

ISL75051SRHEVAL1Z

ISL75051SRH High Performance 3A LDO Evaluation Board

AN1667
Rev.0.00
January 17, 2012

Description

The ISL75051SRH is a high-performance, adjustable, low-voltage, high-current, low-dropout linear regulator specified at 3A rated output current for input voltages from 2.2V to 6V. The LDO outputs can be adjusted from 0.8V to 5V by means of two preset resistors. Salient features of the part include:

- TID, ELDRS and SEE Rated
- Very Fast Load Transient Response
- $\pm 2.0\%$ Guaranteed VOUT Accuracy over Line, Load and Temperature
- Typical Dropout of 287mV at 3A
- EN Feature
- PG Feature
- OCP Feature
- Short-circuit and Over-temperature Protection

The ISL75051SRHEVAL1Z evaluation board provides a simple platform to evaluate performance of the ISL75051SRH. The device output voltage is adjustable, and jumpers are provided to easily set popular output voltages.

What's Inside

The evaluation kit contains the following:

- ISL75051SRHEVAL1Z evaluation board
- ISL75051SRH datasheet
- AN1667 application note

Test Steps

1. Select the desired output voltage by shorting one of the jumpers from J2 through J6. The option of JP7 provides for continuous adjustment of VOUT using potentiometer R13.
2. Set the OCP limit by using jumpers JP8 and JP9. JP9 = 0.8A min, and JP8 = 4A min.
3. Close JP10. Also closing jumper JP1 (2 and 3) selects R2 = 5.49k as pull-up for PGOOD.
4. Ensure that the output capacitor and C_p are set according to recommended values shown in Table 1.
5. Connect the input supply to VIN/GND and the load to VOUT/GND. Select the VIN to VOUT ratio to keep dissipation within the thermal limits of the device.
6. Use JP11 to enable/disable the IC; Open = Enable, and Close = Disable. (Note: For REVB boards, Close = Enable and Open = Disable.)

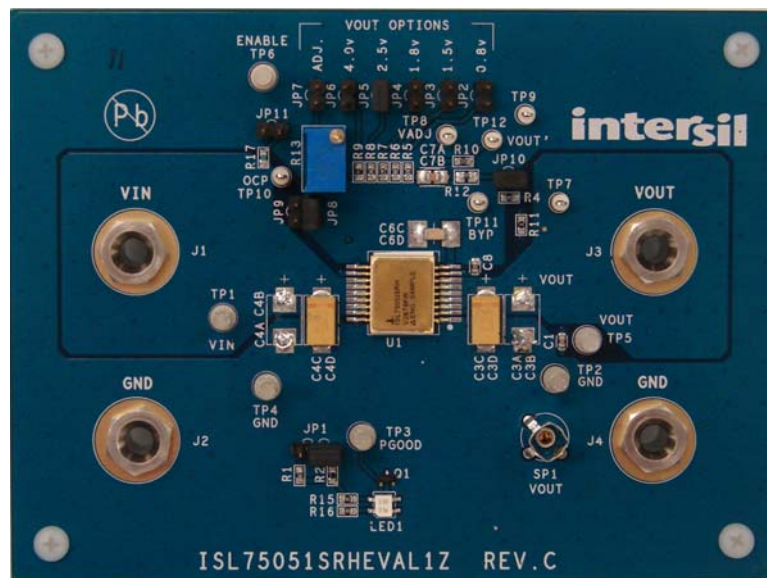

FIGURE 1. ISL75051SRHEVAL1Z EVALUATION BOARD

Optimizing LDO Performance

Performance of the ISL75051SRH can be optimized by following the guidelines provided in this application note.

Input and Output Capacitor Selection

RH operation requires the use of a combination of tantalum and ceramic capacitors to achieve a good volume-to-capacitance ratio. The recommended combination is a 220 μ F, 25m Ω , 10V DSSC 04051-032 rated tantalum capacitor in parallel with a 0.1 μ F MIL-PRF-49470 CDR04 ceramic capacitor. This is to be connected between VIN to GND pins and VOUT to GND pins of the LDO, with PCB traces no longer than 0.5cm. The stability of the device depends on the capacitance and ESR of the output capacitor. The usable ESR range for the device is 6m Ω to 100m Ω . At the lower limit of ESR = 6m Ω , the phase margin is about 51 $^{\circ}$ C. On the high side, an ESR of 100m Ω is found to limit the gain margin at around 10dB. The typical GM/PM seen on the ISL75051SRHEVAL1Z evaluation board for VIN = 3.3V, VOUT = 1.8V, and IOUT = 3A, with a 220 μ F, 10V, 25m Ω capacitor, is GM = 16.3dB and PM = 69.16 $^{\circ}$ C.

Pole Capacitor (C_P)

A small capacitor (C_P) can be placed on the ADJ pin of the ISL75051SRH, as shown in Figure 2, across the bottom resistor in the feedback resistor divider. This is effectively a pole. The value of the capacitor can be calculated using Equation 1:

$$F_P = 1/(2 \cdot \pi \cdot R_{\text{BOTTOM}} \cdot C_P) \quad (\text{EQ. 1})$$

The pole should be set to have the break frequency at 1MHz.

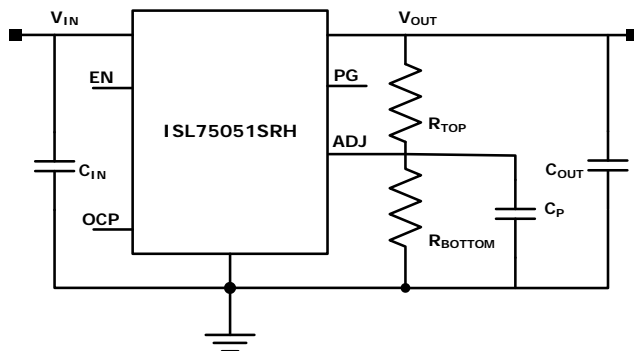

FIGURE 2. ISL75051SRH TYPICAL APPLICATION

Table 1 gives the recommended values for output capacitors (MLCC X5R/X7R) and C_P for different voltage rails. Correct selection of the output capacitor and C_P also helps increase PSRR at high frequencies. The board, however, uses a 100pF capacitor as a typical value most suited for the application range.

TABLE 1. RECOMMENDED OUTPUT CAPACITOR VALUES

V _{OUT} (V)	R _{TOP} (k Ω)	R _{BOTTOM} (Ω)	C _P (pF)	C _{OUT} (μ F)
5.0	4.32	499	120	220
4.0	4.32	634	120	220
2.5	4.32	1.13k	120	220
1.8	4.32	1.74k	100	220
1.5 (Note 1)	4.32	2.26k	100	47
1.5	4.32	2.26k	100	220
0.8	4.32	7.87k	68	220

NOTE:

1. Either option could be used depending on cost/performance requirements.

Layout Guidelines

Good PCB layout is important to achieving expected performance. When placing components and routing traces, minimize ground impedance and keep parasitic inductance low. Give the input and output capacitors a good ground connection, and place them as close to the IC as possible. Route the traces connecting the ADJ pin away from noisy planes and traces, and keep the board capacitance of the ADJ net to GND as low as possible.

Thermal Guidelines

If the die temperature exceeds +175 $^{\circ}$ C typical, then the LDO output shuts down to zero until the die temperature cools to +155 $^{\circ}$ C typical. The level of power combined with the thermal impedance of the package (RTHjc of 4 $^{\circ}$ C/W for the 18 Ld CDFF package) determines whether the junction temperature exceeds the thermal shutdown temperature specified in the "Electrical Specifications" table of the [ISL75051SRH datasheet](#). Mount the device on a high effective thermal conductivity PCB with thermal vias, per JESD51-7 and JESD51-5. Place a silpad between package base and PCB copper plane. Select the VIN and VOUT ratios to ensure that dissipation for the selected VIN range keeps T_J within the recommended operating level of 150 $^{\circ}$ C for normal operation.

Typical Performance Curves Unless otherwise specified, $V_{IN} = V_{OUT} + 0.4V$, $V_{OUT} = 1.8V$, $C_{IN} = C_{OUT} = 10\mu F$, $T_J = +25^\circ C$, $I_{LOAD} = 0A$.



FIGURE 3. START-UP WAVEFORMS: $V_{IN} = 6.0V$, $V_{OUT} = 0.8V$, EN LOW TO HIGH



FIGURE 4. START-UP WAVEFORMS: $V_{IN} = 2.2V$, $V_{OUT} = 0.8V$, EN LOW TO HIGH



FIGURE 5. SHUTDOWN WAVEFORM: $V_{IN} = 6.0V$, $V_{OUT} = 0.8V$, EN HIGH TO LOW



FIGURE 6. SHUTDOWN WAVEFORM: $V_{IN} = 2.2V$, $V_{OUT} = 0.8V$, EN HIGH TO LOW

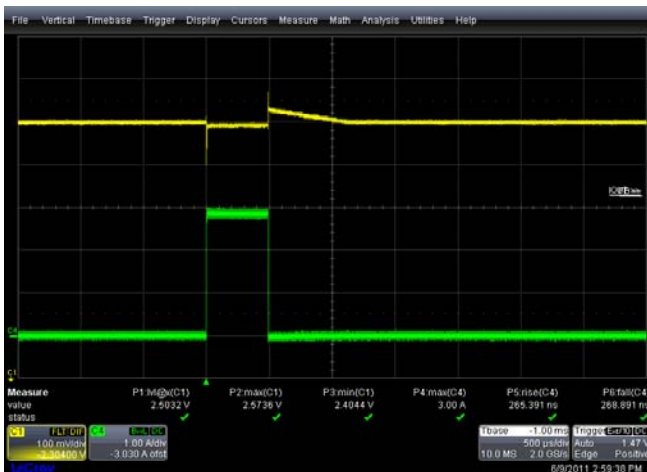

FIGURE 7. LOAD TRANSIENT, $V_{IN} = 3.3V$, $V_{OUT} = 2.5V$, $C_{OUT} = 47\mu F$ 35mΩ



FIGURE 8. LOAD TRANSIENT, $V_{IN} = 3.3V$, $V_{OUT} = 2.5V$, $C_{OUT} = 220\mu F$ 25mΩ

Typical Performance Curves Unless otherwise specified, $V_{IN} = V_{OUT} + 0.4V$, $V_{OUT} = 1.8V$, $C_{IN} = C_{OUT} = 10\mu F$, $T_J = +25^\circ C$, $I_{LOAD} = 0A$. (Continued)

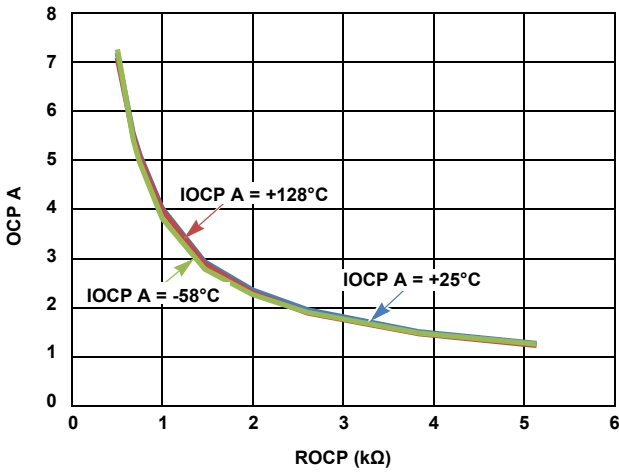

FIGURE 9. ROCP (kΩ) vs OCP A OVER TEMP

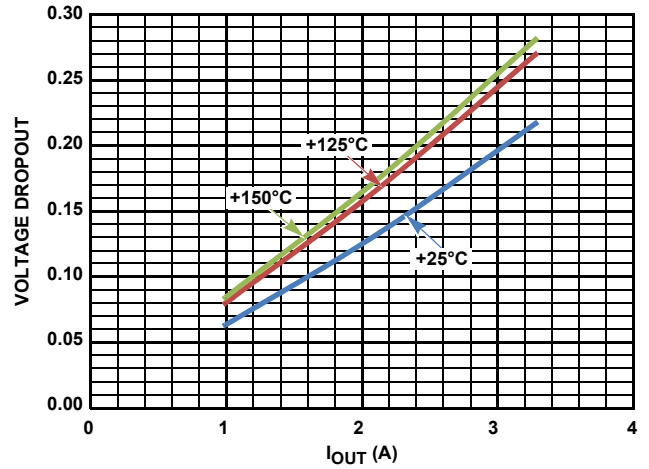

FIGURE 10. DROPOUT vs I_{OUT}

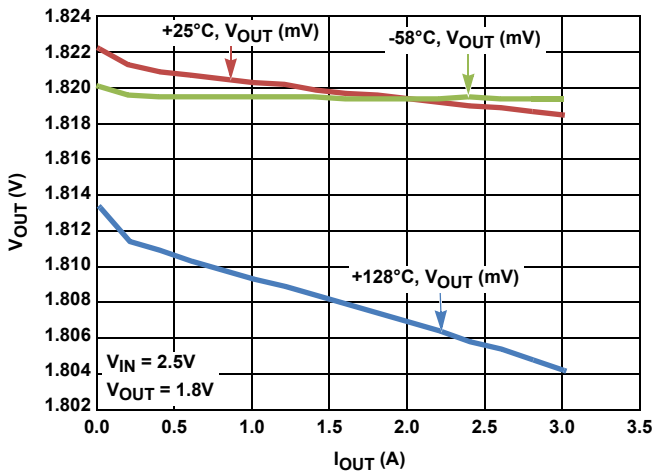

FIGURE 11. LOAD REGULATION V_{OUT} vs I_{OUT}

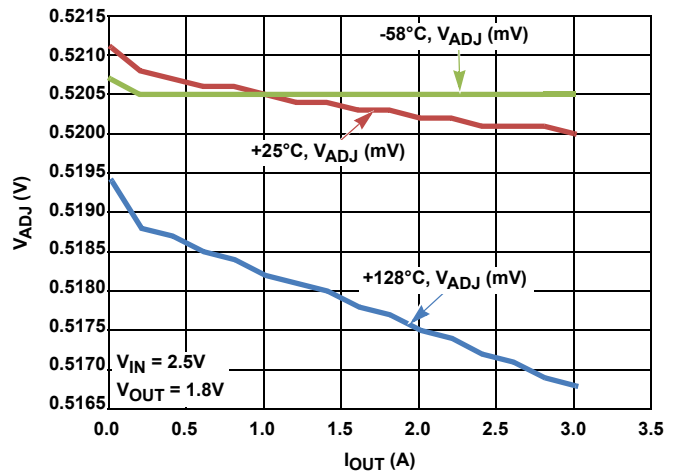

FIGURE 12. LOAD REGULATION V_{ADJ} vs I_{OUT}

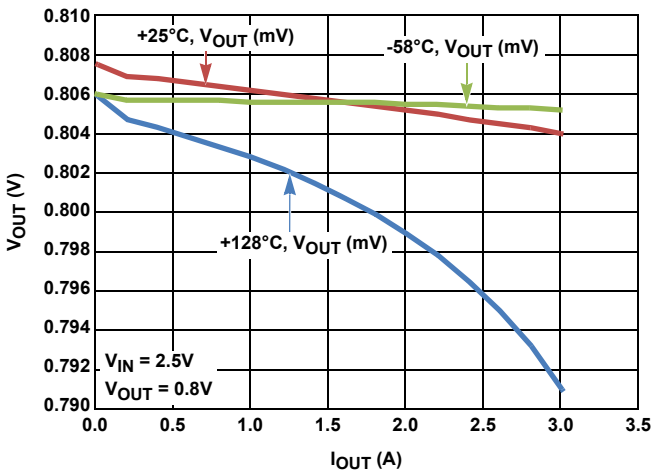

FIGURE 13. LOAD REGULATION V_{OUT} vs I_{OUT}

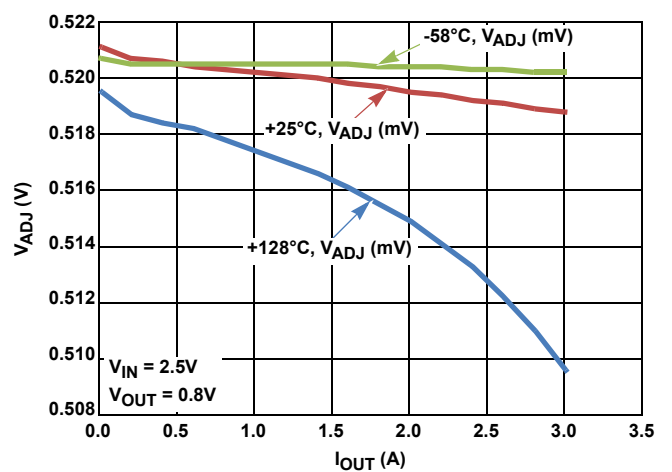

FIGURE 14. LOAD REGULATION V_{ADJ} vs I_{OUT}

Typical Performance Curves Unless otherwise specified, $V_{IN} = V_{OUT} + 0.4V$, $V_{OUT} = 1.8V$, $C_{IN} = C_{OUT} = 10\mu F$, $T_J = +25^\circ C$, $I_{LOAD} = 0A$. (Continued)

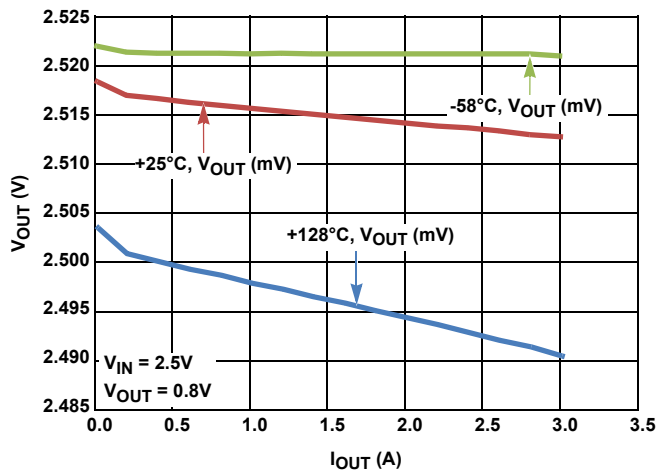

FIGURE 15. LOAD REGULATION V_{OUT} vs I_{OUT}

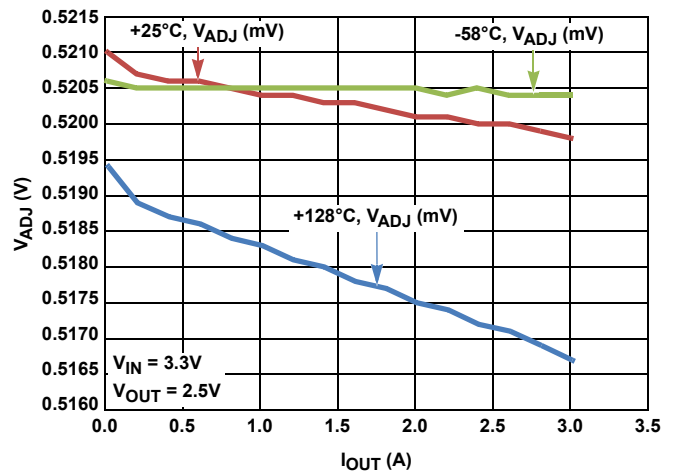
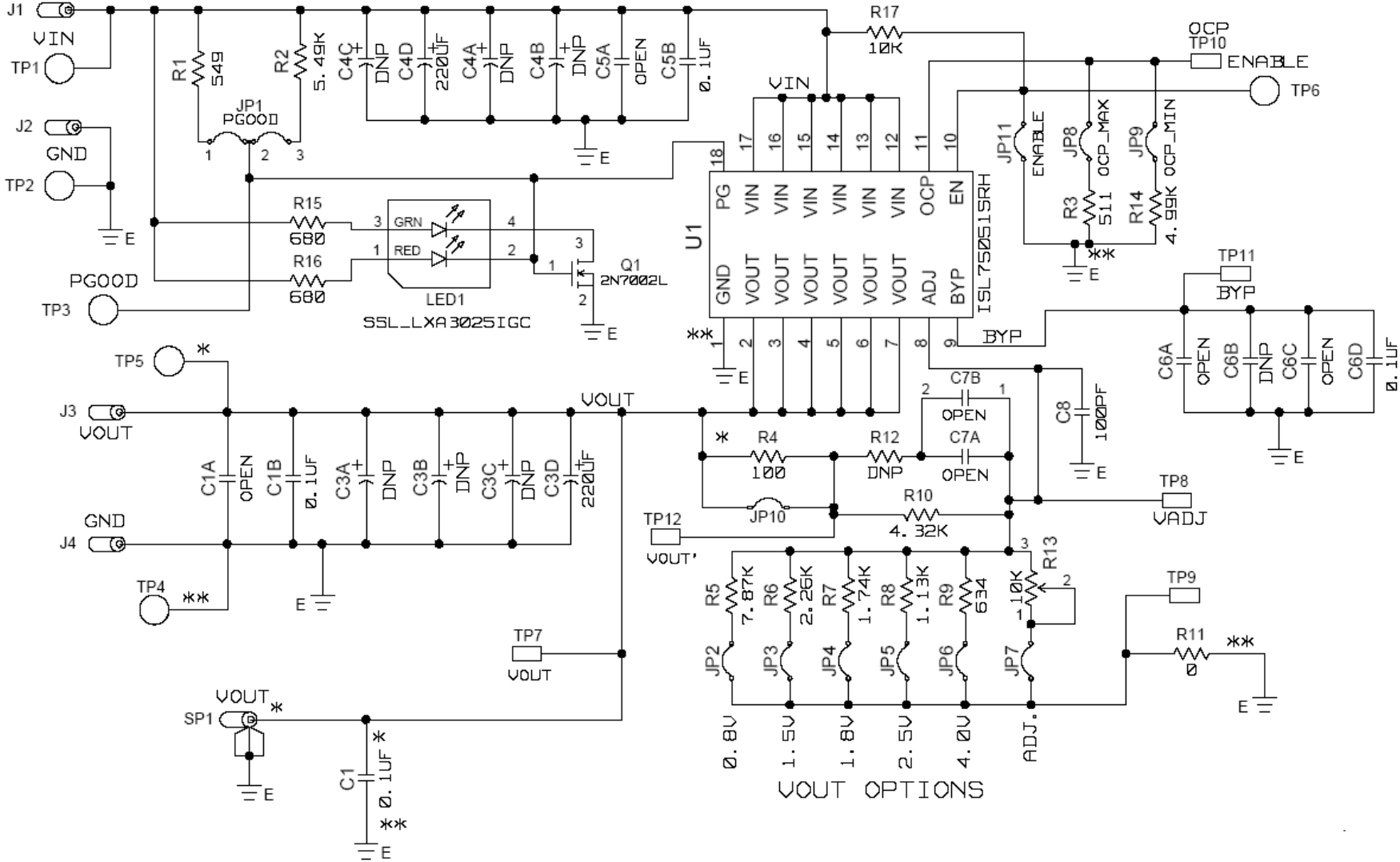

FIGURE 16. LOAD REGULATION V_{ADJ} vs I_{OUT}

Schematic



ISL75051SRHEVAL1Z Bill of Materials

PART NUMBER	QTY	UNITS	REFERENCE DESIGNATOR	DESCRIPTION	MANUFACTURER	MANUFACTURER PART
ISL75051SRHEVAL1ZREVCPCB	1	ea		PWB-PCB, ISL75051SRHEVAL1Z, REVC, ROHS	IMAGINEERING INC	ISL75051SRHEVAL1ZREV CPCB
C0805X472K5RACTU-T	1	ea	C7B	CAP, SMD, 0805, 4700pF, 50V, 10%, X7R, AEC-Q200, ROHS	KEMET	C0805X472K5RACTU
CDR04BX104AKWS	4	ea	C1B, C5B, C6B, C6D	CAP-MILQUAL, SMD, 1812, 0.1µF, 50V, 10%, X7R, ROHS	AVX	CDR04BX104AKWS
H1045-00101-50V5-T	1	ea	C8	CAP, SMD, 0603, 100pF, 50V, 5%, COG, ROHS	PANASONIC	ECJ-1VC1H101J
H1045-00104-16V10-T	1	ea	C1	CAP, SMD, 0603, 0.1µF, 16V, 10%, X7R, ROHS	MURATA	GRM39X7R104K016AD
H1045-DNP	0	ea	C1A, C5A, C6A, C6C	CAP, SMD, 0603, DNP- PLACE HOLDER, ROHS		
H1046-DNP	0	ea	C7A	CAP, SMD, 0805, DNP- PLACE HOLDER, ROHS		
T525D227M010ATE025	2	ea	C3D, C4D	CAP-TANT, SMD, 7.3x4.3, 220µF, 10V, 20%, 25mΩ, DF:10, ROHS	KEMET	T525D227M010ATE025
108-0740-001	4	ea	J1-J4	CONN-JACK, BANANA- SS-SDRLESS, VERTICAL, ROHS	JOHNSON COMPONENTS	108-0740-001
131-4353-00	1	ea	SP1	CONN-SCOPE PROBE TEST PT, COMPACT, PCB MNT, ROHS	TEKTRONIX	131-4353-00
1514-2	6	ea	TP1-TP6	CONN-TURRET, TERMINAL POST, TH, ROHS	KEYSTONE	1514-2
5002	6	ea	TP7-TP12	CONN-MINI TEST POINT, VERTICAL, WHITE, ROHS	KEYSTONE	5002
68000-236HLF-1X3	1	ea	JP1	CONN-HEADER, 1x3, BREAKAWY 1x36, 2.54mm, ROHS	BERG/FCI	68000-236HLF
69190-202HLF	10	ea	JP2-JP11	CONN-HEADER, 1x2, RETENTIVE, 2.54mm, 0.230 x 0.120, ROHS	BERG/FCI	69190-202HLF
SSL-LXA3025IGC-TR	1	ea	LED1	LED, SMD, 3x2.5mm, 4P, RED/GREEN, 12/20MCD, 2V	LUMEX	SSL-LXA3025IGC-TR
ISL75051SRH	1	ea	U1 (SEE ASSEMBLY INSTRUCTIONS)	IC-3A RAD HARD LDO REGULATOR, 18P, CDFF, ROHS	INTERSIL	ISL75051SRH
2N7002LT1G-T	1	ea	Q1	TRANSISTOR-MOS, N-CHANNEL, SMD, SOT23, 60V, 115mA, ROHS	ON SEMICONDUCTOR	2N7002LT1G

ISL75051SRHEVAL1Z Bill of Materials (Continued)

PART NUMBER	QTY	UNITS	REFERENCE DESIGNATOR	DESCRIPTION	MANUFACTURER	MANUFACTURER PART
3299W-1-103LF	1	ea	R13	POT-TRIM, TH, 3P, 10k, 1/2W, 10%, 3/8SQ, 25TURN, TOPADJ, ROHS	BOURNS	3299W-1-103LF
H2511-00R00-1/10W-T	1	ea	R11	RES, SMD, 0603, 0Ω, 1/10W, TF, ROHS	VENKEL	CR0603-10W-000T
H2511-01000-1/10W1-T	1	ea	R4	RES, SMD, 0603, 100Ω, 1/10W, 1%, TF, ROHS	VENKEL	CR0603-10W-1000FT
H2511-01002-1/10W1-T	1	ea	R17	RES, SMD, 0603, 10k, 1/10W, 1%, TF, ROHS	KOA	RK73H1JT1002F
H2511-01131-1/10W1-T	1	ea	R8	RES, SMD, 0603, 1.13k, 1/10W, 1%, TF, ROHS	YAGEO	RC0603FR-071K13L
H2511-01741-1/10W1-T	1	ea	R7	RES, SMD, 0603, 1.74k, 1/10W, 1%, TF, ROHS	PANASONIC	ERJ-3EKF1741V
H2511-02261-1/10W1-T	1	ea	R6	RES, SMD, 0603, 2.26k, 1/10W, 1%, TF, ROHS	YAGEO	RC0603FR-072K26L
H2511-02671-1/10W1-T	0	ea	R12	RES, SMD, 0603, 2.67k, 1/10W, 1%, TF, ROHS	YAGEO	RC0603FR-072K67L
H2511-04321-1/10W1-T	1	ea	R10	RES, SMD, 0603, 4.32k, 1/10W, 1%, TF, ROHS		
H2511-04991-1/10W1-T	1	ea	R14	RES, SMD, 0603, 4.99k, 1/10W, 1%, TF, ROHS	PANASONIC	ERJ-3EKF4991V
H2511-05110-1/10W1-T	1	ea	R3	RES, SMD, 0603, 511Ω, 1/10W, 1%, TF, ROHS	VENKEL	CR0603-10W-5110FT
H2511-05490-1/10W1-T	1	ea	R1	RES, SMD, 0603, 549Ω, 1/10W, 1%, TF, ROHS	VENKEL	CR0603-10W-5490FT
H2511-05491-1/10W1-T	1	ea	R2	RES, SMD, 0603, 5.49k, 1/10W, 1%, TF, ROHS	VENKEL	CR0603-10W-5491FT
H2511-06340-1/10W1-T	1	ea	R9	RES, SMD, 0603, 634Ω, 1/10W, 1%, TF, ROHS	YAGEO	RC0603FR-07634RL
H2511-06800-1/10W1-T	2	ea	R15, R16	RES, SMD, 0603, 680Ω, 1/10W, 1%, TF, ROHS	ROHM	MCR03EZPF6800
H2511-07871-1/10W1-T	1	ea	R5	RES, SMD, 0603, 7.87k, 1/10W, 1%, TF, ROHS	YAGEO	RC0603FR-077K87L
4-40X1/2-SCREW	4	ea	Four corners	SCREW, 4-40x1/2in, PAN, NYLON, PHILLIPS, ROHS		
4-40X3/4-STANDOFF	4	ea	Four corners	STANDOFF, 4-40x3/4in, F/F, HEX, NYLON, ROHS	KEYSTONE	1902D
5X8-STATIC-BAG	1	ea	Place assy in bag.	BAG, STATIC, 5x8, ZIPLOC, ROHS	INTERSIL	212403-013
ASSEMBLY INSTRUCTIONS	1	ea	a) U1 - Cut a 0.4 inch square of part # SP2000-0.020-AC-1212-NA	Instructions for assembly.	INTERSIL	ASSEMBLY INSTRUCTIONS
ASSEMBLY INSTRUCTIONS	1	ea	b) Affix to PCB where U1 will be installed.	Instructions for assembly.	INTERSIL	ASSEMBLY INSTRUCTIONS

ISL75051SRHEVAL1Z Bill of Materials (Continued)

PART NUMBER	QTY	UNITS	REFERENCE DESIGNATOR	DESCRIPTION	MANUFACTURER	MANUFACTURER PART
ASSEMBLY INSTRUCTIONS	1	ea	c) HAND SOLDER U1 on top of insulation	Instructions for assembly.	INTERSIL	ASSEMBLY INSTRUCTIONS
ASSEMBLY INSTRUCTIONS	1	ea	d) Wash after soldering	Instructions for assembly.	INTERSIL	ASSEMBLY INSTRUCTIONS
DNP	0	ea	C3A, C3C, C4A, C4C (6TPF220ML)	DO NOT POPULATE OR PURCHASE		
LABEL-DATE CODE	1	ea		LABEL-FOR DATE CODE AND BOM REV #	INTERSIL	LABEL-DATE CODE
SP2000-0.020-AC-1212-NA	0.3	ea	U1 (SEE ASSEMBLY INSTRUCTIONS)	INSULATION-SILICONE ELASTOMER, 12x12, 0.020in, W/ADHESIVE, ROHS	BERGQUIST	SP2000-0.020-AC-1212-NA

Layout

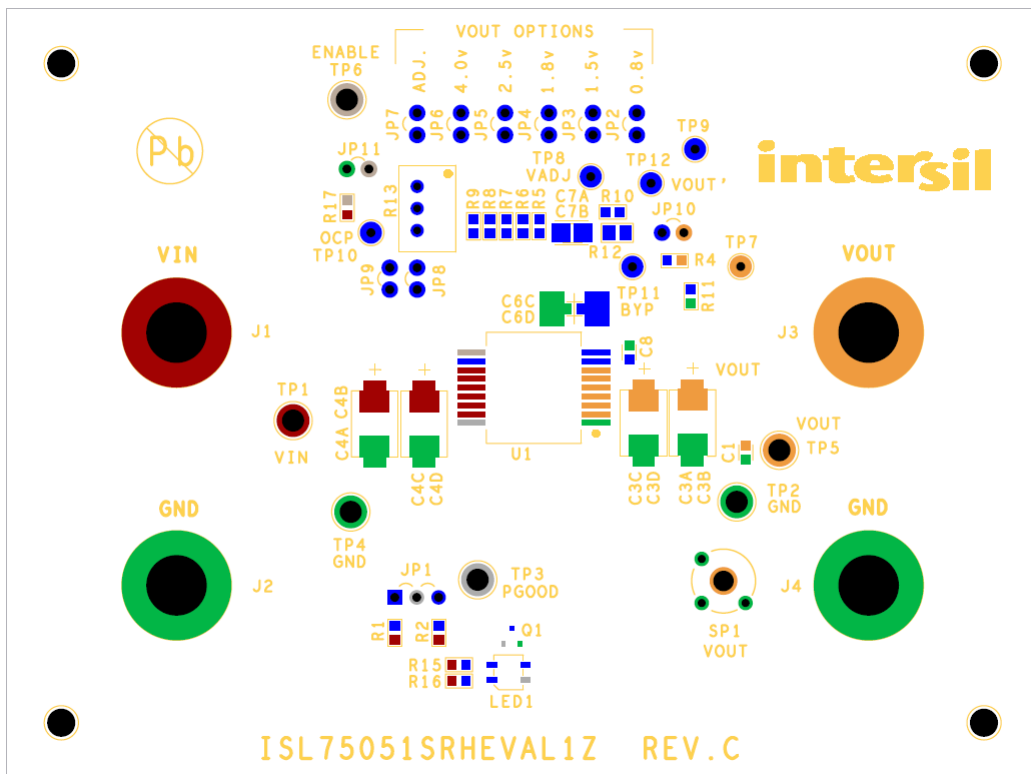

FIGURE 17. SILK SCREEN TOP

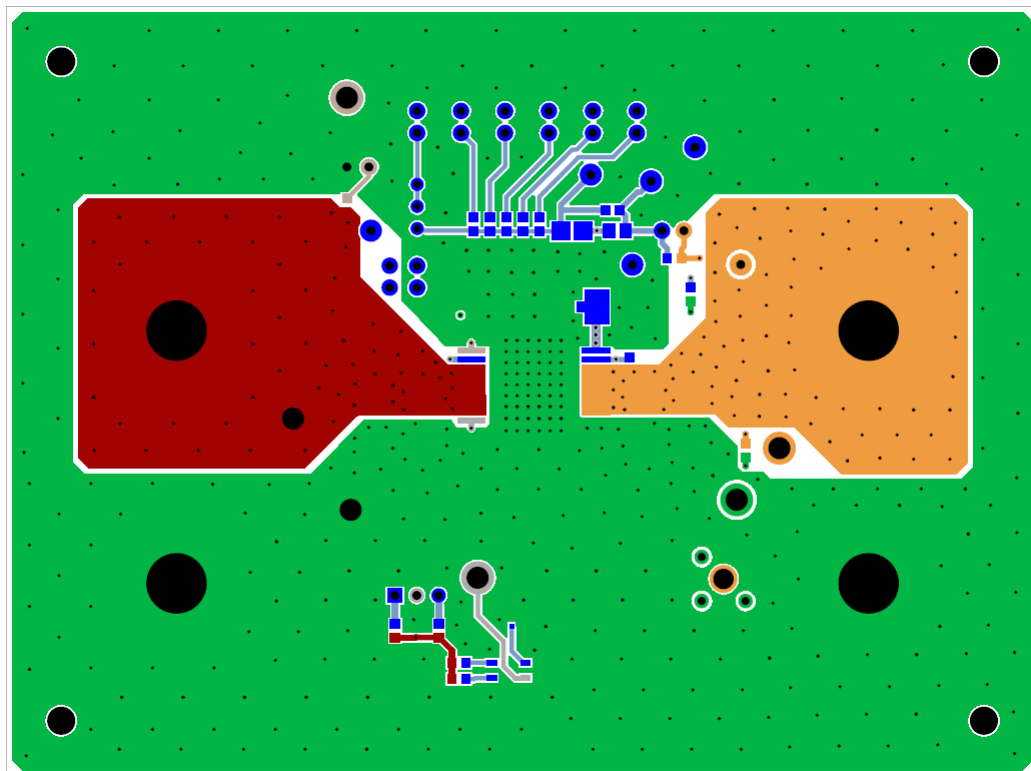

FIGURE 18. TOP LAYER COMPONENT SIDE

Layout (Continued)

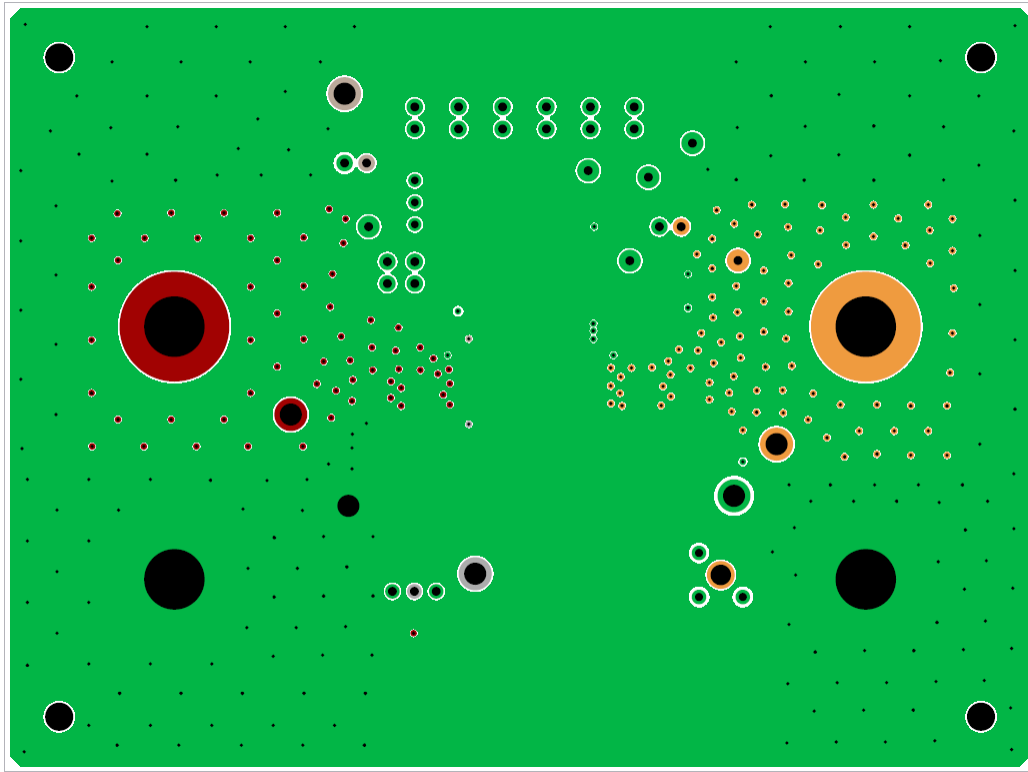

FIGURE 19. LAYER 2

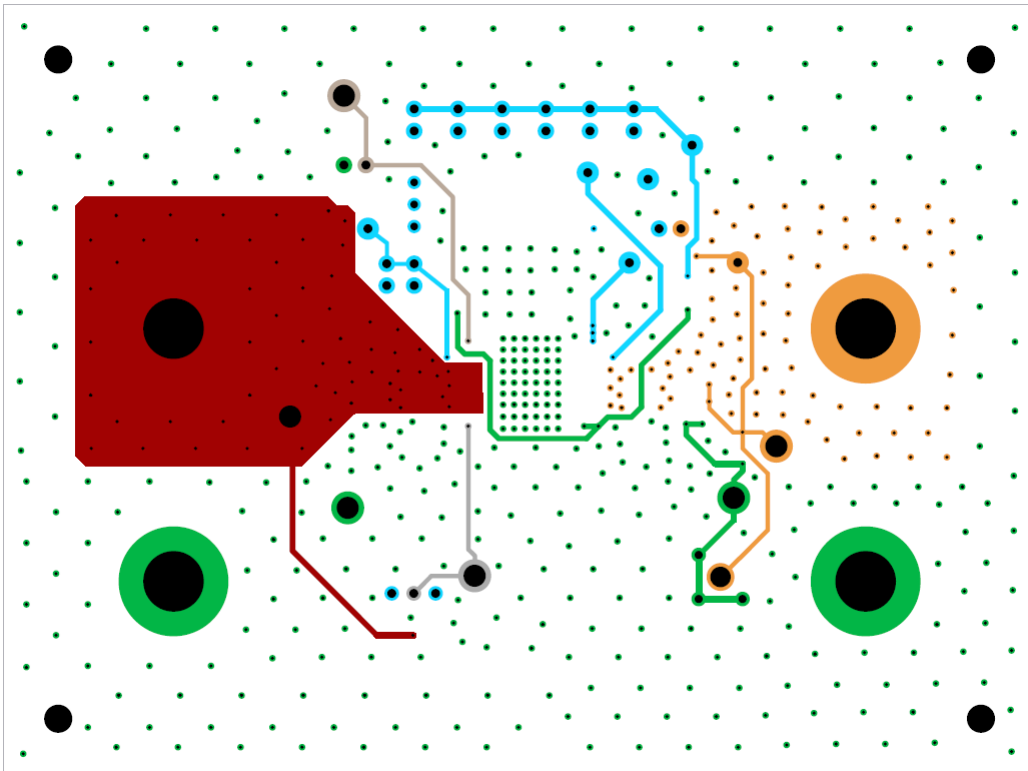

FIGURE 20. LAYER 3

Layout (Continued)

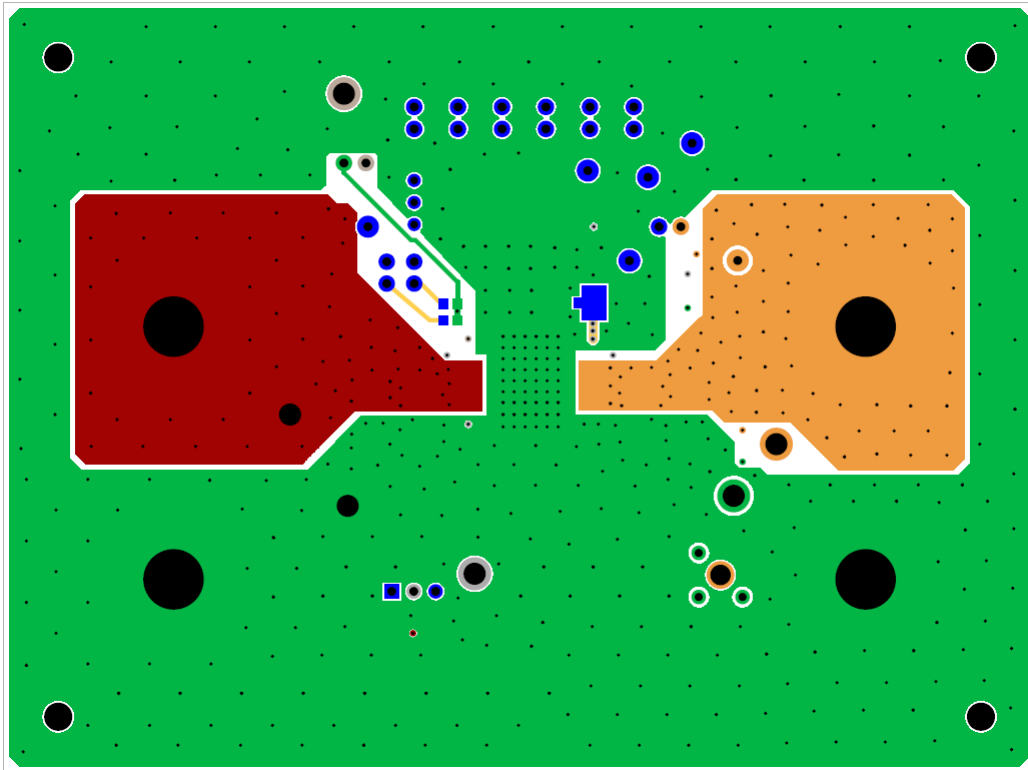

FIGURE 21. BOTTOM LAYER SOLDER SIDE

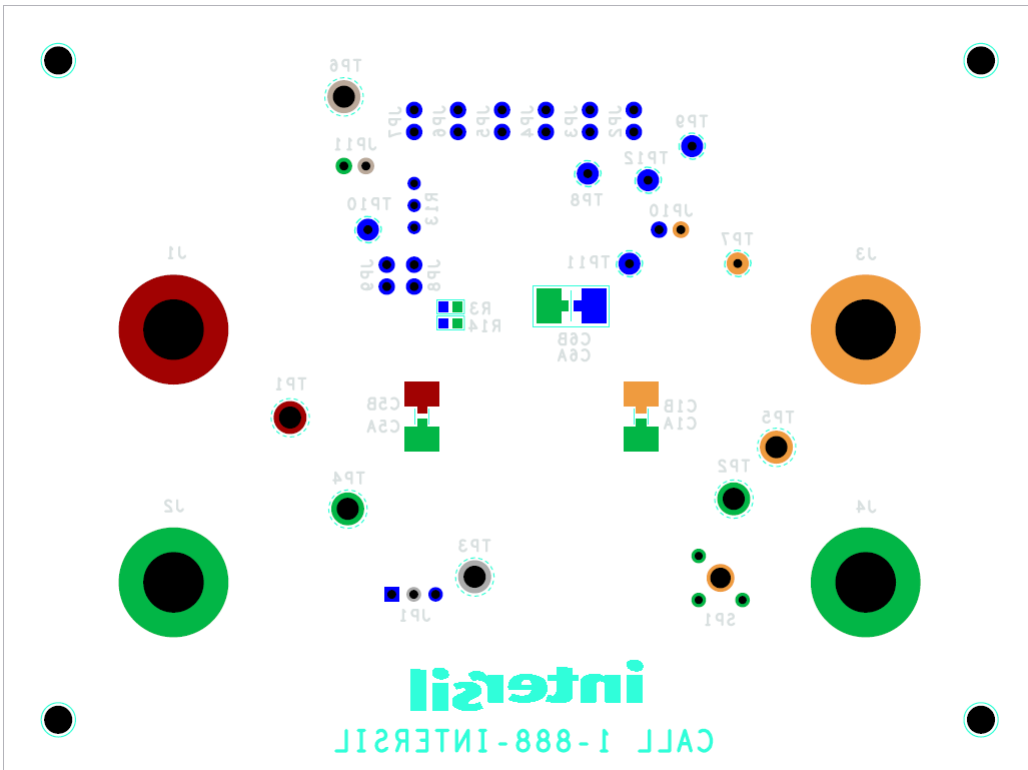

FIGURE 22. SILK SCREEN BOTTOM

Layout (Continued)

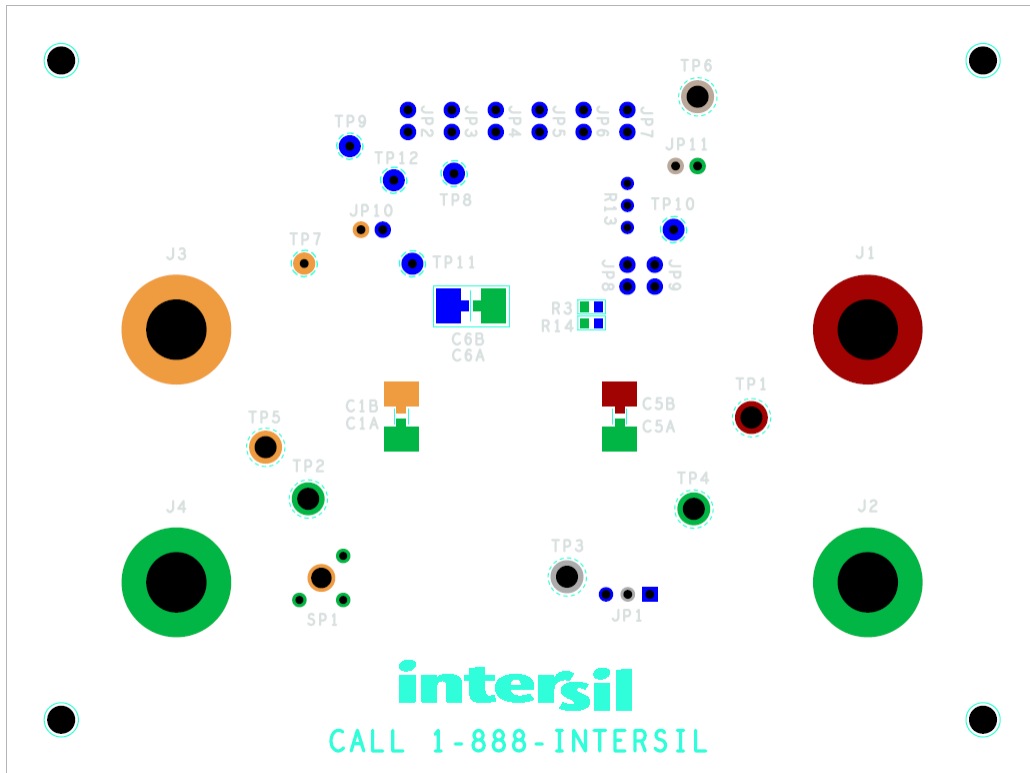
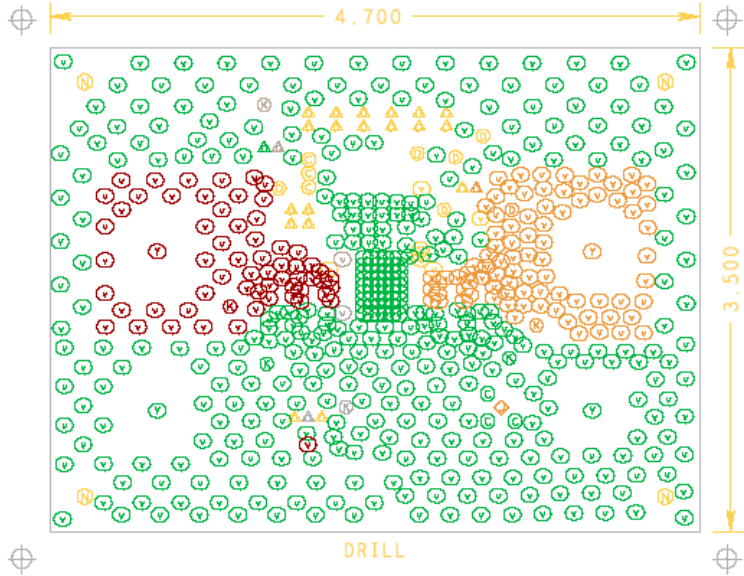
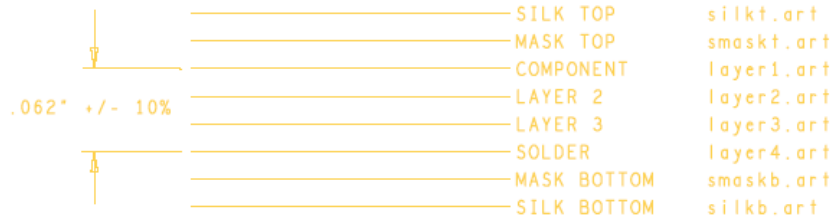

FIGURE 23. SILK SCREEN BOTTOM MIRROR

Drill Drawings



PHYSICAL BOARD DIMENSIONS & LAYER STRUCTURE



DRILL CHART: TOP to BOTTOM			
ALL UNITS ARE IN MILS			
FIGURE	SIZE	PLATED	QTY
⊙	16.0	PLATED	547
⊙	35.0	PLATED	3
⊙	37.0	PLATED	3
⊙	40.0	PLATED	6
△	41.0	PLATED	23
◇	93.0	PLATED	1
⊗	100.0	PLATED	6
⊙	275.0	PLATED	4
⊗	128.0	NON-PLATED	4

NOTES:

1. THIS BOARD IS RoHS COMPLIANT.
2. PRINTED WIRING BOARD DESIGN AND ACCEPTANCE CRITERIA SHALL BE IAW WITH THE REQUIREMENTS OF IPC-D-275 AND IPC-A-600.
3. MATERIAL: FR4 (RoHS COMPLIANT), 1 OZ COPPER.
4. APPLY SOLDER MASK, BOTH SIDES OVER BARE COPPER IAW IPC-SM-840. CLASS 2 (LPI) (BLUE MASK).
5. ALL PATTERNS ARE VIEWED FROM THE PRIMARY SIDE LOOKING THROUGH THE BOARD.
6. UNLESS OTHERWISE SPECIFIED ALL HOLE DIAMETERS ARE AFTER PLATING.
7. APPLY SILKSCREEN USING WHITE NON-CONDUCTIVE EPOXY BASED INK.
8. PWB MUST BE 100% ELECTRICALLY TESTED FOR SHORTS AND CONTINUITY. USE NETLIST PROVIDED ISL75051SRHEVAL12C_IPC356.IPC IAW IPC-D-356.
9. MARK DATE CODE AND MANUFACTURES IDENIFICATION ON SOLDER SIDE PER IPC-6011 AND IPC-6012.
- 10 TOLERANCE ON ALL DRILL HOLES SHALL BE IAW IPC-D-2221 & 2222 UNLESS OTHERWISE SPECIFIED.

Notice

1. Descriptions of circuits, software and other related information in this document are provided only to illustrate the operation of semiconductor products and application examples. You are fully responsible for the incorporation or any other use of the circuits, software, and information in the design of your product or system. Renesas Electronics disclaims any and all liability for any losses and damages incurred by you or third parties arising from the use of these circuits, software, or information.
2. Renesas Electronics hereby expressly disclaims any warranties against and liability for infringement or any other claims involving patents, copyrights, or other intellectual property rights of third parties, by or arising from the use of Renesas Electronics products or technical information described in this document, including but not limited to, the product data, drawings, charts, programs, algorithms, and application examples.
3. No license, express, implied or otherwise, is granted hereby under any patents, copyrights or other intellectual property rights of Renesas Electronics or others.
4. You shall not alter, modify, copy, or reverse engineer any Renesas Electronics product, whether in whole or in part. Renesas Electronics disclaims any and all liability for any losses or damages incurred by you or third parties arising from such alteration, modification, copying or reverse engineering.
5. Renesas Electronics products are classified according to the following two quality grades: "Standard" and "High Quality". The intended applications for each Renesas Electronics product depends on the product's quality grade, as indicated below.
"Standard": Computers; office equipment; communications equipment; test and measurement equipment; audio and visual equipment; home electronic appliances; machine tools; personal electronic equipment; industrial robots; etc.
"High Quality": Transportation equipment (automobiles, trains, ships, etc.); traffic control (traffic lights); large-scale communication equipment; key financial terminal systems; safety control equipment; etc.
Unless expressly designated as a high reliability product or a product for harsh environments in a Renesas Electronics data sheet or other Renesas Electronics document, Renesas Electronics products are not intended or authorized for use in products or systems that may pose a direct threat to human life or bodily injury (artificial life support devices or systems; surgical implantations; etc.), or may cause serious property damage (space system; undersea repeaters; nuclear power control systems; aircraft control systems; key plant systems; military equipment; etc.). Renesas Electronics disclaims any and all liability for any damages or losses incurred by you or any third parties arising from the use of any Renesas Electronics product that is inconsistent with any Renesas Electronics data sheet, user's manual or other Renesas Electronics document.
6. When using Renesas Electronics products, refer to the latest product information (data sheets, user's manuals, application notes, "General Notes for Handling and Using Semiconductor Devices" in the reliability handbook, etc.), and ensure that usage conditions are within the ranges specified by Renesas Electronics with respect to maximum ratings, operating power supply voltage range, heat dissipation characteristics, installation, etc. Renesas Electronics disclaims any and all liability for any malfunctions, failure or accident arising out of the use of Renesas Electronics products outside of such specified ranges.
7. Although Renesas Electronics endeavors to improve the quality and reliability of Renesas Electronics products, semiconductor products have specific characteristics, such as the occurrence of failure at a certain rate and malfunctions under certain use conditions. Unless designated as a high reliability product or a product for harsh environments in a Renesas Electronics data sheet or other Renesas Electronics document, Renesas Electronics products are not subject to radiation resistance design. You are responsible for implementing safety measures to guard against the possibility of bodily injury, injury or damage caused by fire, and/or danger to the public in the event of a failure or malfunction of Renesas Electronics products, such as safety design for hardware and software, including but not limited to redundancy, fire control and malfunction prevention, appropriate treatment for aging degradation or any other appropriate measures. Because the evaluation of microcomputer software alone is very difficult and impractical, you are responsible for evaluating the safety of the final products or systems manufactured by you.
8. Please contact a Renesas Electronics sales office for details as to environmental matters such as the environmental compatibility of each Renesas Electronics product. You are responsible for carefully and sufficiently investigating applicable laws and regulations that regulate the inclusion or use of controlled substances, including without limitation, the EU RoHS Directive, and using Renesas Electronics products in compliance with all these applicable laws and regulations. Renesas Electronics disclaims any and all liability for damages or losses occurring as a result of your noncompliance with applicable laws and regulations.
9. Renesas Electronics products and technologies shall not be used for or incorporated into any products or systems whose manufacture, use, or sale is prohibited under any applicable domestic or foreign laws or regulations. You shall comply with any applicable export control laws and regulations promulgated and administered by the governments of any countries asserting jurisdiction over the parties or transactions.
10. It is the responsibility of the buyer or distributor of Renesas Electronics products, or any other party who distributes, disposes of, or otherwise sells or transfers the product to a third party, to notify such third party in advance of the contents and conditions set forth in this document.
11. This document shall not be reprinted, reproduced or duplicated in any form, in whole or in part, without prior written consent of Renesas Electronics.
12. Please contact a Renesas Electronics sales office if you have any questions regarding the information contained in this document or Renesas Electronics products.
(Note 1) "Renesas Electronics" as used in this document means Renesas Electronics Corporation and also includes its directly or indirectly controlled subsidiaries.
(Note 2) "Renesas Electronics product(s)" means any product developed or manufactured by or for Renesas Electronics.

(Rev.4.0-1 November 2017)



SALES OFFICES

Renesas Electronics Corporation

<http://www.renesas.com>

Refer to "<http://www.renesas.com/>" for the latest and detailed information.

Renesas Electronics America Inc.
1001 Murphy Ranch Road, Milpitas, CA 95035, U.S.A.
Tel: +1-408-432-8888, Fax: +1-408-434-5351

Renesas Electronics Canada Limited
9251 Yonge Street, Suite 8309 Richmond Hill, Ontario Canada L4C 9T3
Tel: +1-905-237-2004

Renesas Electronics Europe Limited
Dukes Meadow, Millboard Road, Bourne End, Buckinghamshire, SL8 5FH, U.K.
Tel: +44-1628-651-700, Fax: +44-1628-651-804

Renesas Electronics Europe GmbH
Arcadiastrasse 10, 40472 Düsseldorf, Germany
Tel: +49-211-6503-0, Fax: +49-211-6503-1327

Renesas Electronics (China) Co., Ltd.
Room 1709 Quantum Plaza, No.27 ZhichunLu, Haidian District, Beijing, 100191 P. R. China
Tel: +86-10-8235-1155, Fax: +86-10-8235-7679

Renesas Electronics (Shanghai) Co., Ltd.
Unit 301, Tower A, Central Towers, 555 Langao Road, Putuo District, Shanghai, 200333 P. R. China
Tel: +86-21-2226-0888, Fax: +86-21-2226-0999

Renesas Electronics Hong Kong Limited
Unit 1601-1611, 16/F., Tower 2, Grand Century Place, 193 Prince Edward Road West, Mongkok, Kowloon, Hong Kong
Tel: +852-2265-6688, Fax: +852-2886-9022

Renesas Electronics Taiwan Co., Ltd.
13F, No. 363, Fu Shing North Road, Taipei 10543, Taiwan
Tel: +886-2-8175-9600, Fax: +886-2-8175-9670

Renesas Electronics Singapore Pte. Ltd.
80 Bendemeer Road, Unit #06-02 Hyflux Innovation Centre, Singapore 339949
Tel: +65-6213-0200, Fax: +65-6213-0300

Renesas Electronics Malaysia Sdn.Bhd.
Unit 1207, Block B, Menara Amcorp, Amcorp Trade Centre, No. 18, Jln Persiaran Barat, 46050 Petaling Jaya, Selangor Darul Ehsan, Malaysia
Tel: +60-3-7955-9390, Fax: +60-3-7955-9510

Renesas Electronics India Pvt. Ltd.
No.777C, 100 Feet Road, HAL 2nd Stage, Indiranagar, Bangalore 560 038, India
Tel: +91-80-67208700, Fax: +91-80-67208777

Renesas Electronics Korea Co., Ltd.
17F, KAMCO Yangjae Tower, 262, Gangnam-daero, Gangnam-gu, Seoul, 06265 Korea
Tel: +82-2-558-3737, Fax: +82-2-558-5338