

ISL6255EVAL2Z

Evaluation Board

AN1297
Rev 0.00
April 10, 2007

General Description

The ISL6255EVAL2Z REV B EV kit includes all the circuitry needed to demonstrate the capabilities of the ISL6255 Lithium-Ion battery-charger with integrated AC adapter current limit. The user can experiment with an extensive matrix of battery charge parameters, AC adapter current limit, monitor functions, and load switching.

The ISL6255, ISL6255A is a highly integrated battery charger controller for Li-Ion/Li-Ion polymer batteries. High Efficiency is achieved by a synchronous buck topology and the use of a MOSFET, instead of a diode, for selecting power from the adapter or battery. The low side MOSFET emulates a diode at light loads to improve the light load efficiency and prevent system bus boosting.

The constant output voltage can be selected for 2, 3 and 4 series Li-Ion cells with 0.5% accuracy over-temperature. It can also be programmed between 4.2V + 5%/cell and 4.2V - 5%/cell to optimize battery capacity. When supplying the load and battery charger simultaneously, the input current limit for the AC adapter is programmable to within 3% accuracy to avoid overloading the AC adapter and to allow the system to make efficient use of available adapter power for charging. It also has a wide range of programmable charging current. The ISL6255, ISL6255A provides outputs that are used to monitor the current drawn from the AC adapter, and monitor for the presence of an AC adapter. The ISL6255, ISL6255A automatically transitions from regulating current mode to regulating voltage mode.

ISL6255, ISL6255A has a feature for automatic power source selection by switching to the battery when the AC adapter is removed or switching to the AC adapter when the AC adapter is available. It also provides a DC adapter monitor to support aircraft power applications with the option of no battery charging.

Features

- ±0.5% Charge Voltage Accuracy (-10°C to +100°C)
- ±3% Accurate Input Current Limit
- ±3% Accurate Battery Charge Current Limit
- ±25% Accurate Battery Trickle Charge Current Limit (ISL6255A)
- Programmable Charge Current Limit, Adapter Current Limit and Charge Voltage
- Fixed 300kHz PWM Synchronous Buck Controller with Diode Emulation at Light Load
- Output for Current Drawn from AC Adapter
- AC Adapter Present Indicator
- Fast Input Current Limit Response
- Input Voltage Range 7V to 25V
- Support 2, 3 and 4 Cells Battery Pack
- Up to 17.64V Battery-Voltage Set Point
- Control Adapter Power Source Select MOSFET
- Thermal Shutdown
- Aircraft Power Capable
- DC Adapter Present Indicator
- Battery Discharge MOSFET Control
- Less than 10µA Battery Leakage Current
- Support Pulse Charging
- Charge Any Battery Chemistry: Li-Ion, NiCd, NiMH, etc.
- Pb-Free Plus Anneal Available (RoHS Compliant)

Applications

- Notebook, Desknote and Sub-notebook Computers
- Personal Digital Assistant

Ordering Information

PART NUMBER (Notes 1, 2)	PART MARKING	TEMP RANGE (°C)	PACKAGE (Pb-free)	PKG. DWG. #
ISL6255HRZ	ISL 6255HRZ	-10 to +100	28 Ld 5x5 QFN	L28.5x5
ISL6255HAZ	ISL 6255HAZ	-10 to +100	28 Ld QSOP	M28.15
ISL6255AHRZ	ISL6255 AHRZ	-10 to +100	28 Ld 5x5 QFN	L28.5x5
ISL6255AHAZ	ISL6255 AHAZ	-10 to +100	28 Ld QSOP	M28.15

NOTES:

1. Intersil Pb-free plus anneal products employ special Pb-free material sets; molding compounds/die attach materials and 100% matte tin plate termination finish, which are RoHS compliant and compatible with both SnPb and Pb-free soldering operations. Intersil Pb-free products are MSL classified at Pb-free peak reflow temperatures that meet or exceed the Pb-free requirements of IPC/JEDEC J STD-020.
2. Add "-T" for Tape and Reel.

Pinouts

ISL6255, ISL6255A
(28 LD QSOP)
 TOP VIEW

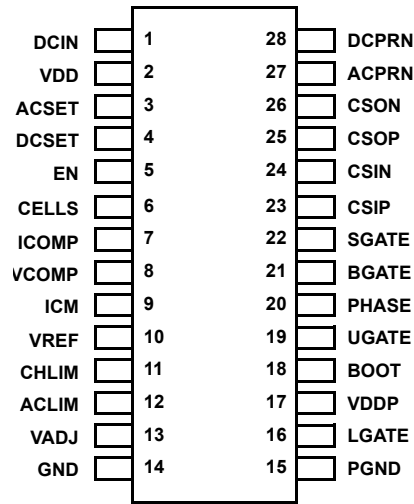

ISL6255, ISL6255A
(28 LD QFN)
 TOP VIEW

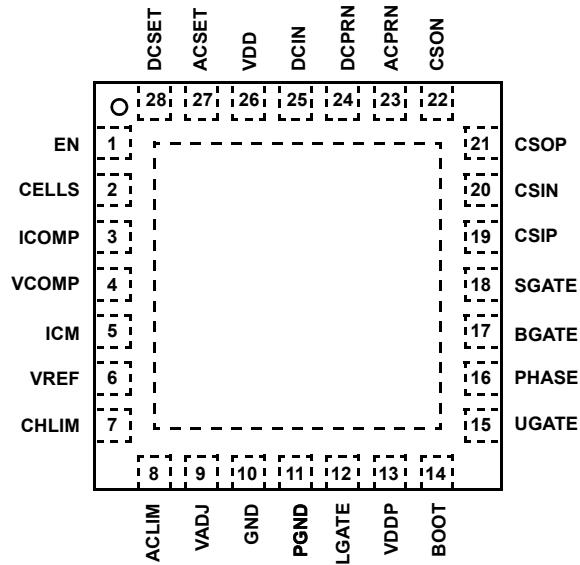

What's Inside

This Evaluation Board Kit contains the following materials:

- Qty(1) ISL625x EVAL2Z Evaluation Board
- Qty(1) ISL6255EVAL2Z Setup Procedure

What is Needed

The following materials are recommended to perform testing:

- One adjustable 25V 6A power supply
- Two adjustable 6A constant current electronic loads
- Two DVMs
- One 500MHz four channel oscilloscope
- Four passive oscilloscope voltage probes
- Two 10ADC Current Probes
- One Signal generator

Jumper Selection Guide

Step 1: Select the Number of Cells (Table 1)

The CELLS pin chooses the correct output voltage clamp for a given number of cells series-connected in the battery pack. Select the output voltage by placing a shunt jumper across the appropriate pins of JP1.

TABLE 1. JUMPER JP1 FUNCTIONS

SHUNT JUMPER LOCATION	CELLS PIN CONNECTED TO:	NUMBER OF CELLS CONNECTED IN SERIES	100% CONSTANT OUTPUT VOLTAGE
1 to 2	VDD	4	16.8
2 to 3	GND	3	12.6
Removed	Floating	2	8.4

Step 2: Select the Cell Trim Voltage (Table 2)

The VADJ pin trims the battery charger output voltage limit. Preset battery charger output voltage limits are selected by placing a shunt jumper across the appropriate pins of JP6. For other battery charger output voltage limits, install a shunt jumper across pins 3 and 4, which connects the wiper of potentiometer R₂₄ to VADJ. Potentiometer R₂₄ may be removed and replaced with resistors R₁₉ and R₂₁. Resistor R₂₀ limits the trim increase to 1%. Shorting R₂₀ allows the trim to increase 5%. Decreasing trim range is unaffected.

TABLE 2. JUMPER JP6 FUNCTIONS

SHUNT LOCATION	VADJ PIN	BATTERY VOLTAGE CHANGE PER CELL
1 to 3	Through R ₂₀ to VREF	+5%
3 to 5	To GND	-5%
5 to 6	Floating	None
3 to 4	R ₂₄ Wiper or R ₁₉ /R ₂₁	Adjustable between -5% to +5%

Step 3: Select the Battery Charger Current Limit (Table 3)

The CHLIM pin chooses the desired battery charger current limit threshold. Preset battery charger current limit thresholds are selected by placing a shunt jumper across the appropriate pins of JP4. For other battery charger current limit thresholds, install a shunt jumper across pins 3 and 4, which connects the wiper of potentiometer R₂₂ to CHLIM. Potentiometer R₂₂ may be removed and replaced with resistors R₆ and R₇.

TABLE 3. JUMPER JP4 FUNCTIONS

SHUNT JUMPER LOCATION	CHLIM PIN CONNECTED TO:	100% CURRENT FEEDBACK CSOP TO CSON	100% CONSTANT CURRENT
1 to 3	VREF	120mV	4.80A
Removed	Floating	0V	0A
3 to 5	GND	0V	0A
3 to 4	R ₂₂ or R ₆ /R ₇	0mV to 120mV	0A to 4.8A

Step 4: Select the AC Adapter Current Limit (Table 4)

The ACLIM pin chooses the desired AC adapter current limit threshold. Preset AC adapter current limit thresholds are selected by placing a shunt jumper across the appropriate pins of JP5. For other AC adapter current limit thresholds, install a shunt jumper across pins 3 and 4, which connects the wiper of potentiometer R₂₃ to ACLIM. Potentiometer R₂₃ may be removed and replaced with resistors R₁₇ and R₁₈.

TABLE 4. JUMPER JP5 FUNCTIONS

SHUNT JUMPER LOCATION	ACLIM PIN CONNECTED TO:	100% CURRENT FEEDBACK CSIP TO CSIN	100% ADAPTER CURRENT
1 to 3	VREF	100mV	5.15A
Removed	Floating	75mV	3.90A
3 to 5	GND	50mV	2.65A
3 to 4	R ₂₃ or R ₁₇ /R ₁₈	50mV to 100mV	2.65A to 5.15A

Interface Connections

TABLE 5.

HEADER	PIN#	CONNECT TO
H1 INPUT POWER	1	"+" INPUT POWER
	2	"+" SENSE (if used)
	3	"-" SENSE (if used)
	4	"-" INPUT POWER
H2 SYSTEMLOAD OUTPUT	1	"+" SYSTEM LOAD OUTPUT
	2	"+" SENSE (if used)
	3	"-" SENSE (if used)
	4	"-" SYSTEM LOAD OUTPUT
H3 BATTERY CHARGER OUTPUT	1	"+" BATTERY CHARGER OUTPUT
	2	"+" SENSE (if used)
	3	"-" SENSE (if used)
	4	"-" BATTERY CHARGER OUTPUT

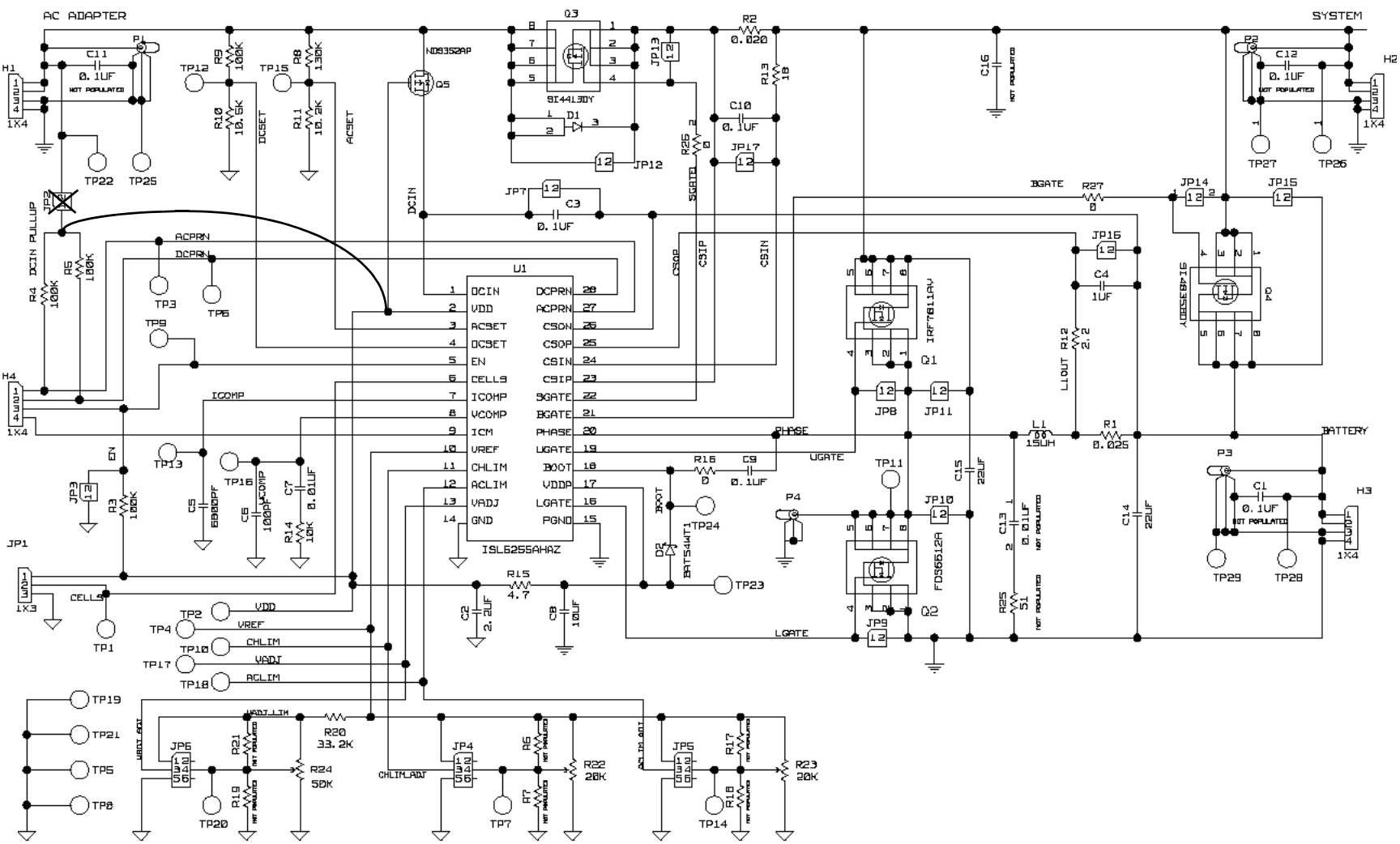

ISL6255EVAL2Z Schematic



TABLE 6. BILL OF MATERIALS

QTY	REF DES	DESCRIPTION	MFG NAME	PART NUMBER
1	C6	Capacitor, SMD, 0603, 100pF, 50V, 5%, COG	TDK	C1608COG1H101J
1	C7	Capacitor, SMD, 0805, 0.01 μ F, 50V, 5%, COG	TDK	C2012COG1H103J
1	C5	Capacitor, SMD, 0805, 6800pF, 50V, 5%, COG	TDK	C2012COG1H682J
3	C2, C4, C8	Capacitor, SMD, 0805, 1.0 μ F, 16V, 20%, X7R	TDK	C2012X7R1C105M
3	C3, C9, C10	Capacitor, SMD, 0805, 0.1 μ F, 50V, 10%, X7R	TDK	C2012X7R1H104K
2	C14, C15	Capacitor, SMD, 1812, 22 μ F, 25V, 20%, X5R	TDK	C4532X5R1E226M
1	L1	Choke, SMD, 8mm, 15 μ H, 20%, 5.65A, Shielded	Sumida	CDRH127/LD-150NC
1	U1	IC, Battery Charger, 24 Ld QSOP, -10°C to +100°C	Intersil	ISL6251HAZ
1	Q2	MOSFET, N-CH, 8P, SOIC, 30V, 8.4A, 0.022 Ω	Fairchild	FDS6612A
1	Q1	MOSFET, N-CH, 8P, SOIC, 30V, 10.8A, 0.011 Ω	IR	IRF7811AV
1	Q3	MOSFET, P-CH, SOIC, 30V, 13A, 0.014 Ω	Siliconix	SI4413DY
1	Q4	MOSFET, P-CH, SOIC, 30V, 6A, 0.033 Ω	Siliconix	SI4835BDY
1	Q5	MOSFET, P-CH, 3P, SOT23, -30V, -0.9A, 0.5 Ω	Fairchild	NDS352AP
1	D1	DIODE SCHOTTKY 40V 10A POWERDI5	Diodes Inc.	PDS1040-13
1	D2	SURFACE MOUNT SCHOTTKY BARRIER DIODE	Diodes Inc	BAT54WT1
1	R2	Resistor, Shunt, SMD, 2010, 0.020 Ω , 1W, 1%	IRC	LRC-LRF2010-01-R020-F
1	R1	Resistor, Shunt, SMD, 2010, 0.025 Ω , 1W, 1%	IRC	LRC-LRF2010-01-R025-F
1	R13	Resistor, SMD, 0805, 18 Ω , 0.125W, 5%	KOA	RK73B2AT180J
1	R12	Resistor, SMD, 0805, 2.2 Ω , 0.125W, 5%	KOA	RK73B2AT2R2J
1	R15	Resistor, SMD, 0805, 4.7 Ω , 0.125W, 5%	KOA	RK73B2AT4R7J
1	R14	Resistor, SMD, 0805, 10k Ω , 0.125W, 1%	KOA	RK73H2AT1002F
1	R11	Resistor, SMD, 0805, 7.87k Ω , 0.125W, 1%	KOA	RK73H2AT7871F
3	R3, R4, R8	Resistor, SMD, 0805, 100k Ω , 0.125W, 1%	KOA	RK73H2AT1003F
1	R20	Resistor, SMD, 0805, 33.2k Ω , 0.125W, 1%	KOA	RK73H2AT3322F
1	R16	Resistor, SMD, 0805, 0 Ω , 2A, 50m Ω Max	KOA	RK73Z2AT

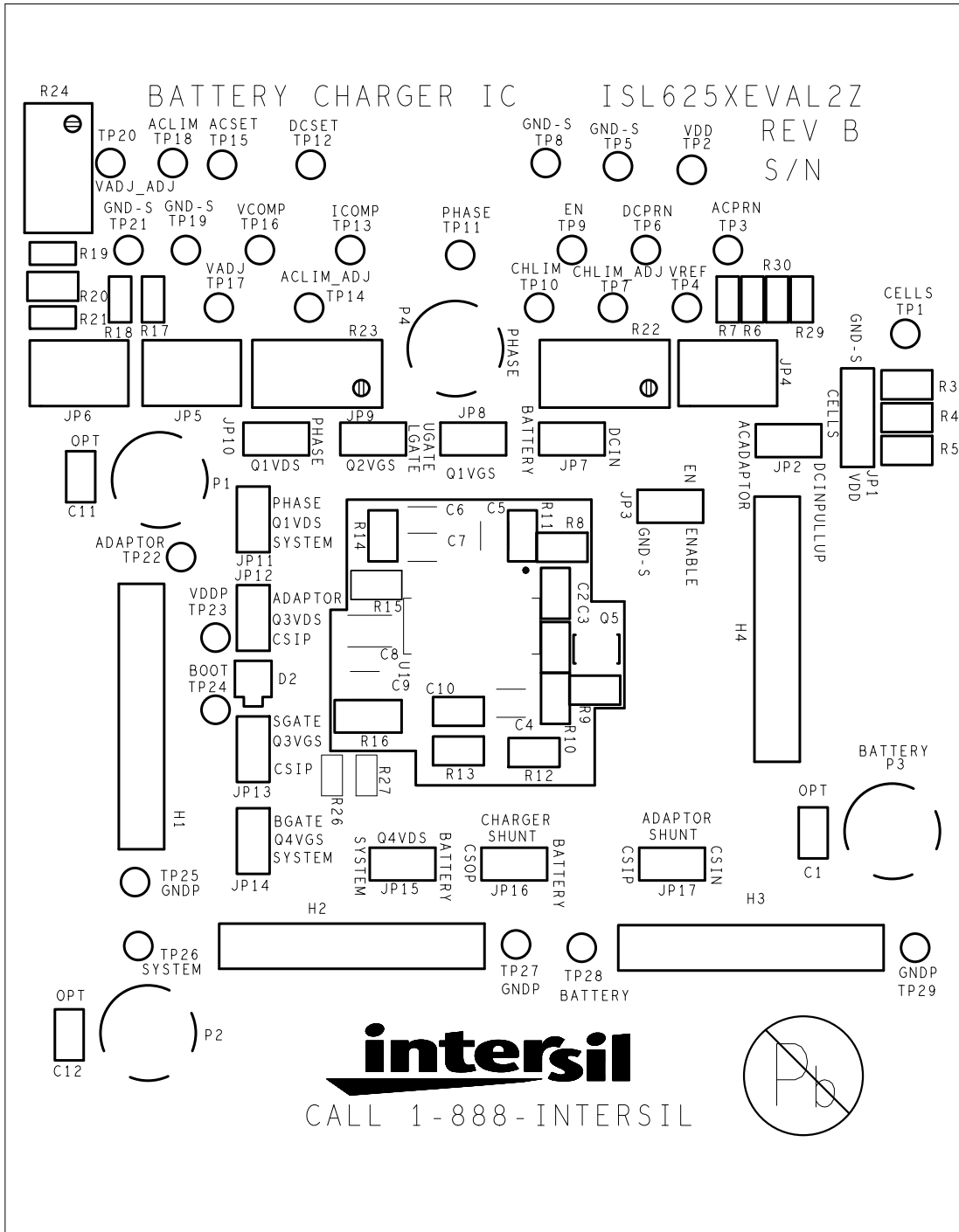

FIGURE 1. TOP SILK

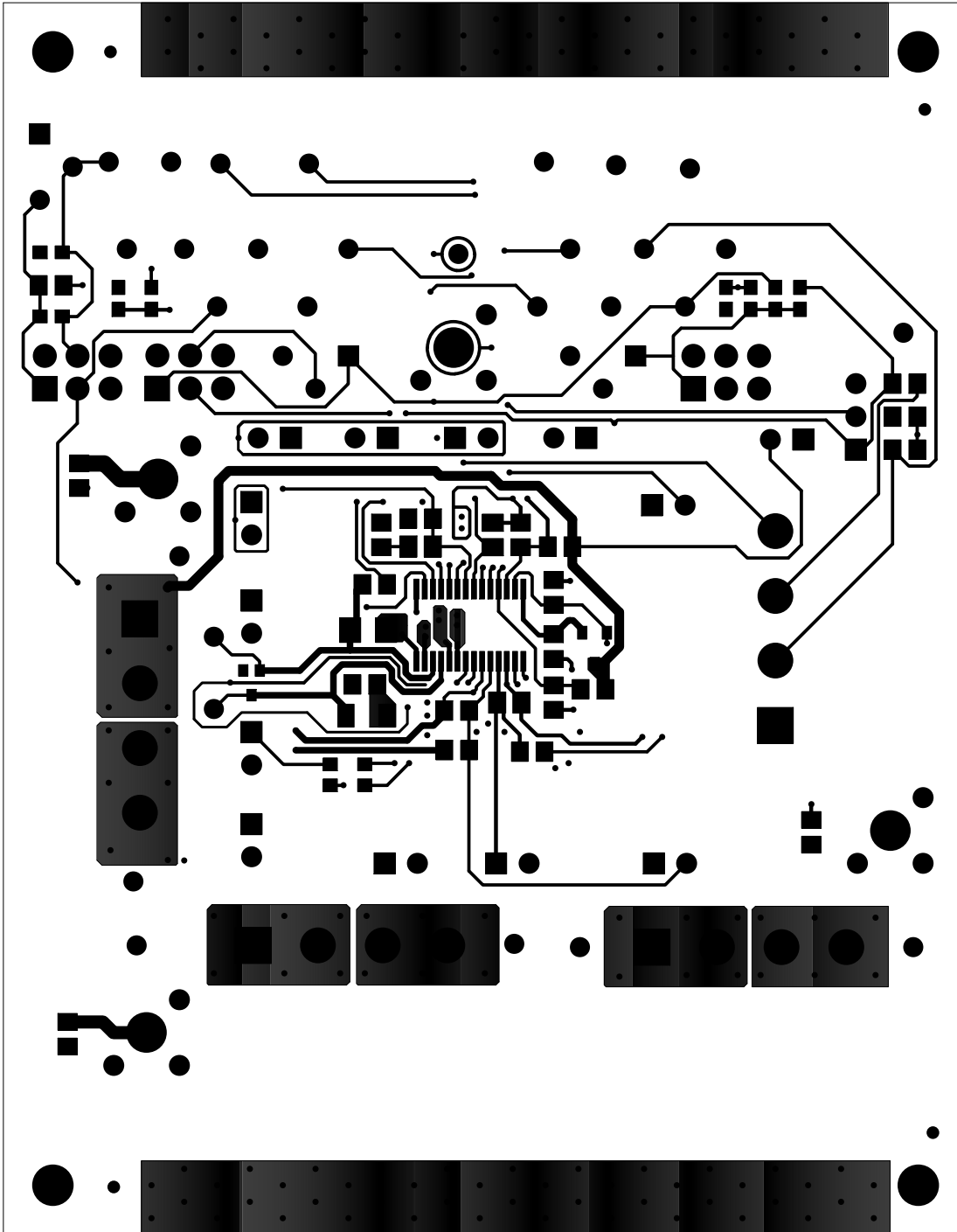

FIGURE 2. TOP LAYER

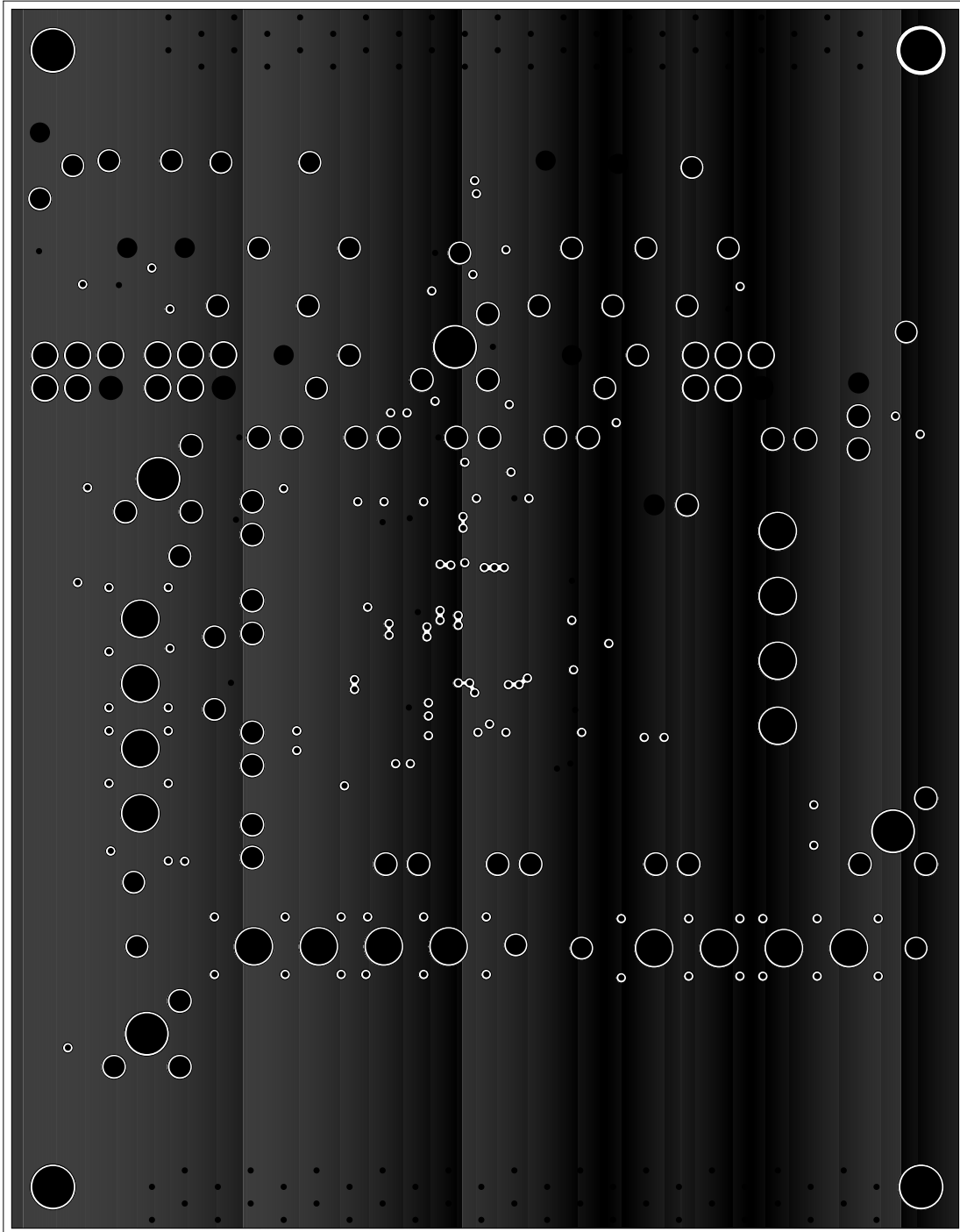

FIGURE 3. LAYER 2 GROUND

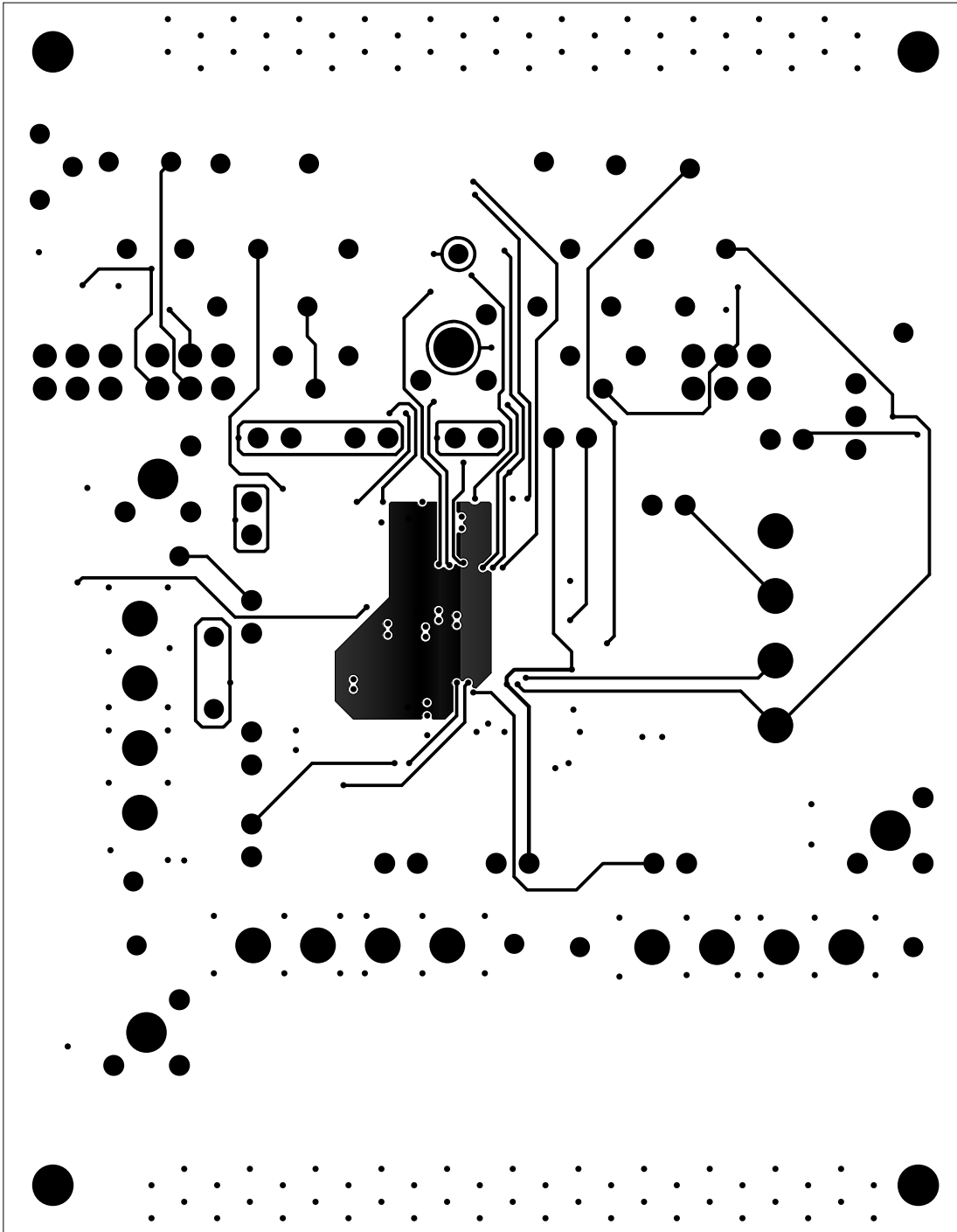

FIGURE 4. LAYER 3 SIGNAL

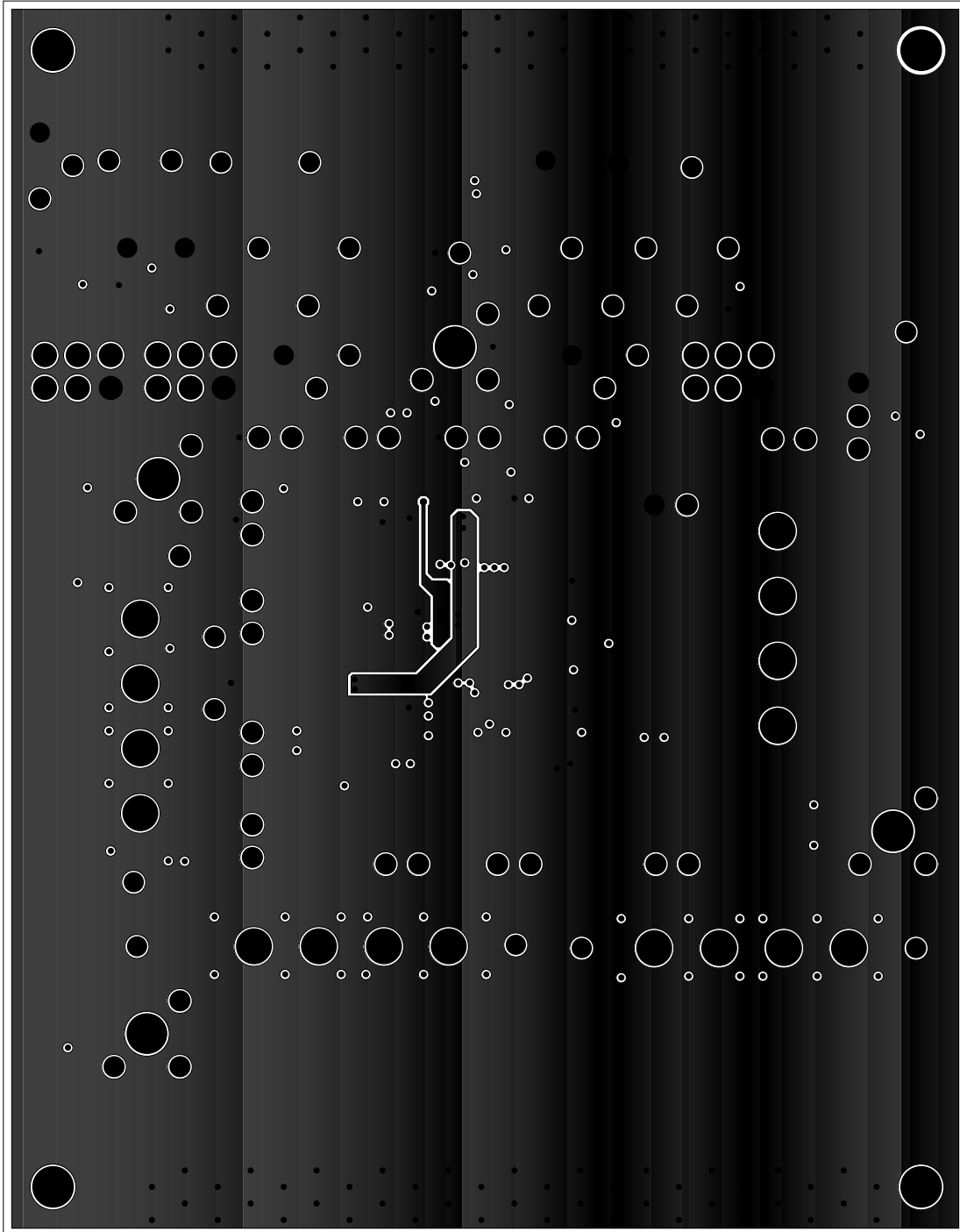

FIGURE 5. LAYER 4 GROUND

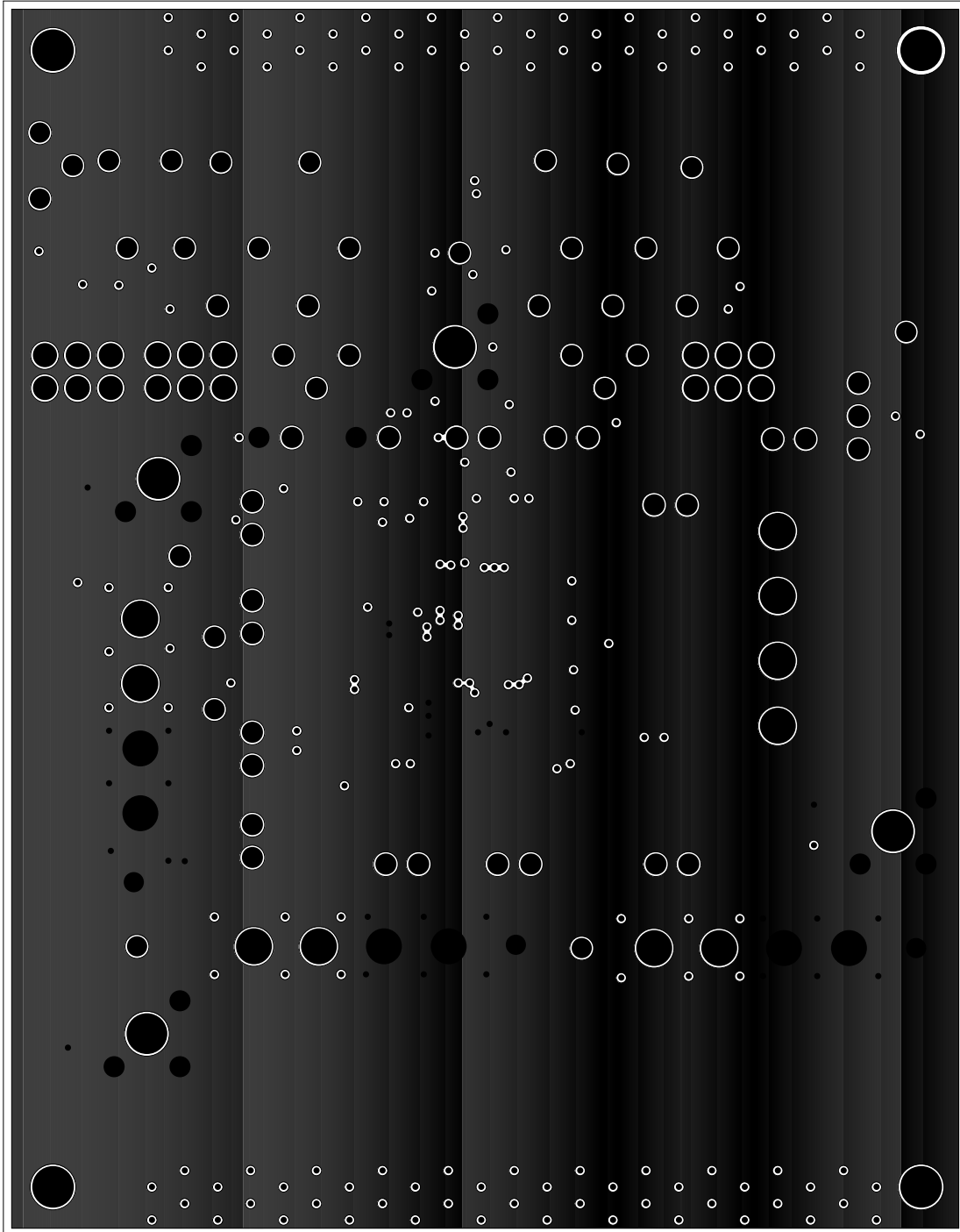

FIGURE 6. LAYER 5 GROUND

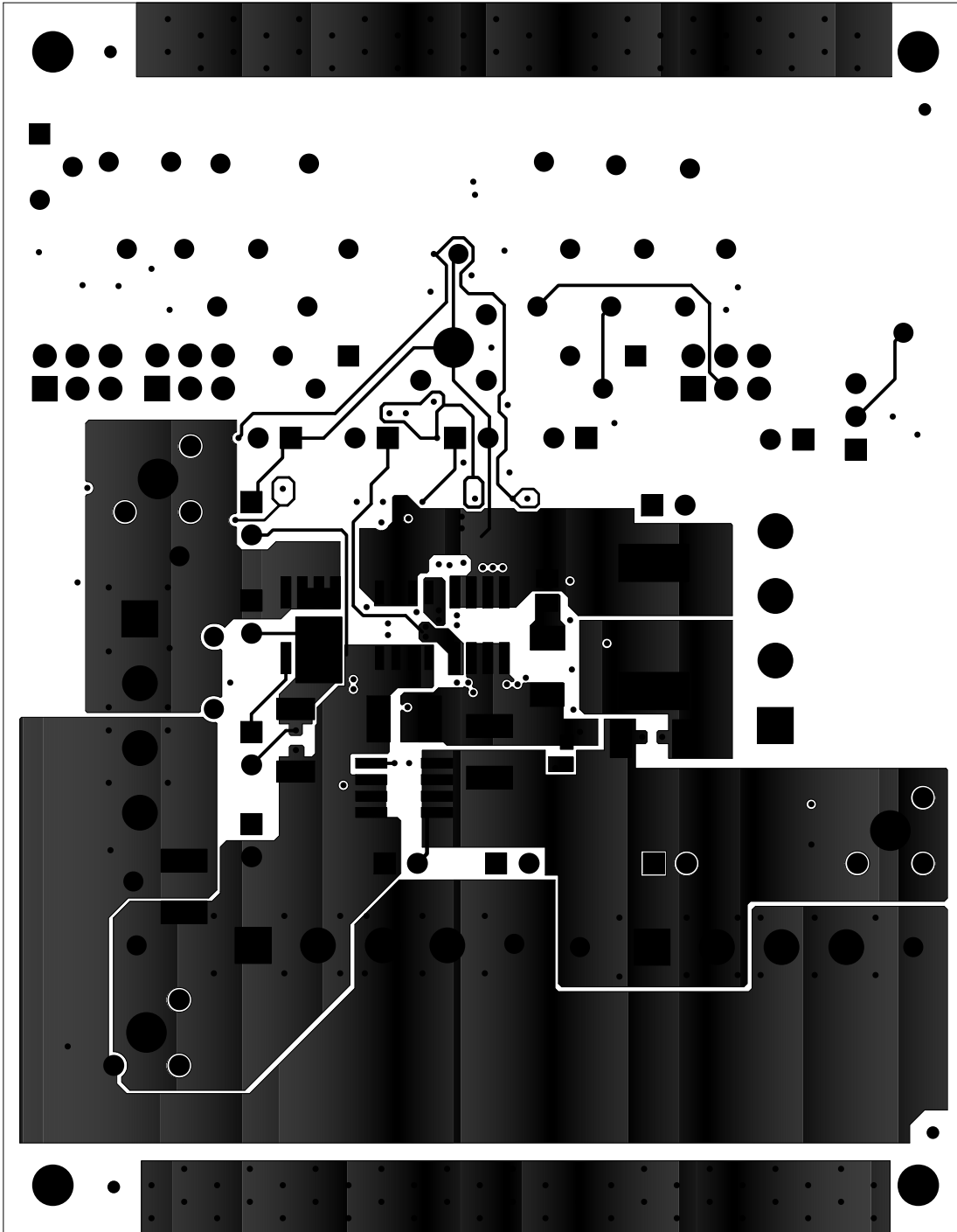

FIGURE 7. BOTTOM COPPER

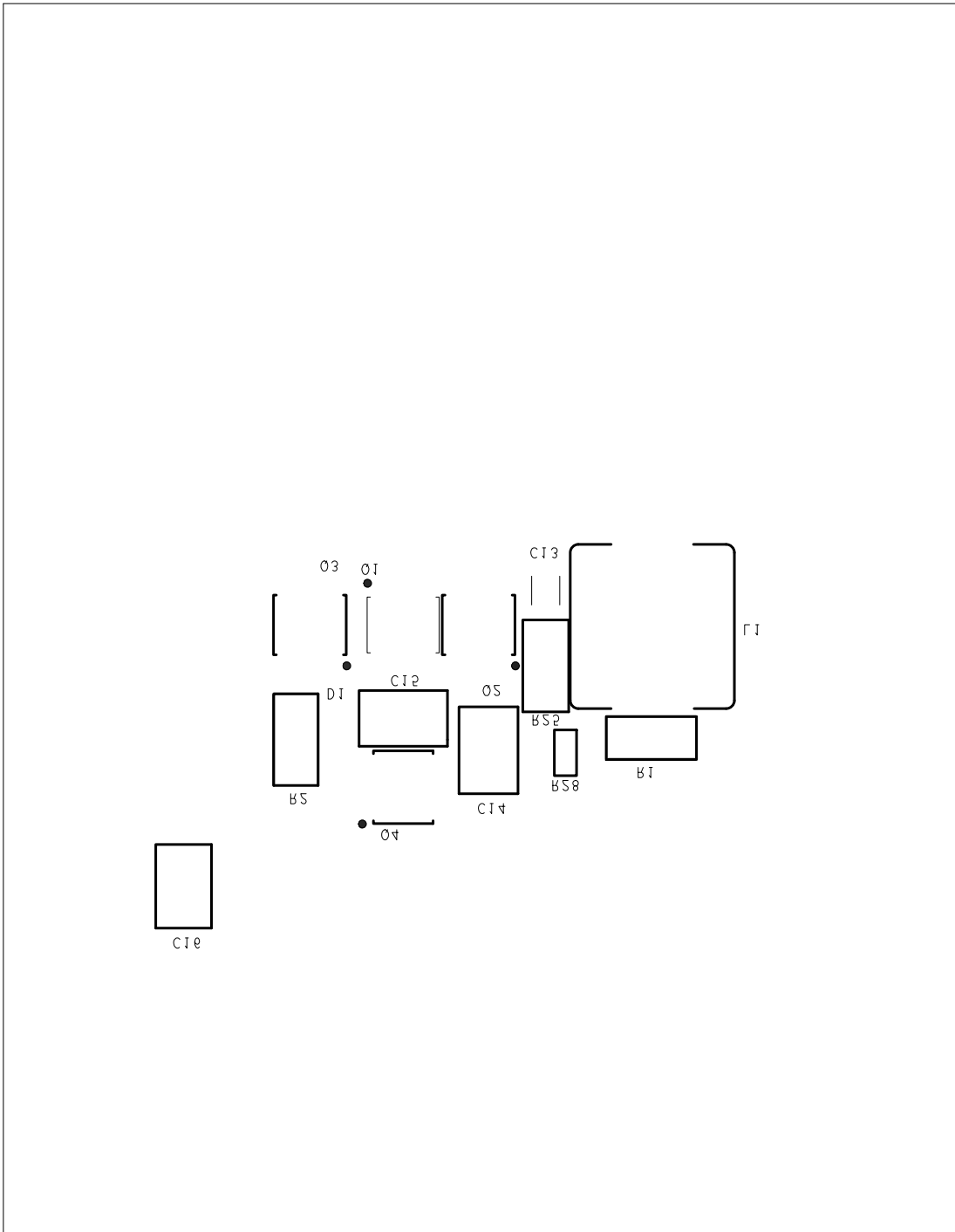

FIGURE 8. BOTTOM SILK

Notice

1. Descriptions of circuits, software and other related information in this document are provided only to illustrate the operation of semiconductor products and application examples. You are fully responsible for the incorporation or any other use of the circuits, software, and information in the design of your product or system. Renesas Electronics disclaims any and all liability for any losses and damages incurred by you or third parties arising from the use of these circuits, software, or information.
2. Renesas Electronics hereby expressly disclaims any warranties against and liability for infringement or any other claims involving patents, copyrights, or other intellectual property rights of third parties, by or arising from the use of Renesas Electronics products or technical information described in this document, including but not limited to, the product data, drawings, charts, programs, algorithms, and application examples.
3. No license, express, implied or otherwise, is granted hereby under any patents, copyrights or other intellectual property rights of Renesas Electronics or others.
4. You shall not alter, modify, copy, or reverse engineer any Renesas Electronics product, whether in whole or in part. Renesas Electronics disclaims any and all liability for any losses or damages incurred by you or third parties arising from such alteration, modification, copying or reverse engineering.
5. Renesas Electronics products are classified according to the following two quality grades: "Standard" and "High Quality". The intended applications for each Renesas Electronics product depends on the product's quality grade, as indicated below.
"Standard": Computers; office equipment; communications equipment; test and measurement equipment; audio and visual equipment; home electronic appliances; machine tools; personal electronic equipment; industrial robots; etc.
"High Quality": Transportation equipment (automobiles, trains, ships, etc.); traffic control (traffic lights); large-scale communication equipment; key financial terminal systems; safety control equipment; etc.
Unless expressly designated as a high reliability product or a product for harsh environments in a Renesas Electronics data sheet or other Renesas Electronics document, Renesas Electronics products are not intended or authorized for use in products or systems that may pose a direct threat to human life or bodily injury (artificial life support devices or systems; surgical implantations; etc.), or may cause serious property damage (space system; undersea repeaters; nuclear power control systems; aircraft control systems; key plant systems; military equipment; etc.). Renesas Electronics disclaims any and all liability for any damages or losses incurred by you or any third parties arising from the use of any Renesas Electronics product that is inconsistent with any Renesas Electronics data sheet, user's manual or other Renesas Electronics document.
6. When using Renesas Electronics products, refer to the latest product information (data sheets, user's manuals, application notes, "General Notes for Handling and Using Semiconductor Devices" in the reliability handbook, etc.), and ensure that usage conditions are within the ranges specified by Renesas Electronics with respect to maximum ratings, operating power supply voltage range, heat dissipation characteristics, installation, etc. Renesas Electronics disclaims any and all liability for any malfunctions, failure or accident arising out of the use of Renesas Electronics products outside of such specified ranges.
7. Although Renesas Electronics endeavors to improve the quality and reliability of Renesas Electronics products, semiconductor products have specific characteristics, such as the occurrence of failure at a certain rate and malfunctions under certain use conditions. Unless designated as a high reliability product or a product for harsh environments in a Renesas Electronics data sheet or other Renesas Electronics document, Renesas Electronics products are not subject to radiation resistance design. You are responsible for implementing safety measures to guard against the possibility of bodily injury, injury or damage caused by fire, and/or danger to the public in the event of a failure or malfunction of Renesas Electronics products, such as safety design for hardware and software, including but not limited to redundancy, fire control and malfunction prevention, appropriate treatment for aging degradation or any other appropriate measures. Because the evaluation of microcomputer software alone is very difficult and impractical, you are responsible for evaluating the safety of the final products or systems manufactured by you.
8. Please contact a Renesas Electronics sales office for details as to environmental matters such as the environmental compatibility of each Renesas Electronics product. You are responsible for carefully and sufficiently investigating applicable laws and regulations that regulate the inclusion or use of controlled substances, including without limitation, the EU RoHS Directive, and using Renesas Electronics products in compliance with all these applicable laws and regulations. Renesas Electronics disclaims any and all liability for damages or losses occurring as a result of your noncompliance with applicable laws and regulations.
9. Renesas Electronics products and technologies shall not be used for or incorporated into any products or systems whose manufacture, use, or sale is prohibited under any applicable domestic or foreign laws or regulations. You shall comply with any applicable export control laws and regulations promulgated and administered by the governments of any countries asserting jurisdiction over the parties or transactions.
10. It is the responsibility of the buyer or distributor of Renesas Electronics products, or any other party who distributes, disposes of, or otherwise sells or transfers the product to a third party, to notify such third party in advance of the contents and conditions set forth in this document.
11. This document shall not be reprinted, reproduced or duplicated in any form, in whole or in part, without prior written consent of Renesas Electronics.
12. Please contact a Renesas Electronics sales office if you have any questions regarding the information contained in this document or Renesas Electronics products.
(Note 1) "Renesas Electronics" as used in this document means Renesas Electronics Corporation and also includes its directly or indirectly controlled subsidiaries.
(Note 2) "Renesas Electronics product(s)" means any product developed or manufactured by or for Renesas Electronics.

(Rev.4.0-1 November 2017)



SALES OFFICES

Renesas Electronics Corporation

<http://www.renesas.com>

Refer to "<http://www.renesas.com/>" for the latest and detailed information.

Renesas Electronics America Inc.
1001 Murphy Ranch Road, Milpitas, CA 95035, U.S.A.
Tel: +1-408-432-8888, Fax: +1-408-434-5351

Renesas Electronics Canada Limited
9251 Yonge Street, Suite 8309 Richmond Hill, Ontario Canada L4C 9T3
Tel: +1-905-237-2004

Renesas Electronics Europe Limited
Dukes Meadow, Millboard Road, Bourne End, Buckinghamshire, SL8 5FH, U.K
Tel: +44-1628-651-700, Fax: +44-1628-651-804

Renesas Electronics Europe GmbH
Arcadiastrasse 10, 40472 Düsseldorf, Germany
Tel: +49-211-6503-0, Fax: +49-211-6503-1327

Renesas Electronics (China) Co., Ltd.
Room 1709 Quantum Plaza, No.27 ZhichunLu, Haidian District, Beijing, 100191 P. R. China
Tel: +86-10-8235-1155, Fax: +86-10-8235-7679

Renesas Electronics (Shanghai) Co., Ltd.
Unit 301, Tower A, Central Towers, 555 Langao Road, Putuo District, Shanghai, 200333 P. R. China
Tel: +86-21-2226-0888, Fax: +86-21-2226-0999

Renesas Electronics Hong Kong Limited
Unit 1601-1611, 16/F., Tower 2, Grand Century Place, 193 Prince Edward Road West, Mongkok, Kowloon, Hong Kong
Tel: +852-2265-6688, Fax: +852-2886-9022

Renesas Electronics Taiwan Co., Ltd.
13F, No. 363, Fu Shing North Road, Taipei 10543, Taiwan
Tel: +886-2-8175-9600, Fax: +886-2-8175-9670

Renesas Electronics Singapore Pte. Ltd.
80 Bendemeer Road, Unit #06-02 Hyflux Innovation Centre, Singapore 339949
Tel: +65-6213-0200, Fax: +65-6213-0300

Renesas Electronics Malaysia Sdn.Bhd.
Unit 1207, Block B, Menara Amcorp, Amcorp Trade Centre, No. 18, Jln Persiaran Barat, 46050 Petaling Jaya, Selangor Darul Ehsan, Malaysia
Tel: +60-3-7955-9390, Fax: +60-3-7955-9510

Renesas Electronics India Pvt. Ltd.
No.777C, 100 Feet Road, HAL 2nd Stage, Indiranagar, Bangalore 560 038, India
Tel: +91-80-67208700, Fax: +91-80-67208777

Renesas Electronics Korea Co., Ltd.
17F, KAMCO Yangjae Tower, 262, Gangnam-daero, Gangnam-gu, Seoul, 06265 Korea
Tel: +82-2-558-3737, Fax: +82-2-558-5338

ISL6255EVAL2Z

Evaluation Board

AN1297
Rev 0.00
April 10, 2007

General Description

The ISL6255EVAL2Z REV B EV kit includes all the circuitry needed to demonstrate the capabilities of the ISL6255 Lithium-Ion battery-charger with integrated AC adapter current limit. The user can experiment with an extensive matrix of battery charge parameters, AC adapter current limit, monitor functions, and load switching.

The ISL6255, ISL6255A is a highly integrated battery charger controller for Li-Ion/Li-Ion polymer batteries. High Efficiency is achieved by a synchronous buck topology and the use of a MOSFET, instead of a diode, for selecting power from the adapter or battery. The low side MOSFET emulates a diode at light loads to improve the light load efficiency and prevent system bus boosting.

The constant output voltage can be selected for 2, 3 and 4 series Li-Ion cells with 0.5% accuracy over-temperature. It can also be programmed between 4.2V + 5%/cell and 4.2V - 5%/cell to optimize battery capacity. When supplying the load and battery charger simultaneously, the input current limit for the AC adapter is programmable to within 3% accuracy to avoid overloading the AC adapter and to allow the system to make efficient use of available adapter power for charging. It also has a wide range of programmable charging current. The ISL6255, ISL6255A provides outputs that are used to monitor the current drawn from the AC adapter, and monitor for the presence of an AC adapter. The ISL6255, ISL6255A automatically transitions from regulating current mode to regulating voltage mode.

ISL6255, ISL6255A has a feature for automatic power source selection by switching to the battery when the AC adapter is removed or switching to the AC adapter when the AC adapter is available. It also provides a DC adapter monitor to support aircraft power applications with the option of no battery charging.

Features

- ±0.5% Charge Voltage Accuracy (-10°C to +100°C)
- ±3% Accurate Input Current Limit
- ±3% Accurate Battery Charge Current Limit
- ±25% Accurate Battery Trickle Charge Current Limit (ISL6255A)
- Programmable Charge Current Limit, Adapter Current Limit and Charge Voltage
- Fixed 300kHz PWM Synchronous Buck Controller with Diode Emulation at Light Load
- Output for Current Drawn from AC Adapter
- AC Adapter Present Indicator
- Fast Input Current Limit Response
- Input Voltage Range 7V to 25V
- Support 2, 3 and 4 Cells Battery Pack
- Up to 17.64V Battery-Voltage Set Point
- Control Adapter Power Source Select MOSFET
- Thermal Shutdown
- Aircraft Power Capable
- DC Adapter Present Indicator
- Battery Discharge MOSFET Control
- Less than 10µA Battery Leakage Current
- Support Pulse Charging
- Charge Any Battery Chemistry: Li-Ion, NiCd, NiMH, etc.
- Pb-Free Plus Anneal Available (RoHS Compliant)

Applications

- Notebook, Desknote and Sub-notebook Computers
- Personal Digital Assistant

Ordering Information

PART NUMBER (Notes 1, 2)	PART MARKING	TEMP RANGE (°C)	PACKAGE (Pb-free)	PKG. DWG. #
ISL6255HRZ	ISL 6255HRZ	-10 to +100	28 Ld 5x5 QFN	L28.5x5
ISL6255HAZ	ISL 6255HAZ	-10 to +100	28 Ld QSOP	M28.15
ISL6255AHRZ	ISL6255 AHRZ	-10 to +100	28 Ld 5x5 QFN	L28.5x5
ISL6255AAZ	ISL6255 AAZ	-10 to +100	28 Ld QSOP	M28.15

NOTES:

1. Intersil Pb-free plus anneal products employ special Pb-free material sets; molding compounds/die attach materials and 100% matte tin plate termination finish, which are RoHS compliant and compatible with both SnPb and Pb-free soldering operations. Intersil Pb-free products are MSL classified at Pb-free peak reflow temperatures that meet or exceed the Pb-free requirements of IPC/JEDEC J STD-020.
2. Add "-T" for Tape and Reel.

What's Inside

This Evaluation Board Kit contains the following materials:

- Qty(1) ISL625x EVAL2Z Evaluation Board
- Qty(1) ISL6255EVAL2Z Setup Procedure

What is Needed

The following materials are recommended to perform testing:

- One adjustable 25V 6A power supply
- Two adjustable 6A constant current electronic loads
- Two DVMs
- One 500MHz four channel oscilloscope
- Four passive oscilloscope voltage probes
- Two 10ADC Current Probes
- One Signal generator

Jumper Selection Guide

Step 1: Select the Number of Cells (Table 1)

The CELLS pin chooses the correct output voltage clamp for a given number of cells series-connected in the battery pack. Select the output voltage by placing a shunt jumper across the appropriate pins of JP1.

TABLE 1. JUMPER JP1 FUNCTIONS

SHUNT JUMPER LOCATION	CELLS PIN CONNECTED TO:	NUMBER OF CELLS CONNECTED IN SERIES	100% CONSTANT OUTPUT VOLTAGE
1 to 2	VDD	4	16.8
2 to 3	GND	3	12.6
Removed	Floating	2	8.4

Step 2: Select the Cell Trim Voltage (Table 2)

The VADJ pin trims the battery charger output voltage limit. Preset battery charger output voltage limits are selected by placing a shunt jumper across the appropriate pins of JP6. For other battery charger output voltage limits, install a shunt jumper across pins 3 and 4, which connects the wiper of potentiometer R₂₄ to VADJ. Potentiometer R₂₄ may be removed and replaced with resistors R₁₉ and R₂₁. Resistor R₂₀ limits the trim increase to 1%. Shorting R₂₀ allows the trim to increase 5%. Decreasing trim range is unaffected.

TABLE 2. JUMPER JP6 FUNCTIONS

SHUNT LOCATION	VADJ PIN	BATTERY VOLTAGE CHANGE PER CELL
1 to 3	Through R ₂₀ to VREF	+5%
3 to 5	To GND	-5%
5 to 6	Floating	None
3 to 4	R ₂₄ Wiper or R ₁₉ /R ₂₁	Adjustable between -5% to +5%

Step 3: Select the Battery Charger Current Limit (Table 3)

The CHLIM pin chooses the desired battery charger current limit threshold. Preset battery charger current limit thresholds are selected by placing a shunt jumper across the appropriate pins of JP4. For other battery charger current limit thresholds, install a shunt jumper across pins 3 and 4, which connects the wiper of potentiometer R₂₂ to CHLIM. Potentiometer R₂₂ may be removed and replaced with resistors R₆ and R₇.

TABLE 3. JUMPER JP4 FUNCTIONS

SHUNT JUMPER LOCATION	CHLIM PIN CONNECTED TO:	100% CURRENT FEEDBACK CSOP TO CSON	100% CONSTANT CURRENT
1 to 3	VREF	120mV	4.80A
Removed	Floating	0V	0A
3 to 5	GND	0V	0A
3 to 4	R ₂₂ or R ₆ /R ₇	0mV to 120mV	0A to 4.8A

Step 4: Select the AC Adapter Current Limit (Table 4)

The ACLIM pin chooses the desired AC adapter current limit threshold. Preset AC adapter current limit thresholds are selected by placing a shunt jumper across the appropriate pins of JP5. For other AC adapter current limit thresholds, install a shunt jumper across pins 3 and 4, which connects the wiper of potentiometer R₂₃ to ACLIM. Potentiometer R₂₃ may be removed and replaced with resistors R₁₇ and R₁₈.

TABLE 4. JUMPER JP5 FUNCTIONS

SHUNT JUMPER LOCATION	ACLIM PIN CONNECTED TO:	100% CURRENT FEEDBACK CSIP TO CSIN	100% ADAPTER CURRENT
1 to 3	VREF	100mV	5.15A
Removed	Floating	75mV	3.90A
3 to 5	GND	50mV	2.65A
3 to 4	R ₂₃ or R ₁₇ /R ₁₈	50mV to 100mV	2.65A to 5.15A

Interface Connections

TABLE 5.

HEADER	PIN#	CONNECT TO
H1 INPUT POWER	1	"+" INPUT POWER
	2	"+" SENSE (if used)
	3	"-" SENSE (if used)
	4	"-" INPUT POWER
H2 SYSTEMLOAD OUTPUT	1	"+" SYSTEM LOAD OUTPUT
	2	"+" SENSE (if used)
	3	"-" SENSE (if used)
	4	"-" SYSTEM LOAD OUTPUT
H3 BATTERY CHARGER OUTPUT	1	"+" BATTERY CHARGER OUTPUT
	2	"+" SENSE (if used)
	3	"-" SENSE (if used)
	4	"-" BATTERY CHARGER OUTPUT

TABLE 6. BILL OF MATERIALS

QTY	REF DES	DESCRIPTION	MFG NAME	PART NUMBER
1	C6	Capacitor, SMD, 0603, 100pF, 50V, 5%, COG	TDK	C1608COG1H101J
1	C7	Capacitor, SMD, 0805, 0.01 μ F, 50V, 5%, COG	TDK	C2012COG1H103J
1	C5	Capacitor, SMD, 0805, 6800pF, 50V, 5%, COG	TDK	C2012COG1H682J
3	C2, C4, C8	Capacitor, SMD, 0805, 1.0 μ F, 16V, 20%, X7R	TDK	C2012X7R1C105M
3	C3, C9, C10	Capacitor, SMD, 0805, 0.1 μ F, 50V, 10%, X7R	TDK	C2012X7R1H104K
2	C14, C15	Capacitor, SMD, 1812, 22 μ F, 25V, 20%, X5R	TDK	C4532X5R1E226M
1	L1	Choke, SMD, 8mm, 15 μ H, 20%, 5.65A, Shielded	Sumida	CDRH127/LD-150NC
1	U1	IC, Battery Charger, 24 Ld QSOP, -10°C to +100°C	Intersil	ISL6251HAZ
1	Q2	MOSFET, N-CH, 8P, SOIC, 30V, 8.4A, 0.022 Ω	Fairchild	FDS6612A
1	Q1	MOSFET, N-CH, 8P, SOIC, 30V, 10.8A, 0.011 Ω	IR	IRF7811AV
1	Q3	MOSFET, P-CH, SOIC, 30V, 13A, 0.014 Ω	Siliconix	SI4413DY
1	Q4	MOSFET, P-CH, SOIC, 30V, 6A, 0.033 Ω	Siliconix	SI4835BDY
1	Q5	MOSFET, P-CH, 3P, SOT23, -30V, -0.9A, 0.5 Ω	Fairchild	NDS352AP
1	D1	DIODE SCHOTTKY 40V 10A POWERDI5	Diodes Inc.	PDS1040-13
1	D2	SURFACE MOUNT SCHOTTKY BARRIER DIODE	Diodes Inc	BAT54WT1
1	R2	Resistor, Shunt, SMD, 2010, 0.020 Ω , 1W, 1%	IRC	LRC-LRF2010-01-R020-F
1	R1	Resistor, Shunt, SMD, 2010, 0.025 Ω , 1W, 1%	IRC	LRC-LRF2010-01-R025-F
1	R13	Resistor, SMD, 0805, 18 Ω , 0.125W, 5%	KOA	RK73B2AT180J
1	R12	Resistor, SMD, 0805, 2.2 Ω , 0.125W, 5%	KOA	RK73B2AT2R2J
1	R15	Resistor, SMD, 0805, 4.7 Ω , 0.125W, 5%	KOA	RK73B2AT4R7J
1	R14	Resistor, SMD, 0805, 10k Ω , 0.125W, 1%	KOA	RK73H2AT1002F
1	R11	Resistor, SMD, 0805, 7.87k Ω , 0.125W, 1%	KOA	RK73H2AT7871F
3	R3, R4, R8	Resistor, SMD, 0805, 100k Ω , 0.125W, 1%	KOA	RK73H2AT1003F
1	R20	Resistor, SMD, 0805, 33.2k Ω , 0.125W, 1%	KOA	RK73H2AT3322F
1	R16	Resistor, SMD, 0805, 0 Ω , 2A, 50m Ω Max	KOA	RK73Z2AT

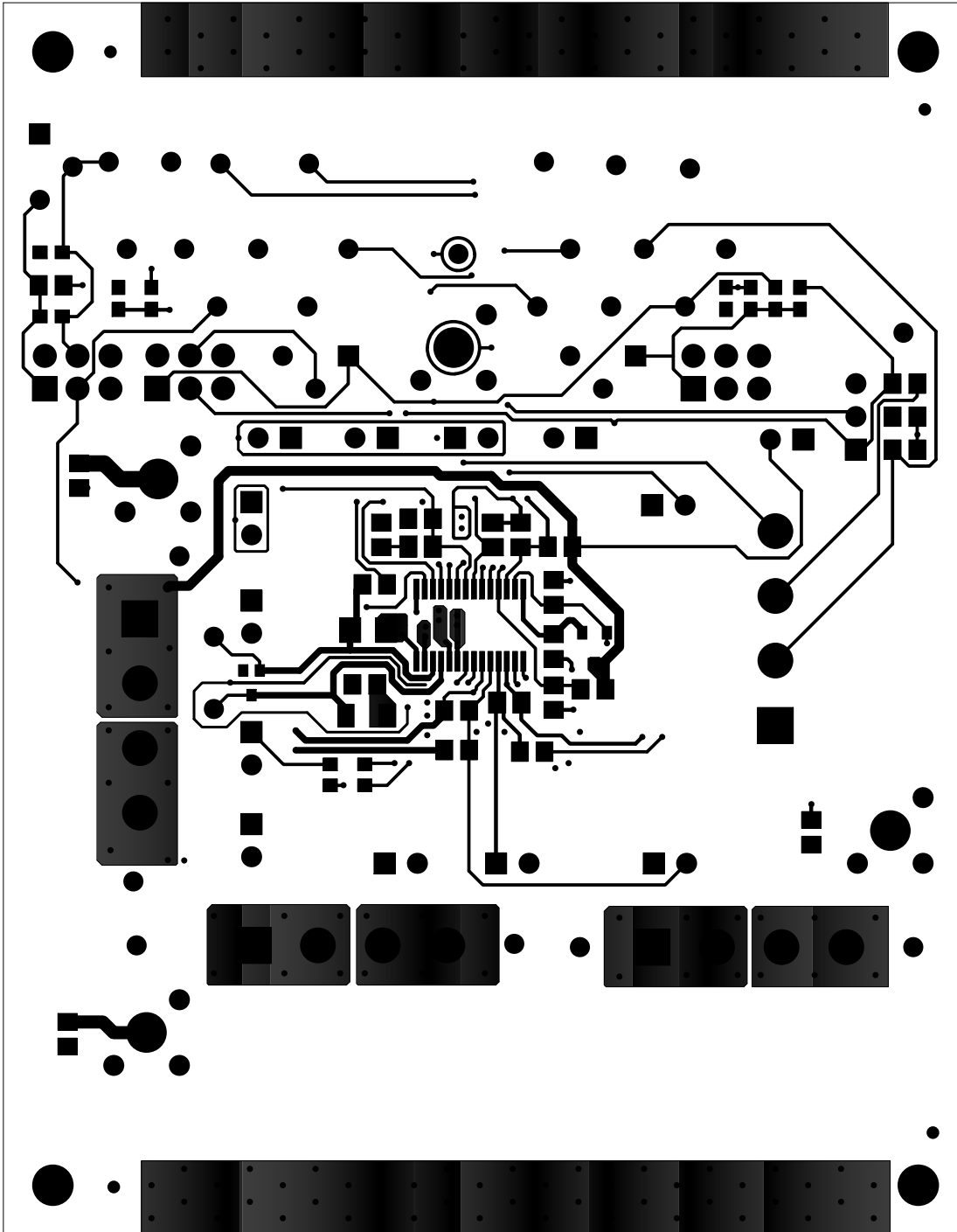

FIGURE 2. TOP LAYER

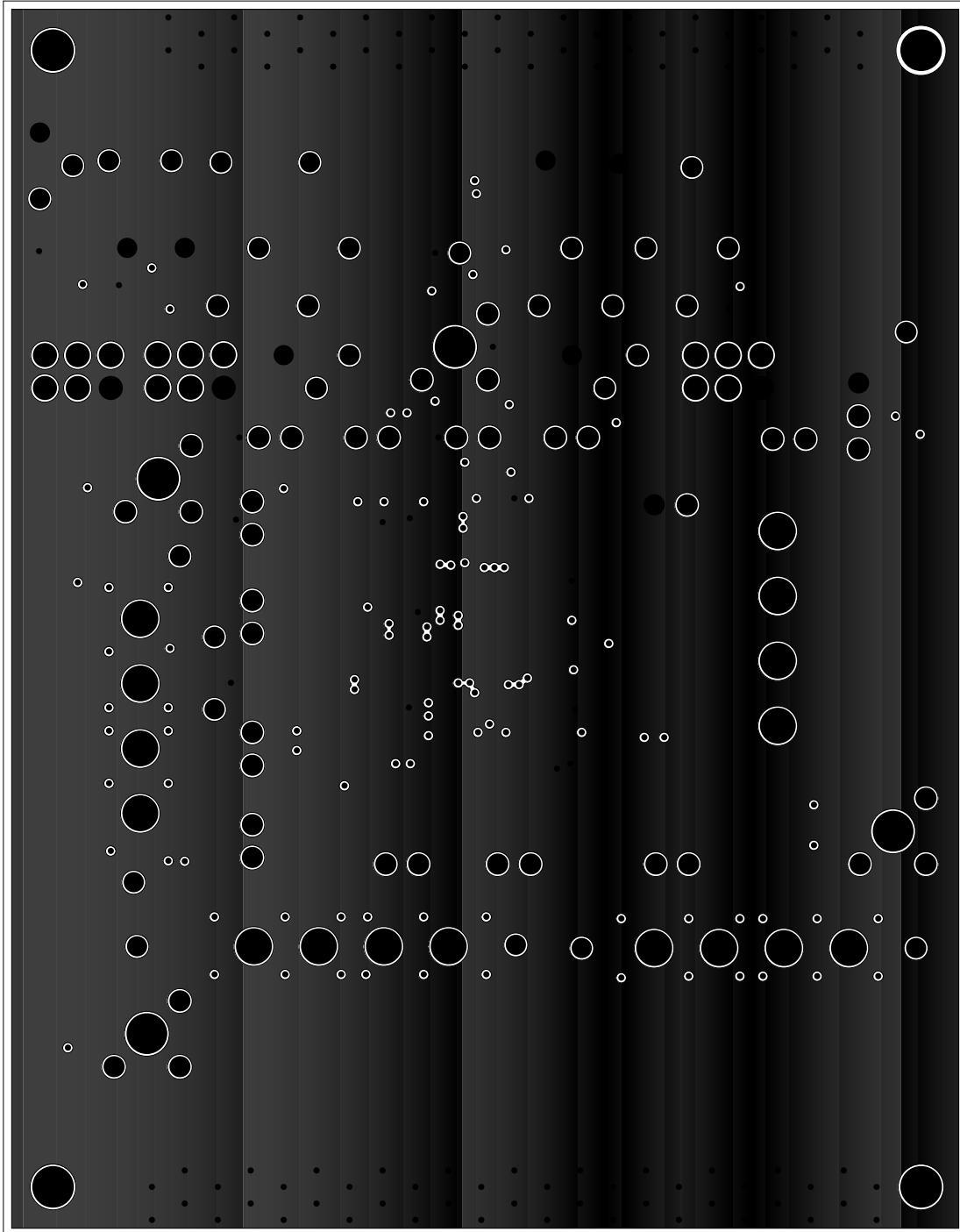

FIGURE 3. LAYER 2 GROUND

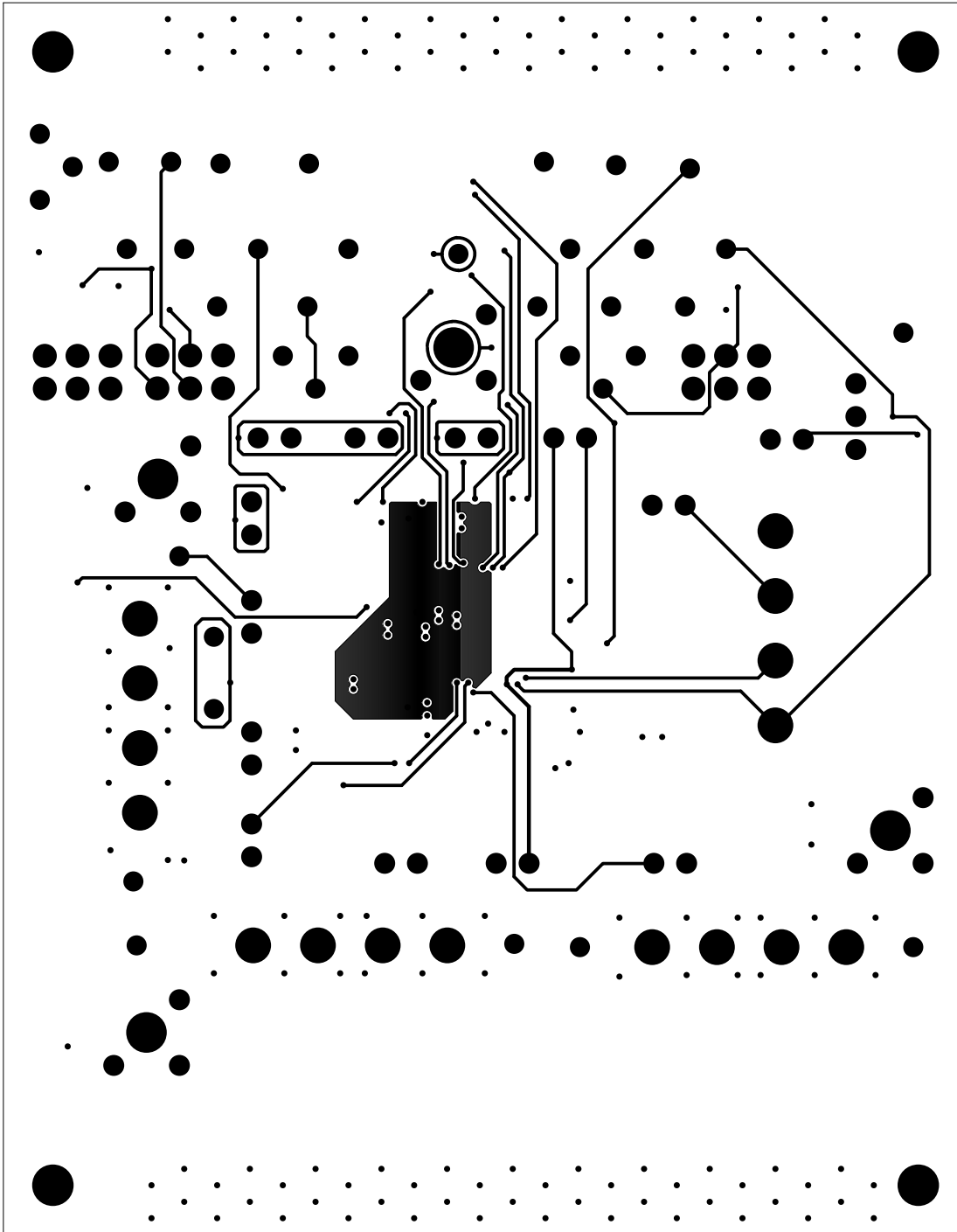

FIGURE 4. LAYER 3 SIGNAL

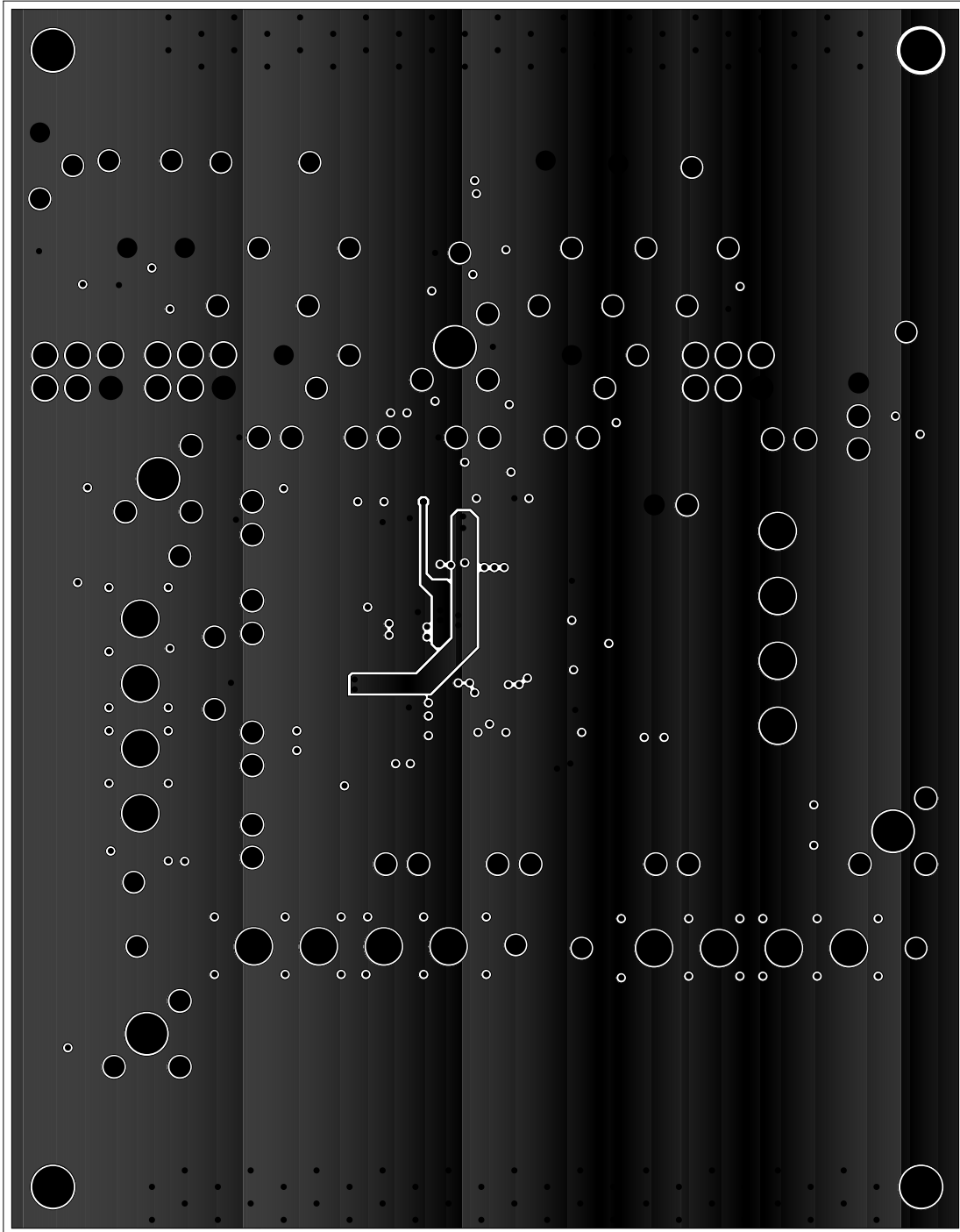

FIGURE 5. LAYER 4 GROUND

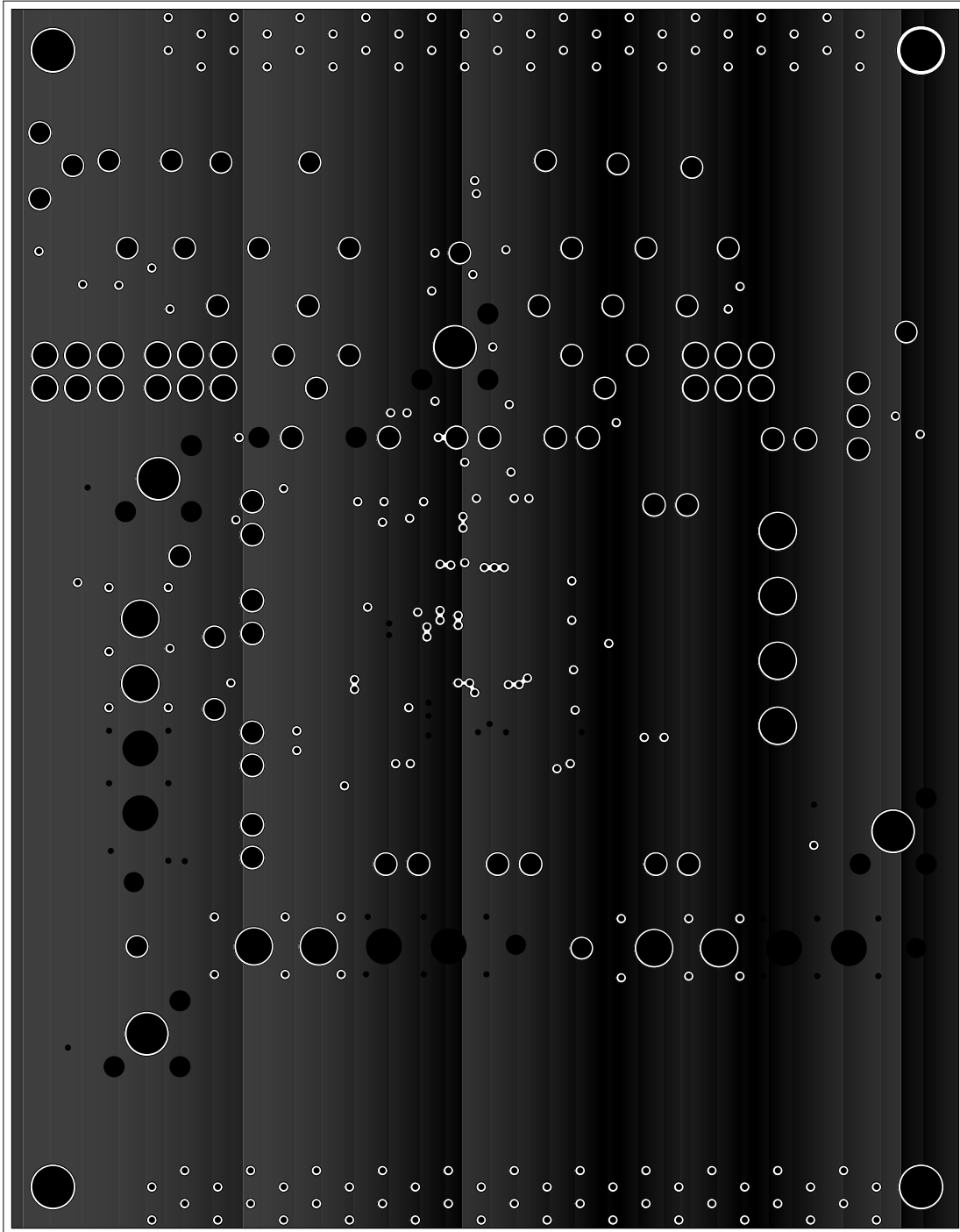

FIGURE 6. LAYER 5 GROUND

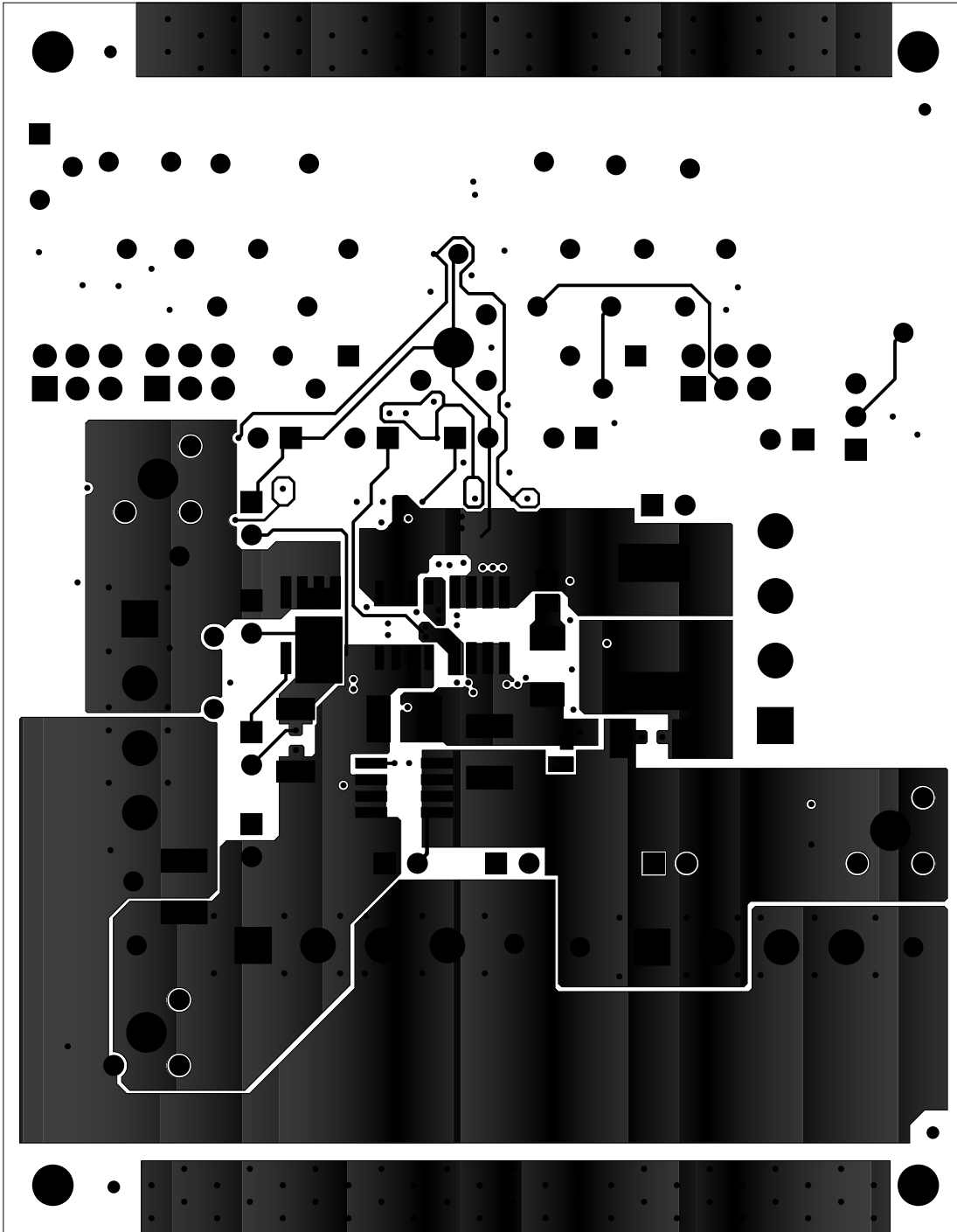

FIGURE 7. BOTTOM COPPER

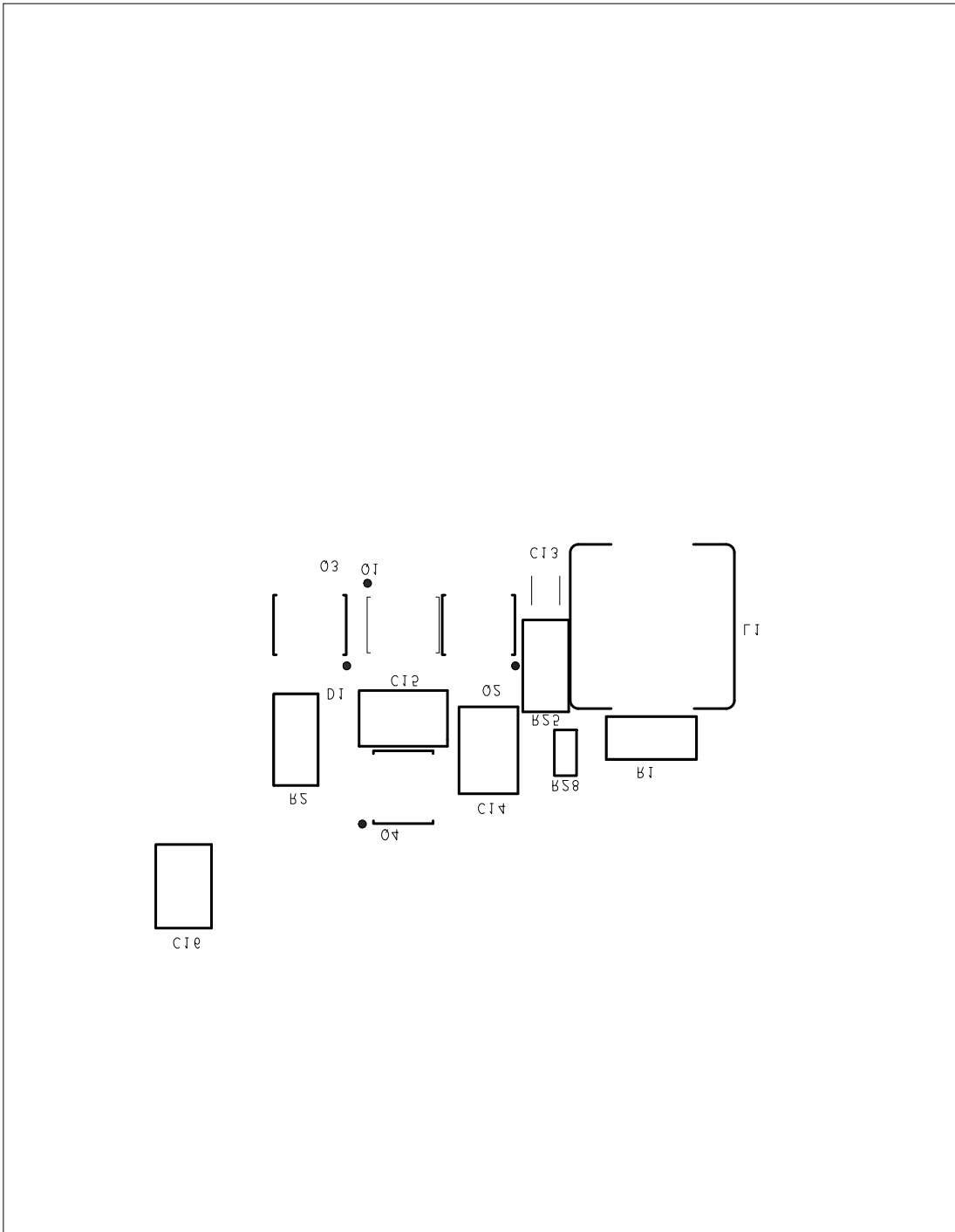

FIGURE 8. BOTTOM SILK

Notice

1. Descriptions of circuits, software and other related information in this document are provided only to illustrate the operation of semiconductor products and application examples. You are fully responsible for the incorporation or any other use of the circuits, software, and information in the design of your product or system. Renesas Electronics disclaims any and all liability for any losses and damages incurred by you or third parties arising from the use of these circuits, software, or information.
2. Renesas Electronics hereby expressly disclaims any warranties against and liability for infringement or any other claims involving patents, copyrights, or other intellectual property rights of third parties, by or arising from the use of Renesas Electronics products or technical information described in this document, including but not limited to, the product data, drawings, charts, programs, algorithms, and application examples.
3. No license, express, implied or otherwise, is granted hereby under any patents, copyrights or other intellectual property rights of Renesas Electronics or others.
4. You shall not alter, modify, copy, or reverse engineer any Renesas Electronics product, whether in whole or in part. Renesas Electronics disclaims any and all liability for any losses or damages incurred by you or third parties arising from such alteration, modification, copying or reverse engineering.
5. Renesas Electronics products are classified according to the following two quality grades: "Standard" and "High Quality". The intended applications for each Renesas Electronics product depends on the product's quality grade, as indicated below.
"Standard": Computers; office equipment; communications equipment; test and measurement equipment; audio and visual equipment; home electronic appliances; machine tools; personal electronic equipment; industrial robots; etc.
"High Quality": Transportation equipment (automobiles, trains, ships, etc.); traffic control (traffic lights); large-scale communication equipment; key financial terminal systems; safety control equipment; etc.
Unless expressly designated as a high reliability product or a product for harsh environments in a Renesas Electronics data sheet or other Renesas Electronics document, Renesas Electronics products are not intended or authorized for use in products or systems that may pose a direct threat to human life or bodily injury (artificial life support devices or systems; surgical implantations; etc.), or may cause serious property damage (space system; undersea repeaters; nuclear power control systems; aircraft control systems; key plant systems; military equipment; etc.). Renesas Electronics disclaims any and all liability for any damages or losses incurred by you or any third parties arising from the use of any Renesas Electronics product that is inconsistent with any Renesas Electronics data sheet, user's manual or other Renesas Electronics document.
6. When using Renesas Electronics products, refer to the latest product information (data sheets, user's manuals, application notes, "General Notes for Handling and Using Semiconductor Devices" in the reliability handbook, etc.), and ensure that usage conditions are within the ranges specified by Renesas Electronics with respect to maximum ratings, operating power supply voltage range, heat dissipation characteristics, installation, etc. Renesas Electronics disclaims any and all liability for any malfunctions, failure or accident arising out of the use of Renesas Electronics products outside of such specified ranges.
7. Although Renesas Electronics endeavors to improve the quality and reliability of Renesas Electronics products, semiconductor products have specific characteristics, such as the occurrence of failure at a certain rate and malfunctions under certain use conditions. Unless designated as a high reliability product or a product for harsh environments in a Renesas Electronics data sheet or other Renesas Electronics document, Renesas Electronics products are not subject to radiation resistance design. You are responsible for implementing safety measures to guard against the possibility of bodily injury, injury or damage caused by fire, and/or danger to the public in the event of a failure or malfunction of Renesas Electronics products, such as safety design for hardware and software, including but not limited to redundancy, fire control and malfunction prevention, appropriate treatment for aging degradation or any other appropriate measures. Because the evaluation of microcomputer software alone is very difficult and impractical, you are responsible for evaluating the safety of the final products or systems manufactured by you.
8. Please contact a Renesas Electronics sales office for details as to environmental matters such as the environmental compatibility of each Renesas Electronics product. You are responsible for carefully and sufficiently investigating applicable laws and regulations that regulate the inclusion or use of controlled substances, including without limitation, the EU RoHS Directive, and using Renesas Electronics products in compliance with all these applicable laws and regulations. Renesas Electronics disclaims any and all liability for damages or losses occurring as a result of your noncompliance with applicable laws and regulations.
9. Renesas Electronics products and technologies shall not be used for or incorporated into any products or systems whose manufacture, use, or sale is prohibited under any applicable domestic or foreign laws or regulations. You shall comply with any applicable export control laws and regulations promulgated and administered by the governments of any countries asserting jurisdiction over the parties or transactions.
10. It is the responsibility of the buyer or distributor of Renesas Electronics products, or any other party who distributes, disposes of, or otherwise sells or transfers the product to a third party, to notify such third party in advance of the contents and conditions set forth in this document.
11. This document shall not be reprinted, reproduced or duplicated in any form, in whole or in part, without prior written consent of Renesas Electronics.
12. Please contact a Renesas Electronics sales office if you have any questions regarding the information contained in this document or Renesas Electronics products.
(Note 1) "Renesas Electronics" as used in this document means Renesas Electronics Corporation and also includes its directly or indirectly controlled subsidiaries.
(Note 2) "Renesas Electronics product(s)" means any product developed or manufactured by or for Renesas Electronics.

(Rev.4.0-1 November 2017)



SALES OFFICES

Renesas Electronics Corporation

<http://www.renesas.com>

Refer to "<http://www.renesas.com/>" for the latest and detailed information.

Renesas Electronics America Inc.
1001 Murphy Ranch Road, Milpitas, CA 95035, U.S.A.
Tel: +1-408-432-8888, Fax: +1-408-434-5351

Renesas Electronics Canada Limited
9251 Yonge Street, Suite 8309 Richmond Hill, Ontario Canada L4C 9T3
Tel: +1-905-237-2004

Renesas Electronics Europe Limited
Dukes Meadow, Millboard Road, Bourne End, Buckinghamshire, SL8 5FH, U.K
Tel: +44-1628-651-700, Fax: +44-1628-651-804

Renesas Electronics Europe GmbH
Arcadiastrasse 10, 40472 Düsseldorf, Germany
Tel: +49-211-6503-0, Fax: +49-211-6503-1327

Renesas Electronics (China) Co., Ltd.
Room 1709 Quantum Plaza, No.27 ZhichunLu, Haidian District, Beijing, 100191 P. R. China
Tel: +86-10-8235-1155, Fax: +86-10-8235-7679

Renesas Electronics (Shanghai) Co., Ltd.
Unit 301, Tower A, Central Towers, 555 Langao Road, Putuo District, Shanghai, 200333 P. R. China
Tel: +86-21-2226-0888, Fax: +86-21-2226-0999

Renesas Electronics Hong Kong Limited
Unit 1601-1611, 16/F., Tower 2, Grand Century Place, 193 Prince Edward Road West, Mongkok, Kowloon, Hong Kong
Tel: +852-2265-6688, Fax: +852-2886-9022

Renesas Electronics Taiwan Co., Ltd.
13F, No. 363, Fu Shing North Road, Taipei 10543, Taiwan
Tel: +886-2-8175-9600, Fax: +886-2-8175-9670

Renesas Electronics Singapore Pte. Ltd.
80 Bendemeer Road, Unit #06-02 Hyflux Innovation Centre, Singapore 339949
Tel: +65-6213-0200, Fax: +65-6213-0300

Renesas Electronics Malaysia Sdn.Bhd.
Unit 1207, Block B, Menara Amcorp, Amcorp Trade Centre, No. 18, Jln Persiaran Barat, 46050 Petaling Jaya, Selangor Darul Ehsan, Malaysia
Tel: +60-3-7955-9390, Fax: +60-3-7955-9510

Renesas Electronics India Pvt. Ltd.
No.777C, 100 Feet Road, HAL 2nd Stage, Indiranagar, Bangalore 560 038, India
Tel: +91-80-67208700, Fax: +91-80-67208777

Renesas Electronics Korea Co., Ltd.
17F, KAMCO Yangjae Tower, 262, Gangnam-daero, Gangnam-gu, Seoul, 06265 Korea
Tel: +82-2-558-3737, Fax: +82-2-558-5338