

RTKA223011DE0010BU

Evaluation Board

The RAA223011 evaluation board (RTKA223011DE0010BU) is a high voltage buck converter that is designed to demonstrate a low-cost high performance non-isolated AC/DC conversion from an universal input of 85V_{AC} to 265V_{AC}, to a 12V output with the output current up to 300mA.

The RTKA223011DE0010BU has built-in overcurrent, short-circuit, input brownout, and over-temperature protection. The board is designed on a single side PCB with a single diode half-wave input rectification. It is pre-compliant with conducted and radiated EMI requirements by EN55022/CISPR 22.

The RTKA223011DE0010BU comes with a RAA223011 in 8 Ld SOIC package.

Key Features

- Universal input
- Single-side PCB with low cost external components
- EMI compliance for EN55022/CISPR22
- Standby power less than 10mW
- No audible noise

Specifications

This board is optimized for the following operating conditions:

- Input voltage: 85V_{AC} ~ 265V_{AC}
- Output voltage: 12V_{DC}
- Output current: 300mA max (at 230V_{AC} or higher)
- Output power: 3.6W
- Efficiency: >73% at 100% load; 80% at 50% load
- No-load power: 7mW at 120V_{AC}; 9.6mW at 230V_{AC}
- Load regulation: -2.4%, load range 10% to 100%
- Operating temperature: -45°C~65°C
- Board dimension: 40mm x 60mm

Ordering Information

Part Number	Description
RTKA223011DE0010BU	RAA223011 evaluation Board for 8 Ld SOIC option

Related Literature

For a full list of related documents, visit our website:

- [RAA223011](#) device page

1. Circuit Description

The RTKA223011DE0010BU is buck regulator implemented with a high-side float-switching topology, with switching frequency up to 33kHz. Its input has D1, D7 as a low-cost half-wave rectification (with an optional full-bridge rectifier foot-print). FR is a 1W fusible resistor providing input overcurrent protection and inrush current limiting. It also helps to absorb the input line surge energy together with DC buffer caps, C1 and C2.

C1, L1, and C2 consists of the input filter that provides the energy buffer after rectification and reduces conducted EMI noises to the input. L2, D2, and C_{OUT} is the buck converter. RFB1, RFB2, CFB2, and CFB1 provide the output feedback signal to the IC. D4 and R2 provide V_{CC} biasing current after startup, to increase the efficiency. They can be optional for low-cost, low-power applications. C_{VCC} is the IC supply capacitor.

1.1 Recommended Equipment

- AC Power supply capable of generating AC voltage from 85V_{AC} to 265V_{AC} at 60Hz/50Hz, with at least 100mA output current capability.
- Load resistor box with adjustable value of 40Ω and up, or an electronics load than can emulate a resistor load or current load up to 300mA.
- Multimeters to measure the output voltage and current.
- Power meter to measure the AC input power.

1.2 Quick Start Guide

1. Program the AC power supply with a voltage between 85V_{AC} and 265V_{AC} at the corresponding frequency of 60Hz or 50Hz.
2. While the AC power supply is off, connect the output cables of the AC power supply to the L and N terminals of the RTKA223011DE0010BU. An optional power meter can be added in between the AC power supply output and input of the board.
3. Connect the load to the output terminals VOUT and GND.
4. Connect a voltage meter to VOUT and GND and connect a current meter between board outputs and the load.
5. Turn on AC power supply.

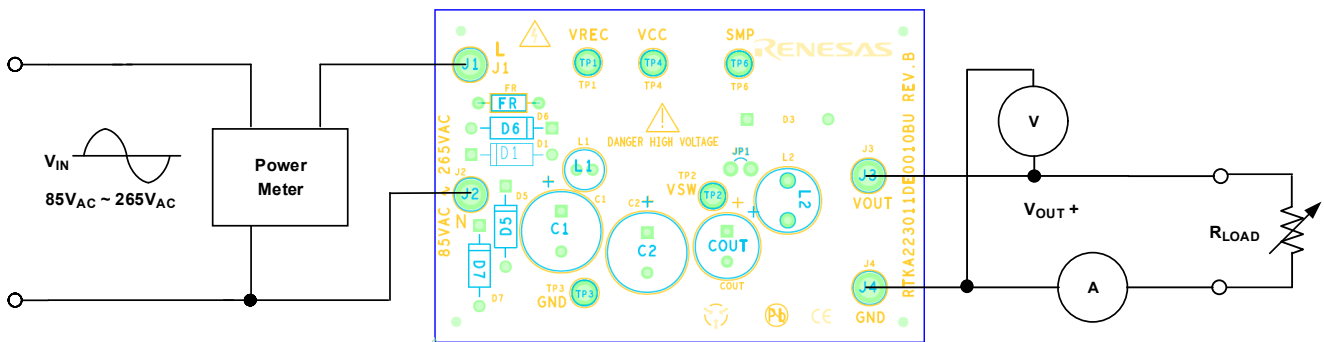

Figure 1. RTKA223011DE0010BU Connection Diagram

2. Board Design

2.1 PCB Guidelines

For detailed PCB guidelines, see the RAA223011 datasheet.

2.2 RTKA223011DE0010BU Evaluation board



Figure 2. RTKA223011DE0010BU Evaluation Board (Top)

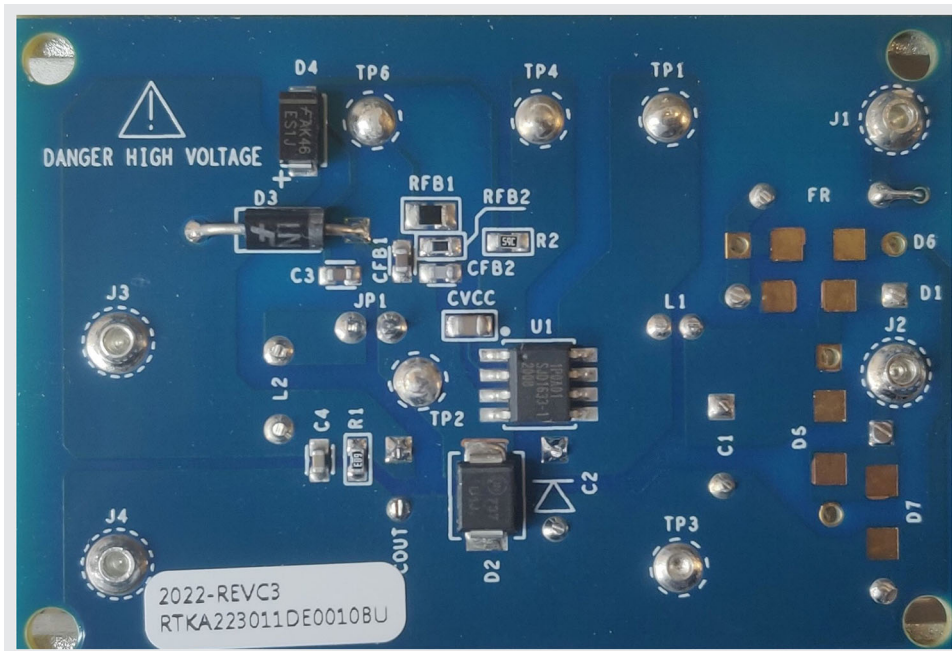

Figure 3. RTKA223011DE0010BU Evaluation Board (Bottom)

2.3 RTKA223011DE0010BU Circuit Schematic

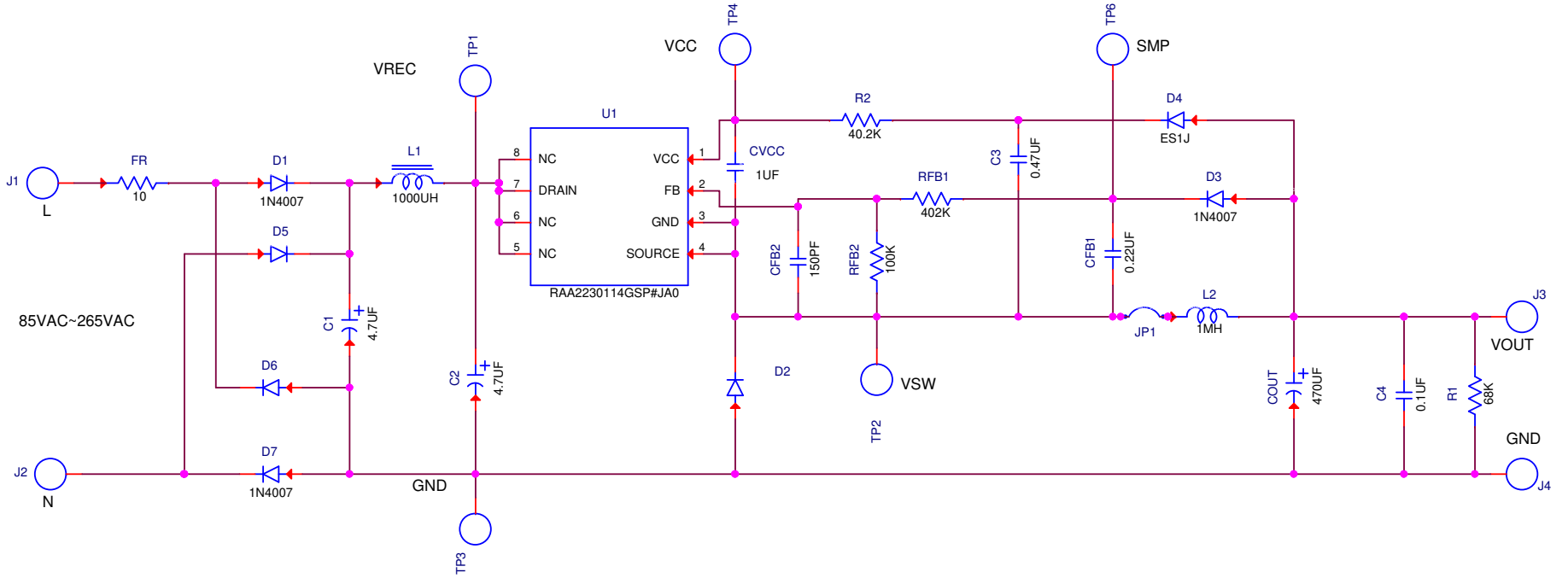

Figure 4. RTKA223011DE0010BU Schematic

2.4 Bill of Materials

QTY	Reference Designator	Description	Manufacturer	Part Number
1	COUT	CAP ALUM 470 μ F 20% 16V Radial	Rubycon	16ZLH470MEFCT78X11.5
3	D1, D3, D7	Generic Diode, 1kV, 1A, DO41	MCC	1N4007
2	C3, C4	Multilayer CAP, 0.47 μ F, 16V, 10%, 0603	TDK	C1608X7R1C474K
1	FR	Miniature Metal Film Resistor, 10 Ω , 1W, 1%, Axial	Yageo	FKN1WSJR-52-10R
1	D4	1A 600V Fast Rectifier Diode, SMA	Fairchild	ES1J
2	C1, C2	CAP ALUM 4.7 μ F 20% 400V Radial	Kemet	ESG475M400AH2AA
1	CFB2	Ceramic Chip Cap, 150pF, 5%, 50V, 0603	Murata	GRM1885C1H151JA01D
1	CFB1	Ceramic Chip Cap, 0.22 μ F, 10%, X7R, 25V, 0603	Murata	GRM188Z71E224KE43
1	CVCC	Multilayer Cap, 1 μ F, 10V, 10%, X7R, 0603	Generic	GRM188R71A105KA61D
1	RFB2	Thick Film Chip Resistor, 100k, 1%, 1/10W, 0603	Generic	
1	R2	Thick Film Chip Resistor, 40.2k, 1%, 1/10W, 0603	Generic	
1	R1	Thick Film Chip Resistor, 68k, 1%, 1/10W, 0603	Generic	
1	RFB1	Thick Film Chip Resistor, 402k, 1%, 1/8W, 0805	Generic	
1	D2	Ultrafast Power Rectifier, 600V, 2A, SMB	On Semiconductors	MURS160T3
1	U1	700V, 1W AC/DC Buck Regulator, SO8	Renesas	RAA2230114GSP#JA0
1	L2	Fixed Inductor, 1MH, 15%, 470MA, 1.915 Ω , TH	Sumida	RCH8011NP-102L
1	L1	RLB Series Radial Lead Inductor, 1mH, 10%, 100mA, 11.5 Ω , TH	Bourns	RLB0608-102KL

2.5 Board Layout

To download our design files, visit our [website](#).

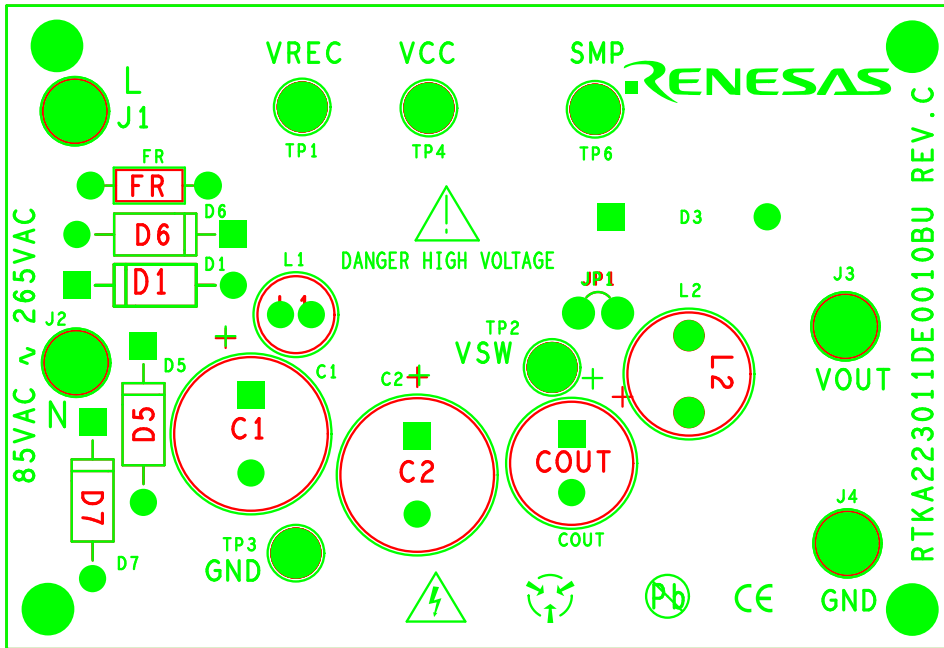

Figure 5. Top Layer

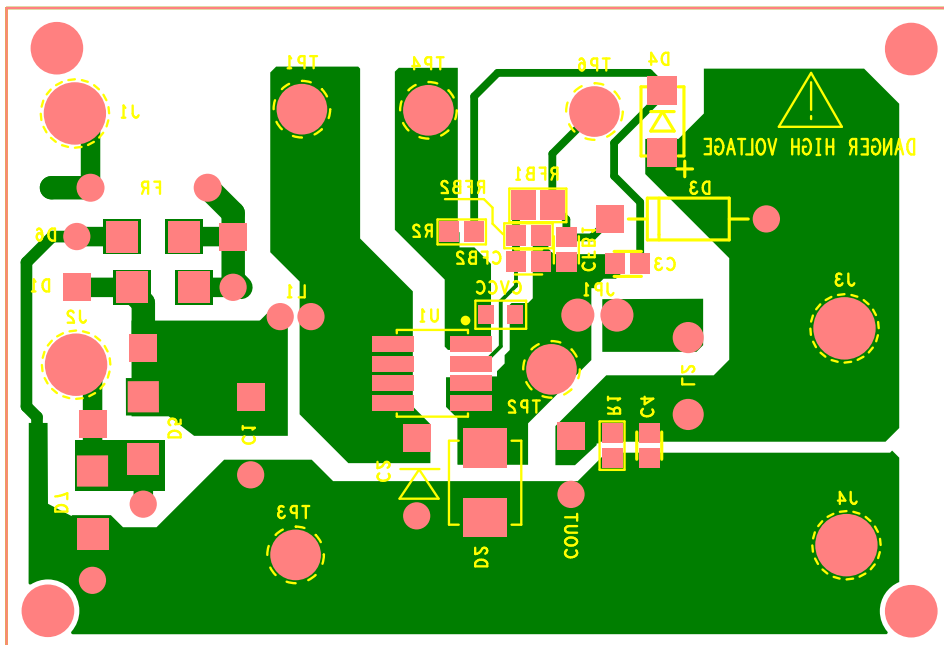

Figure 6. Bottom Layer

3. Typical Performance Curves

$V_{in} = 85V_{AC} \sim 265V_{AC}$, $V_{OUT} = 12V$, $I_{OUT} = 300mA$ (maximum), $T_A = +25^{\circ}C$

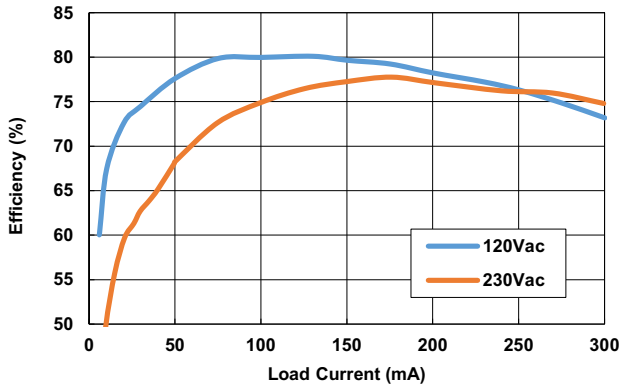

Figure 7. Efficiency Overload Current, $V_{OUT} = 12V$

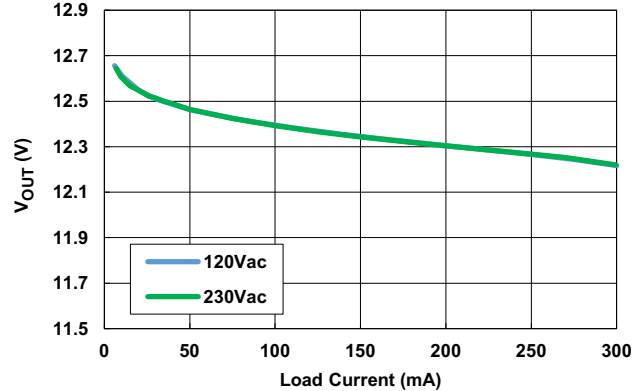

Figure 8. Load Regulation

Table 1. Typical No-Load Power Consumption

Power Supply	Standby Power	Energy Star
120V _{AC} /60Hz	7mW	300mW
230V _{AC} /50Hz	9.5mW	300mW

3.1 EMI Test Results

RTKA223011DE0010BU is compliant to the conducted and radiated EMI requirements of FCC Part15 and CISPR22.

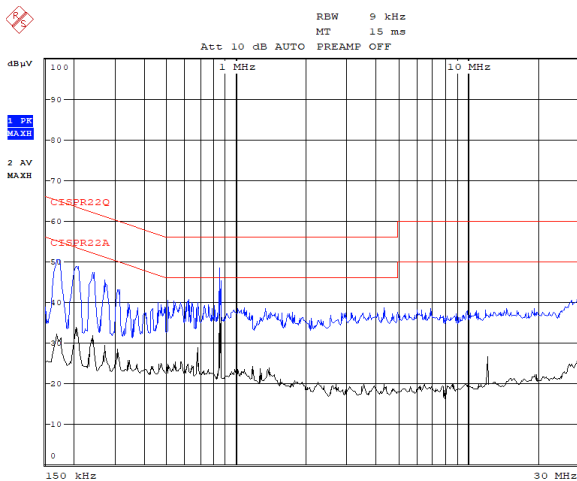

Figure 9. Line, 120V_{AC}

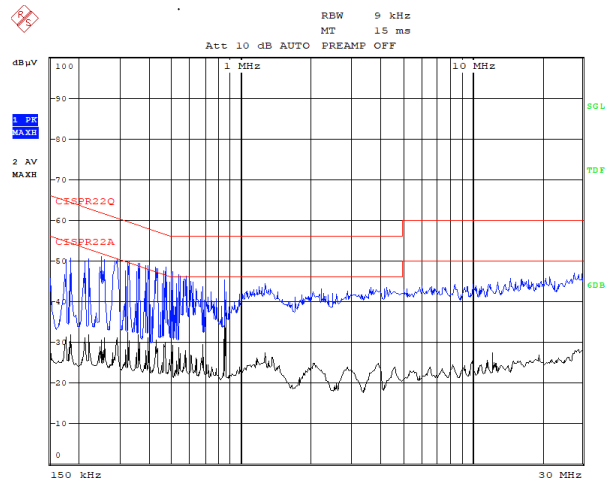

Figure 10. Line, 230V_{AC}

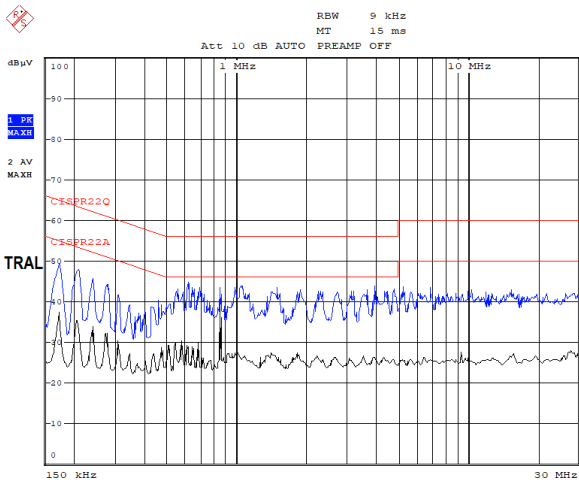

Figure 11. Neutral, 120V_{AC}

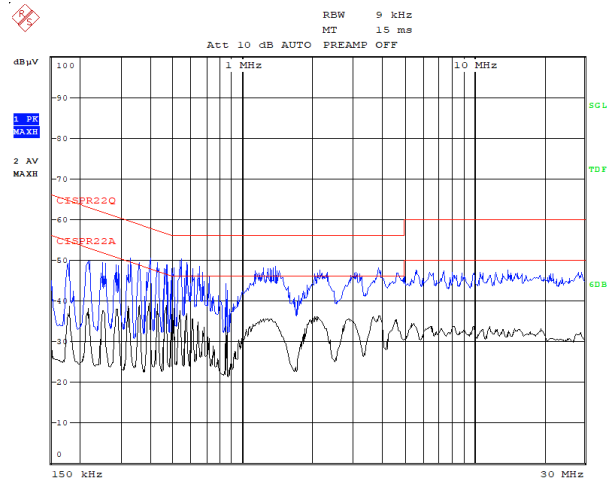

Figure 12. Neutral, 230V_{AC}

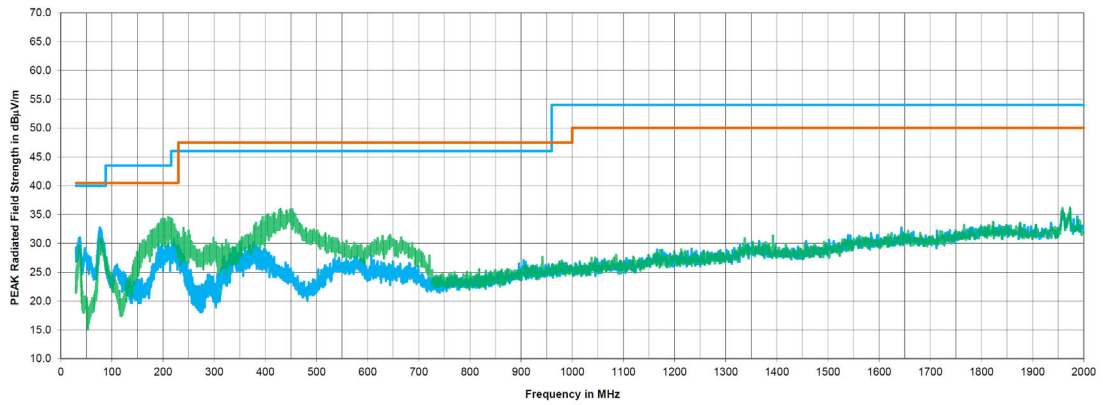

Figure 13. FCC Part15/CISPR22 Class B Radiated Emissions at 3 Meters, 120V_{AC}, 60Hz (Peak Detector)

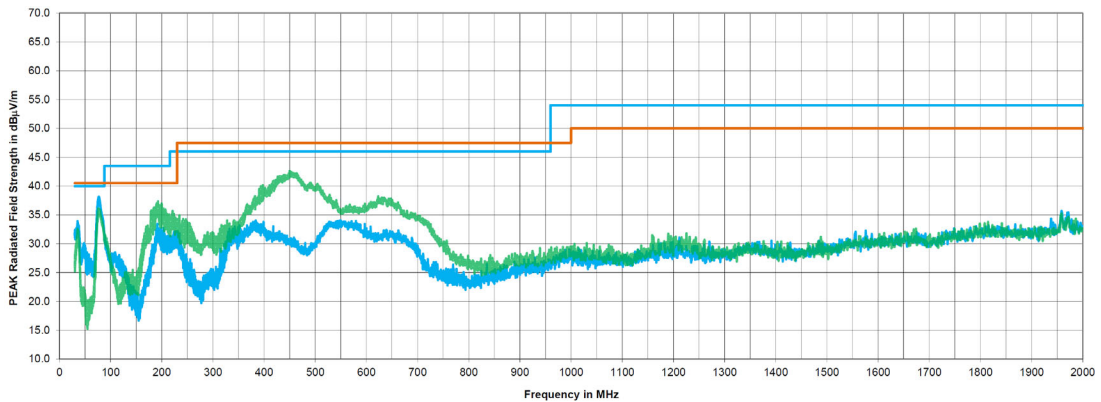

Figure 14. FCC Part15/CISPR22 Class B Radiated Emissions at 3 Meters, 230V_{AC}, 50Hz (Peak Detector)

4. Revision History

Rev.	Date	Description
1.00	Jan.27.21	Initial release

IMPORTANT NOTICE AND DISCLAIMER

RENESAS ELECTRONICS CORPORATION AND ITS SUBSIDIARIES (“RENESAS”) PROVIDES TECHNICAL SPECIFICATIONS AND RELIABILITY DATA (INCLUDING DATASHEETS), DESIGN RESOURCES (INCLUDING REFERENCE DESIGNS), APPLICATION OR OTHER DESIGN ADVICE, WEB TOOLS, SAFETY INFORMATION, AND OTHER RESOURCES “AS IS” AND WITH ALL FAULTS, AND DISCLAIMS ALL WARRANTIES, EXPRESS OR IMPLIED, INCLUDING, WITHOUT LIMITATION, ANY IMPLIED WARRANTIES OF MERCHANTABILITY, FITNESS FOR A PARTICULAR PURPOSE, OR NON-INFRINGEMENT OF THIRD PARTY INTELLECTUAL PROPERTY RIGHTS.

These resources are intended for developers skilled in the art designing with Renesas products. You are solely responsible for (1) selecting the appropriate products for your application, (2) designing, validating, and testing your application, and (3) ensuring your application meets applicable standards, and any other safety, security, or other requirements. These resources are subject to change without notice. Renesas grants you permission to use these resources only for development of an application that uses Renesas products. Other reproduction or use of these resources is strictly prohibited. No license is granted to any other Renesas intellectual property or to any third party intellectual property. Renesas disclaims responsibility for, and you will fully indemnify Renesas and its representatives against, any claims, damages, costs, losses, or liabilities arising out of your use of these resources. Renesas' products are provided only subject to Renesas' Terms and Conditions of Sale or other applicable terms agreed to in writing. No use of any Renesas resources expands or otherwise alters any applicable warranties or warranty disclaimers for these products.

(Rev.1.0 Mar 2020)

Corporate Headquarters

TOYOSU FORESIA, 3-2-24 Toyosu,
Koto-ku, Tokyo 135-0061, Japan
www.renesas.com

Contact Information

For further information on a product, technology, the most up-to-date version of a document, or your nearest sales office, please visit:
www.renesas.com/contact/

Trademarks

Renesas and the Renesas logo are trademarks of Renesas Electronics Corporation. All trademarks and registered trademarks are the property of their respective owners.