

## Introduction

The evaluation board is designed to help the customer evaluate the following devices.

Product Number	Description
9FGL0841	8-output PCIe Clock Generator 3.3V Z <sub>OUT</sub> = 100Ω
9FGV0841	8-output PCIe Clock Generator 1.8V Z <sub>OUT</sub> = 100Ω
9FGU0841	8-output PCIe Clock Generator 1.5V Z <sub>OUT</sub> = 100Ω
9FGL0851	8-output PCIe Clock Generator 3.3V Z <sub>OUT</sub> = 85Ω

The devices are programmable through SMBus interface. This user guide details the board set and connection as well as the companion GUI installation for communicating to the device. The board has a self contained USB to SMBus interface.

## Board Overview

Use the following diagram and table to identify: power supply jacks, USB connector, input and output frequency SMA connectors.

**Figure 1. Evaluation Board Overview for the 9FGL0841–100Ω Differential**

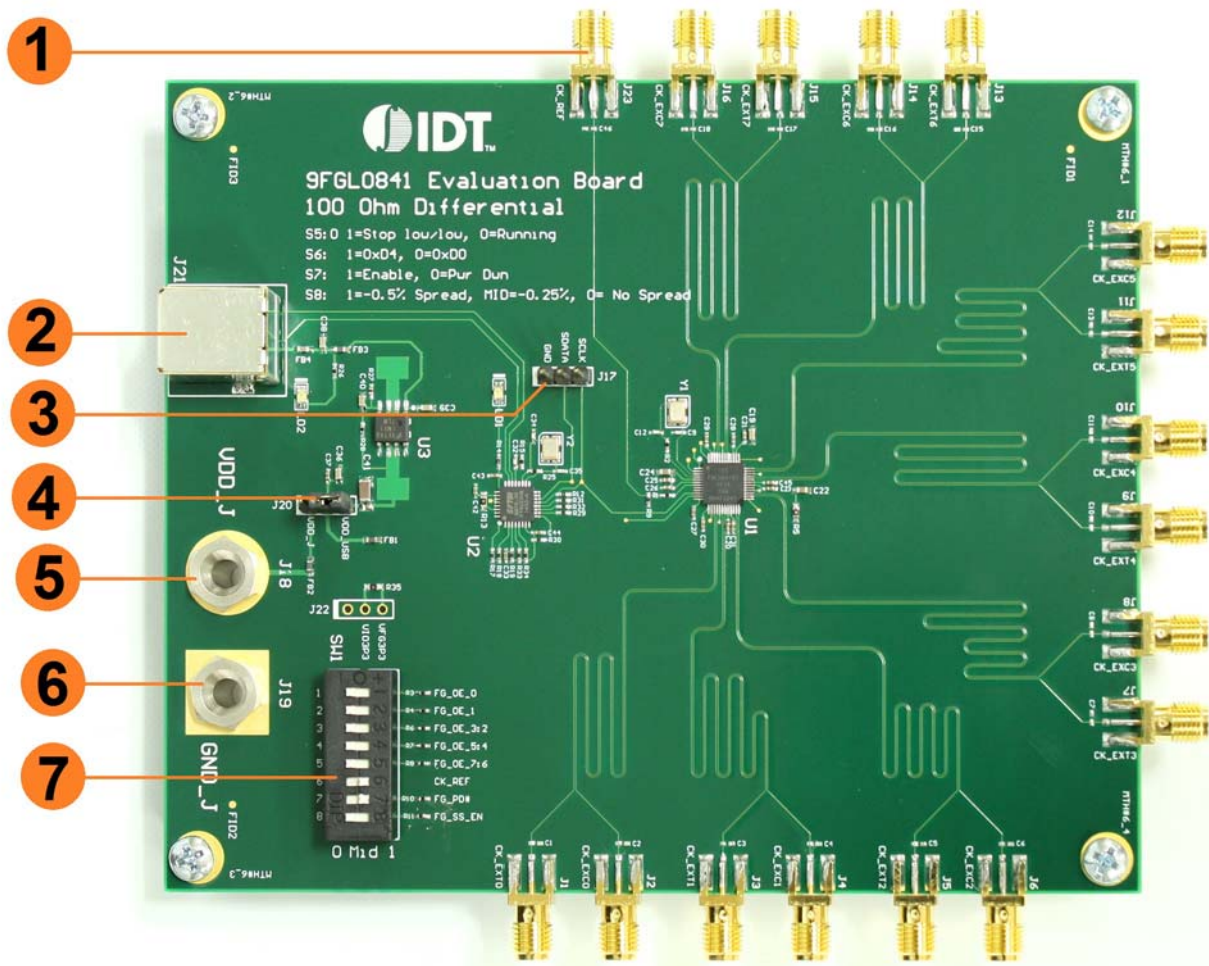

**Table 1: EBV Pins and Functions**

Item	Name	On-Board Connector Label	Function
1	Outputs 0-7	J1-J16	Low power HCSL outputs
2	USB Interface	J21	Used for connection with a PC and for interaction with the IDT PCIe GUI
3	I <sup>2</sup> C Connection Port	J17	Used for an external I <sup>2</sup> C connection
4	Input Voltage Selector	J20	Used for selection of USB power supply or external power supply from J18
5	Power Supply Jack	J18	Input power supply
6	Ground Jack	J19	Used for GND
7	DIP Switch	SW1	S1: FG_OE_0 S2: FG_OE_1 S3: FG_OE_3:2 S4: FG_OE_5:4 S5: FG_OE_7:6 S6: CK_REF S7: FG_PD# S8: FG_SS_EN

### Board Power Supply

By default, the board is powered from the USB connector.

**Bench Power Supply** – An external power supply can be used by connecting jumper J20 between the central pin and the VDD\_J position. VDD\_J must then be connected to the appropriate power supply for the device ordered.

- 9FGL= 3.3V
- 9FGV= 1.8V
- 9FGU = 1.5V

**USB Power Supply** – When the board is connected to a PC through a USB cable, on-board voltage regulators can supply the appropriate voltage to the clock chip. USB power is selected by connecting J20 between the central pin and the VDD\_USB pin.

Depending on the evaluation board ordered, the R22 resistor will be pre-populated as follows:

- For VDD = 1.5V: R22 = 49.9Ω
- For VDD = 1.8V: R22 = 107Ω
- For VDD = 3.3V: R22 = 402Ω

**Figure 2. Connecting the jumper to VDD\_J or VDD\_USB. Default is to power by USB**



## Connecting the Board

The board is connected to a PC through a USB connector for configuring the device, as shown in Figure 3 below. The USB interface will also provide +5V power supply to the board, from which on-board voltage regulators generate various voltages for the core as well as for each output. LED LD2 will light up to indicate a successful connection

The board can also be powered by a bench power supply by connecting one banana jack J18 for the core voltage, respectively. Please see board power supply section for details.

**Figure 3. Connecting the Board with USB Port for Communications with Software GUI**

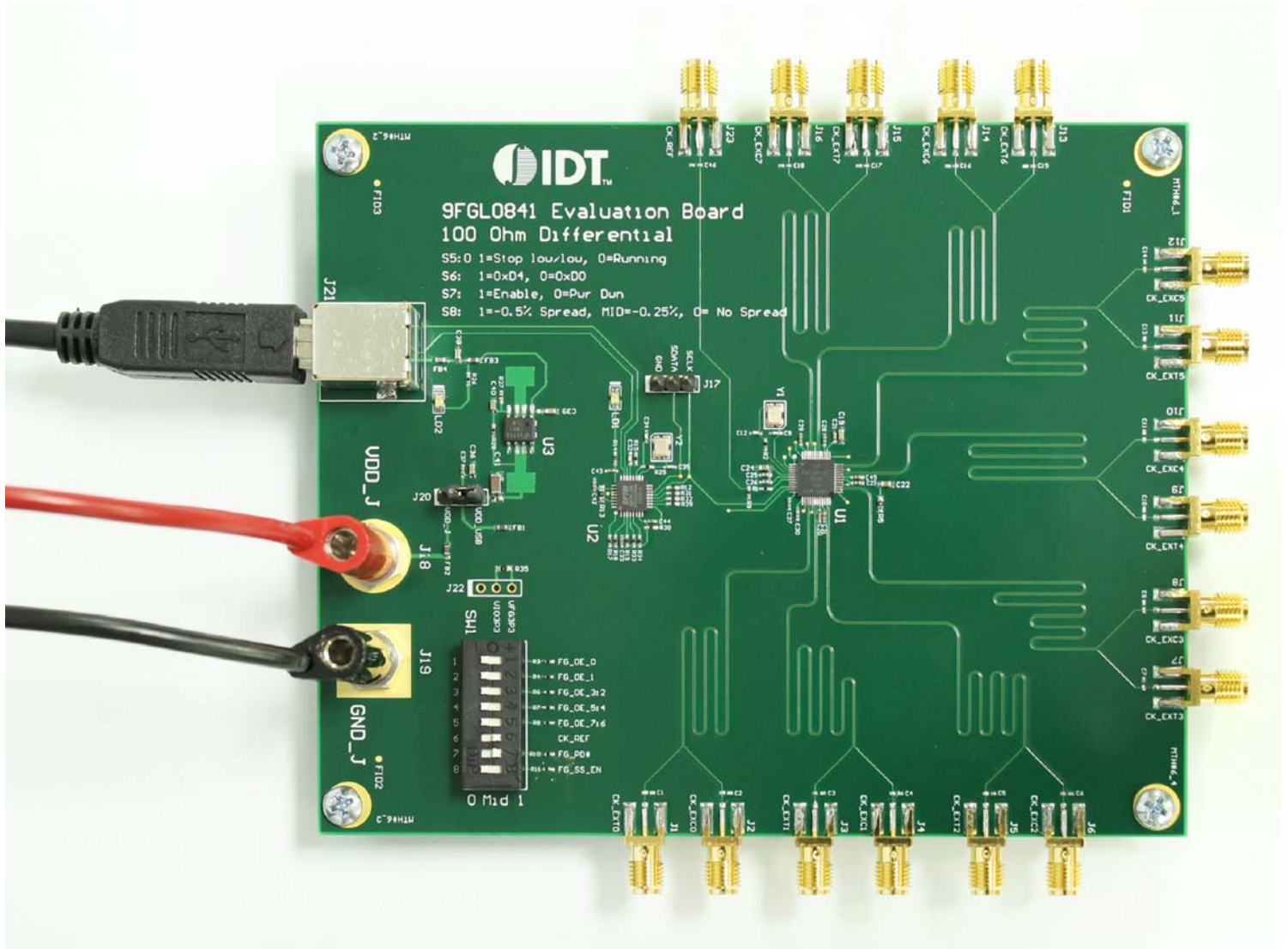

## PCIe GUI Installation Setup

First the GUI requires a driver for the FTDI IC that interface between the USB and SMBus interfaces.

1. Unzip the files from the PCIe GUI archive on your PC. PCIe GUI zip file can be found at <http://www.idt.com/document/swr/software-pcie-evaluation-kits>
2. Extract the FTDI windows driver from the PCIe GUI archive or go to the FTDI website to download the latest driver and install on your computer.

Note: For non-Windows operating systems, download the respective driver from the FTDI website.

<http://www.ftdichip.com/Drivers/D2XX.htm>

Currently Supported D2XX Drivers:

Operating System	Release Date	Processor Architecture							Comments
		x86 (32-bit)	x64 (64-bit)	PPC	ARM	MIPSII	MIPSIV	SH4	
Windows*	2014-09-29	Available as <a href="#">setup executable</a> Contact <a href="mailto:support1@ftdichip.com">support1@ftdichip.com</a> if looking to create customised drivers		-	-	-	-	-	2.12.00 WHQL Certified Available as setup executable <a href="#">Release Notes</a>
Windows RT	2014-07-04	<a href="#">1.0.2</a>	-	-	<a href="#">1.0.2</a>	-	-	-	A guide to support the driver (AN_271) is available <a href="#">here</a>
Linux	2012-06-29	1.1.12	1.1.12	-	1.1.12 Suitable for Raspberry Pi	-	-	-	<a href="#">ReadMe</a>
Mac OS X	2012-10-30	1.2.2	1.2.2	1.2.2	-	-	-	-	Requires Mac OS X 10.4 (Tiger) or later <a href="#">ReadMe</a>
Windows CE 4.2-5.2**	2014-22-04	1.0.1.10	-	-	1.0.1.10	1.0.1.6	1.0.1.6	1.0.1.6	
Windows CE 6.0/7.0	2014-22-04	1.0.1.10 CE 6.0 CAT CE 7.0 CAT	-	-	1.0.1.10 CE 6.0 CAT CE 7.0 CAT	1.0.1.6	1.0.1.6	1.0.1.6	For use of the CAT files supplied for ARM and x86 builds refer to <a href="#">AN_319</a>

3. Double click the executable file to install the driver.

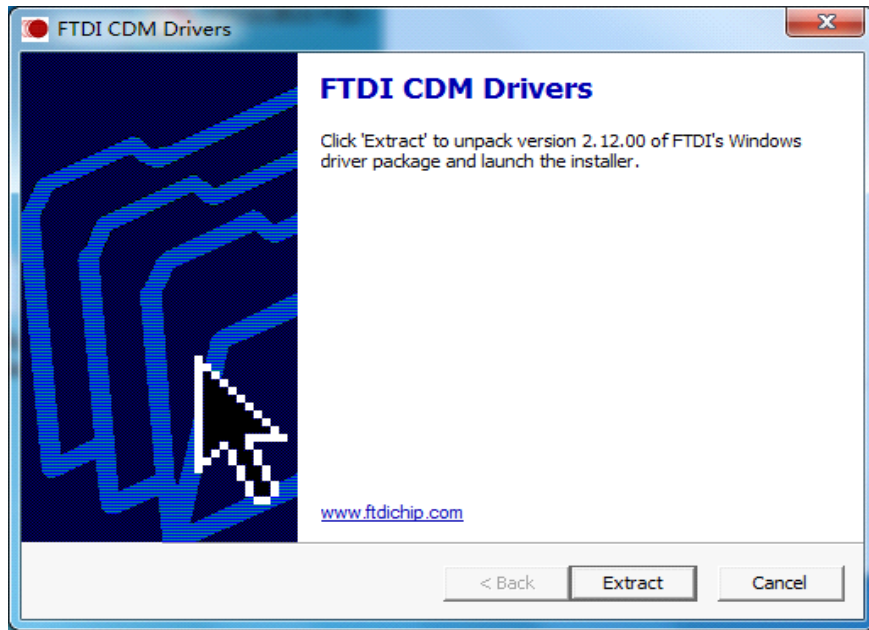

4. Connect the board to the computer using the supplied USB cable. Double click on the Application file ClockCtl.exe to start the PCIe GUI support application.

If no board is connected, the following message will appear:



5. PCIe Clock/Buffer GUI main window:

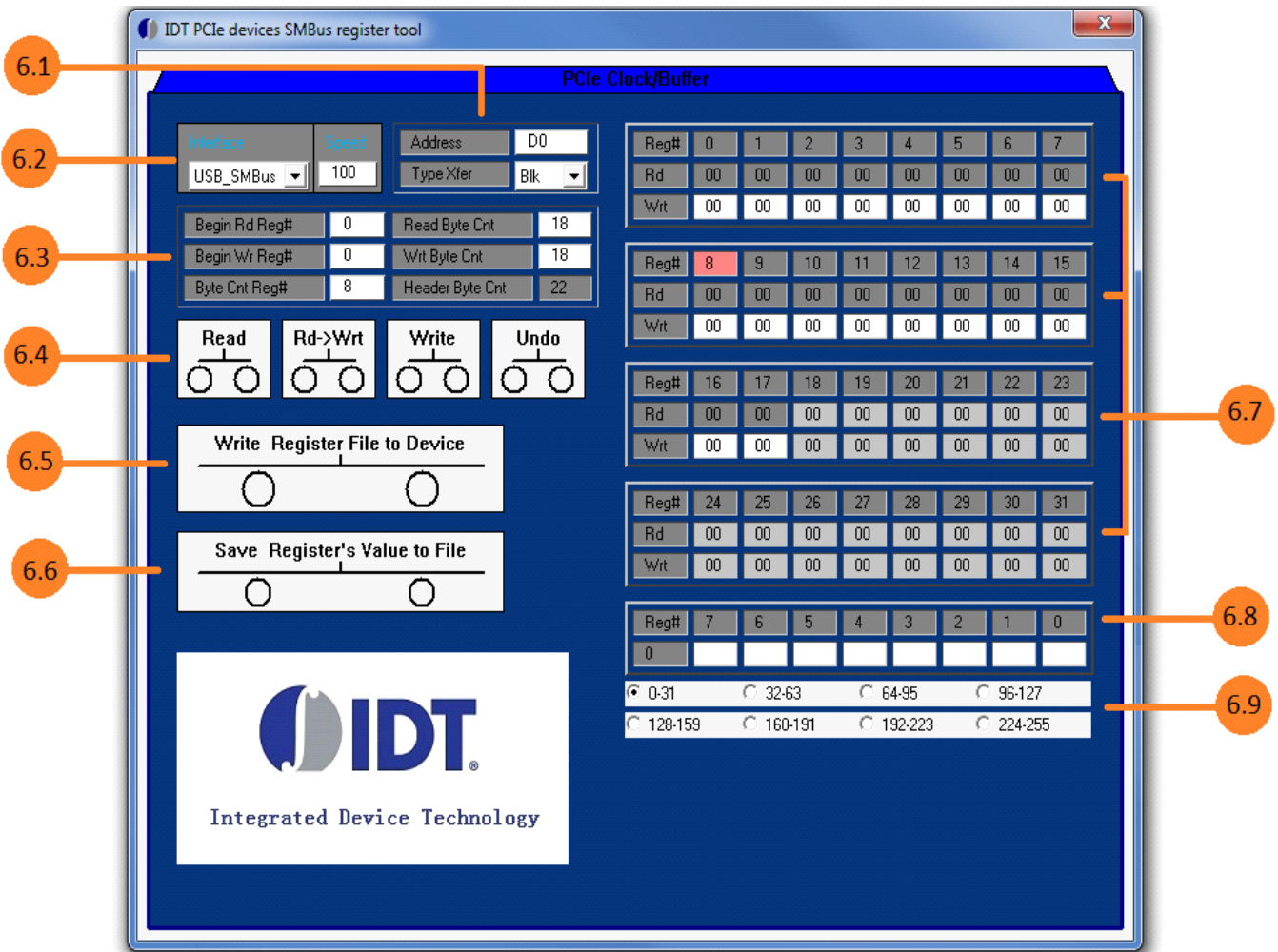

6.1 Slave address

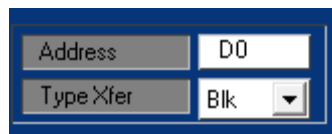

The address is 7-bit slave address combined with 0 in LSB, for example if the slave address is 1101000, D0 should be filled.

Type Xfer

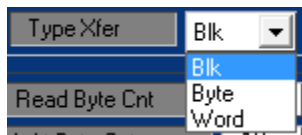

6.2 SMBus interface



Only USB to SMBus is available, you can change the SMBus speed, but please note that the speed of SMBus is from 10KHz to 100KHz.

### 6.3 Begin Reg# and Byte Count

Begin Rd Reg#	0	Read Byte Cnt	18
Begin Wr Reg#	0	Wrt Byte Cnt	18
Byte Cnt Reg#	8	Header Byte Cnt	22

- Begin Rd Reg# is the begin register address of read operation.
- Read Byte Cnt is the byte count of read operation.
- Begin Wr Reg# is the begin register address of write operation.
- Wrt Byte Cnt is the byte count of write operation.

### 6.4 Register Operations

#### 6.4.1 Read Operation

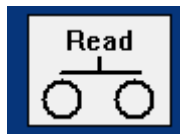

Pressing the read button will initiate a read. If a chipset is used for reading, the byte count is determined by the value in the device byte count register. The byte count cannot be larger than 32 dec. Non-read locations in the read grid will be grayed out.

Rd->Wrt Operation

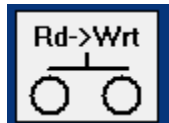

Pressing the Rd>Wrt button will copy all of the read cells to the write cell contents

#### 6.4.2 Write Operation

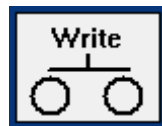

Write button operation. If the chipset is used for writing, the byte count is controlled by the value in the GUI panel byte count register. Registers that will not be written because of the starting location setting and byte count will be grayed out.

The hex values for data to be written will be in a cell with a white background.

#### 6.4.3 Undo Operation

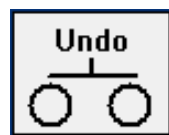

Reverts the last performed operation.

6.5 Write from file

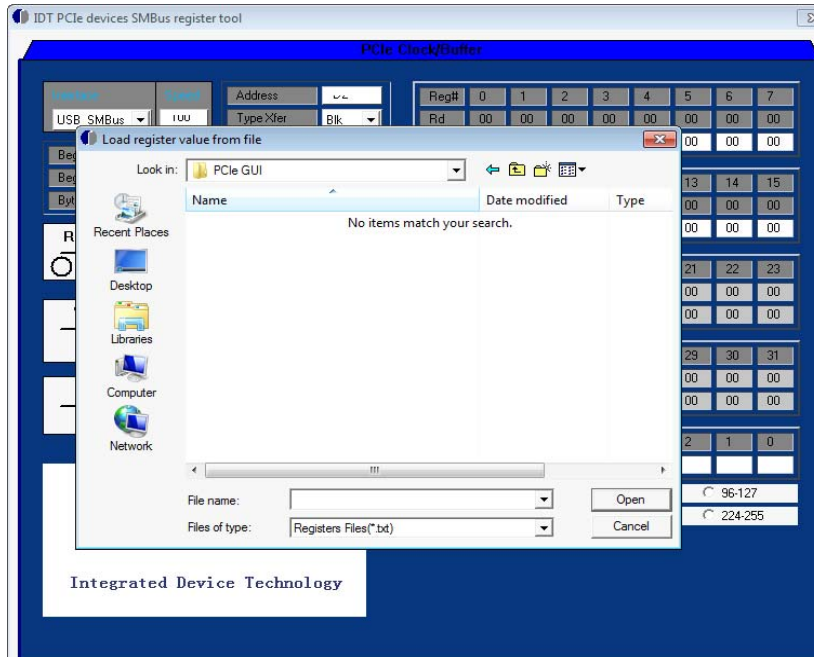
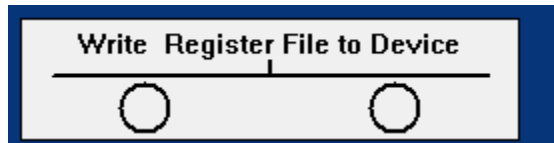

To Write register from file, click "Write Register File to Device" button, it will pop up a window, select the file path and the file name, then click "Open", the GUI will read all registers' value from the file then down load to device.

6.6 Save registers to file

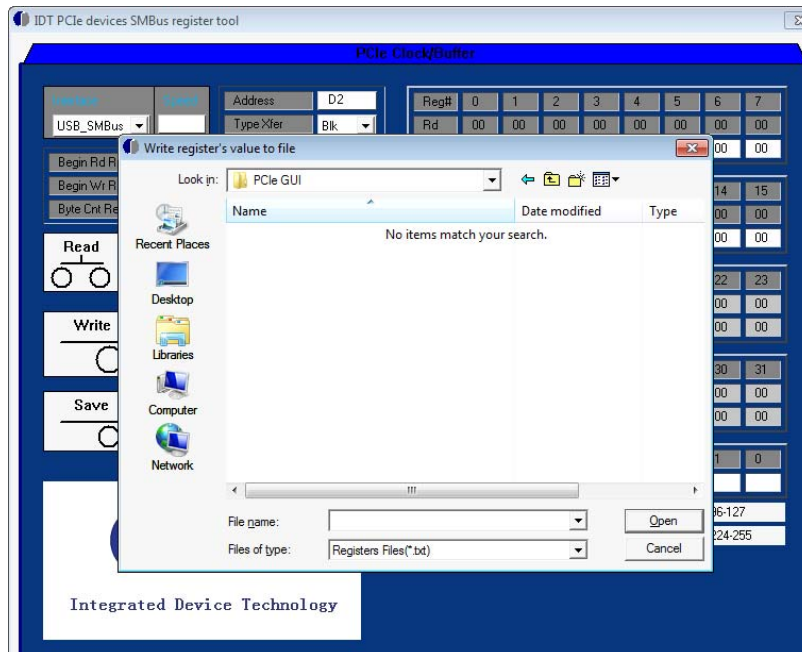
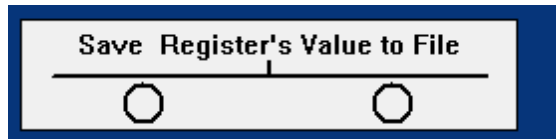

To save registers to file, click "Save Registers Value to File" button, it will pop up a window, select the file path and fill the file name, then click "Save", the GUI will dump all registers' value then save to the file.

6.7 Register Value field

Reg#	0	1	2	3	4	5	6	7
Rd	00	00	00	00	00	00	00	00
Wrt	00	00	00	00	00	00	00	00

The hexadecimal read information will be grayed background reminding the user that it cannot be altered. Hexadecimal write information will be on a white background.

6.8 Binary display table

Reg#	7	6	5	4	3	2	1	0
0								

Clicking on a Reg# Rd window will display the binary decode of the hex value. This may be used for entering binary data instead of hexadecimal data.

6.9 Byte count range switch

<input checked="" type="radio"/> 0-31	<input type="radio"/> 32-63	<input type="radio"/> 64-95	<input type="radio"/> 96-127
<input type="radio"/> 128-159	<input type="radio"/> 160-191	<input type="radio"/> 192-223	<input type="radio"/> 224-255

Since there is 32-byte value could be display at the time, if the byte count exceed 32, need to switch the range.

6. Read/Write Operations

Read

Pressing the read button will initiate a read. If a chip set is used for reading, the byte count is determined by the value in the device byte count register. The byte count cannot be larger than 32 dec. Non-read locations in the read grid will be grayed out.

Rd->Wrt

Pressing the Rd>Wrt button will copy all of the read cells to the write cell contents.

Write

Write button operation. If the chip set is used for writing, the byte count is controlled by the value in the GUI panel byte count register. Registers that will not be written because of the starting location setting and byte count will be grayed out.

The hex values for data to be written will be in a cell with a white background.



7. Read/Write from file

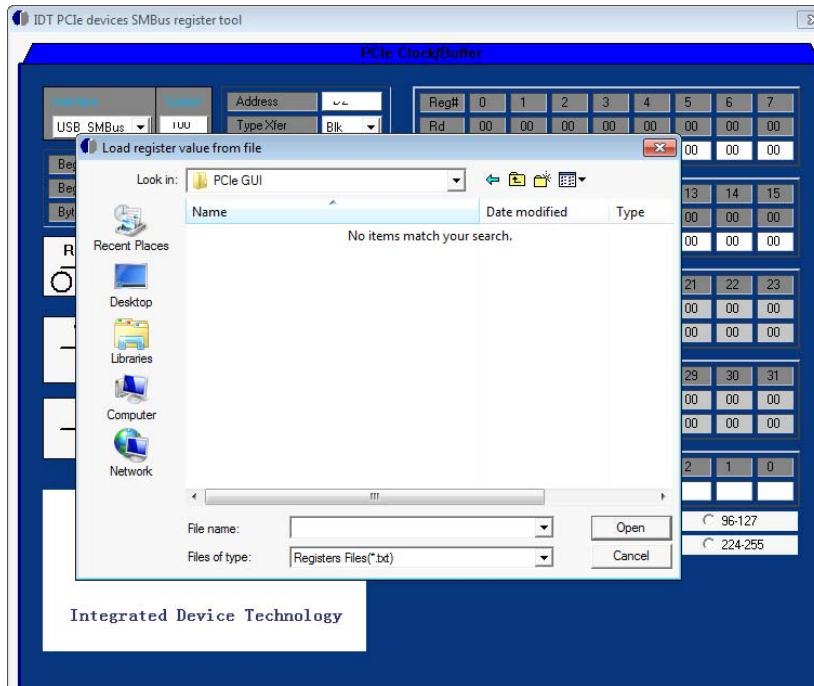

To Write register from file, click "Write Register File to Device" button, it will pop up a window, select the file path and the file name, then click "Open", the GUI will read all registers' value from the file then down load to device.

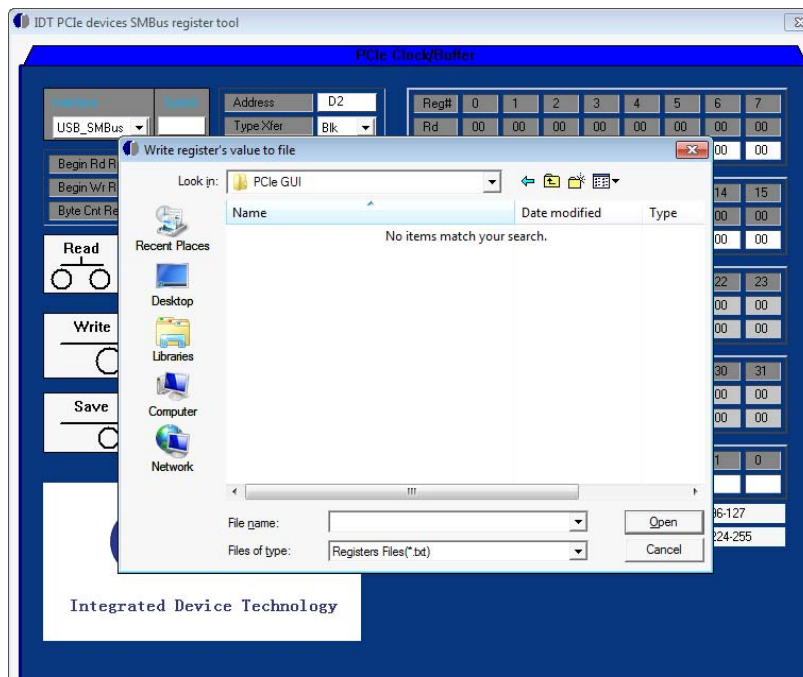

To save registers to file, click "Save Registers Value to File" button, it will pop up a window, select the file path and fill the file name, then click "Save", the GUI will dump all registers' value then save to the file.

**Note:** LED LD1 will light up on every SDATA operation.

# Board Schematics

Figure 4. 9FGL0841 Schematics

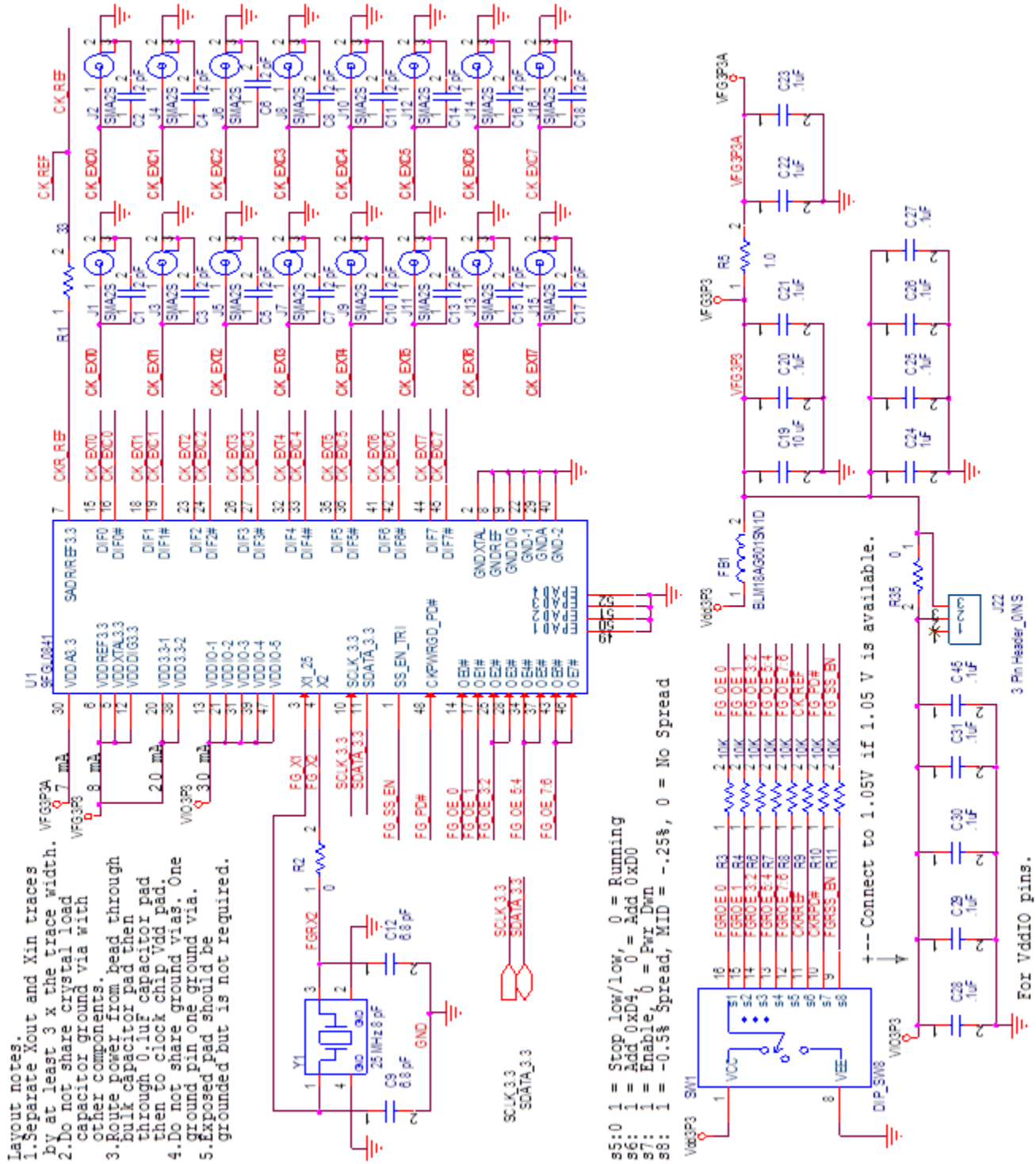
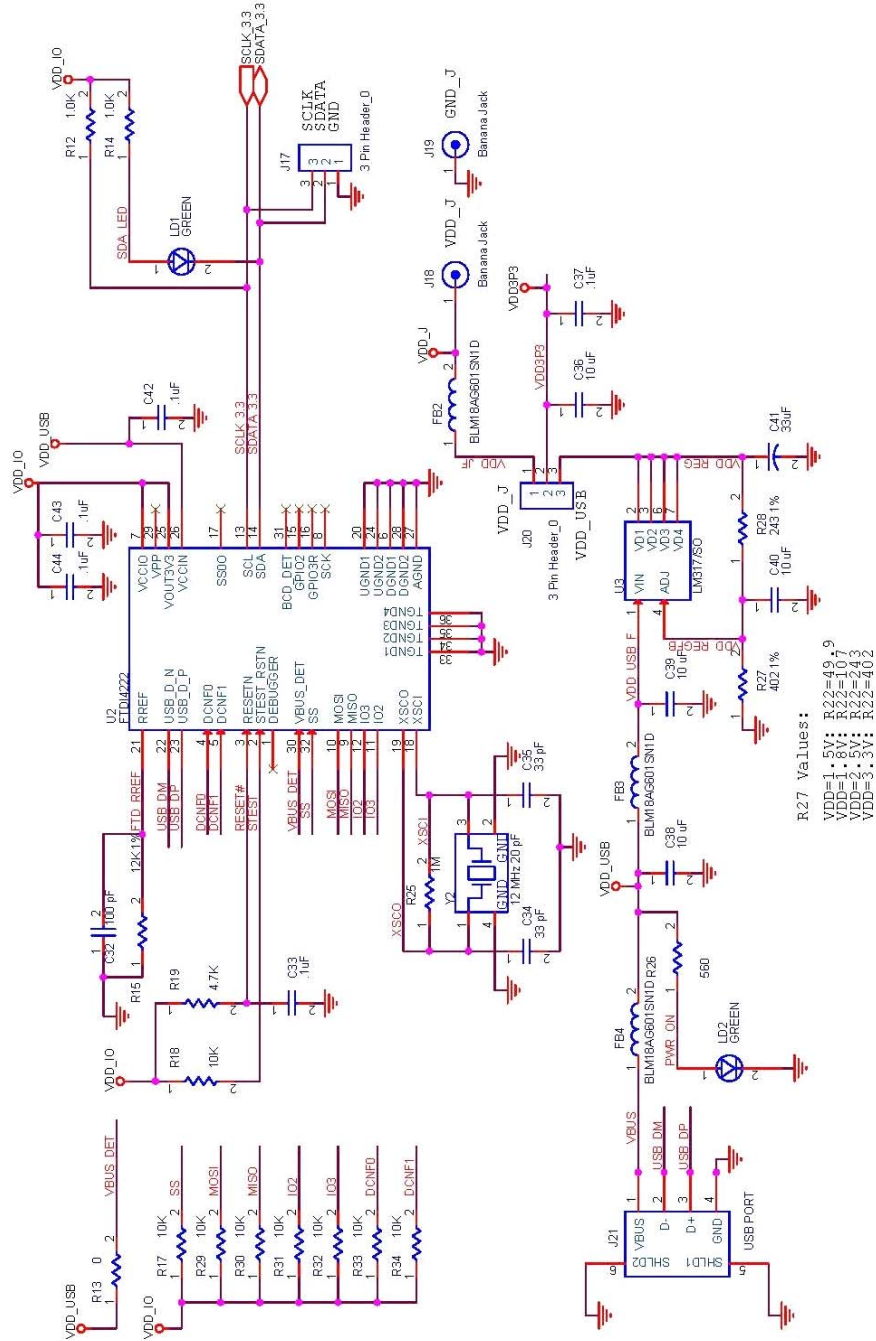

Figure 5. USB Interface and Power



## Orderable Part Numbers

The following evaluation board part numbers are available for order.

**Table 2: Orderable Part Numbers**

<b>Part Number</b>	<b>Description</b>
EVK9FGL0841	9FGL0841 Evaluation Kit
EVK9FGV0841	9FGV0841 Evaluation Kit
EVK9FGU0841	9FGU0841 Evaluation Kit
EVK9FGL0851	9FGL0851 Evaluation Kit



## Notice

1. Descriptions of circuits, software and other related information in this document are provided only to illustrate the operation of semiconductor products and application examples. You are fully responsible for the incorporation or any other use of the circuits, software, and information in the design of your product or system. Renesas Electronics disclaims any and all liability for any losses and damages incurred by you or third parties arising from the use of these circuits, software, or information.
2. Renesas Electronics hereby expressly disclaims any warranties against and liability for infringement or any other claims involving patents, copyrights, or other intellectual property rights of third parties, by or arising from the use of Renesas Electronics products or technical information described in this document, including but not limited to, the product data, drawings, charts, programs, algorithms, and application examples.
3. No license, express, implied or otherwise, is granted hereby under any patents, copyrights or other intellectual property rights of Renesas Electronics or others.
4. You shall be responsible for determining what licenses are required from any third parties, and obtaining such licenses for the lawful import, export, manufacture, sales, utilization, distribution or other disposal of any products incorporating Renesas Electronics products, if required.
5. You shall not alter, modify, copy, or reverse engineer any Renesas Electronics product, whether in whole or in part. Renesas Electronics disclaims any and all liability for any losses or damages incurred by you or third parties arising from such alteration, modification, copying or reverse engineering.
6. Renesas Electronics products are classified according to the following two quality grades: "Standard" and "High Quality". The intended applications for each Renesas Electronics product depends on the product's quality grade, as indicated below.

"Standard": Computers; office equipment; communications equipment; test and measurement equipment; audio and visual equipment; home electronic appliances; machine tools; personal electronic equipment; industrial robots; etc.

"High Quality": Transportation equipment (automobiles, trains, ships, etc.); traffic control (traffic lights); large-scale communication equipment; key financial terminal systems; safety control equipment; etc.

Unless expressly designated as a high reliability product or a product for harsh environments in a Renesas Electronics data sheet or other Renesas Electronics document, Renesas Electronics products are not intended or authorized for use in products or systems that may pose a direct threat to human life or bodily injury (artificial life support devices or systems; surgical implantations; etc.), or may cause serious property damage (space system; undersea repeaters; nuclear power control systems; aircraft control systems; key plant systems; military equipment; etc.). Renesas Electronics disclaims any and all liability for any damages or losses incurred by you or any third parties arising from the use of any Renesas Electronics product that is inconsistent with any Renesas Electronics data sheet, user's manual or other Renesas Electronics document.
7. No semiconductor product is absolutely secure. Notwithstanding any security measures or features that may be implemented in Renesas Electronics hardware or software products, Renesas Electronics shall have absolutely no liability arising out of any vulnerability or security breach, including but not limited to any unauthorized access to or use of a Renesas Electronics product or a system that uses a Renesas Electronics product. RENESAS ELECTRONICS DOES NOT WARRANT OR GUARANTEE THAT RENESAS ELECTRONICS PRODUCTS, OR ANY SYSTEMS CREATED USING RENESAS ELECTRONICS PRODUCTS WILL BE INVULNERABLE OR FREE FROM CORRUPTION, ATTACK, VIRUSES, INTERFERENCE, HACKING, DATA LOSS OR THEFT, OR OTHER SECURITY INTRUSION ("Vulnerability Issues"). RENESAS ELECTRONICS DISCLAIMS ANY AND ALL RESPONSIBILITY OR LIABILITY ARISING FROM OR RELATED TO ANY VULNERABILITY ISSUES. FURTHERMORE, TO THE EXTENT PERMITTED BY APPLICABLE LAW, RENESAS ELECTRONICS DISCLAIMS ANY AND ALL WARRANTIES, EXPRESS OR IMPLIED, WITH RESPECT TO THIS DOCUMENT AND ANY RELATED OR ACCOMPANYING SOFTWARE OR HARDWARE, INCLUDING BUT NOT LIMITED TO THE IMPLIED WARRANTIES OF MERCHANTABILITY, OR FITNESS FOR A PARTICULAR PURPOSE.
8. When using Renesas Electronics products, refer to the latest product information (data sheets, user's manuals, application notes, "General Notes for Handling and Using Semiconductor Devices" in the reliability handbook, etc.), and ensure that usage conditions are within the ranges specified by Renesas Electronics with respect to maximum ratings, operating power supply voltage range, heat dissipation characteristics, installation, etc. Renesas Electronics disclaims any and all liability for any malfunctions, failure or accident arising out of the use of Renesas Electronics products outside of such specified ranges.
9. Although Renesas Electronics endeavors to improve the quality and reliability of Renesas Electronics products, semiconductor products have specific characteristics, such as the occurrence of failure at a certain rate and malfunctions under certain use conditions. Unless designated as a high reliability product or a product for harsh environments in a Renesas Electronics data sheet or other Renesas Electronics document, Renesas Electronics products are not subject to radiation resistance design. You are responsible for implementing safety measures to guard against the possibility of bodily injury, injury or damage caused by fire, and/or danger to the public in the event of a failure or malfunction of Renesas Electronics products, such as safety design for hardware and software, including but not limited to redundancy, fire control and malfunction prevention, appropriate treatment for aging degradation or any other appropriate measures. Because the evaluation of microcomputer software alone is very difficult and impractical, you are responsible for evaluating the safety of the final products or systems manufactured by you.
10. Please contact a Renesas Electronics sales office for details as to environmental matters such as the environmental compatibility of each Renesas Electronics product. You are responsible for carefully and sufficiently investigating applicable laws and regulations that regulate the inclusion or use of controlled substances, including without limitation, the EU RoHS Directive, and using Renesas Electronics products in compliance with all these applicable laws and regulations. Renesas Electronics disclaims any and all liability for damages or losses occurring as a result of your noncompliance with applicable laws and regulations.
11. Renesas Electronics products and technologies shall not be used for or incorporated into any products or systems whose manufacture, use, or sale is prohibited under any applicable domestic or foreign laws or regulations. You shall comply with any applicable export control laws and regulations promulgated and administered by the governments of any countries asserting jurisdiction over the parties or transactions.
12. It is the responsibility of the buyer or distributor of Renesas Electronics products, or any other party who distributes, disposes of, or otherwise sells or transfers the product to a third party, to notify such third party in advance of the contents and conditions set forth in this document.
13. This document shall not be reprinted, reproduced or duplicated in any form, in whole or in part, without prior written consent of Renesas Electronics.
14. Please contact a Renesas Electronics sales office if you have any questions regarding the information contained in this document or Renesas Electronics products.

(Note1) "Renesas Electronics" as used in this document means Renesas Electronics Corporation and also includes its directly or indirectly controlled subsidiaries.

(Note2) "Renesas Electronics product(s)" means any product developed or manufactured by or for Renesas Electronics.

(Disclaimer Rev.5.0-1 October 2020)

## Corporate Headquarters

TOYOSU FORESIA, 3-2-24 Toyosu,  
Koto-ku, Tokyo 135-0061, Japan  
[www.renesas.com](http://www.renesas.com)

## Trademarks

Renesas and the Renesas logo are trademarks of Renesas Electronics Corporation. All trademarks and registered trademarks are the property of their respective owners.

## Contact Information

For further information on a product, technology, the most up-to-date version of a document, or your nearest sales office, please visit:  
[www.renesas.com/contact/](http://www.renesas.com/contact/)