

お客様各位

カタログ等資料中の旧社名の扱いについて

2010年4月1日を以ってNECエレクトロニクス株式会社及び株式会社ルネサステクノロジが合併し、両社の全ての事業が当社に承継されております。従いまして、本資料中には旧社名での表記が残っておりますが、当社の資料として有効ですので、ご理解の程宜しくお願ひ申し上げます。

ルネサスエレクトロニクス ホームページ (<http://www.renesas.com>)

2010年4月1日
ルネサスエレクトロニクス株式会社

【発行】ルネサスエレクトロニクス株式会社 (<http://www.renesas.com>)

【問い合わせ先】<http://japan.renesas.com/inquiry>

Not recommended
for new design

ご注意書き

1. 本資料に記載されている内容は本資料発行時点のものであり、予告なく変更することがあります。当社製品のご購入およびご使用にあたりましては、事前に当社営業窓口で最新の情報をご確認いただきますとともに、当社ホームページなどを通じて公開される情報に常にご注意ください。
2. 本資料に記載された当社製品および技術情報の使用に関連し発生した第三者の特許権、著作権その他の知的財産権の侵害等に関し、当社は、一切その責任を負いません。当社は、本資料に基づき当社または第三者の特許権、著作権その他の知的財産権を何ら許諾するものではありません。
3. 当社製品を改造、改変、複製等しないでください。
4. 本資料に記載された回路、ソフトウェアおよびこれらに関連する情報は、半導体製品の動作例、応用例を説明するものです。お客様の機器の設計において、回路、ソフトウェアおよびこれらに関連する情報を使用する場合には、お客様の責任において行ってください。これらの使用に起因しお客様または第三者に生じた損害に関し、当社は、一切その責任を負いません。
5. 輸出に際しては、「外国為替及び外国貿易法」その他輸出関連法令を遵守し、かかる法令の定めるところにより必要な手続を行ってください。本資料に記載されている当社製品および技術を大量破壊兵器の開発等の目的、軍事利用の目的その他軍事用途の目的で使用しないでください。また、当社製品および技術を国内外の法令および規則により製造・使用・販売を禁止されている機器に使用することができません。
6. 本資料に記載されている情報は、正確を期すため慎重に作成したのですが、誤りが無いことを保証するものではありません。万一、本資料に記載されている情報の誤りに起因する損害がお客様に生じた場合においても、当社は、一切その責任を負いません。
7. 当社は、当社製品の品質水準を「標準水準」、「高品質水準」および「特定水準」に分類しております。また、各品質水準は、以下に示す用途に製品が使われることを意図しておりますので、当社製品の品質水準をご確認ください。お客様は、当社の文書による事前の承諾を得ることなく、「特定水準」に分類された用途に当社製品を使用することができません。また、お客様は、当社の文書による事前の承諾を得ることなく、意図されていない用途に当社製品を使用することができません。当社の文書による事前の承諾を得ることなく、「特定水準」に分類された用途または意図されていない用途に当社製品を使用したことによりお客様または第三者に生じた損害等に関し、当社は、一切その責任を負いません。なお、当社製品のデータ・シート、データ・ブック等の資料で特に品質水準の表示がない場合は、標準水準製品であることを表します。
標準水準： コンピュータ、OA 機器、通信機器、計測機器、AV 機器、家電、工作機械、パーソナル機器、産業用ロボット
高品質水準： 輸送機器（自動車、電車、船舶等）、交通用信号機器、防災・防犯装置、各種安全装置、生命維持を目的として設計されていない医療機器（厚生労働省定義の管理医療機器に相当）
特定水準： 航空機器、航空宇宙機器、海底中継器、原子力制御システム、生命維持のための医療機器（生命維持装置、人体に埋め込み使用するもの、治療行為（患部切り出し等）を行うもの、その他直接人命に影響を与えるもの）（厚生労働省定義の高度管理医療機器に相当）またはシステム等
8. 本資料に記載された当社製品のご使用につき、特に、最大定格、動作電源電圧範囲、放熱特性、実装条件その他諸条件につきましては、当社保証範囲内でご使用ください。当社保証範囲を超えて当社製品をご使用された場合の故障および事故につきましては、当社は、一切その責任を負いません。
9. 当社は、当社製品の品質および信頼性の向上に努めておりますが、半導体製品はある確率で故障が発生したり、使用条件によっては誤動作したりする場合があります。また、当社製品は耐放射線設計については行っておりません。当社製品の故障または誤動作が生じた場合も、人身事故、火災事故、社会的損害などを生じさせないようお客様の責任において冗長設計、延焼対策設計、誤動作防止設計等の安全設計およびエージング処理等、機器またはシステムとしての出荷保証をお願いいたします。特に、マイコンソフトウェアは、単独での検証は困難なため、お客様が製造された最終の機器・システムとしての安全検証をお願いいたします。
10. 当社製品の環境適合性等、詳細につきましては製品個別に必ず当社営業窓口までお問合せください。ご使用に際しては、特定の物質の含有・使用を規制する RoHS 指令等、適用される環境関連法令を十分調査のうえ、かかる法令に適合するようご使用ください。お客様がかかる法令を遵守しないことにより生じた損害に関し、当社は、一切その責任を負いません。
11. 本資料の全部または一部を当社の文書による事前の承諾を得ることなく転載または複製することを固くお断りいたします。
12. 本資料に関する詳細についてのお問い合わせその他お気付きの点等がございましたら当社営業窓口までご照会ください。

注 1. 本資料において使用されている「当社」とは、ルネサスエレクトロニクス株式会社およびルネサスエレクトロニクス株式会社とその総株主の議決権の過半数を直接または間接に保有する会社をいいます。

注 2. 本資料において使用されている「当社製品」とは、注 1 において定義された当社の開発、製造製品をいいます。

HSG1003

SiGeHBT

高周波低雑音増幅

RJJ03G0285-0200

Rev.2.00

2005.01.25

特長

- 高電力利得, 低雑音指数です。
- $MSG = 21 \text{ dB typ.}, NF = 0.65 \text{ dB typ. at } V_{CE} = 2 \text{ V}, I_C = 5 \text{ mA}, f = 1.8 \text{ GHz}$
 $MSG = 19 \text{ dB typ.}, NF = 0.75 \text{ dB typ. at } V_{CE} = 2 \text{ V}, I_C = 5 \text{ mA}, f = 2.4 \text{ GHz}$
 $MSG = 14 \text{ dB typ.}, NF = 1.2 \text{ dB typ. at } V_{CE} = 2 \text{ V}, I_C = 10 \text{ mA}, f = 5.8 \text{ GHz}$
- 利得帯域幅積
 $f_T = 36 \text{ GHz typ. at } f = 1 \text{ GHz}$
- $V_{CEO} = 3.5 \text{ V}$
- 2.4 GHz / 5 GHz Band WLAN やコードレスフォンに適しています。

外観図

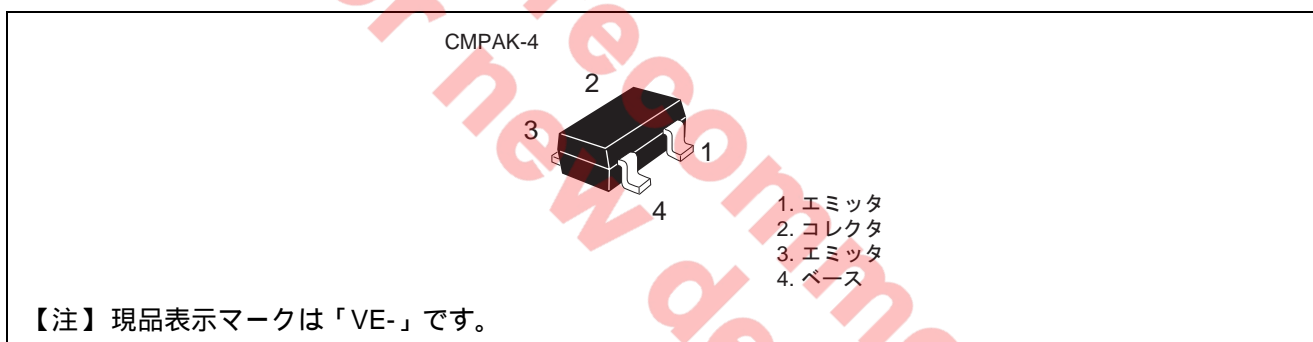

絶対最大定格

($T_a = 25^\circ\text{C}$)

項目	記号	定格値	単位
コレクタ・ベース電圧	V_{CBO}	8	V
コレクタ・エミッタ電圧	V_{CEO}	3.5	V
エミッタ・ベース電圧	V_{EBO}	1.2	V
コレクタ電流	I_C	35	mA
許容コレクタ損失	P_c	100	mW
	P_c 注 ¹	250	mW
接合部温度	T_j	150	$^\circ\text{C}$
保存温度	T_{stg}	-55 ~ +150	$^\circ\text{C}$

【注】 1. Value on PCB (FR-4 : 40 x 40 x 1.6mm Double side)

電気的特性

(Ta = 25°C)

項目	記号	Min	Typ	Max	単位	測定条件
直流電流増幅率	h_{FE}	100	200	300	—	$V_{CE} = 2\text{ V}$, $I_C = 5\text{ mA}$
帰還容量	C_{re}	—	0.12	—	pF	$V_{CB} = 2\text{ V}$, $I_E = 0$, $f = 1\text{ MHz}$
利得帯域幅積	f_T	—	36	—	GHz	$V_{CE} = 2\text{ V}$, $I_C = f_T\text{ peak}$, $f = 1\text{ GHz}$
挿入利得	$ S_{21} ^2$	—	18	—	dB	$V_{CE} = 2\text{ V}$, $I_C = 5\text{ mA}$, $f = 1.8\text{ GHz}$
		—	16	—		$V_{CE} = 2\text{ V}$, $I_C = 5\text{ mA}$, $f = 2.4\text{ GHz}$
		—	10	—		$V_{CE} = 2\text{ V}$, $I_C = 10\text{ mA}$, $f = 5.8\text{ GHz}$
最大安定利得 ^{注1}	MSG	—	21	—	dB	$V_{CE} = 2\text{ V}$, $I_C = 5\text{ mA}$, $f = 1.8\text{ GHz}$
		—	19	—		$V_{CE} = 2\text{ V}$, $I_C = 5\text{ mA}$, $f = 2.4\text{ GHz}$
		—	14	—		$V_{CE} = 2\text{ V}$, $I_C = 10\text{ mA}$, $f = 5.8\text{ GHz}$
電力利得	PG	—	18.5	—	dB	$V_{CE} = 2\text{ V}$, $I_C = 5\text{ mA}$, $f = 1.8\text{ GHz}$
		—	17	—		$V_{CE} = 2\text{ V}$, $I_C = 5\text{ mA}$, $f = 2.4\text{ GHz}$
		7	10	—		$V_{CE} = 2\text{ V}$, $I_C = 10\text{ mA}$, $f = 5.8\text{ GHz}$
雑音指数	NF	—	0.65	—	dB	$V_{CE} = 2\text{ V}$, $I_C = 5\text{ mA}$, $f = 1.8\text{ GHz}$
		—	0.75	—		$V_{CE} = 2\text{ V}$, $I_C = 5\text{ mA}$, $f = 2.4\text{ GHz}$
		—	1.2	1.8		$V_{CE} = 2\text{ V}$, $I_C = 10\text{ mA}$, $f = 5.8\text{ GHz}$
最大有能利得 ^{注2}	MAG	—	11	—	dB	$V_{CE} = 2\text{ V}$, $I_C = 10\text{ mA}$, $f = 5.8\text{ GHz}$

【注】 1. $MSG = |S_{21}| / |S_{12}|$ 2. $MAG = |S_{21}| / |S_{12}|(K \cdot (K^2 - 1)^{1/2})$

主特性

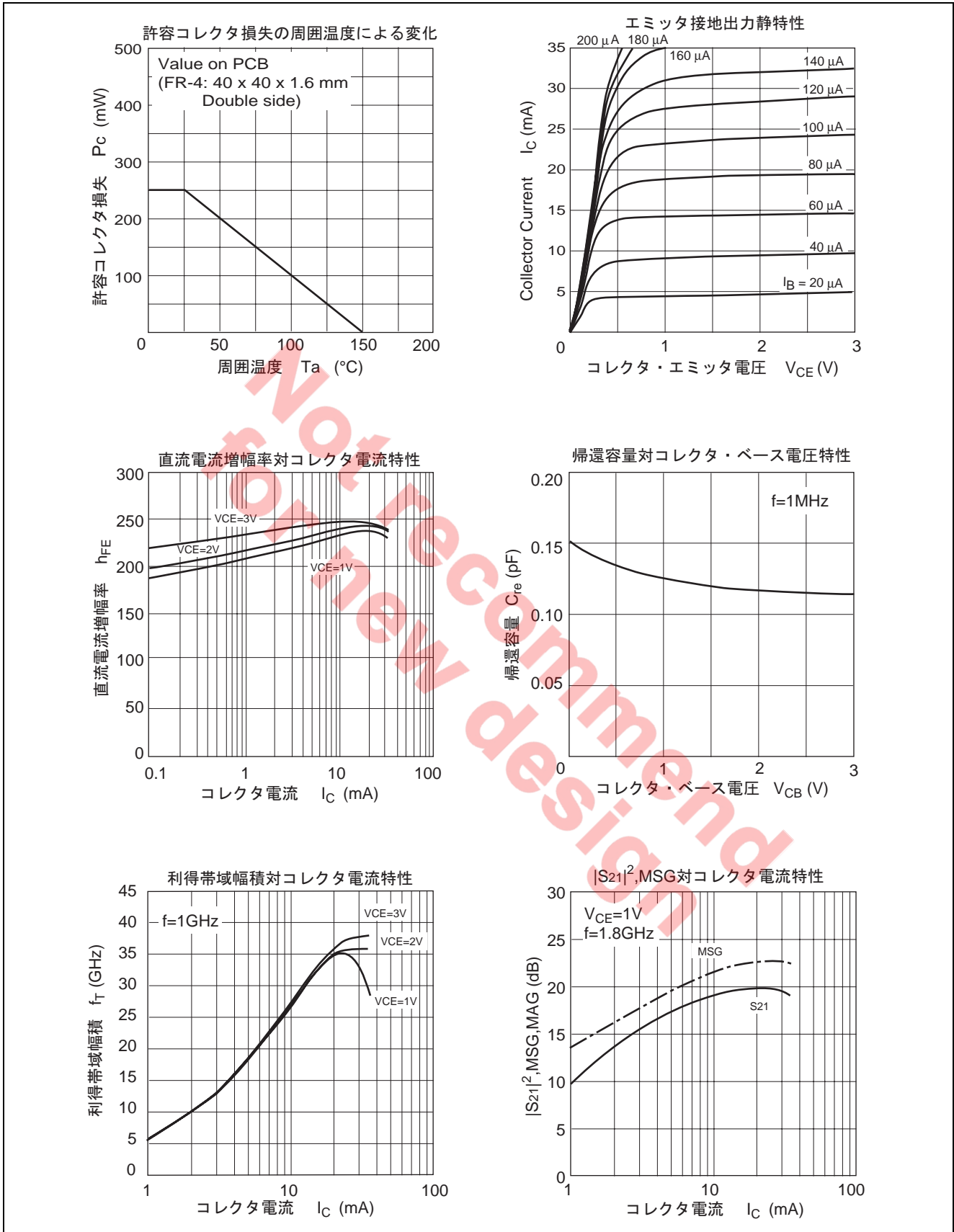

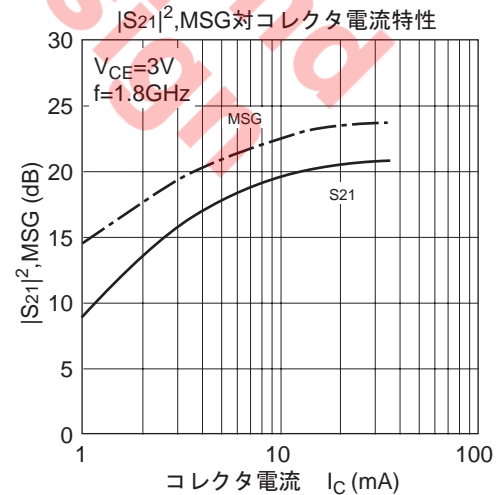
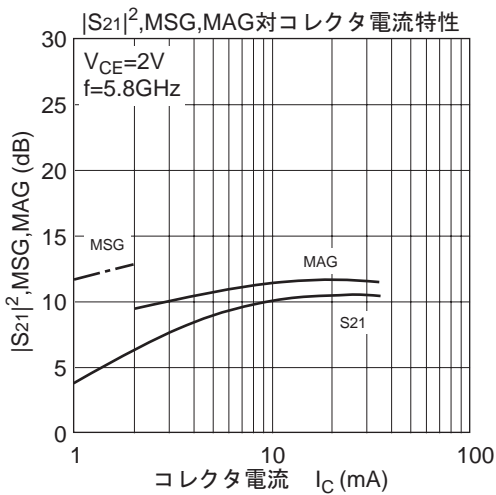
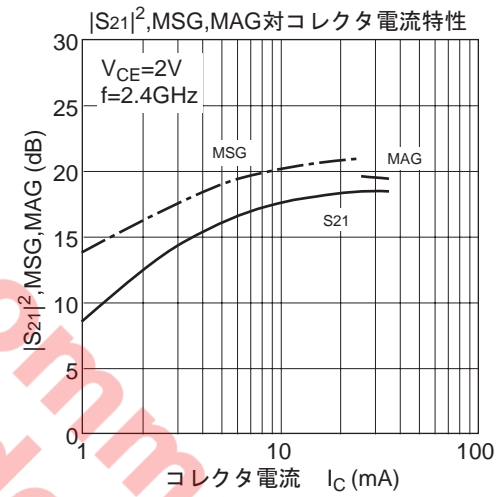
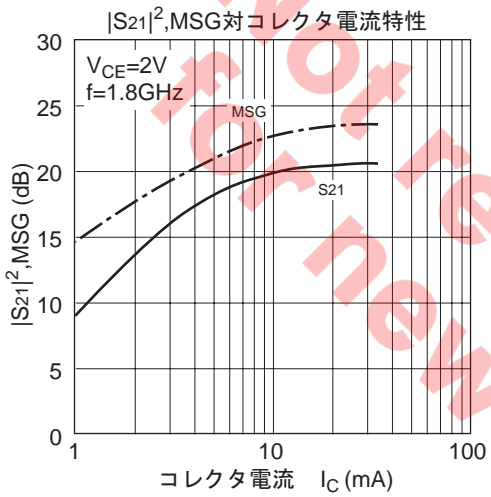
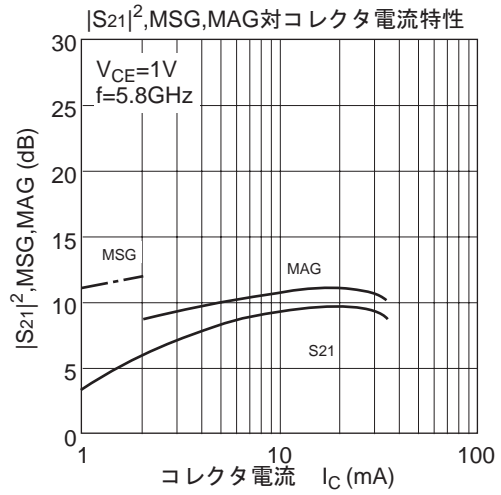
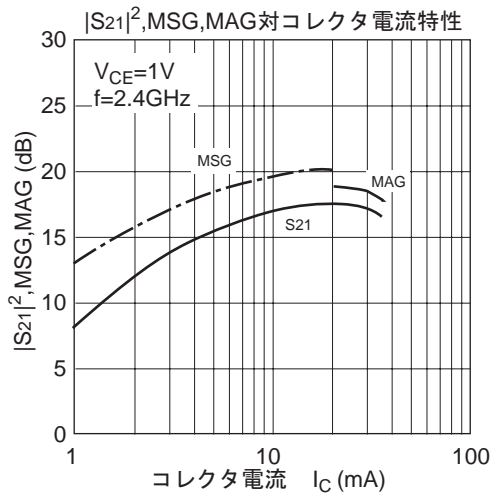

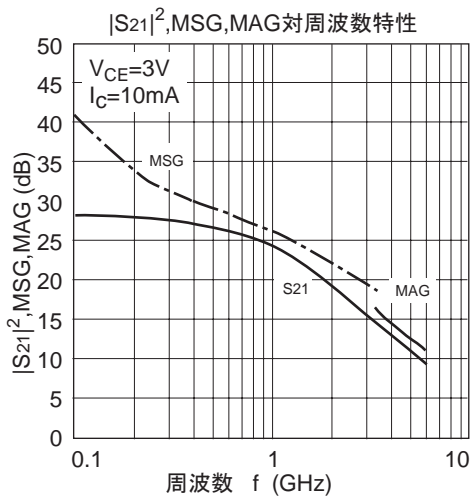
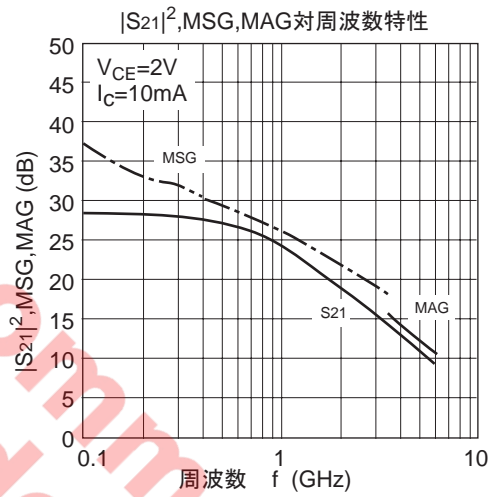
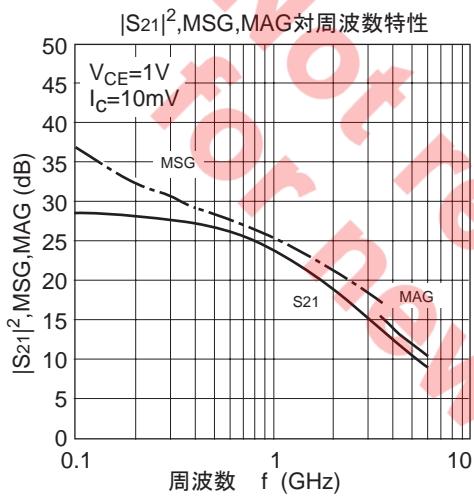
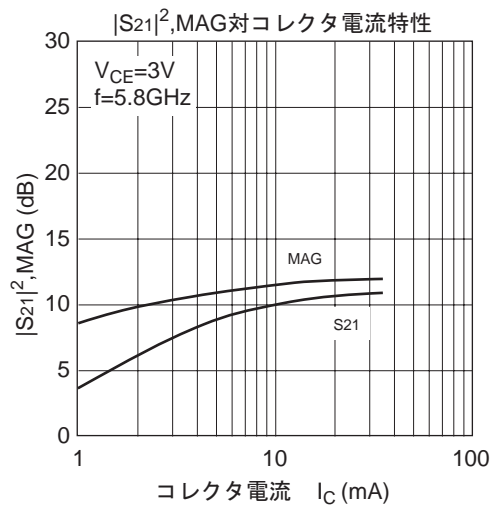
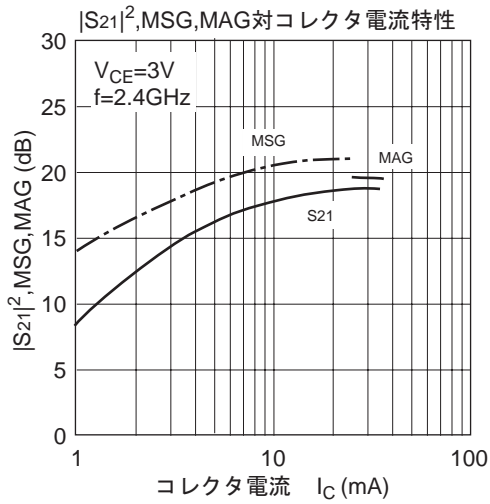

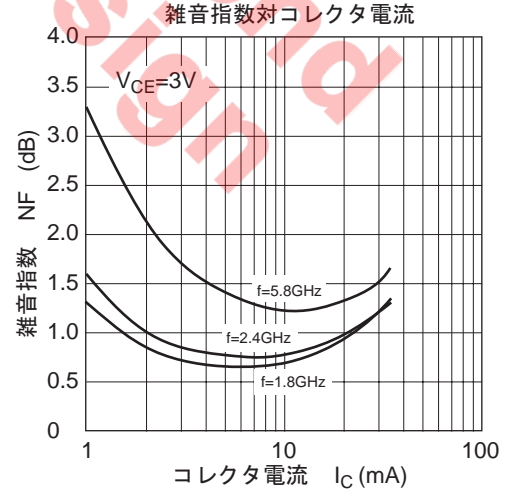
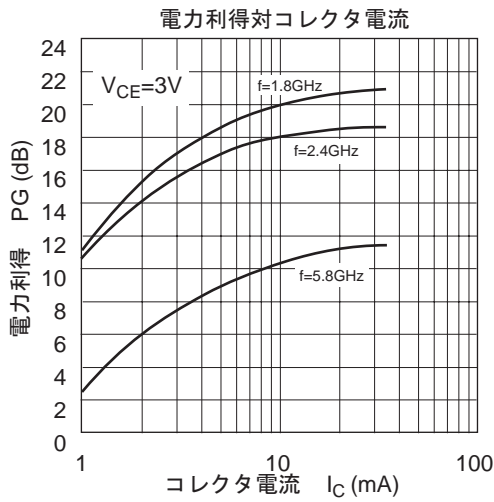
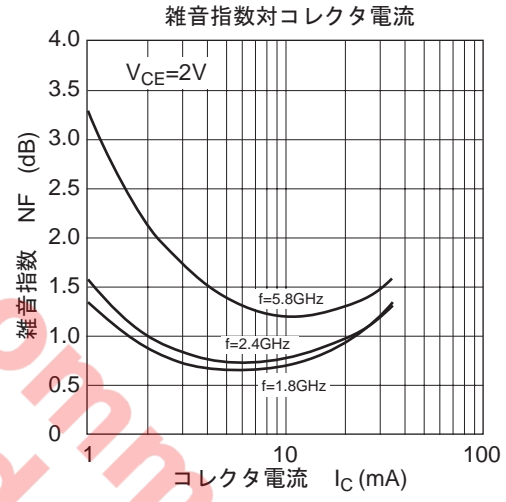
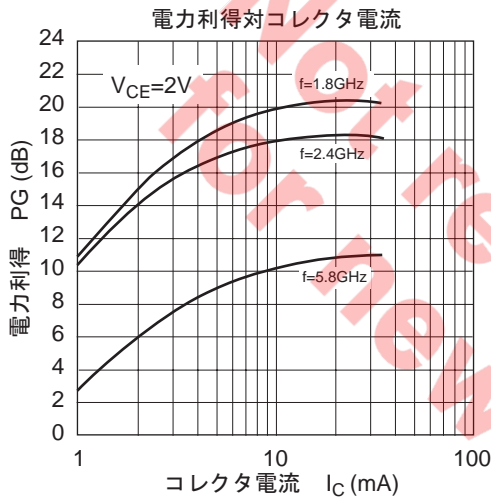
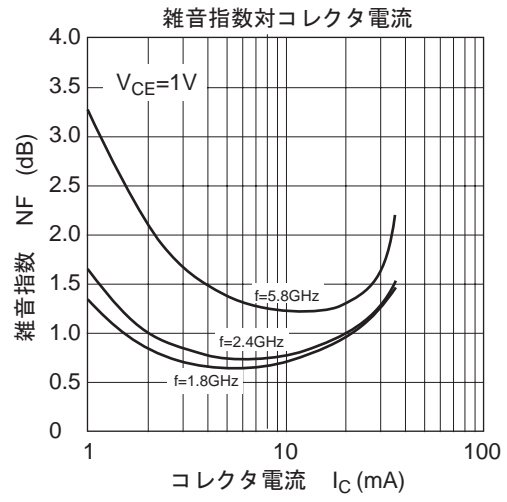
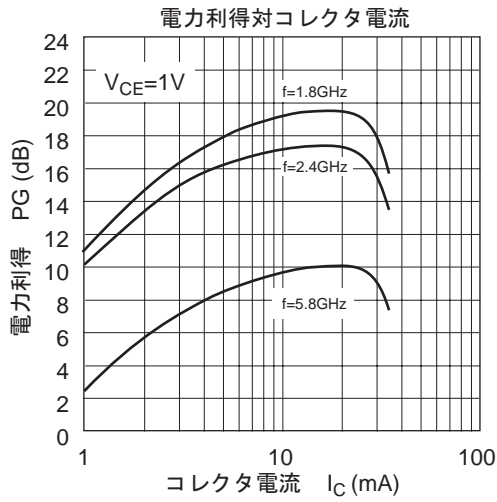

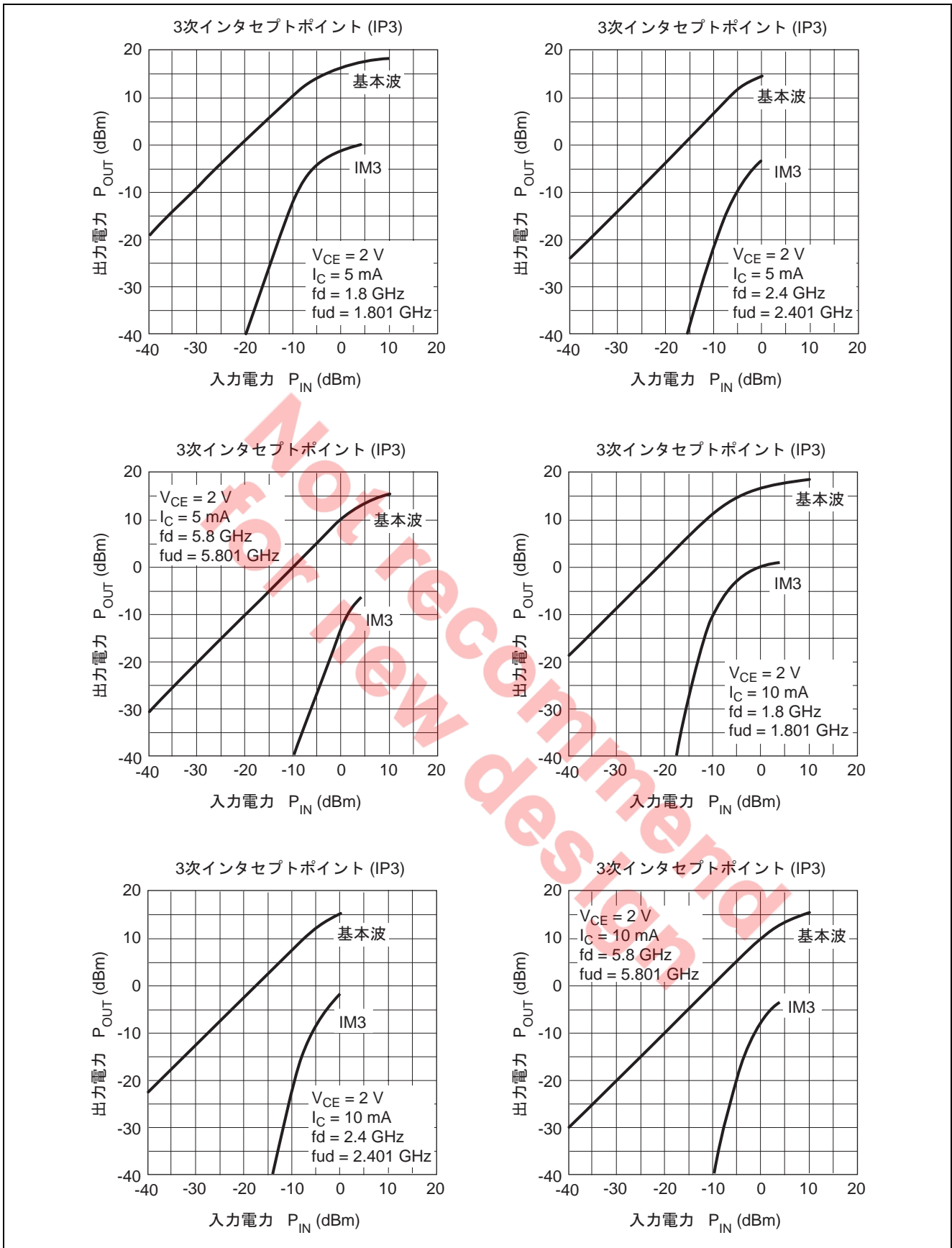

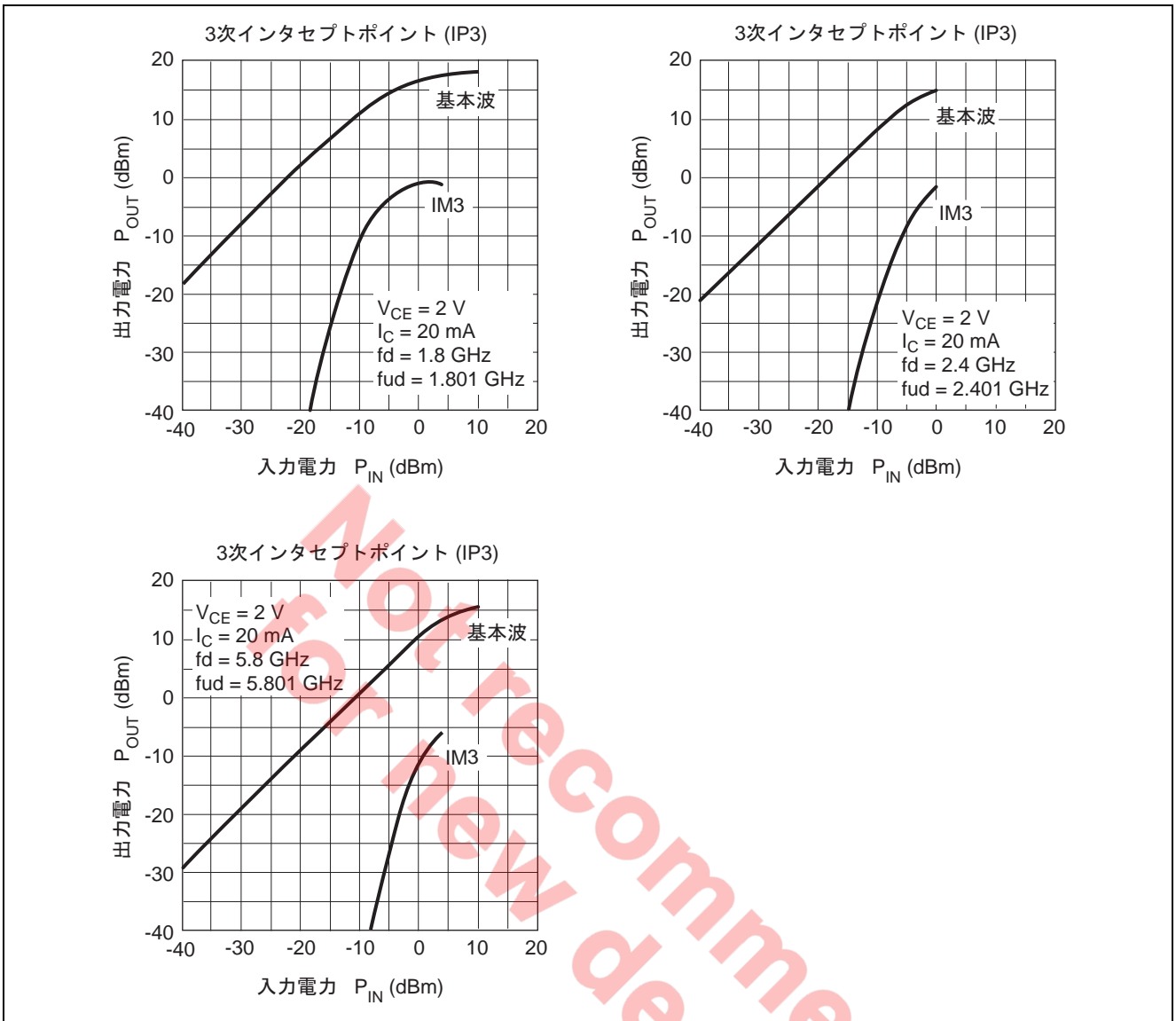

S11 Parameter vs. Frequency

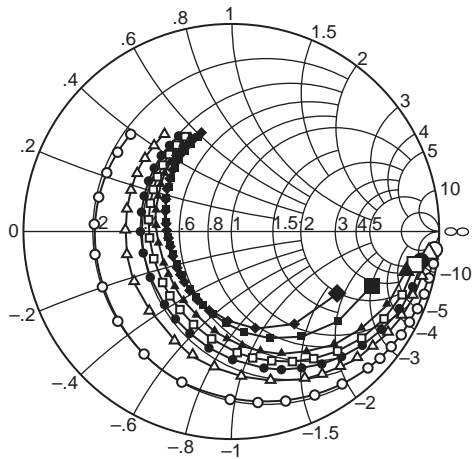

Condition: VCE = 1 V , Zo = 50 Ω
 100 to 1000 MHz (100 MHz step)
 1000 to 2000 MHz (200 MHz step)
 2000 to 6000 MHz (400 MHz step)

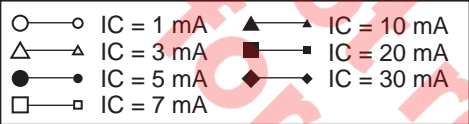

S21 Parameter vs. Frequency

Scale: 15 / div.

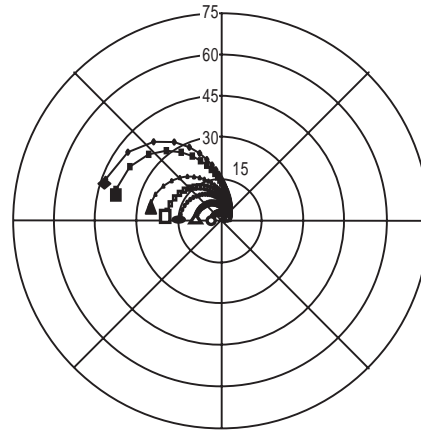

Condition: VCE = 1 V , Zo = 50 Ω
 100 to 6000 MHz (100 MHz step)

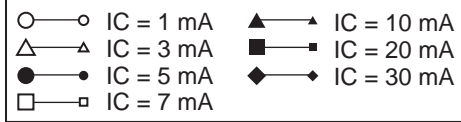

S12 Parameter vs. Frequency

Scale: 0.1 / div.

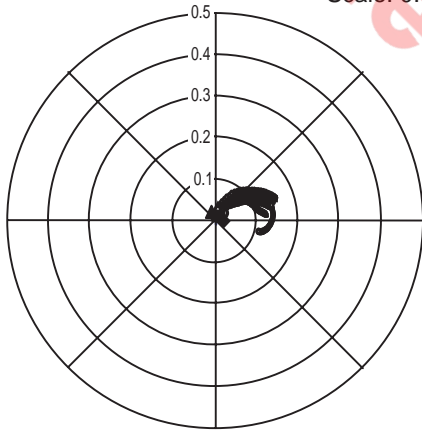

Condition: VCE = 1 V , Zo = 50 Ω
 100 to 6000 MHz (100 MHz step)



S22 Parameter vs. Frequency

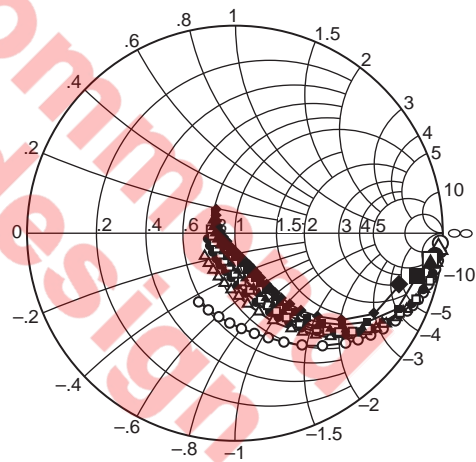

Condition: VCE = 1 V , Zo = 50 Ω
 100 to 1000 MHz (100 MHz step)
 1000 to 2000 MHz (200 MHz step)
 2000 to 6000 MHz (400 MHz step)

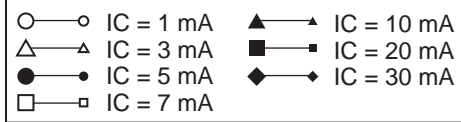

S11 Parameter vs. Frequency

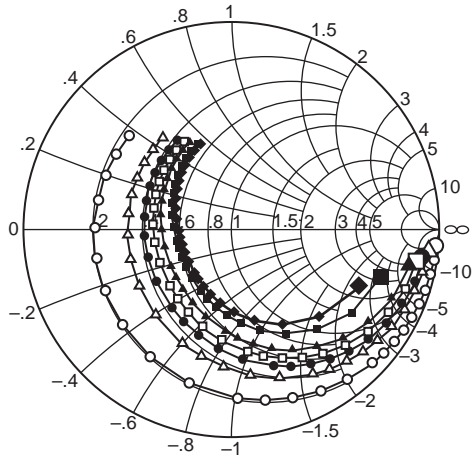

Condition: VCE = 2 V , Zo = 50 Ω
 100 to 1000 MHz (100 MHz step)
 1000 to 2000 MHz (200 MHz step)
 2000 to 6000 MHz (400 MHz step)

- | | |
|---------------|----------------|
| ○—○ IC = 1 mA | ▲—▲ IC = 10 mA |
| △—△ IC = 3 mA | ■—■ IC = 20 mA |
| ●—● IC = 5 mA | ◆—◆ IC = 30 mA |
| □—□ IC = 7 mA | |

S21 Parameter vs. Frequency

Scale: 15 / div.

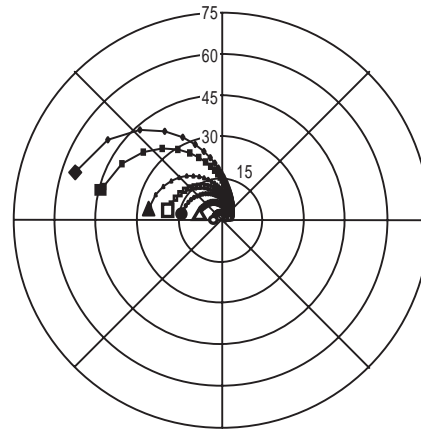

Condition: VCE = 2 V , Zo = 50 Ω
 100 to 6000 MHz (100 MHz step)

- | | |
|---------------|----------------|
| ○—○ IC = 1 mA | ▲—▲ IC = 10 mA |
| △—△ IC = 3 mA | ■—■ IC = 20 mA |
| ●—● IC = 5 mA | ◆—◆ IC = 30 mA |
| □—□ IC = 7 mA | |

S12 Parameter vs. Frequency

Scale: 0.1 / div.

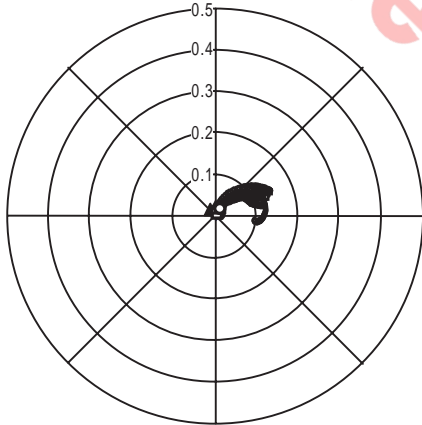

Condition: VCE = 2 V , Zo = 50 Ω
 100 to 6000 MHz (100 MHz step)

- | | |
|---------------|----------------|
| ○—○ IC = 1 mA | ▲—▲ IC = 10 mA |
| △—△ IC = 3 mA | ■—■ IC = 20 mA |
| ●—● IC = 5 mA | ◆—◆ IC = 30 mA |
| □—□ IC = 7 mA | |

S22 Parameter vs. Frequency

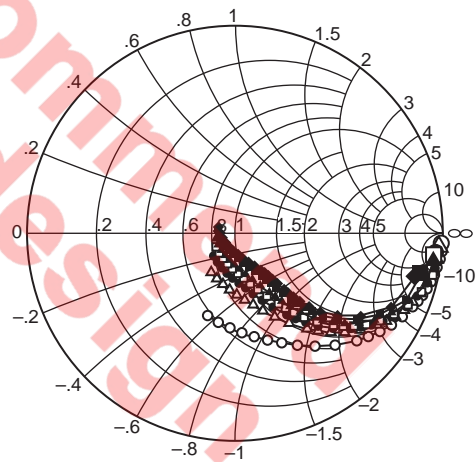

Condition: VCE = 2 V , Zo = 50 Ω
 100 to 1000 MHz (100 MHz step)
 1000 to 2000 MHz (200 MHz step)
 2000 to 6000 MHz (400 MHz step)

- | | |
|---------------|----------------|
| ○—○ IC = 1 mA | ▲—▲ IC = 10 mA |
| △—△ IC = 3 mA | ■—■ IC = 20 mA |
| ●—● IC = 5 mA | ◆—◆ IC = 30 mA |
| □—□ IC = 7 mA | |

S11 Parameter vs. Frequency

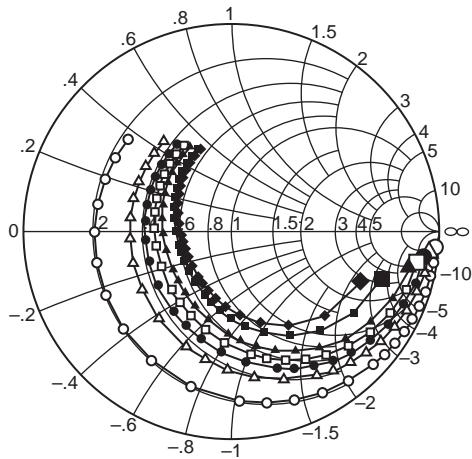

Condition: VCE = 3 V , Zo = 50 Ω
 100 to 1000 MHz (100 MHz step)
 1000 to 2000 MHz (200 MHz step)
 2000 to 6000 MHz (400 MHz step)



S21 Parameter vs. Frequency

Scale: 15 / div.

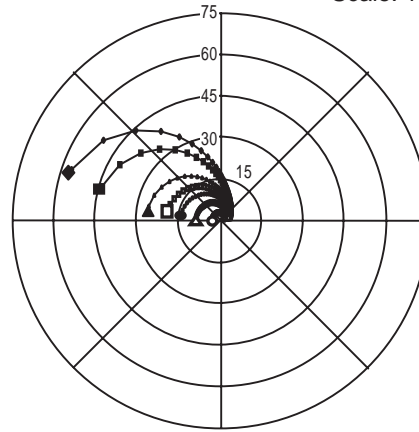

Condition: VCE = 3 V , Zo = 50 Ω
 100 to 6000 MHz (100 MHz step)

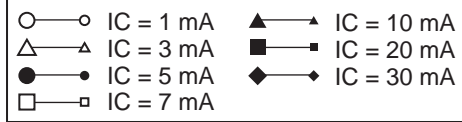

S12 Parameter vs. Frequency

Scale: 0.1 / div.

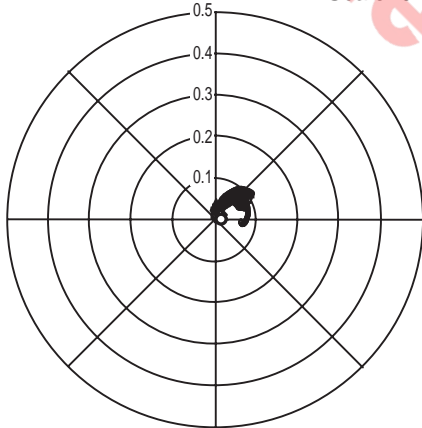

Condition: VCE = 3 V , Zo = 50 Ω
 100 to 6000 MHz (100 MHz step)



S22 Parameter vs. Frequency

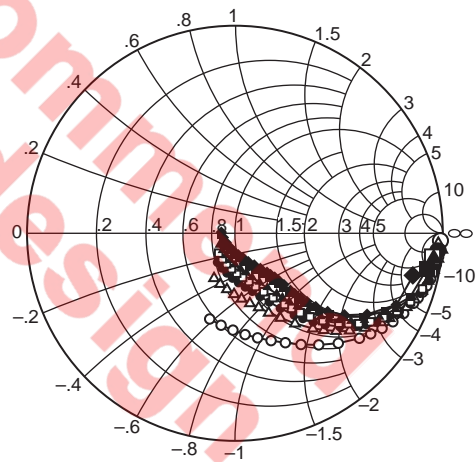

Condition: VCE = 3 V , Zo = 50 Ω
 100 to 1000 MHz (100 MHz step)
 1000 to 2000 MHz (200 MHz step)
 2000 to 6000 MHz (400 MHz step)

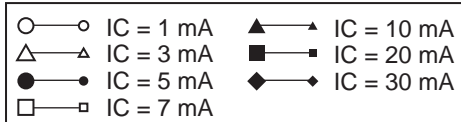

S パラメータ

(V_{CE} = 1 V, I_C = 1 mA, Z_O = 50 Ω)

f (MHz)	S11		S21		S12		S22	
	MAG	ANG	MAG	ANG	MAG	ANG	MAG	ANG
100	0.980	-4.9	3.18	175.9	0.0044	86.2	0.988	-2.8
200	0.982	-9.0	3.18	171.6	0.0149	86.8	0.996	-5.3
300	0.974	-13.1	3.17	167.8	0.0247	84.0	0.987	-7.7
400	0.972	-17.9	3.17	164.1	0.0337	76.0	0.980	-10.3
500	0.966	-22.5	3.17	160.4	0.0405	75.2	0.972	-13.0
600	0.958	-26.9	3.15	157.0	0.0473	71.9	0.961	-15.2
700	0.953	-31.3	3.11	153.2	0.0549	67.6	0.950	-17.7
800	0.944	-35.8	3.08	149.6	0.0620	65.0	0.937	-20.0
900	0.936	-40.5	3.10	147.0	0.0682	61.3	0.923	-22.3
1000	0.925	-45.0	3.08	142.8	0.0754	59.8	0.909	-24.4
1100	0.915	-49.5	3.05	139.4	0.0816	56.4	0.895	-26.6
1200	0.903	-54.1	3.05	135.5	0.0871	53.3	0.879	-28.8
1300	0.891	-58.5	3.00	132.2	0.0934	50.9	0.863	-30.9
1400	0.880	-63.1	2.96	128.9	0.0982	47.8	0.848	-33.0
1500	0.867	-67.7	2.94	125.6	0.1036	45.1	0.833	-35.1
1600	0.854	-72.4	2.92	122.2	0.1074	42.6	0.817	-37.0
1700	0.843	-76.9	2.88	118.8	0.1127	40.0	0.800	-39.1
1800	0.830	-81.3	2.83	115.5	0.1156	37.3	0.784	-41.0
1900	0.819	-85.9	2.79	112.4	0.1194	35.2	0.768	-43.0
2000	0.806	-90.6	2.76	109.3	0.1226	32.7	0.751	-44.9
2200	0.783	-99.4	2.67	103.0	0.1282	27.9	0.719	-48.7
2400	0.762	-108.4	2.59	96.9	0.1322	23.3	0.687	-52.3
2600	0.742	-117.2	2.51	90.9	0.1348	18.6	0.655	-55.8
2800	0.724	-125.7	2.42	85.2	0.1370	14.8	0.628	-59.2
3000	0.708	-134.1	2.34	79.6	0.1376	11.1	0.601	-62.5
3200	0.697	-142.0	2.24	74.2	0.1382	7.2	0.575	-66.0
3400	0.686	-149.8	2.16	69.0	0.1373	4.1	0.553	-69.3
3600	0.676	-157.1	2.07	64.0	0.1350	0.8	0.529	-72.5
3800	0.671	-164.0	2.00	59.3	0.1323	-1.5	0.510	-75.8
4000	0.667	-170.7	1.92	54.5	0.1313	-3.9	0.493	-79.2
4200	0.664	-177.3	1.86	50.0	0.1283	-6.1	0.476	-82.7
4400	0.663	176.7	1.79	45.5	0.1261	-8.1	0.461	-86.2
4600	0.662	170.8	1.73	41.2	0.1230	-9.6	0.447	-89.7
4800	0.663	165.2	1.66	37.0	0.1199	-11.1	0.435	-93.4
5000	0.664	159.8	1.60	32.8	0.1167	-12.6	0.423	-97.1
5200	0.666	154.6	1.55	28.7	0.1142	-13.2	0.411	-101.1
5400	0.670	149.7	1.50	24.8	0.1116	-14.0	0.402	-105.2
5600	0.671	145.0	1.45	20.9	0.1089	-14.1	0.392	-109.2
5800	0.674	140.4	1.40	17.0	0.1069	-14.1	0.384	-113.5
6000	0.678	135.9	1.36	13.2	0.1048	-14.3	0.376	-117.9

Sパラメータ

(V_{CE} = 1 V, I_C = 3 mA, Z_O = 50 Ω)

f (MHz)	S11		S21		S12		S22	
	MAG	ANG	MAG	ANG	MAG	ANG	MAG	ANG
100	0.953	-6.7	9.14	173.8	0.0077	73.4	0.981	-4.6
200	0.947	-13.2	9.09	168.0	0.0151	82.6	0.988	-8.5
300	0.929	-19.3	8.97	162.6	0.0214	75.6	0.972	-12.5
400	0.916	-26.1	8.84	157.3	0.0304	73.8	0.953	-16.5
500	0.900	-32.6	8.71	152.3	0.0377	68.0	0.933	-20.3
600	0.880	-39.0	8.55	147.6	0.0442	65.8	0.907	-23.9
700	0.861	-44.9	8.29	143.0	0.0506	62.4	0.881	-27.5
800	0.838	-50.9	8.09	138.4	0.0561	58.9	0.852	-30.9
900	0.817	-57.3	7.99	134.5	0.0609	54.4	0.822	-33.9
1000	0.792	-63.2	7.76	129.9	0.0654	52.3	0.792	-36.8
1100	0.769	-69.0	7.54	125.9	0.0690	49.2	0.765	-39.6
1200	0.743	-75.0	7.36	121.6	0.0727	46.5	0.735	-42.1
1300	0.720	-80.4	7.12	117.8	0.0759	43.9	0.706	-44.7
1400	0.699	-85.8	6.88	114.2	0.0787	41.6	0.680	-47.1
1500	0.677	-91.4	6.68	110.7	0.0822	40.0	0.654	-49.4
1600	0.657	-96.8	6.49	107.1	0.0832	37.8	0.628	-51.4
1700	0.639	-101.9	6.28	103.8	0.0862	36.5	0.604	-53.5
1800	0.622	-107.0	6.07	100.6	0.0881	34.1	0.579	-55.4
1900	0.606	-112.0	5.87	97.5	0.0897	32.7	0.558	-57.4
2000	0.592	-117.1	5.69	94.6	0.0905	31.0	0.536	-59.3
2200	0.568	-126.3	5.33	88.9	0.0934	27.9	0.497	-62.8
2400	0.548	-135.5	5.01	83.5	0.0947	25.5	0.461	-66.1
2600	0.533	-144.2	4.71	78.4	0.0965	23.8	0.427	-69.5
2800	0.523	-152.5	4.44	73.6	0.0984	22.1	0.398	-72.7
3000	0.515	-160.1	4.19	69.0	0.0997	20.4	0.372	-75.9
3200	0.511	-167.4	3.96	64.6	0.1014	18.9	0.348	-79.4
3400	0.508	-174.3	3.75	60.3	0.1012	17.2	0.326	-82.6
3600	0.506	179.2	3.55	56.2	0.1021	16.4	0.305	-85.9
3800	0.507	173.4	3.38	52.4	0.1031	15.5	0.288	-89.4
4000	0.510	167.8	3.22	48.5	0.1048	15.1	0.273	-93.1
4200	0.514	162.4	3.08	44.7	0.1060	14.2	0.259	-97.0
4400	0.518	157.5	2.95	41.1	0.1071	13.4	0.247	-101.2
4600	0.524	152.8	2.82	37.5	0.1092	12.5	0.235	-105.5
4800	0.529	148.2	2.71	33.9	0.1106	11.6	0.224	-109.7
5000	0.535	143.8	2.60	30.5	0.1117	11.3	0.214	-114.7
5200	0.541	139.5	2.50	27.0	0.1138	10.6	0.205	-119.6
5400	0.547	135.6	2.41	23.6	0.1157	9.4	0.198	-124.9
5600	0.553	131.7	2.32	20.2	0.1179	9.0	0.191	-130.3
5800	0.558	127.9	2.24	16.9	0.1197	8.1	0.186	-136.0
6000	0.565	124.2	2.16	13.5	0.1220	7.2	0.181	-142.0

Sパラメータ

(V_{CE} = 1 V, I_C = 5 mA, Z_O = 50 Ω)

f (MHz)	S11		S21		S12		S22	
	MAG	ANG	MAG	ANG	MAG	ANG	MAG	ANG
100	0.922	-8.9	14.58	172.1	0.0110	92.2	0.967	-6.3
200	0.909	-17.0	14.38	164.8	0.0151	75.0	0.974	-11.4
300	0.887	-24.8	14.03	158.0	0.0227	75.8	0.948	-16.6
400	0.861	-33.2	13.65	151.7	0.0304	70.8	0.919	-21.6
500	0.833	-41.2	13.26	145.8	0.0346	65.8	0.884	-26.4
600	0.801	-48.8	12.82	140.2	0.0409	62.3	0.845	-30.7
700	0.771	-55.9	12.25	135.0	0.0454	58.2	0.806	-34.8
800	0.738	-63.0	11.78	129.9	0.0499	54.9	0.764	-38.5
900	0.707	-70.3	11.38	125.4	0.0534	51.7	0.726	-41.7
1000	0.676	-76.8	10.88	120.7	0.0567	49.0	0.688	-44.7
1100	0.648	-83.2	10.38	116.5	0.0593	46.7	0.653	-47.5
1200	0.618	-89.7	9.96	112.3	0.0619	44.0	0.618	-50.0
1300	0.593	-95.4	9.49	108.5	0.0642	43.0	0.586	-52.4
1400	0.572	-101.1	9.06	105.1	0.0666	41.6	0.559	-54.6
1500	0.550	-106.9	8.67	101.7	0.0686	40.3	0.530	-56.8
1600	0.531	-112.4	8.30	98.5	0.0708	39.2	0.505	-58.6
1700	0.516	-117.6	7.95	95.4	0.0735	38.3	0.480	-60.6
1800	0.502	-122.8	7.61	92.5	0.0738	36.3	0.457	-62.3
1900	0.489	-127.7	7.30	89.7	0.0750	36.0	0.437	-64.1
2000	0.478	-132.7	7.01	87.0	0.0759	34.9	0.417	-65.9
2200	0.462	-141.8	6.48	82.0	0.0792	33.3	0.381	-69.1
2400	0.451	-150.6	6.02	77.2	0.0818	32.3	0.349	-72.4
2600	0.443	-158.8	5.61	72.7	0.0844	31.1	0.319	-75.7
2800	0.439	-166.3	5.25	68.5	0.0872	29.7	0.294	-79.1
3000	0.438	-173.5	4.92	64.4	0.0890	28.7	0.272	-82.4
3200	0.440	-180.0	4.63	60.4	0.0922	27.7	0.251	-86.4
3400	0.442	173.7	4.37	56.6	0.0947	27.0	0.232	-90.2
3600	0.445	167.9	4.13	53.0	0.0964	25.9	0.214	-94.1
3800	0.449	162.8	3.91	49.5	0.0992	25.7	0.200	-98.3
4000	0.455	158.0	3.73	46.0	0.1023	24.4	0.188	-103.1
4200	0.462	153.2	3.55	42.5	0.1058	23.7	0.177	-108.1
4400	0.469	148.7	3.39	39.2	0.1088	22.9	0.167	-113.6
4600	0.476	144.6	3.25	35.9	0.1114	21.8	0.158	-119.3
4800	0.483	140.7	3.11	32.6	0.1146	20.5	0.150	-125.4
5000	0.491	136.8	2.98	29.4	0.1174	19.6	0.144	-131.6
5200	0.499	133.0	2.87	26.2	0.1205	18.3	0.138	-138.9
5400	0.505	129.4	2.76	23.0	0.1236	17.1	0.135	-146.1
5600	0.512	125.9	2.66	19.8	0.1268	16.0	0.132	-153.2
5800	0.519	122.5	2.56	16.7	0.1298	14.2	0.131	-160.8
6000	0.527	119.1	2.47	13.5	0.1330	13.3	0.131	-168.4

Sパラメータ

(V_{CE} = 1 V, I_C = 7 mA, Z_O = 50 Ω)

f (MHz)	S11		S21		S12		S22	
	MAG	ANG	MAG	ANG	MAG	ANG	MAG	ANG
100	0.897	-10.3	19.56	170.6	0.0103	89.3	0.954	-7.7
200	0.874	-20.5	19.13	162.0	0.0137	81.7	0.963	-13.8
300	0.845	-30.0	18.47	154.2	0.0244	69.4	0.925	-20.2
400	0.809	-39.5	17.74	147.0	0.0282	68.9	0.880	-26.0
500	0.769	-48.6	16.98	140.4	0.0326	62.9	0.834	-31.3
600	0.729	-57.3	16.17	134.3	0.0373	59.6	0.785	-35.8
700	0.692	-65.1	15.24	128.7	0.0424	54.4	0.736	-40.1
800	0.653	-72.9	14.43	123.4	0.0456	52.1	0.689	-43.8
900	0.618	-80.7	13.70	118.6	0.0484	49.4	0.645	-47.0
1000	0.585	-87.5	12.92	114.1	0.0508	47.9	0.605	-49.9
1100	0.556	-94.0	12.18	110.0	0.0536	47.3	0.568	-52.5
1200	0.528	-100.6	11.54	106.1	0.0557	45.3	0.535	-54.8
1300	0.505	-106.5	10.90	102.5	0.0578	44.2	0.503	-57.0
1400	0.486	-112.4	10.32	99.3	0.0599	43.5	0.475	-58.9
1500	0.468	-118.1	9.80	96.1	0.0625	42.3	0.448	-60.8
1600	0.453	-123.5	9.31	93.2	0.0631	41.5	0.424	-62.6
1700	0.440	-128.7	8.86	90.4	0.0648	40.9	0.402	-64.4
1800	0.431	-133.8	8.45	87.7	0.0663	39.6	0.381	-66.0
1900	0.421	-138.5	8.07	85.2	0.0687	39.9	0.363	-67.6
2000	0.415	-143.4	7.72	82.7	0.0694	39.3	0.344	-69.3
2200	0.404	-152.3	7.09	78.1	0.0729	38.3	0.312	-72.6
2400	0.399	-160.6	6.55	73.7	0.0762	37.8	0.283	-75.8
2600	0.397	-168.3	6.08	69.6	0.0798	36.4	0.258	-79.4
2800	0.398	-175.3	5.67	65.6	0.0832	35.7	0.236	-82.8
3000	0.400	178.2	5.31	61.9	0.0870	34.3	0.216	-86.7
3200	0.404	172.1	4.98	58.2	0.0899	33.8	0.197	-91.2
3400	0.410	166.3	4.70	54.6	0.0928	32.2	0.180	-95.7
3600	0.415	161.0	4.43	51.2	0.0963	31.5	0.165	-100.4
3800	0.420	156.5	4.20	47.9	0.0995	31.2	0.155	-105.6
4000	0.429	152.1	3.99	44.7	0.1038	30.1	0.145	-111.6
4200	0.437	147.7	3.80	41.4	0.1071	29.0	0.136	-118.3
4400	0.444	143.8	3.63	38.2	0.1110	27.6	0.128	-125.3
4600	0.453	140.0	3.47	35.0	0.1145	26.3	0.122	-132.7
4800	0.460	136.2	3.32	31.9	0.1183	24.4	0.118	-140.4
5000	0.469	132.6	3.19	28.8	0.1220	23.1	0.114	-148.6
5200	0.477	129.2	3.06	25.7	0.1256	21.9	0.113	-156.9
5400	0.485	125.8	2.94	22.6	0.1295	20.4	0.113	-165.1
5600	0.492	122.6	2.84	19.6	0.1322	18.9	0.115	-173.1
5800	0.500	119.4	2.73	16.6	0.1356	17.2	0.117	179.1
6000	0.508	116.2	2.64	13.6	0.1391	15.6	0.122	171.3

Sパラメータ

(V_{CE} = 1 V, I_C = 10 mA, Z_O = 50 Ω)

f (MHz)	S11		S21		S12		S22	
	MAG	ANG	MAG	ANG	MAG	ANG	MAG	ANG
100	0.863	-13.0	26.20	168.5	0.0052	62.3	0.951	-9.2
200	0.825	-25.3	25.34	158.4	0.0147	87.9	0.939	-17.1
300	0.780	-36.8	24.07	149.2	0.0217	65.9	0.888	-24.7
400	0.735	-47.9	22.71	141.2	0.0267	66.2	0.825	-31.1
500	0.684	-58.2	21.28	133.8	0.0314	59.7	0.764	-36.9
600	0.636	-67.9	19.83	127.3	0.0341	58.4	0.706	-41.5
700	0.594	-76.5	18.35	121.5	0.0374	53.4	0.650	-45.6
800	0.554	-84.7	17.05	116.2	0.0401	51.4	0.599	-49.0
900	0.520	-92.5	15.89	111.6	0.0421	51.5	0.555	-51.9
1000	0.488	-99.7	14.78	107.4	0.0455	50.0	0.515	-54.5
1100	0.463	-106.3	13.78	103.6	0.0473	48.3	0.479	-56.7
1200	0.440	-112.9	12.91	100.0	0.0497	47.8	0.448	-58.7
1300	0.422	-118.8	12.09	96.8	0.0508	48.2	0.419	-60.6
1400	0.407	-124.6	11.38	93.8	0.0532	48.1	0.392	-62.4
1500	0.394	-130.2	10.74	91.0	0.0551	46.4	0.370	-64.1
1600	0.383	-135.6	10.15	88.3	0.0571	46.1	0.348	-65.5
1700	0.376	-140.5	9.62	85.8	0.0590	45.6	0.328	-67.2
1800	0.369	-145.5	9.14	83.4	0.0611	44.5	0.310	-68.6
1900	0.365	-150.2	8.70	81.1	0.0623	44.7	0.294	-70.2
2000	0.362	-154.7	8.30	78.9	0.0651	44.5	0.278	-71.7
2200	0.358	-162.9	7.59	74.7	0.0693	43.7	0.251	-75.0
2400	0.358	-170.6	6.99	70.6	0.0726	43.0	0.227	-78.5
2600	0.361	-177.6	6.47	66.8	0.0761	41.7	0.204	-82.4
2800	0.364	175.8	6.03	63.2	0.0808	41.0	0.185	-86.5
3000	0.370	170.1	5.63	59.7	0.0839	39.8	0.167	-91.1
3200	0.378	164.5	5.28	56.2	0.0891	38.4	0.153	-96.7
3400	0.385	159.4	4.97	52.9	0.0922	37.7	0.139	-102.4
3600	0.392	154.7	4.68	49.7	0.0959	36.5	0.126	-108.5
3800	0.399	150.6	4.43	46.6	0.1004	35.5	0.116	-114.8
4000	0.408	146.6	4.21	43.5	0.1057	34.3	0.110	-123.1
4200	0.417	142.7	4.01	40.4	0.1097	32.7	0.105	-131.3
4400	0.426	139.3	3.83	37.3	0.1140	31.0	0.101	-140.6
4600	0.435	135.7	3.66	34.3	0.1178	29.8	0.099	-149.3
4800	0.444	132.3	3.50	31.3	0.1217	27.8	0.099	-158.9
5000	0.452	128.9	3.36	28.3	0.1256	26.5	0.099	-167.4
5200	0.460	125.8	3.23	25.4	0.1297	24.8	0.103	-176.8
5400	0.468	122.6	3.10	22.4	0.1343	22.7	0.107	174.9
5600	0.477	119.6	2.99	19.5	0.1374	21.6	0.113	167.2
5800	0.484	116.6	2.88	16.5	0.1412	19.3	0.118	160.3
6000	0.494	113.5	2.78	13.6	0.1450	17.8	0.126	153.8

Sパラメータ

(V_{CE} = 1 V, I_C = 20 mA, Z_O = 50 Ω)

f (MHz)	S11		S21		S12		S22	
	MAG	ANG	MAG	ANG	MAG	ANG	MAG	ANG
100	0.724	-21.2	39.39	163.6	0.0058	54.8	0.900	-13.4
200	0.671	-40.3	38.06	149.5	0.0099	67.2	0.861	-25.1
300	0.606	-56.4	35.19	137.6	0.0171	58.2	0.764	-34.1
400	0.546	-70.5	31.79	128.1	0.0220	65.1	0.677	-40.8
500	0.490	-82.9	28.32	120.2	0.0236	61.1	0.600	-46.1
600	0.445	-93.5	25.27	113.9	0.0276	58.5	0.533	-50.0
700	0.410	-102.7	22.61	108.7	0.0299	55.2	0.477	-52.9
800	0.381	-111.1	20.40	104.2	0.0316	56.7	0.432	-55.4
900	0.361	-118.9	18.56	100.4	0.0341	54.9	0.395	-57.4
1000	0.344	-125.9	16.96	97.0	0.0367	55.2	0.363	-58.8
1100	0.331	-132.3	15.60	93.8	0.0384	53.9	0.335	-60.2
1200	0.321	-138.6	14.44	91.0	0.0415	54.2	0.310	-61.6
1300	0.313	-144.1	13.41	88.4	0.0434	55.0	0.289	-62.9
1400	0.308	-149.4	12.52	86.0	0.0454	55.4	0.270	-64.1
1500	0.305	-154.4	11.74	83.7	0.0481	54.7	0.253	-65.2
1600	0.303	-159.3	11.04	81.5	0.0506	54.5	0.238	-66.2
1700	0.302	-163.4	10.42	79.4	0.0531	54.0	0.224	-67.7
1800	0.303	-167.6	9.87	77.4	0.0552	53.9	0.211	-69.0
1900	0.303	-171.3	9.36	75.4	0.0575	53.8	0.199	-70.4
2000	0.305	-175.1	8.91	73.6	0.0596	53.1	0.187	-72.0
2200	0.311	178.3	8.12	69.9	0.0655	52.3	0.167	-75.6
2400	0.318	172.2	7.45	66.4	0.0700	50.7	0.149	-79.4
2600	0.325	166.9	6.88	63.1	0.0749	50.0	0.132	-84.7
2800	0.334	161.7	6.39	59.8	0.0803	48.5	0.118	-90.1
3000	0.343	157.0	5.96	56.7	0.0849	47.2	0.105	-96.3
3200	0.354	152.8	5.59	53.5	0.0892	45.8	0.094	-105.2
3400	0.363	148.6	5.25	50.4	0.0939	44.3	0.084	-114.0
3600	0.372	144.8	4.95	47.5	0.0984	42.5	0.076	-124.4
3800	0.379	141.6	4.69	44.7	0.1034	41.4	0.073	-134.2
4000	0.389	138.3	4.45	41.8	0.1087	39.5	0.073	-146.5
4200	0.400	135.2	4.23	38.8	0.1138	37.8	0.074	-158.7
4400	0.410	132.1	4.04	36.0	0.1174	35.7	0.077	-169.5
4600	0.419	129.0	3.86	33.1	0.1223	33.8	0.083	-179.9
4800	0.428	126.1	3.69	30.3	0.1269	32.3	0.089	171.8
5000	0.437	123.3	3.54	27.5	0.1304	30.4	0.096	163.6
5200	0.446	120.5	3.40	24.6	0.1354	28.3	0.104	156.8
5400	0.455	117.8	3.27	21.8	0.1396	26.5	0.113	150.6
5600	0.464	115.1	3.15	19.0	0.1435	24.5	0.122	145.1
5800	0.471	112.3	3.04	16.2	0.1479	22.4	0.132	139.9
6000	0.482	109.7	2.93	13.3	0.1516	20.3	0.141	135.1

Sパラメータ

(V_{CE} = 1 V, I_C = 30 mA, Z_O = 50 Ω)

f (MHz)	S11		S21		S12		S22	
	MAG	ANG	MAG	ANG	MAG	ANG	MAG	ANG
100	0.588	-30.4	44.10	160.5	0.0066	96.2	0.826	-17.7
200	0.537	-55.8	41.51	143.8	0.0122	73.0	0.768	-29.9
300	0.478	-76.3	37.20	130.6	0.0181	64.3	0.658	-39.1
400	0.431	-92.4	32.78	120.8	0.0193	59.8	0.561	-45.3
500	0.395	-105.9	28.61	113.2	0.0226	54.6	0.486	-49.6
600	0.368	-116.5	25.25	107.5	0.0244	60.0	0.429	-52.4
700	0.348	-125.5	22.39	102.9	0.0268	58.2	0.381	-54.6
800	0.332	-133.4	20.12	98.9	0.0294	57.7	0.345	-56.1
900	0.322	-139.9	18.26	95.4	0.0317	56.3	0.313	-57.5
1000	0.315	-146.4	16.60	92.4	0.0342	58.0	0.287	-58.4
1100	0.310	-152.2	15.24	89.6	0.0358	57.6	0.266	-59.1
1200	0.307	-157.5	14.08	87.1	0.0384	57.4	0.245	-60.3
1300	0.304	-162.0	13.06	84.8	0.0409	57.9	0.229	-61.1
1400	0.304	-166.4	12.18	82.6	0.0444	59.2	0.214	-62.0
1500	0.305	-170.6	11.41	80.5	0.0473	58.7	0.200	-62.9
1600	0.306	-174.2	10.73	78.4	0.0497	57.8	0.188	-63.9
1700	0.309	-177.8	10.11	76.5	0.0515	57.9	0.177	-65.3
1800	0.312	178.9	9.57	74.6	0.0541	57.9	0.166	-66.3
1900	0.313	175.8	9.07	72.8	0.0574	57.6	0.156	-67.8
2000	0.318	173.0	8.63	71.1	0.0597	57.0	0.147	-69.7
2200	0.325	167.5	7.86	67.6	0.0651	55.7	0.130	-73.2
2400	0.334	162.8	7.21	64.3	0.0703	54.2	0.114	-77.6
2600	0.343	158.0	6.65	61.1	0.0752	52.9	0.099	-83.9
2800	0.353	153.8	6.18	58.0	0.0801	51.5	0.087	-90.2
3000	0.363	150.1	5.76	54.9	0.0852	49.6	0.076	-98.8
3200	0.374	146.4	5.40	51.9	0.0899	48.1	0.067	-110.3
3400	0.384	142.8	5.07	48.8	0.0946	46.6	0.060	-122.9
3600	0.392	139.4	4.78	46.0	0.1001	44.4	0.055	-137.4
3800	0.401	136.5	4.52	43.2	0.1047	43.2	0.057	-150.1
4000	0.411	133.6	4.30	40.4	0.1098	40.9	0.060	-163.7
4200	0.420	130.8	4.09	37.5	0.1144	39.3	0.065	-175.8
4400	0.430	128.0	3.90	34.6	0.1192	36.9	0.073	173.8
4600	0.440	125.2	3.73	31.9	0.1240	35.3	0.080	165.4
4800	0.448	122.6	3.56	29.1	0.1291	33.3	0.089	158.0
5000	0.457	119.9	3.42	26.2	0.1333	31.5	0.099	152.1
5200	0.467	117.3	3.28	23.5	0.1378	29.4	0.108	146.1
5400	0.474	114.7	3.15	20.7	0.1414	27.3	0.118	140.9
5600	0.483	112.1	3.04	17.9	0.1454	25.4	0.128	136.6
5800	0.491	109.5	2.93	15.1	0.1494	23.0	0.138	132.2
6000	0.499	106.9	2.82	12.3	0.1536	20.9	0.149	128.3

Sパラメータ

(V_{CE} = 2 V, I_C = 1 mA, Z_O = 50 Ω)

f (MHz)	S11		S21		S12		S22	
	MAG	ANG	MAG	ANG	MAG	ANG	MAG	ANG
100	0.980	-4.5	3.19	176.0	0.0053	145.2	0.992	-2.6
200	0.982	-8.6	3.19	171.9	0.0131	84.4	0.997	-4.8
300	0.976	-12.7	3.18	168.2	0.0223	86.1	0.991	-7.0
400	0.973	-17.4	3.18	164.7	0.0286	77.8	0.982	-9.4
500	0.967	-21.7	3.18	161.1	0.0348	76.2	0.977	-11.6
600	0.961	-26.1	3.17	157.8	0.0407	72.9	0.968	-13.8
700	0.956	-30.4	3.13	154.2	0.0472	69.5	0.958	-16.0
800	0.947	-34.6	3.11	150.7	0.0533	66.0	0.947	-18.2
900	0.940	-39.2	3.13	148.2	0.0603	63.6	0.935	-20.3
1000	0.929	-43.6	3.11	144.1	0.0651	60.6	0.921	-22.4
1100	0.919	-48.0	3.08	140.8	0.0709	57.1	0.909	-24.4
1200	0.908	-52.5	3.08	136.9	0.0758	55.3	0.896	-26.4
1300	0.896	-56.7	3.03	133.6	0.0810	52.1	0.881	-28.3
1400	0.886	-61.2	3.00	130.5	0.0856	50.4	0.868	-30.3
1500	0.873	-65.7	2.98	127.2	0.0900	46.4	0.853	-32.3
1600	0.860	-70.3	2.97	123.8	0.0939	44.5	0.838	-34.1
1700	0.848	-74.7	2.93	120.6	0.0981	42.1	0.823	-36.0
1800	0.836	-79.1	2.88	117.4	0.1013	39.6	0.807	-37.8
1900	0.824	-83.6	2.84	114.3	0.1047	36.9	0.793	-39.6
2000	0.812	-88.2	2.81	111.2	0.1072	34.2	0.778	-41.4
2200	0.789	-96.9	2.72	105.0	0.1128	29.9	0.748	-44.9
2400	0.767	-105.7	2.65	99.0	0.1153	25.5	0.718	-48.2
2600	0.747	-114.3	2.57	93.1	0.1182	21.2	0.688	-51.5
2800	0.728	-122.9	2.49	87.5	0.1201	17.3	0.662	-54.8
3000	0.712	-131.2	2.40	81.9	0.1213	13.6	0.637	-57.8
3200	0.698	-139.1	2.31	76.5	0.1211	10.3	0.613	-61.0
3400	0.687	-146.9	2.23	71.3	0.1203	7.1	0.591	-64.1
3600	0.677	-154.3	2.14	66.4	0.1183	4.1	0.569	-67.1
3800	0.670	-161.2	2.07	61.6	0.1155	1.3	0.550	-70.1
4000	0.666	-168.1	1.99	56.9	0.1151	-0.5	0.534	-73.3
4200	0.662	-174.7	1.93	52.4	0.1129	-2.4	0.517	-76.5
4400	0.661	179.1	1.85	47.9	0.1102	-4.1	0.503	-79.8
4600	0.660	173.1	1.79	43.6	0.1075	-5.5	0.489	-83.1
4800	0.660	167.5	1.73	39.3	0.1055	-6.3	0.477	-86.4
5000	0.660	162.0	1.67	35.2	0.1021	-7.1	0.465	-89.8
5200	0.662	156.7	1.62	31.1	0.1002	-7.8	0.453	-93.4
5400	0.665	151.7	1.56	27.2	0.0982	-8.2	0.443	-97.1
5600	0.667	146.9	1.51	23.3	0.0949	-7.7	0.434	-101.1
5800	0.669	142.1	1.46	19.4	0.0937	-7.5	0.425	-105.0
6000	0.672	137.6	1.41	15.6	0.0927	-6.8	0.415	-108.9

Sパラメータ

(V_{CE} = 2 V, I_C = 3 mA, Z_O = 50 Ω)

f (MHz)	S11		S21		S12		S22	
	MAG	ANG	MAG	ANG	MAG	ANG	MAG	ANG
100	0.954	-6.5	9.14	174.1	0.0059	97.1	0.982	-3.9
200	0.945	-12.6	9.10	168.5	0.0121	90.7	0.989	-7.5
300	0.933	-18.5	8.98	163.3	0.0195	78.2	0.977	-11.1
400	0.922	-24.8	8.87	158.2	0.0267	76.4	0.959	-14.5
500	0.905	-31.1	8.76	153.4	0.0332	70.5	0.942	-18.0
600	0.886	-37.1	8.61	148.8	0.0388	66.7	0.921	-21.2
700	0.868	-42.8	8.37	144.3	0.0435	63.3	0.898	-24.5
800	0.845	-48.6	8.18	139.9	0.0481	59.5	0.873	-27.4
900	0.825	-54.8	8.09	136.1	0.0522	56.1	0.846	-30.1
1000	0.800	-60.4	7.88	131.6	0.0571	54.0	0.818	-32.8
1100	0.778	-65.9	7.67	127.6	0.0597	50.5	0.794	-35.2
1200	0.752	-71.7	7.51	123.3	0.0642	49.3	0.767	-37.6
1300	0.729	-77.0	7.27	119.6	0.0664	46.6	0.741	-39.9
1400	0.709	-82.3	7.04	116.1	0.0697	44.6	0.715	-42.0
1500	0.686	-87.7	6.85	112.5	0.0715	42.0	0.691	-44.0
1600	0.663	-92.9	6.66	109.0	0.0739	39.4	0.667	-45.8
1700	0.645	-98.0	6.45	105.7	0.0760	38.3	0.644	-47.7
1800	0.627	-102.9	6.25	102.6	0.0779	36.6	0.621	-49.4
1900	0.611	-107.8	6.06	99.5	0.0791	35.2	0.601	-51.1
2000	0.596	-112.9	5.87	96.5	0.0805	33.9	0.580	-52.8
2200	0.569	-122.0	5.51	90.9	0.0825	30.5	0.543	-55.8
2400	0.547	-131.2	5.20	85.5	0.0847	28.8	0.508	-58.7
2600	0.529	-139.8	4.90	80.4	0.0862	26.5	0.475	-61.7
2800	0.516	-148.1	4.62	75.6	0.0866	25.0	0.449	-64.3
3000	0.506	-155.9	4.37	70.9	0.0883	23.0	0.423	-67.0
3200	0.502	-163.3	4.13	66.5	0.0901	22.1	0.399	-69.8
3400	0.497	-170.4	3.92	62.2	0.0903	20.5	0.379	-72.6
3600	0.494	-176.9	3.72	58.2	0.0913	20.2	0.358	-75.2
3800	0.494	177.0	3.54	54.3	0.0921	19.5	0.341	-77.9
4000	0.497	171.2	3.38	50.5	0.0939	19.1	0.327	-81.2
4200	0.500	165.7	3.23	46.7	0.0948	18.3	0.312	-84.2
4400	0.504	160.5	3.09	43.0	0.0963	17.8	0.298	-87.7
4600	0.508	155.7	2.97	39.4	0.0980	17.3	0.286	-91.1
4800	0.513	151.1	2.85	35.9	0.1005	16.7	0.275	-94.6
5000	0.518	146.5	2.74	32.4	0.1016	16.0	0.264	-98.4
5200	0.525	142.1	2.64	28.9	0.1030	15.3	0.253	-102.4
5400	0.530	138.1	2.54	25.5	0.1054	15.0	0.245	-106.6
5600	0.536	134.1	2.45	22.1	0.1074	14.3	0.235	-110.8
5800	0.541	130.2	2.36	18.8	0.1098	13.3	0.228	-115.5
6000	0.548	126.4	2.29	15.5	0.1123	12.7	0.220	-120.3

Sパラメータ

(V_{CE} = 2 V, I_C = 5 mA, Z_O = 50 Ω)

f (MHz)	S11		S21		S12		S22	
	MAG	ANG	MAG	ANG	MAG	ANG	MAG	ANG
100	0.924	-8.2	14.62	172.4	0.0099	95.9	0.974	-5.4
200	0.914	-15.8	14.43	165.5	0.0130	75.7	0.980	-9.9
300	0.891	-23.5	14.11	159.0	0.0191	79.3	0.959	-14.4
400	0.869	-31.3	13.76	152.9	0.0260	72.2	0.932	-18.9
500	0.841	-38.8	13.40	147.2	0.0304	66.8	0.901	-23.1
600	0.812	-46.1	12.99	141.7	0.0359	62.2	0.867	-26.9
700	0.782	-52.8	12.44	136.6	0.0401	59.6	0.831	-30.6
800	0.750	-59.6	12.00	131.6	0.0438	55.7	0.794	-33.8
900	0.718	-66.7	11.63	127.1	0.0465	55.1	0.758	-36.6
1000	0.686	-73.0	11.14	122.5	0.0499	52.2	0.723	-39.3
1100	0.657	-79.0	10.66	118.4	0.0521	48.3	0.692	-41.7
1200	0.626	-85.3	10.25	114.2	0.0552	46.8	0.659	-44.0
1300	0.600	-91.0	9.79	110.4	0.0572	45.4	0.630	-46.0
1400	0.577	-96.5	9.36	106.9	0.0596	44.0	0.603	-48.0
1500	0.555	-102.0	8.98	103.6	0.0606	42.4	0.576	-49.8
1600	0.534	-107.4	8.61	100.3	0.0624	41.6	0.551	-51.3
1700	0.516	-112.6	8.25	97.3	0.0644	39.9	0.527	-52.9
1800	0.501	-117.6	7.91	94.4	0.0661	38.9	0.506	-54.3
1900	0.487	-122.6	7.60	91.6	0.0664	37.9	0.486	-55.8
2000	0.474	-127.4	7.31	88.9	0.0684	36.9	0.467	-57.2
2200	0.455	-136.6	6.77	83.8	0.0711	35.6	0.432	-59.8
2400	0.441	-145.5	6.29	79.0	0.0732	34.7	0.402	-62.3
2600	0.430	-153.9	5.88	74.5	0.0753	33.4	0.374	-64.9
2800	0.424	-161.7	5.51	70.3	0.0783	32.9	0.349	-67.4
3000	0.422	-169.0	5.17	66.2	0.0802	31.6	0.326	-70.0
3200	0.422	-175.9	4.87	62.2	0.0825	30.7	0.306	-72.8
3400	0.423	177.7	4.60	58.4	0.0853	30.1	0.286	-75.7
3600	0.424	171.7	4.35	54.7	0.0875	29.6	0.269	-78.2
3800	0.427	166.5	4.13	51.3	0.0892	29.2	0.253	-81.2
4000	0.434	161.3	3.93	47.8	0.0927	28.5	0.241	-84.6
4200	0.440	156.4	3.75	44.4	0.0957	27.7	0.228	-88.4
4400	0.446	151.9	3.58	41.0	0.0985	26.9	0.216	-92.3
4600	0.454	147.6	3.43	37.7	0.1015	25.8	0.205	-96.1
4800	0.460	143.5	3.29	34.4	0.1047	24.6	0.195	-100.3
5000	0.467	139.3	3.16	31.2	0.1073	23.6	0.185	-104.8
5200	0.475	135.6	3.04	28.0	0.1102	22.8	0.176	-109.6
5400	0.481	131.9	2.93	24.8	0.1138	21.3	0.168	-114.9
5600	0.489	128.3	2.82	21.7	0.1171	20.5	0.161	-120.1
5800	0.497	124.7	2.72	18.5	0.1201	18.8	0.154	-125.8
6000	0.504	121.4	2.63	15.4	0.1242	17.9	0.148	-132.1

S パラメータ

(V_{CE} = 2 V, I_C = 7 mA, Z_O = 50 Ω)

f (MHz)	S11		S21		S12		S22	
	MAG	ANG	MAG	ANG	MAG	ANG	MAG	ANG
100	0.901	-9.8	19.67	171.0	0.0075	50.0	0.966	-6.2
200	0.883	-19.0	19.27	162.8	0.0114	75.2	0.970	-12.1
300	0.852	-28.0	18.64	155.3	0.0193	82.6	0.938	-17.6
400	0.820	-37.0	17.96	148.4	0.0251	69.8	0.899	-22.6
500	0.781	-45.6	17.26	141.9	0.0286	65.2	0.857	-27.2
600	0.742	-53.8	16.48	136.0	0.0341	60.3	0.813	-31.3
700	0.704	-61.3	15.59	130.5	0.0378	58.1	0.768	-35.0
800	0.666	-68.6	14.80	125.2	0.0396	54.8	0.724	-38.2
900	0.629	-76.1	14.10	120.5	0.0423	53.5	0.685	-40.9
1000	0.594	-82.6	13.33	116.0	0.0444	50.4	0.647	-43.3
1100	0.564	-89.0	12.60	111.9	0.0472	48.8	0.613	-45.6
1200	0.534	-95.2	11.96	107.9	0.0484	48.1	0.580	-47.5
1300	0.509	-101.1	11.32	104.3	0.0508	47.4	0.550	-49.4
1400	0.488	-106.8	10.73	101.1	0.0535	46.3	0.523	-50.9
1500	0.468	-112.4	10.21	97.9	0.0552	44.9	0.498	-52.5
1600	0.450	-117.7	9.72	94.9	0.0563	43.9	0.475	-53.8
1700	0.436	-122.9	9.26	92.1	0.0588	42.7	0.453	-55.2
1800	0.424	-127.9	8.84	89.5	0.0592	42.4	0.434	-56.5
1900	0.412	-132.8	8.45	86.9	0.0610	42.0	0.415	-57.7
2000	0.403	-137.6	8.08	84.5	0.0621	41.7	0.398	-58.8
2200	0.390	-146.5	7.44	79.8	0.0653	40.7	0.367	-61.3
2400	0.382	-155.1	6.89	75.4	0.0682	39.9	0.339	-63.6
2600	0.377	-163.0	6.40	71.3	0.0720	39.3	0.314	-66.1
2800	0.376	-170.4	5.98	67.4	0.0751	38.4	0.292	-68.5
3000	0.377	-177.3	5.60	63.6	0.0784	37.0	0.272	-71.2
3200	0.381	176.4	5.26	59.9	0.0808	36.7	0.254	-74.0
3400	0.385	170.3	4.96	56.3	0.0838	35.7	0.236	-77.0
3600	0.389	164.7	4.68	52.9	0.0873	34.8	0.220	-79.8
3800	0.394	160.0	4.44	49.7	0.0905	34.6	0.207	-83.0
4000	0.402	155.4	4.23	46.4	0.0944	33.4	0.194	-86.9
4200	0.409	150.9	4.03	43.1	0.0979	32.2	0.183	-91.1
4400	0.418	146.7	3.85	39.9	0.1016	31.2	0.172	-95.5
4600	0.426	142.7	3.68	36.8	0.1050	29.7	0.163	-100.3
4800	0.433	138.9	3.53	33.7	0.1081	28.6	0.153	-105.0
5000	0.441	135.2	3.39	30.6	0.1117	27.1	0.144	-110.4
5200	0.450	131.6	3.26	27.5	0.1150	25.6	0.136	-116.6
5400	0.456	128.3	3.14	24.4	0.1194	24.3	0.129	-122.8
5600	0.465	124.9	3.02	21.4	0.1222	22.7	0.124	-129.4
5800	0.473	121.7	2.92	18.4	0.1262	21.4	0.119	-137.0
6000	0.481	118.5	2.82	15.4	0.1301	20.3	0.115	-144.6

Sパラメータ

(V_{CE} = 2 V, I_C = 10 mA, Z_O = 50 Ω)

f (MHz)	S11		S21		S12		S22	
	MAG	ANG	MAG	ANG	MAG	ANG	MAG	ANG
100	0.871	-11.8	26.57	169.1	0.0044	49.5	0.961	-7.8
200	0.837	-23.4	25.71	159.4	0.0127	77.4	0.953	-14.8
300	0.793	-34.2	24.48	150.6	0.0170	74.2	0.906	-21.3
400	0.749	-44.4	23.16	142.8	0.0219	67.3	0.850	-27.0
500	0.698	-54.1	21.80	135.6	0.0265	63.8	0.797	-31.9
600	0.650	-63.4	20.39	129.1	0.0297	59.2	0.743	-35.9
700	0.607	-71.5	18.95	123.4	0.0333	56.8	0.689	-39.5
800	0.564	-79.4	17.66	118.1	0.0359	54.1	0.642	-42.3
900	0.527	-86.9	16.50	113.5	0.0373	52.8	0.600	-44.7
1000	0.494	-93.6	15.39	109.2	0.0405	51.4	0.563	-46.9
1100	0.467	-100.2	14.38	105.4	0.0416	50.1	0.529	-48.6
1200	0.441	-106.5	13.49	101.8	0.0433	49.7	0.498	-50.2
1300	0.419	-112.2	12.66	98.5	0.0452	48.3	0.470	-51.7
1400	0.402	-117.9	11.92	95.5	0.0483	48.4	0.446	-52.9
1500	0.386	-123.6	11.26	92.7	0.0497	48.8	0.423	-54.2
1600	0.374	-129.0	10.66	90.0	0.0514	48.6	0.402	-55.2
1700	0.364	-133.8	10.11	87.5	0.0530	47.3	0.384	-56.3
1800	0.356	-138.9	9.61	85.0	0.0546	47.2	0.366	-57.2
1900	0.348	-143.6	9.16	82.7	0.0569	46.8	0.350	-58.4
2000	0.343	-148.3	8.74	80.5	0.0582	46.7	0.335	-59.4
2200	0.337	-157.0	8.01	76.3	0.0617	45.8	0.308	-61.5
2400	0.334	-165.1	7.38	72.3	0.0652	45.9	0.285	-63.7
2600	0.335	-172.4	6.84	68.5	0.0698	44.1	0.262	-66.2
2800	0.338	-179.4	6.37	64.9	0.0730	43.6	0.242	-68.7
3000	0.342	174.5	5.96	61.3	0.0772	42.9	0.225	-71.3
3200	0.349	168.6	5.59	57.9	0.0801	42.0	0.209	-74.6
3400	0.354	163.2	5.27	54.5	0.0840	41.1	0.192	-77.9
3600	0.361	158.2	4.97	51.3	0.0885	39.4	0.177	-81.0
3800	0.367	153.9	4.71	48.3	0.0918	38.7	0.167	-84.4
4000	0.377	149.7	4.48	45.2	0.0962	37.8	0.155	-89.2
4200	0.386	145.7	4.27	42.1	0.1007	36.1	0.144	-93.9
4400	0.394	141.9	4.08	39.0	0.1038	34.8	0.134	-99.2
4600	0.404	138.3	3.90	36.0	0.1081	33.1	0.126	-104.9
4800	0.411	134.8	3.74	33.1	0.1119	31.5	0.118	-111.4
5000	0.420	131.3	3.59	30.1	0.1163	30.4	0.111	-117.9
5200	0.429	128.1	3.45	27.1	0.1196	28.7	0.105	-125.8
5400	0.437	125.0	3.32	24.1	0.1237	26.9	0.100	-134.2
5600	0.446	121.8	3.20	21.2	0.1275	25.5	0.096	-142.6
5800	0.454	118.8	3.09	18.3	0.1307	23.7	0.094	-151.2
6000	0.462	115.8	2.98	15.4	0.1353	21.8	0.093	-161.0

Sパラメータ

(V_{CE} = 2 V, I_C = 20 mA, Z_O = 50 Ω)

f (MHz)	S11		S21		S12		S22	
	MAG	ANG	MAG	ANG	MAG	ANG	MAG	ANG
100	0.753	-17.6	44.57	164.4	0.0079	89.7	0.910	-12.2
200	0.704	-34.9	41.52	150.9	0.0118	75.1	0.889	-21.3
300	0.632	-49.8	37.55	139.5	0.0166	61.5	0.803	-29.2
400	0.566	-62.8	33.64	130.2	0.0182	64.8	0.722	-35.1
500	0.504	-74.4	29.99	122.4	0.0209	59.1	0.648	-39.5
600	0.454	-84.5	26.76	116.0	0.0243	59.2	0.586	-42.8
700	0.414	-93.5	24.00	110.8	0.0272	58.5	0.531	-45.0
800	0.380	-101.5	21.68	106.1	0.0288	57.4	0.489	-46.9
900	0.354	-109.2	19.71	102.2	0.0300	56.8	0.451	-48.3
1000	0.334	-116.2	18.05	98.7	0.0333	57.6	0.422	-49.4
1100	0.317	-122.9	16.62	95.6	0.0351	56.2	0.393	-50.2
1200	0.303	-128.9	15.39	92.7	0.0368	56.6	0.371	-50.9
1300	0.293	-134.7	14.30	90.0	0.0392	56.9	0.349	-51.8
1400	0.284	-140.4	13.36	87.6	0.0415	56.9	0.331	-52.4
1500	0.278	-145.7	12.53	85.3	0.0438	55.5	0.315	-53.2
1600	0.275	-150.7	11.79	83.0	0.0456	56.2	0.299	-53.6
1700	0.272	-155.3	11.13	80.9	0.0488	55.3	0.284	-54.5
1800	0.270	-160.1	10.55	78.9	0.0505	55.5	0.273	-55.2
1900	0.270	-164.0	10.01	77.0	0.0529	56.5	0.261	-56.0
2000	0.271	-168.2	9.53	75.1	0.0545	55.1	0.250	-56.9
2200	0.274	-175.6	8.69	71.5	0.0595	54.6	0.230	-58.8
2400	0.279	177.7	7.99	68.0	0.0638	53.3	0.212	-60.9
2600	0.286	171.8	7.38	64.7	0.0682	52.1	0.193	-63.5
2800	0.294	166.0	6.86	61.5	0.0731	51.2	0.178	-66.0
3000	0.303	161.1	6.41	58.3	0.0780	49.4	0.163	-68.9
3200	0.312	156.3	6.01	55.2	0.0820	48.9	0.149	-73.0
3400	0.321	151.9	5.65	52.1	0.0863	46.9	0.135	-76.7
3600	0.329	147.8	5.33	49.2	0.0907	45.3	0.122	-80.9
3800	0.338	144.3	5.05	46.4	0.0953	44.1	0.113	-85.6
4000	0.348	141.0	4.80	43.5	0.1004	42.3	0.103	-92.1
4200	0.358	137.7	4.57	40.6	0.1049	40.5	0.095	-98.6
4400	0.368	134.4	4.36	37.8	0.1096	39.0	0.086	-106.7
4600	0.378	131.5	4.17	35.0	0.1131	37.5	0.080	-115.8
4800	0.387	128.5	4.00	32.2	0.1182	35.4	0.075	-125.7
5000	0.396	125.6	3.84	29.4	0.1222	33.8	0.071	-136.2
5200	0.406	122.7	3.69	26.5	0.1260	31.8	0.069	-147.9
5400	0.414	120.0	3.55	23.7	0.1298	29.8	0.070	-159.6
5600	0.423	117.3	3.42	20.9	0.1343	28.0	0.071	-170.8
5800	0.432	114.5	3.30	18.1	0.1383	25.6	0.076	178.9
6000	0.441	111.8	3.19	15.3	0.1425	24.0	0.081	169.0

Sパラメータ

(V_{CE} = 2 V, I_C = 30 mA, Z_O = 50 Ω)

f (MHz)	S11		S21		S12		S22	
	MAG	ANG	MAG	ANG	MAG	ANG	MAG	ANG
100	0.668	-23.8	55.36	161.1	0.0054	38.3	0.888	-13.4
200	0.593	-44.8	50.41	145.2	0.0092	69.0	0.835	-25.2
300	0.517	-61.8	43.97	132.6	0.0143	67.6	0.729	-33.2
400	0.450	-76.0	38.03	123.1	0.0166	66.3	0.636	-38.5
500	0.396	-88.4	32.96	115.7	0.0207	61.0	0.562	-42.4
600	0.357	-98.9	28.82	109.8	0.0212	63.2	0.505	-44.3
700	0.327	-108.1	25.49	105.1	0.0245	62.2	0.455	-45.9
800	0.305	-116.5	22.78	101.0	0.0263	59.2	0.419	-46.9
900	0.287	-124.3	20.56	97.5	0.0273	60.5	0.386	-47.8
1000	0.274	-130.9	18.71	94.4	0.0303	59.6	0.361	-48.2
1100	0.265	-137.4	17.15	91.6	0.0332	60.9	0.338	-48.8
1200	0.258	-143.5	15.82	89.1	0.0348	61.2	0.319	-49.1
1300	0.253	-148.9	14.67	86.7	0.0376	61.8	0.302	-49.4
1400	0.250	-154.2	13.68	84.4	0.0398	61.3	0.288	-49.9
1500	0.249	-159.3	12.80	82.4	0.0424	60.2	0.273	-50.6
1600	0.248	-163.6	12.03	80.3	0.0450	61.6	0.261	-50.9
1700	0.248	-167.8	11.34	78.4	0.0478	60.5	0.249	-51.7
1800	0.251	-171.8	10.74	76.5	0.0494	59.7	0.239	-52.0
1900	0.252	-175.4	10.19	74.7	0.0520	59.5	0.229	-53.1
2000	0.255	-179.0	9.68	73.0	0.0542	59.2	0.219	-53.8
2200	0.261	174.9	8.82	69.6	0.0589	58.1	0.202	-55.7
2400	0.270	168.9	8.10	66.3	0.0636	56.6	0.185	-57.8
2600	0.278	164.0	7.48	63.1	0.0686	55.0	0.169	-60.4
2800	0.288	159.0	6.95	60.1	0.0740	53.8	0.155	-63.2
3000	0.298	154.6	6.49	57.1	0.0780	52.3	0.140	-66.1
3200	0.308	150.6	6.08	54.1	0.0830	50.7	0.128	-70.6
3400	0.318	146.6	5.72	51.1	0.0876	49.0	0.115	-74.8
3600	0.327	143.1	5.39	48.3	0.0916	47.6	0.102	-79.2
3800	0.335	140.0	5.11	45.6	0.0967	46.2	0.093	-85.0
4000	0.346	137.0	4.86	42.8	0.1021	43.8	0.085	-91.8
4200	0.356	134.1	4.63	40.0	0.1061	42.4	0.076	-100.0
4400	0.367	131.1	4.42	37.2	0.1113	40.5	0.069	-109.6
4600	0.376	128.5	4.22	34.4	0.1156	38.4	0.064	-121.1
4800	0.385	125.6	4.04	31.6	0.1199	36.8	0.060	-133.1
5000	0.395	123.0	3.88	28.9	0.1241	34.9	0.059	-145.8
5200	0.404	120.3	3.73	26.1	0.1281	32.9	0.060	-160.3
5400	0.413	117.6	3.59	23.3	0.1326	30.8	0.063	-172.0
5600	0.422	115.1	3.46	20.6	0.1371	29.0	0.068	177.0
5800	0.431	112.5	3.34	17.8	0.1413	26.7	0.073	166.5
6000	0.440	109.9	3.22	15.0	0.1450	24.8	0.081	157.5

Sパラメータ

(V_{CE} = 3 V, I_C = 1 mA, Z_O = 50 Ω)

f (MHz)	S11		S21		S12		S22	
	MAG	ANG	MAG	ANG	MAG	ANG	MAG	ANG
100	0.983	-4.2	3.17	176.2	0.0081	61.2	0.989	-2.2
200	0.981	-8.6	3.17	172.0	0.0107	87.9	0.997	-4.6
300	0.978	-12.4	3.17	168.4	0.0209	80.5	0.990	-6.8
400	0.975	-17.2	3.17	164.9	0.0263	78.1	0.984	-9.0
500	0.969	-21.6	3.18	161.4	0.0324	77.0	0.978	-11.2
600	0.962	-25.7	3.17	158.1	0.0396	71.9	0.971	-13.3
700	0.957	-30.0	3.12	154.6	0.0460	68.5	0.961	-15.5
800	0.949	-34.3	3.10	151.1	0.0510	67.0	0.950	-17.6
900	0.942	-38.8	3.13	148.5	0.0564	63.7	0.939	-19.6
1000	0.931	-43.1	3.11	144.5	0.0625	60.8	0.927	-21.5
1100	0.922	-47.5	3.08	141.2	0.0668	57.8	0.916	-23.5
1200	0.910	-52.0	3.08	137.4	0.0722	55.3	0.903	-25.5
1300	0.899	-56.2	3.04	134.1	0.0769	53.2	0.889	-27.4
1400	0.888	-60.6	3.00	131.0	0.0820	50.4	0.875	-29.4
1500	0.876	-65.1	2.99	127.7	0.0858	47.0	0.862	-31.3
1600	0.863	-69.6	2.97	124.4	0.0898	45.0	0.847	-33.0
1700	0.852	-74.0	2.94	121.2	0.0934	42.1	0.834	-34.8
1800	0.839	-78.5	2.89	118.0	0.0973	39.5	0.818	-36.6
1900	0.827	-82.8	2.85	114.9	0.0998	37.6	0.803	-38.4
2000	0.815	-87.5	2.82	111.8	0.1029	35.5	0.788	-40.2
2200	0.792	-96.0	2.74	105.6	0.1073	30.8	0.760	-43.6
2400	0.769	-104.8	2.67	99.6	0.1109	25.9	0.731	-46.8
2600	0.749	-113.5	2.58	93.8	0.1138	21.6	0.702	-50.0
2800	0.730	-122.0	2.50	88.2	0.1149	18.1	0.676	-53.1
3000	0.713	-130.2	2.42	82.5	0.1159	14.3	0.651	-56.1
3200	0.700	-138.2	2.33	77.2	0.1150	11.4	0.627	-59.2
3400	0.688	-146.0	2.25	72.1	0.1145	7.7	0.606	-62.2
3600	0.678	-153.4	2.16	67.1	0.1131	4.9	0.585	-65.2
3800	0.670	-160.4	2.09	62.4	0.1112	2.6	0.566	-68.1
4000	0.666	-167.2	2.01	57.6	0.1087	0.9	0.550	-71.2
4200	0.663	-173.9	1.95	53.1	0.1072	-1.1	0.534	-74.4
4400	0.661	179.9	1.88	48.6	0.1047	-3.1	0.519	-77.5
4600	0.659	173.9	1.81	44.3	0.1020	-3.7	0.506	-80.7
4800	0.659	168.2	1.75	40.1	0.1000	-5.3	0.494	-84.0
5000	0.659	162.6	1.69	35.9	0.0969	-5.5	0.482	-87.3
5200	0.661	157.3	1.64	31.8	0.0943	-5.8	0.470	-90.8
5400	0.663	152.3	1.58	28.0	0.0931	-6.3	0.461	-94.5
5600	0.666	147.4	1.53	24.1	0.0908	-5.6	0.451	-98.1
5800	0.668	142.7	1.48	20.2	0.0899	-5.3	0.442	-102.0
6000	0.670	138.1	1.43	16.4	0.0885	-4.0	0.433	-105.9

Sパラメータ

(V_{CE} = 3 V, I_C = 3 mA, Z_O = 50 Ω)

f (MHz)	S11		S21		S12		S22	
	MAG	ANG	MAG	ANG	MAG	ANG	MAG	ANG
100	0.956	-6.2	9.07	174.1	0.0084	118.4	0.979	-4.2
200	0.950	-12.3	9.03	168.7	0.0117	72.8	0.990	-7.3
300	0.936	-18.1	8.93	163.5	0.0190	74.0	0.977	-10.5
400	0.924	-24.5	8.83	158.5	0.0255	74.2	0.962	-13.9
500	0.909	-30.5	8.73	153.8	0.0317	68.2	0.946	-17.2
600	0.891	-36.5	8.59	149.2	0.0364	67.6	0.926	-20.3
700	0.872	-42.2	8.35	144.8	0.0420	64.2	0.903	-23.3
800	0.851	-47.9	8.18	140.4	0.0464	59.7	0.879	-26.3
900	0.830	-54.0	8.10	136.6	0.0492	57.5	0.853	-28.8
1000	0.806	-59.5	7.89	132.1	0.0545	54.1	0.827	-31.4
1100	0.783	-65.1	7.69	128.1	0.0574	52.0	0.803	-33.8
1200	0.757	-70.7	7.53	123.9	0.0614	48.7	0.778	-36.0
1300	0.734	-76.0	7.30	120.2	0.0642	47.0	0.752	-38.2
1400	0.713	-81.3	7.08	116.7	0.0673	44.7	0.728	-40.3
1500	0.690	-86.6	6.89	113.1	0.0693	42.4	0.704	-42.3
1600	0.668	-91.8	6.71	109.6	0.0709	40.2	0.680	-44.0
1700	0.649	-96.7	6.50	106.3	0.0732	38.7	0.658	-45.8
1800	0.630	-101.7	6.29	103.2	0.0745	37.1	0.636	-47.4
1900	0.614	-106.7	6.11	100.1	0.0756	35.2	0.616	-49.1
2000	0.598	-111.6	5.93	97.1	0.0770	34.2	0.596	-50.7
2200	0.571	-120.8	5.57	91.5	0.0788	31.8	0.560	-53.5
2400	0.547	-129.8	5.25	86.0	0.0809	29.2	0.525	-56.2
2600	0.529	-138.4	4.95	81.0	0.0828	27.2	0.494	-59.0
2800	0.515	-146.9	4.68	76.2	0.0845	25.3	0.466	-61.5
3000	0.506	-154.7	4.42	71.5	0.0857	24.3	0.442	-64.0
3200	0.499	-162.1	4.18	67.1	0.0855	22.9	0.419	-66.8
3400	0.494	-169.2	3.97	62.8	0.0871	21.6	0.398	-69.5
3600	0.491	-175.8	3.77	58.8	0.0872	21.0	0.377	-71.9
3800	0.490	178.1	3.59	54.9	0.0884	20.9	0.361	-74.5
4000	0.492	172.3	3.43	51.1	0.0893	20.0	0.347	-77.5
4200	0.495	166.7	3.28	47.3	0.0912	19.8	0.332	-80.5
4400	0.499	161.5	3.14	43.6	0.0929	18.9	0.319	-83.7
4600	0.505	156.6	3.01	40.0	0.0943	18.7	0.308	-86.8
4800	0.508	151.9	2.89	36.5	0.0966	17.8	0.295	-90.2
5000	0.513	147.3	2.78	33.0	0.0976	17.7	0.285	-93.5
5200	0.519	142.9	2.68	29.5	0.0993	17.4	0.274	-97.4
5400	0.525	138.9	2.58	26.1	0.1018	16.6	0.265	-101.4
5600	0.531	134.8	2.49	22.8	0.1040	16.4	0.256	-105.4
5800	0.537	130.9	2.40	19.4	0.1066	15.2	0.247	-109.6
6000	0.543	127.1	2.32	16.1	0.1088	15.1	0.239	-114.0

Sパラメータ

(V_{CE} = 3 V, I_C = 5 mA, Z_O = 50 Ω)

f (MHz)	S11		S21		S12		S22	
	MAG	ANG	MAG	ANG	MAG	ANG	MAG	ANG
100	0.932	-7.5	14.49	172.5	0.0014	85.0	0.978	-5.0
200	0.919	-15.7	14.33	165.7	0.0097	82.5	0.979	-9.5
300	0.896	-22.9	14.03	159.3	0.0184	73.4	0.959	-13.7
400	0.875	-30.7	13.71	153.3	0.0248	71.7	0.934	-18.0
500	0.847	-38.2	13.37	147.6	0.0295	69.0	0.905	-22.0
600	0.817	-45.4	12.98	142.3	0.0337	63.4	0.873	-25.6
700	0.789	-51.9	12.45	137.2	0.0379	60.3	0.839	-29.2
800	0.756	-58.6	12.02	132.2	0.0422	56.7	0.803	-32.3
900	0.724	-65.6	11.67	127.7	0.0441	53.0	0.768	-35.0
1000	0.693	-71.7	11.19	123.1	0.0479	51.4	0.735	-37.5
1100	0.663	-77.8	10.72	119.0	0.0506	50.1	0.704	-39.8
1200	0.632	-83.9	10.32	114.8	0.0523	47.7	0.673	-41.9
1300	0.605	-89.5	9.86	111.0	0.0548	45.5	0.643	-43.9
1400	0.582	-95.0	9.44	107.6	0.0569	44.5	0.617	-45.7
1500	0.558	-100.6	9.06	104.2	0.0582	43.1	0.591	-47.4
1600	0.537	-106.0	8.69	100.9	0.0605	41.7	0.567	-48.8
1700	0.518	-111.1	8.33	97.8	0.0610	40.2	0.545	-50.4
1800	0.502	-116.0	8.00	94.9	0.0634	39.5	0.523	-51.8
1900	0.487	-121.0	7.68	92.1	0.0642	38.9	0.503	-53.2
2000	0.475	-126.0	7.39	89.4	0.0655	38.0	0.485	-54.4
2200	0.454	-135.0	6.85	84.3	0.0683	36.6	0.451	-56.9
2400	0.438	-144.0	6.37	79.6	0.0704	35.6	0.421	-59.2
2600	0.428	-152.3	5.95	75.1	0.0731	34.1	0.393	-61.5
2800	0.421	-160.2	5.58	70.8	0.0749	33.7	0.369	-63.9
3000	0.418	-167.5	5.24	66.7	0.0780	32.5	0.348	-66.3
3200	0.417	-174.5	4.93	62.7	0.0789	31.6	0.327	-68.8
3400	0.418	179.0	4.66	58.9	0.0819	31.3	0.309	-71.4
3600	0.418	172.9	4.41	55.3	0.0834	30.6	0.291	-73.9
3800	0.422	167.6	4.19	51.9	0.0864	30.3	0.275	-76.6
4000	0.428	162.3	3.99	48.4	0.0892	29.7	0.263	-79.8
4200	0.433	157.5	3.81	44.9	0.0921	28.2	0.250	-83.0
4400	0.439	152.8	3.64	41.5	0.0950	27.8	0.238	-86.6
4600	0.447	148.5	3.49	38.3	0.0980	26.9	0.227	-90.1
4800	0.453	144.2	3.34	35.0	0.1014	25.9	0.217	-93.9
5000	0.461	140.2	3.21	31.8	0.1041	25.4	0.206	-97.8
5200	0.468	136.3	3.09	28.6	0.1072	24.2	0.196	-102.2
5400	0.475	132.7	2.98	25.4	0.1099	23.0	0.188	-106.9
5600	0.483	129.1	2.87	22.2	0.1131	21.9	0.179	-111.4
5800	0.489	125.5	2.77	19.1	0.1161	20.5	0.172	-116.5
6000	0.497	122.1	2.68	16.0	0.1207	19.5	0.164	-121.9

Sパラメータ

(V_{CE} = 3 V, I_C = 7 mA, Z_O = 50 Ω)

f (MHz)	S11		S21		S12		S22	
	MAG	ANG	MAG	ANG	MAG	ANG	MAG	ANG
100	0.903	-9.5	19.54	171.1	0.0110	92.9	0.962	-6.9
200	0.885	-18.5	19.16	163.1	0.0101	77.0	0.969	-11.4
300	0.857	-27.3	18.56	155.7	0.0175	68.7	0.938	-16.7
400	0.824	-36.1	17.92	148.9	0.0230	69.6	0.904	-21.5
500	0.787	-44.6	17.24	142.5	0.0278	61.2	0.863	-25.9
600	0.748	-52.8	16.50	136.6	0.0314	60.3	0.820	-29.8
700	0.711	-60.1	15.63	131.1	0.0352	58.9	0.778	-33.4
800	0.672	-67.4	14.86	125.9	0.0385	54.9	0.736	-36.3
900	0.635	-74.7	14.18	121.2	0.0396	53.7	0.696	-38.8
1000	0.600	-81.2	13.42	116.6	0.0436	51.3	0.660	-41.2
1100	0.569	-87.5	12.70	112.5	0.0464	49.1	0.627	-43.3
1200	0.539	-93.8	12.07	108.5	0.0471	47.0	0.595	-45.2
1300	0.512	-99.4	11.42	104.9	0.0488	47.2	0.566	-46.8
1400	0.490	-105.0	10.84	101.7	0.0513	46.0	0.540	-48.4
1500	0.470	-110.6	10.32	98.5	0.0529	44.9	0.515	-49.9
1600	0.451	-115.9	9.82	95.5	0.0547	44.4	0.493	-51.1
1700	0.436	-121.0	9.36	92.7	0.0555	43.4	0.472	-52.3
1800	0.424	-126.1	8.94	90.0	0.0570	42.6	0.452	-53.5
1900	0.412	-131.0	8.55	87.4	0.0586	42.8	0.434	-54.7
2000	0.402	-135.8	8.19	85.0	0.0605	42.2	0.417	-55.7
2200	0.388	-144.8	7.54	80.3	0.0631	41.3	0.387	-58.0
2400	0.378	-153.4	6.98	75.9	0.0664	40.8	0.360	-60.0
2600	0.373	-161.3	6.49	71.8	0.0688	39.5	0.335	-62.2
2800	0.371	-169.1	6.06	67.9	0.0724	39.4	0.313	-64.4
3000	0.372	-175.9	5.68	64.1	0.0758	37.8	0.293	-66.9
3200	0.375	177.7	5.34	60.4	0.0783	37.8	0.275	-69.6
3400	0.378	171.5	5.03	56.8	0.0805	36.9	0.258	-72.1
3600	0.382	165.9	4.76	53.4	0.0844	35.9	0.242	-74.6
3800	0.387	161.1	4.51	50.2	0.0875	35.5	0.229	-77.6
4000	0.394	156.3	4.30	46.9	0.0908	34.4	0.216	-81.0
4200	0.402	151.9	4.09	43.7	0.0950	33.8	0.205	-84.5
4400	0.409	147.6	3.91	40.5	0.0980	32.2	0.193	-88.4
4600	0.418	143.7	3.75	37.4	0.1009	30.8	0.183	-92.3
4800	0.426	139.7	3.59	34.3	0.1053	29.8	0.173	-96.6
5000	0.434	136.1	3.45	31.1	0.1083	28.7	0.164	-101.2
5200	0.442	132.5	3.32	28.1	0.1122	27.4	0.155	-106.4
5400	0.449	129.1	3.19	25.0	0.1158	26.1	0.147	-111.8
5600	0.457	125.6	3.08	22.0	0.1195	24.7	0.140	-117.3
5800	0.465	122.4	2.97	19.0	0.1228	22.9	0.133	-123.4
6000	0.473	119.1	2.87	15.9	0.1266	21.5	0.127	-130.1

Sパラメータ

(V_{CE} = 3 V, I_C = 10 mA, Z_O = 50 Ω)

f (MHz)	S11		S21		S12		S22	
	MAG	ANG	MAG	ANG	MAG	ANG	MAG	ANG
100	0.869	-11.8	26.56	169.2	0.0022	69.6	0.963	-7.5
200	0.841	-22.8	25.72	159.7	0.0116	75.7	0.951	-14.1
300	0.799	-33.3	24.52	151.0	0.0173	70.7	0.907	-20.2
400	0.755	-43.5	23.24	143.3	0.0235	70.7	0.857	-25.6
500	0.704	-53.1	21.90	136.1	0.0256	63.7	0.804	-30.4
600	0.655	-62.0	20.51	129.7	0.0297	60.4	0.751	-34.2
700	0.612	-70.0	19.10	124.0	0.0318	57.3	0.701	-37.5
800	0.569	-77.9	17.81	118.7	0.0340	54.8	0.654	-40.2
900	0.530	-85.4	16.66	114.1	0.0361	51.3	0.614	-42.6
1000	0.497	-91.9	15.56	109.8	0.0390	52.3	0.577	-44.5
1100	0.469	-98.4	14.54	106.0	0.0410	50.0	0.543	-46.1
1200	0.442	-104.7	13.66	102.3	0.0426	50.7	0.514	-47.6
1300	0.420	-110.3	12.82	99.1	0.0445	49.3	0.487	-48.9
1400	0.402	-116.0	12.08	96.1	0.0462	49.0	0.464	-50.1
1500	0.386	-121.6	11.41	93.2	0.0473	48.7	0.441	-51.2
1600	0.372	-126.9	10.80	90.5	0.0497	48.4	0.421	-52.0
1700	0.361	-132.0	10.25	88.0	0.0514	48.3	0.402	-53.1
1800	0.352	-137.0	9.75	85.5	0.0526	47.6	0.386	-54.0
1900	0.345	-141.6	9.29	83.2	0.0545	47.3	0.370	-55.0
2000	0.338	-146.4	8.87	81.0	0.0559	47.1	0.355	-55.9
2200	0.331	-155.2	8.13	76.8	0.0600	46.3	0.329	-57.8
2400	0.328	-163.3	7.49	72.8	0.0634	45.6	0.305	-59.7
2600	0.327	-171.0	6.95	69.0	0.0670	44.7	0.284	-62.0
2800	0.330	-177.8	6.48	65.3	0.0703	44.2	0.264	-64.2
3000	0.335	175.8	6.06	61.8	0.0751	43.9	0.246	-66.5
3200	0.340	169.9	5.69	58.4	0.0783	42.9	0.230	-69.5
3400	0.347	164.2	5.36	55.0	0.0810	41.4	0.215	-72.1
3600	0.352	159.2	5.05	51.9	0.0845	40.3	0.199	-74.7
3800	0.358	154.8	4.79	48.8	0.0884	39.3	0.188	-77.9
4000	0.368	150.6	4.56	45.7	0.0937	38.7	0.177	-81.9
4200	0.376	146.6	4.35	42.6	0.0974	37.2	0.165	-85.8
4400	0.385	142.7	4.15	39.6	0.1011	36.0	0.154	-90.4
4600	0.394	139.0	3.97	36.6	0.1050	34.3	0.145	-95.0
4800	0.402	135.5	3.81	33.6	0.1087	32.8	0.136	-100.1
5000	0.411	132.1	3.65	30.6	0.1125	31.6	0.127	-105.6
5200	0.420	128.7	3.51	27.7	0.1171	29.7	0.119	-112.1
5400	0.428	125.6	3.38	24.7	0.1206	28.2	0.112	-118.8
5600	0.437	122.5	3.26	21.8	0.1242	26.8	0.106	-126.1
5800	0.444	119.5	3.15	18.9	0.1280	24.7	0.102	-134.1
6000	0.453	116.4	3.04	15.9	0.1322	23.1	0.097	-142.1

Sパラメータ

(V_{CE} = 3 V, I_C = 20 mA, Z_O = 50 Ω)

f (MHz)	S11		S21		S12		S22	
	MAG	ANG	MAG	ANG	MAG	ANG	MAG	ANG
100	0.763	-17.4	44.74	164.5	0.0018	0.3	0.938	-10.6
200	0.706	-33.8	41.64	151.4	0.0073	80.5	0.893	-20.2
300	0.638	-48.2	37.69	140.2	0.0140	70.6	0.813	-27.6
400	0.574	-60.8	33.84	131.0	0.0191	64.8	0.735	-33.3
500	0.511	-72.2	30.22	123.2	0.0209	61.8	0.662	-37.6
600	0.460	-82.0	27.02	116.8	0.0239	57.4	0.601	-40.6
700	0.419	-90.6	24.28	111.5	0.0269	57.5	0.550	-42.8
800	0.384	-98.8	21.95	106.9	0.0281	56.9	0.507	-44.4
900	0.357	-106.1	19.99	103.0	0.0295	57.9	0.470	-45.7
1000	0.334	-112.9	18.31	99.4	0.0331	58.0	0.440	-46.8
1100	0.316	-119.5	16.87	96.2	0.0348	58.8	0.413	-47.6
1200	0.301	-126.2	15.63	93.3	0.0357	57.4	0.390	-48.1
1300	0.290	-131.5	14.52	90.6	0.0374	57.4	0.370	-48.9
1400	0.280	-137.4	13.58	88.2	0.0405	56.5	0.351	-49.4
1500	0.274	-142.7	12.74	85.8	0.0423	56.7	0.334	-50.1
1600	0.269	-147.7	11.99	83.6	0.0445	57.0	0.320	-50.4
1700	0.265	-152.7	11.32	81.5	0.0475	57.5	0.306	-51.3
1800	0.263	-157.3	10.73	79.5	0.0486	56.3	0.294	-51.9
1900	0.262	-161.7	10.19	77.5	0.0509	55.8	0.283	-52.7
2000	0.262	-165.8	9.70	75.6	0.0535	55.9	0.271	-53.4
2200	0.264	-173.5	8.85	72.0	0.0576	54.6	0.251	-55.0
2400	0.269	179.6	8.13	68.5	0.0626	53.8	0.233	-56.9
2600	0.276	173.2	7.52	65.2	0.0665	52.2	0.215	-59.1
2800	0.284	167.4	6.99	62.0	0.0713	52.1	0.200	-61.5
3000	0.292	162.5	6.53	58.8	0.0755	50.4	0.185	-63.9
3200	0.301	157.4	6.12	55.7	0.0805	49.2	0.170	-67.6
3400	0.311	153.0	5.76	52.7	0.0838	47.6	0.157	-70.5
3600	0.318	148.7	5.43	49.8	0.0886	46.4	0.144	-73.5
3800	0.326	145.3	5.15	47.0	0.0931	45.2	0.133	-77.2
4000	0.336	141.9	4.90	44.1	0.0975	43.3	0.123	-82.4
4200	0.347	138.5	4.66	41.2	0.1018	41.7	0.113	-87.7
4400	0.357	135.4	4.45	38.4	0.1062	39.9	0.104	-94.2
4600	0.367	132.2	4.26	35.6	0.1112	38.4	0.095	-100.5
4800	0.375	129.3	4.08	32.7	0.1150	36.2	0.088	-108.5
5000	0.384	126.3	3.92	29.9	0.1191	34.7	0.081	-116.5
5200	0.394	123.5	3.77	27.1	0.1231	32.6	0.076	-127.0
5400	0.403	120.7	3.63	24.3	0.1271	30.7	0.072	-136.8
5600	0.411	117.9	3.50	21.5	0.1318	29.2	0.070	-148.4
5800	0.420	115.2	3.37	18.7	0.1356	27.1	0.071	-159.7
6000	0.429	112.5	3.26	15.9	0.1394	25.1	0.072	-171.2

Sパラメータ

(V_{CE} = 3 V, I_C = 30 mA, Z_O = 50 Ω)

f (MHz)	S11		S21		S12		S22	
	MAG	ANG	MAG	ANG	MAG	ANG	MAG	ANG
100	0.666	-21.6	56.96	161.4	0.0074	75.8	0.877	-13.3
200	0.603	-42.1	51.26	145.9	0.0106	72.4	0.846	-23.9
300	0.527	-58.8	44.58	133.6	0.0133	58.3	0.743	-31.5
400	0.458	-72.4	38.58	124.2	0.0168	62.4	0.654	-36.7
500	0.404	-84.4	33.50	116.7	0.0192	60.6	0.581	-40.2
600	0.362	-94.8	29.33	110.8	0.0222	61.4	0.523	-42.3
700	0.330	-103.6	25.98	106.0	0.0235	60.3	0.476	-43.6
800	0.305	-111.8	23.23	101.8	0.0260	60.1	0.439	-44.6
900	0.285	-119.7	20.98	98.3	0.0281	60.6	0.406	-45.4
1000	0.270	-126.6	19.11	95.2	0.0297	60.9	0.381	-45.9
1100	0.260	-132.8	17.52	92.3	0.0321	61.5	0.359	-46.3
1200	0.252	-139.2	16.17	89.7	0.0342	62.0	0.339	-46.5
1300	0.246	-144.6	14.99	87.3	0.0366	62.0	0.323	-47.0
1400	0.241	-150.1	13.98	85.1	0.0395	61.2	0.308	-47.3
1500	0.238	-155.2	13.10	83.0	0.0418	60.7	0.295	-47.9
1600	0.237	-159.9	12.31	80.9	0.0430	60.1	0.282	-48.0
1700	0.237	-164.4	11.61	79.0	0.0462	60.1	0.270	-48.8
1800	0.239	-168.6	10.99	77.1	0.0486	59.0	0.260	-49.4
1900	0.240	-172.4	10.42	75.3	0.0504	59.8	0.250	-50.2
2000	0.242	-176.2	9.92	73.6	0.0531	59.0	0.241	-50.8
2200	0.248	177.1	9.03	70.2	0.0583	58.6	0.222	-52.6
2400	0.256	171.1	8.29	66.9	0.0626	57.1	0.207	-54.4
2600	0.264	165.9	7.66	63.7	0.0669	55.5	0.190	-56.5
2800	0.273	160.6	7.13	60.7	0.0718	54.2	0.177	-59.0
3000	0.283	156.2	6.65	57.7	0.0761	52.8	0.163	-61.6
3200	0.294	152.0	6.24	54.7	0.0820	51.5	0.149	-65.4
3400	0.304	147.9	5.87	51.7	0.0856	49.5	0.135	-68.8
3600	0.312	144.1	5.53	48.9	0.0900	47.8	0.124	-72.2
3800	0.321	141.0	5.24	46.2	0.0945	46.7	0.113	-76.3
4000	0.331	138.1	4.99	43.4	0.0999	45.1	0.103	-82.1
4200	0.342	135.0	4.75	40.6	0.1039	43.4	0.093	-88.7
4400	0.351	132.0	4.53	37.8	0.1078	41.1	0.085	-95.4
4600	0.361	129.3	4.34	35.1	0.1134	39.5	0.078	-103.2
4800	0.370	126.5	4.16	32.3	0.1175	37.5	0.070	-112.4
5000	0.380	123.8	3.99	29.6	0.1222	35.6	0.065	-123.2
5200	0.389	121.1	3.84	26.8	0.1258	33.7	0.062	-135.3
5400	0.399	118.4	3.69	24.0	0.1298	31.6	0.061	-148.5
5600	0.407	115.9	3.56	21.3	0.1342	29.8	0.061	-161.2
5800	0.416	113.2	3.43	18.5	0.1384	27.6	0.064	-174.2
6000	0.426	110.6	3.32	15.8	0.1427	25.6	0.068	174.5

HSG1003 5.8GHz 評価ボード

評価ボードレイアウト

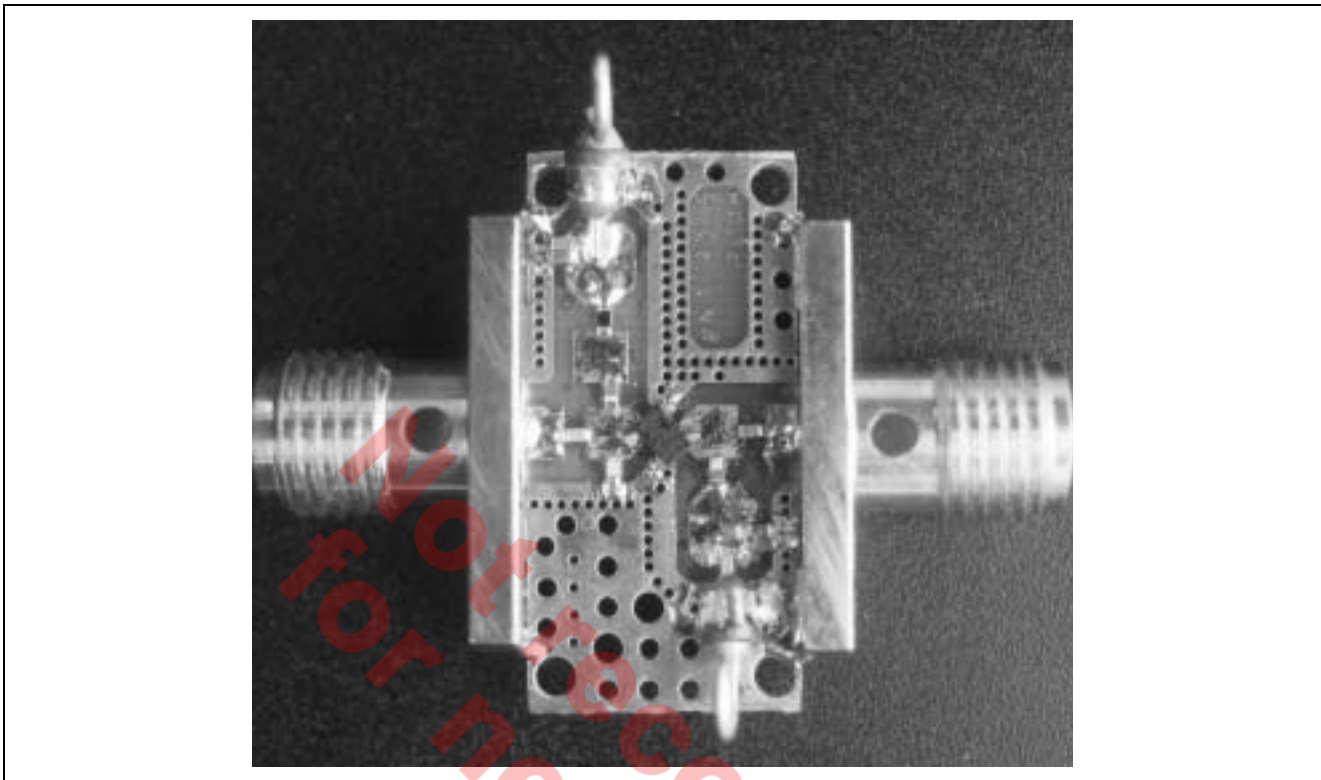

回路図

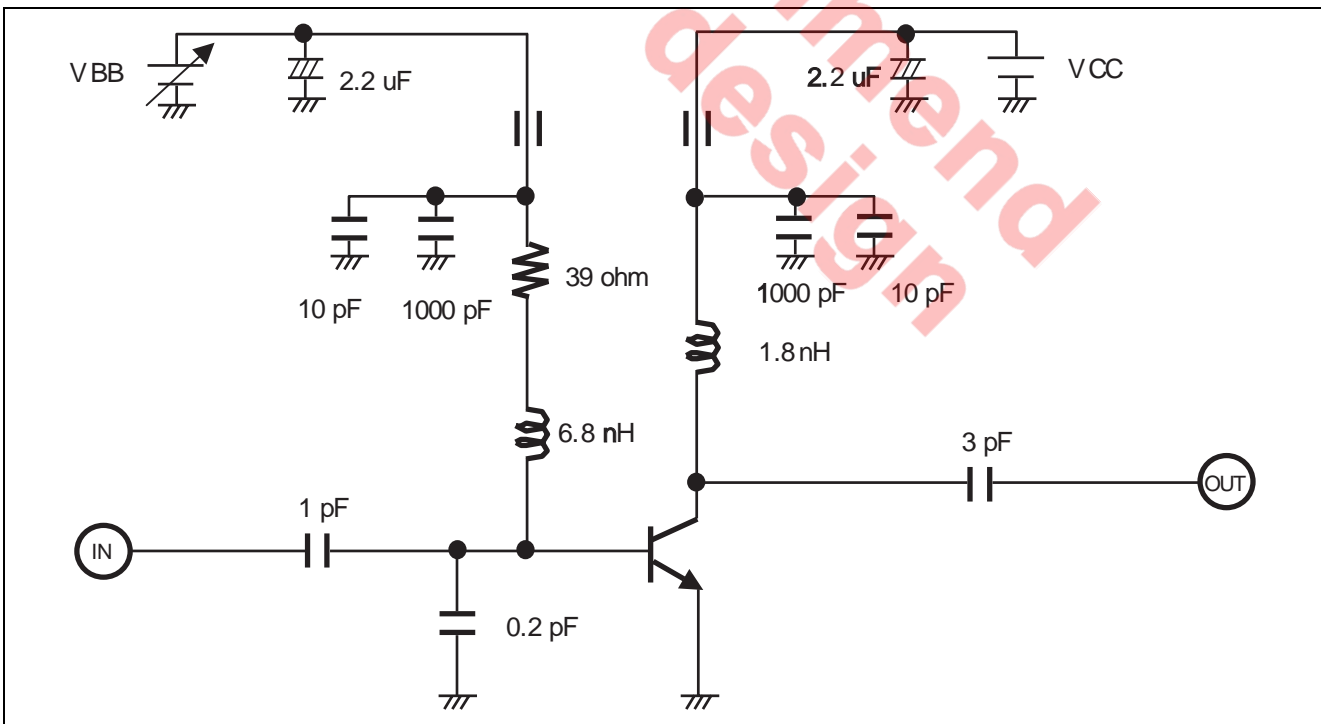

評価ボード上の電気的特性

(V_{CC} = 2 V, I_C = 10 mA, Ta = 25°C)

項目	記号	データ	単位	測定条件
雑音指数	NF	1.44	dB	f = 5.8GHz
電力利得	PG	10.7	dB	f = 5.8GHz
入力リターンロス	RLin	11.6	dB	f = 5.8GHz
出力リターンロス	RLout	15.3	dB	f = 5.8GHz
1dB 利得圧縮	P1dB	+11	dBm	f = 5.8GHz
3次インタセプトポイント	IM3	+25	dBm	fd = 5.8GHz, fud = 5.801GHz

Not recommend
for new design

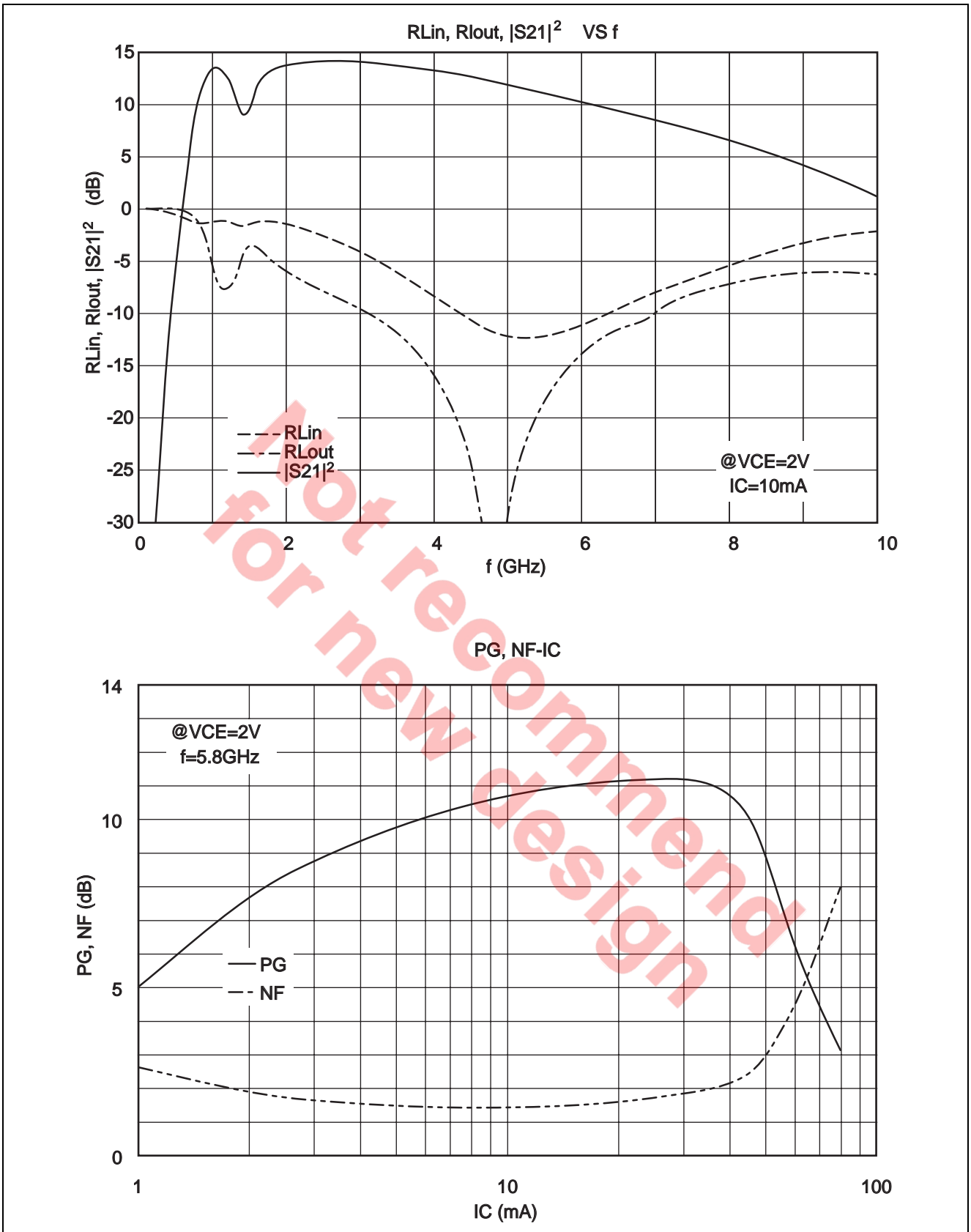

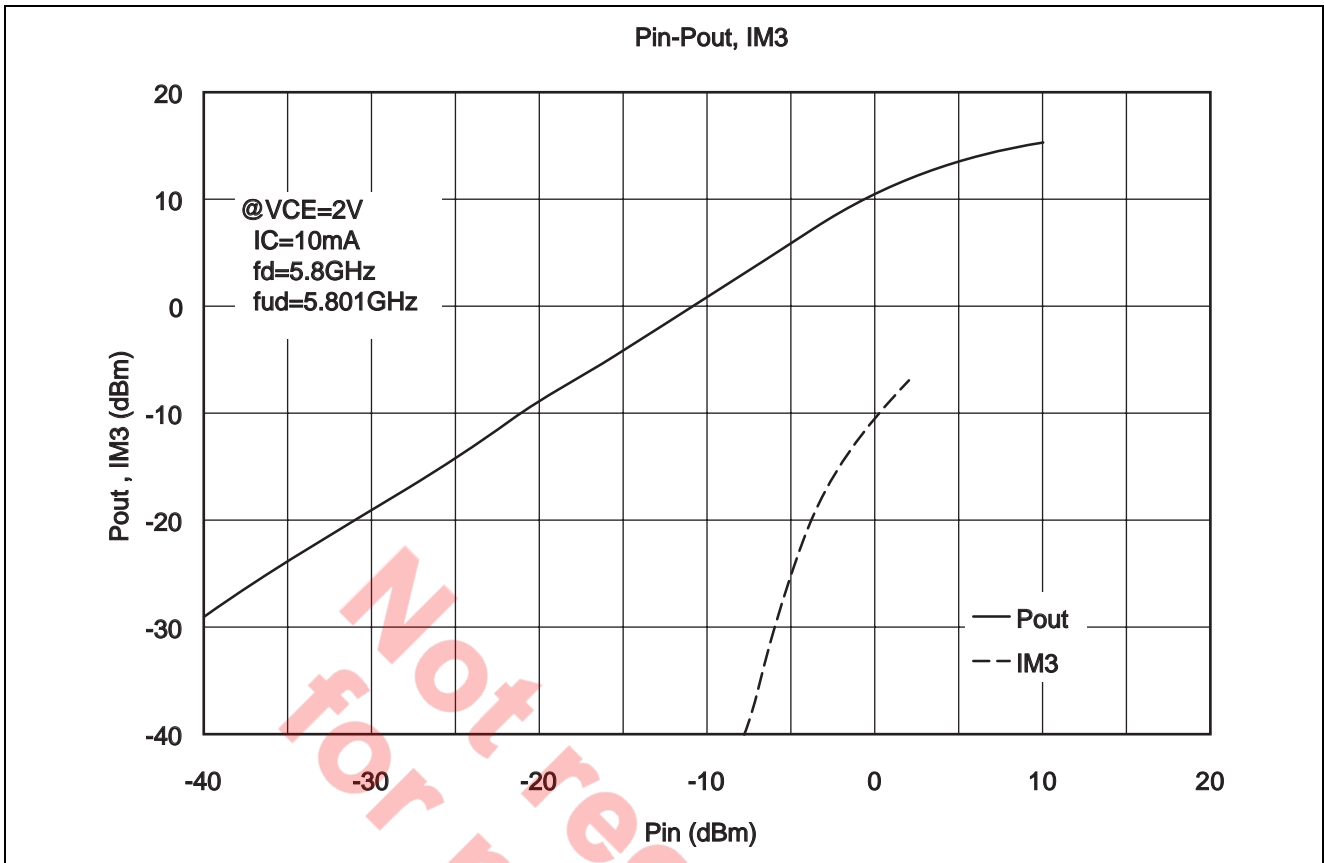

Not recommended for new design

外形寸法図

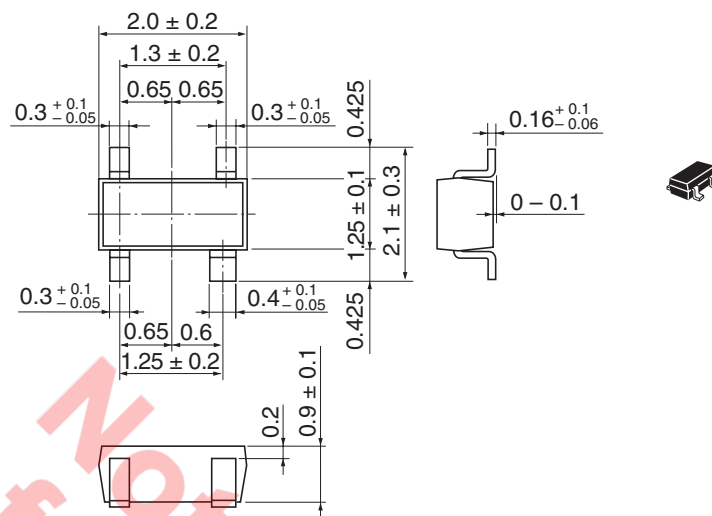
As of January, 2003
Unit: mm

Package Code	CMPAK-4(T)
JEDEC	—
JEITA	Conforms
Mass (reference value)	0.006 g

発注型名

発注型名	梱包数量	梱包形態
HSG1003VE-	3000 pcs	φ178 mm テーピングリール

【注】 各グレード分けについては生産を停止している場合があります。
ご注文の場合は弊社営業または特約店に生産ステータスをご確認ください。

株式会社 ルネサス テクノロジ 営業企画統括部 〒100-0004 東京都千代田区大手町2-6-2 日本ビル

安全設計に関するお願い

1. 弊社は品質、信頼性の向上に努めておりますが、半導体製品は故障が発生したり、誤動作する場合があります。弊社の半導体製品の故障又は誤動作によって結果として、人身事故、火災事故、社会的損害などを生じさせないような安全性を考慮した冗長設計、延焼対策設計、誤動作防止設計などの安全設計に十分ご留意ください。

本資料ご利用に際しての留意事項

1. 本資料は、お客様が用途に応じた適切なルネサス テクノロジ製品をご購入いただくための参考資料であり、本資料中に記載の技術情報についてルネサス テクノロジが所有する知的財産権その他の権利の実施、使用を許諾するものではありません。
2. 本資料に記載の製品データ、図、表、プログラム、アルゴリズムその他応用回路例の使用に起因する損害、第三者所有の権利に対する侵害に関し、ルネサス テクノロジは責任を負いません。
3. 本資料に記載の製品データ、図、表、プログラム、アルゴリズムその他全ての情報は本資料発行時点のものであり、ルネサス テクノロジは、予告なしに、本資料に記載した製品または仕様を変更することがあります。ルネサス テクノロジ半導体製品のご購入に当たりましては、事前にルネサス テクノロジ、ルネサス販売または特約店へ最新の情報をご確認頂きますとともに、ルネサス テクノロジホームページ(<http://www.renesas.com>)などを通じて公開される情報に常にご注意ください。
4. 本資料に記載した情報は、正確を期すため、慎重に制作したものです。万一本資料の記述誤りに起因する損害がお客様に生じた場合には、ルネサス テクノロジはその責任を負いません。
5. 本資料に記載の製品データ、図、表に示す技術的な内容、プログラム及びアルゴリズムを流用する場合は、技術内容、プログラム、アルゴリズム単位で評価するだけでなく、システム全体で十分に評価し、お客様の責任において適用可否を判断してください。ルネサス テクノロジは、適用可否に対する責任を負いません。
6. 本資料に記載された製品は、人命にかかわるような状況の下で使用される機器あるいはシステムに用いられることを目的として設計、製造されたものではありません。本資料に記載の製品を運輸、移動体用、医療用、航空宇宙用、原子力制御用、海中継用機器あるいはシステムなど、特殊用途へのご利用をご検討の際には、ルネサス テクノロジ、ルネサス販売または特約店へご照会ください。
7. 本資料の転載、複製については、文書によるルネサス テクノロジの事前の承諾が必要です。
8. 本資料に関し詳細についてのお問い合わせ、その他お気付きの点がございましたらルネサス テクノロジ、ルネサス販売または特約店までご照会ください。



営業お問合せ窓口

株式会社ルネサス販売

<http://www.renesas.com>

本	社	〒100-0004	千代田区大手町2-6-2 (日本ビル)	(03) 5201-5350
京	支	〒212-0058	川崎市幸区鹿島田890-12 (新川崎三井ビル)	(044) 549-1662
西	支	〒190-0023	立川市柴崎町2-2-23 (第二高島ビル2F)	(042) 524-8701
札	支	〒060-0002	札幌市中央区北二条西4-1 (札幌三井ビル5F)	(011) 210-8717
東	支	〒980-0013	仙台市青葉区花京院1-1-20 (花京院スクエア13F)	(022) 221-1351
い	支	〒970-8026	いわき市平小太郎町4-9 (損保ジャパンいわき第二ビル3F)	(0246) 22-3222
茨	支	〒312-0034	ひたちなか市堀口832-2 (日立システムプラザ勝田1F)	(029) 271-9411
新	支	〒950-0087	新潟市東大通1-4-2 (新潟三井物産ビル3F)	(025) 241-4361
松	支	〒390-0815	松本市深志1-2-11 (昭和ビル7F)	(0263) 33-6622
中	支	〒460-0008	名古屋市中区栄3-13-20 (栄センタービル4F)	(052) 261-3000
浜	支	〒430-7710	浜松市板屋町111-2 (浜松アクタタワー10F)	(053) 451-2131
西	支	〒541-0044	大阪市中央区伏見町4-1-1 (明治安田生命大阪御堂筋ビル)	(06) 6233-9500
北	支	〒920-0031	金沢市広岡3-1-1 (金沢パークビル8F)	(076) 233-5980
広	支	〒730-0036	広島市中区袋町5-25 (広島袋町ビルディング8F)	(082) 244-2570
鳥	支	〒680-0822	鳥取市今町2-251 (日本生命鳥取駅前ビル)	(0857) 21-1915
九	支	〒812-0011	福岡市博多区博多駅前2-17-1 (ヒロカネビル本館5F)	(092) 481-7695
鹿	支	〒890-0053	鹿児島市中央町12-2 (明治安田生命鹿児島中央町ビル)	(099) 284-1748

■技術的なお問合せおよび資料のご請求は下記へどうぞ。

総合お問合せ窓口：カスタマサポートセンタ E-Mail: csc@renesas.com