

## Ultra-Low Quiescent Current Buck and LDO

### General Description

DA9231 is an ultra-low quiescent current high efficiency buck regulator and an ultra-low quiescent current LDO in a compact I<sup>2</sup>C configurable WLCSP package. It is targeting battery powered applications needing highly efficient power supplies.

The buck regulator extends high light-load efficiency down to 10  $\mu$ A further extending battery life. Dynamic Voltage Control (DVC) in the buck regulator facilitates optimization across the system power modes enabling further improvement in System efficiency and battery life.

The low quiescent current LDO can be configured as a Load Switch and provides the second supply output. The LDO's uncommitted inputs can be connected to either the battery or the buck output. Connecting the input to the buck output provides the flexibility to improve the PSRR at the LDO output as needed.

DA9231 provides multiple protection features and comes with the ability to monitor the events and indicators in the GPO pin.

Suitable for space constrained applications, the DA9231 comes in a 1.65 mm x 1.25 mm 12-pin WLCSP package.

### Key Features

- 300 mA buck regulator
  - 750 nA total input current (buck enabled no load, LDO disabled)
  - Up to 81% efficiency at 1.8 V output, 10  $\mu$ A load current
  - Input voltage 2.5 V to 5.5 V (Minimum 2.75 V for start-up)
  - Output voltage 0.6 V to 1.9 V
  - Dynamic Voltage Control (DVC)
- 100 mA LDO/Load Switch
  - Ultra-low quiescent current
  - Input voltage 1.8 V to 5.5 V
  - Output voltage 0.7 V to 3.3 V
- I<sup>2</sup>C interface for device configuration and control
- Protection features and System monitors
- Small 1.65 mm x 1.25 mm, 12-pin WLCSP package

### Applications

- Wearables – wrist wear, hearables
- Smart devices - thermostats and door locks
- Smoke detectors
- Portable medical devices
- Remote sensors
- High efficiency, low power applications

## Ultra-Low Quiescent Current Buck and LDO

### Contents

General Description .....	1
Key Features .....	1
Applications .....	1
Contents .....	2
Figures.....	4
Tables .....	5
<b>1 Terms and Definitions.....</b>	<b>6</b>
<b>2 Block and Application Diagrams .....</b>	<b>7</b>
<b>3 Pinout .....</b>	<b>8</b>
<b>4 Absolute Maximum Ratings .....</b>	<b>10</b>
<b>5 Recommended Operating Conditions.....</b>	<b>11</b>
<b>6 ESD Ratings.....</b>	<b>12</b>
<b>7 Electrical Characteristics .....</b>	<b>13</b>
<b>8 Thermal Characteristics .....</b>	<b>17</b>
<b>9 Typical Operating Characteristics.....</b>	<b>18</b>
9.1 Buck No Load Quiescent Current vs Temperature, Device is Switching.....	18
9.2 Buck and LDO No Load Quiescent Current vs Temperature, Device is Switching .....	18
9.3 RDSon vs Temperature .....	19
9.4 Efficiency vs Load Current .....	19
9.5 Switching Frequency vs Load Current .....	21
9.6 Buck V <sub>OUT</sub> Ripple vs Load Current.....	22
9.7 Buck V <sub>OUT</sub> vs Load Current .....	23
9.8 Typical Mode Operation .....	24
9.9 Buck Load Transient Response.....	25
9.10 Buck Dynamic Voltage Control .....	26
9.11 Device Enable and Start up .....	27
9.12 LDO V <sub>OUT</sub> Accuracy.....	28
9.13 LDO PSRR.....	30
<b>10 Feature Descriptions.....</b>	<b>31</b>
10.1 Chip Enable and Disable Through IC_EN .....	31
10.2 VDD Under-Voltage Lockout.....	31
10.3 Over-Temperature Protection .....	31
10.4 Buck Regulator.....	31
10.4.1 Buck Output Voltage Programmability.....	31
10.4.2 Start-up Operation .....	32
10.4.3 Power Saving Mode Operation.....	32
10.4.4 Dynamic Voltage Control .....	33
10.4.5 Cycle-by-cycle Over-Current Protection .....	33
10.4.6 Output Over-Voltage Protection .....	33

## Ultra-Low Quiescent Current Buck and LDO

10.4.7	Output Under-Voltage Protection .....	33
10.4.8	Automatic Output voltage Discharge .....	33
10.4.9	Event Flag and Fault Control .....	34
10.5	Load Switch, LDO Output and Control .....	35
10.5.1	LDO Output Programmability .....	35
10.5.2	Automatic Output Voltage Discharge .....	36
10.5.3	Load Switch .....	36
10.6	I <sup>2</sup> C Programming .....	37
10.6.1	Interface Description .....	37
10.6.2	Details of the I <sup>2</sup> C Protocol .....	37
10.7	GPO Pin Function Programing .....	38
10.7.1	Power Good Indicator .....	38
10.7.2	Event Indicator .....	38
10.7.3	Reset Pulse Generation .....	38
10.7.4	Always Pull-Down or Hi-Z .....	38
<b>11</b>	<b>Register Overview .....</b>	<b>39</b>
11.1	Register Map .....	39
11.1.1	Buck and LDO Control .....	39
11.1.2	System Module .....	40
11.2	Register Definitions .....	40
11.2.1	Buck and LDO Control .....	40
11.2.1.1	Event/Status/Mask Registers .....	40
11.2.1.2	User Registers .....	42
11.2.2	System Module .....	49
11.2.2.1	System Reset Registers .....	49
11.2.2.2	System ID Registers .....	50
<b>12</b>	<b>Package Information .....</b>	<b>52</b>
12.1	Package Outlines .....	52
12.2	Moisture Sensitivity Level .....	53
12.3	Soldering Information .....	53
<b>13</b>	<b>Ordering Information .....</b>	<b>54</b>

## Ultra-Low Quiescent Current Buck and LDO

### Figures

Figure 1: Block Diagram.....	7
Figure 2: DA9231 Application Diagram.....	7
Figure 3: Pinout Diagram (Top View).....	8
Figure 4: Buck $V_{OUT} = 1.8\text{ V}$ .....	18
Figure 5: Buck $V_{OUT} = 0.9\text{ V}$ .....	18
Figure 6: Buck $V_{OUT} = 1.8\text{ V}$ , LDO $V_{OUT} = 0.8\text{ V}$ .....	18
Figure 7: Buck $V_{OUT} = 0.9\text{ V}$ , LDO $V_{OUT} = 0.8\text{ V}$ .....	18
Figure 8: High-Side FET.....	19
Figure 9: Low-Side FET.....	19
Figure 10: Buck $V_{OUT} = 1.9\text{ V}$ .....	19
Figure 11: Buck $V_{OUT} = 1.8\text{ V}$ .....	19
Figure 12: Buck $V_{OUT} = 1.2\text{ V}$ .....	20
Figure 13: Buck $V_{OUT} = 0.9\text{ V}$ .....	20
Figure 14: Buck $V_{OUT} = 0.6\text{ V}$ .....	20
Figure 15: Buck $V_{OUT} = 1.9\text{ V}$ .....	21
Figure 16: Buck $V_{OUT} = 0.9\text{ V}$ .....	21
Figure 17: Buck $V_{OUT} = 1.2\text{ V}$ .....	21
Figure 18: Buck $V_{OUT} = 0.6\text{ V}$ .....	21
Figure 19: Buck $V_{OUT} = 1.9\text{ V}$ .....	22
Figure 20: Buck $V_{OUT} = 1.3\text{ V}$ .....	22
Figure 21: Buck $V_{OUT} = 0.9\text{ V}$ .....	22
Figure 22: Buck $V_{OUT} = 0.6\text{ V}$ .....	22
Figure 23: Buck $V_{OUT} = 1.9\text{ V}$ .....	23
Figure 24: Buck $V_{OUT} = 1.2\text{ V}$ .....	23
Figure 25: Buck $V_{OUT} = 0.9\text{ V}$ .....	23
Figure 26: Buck $V_{OUT} = 0.6\text{ V}$ .....	23
Figure 27: Buck $V_{IN} = 3.6\text{ V}$ , Buck $V_{OUT} = 1.8\text{ V}$ , Buck $I_{LOAD} = 1\text{ mA}$ .....	24
Figure 28: Buck $V_{IN} = 3.6\text{ V}$ , Buck $V_{OUT} = 1.8\text{ V}$ , Buck $I_{LOAD} = 10\text{ mA}$ .....	24
Figure 29: Buck $V_{IN} = 3.6\text{ V}$ , Buck $V_{OUT} = 1.8\text{ V}$ , Buck $I_{LOAD} = 100\text{ mA}$ .....	24
Figure 30: Buck $V_{IN} = 3.6\text{ V}$ , Buck $V_{OUT} = 1.8\text{ V}$ , Buck $I_{LOAD} = 300\text{ mA}$ .....	24
Figure 31: Buck $I_{LOAD} = 10\text{ mA}$ to $300\text{ mA}$ to $10\text{ mA}$ ( $0.3\text{ A}/\mu\text{s}$ ); Buck $V_{IN} = 3.6\text{ V}$ , Buck $V_{OUT} = 1.8\text{ V}$ .....	25
Figure 32: Buck $I_{LOAD} = 100\text{ mA}$ to $300\text{ mA}$ to $100\text{ mA}$ ( $0.2\text{ A}/\mu\text{s}$ ); Buck $V_{IN} = 3.6\text{ V}$ , Buck $V_{OUT} = 1.8\text{ V}$ .....	25
Figure 33: Buck $I_{LOAD} = 10\text{ mA}$ to $300\text{ mA}$ to $10\text{ mA}$ ( $0.3\text{ A}/\mu\text{s}$ ); Buck $V_{IN} = 3.6\text{ V}$ , Buck $V_{OUT} = 1.2\text{ V}$ .....	25
Figure 34: Buck $I_{LOAD} = 100\text{ mA}$ to $300\text{ mA}$ to $100\text{ mA}$ ( $0.2\text{ A}/\mu\text{s}$ ); Buck $V_{IN} = 3.6\text{ V}$ , Buck $V_{OUT} = 1.2\text{ V}$ .....	25
Figure 35: Buck $I_{LOAD} = 10\text{ mA}$ to $300\text{ mA}$ to $10\text{ mA}$ ( $0.3\text{ A}/\mu\text{s}$ ); Buck $V_{IN} = 3.6\text{ V}$ , Buck $V_{OUT} = 0.9\text{ V}$ .....	25
Figure 36: Buck $I_{LOAD} = 100\text{ mA}$ to $300\text{ mA}$ to $100\text{ mA}$ ( $0.2\text{ A}/\mu\text{s}$ ); Buck $V_{IN} = 3.6\text{ V}$ , Buck $V_{OUT} = 0.9\text{ V}$ .....	25
Figure 37: Buck $I_{LOAD} = 10\text{ mA}$ to $300\text{ mA}$ to $10\text{ mA}$ ( $0.3\text{ A}/\mu\text{s}$ ); Buck $V_{IN} = 3.6\text{ V}$ , Buck $V_{OUT} = 0.6\text{ V}$ .....	26
Figure 38: Buck $I_{LOAD} = 100\text{ mA}$ to $300\text{ mA}$ to $100\text{ mA}$ ( $0.2\text{ A}/\mu\text{s}$ ); Buck $V_{IN} = 3.6\text{ V}$ , Buck $V_{OUT} = 0.6\text{ V}$ .....	26
Figure 39: Buck $V_{OUT} 0.6\text{ V}$ to $1.2\text{ V}$ ; Buck $V_{IN} = 3.6\text{ V}$ , Buck $I_{LOAD} = 300\text{ mA}$ .....	26
Figure 40: Buck $V_{OUT} 1.2\text{ V}$ to $0.6\text{ V}$ ; Buck $V_{IN} = 3.6\text{ V}$ , Buck $I_{LOAD} = 300\text{ mA}$ .....	26
Figure 41: Buck $V_{OUT} 1.3\text{ V}$ to $1.9\text{ V}$ ; Buck $V_{IN} = 3.6\text{ V}$ , Buck $I_{LOAD} = 300\text{ mA}$ .....	26
Figure 42: Buck $V_{OUT} 1.9\text{ V}$ to $1.3\text{ V}$ ; Buck $V_{IN} = 3.6\text{ V}$ , Buck $I_{LOAD} = 300\text{ mA}$ .....	26
Figure 43: Device Enable: Buck $V_{IN} = 3.6\text{ V}$ , Buck $V_{OUT} 1.8\text{ V}$ , Buck $I_{LOAD} = 300\text{ mA}$ .....	27
Figure 44: $V_{OUT}$ ramp-up after Enabled (Zoom-in of Figure 43).....	27
Figure 45: Device Enable: Buck $V_{IN} = \text{LDO } V_{IN} = 3.6\text{ V}$ , Buck $V_{OUT} = 1.8\text{ V}$ , LDO $V_{OUT} = 3.3\text{ V}$ .....	27
Figure 46: LDO $V_{OUT} = 0.8\text{ V}$ .....	28
Figure 47: LDO $V_{OUT} = 2\text{ V}$ .....	28
Figure 48: LDO $V_{OUT} = 3.3\text{ V}$ .....	28
Figure 49: LDO $I_{LOAD} = 5\text{ mA}$ to $100\text{ mA}$ to $5\text{ mA}$ ( $0.1\text{ A} / 1\ \mu\text{s}$ ); LDO $V_{IN} = 3.6\text{ V}$ , LDO $V_{OUT} = 0.8\text{ V}$ .....	29

## Ultra-Low Quiescent Current Buck and LDO

Figure 50: LDO $I_{LOAD} = 5\text{ mA}$ to $100\text{ mA}$ to $5\text{ mA}$ ( $0.1\text{ A} / 1\ \mu\text{s}$ ); LDO $V_{IN} = 3.6\text{ V}$ , LDO $V_{OUT} = 2\text{ V}$ ...	29
Figure 51: LDO $I_{LOAD} = 5\text{ mA}$ to $100\text{ mA}$ to $5\text{ mA}$ ( $0.1\text{ A} / 1\ \mu\text{s}$ ); LDO $V_{IN} = 3.6\text{ V}$ , LDO $V_{OUT} = 3.3\text{ V}$	29
Figure 52: LDO $V_{IN} = 3.7\text{ V}$ , LDO No Load .....	30
Figure 53: LDO $V_{IN} = 3.7\text{ V}$ , LDO $I_{LOAD} = 100\text{ mA}$ .....	30
Figure 54: I <sup>2</sup> C Serial Interface Pins .....	37
Figure 55: I <sup>2</sup> C Start and Stop Conditions .....	37
Figure 56: Package Outline Drawing.....	52

## Tables

Table 1: Pin Description .....	8
Table 2: Pin Type Definition .....	9
Table 3: Absolute Maximum Ratings.....	10
Table 4: Recommended Operating Conditions .....	11
Table 5: Input Currents.....	13
Table 6: Buck Output.....	13
Table 7: Bypass/LDO Output .....	14
Table 8: GPO – Electrical Performance .....	15
Table 9: I2C interface .....	15
Table 10: Analog Core.....	16
Table 11: Thermal Characteristics .....	17
Table 12: Buck Output Voltage Settings .....	31
Table 13: LDO Output Voltages Settings .....	35
Table 14: GPO as Power Good Indicator.....	38
Table 15: Event/Status/Mask and User Registers .....	39
Table 16: System Registers .....	40
Table 17: Register EVENT .....	40
Table 18: Register STATUS .....	41
Table 19: Register MASK.....	42
Table 20: Register GPO .....	42
Table 21: Register BUCK.....	44
Table 22: Register BUCK_CFG .....	46
Table 23: Register LS_LDO .....	46
Table 24: Register FAULT_CTL.....	48
Table 25: Register PIN_MONTOR.....	49
Table 26: Register SYS_RST_EVENT.....	49
Table 27: Register SYS_SRST .....	50
Table 28: Register SYS_DEVICE_ID .....	50
Table 29: Register SYS_VARIANT_ID.....	50
Table 30: Register SYS_CONFIG_ID .....	51
Table 31: MSL Classification .....	53
Table 32: Ordering Information .....	54
Table 33: OTP List.....	54

---

## Ultra-Low Quiescent Current Buck and LDO

### 1 Terms and Definitions

CDM	Charged Device Model
DC	Direct Current
DCM	Discontinuous Conduction Mode
FET	Field Effect Transistor
GPO	General Purpose Output
LDO	Low DropOut voltage regulator
NMOS	N-channel Metal-Oxide-Semiconductor
OTP	One-Time Programmable (memory)
PMIC	Power Management IC
PMOS	P-channel Metal-Oxide-Semiconductor
R/W	Read/Write
SCL	Serial CLock SDA
T&R	Tape and Reel
UVLO	Under-Voltage LockOut
WLCSP	Wafer-Level Chip-Scale Package

Ultra-Low Quiescent Current Buck and LDO

2 Block and Application Diagrams

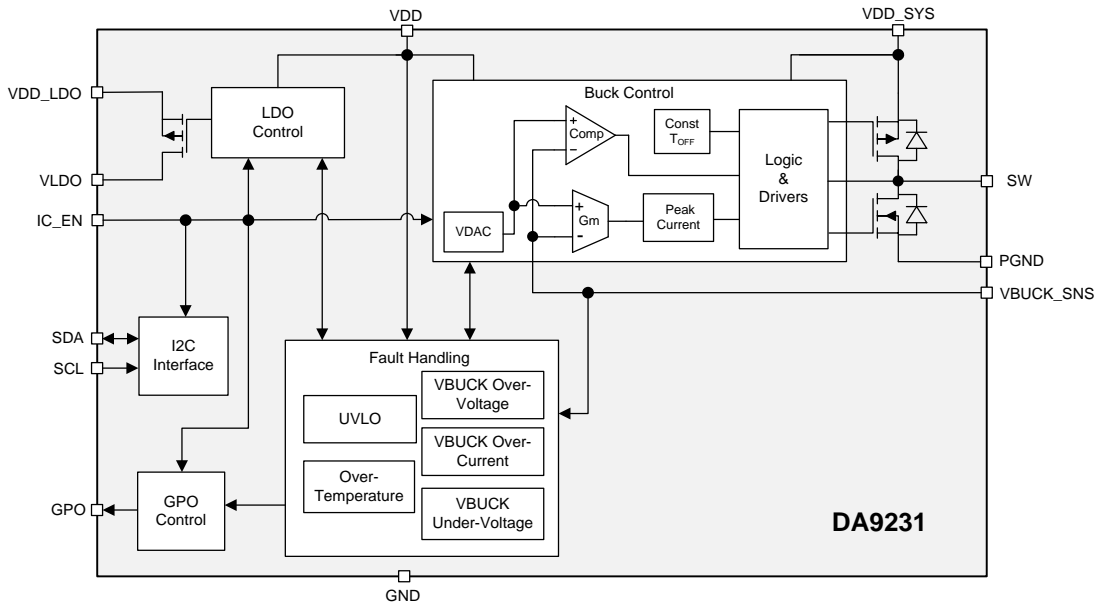


Figure 1: Block Diagram

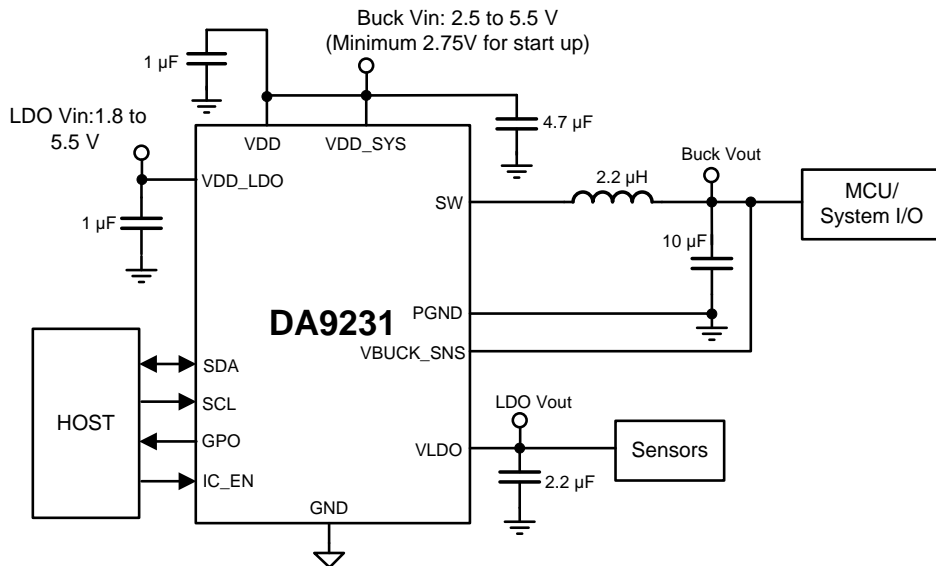


Figure 2: DA9231 Application Diagram

## Ultra-Low Quiescent Current Buck and LDO

### 3 Pinout

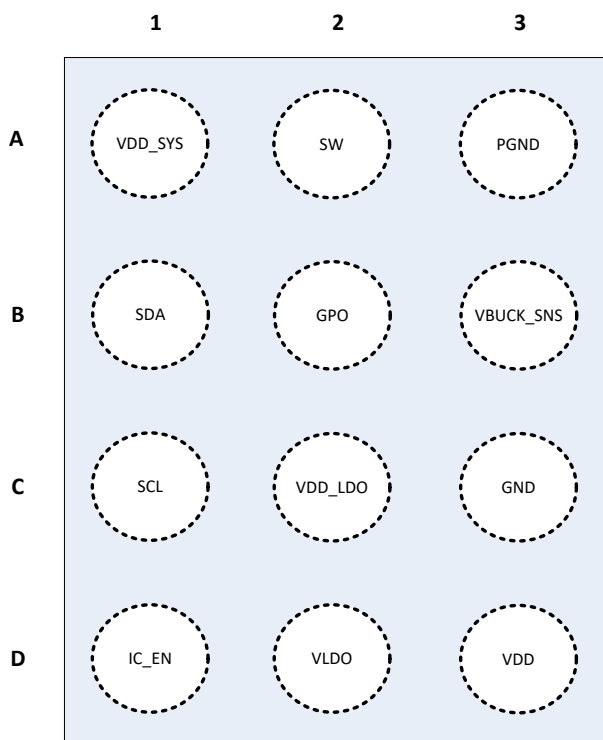


Figure 3: Pinout Diagram (Top View)

Table 1: Pin Description

Pin #	Pin Name	Type (See Table 2)	Drive (mA)	Reset State	Description
A1	VDD_SYS	AI			Buck $V_{IN}$
A2	SW	AIO			Buck switch node
A3	PGND	AIO			Buck ground
B1	SDA	DIO			I <sup>2</sup> C serial data
B2	GPO	DO			General purpose output
B3	VBUCK_SNS	AI			Buck $V_{OUT}$ /feedback voltage
C1	SCL	DI			I <sup>2</sup> C serial clock
C2	VDD_LDO	AI			LDO input voltage
C3	GND	AI			Analog ground
D1	IC_EN	DI			Chip enable
D2	VLDO	AO			LDO output voltage
D3	VDD	AI			Analog $V_{IN}$



---

**Ultra-Low Quiescent Current Buck and LDO**

---

**Table 2: Pin Type Definition**

Pin Type	Description	Pin Type	Description
DI	Digital Input	AI	Analog Input
DO	Digital Output	AO	Analog Output
DIO	Digital Input/Output	AIO	Analog Input/Output
DIOD	Digital Input/Output open Drain	BP	Backdrive Protection
PU	Fixed pull-up resistor	SPU	Switchable pull-up resistor
PD	Fixed pull-down resistor	SPD	Switchable pull-down resistor

## Ultra-Low Quiescent Current Buck and LDO

### 4 Absolute Maximum Ratings

**Table 3: Absolute Maximum Ratings**

Symbol	Description	Conditions	Min	Max	Unit
T <sub>STG</sub>	Storage temperature		-40	125	°C
T <sub>J</sub>	Operating junction temperature		-40	125	°C
V <sub>DD</sub>	Analog VIN pin	Tied to VDD_SYS	-0.3	6	V
V <sub>DD_SYS</sub>	Power VIN pin	Tied to VDD	-0.3	6	V
V <sub>DD_LDO</sub>	LDO Input Voltage pin	VDD_LDO ≤ VDD	-0.3	6	V
I/O pins	Maximum voltage	I/O pin voltage ≤ VDD	-0.3	6	V

Stresses beyond those listed under Absolute maximum ratings may cause permanent damage to the device. These are stress ratings only, so functional operation of the device at these or any other conditions beyond those indicated in the operational sections of the specification are not implied. Exposure to absolute maximum rating conditions for extended periods may affect device reliability.

## Ultra-Low Quiescent Current Buck and LDO

### 5 Recommended Operating Conditions

**Table 4: Recommended Operating Conditions**

Parameter	Description	Conditions	Min	Typ	Max	Unit
V <sub>DD</sub>	Analog V <sub>IN</sub>	VDD= VDD_SYS	2.5 <a href="#">Note 1</a>		5.5	V
V <sub>DD_SYS</sub>	Power V <sub>IN</sub>	VDD= VDD_SYS	2.5 <a href="#">Note 1</a>		5.5	V
V <sub>DD_LDO</sub>	Input voltage range for LDO mode	VDD_LDO ≤ VDD	1.8		5.5	V
	Input voltage range for Load switch mode	VDD_LDO ≤ VDD	0.8		5.5	V

**Note 1** Requires minimum 2.75 V for start-up. Once started, input voltage can go down to 2.5 V.

## Ultra-Low Quiescent Current Buck and LDO

### 6 ESD Ratings

Parameter	Description	Conditions	Value	Unit
V <sub>ESD</sub>	Electrostatic discharge	Human body model (HBM), per ANSI/ESDA/JEDEC JS-001 <a href="#">Note 2</a>	± 2000	V
		Charged device model (CDM), per JEDEC specification JESD22-C101 <a href="#">Note 3</a>	± 500	

**Note 2** JEDEC document JEP155 states that 500-V HBM allows safe manufacturing with a standard ESD control process.

**Note 3** JEDEC document JEP157 states that 250-V CDM allows safe manufacturing with a standard ESD control process.

## Ultra-Low Quiescent Current Buck and LDO

### 7 Electrical Characteristics

VDD = VDD\_SYS = 3.6 V, T<sub>J</sub> = -40°C to 85°C. Typical values are at T<sub>J</sub> = 25°C (unless otherwise noted).

**Table 5: Input Currents**

Symbol	Parameter	Conditions	Min	Typ	Max	Unit
<b>Electrical performance</b>						
I <sub>Q_BUCK_LD</sub> O_ON_NO_L D	Buck and LDO no load quiescent current	-40 °C < T <sub>J</sub> < 85 °C Buck enabled and regulating with no load LDO enabled 2.5 V ≤ V <sub>VDD_SYS</sub> ≤ 5.5 V V <sub>BUCK</sub> = 1.8 V V <sub>VLDO</sub> = 0.8 V		1.35	4.25	μA
I <sub>Q_BUCK_ON</sub> _NO_LD	Buck no load quiescent current	-40 °C < T <sub>J</sub> < 85 °C Buck enabled and regulating, no load 2.5 V ≤ V <sub>VDD_SYS</sub> ≤ 5.5 V V <sub>BUCK</sub> = 1.8 V		0.75	3.5	μA

**Table 6: Buck Output**

Symbol	Parameter	Conditions	Min	Typ	Max	Unit
<b>Electrical performance</b>						
R <sub>ON_PMOS</sub>	On resistance of PMOS pass device	V <sub>VDD_SYS</sub> = 3.6 V I <sub>OUT</sub> = 50 mA		600	800	mΩ
R <sub>ON_NMOS</sub>	On resistance of NMOS pass device	V <sub>VDD_SYS</sub> = 3.6 V I <sub>OUT</sub> = 50 mA		300	450	mΩ
R <sub>SYS_DHCG</sub>	MOSFET on-resistance for buck discharge	V <sub>VDD_SYS</sub> = 3.6 V I <sub>OUT</sub> = -10 mA into V <sub>OUT</sub> pin		33		Ω
t <sub>START</sub>	Buck start-up time	V <sub>VDD_SYS</sub> = 3.6 V V <sub>BUCK</sub> = 1.8 V I <sub>OUT</sub> = 0 A from BUCK_EN = 1 to switching start		3		ms
I <sub>LIM_SW_PM</sub> OS	SW current limit PMOS	V <sub>VDD_SYS</sub> = 3.6 V V <sub>BUCK</sub> = 1.8 V		600		mA
t <sub>OFF</sub>	Off time in continuous conduction mode	V <sub>BUCK</sub> = 1.8 V		270		ns
f <sub>SW</sub>	Switching frequency in continuous conduction mode				3	MHz
I <sub>OUT_MAX</sub>	Maximum DC output current		300			mA

## Ultra-Low Quiescent Current Buck and LDO

Symbol	Parameter	Conditions	Min	Typ	Max	Unit
I <sub>LIM_PMOS_SOFTSTART</sub>	PMOS switch current limit during softstart	Current limit is reduced during softstart		350		mA
V <sub>OUT_VBUC_K_SNS</sub>	Buck output voltage range	Programable range, 50 mV steps	0.6		1.9	V
V <sub>OUT_VBUC_K_SNS_HI</sub>	Buck output voltage range	HI programable range, 50 mV steps V <sub>OUT_RANGE_HI</sub> = 1	1.3		1.9	V
V <sub>OUT_VBUC_K_SNS_LO</sub>	Buck output voltage range	LO programable range, 50 mV steps V <sub>OUT_RANGE_HI</sub> = 0	0.6		1.3	V
V <sub>OUT_VBUC_K_ACC</sub>	Buck output voltage accuracy	V <sub>VDD_SYS</sub> = 5 V PFM mode I <sub>OUT</sub> = 10 mA V <sub>OUT_RANGE_HI</sub> = 1 V <sub>BUCK</sub> = 1.8 V	-2.5	0	2.5	%
V <sub>OUT_PWM_LD2</sub>	DC output voltage load regulation in CCM mode	V <sub>BUCK</sub> = 1.8 V Load range		0.01		%/mA
V <sub>OUT_PWM_LINE2</sub>	DC output voltage line regulation in CCM mode	V <sub>BUCK</sub> = 1.8 V I <sub>OUT</sub> = 200 mA V <sub>DD</sub> range		0.1		%/V

**Table 7: Bypass/LDO Output**

Symbol	Parameter	Conditions	Min	Typ	Max	Unit
<b>Electrical performance</b>						
V <sub>IN_LDSW</sub>	Input voltage range for LDO	Bypass mode V <sub>VDD_LDO</sub> ≤ V <sub>VDD</sub>	0.8		5.5	V
V <sub>IN_LDO</sub>	Input voltage range for LDO	LDO mode V <sub>VDD_LDO</sub> ≤ V <sub>VDD</sub>	1.8		5.5	V
V <sub>OUT_ACC</sub>	DC output accuracy	Over V <sub>DD_LDO</sub> , I <sub>OUT</sub> , temperature	-3		3	%
V <sub>OUT_LDO</sub>	Output range for LDO	Programmable range, 100 mV steps	0.7		3.3	V
V <sub>OUT_LINE</sub>	DC line regulation	I <sub>OUT</sub> = 10 mA	-0.8		0.8	%
V <sub>OUT_LD</sub>	DC load regulation	I <sub>OUT</sub> = 100 mA V <sub>VDD_LDO</sub> - V <sub>VLDO</sub> ≥ 0.2 V		-2		%
V <sub>OUT_TR_LD</sub>	Load transient	2 μA to 100 mA in 1 μs V <sub>VDD_LDO</sub> ≥ 2.2 V V <sub>VDD_LDO</sub> - V <sub>VLDO</sub> ≥ 0.2 V C <sub>OUT_LDO</sub> = 1 μF	-100		100	mV

## Ultra-Low Quiescent Current Buck and LDO

Symbol	Parameter	Conditions	Min	Typ	Max	Unit
$V_{OUT\_TR\_L\_D\_LO}$	Load transient	2 $\mu$ A to 100 mA in 1 $\mu$ s $V_{VDD\_LDO} < 2.2$ V $V_{VDD\_LDO} - V_{VLDO} \geq 0.2$ V $C_{OUT\_LDO} = 1$ $\mu$ F	-250		270	mV
$R_{ON\_LDO}$	On resistance of LDO	$V_{VDD\_LDO} = 3.7$ V		350		m $\Omega$
$R_{DHCG\_LDO\_ON}$	MOSFET on-resistance for LDO discharge	$I_{LOAD} = -10$ mA		27	80	$\Omega$
$I_{OUT\_MAX\_LDO}$	Output current capability in LDO mode	$V_{VDD\_LDO} = 3.6$ V $V_{VLDO} = 3.3$ V			100	mA
$I_{OUT\_MAX\_LS}$	Output current capability in Load Switch mode				100	mA

**Table 8: GPO – Electrical Performance**

Symbol	Parameter	Conditions	Min	Typ	Max	Unit
<b>Electrical performance</b>						
$R_{PD}$	GPO pull-down resistance	$V_{VDD\_SYS} = 3.6$ V		12		$\Omega$
$V_{OH}$	GPO Output high voltage	$V_{PULLUP} = 1.8$ V	1.4			V
$V_{OL}$	GPO Output low voltage	$V_{PULLUP} = 1.8$ V			0.4	V

**Table 9: I2C interface**

Symbol	Parameter	Conditions	Min	Typ	Max	Unit
<b>Electrical performance</b>						
$f_{I2C\_CLK}$	I <sup>2</sup> C bus specification standard and fast mode frequency support		100		400	kHz
$V_{IN\_HI\_THR}$	Input high threshold level for SDA and SCL		1.4			V
$V_{IN\_LO\_THR}$	Input low threshold level for SDA and SCL				0.4	V
$V_{OUT\_LO\_THR}$	Output low threshold level for SDA				0.4	V
$I_{LKG\_HILVL}$	High-level leakage current for SDA and SCL.	$V_{PU} = V_{VDD}$ SDA and SCL			1	$\mu$ A

---



---

**Ultra-Low Quiescent Current Buck and LDO**
**Table 10: Analog Core**

Symbol	Parameter	Conditions	Min	Typ	Max	Unit
<b>Electrical performance</b>						
T <sub>SHDN_HYS</sub>	Thermal shut-down hysteresis			20		°C
T <sub>SHDN_THR</sub>	Thermal shut-down threshold			125		°C
V <sub>TH_UVLO</sub>	Under-voltage lockout threshold	Input voltage falling	2.4		2.5	V
V <sub>TH_UVLO_RISE</sub>	Under-voltage lockout threshold rising.	Input voltage rising.			2.75	V
V <sub>HYS_UVLO</sub>	Under-voltage lockout hysteresis	Input voltage rising		200		mV



---

**Ultra-Low Quiescent Current Buck and LDO****8 Thermal Characteristics****Table 11: Thermal Characteristics**

Parameter	Description	Conditions	Typ	Unit
R <sub>TH_JA</sub>	Junction-to-ambient thermal resistance	JEDEC 6-layer PCB, no airflow	73.2	°C/W
Ψ <sub>JT</sub>	Junction-to-top characterization parameter	JEDEC 6-layer PCB, no airflow	6.66	°C/W
R <sub>TH_JB</sub>	Junction-to-board thermal resistance	JEDEC 6-layer PCB, no airflow	34.8	°C/W

## Ultra-Low Quiescent Current Buck and LDO

### 9 Typical Operating Characteristics

Test Circuit of [Figure 2](#), Buck  $V_{IN} = VDD\_SYS = VDD$ ,  $L = 2.2 \mu H$  (170 m $\Omega$ ),  $T_A = 25 \text{ }^\circ C$ , unless specified otherwise.

#### 9.1 Buck No Load Quiescent Current vs Temperature, Device is Switching

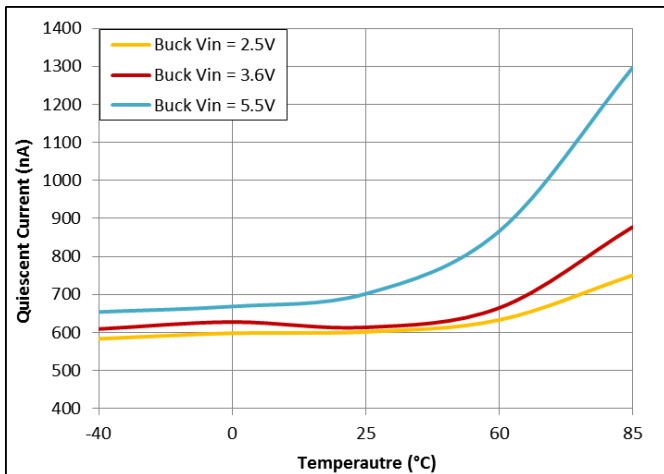


Figure 4: Buck  $V_{OUT} = 1.8 \text{ V}$

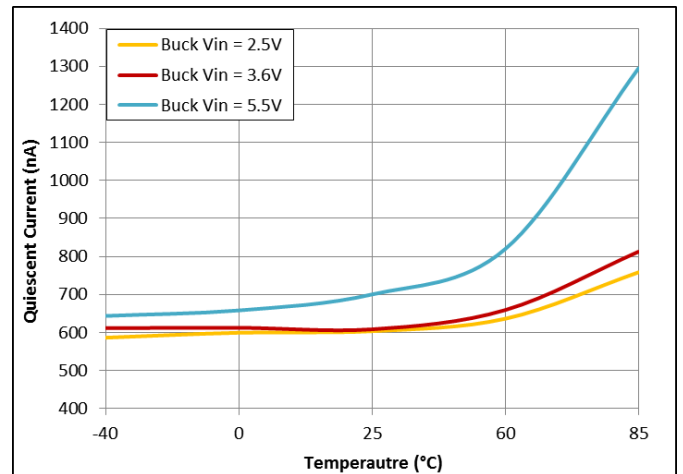


Figure 5: Buck  $V_{OUT} = 0.9 \text{ V}$

#### 9.2 Buck and LDO No Load Quiescent Current vs Temperature, Device is Switching

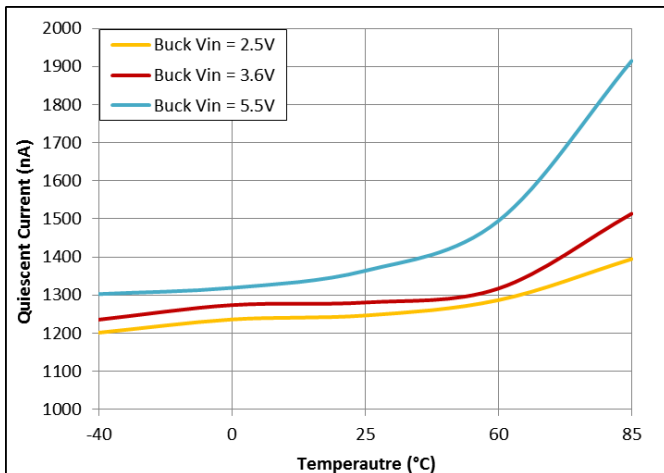


Figure 6: Buck  $V_{OUT} = 1.8 \text{ V}$ , LDO  $V_{OUT} = 0.8 \text{ V}$

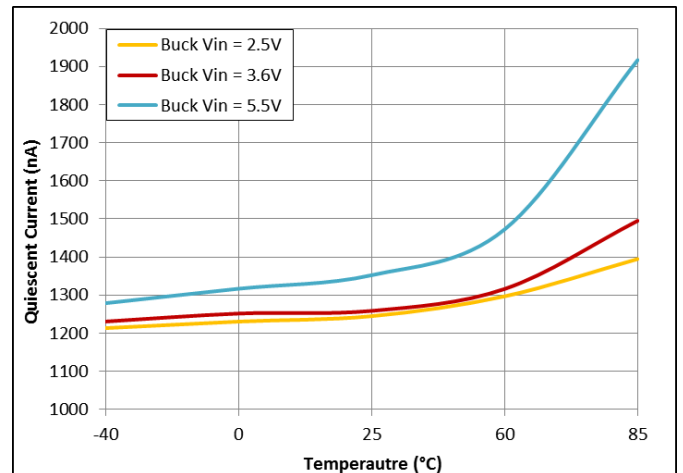


Figure 7: Buck  $V_{OUT} = 0.9 \text{ V}$ , LDO  $V_{OUT} = 0.8 \text{ V}$

Ultra-Low Quiescent Current Buck and LDO

9.3 RDSon vs Temperature

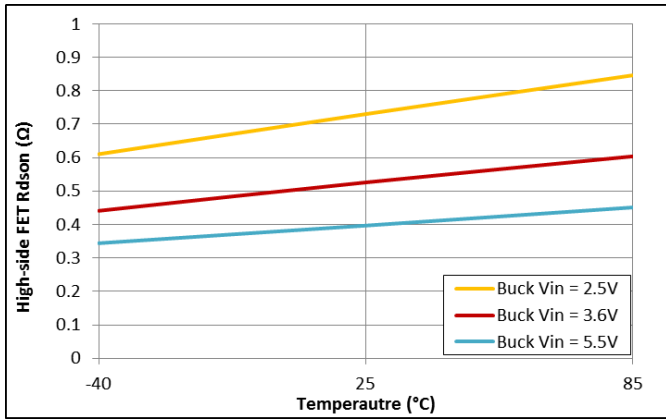


Figure 8: High-Side FET

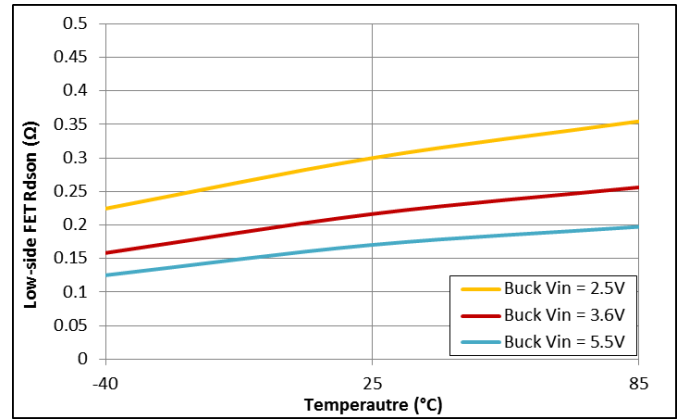


Figure 9: Low-Side FET

9.4 Efficiency vs Load Current

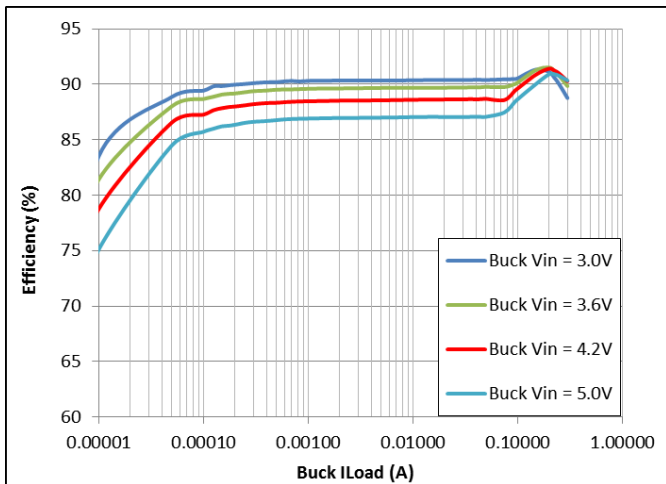


Figure 10: Buck V<sub>OUT</sub> = 1.9 V

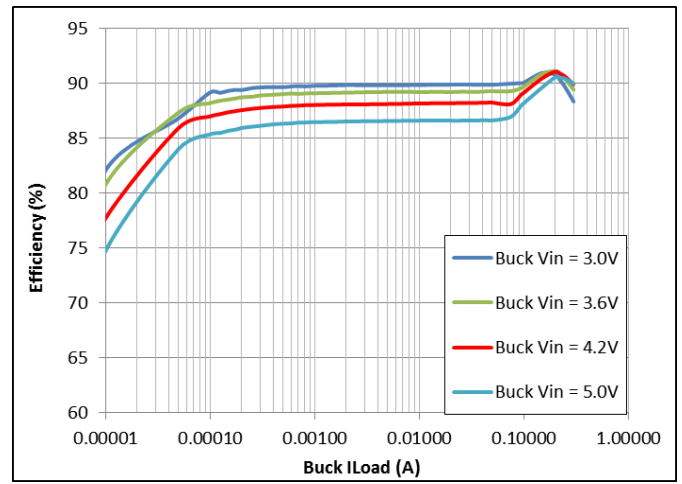


Figure 11: Buck V<sub>OUT</sub> = 1.8 V

Ultra-Low Quiescent Current Buck and LDO

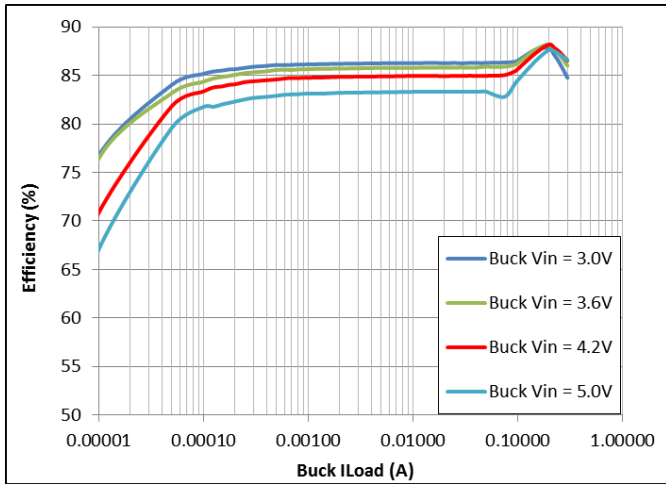


Figure 12: Buck V<sub>OUT</sub> = 1.2 V

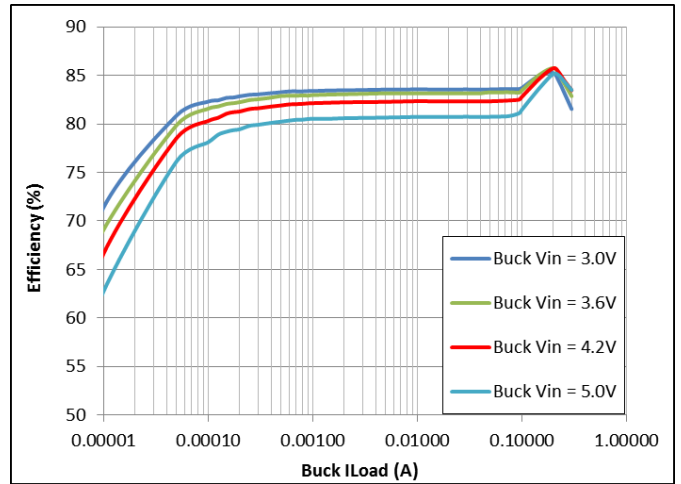


Figure 13: Buck V<sub>OUT</sub> = 0.9 V

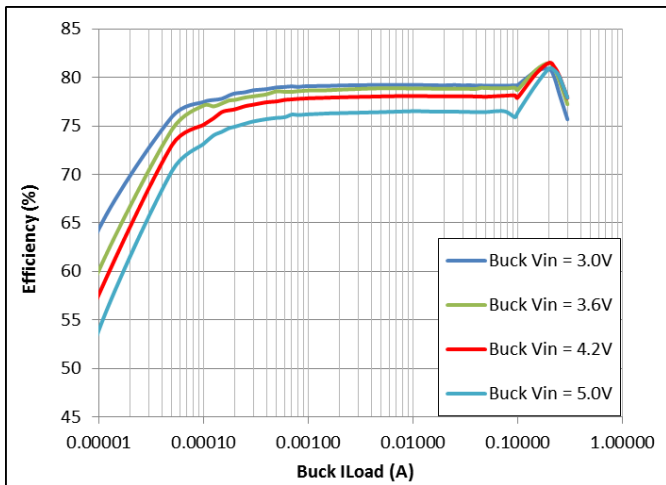


Figure 14: Buck V<sub>OUT</sub> = 0.6 V

Ultra-Low Quiescent Current Buck and LDO

9.5 Switching Frequency vs Load Current

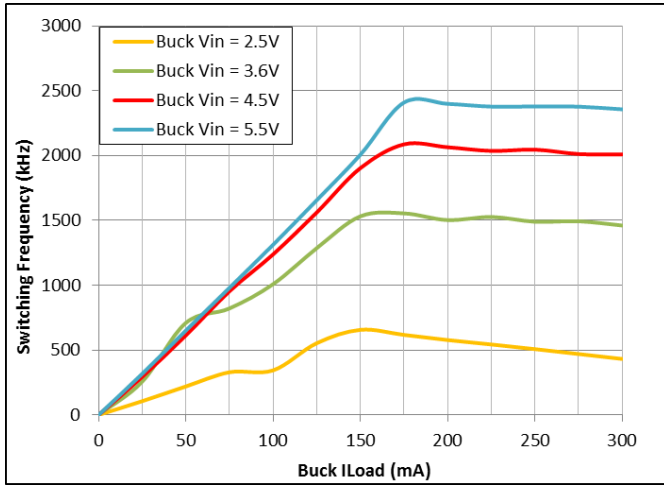


Figure 15: Buck V<sub>OUT</sub> = 1.9 V

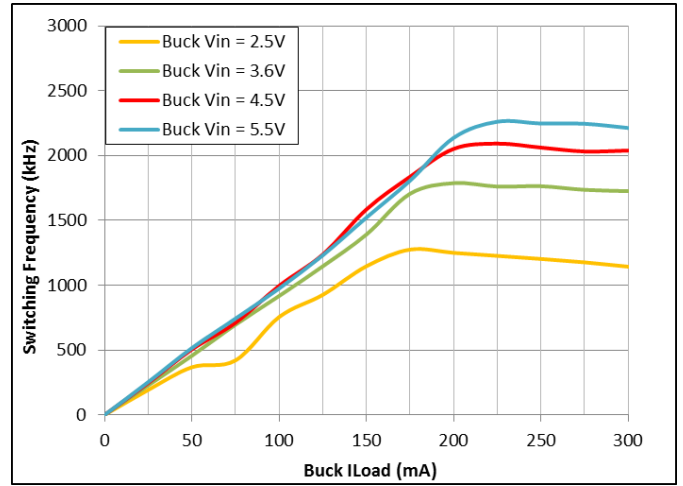


Figure 17: Buck V<sub>OUT</sub> = 1.2 V

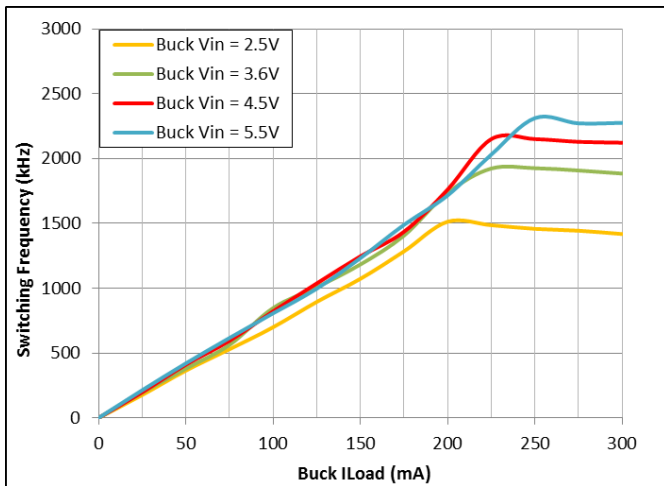


Figure 16: Buck V<sub>OUT</sub> = 0.9 V

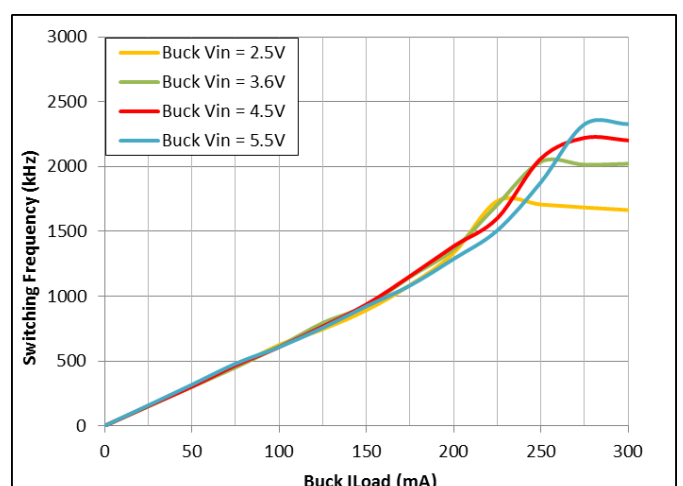


Figure 18: Buck V<sub>OUT</sub> = 0.6 V

Ultra-Low Quiescent Current Buck and LDO

9.6 Buck V<sub>OUT</sub> Ripple vs Load Current

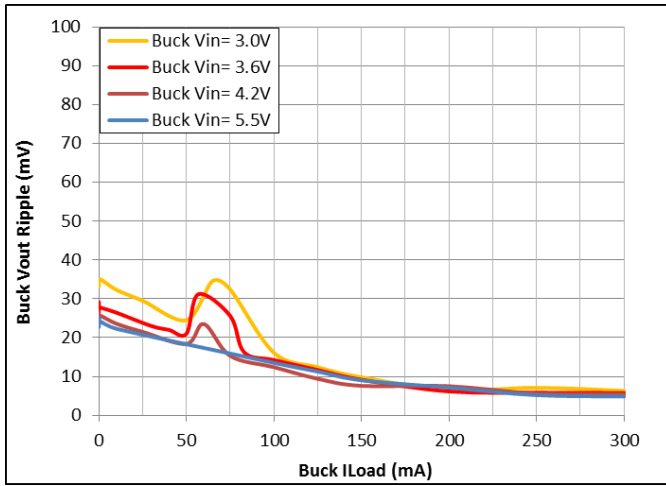


Figure 19: Buck V<sub>OUT</sub> = 1.9 V

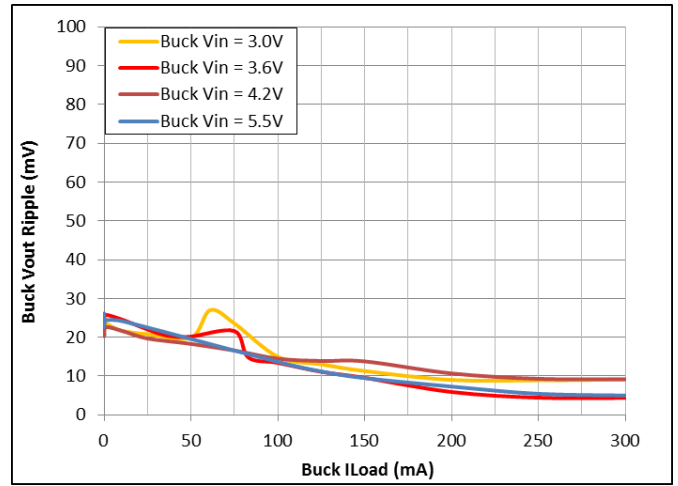


Figure 20: Buck V<sub>OUT</sub> = 1.3 V

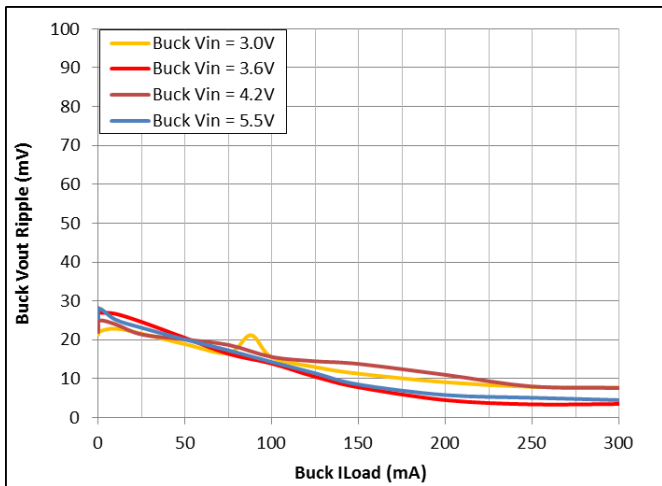


Figure 21: Buck V<sub>OUT</sub> = 0.9 V

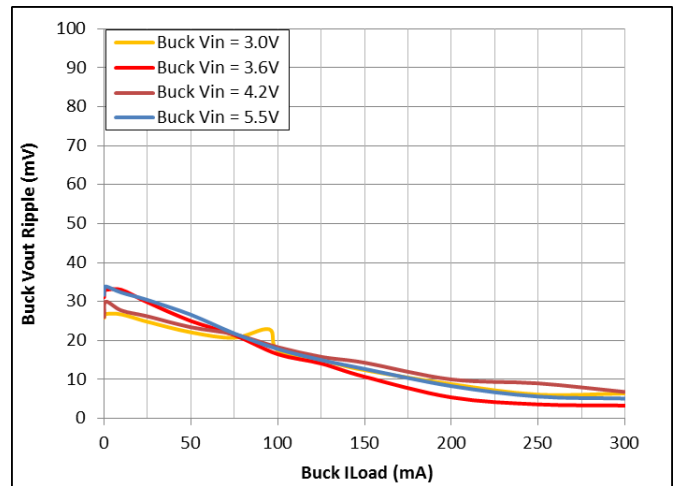


Figure 22: Buck V<sub>OUT</sub> = 0.6 V

Ultra-Low Quiescent Current Buck and LDO

9.7 Buck  $V_{OUT}$  vs Load Current

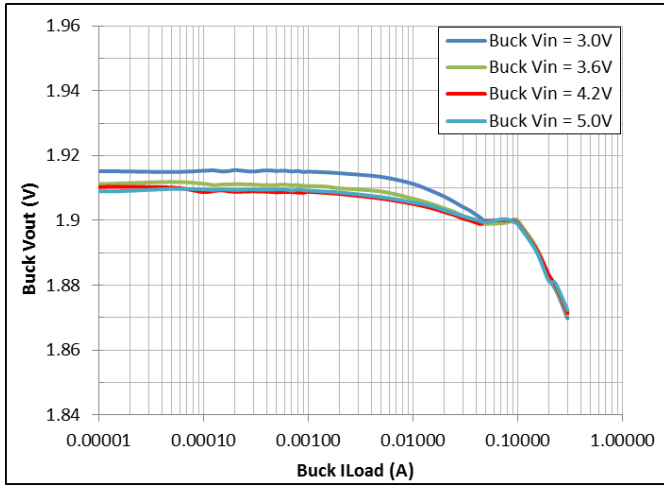


Figure 23: Buck  $V_{OUT}$  = 1.9 V

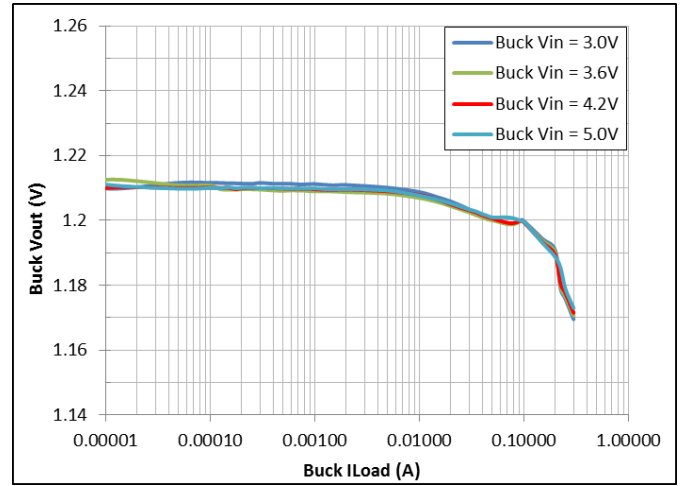


Figure 24: Buck  $V_{OUT}$  = 1.2 V

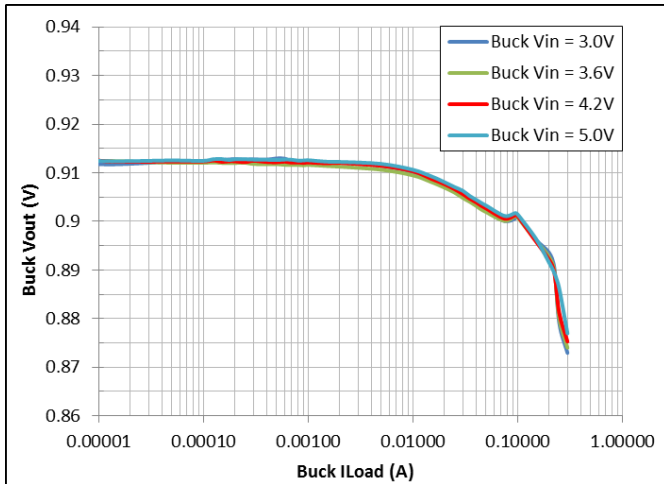


Figure 25: Buck  $V_{OUT}$  = 0.9 V

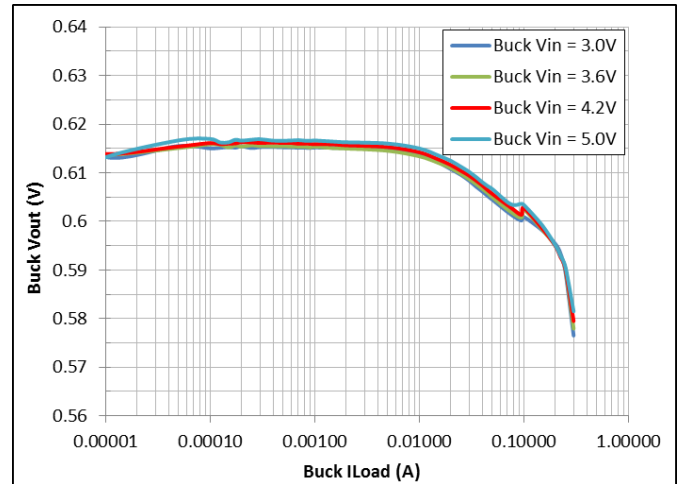
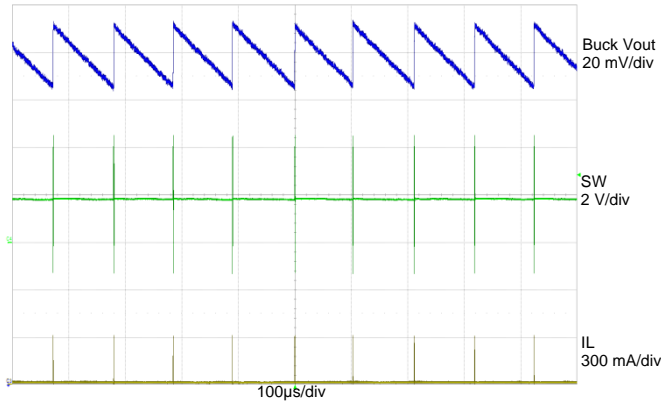


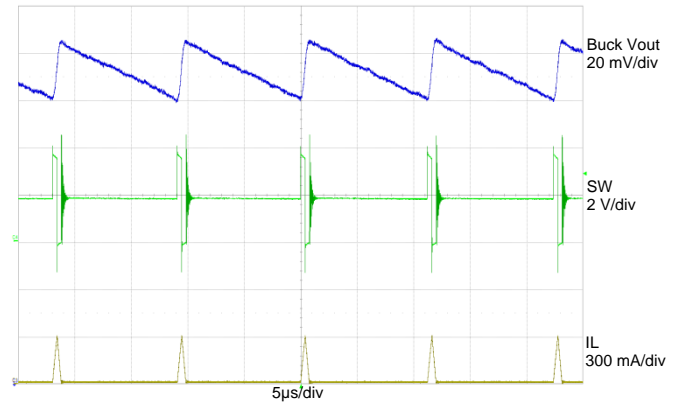
Figure 26: Buck  $V_{OUT}$  = 0.6 V

## Ultra-Low Quiescent Current Buck and LDO

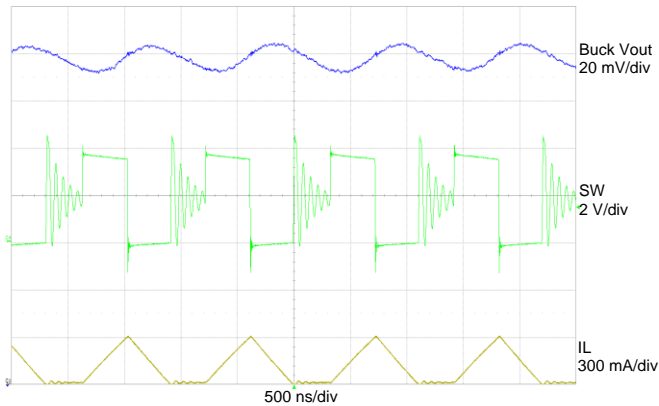
### 9.8 Typical Mode Operation



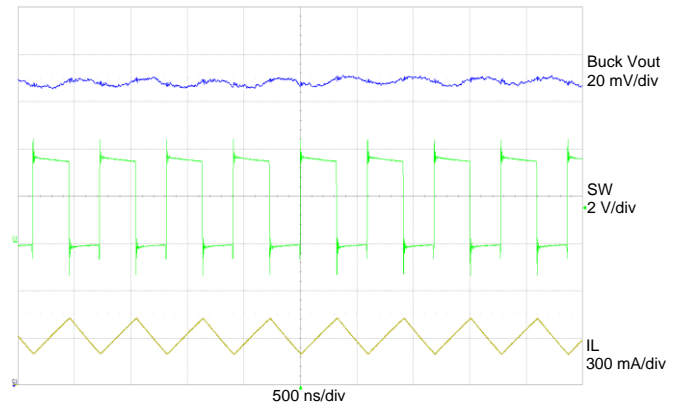
**Figure 27: Buck  $V_{IN} = 3.6$  V, Buck  $V_{OUT} = 1.8$  V,  
Buck  $I_{LOAD} = 1$  mA**



**Figure 28: Buck  $V_{IN} = 3.6$  V, Buck  $V_{OUT} = 1.8$  V,  
Buck  $I_{LOAD} = 10$  mA**



**Figure 29: Buck  $V_{IN} = 3.6$  V, Buck  $V_{OUT} = 1.8$  V,  
Buck  $I_{LOAD} = 100$  mA**

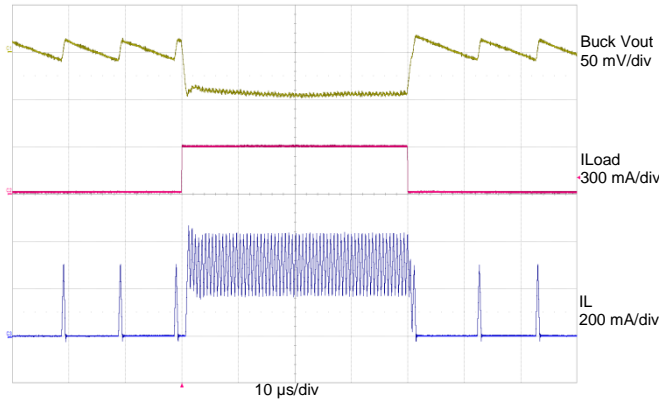


**Figure 30: Buck  $V_{IN} = 3.6$  V, Buck  $V_{OUT} = 1.8$  V,  
Buck  $I_{LOAD} = 300$  mA**

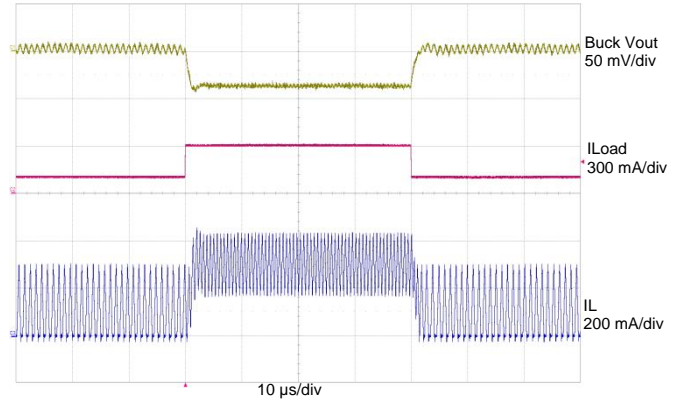


## Ultra-Low Quiescent Current Buck and LDO

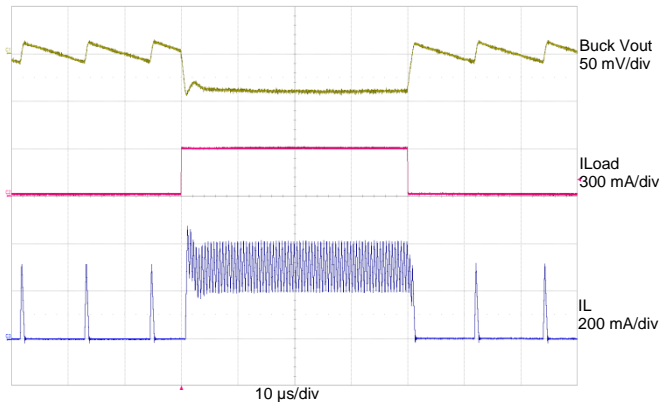
### 9.9 Buck Load Transient Response



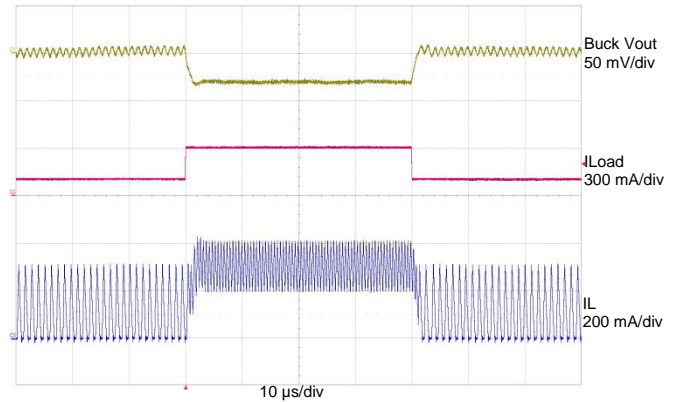
**Figure 31:** Buck  $I_{LOAD} = 10 \text{ mA}$  to  $300 \text{ mA}$  to  $10 \text{ mA}$  ( $0.3 \text{ A}/\mu\text{s}$ ); Buck  $V_{IN} = 3.6 \text{ V}$ , Buck  $V_{OUT} = 1.8 \text{ V}$



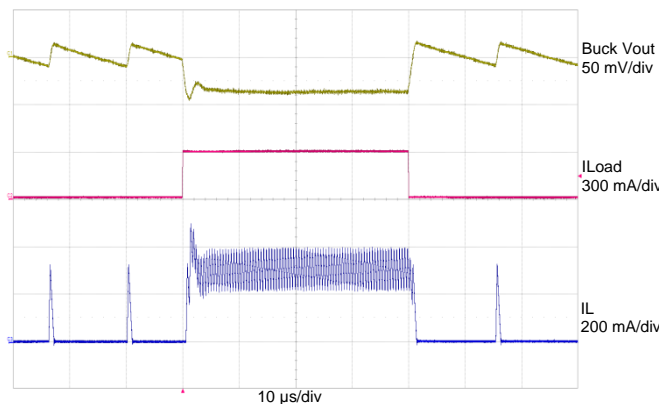
**Figure 32:** Buck  $I_{LOAD} = 100 \text{ mA}$  to  $300 \text{ mA}$  to  $100 \text{ mA}$  ( $0.2 \text{ A}/\mu\text{s}$ ); Buck  $V_{IN} = 3.6 \text{ V}$ , Buck  $V_{OUT} = 1.8 \text{ V}$



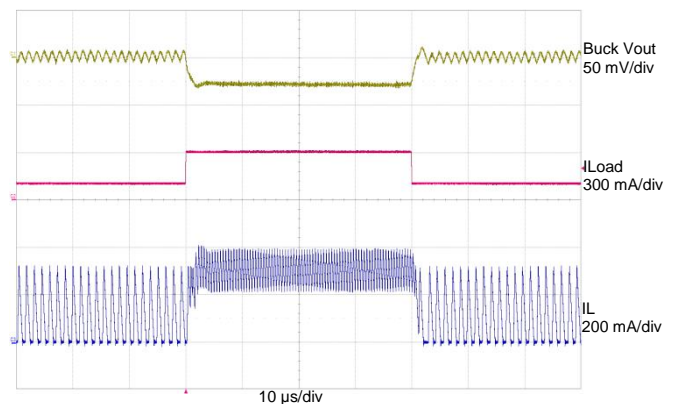
**Figure 33:** Buck  $I_{LOAD} = 10 \text{ mA}$  to  $300 \text{ mA}$  to  $10 \text{ mA}$  ( $0.3 \text{ A}/\mu\text{s}$ ); Buck  $V_{IN} = 3.6 \text{ V}$ , Buck  $V_{OUT} = 1.2 \text{ V}$



**Figure 34:** Buck  $I_{LOAD} = 100 \text{ mA}$  to  $300 \text{ mA}$  to  $100 \text{ mA}$  ( $0.2 \text{ A}/\mu\text{s}$ ); Buck  $V_{IN} = 3.6 \text{ V}$ , Buck  $V_{OUT} = 1.2 \text{ V}$

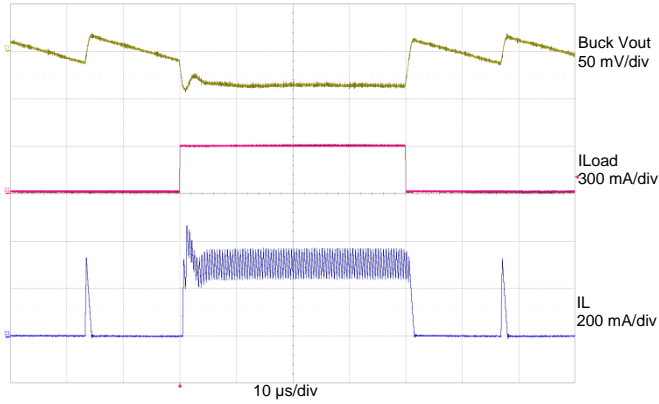


**Figure 35:** Buck  $I_{LOAD} = 10 \text{ mA}$  to  $300 \text{ mA}$  to  $10 \text{ mA}$  ( $0.3 \text{ A}/\mu\text{s}$ ); Buck  $V_{IN} = 3.6 \text{ V}$ , Buck  $V_{OUT} = 0.9 \text{ V}$

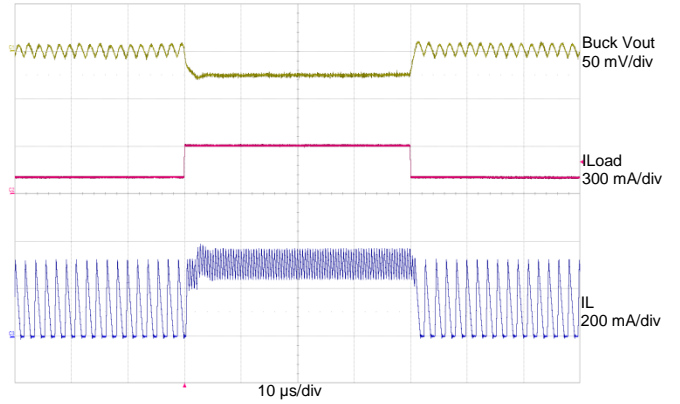


**Figure 36:** Buck  $I_{LOAD} = 100 \text{ mA}$  to  $300 \text{ mA}$  to  $100 \text{ mA}$  ( $0.2 \text{ A}/\mu\text{s}$ ); Buck  $V_{IN} = 3.6 \text{ V}$ , Buck  $V_{OUT} = 0.9 \text{ V}$

Ultra-Low Quiescent Current Buck and LDO

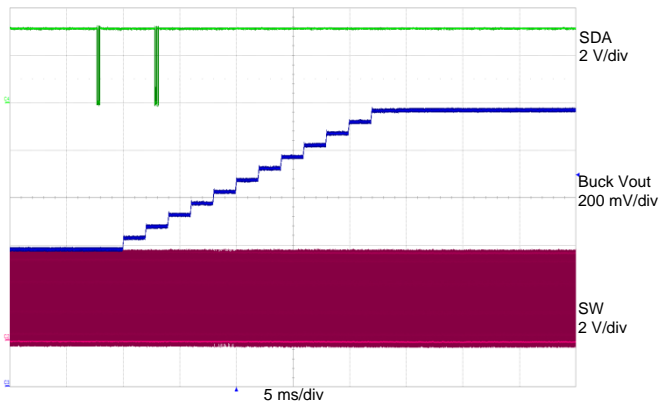


**Figure 37: Buck  $I_{LOAD} = 10\text{ mA}$  to  $300\text{ mA}$  to  $10\text{ mA}$  ( $0.3\text{ A}/\mu\text{s}$ ); Buck  $V_{IN} = 3.6\text{ V}$ , Buck  $V_{OUT} = 0.6\text{ V}$**

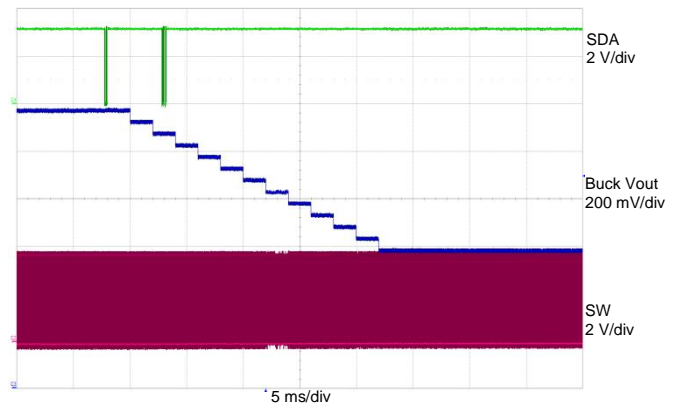


**Figure 38: Buck  $I_{LOAD} = 100\text{ mA}$  to  $300\text{ mA}$  to  $100\text{ mA}$  ( $0.2\text{ A}/\mu\text{s}$ ); Buck  $V_{IN} = 3.6\text{ V}$ , Buck  $V_{OUT} = 0.6\text{ V}$**

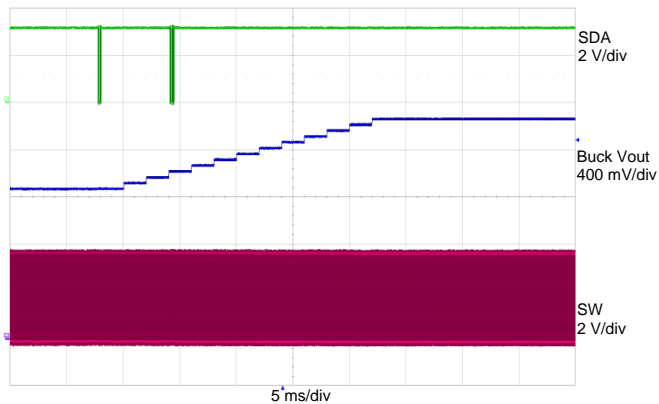
9.10 Buck Dynamic Voltage Control



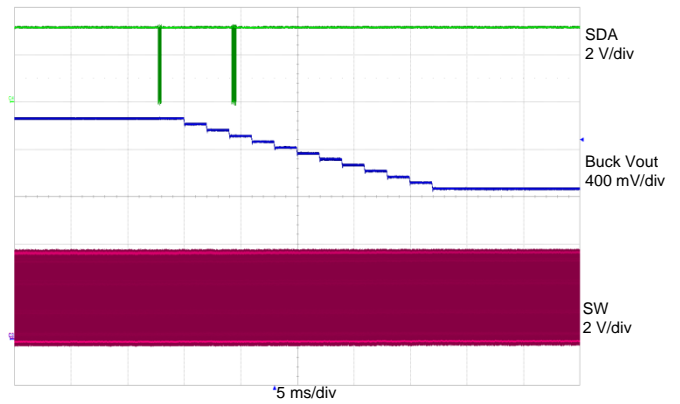
**Figure 39: Buck  $V_{OUT} 0.6\text{ V}$  to  $1.2\text{ V}$ ; Buck  $V_{IN} = 3.6\text{ V}$ , Buck  $I_{LOAD} = 300\text{ mA}$**



**Figure 40: Buck  $V_{OUT} 1.2\text{ V}$  to  $0.6\text{ V}$ ; Buck  $V_{IN} = 3.6\text{ V}$ , Buck  $I_{LOAD} = 300\text{ mA}$**



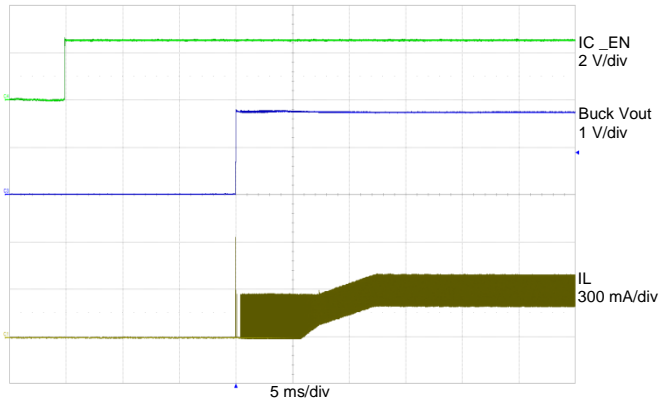
**Figure 41: Buck  $V_{OUT} 1.3\text{ V}$  to  $1.9\text{ V}$ ; Buck  $V_{IN} = 3.6\text{ V}$ , Buck  $I_{LOAD} = 300\text{ mA}$**



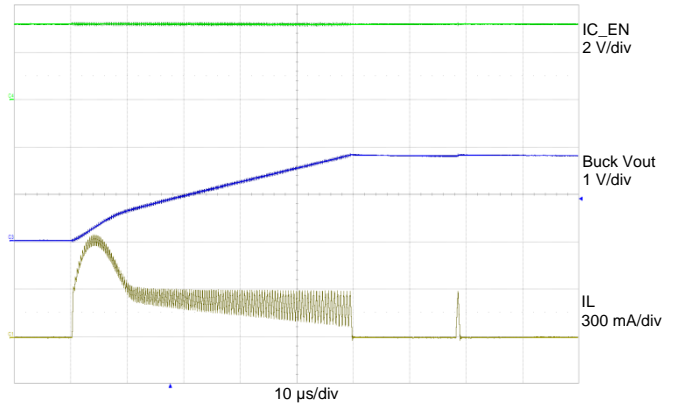
**Figure 42: Buck  $V_{OUT} 1.9\text{ V}$  to  $1.3\text{ V}$ ; Buck  $V_{IN} = 3.6\text{ V}$ , Buck  $I_{LOAD} = 300\text{ mA}$**

Ultra-Low Quiescent Current Buck and LDO

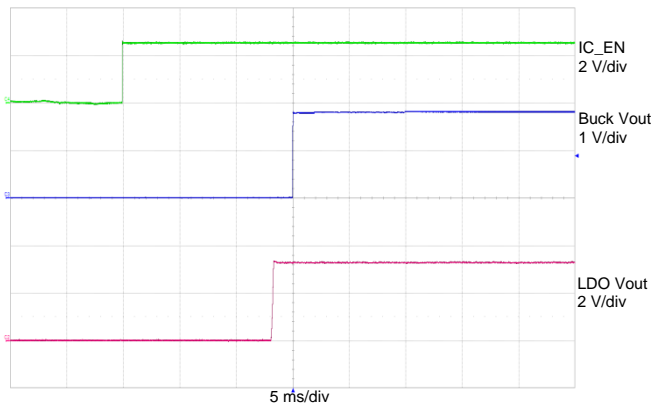
9.11 Device Enable and Start up



**Figure 43: Device Enable:**  
**Buck  $V_{IN}$  = 3.6 V, Buck  $V_{OUT}$  1.8 V,**  
**Buck  $I_{LOAD}$  = 300 mA**



**Figure 44:  $V_{OUT}$  ramp-up after Enabled**  
**(Zoom-in of Figure 43)**



**Figure 45: Device Enable:**  
**Buck  $V_{IN}$  = LDO  $V_{IN}$  = 3.6 V,**  
**Buck  $V_{OUT}$  = 1.8 V, LDO  $V_{OUT}$  = 3.3 V**

Ultra-Low Quiescent Current Buck and LDO

9.12 LDO V<sub>OUT</sub> Accuracy

LDO V<sub>OUT</sub> Accuracy is calculated based on equation:

$$100\% \times (\text{Actual LDO output voltage} - \text{Target LDO output voltage}) / \text{Target LDO output voltage}$$

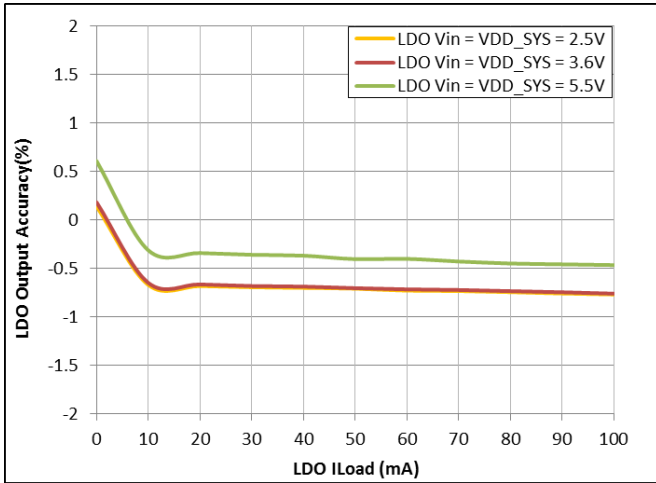


Figure 46: LDO V<sub>OUT</sub> = 0.8 V

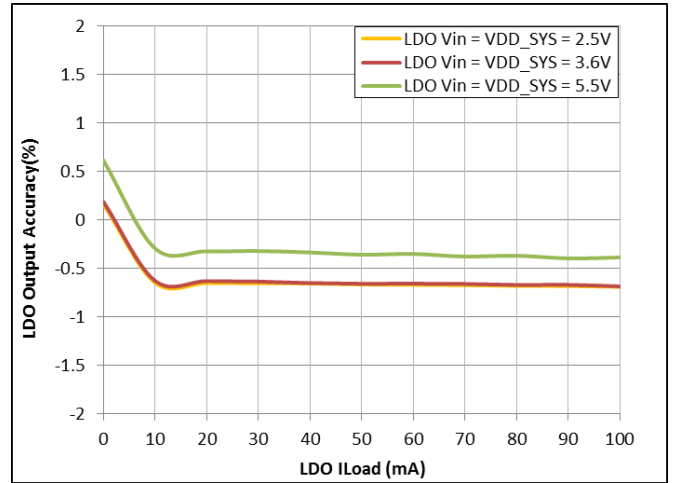


Figure 47: LDO V<sub>OUT</sub> = 2 V

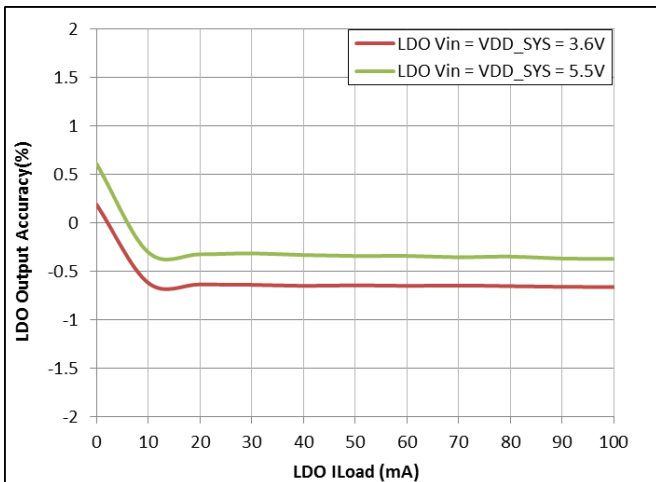
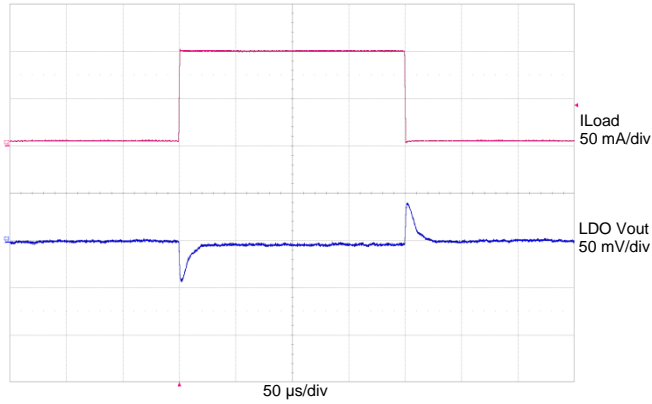


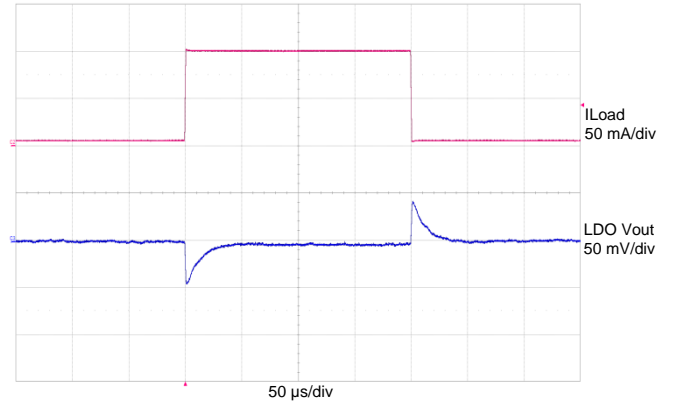
Figure 48: LDO V<sub>OUT</sub> = 3.3 V

## Ultra-Low Quiescent Current Buck and LDO

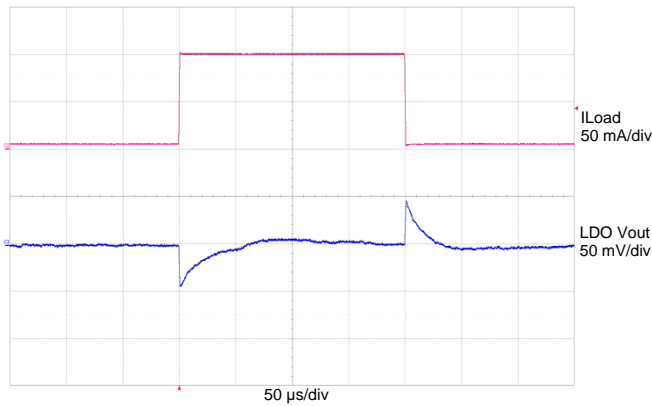
### 9.13 LDO Load Transient Response



**Figure 49: LDO  $I_{LOAD} = 5 \text{ mA}$  to  $100 \text{ mA}$  to  $5 \text{ mA}$   
( $0.1 \text{ A} / 1 \mu\text{s}$ );  
LDO  $V_{IN} = 3.6 \text{ V}$ , LDO  $V_{OUT} = 0.8 \text{ V}$**



**Figure 50: LDO  $I_{LOAD} = 5 \text{ mA}$  to  $100 \text{ mA}$  to  $5 \text{ mA}$   
( $0.1 \text{ A} / 1 \mu\text{s}$ );  
LDO  $V_{IN} = 3.6 \text{ V}$ , LDO  $V_{OUT} = 2 \text{ V}$**



**Figure 51: LDO  $I_{LOAD} = 5 \text{ mA}$  to  $100 \text{ mA}$  to  $5 \text{ mA}$   
( $0.1 \text{ A} / 1 \mu\text{s}$ );  
LDO  $V_{IN} = 3.6 \text{ V}$ , LDO  $V_{OUT} = 3.3 \text{ V}$**

Ultra-Low Quiescent Current Buck and LDO

9.14 LDO PSRR

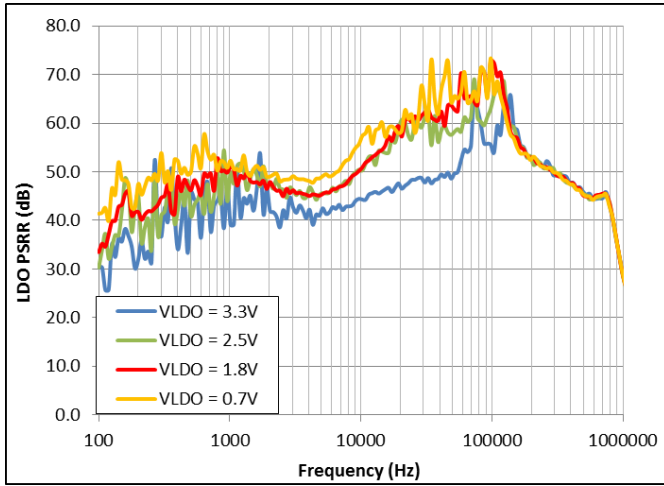


Figure 52: LDO  $V_{IN} = 3.7$  V, LDO No Load

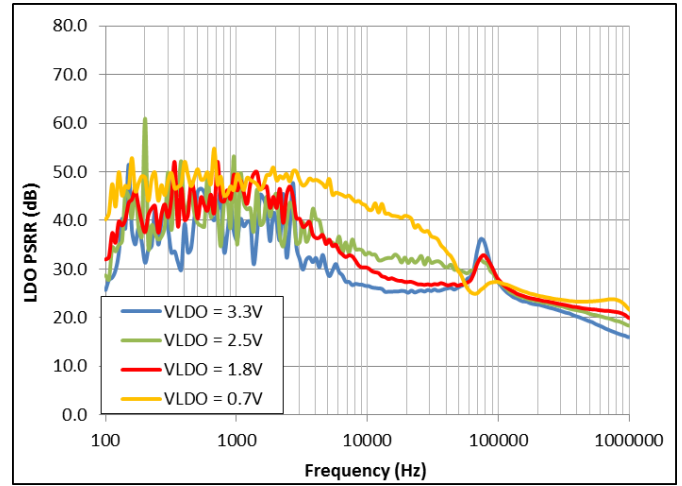


Figure 53: LDO  $V_{IN} = 3.7$  V, LDO  $I_{LOAD} = 100$  mA

## Ultra-Low Quiescent Current Buck and LDO

### 10 Feature Descriptions

#### 10.1 Chip Enable and Disable Through IC\_EN

DA9231 features a dedicated IC\_EN pin to enable and disable the chip. When IC\_EN = high, the device is turned on. IC\_EN voltage should not exceed VDD\_SYS voltage on the device. When EN = low, the device is shut down completely, including I<sup>2</sup>C communications.

#### 10.2 VDD Under-Voltage Lockout

DA9231 features an under-voltage lockout (UVLO) on VDD. When VDD falls below UVLO falling threshold, both buck and LDO are disabled, see Section 10.4.9 for fault behaviour and control, A VIN\_UV\_Event will be flagged if it is not masked. When VDD rises above the UVLO rising threshold, the device will be alive. VDD should be always tied to VDD\_SYS on the PCB board so both VDD and VDD\_SYS will share the same UVLO protection.

#### 10.3 Over-Temperature Protection

DA9231 also features an on-Chip over-temperature protection (TSD). The die junction temperature is monitored when buck is in continuous current Mode or when LDO is ON. When the junction temperature is higher than the thermal shutdown threshold, both buck and LDO are disabled to prevent the device being damaged by over-heating, see Section 10.4.9 for fault behavior and control. An OT\_Event will be flagged if it is not masked.

#### 10.4 Buck Regulator

DA9231 includes a nano-ampere standby buck regulator with an adjustable output voltage, Dynamic Voltage Scaling capability and a maximum load current of 300 mA. It also has power saving mode operation and different protection features.

##### 10.4.1 Buck Output Voltage Programmability

The DA9231 buck regulator can be set to two different ranges based on the value of VOUT\_RANGE\_HI. The value of BUCK\_VOUT<4:0> is locked to a certain range based on the value of VOUT\_RANGE\_HI and VOUT\_RANGE\_HI can only be changed while the buck is disabled. The buck can be set to the output voltages shown in Table 12. If a command is received outside of the allowable range (that is above 1.3 V for VOUT\_RANGE\_HI = 0 or below 1.3 V for VOUT\_RANGE\_HI = 1), digital will force the value of BUCK\_VOUT<3:0> to 01110 (1.3 V).

**Table 12: Buck Output Voltage Settings**

VOUT_RANGE_HI	BUCK_VOUT<4:0>	Buck Output Voltage (V)
0	00000	0.60
0	00001	0.65
0	00010	0.70
0	00011	0.75
0	00100	0.80
0	00101	0.85
0	00110	0.90
0	00111	0.95

## Ultra-Low Quiescent Current Buck and LDO

VOUT_RANGE_HI	BUCK_VOUT<4:0>	Buck Output Voltage (V)
0	01000	1.00
0	01001	1.05
0	01010	1.10
0	01011	1.15
0	01100	1.20
0	01101	1.25
0 or 1	01110	1.30
1	01111	1.35
1	10000	1.40
1	10001	1.45
1	10010	1.50
1	10011	1.55
1	10100	1.60
1	10101	1.65
1	10110	1.70
1	10111	1.75
1	11000	1.80
1	11001	1.85
1	11010	1.90
1	11011	1.90
1	11100	1.90
1	11101	1.90
1	11110	1.90
1	11111	1.90

### 10.4.2 Start-up Operation

DA9231 buck integrates a start-up circuit to minimize output voltage over-shoot and input voltage drop during start-up. When writing 1 to BUCK\_EN (Bit 7 of Reg0x05), the buck is enabled and starts switching after a typical delay time of 3 ms. During start-up, the cycle-by-cycle current limit is reduced to limit inrush current.

### 10.4.3 Power Saving Mode Operation

DA9231 buck regulator features power saving mode that greatly reduces the quiescent current when device has very light load condition. When load decreases, buck regulator enters discontinuous mode and operates with Pulse Frequency Modulation (PFM). The low-side FET will be turned off based on a zero-crossing comparator to prevent negative inductor current flowing through the FET which can result in additional conduction loss. If both FETs remain in the OFF state for a certain delay time after inductor current crosses zero, the device will enter power saving mode. In power saving mode, DA9231 shuts down most of the internal circuitry to save current consumption. The



## Ultra-Low Quiescent Current Buck and LDO

lighter the load, the longer the duration of power saving mode will be, to achieve the lowest quiescent current and improve light load efficiency.

### 10.4.4 Dynamic Voltage Control

DA9231 buck regulator has dynamic voltage control (DVC) feature which allows the buck output voltage to track the internal reference voltage when it changes at a rate of 50 mV/2 ms. Since the buck output voltage can only be changed within an allowable range while still keeping the buck enabled; DVC also follows the same behaviour. The DVC is done via I<sup>2</sup>C, whereby the buck output voltage setting is stepped in 50 mV steps within either the low range or high range. Each voltage step lasts for 2 ms.

### 10.4.5 Cycle-by-cycle Over-Current Protection

For the Over-current Protection (OCP) in DA9231, the peak current through high-side FET is monitored cycle-by-cycle. When the sensed current exceeds the pre-set current limit, the high-side FET will be turned OFF immediately to limit the inductor current. The high-side FET will be turned on again after the constant-off time expires. If the OC condition persists for 64  $\mu$ s, buck will be forced off and buck output will be pull-down until the fault clears, see Section 10.4.9 for fault behavior and control and Section 10.4.8 for output voltage discharge and control. An OC\_BUCK\_Event will be flagged if it is not masked.

### 10.4.6 Output Over-Voltage Protection

DA9231 features an output over-voltage protection (OVP) to protect the load from damage. When both IC\_EN and BUCK\_EN are high and the buck output voltage is 200 mV greater than the internal reference voltage, the high side FET is immediately OFF, see Section 10.4.9 for fault behavior and control. Then the internal buck output discharge FET will be turned on to discharge buck output capacitor, see Section 10.4.8 for output voltage discharge and control. An OV\_BUCK\_Event will be flagged if it is not masked. Buck will remain off and buck output will be pull-down until the fault is cleared.

### 10.4.7 Output Under-Voltage Protection

When buck output short happens, inductor current will increase until the peak reaches the cycle-by-cycle current limit. Then the high-side FET turns OFF and low-side FET turns on. Since buck output is shorted, inductor current slope is very small during low-side FET on time. The inductor current could gradually go higher and higher. To effectively prevent the inductor current running away at V<sub>OUT</sub> short condition, buck V<sub>OUT</sub> is also monitored. If over-current condition happens and buck V<sub>OUT</sub> drops 400 mV below the reference voltage, the buck regulator will be shut off immediately and an UV\_BUCK\_Event will be flagged if it is not masked, see Section 10.4.9 for fault behavior and control.

### 10.4.8 Automatic Output voltage Discharge

To speed up the discharging of buck output capacitor and ensure a safer start-up next time, the buck regulator provides automatic output voltage discharge when IC\_EN is pulled low or buck shutdown caused by any fault. Automatic output discharge when buck is forced OFF by fault needs to set register bit BUCK\_PD\_CFG1 = 0; automatic output discharge when buck is disabled by BUCK\_EN = 0 needs to set register bit BUCK\_PD\_CFG2 = 0. The output of the buck regulator is discharged through VBUCK\_SNS pin and an internal buck output discharge FET with typical 33  $\Omega$  resistance.

## Ultra-Low Quiescent Current Buck and LDO

### 10.4.9 Event Flag and Fault Control

DA9231 has the flexibility for customers to control the behaviour of buck/LDO when there is a fault condition. There are five register bits (UVLO\_FRC\_DIS, TSD\_FRC\_DIS, OV\_DIS\_BUCK, OC\_BUCK\_EVENT, SC\_DIS\_BUCK) controlling whether the buck/LDO will be disabled when the corresponding fault condition happens. In addition, users can choose whether to mask or unmask the event flag when the fault condition happens.

When there is a VDD Under-voltage condition, both BUCK and LDO will be forced OFF if UVLO\_FRC\_DIS = 1. Buck and LDO will remain alive if UVLO\_FRC\_DIS = 0. During the VDD Under-voltage condition, the event register bit VIN\_UV\_EVENT = 1 if the corresponding mask register bit M\_VIN\_UV is set to 0 otherwise VIN\_UV\_EVENT = 0.

When there is an Over-Temperature fault inside the device, both buck and LDO will be forced OFF if TSD\_FRC\_DIS = 1. If TSD\_FRC\_DIS = 0, buck and LDO will remain alive. During the over-temperature condition, the event register bit OT\_EVENT = 1.

When there is an over-voltage fault at buck output, buck will be forced OFF if OV\_DIS\_BUCK = 1. Buck will continue switching if OV\_DIS\_BUCK = 0. During the fault, OV\_BUCK\_EVENT is set to 1 if M\_OV\_BUCK\_EVENT = 0 otherwise OV\_BUCK\_EVENT = 0.

When the over-current condition in buck persists for 64  $\mu$ s and M\_OC\_BUCK\_EVENT is set to 0, OC\_BUCK\_EVENT will be set to 1. If OC\_DIS\_BUCK = 1, BUCK is forced disabled. If OC\_DIS\_BUCK = 0, buck will continue switching during the over-current condition.

When there is a buck Output under-voltage condition and M\_UV\_BUCK\_EVENT = 0, UV\_BUCK\_EVENT is set to 1. If both buck output under-voltage and over-current condition exist and SC\_DIS\_BUCK = 1, buck will be forced OFF. If SC\_DIS\_BUCK = 0, buck will continue switching without shutting down by the under-voltage protection.

DA9231 also has a fault recovery mechanism that can be customized through the 3-bits RCVRY\_NUM. This value determines the fault recovery trial number for buck and is counted down by every fault that triggers buck OFF. When RCVRY\_NUM reaches 0, recovery trial is ended and buck will remain OFF even if the buck enable signals are toggled HI. If RCVRY\_NUM is set to 0x7, there will be no count down on the recovery trial number and recovery trail will not be ended. Before RCVRY\_NUM reaches 0, BUCK will be recovered automatically if the fault condition disappears.

Event flags are not automatically cleared when the fault conditions disappear. They have to be cleared by changing the values in register EVENT through I<sup>2</sup>C.

## Ultra-Low Quiescent Current Buck and LDO

### 10.5 Load Switch, LDO Output and Control

#### 10.5.1 LDO Output Programmability

The LDO can be set to the output voltages shown in [Table 13](#). The LDO output voltage can only be changed while LDO is disabled.

**Table 13: LDO Output Voltages Settings**

LDO_VOUT<4:0>	LDO Output Voltage (V)
00000	0.7
00001	0.8
00010	0.9
00011	1.0
00100	1.1
00101	1.2
00110	1.3
00111	1.4
01000	1.5
01001	1.6
01010	1.7
01011	1.8
01100	1.9
01101	2.0
01110	2.1
01111	2.2
10000	2.3
10001	2.4
10010	2.5
10011	2.6
10100	2.7
10101	2.8
10110	2.9
10111	3.0
11000	3.1
11001	3.2
11010	3.3
11011	Load switch mode
11100	Load switch mode
11101	Load switch mode

## Ultra-Low Quiescent Current Buck and LDO

LDO_VOUT<4:0>	LDO Output Voltage (V)
11110	Load switch mode
11111	Load switch mode

### 10.5.2 Automatic Output Voltage Discharge

Similar to buck regulator, the LDO also provides automatic output voltage discharge when IC\_EN is pulled low or LDO turn-off caused by any fault. The internal LDO output discharge FET has a typical 25  $\Omega$  resistance.

### 10.5.3 Load Switch

DA9231 also features load switch mode for its LDO. When LDO\_VOUT<4:0> is set to any value between 11011 and 11111, the LDO is configured as a load switch. In load switch mode, the LDO FET is fully ON. The turn-on and turn-off of load switch is controlled only through I<sup>2</sup>C command.

See Section 10.4.9 for fault behaviour and control, and Section 10.4.8 for output voltage discharge and control.

## Ultra-Low Quiescent Current Buck and LDO

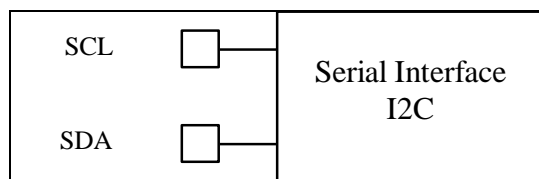
### 10.6 I<sup>2</sup>C Programming

#### 10.6.1 Interface Description

DA9231 includes an I<sup>2</sup>C compatible interface based on the following signals:

- SCL: standard 400 kHz I<sup>2</sup>C bus serial clock generated by the Host processor
- SDA: standard 400 kHz I<sup>2</sup>C bus serial address/data input output

SDA and SCL are open drain I/O terminals. The standard frequency of the I<sup>2</sup>C bus is 400 kHz in fast mode or 100 kHz in slow mode.



**Figure 54: I<sup>2</sup>C Serial Interface Pins**

The I<sup>2</sup>C bus is used to control most functions and change register values depending on the application requirements. In active battery, the I<sup>2</sup>C circuitry is powered from the battery. The interface maintains a proper operation as long as VDD\_SYS is valid.

The device is compatible with the standard I<sup>2</sup>C protocol but only operates as a slave. The transfer protocol is the same whether operating in fast or slow mode.

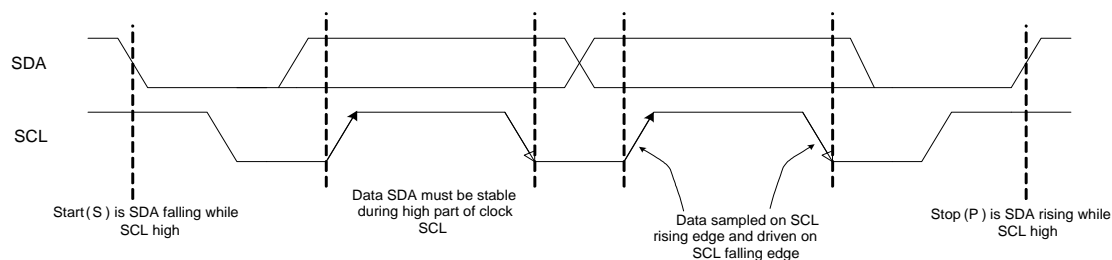
#### 10.6.2 Details of the I<sup>2</sup>C Protocol

The device supports 7-bit addressing only, the address is 2F. The 8-bit shifted address is 5E.

A timer runs during I<sup>2</sup>C transitions. If the timer expires while SDA is held low, all additional commands are ignored and the I<sup>2</sup>C state machine is reset. The timer is reset with a START condition and stopped with a STOP condition.

The I<sup>2</sup>C bus is monitored at all times for a valid SLAVE address, and an acknowledge bit is generated if the SLAVE address was true.

- A START condition is initiated by a high to low transition on the SDA line while the SCL is in the high state.
- A STOP condition is indicated by a low to high transition on the SDA line while the SCL is in the high state.
- An ACKNOWLEDGE is indicated by the receiver pulling the SDA line low during the following clock cycle.



**Figure 55: I<sup>2</sup>C Start and Stop Conditions**

## Ultra-Low Quiescent Current Buck and LDO

When the address is matching the following event sequence happens:

1. The device generates an ACKNOWLEDGE to indicate to the master that the communication link has been established
2. The master generates SCL clock cycles to transmit or receive data
3. After receiving data, an ACKNOWLEDGE is generated either by the device or the master (whichever is transmitting the data)  
A data sequence is 9-bit, consisting of 8-bit data and 1-bit ACKNOWLEDGE. It can be repeated as long as necessary.
4. The master generates a STOP condition to end the data transfer

The bus returns to IDLE-mode if during a message a new START or STOP condition occurs. Data is transmitted MSB first for both R/W operations.

### 10.7 GPO Pin Function Programing

DA9231 has a General purpose output (GPO) pin which can be programed to have multiple functions.

#### 10.7.1 Power Good Indicator

When GPO pin is configured to the VDD power good indicator, it is an open drain output and can be configured to either active high or active low. When GPO status is Hi-Z, an external pull-up is required for GPO to be high.

**Table 14: GPO as Power Good Indicator**

GPO Configuration	VIN > VIN <sub>UVLo</sub>	GPO Status
Active High	No	0
	Yes	Hi-Z
Active Low	No	Hi-Z
	Yes	0

#### 10.7.2 Event Indicator

GPO pin can also be configured as the event indicator in open drain output. Whenever there is an event or multiple events (VIN\_UV\_EVNT or OT\_EVENT or OV\_BUCK\_EVENT or OC\_BUCK\_EVENT or UV\_BUCK\_EVENT) happen, GPO will be pulled down Low. This can be used as an interrupt to host CPU to inform events happened. When there is no event, GPO will remain in Hi-Z status and an external pull-up is required for GPO to be high.

#### 10.7.3 Reset Pulse Generation

GPO pin can be configured to generate a reset pulse signal when buck or LDO starts. The reset signal can be used by host CPU or other device that are connected to buck output or LDO output. When GPO is Low, it indicates a reset pulse period; when GPO is in Hi-Z status (An external pull-up is required for GPO to be high), it indicates a non-reset period.

There is also a timing control to negate the reset pulse signal. The GPO reset pulse width can be adjusted between 8 and 112 ms measured from written 1 to BUCK\_EN or EN\_LS\_LDO register bit.

#### 10.7.4 Always Pull-Down or Hi-Z

When GPO pin is not used, it can be configured to either always Hi-Z or pull-down to Low.

## Ultra-Low Quiescent Current Buck and LDO

### 11 Register Overview

#### 11.1 Register Map

##### 11.1.1 Buck and LDO Control

**Table 15: Event/Status/Mask and User Registers**

User Registers									
Register	Addr	7	6	5	4	3	2	1	0
EVENT	0x0000	OT_EVENT	VIN_UV_EVENT	Reserved	OC_BUCK_EVENT	OV_BUCK_EVENT	UV_BUCK_EVENT	Reserved	Reserved
STATUS	0x0002	OT_STAT	VIN_UV_STAT	Reserved	OC_BUCK_STAT	OV_BUCK_STAT	UV_BUCK_STAT	Reserved	BUCK_EN_STAT
MASK	0x0003	Reserved	M_VIN_UV	Reserved	M_OC_BUCK_EVENT	M_OV_BUCK_EVENT	M_UV_BUCK_EVENT	Reserved	Reserved
GPO	0x0004	GPO_RST_CTRL<3:0>				GPO_CTRL<3:0>			
BUCK	0x0005	BUCK_EN	VOUT_RANGE_HI	Reserved	BUCK_VOUT<4:0>				
BUCK_CFG	0x0006	Reserved	Reserved	BUCK_PD_CFG2	BUCK_PD_CFG1	Reserved	Reserved	SEL_BUCK_ILIM<1:0>	
LS_LDO	0x0007	EN_LS_LDO	Reserved	Reserved	LS_LDO<4:0>				
FAULT_CTL	0x0008	SC_DIS_BUCK	OC_DIS_BUCK	OV_DIS_BUCK	TSD_FRC_DIS	UVLO_FRC_DIS	RCVRY_NUM<2:0>		
PIN_MONTOR	0x000A	Reserved	Reserved	Reserved	Reserved	Reserved	Reserved	Reserved	GPO_OUT_MON

## Ultra-Low Quiescent Current Buck and LDO

### 11.1.2 System Module

**Table 16: System Registers**

User Registers									
Register	Addr	7	6	5	4	3	2	1	0
SYS_RST_EVENT	0x0001	Reserved	Reserved	Reserved	Reserved	Reserved	Reserved	Reserved	RESET_EVENT
SYS_SRST	0x0009	Reserved	Reserved	Reserved	Reserved	SRST<3:0>			
SYS_DEVICE_ID	0x0080	DEV_ID<7:0>							
SYS_VARIANT_ID	0x0081	MRC<3:0>				VRC<3:0>			
SYS_CONFIG_ID	0x0082	CONFIG_REV<7:0>							

## 11.2 Register Definitions

### 11.2.1 Buck and LDO Control

#### 11.2.1.1 Event/Status/Mask Registers

**Table 17: Register EVENT**

Address	Register Name	POR Value	Event flag						
0x0000	EVENT	0x00							
7	6	5	4	3	2	1	0		
OT_EVENT	VIN_UV_EVENT	Reserved	OC_BUCK_EVENT	OV_BUCK_EVENT	UV_BUCK_EVENT	Reserved	Reserved		
Field Name	Bits	Type	POR	Description					
OT_EVENT	[7]	evnt	0x0	Over Temperature fault event flag. When Over temperature condition is detected, this bit is set to 1. When I2C writes '1' to this bit, the event flag is cleared.					
VIN_UV_EVENT	[6]	evnt	0x0	Under Voltage on VDD event flag. When Under Voltage (UVLO) condition is detected, this bit is set to 1. When I2C writes '1' to this bit, the event flag is cleared.					



## Ultra-Low Quiescent Current Buck and LDO

Field Name	Bits	Type	POR	Description
OC_BUCK_EVENT	[4]	evnt	0x0	Over Current on BUCK OUT event flag. When the buck Over Current condition is detected (when BUCK_EN==1 && M_OC_BUCK==0), this bit is set to 1. When I2C writes '1' to this bit, the event flag is cleared.
OV_BUCK_EVENT	[3]	evnt	0x0	Over Voltage on BUCK OUT event flag. When the buck Over Voltage condition is detected (when BUCK_EN==1 && M_OV_BUCK==0), this bit is set to 1. When I2C writes '1' to this bit, the event flag is cleared.
UV_BUCK_EVENT	[2]	evnt	0x0	Under voltage on BUCK OUT event flag. When the under voltage condition (i.e. short circuit) is detected on the buck (when BUCK_EN==1 && M_UV_BUCK==0), this bit is set to 1. When I2C writes '1' to this bit, this event flag is cleared.

**Table 18: Register STATUS**

Address	Register Name	POR Value	Status				
0x0002	STATUS	0x00					
7	6	5	4	3	2	1	0
OT_STAT	VIN_UV_STAT	Reserved	OC_BUCK_STAT	OV_BUCK_STAT	UV_BUCK_STAT	Reserved	BUCK_EN_STAT
Field Name	Bits	Type	POR	Description			
OT_STAT	[7]	virtual	0x0	Indicate present Over Temp status.			
VIN_UV_STAT	[6]	virtual	0x0	Indicate present VIN under-voltage status.			
OC_BUCK_STAT	[4]	virtual	0x0	Indicate present BUCK V <sub>OUT</sub> over current status.			
OV_BUCK_STAT	[3]	virtual	0x0	Indicate present BUCK V <sub>OUT</sub> over voltage status.			
UV_BUCK_STAT	[2]	virtual	0x0	Indicate present BUCK V <sub>OUT</sub> under voltage status.			
BUCK_EN_STAT	[0]	virtual	0x0	Indicate present Buck Enable status. 1:Buck enabled 0:Buck disabled			

## Ultra-Low Quiescent Current Buck and LDO

**Table 19: Register MASK**

Address	Register Name	POR Value	Mask				
0x0003	MASK	0x7C					
7	6	5	4	3	2	1	0
Reserved	M_VIN_UV	Reserved	M_OC_BUCK_EVENT	M_OV_BUCK_EVENT	M_UV_BUCK_EVENT	Reserved	Reserved
Field Name	Bits	Type	POR	Description			
M_VIN_UV	[6]	cfg OTP	0x1	Mask to set VIN_UV_EVNT. VIN_UV_STAT is updated regardless of this mask.			
M_OC_BUCK_EVENT	[4]	cfg OTP	0x1	Masks to set OC_BUCK_EVENT. OC_BUCK_STAT is updated regardless of this mask.			
M_OV_BUCK_EVENT	[3]	cfg OTP	0x1	Masks to set OV_BUCK_EVENT. OV_BUCK_STAT is updated regardless of this mask.			
M_UV_BUCK_EVENT	[2]	cfg OTP	0x1	Masks to set UV_BUCK_EVENT. UV_BUCK_STAT is updated regardless of this mask.			

### 11.2.1.2 User Registers

**Table 20: Register GPO**

Address	Register Name	POR Value	GPO control				
0x0004	GPO	0x00					
7	6	5	4	3	2	1	0
GPO_RST_CTRL<3:0>				GPO_CTRL<3:0>			
Field Name	Bits	Type	POR	Description			
GPO_RST_CTRL	[7:4]	cfg OTP	0x0	Reset pulse signal negate timing control			
				Value	Description		
				0x0	8 ms after BUCK_EN = 1, GPO reset pulse is negated.		
				0x1	16 ms after BUCK_EN = 1, GPO reset pulse is negated.		

## Ultra-Low Quiescent Current Buck and LDO

Field Name	Bits	Type	POR	Description	
				0x2	32 ms after BUCK_EN = 1, GPO reset pulse is negated.
				0x3	48 ms after BUCK_EN = 1, GPO reset pulse is negated.
				0x4	64 ms after BUCK_EN = 1, GPO reset pulse is negated.
				0x5	80 ms after BUCK_EN = 1, GPO reset pulse is negated.
				0x6	96 ms after BUCK_EN = 1, GPO reset pulse is negated.
				0x7	112 ms after BUCK_EN = 1, GPO reset pulse is negated.
				0x8	8 ms after EN_LS_LDO = 1, GPO reset pulse is negated.
				0x9	16 ms after EN_LS_LDO = 1, GPO reset pulse is negated.
				0xA	32 ms after EN_LS_LDO = 1, GPO reset pulse is negated.
				0xB	48 ms after EN_LS_LDO = 1, GPO reset pulse is negated.
				0xC	64 ms after EN_LS_LDO = 1, GPO reset pulse is negated.
				0xD	80 ms after EN_LS_LDO = 1, GPO reset pulse is negated.
				0xE	96 ms after EN_LS_LDO = 1, GPO reset pulse is negated.
				0xF	112 ms after EN_LS_LDO = 1, GPO reset pulse is negated.
				GPO_CTRL	[3:0]
<b>Value</b>	<b>Description</b>				
0x1	Reset Pulse generation output				
0x2	PowerGood indicator, Active Low				
0x3	PowerGood indicator, Active High				
0x4	Event indicator				
0x8	Force GPO output low				
0x9	Force GPO output hi-z				

## Ultra-Low Quiescent Current Buck and LDO

**Table 21: Register BUCK**

Address	Register Name	POR Value					
0x0005	BUCK	0x58	Buck enable & V <sub>OUT</sub> control				
7	6	5	4	3	2	1	0
BUCK_EN	VOUT_RANGE_HI	Reserved	BUCK_VOUT<4:0>				
Field Name	Bits	Type	POR	Description			
BUCK_EN	[7]	cfg OTP	0x0	BUCK enable			
VOUT_RANGE_HI	[6]	cfg OTP	0x1	Range selection for buck. This can only be changed while BUCK_EN = 0			
				Value	Description		
				0x0	0.60 V ≤ V <sub>BUCK</sub> ≤ 1.30 V		
				0x1	1.30 V ≤ V <sub>BUCK</sub> ≤ 1.90 V		
BUCK_VOUT	[4:0]	databl k OTP	0x18	Buck output voltage			
				Value	Description		
				0x00	0.60 V		
				0x01	0.65 V		
				0x02	0.70 V		
				0x03	0.75 V		
				0x04	0.80 V		
				0x05	0.85 V		
				0x06	0.90 V		
				0x07	0.95 V		
				0x08	1.00 V		
0x09	1.05 V						

## Ultra-Low Quiescent Current Buck and LDO

Field Name	Bits	Type	POR	Description
				0x0A 1.10 V
				0x0B 1.15 V
				0x0C 1.20 V
				0x0D 1.25 V
				0x0E 1.30 V
				0x0F 1.35 V
				0x10 1.40 V
				0x11 1.45 V
				0x12 1.50 V
				0x13 1.55 V
				0x14 1.60 V
				0x15 1.65 V
				0x16 1.70 V
				0x17 1.75 V
				0x18 1.80 V
				0x19 1.85 V
				0x1A 1.90 V
				0x1B 1.90 V
				0x1C 1.90 V
				0x1D 1.90 V
				0x1E 1.90 V
				0x1F 1.90 V

## Ultra-Low Quiescent Current Buck and LDO

**Table 22: Register BUCK\_CFG**

Address	Register Name	POR Value					
0x0006	BUCK_CFG	0x00	Buck config				
7	6	5	4	3	2	1	0
Reserved	Reserved	BUCK_PD_CFG2	BUCK_PD_CFG1	Reserved	Reserved	SEL_BUCK_ILIM<1:0>	
Field Name	Bits	Type	POR	Description			
BUCK_PD_CFG2	[5]	cfg OTP	0x0	0: If BUCK_EN = 0, BUCK_PD_EN = 1 1: If BUCK_EN = 0, BUCK_PD_EN = 0			
BUCK_PD_CFG1	[4]	cfg OTP	0x0	0: When BUCK is forced off by faults, BUCK_PD_EN = 1 1: When BUCK is forced off by faults, BUCK_PD_EN = 0			
SEL_BUCK_ILIM	[1:0]	cfg OTP	0x0	Buck peak current limit setting			
				Value	Description		
				0x0	Default current limit		
				0x1	Default +50 mA		
				0x2	Default +100 mA		
0x3	Default +150 mA						

**Table 23: Register LS\_LDO**

Address	Register Name	POR Value					
0x0007	LS_LDO	0x0A	LS/LDO control				
7	6	5	4	3	2	1	0
EN_LS_LDO	Reserved	Reserved	LS_LDO<4:0>				
Field Name	Bits	Type	POR	Description			
EN_LS_LDO	[7]	cfg OTP	0x0	LDO Enable			
LS_LDO	[4:0]	cfg OTP	0xA	LDO voltage. This cannot be written when EN_LS_LDO is '1'			

## Ultra-Low Quiescent Current Buck and LDO

Field Name	Bits	Type	POR	Description	
				Value	Description
				0x00	0.70 V
				0x01	0.80 V
				0x02	0.90 V
				0x03	1.00 V
				0x04	1.10 V
				0x05	1.20 V
				0x06	1.30 V
				0x07	1.40 V
				0x08	1.50 V
				0x09	1.60 V
				0x0A	1.70 V
				0x0B	1.80 V
				0x0C	1.90 V
				0x0D	2.00 V
				0x0E	2.10 V
				0x0F	2.20 V
				0x10	2.30 V
				0x11	2.40 V
				0x12	2.50 V
				0x13	2.60 V
				0x14	2.70 V

## Ultra-Low Quiescent Current Buck and LDO

Field Name	Bits	Type	POR	Description
				0x15 2.80 V
				0x16 2.90 V
				0x17 3.00 V
				0x18 3.10 V
				0x19 3.20 V
				0x1A 3.30 V
				0x1B Load Switch Mode
				0x1C Load Switch Mode
				0x1D Load Switch Mode
				0x1E Load Switch Mode
				0x1F Load Switch Mode

**Table 24: Register FAULT\_CTL**

Address	Register Name	POR Value	Fault & Recovery control				
0x0008	FAULT_CTL	0x1F					
<b>7</b>	<b>6</b>	<b>5</b>	<b>4</b>	<b>3</b>	<b>2</b>	<b>1</b>	<b>0</b>
SC_DIS_BUCK	OC_DIS_BUCK	OV_DIS_BUCK	TSD_FRC_DIS	UVLO_FRC_DIS	RCVRY_NUM<2:0>		
Field Name	Bits	Type	POR	Description			
SC_DIS_BUCK	[7]	cfg OTP	0x0	1: Force disable BUCK during SHORT CIRCUIT condition oc_buck=1 & uv_buck=1			
OC_DIS_BUCK	[6]	cfg OTP	0x0	1: Force disable BUCK during oc_buck=1 for over 64 cycles			
OV_DIS_BUCK	[5]	cfg OTP	0x0	1: Force disable BUCK during ov_buck=1			
TSD_FRC_DIS	[4]	cfg OTP	0x1	1: Force disable BUCK & LDO during Over Temp			



## Ultra-Low Quiescent Current Buck and LDO

Field Name	Bits	Type	POR	Description
UVLO_FRC_DIS	[3]	cfg OTP	0x1	1: Force disable BUCK & LDO during UVLO
RCVRY_NUM	[2:0]	data OTP	0x7	BUCK recovery trial fault number. This is counted down by every fault forcing BUCK off. If RCVRY_NUM becomes 0, Recovery trial is ended. If RCVRY_NUM is set 0x7, this is not counted down and recovery trail is not ended.

**Table 25: Register PIN\_MONTOR**

Address	Register Name	POR Value	PIN MONITOR				
0x000A	PIN_MONTOR	0x00					
7	6	5	4	3	2	1	0
Reserved	Reserved	Reserved	Reserved	Reserved	Reserved	Reserved	GPO_OUT_MON
Field Name	Bits	Type	POR	Description			
GPO_OUT_MON	[0]	virtual	0x0	Indicate current GPO output			

## 11.2.2 System Module

### 11.2.2.1 System Reset Registers

**Table 26: Register SYS\_RST\_EVENT**

Address	Register Name	POR Value	Reset Event flag				
0x0001	SYS_RST_EVENT	0x01					
7	6	5	4	3	2	1	0
Reserved	Reserved	Reserved	Reserved	Reserved	Reserved	Reserved	RESET_EVENT
Field Name	Bits	Type	POR	Description			
RESET_EVENT	[0]	evnt	0x1	RESET event flag. After Reset, this bit is set. When I2C write '1' to this bit, this event flag is cleared.			

## Ultra-Low Quiescent Current Buck and LDO

**Table 27: Register SYS\_SRST**

Address	Register Name	POR Value					
0x0009	SYS_SRST	0x00	Soft Reset				
7	6	5	4	3	2	1	0
Reserved	Reserved	Reserved	Reserved	SRST<3:0>			
Field Name	Bits	Type	POR	Description			
SRST	[3:0]	cfg	0x0	Initiate Soft Reset by writing 0x5.			

### 11.2.2.2 System ID Registers

**Table 28: Register SYS\_DEVICE\_ID**

Address	Register Name	POR Value					
0x0080	SYS_DEVICE_ID	0x00	DEVICE_ID				
7	6	5	4	3	2	1	0
DEV_ID<7:0>							
Field Name	Bits	Type	POR	Description			
DEV_ID	[7:0]	virtual	0x0	Device ID; hard-coded or metal-programmed			

**Table 29: Register SYS\_VARIANT\_ID**

Address	Register Name	POR Value					
0x0081	SYS_VARIANT_ID	0x00	VARIANT_ID				
7	6	5	4	3	2	1	0
MRC<3:0>				VRC<3:0>			

## Ultra-Low Quiescent Current Buck and LDO

Field Name	Bits	Type	POR	Description
MRC	[7:4]	virtual	0x0	Mask Revision Code; mask design changes increment reset value.
VRC	[3:0]	trim OTP	0x0	Chip Variant Code; e.g. package variants.

**Table 30: Register SYS\_CONFIG\_ID**

Address	Register Name	POR Value	CONFIG_ID				
0x0082	SYS_CONFIG_ID	0x00					
7	6	5	4	3	2	1	0
CONFIG_REV<7:0>							
Field Name	Bits	Type	POR	Description			
CONFIG_REV	[7:0]	trim OTP	0x0	OTP settings revision			

Ultra-Low Quiescent Current Buck and LDO

## 12 Package Information

### 12.1 Package Outlines

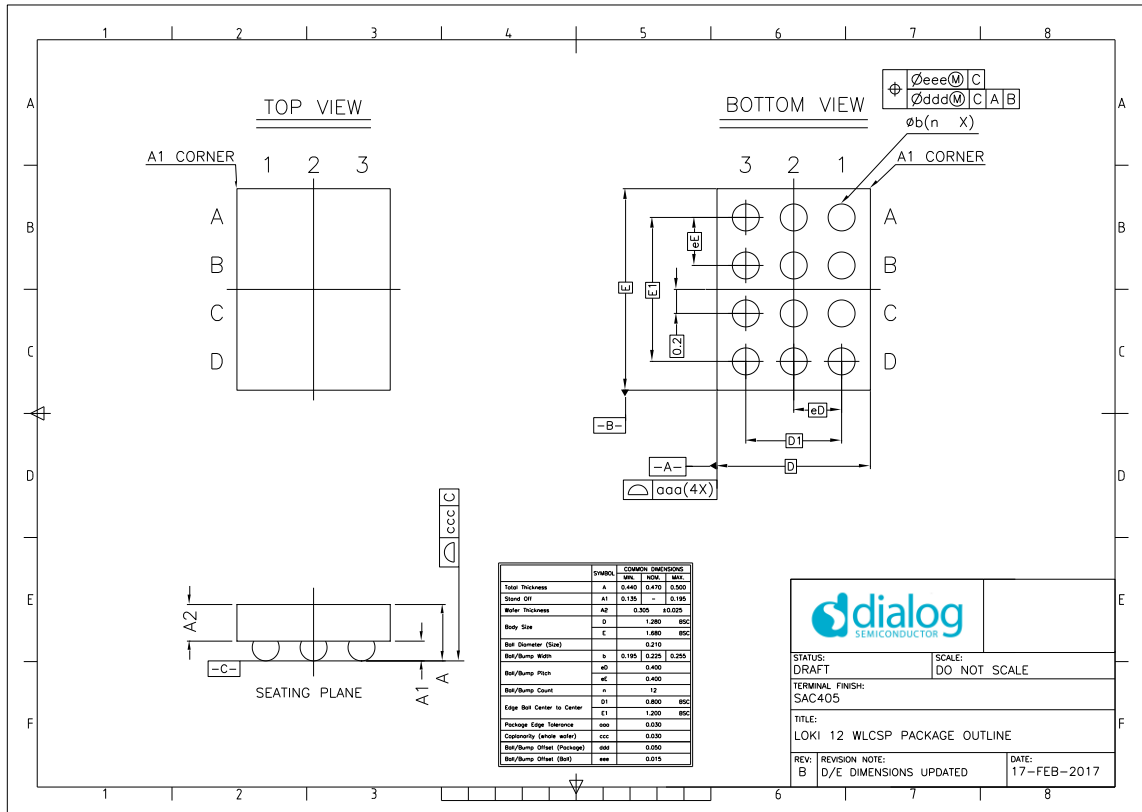


Figure 56: Package Outline Drawing

## Ultra-Low Quiescent Current Buck and LDO

### 12.2 Moisture Sensitivity Level

The Moisture Sensitivity Level (MSL) is an indicator for the maximum allowable time period (floor lifetime) in which a moisture sensitive plastic device, once removed from the dry bag, can be exposed to an environment with a maximum temperature of 30 °C and a maximum relative humidity of 60% RH before the solder reflow process. The MSL classification is defined in [Table 31](#).

The device package is qualified for MSL 1.

**Table 31: MSL Classification**

MSL level	Floor Lifetime
MSL 1	unlimited at 30 °C/85% RH

### 12.3 Soldering Information

Refer to the JEDEC standard J-STD-020 for relevant soldering information. This document can be downloaded from <http://www.jedec.org>.

## Ultra-Low Quiescent Current Buck and LDO

### 13 Ordering Information

The ordering number consists of the part number followed by a suffix indicating the packing method. For details and availability or other custom OTP parts, please consult Renesas Electronics' [customer support portal](#) or your local sales representative.

**Table 32: Ordering Information**

Part number	Package	Size (mm)	Shipment Form	Pack Quantity
DA9231 -xxxx	WLCSP-12	1.25 x 1.65	T&R	4500

**Table 33: OTP List**

Order number	Description	Buck V <sub>OUT</sub> (V)	LDO V <sub>OUT</sub> (V)
DA9231-0BVZ2	OTP with Buck and LDO voltage preconfigured	1.8	3.3
DA9231-0CVZ2	OTP with Buck and LDO voltage preconfigured	0.6	3.3
DA9231-0DVZ2	OTP with Buck and LDO voltage preconfigured	1.2	3.0
DA9231-0EVZ2	OTP with Buck and Load switch mode	1.8	Load switch mode

---

## Ultra-Low Quiescent Current Buck and LDO

---

### Status Definitions

Revision	Datasheet Status	Product Status	Definition
1.<n>	Target	Development	This datasheet contains the design specifications for product development. Specifications may be changed in any manner without notice.
2.<n>	Preliminary	Qualification	This datasheet contains the specifications and preliminary characterization data for products in pre-production. Specifications may be changed at any time without notice in order to improve the design.
3.<n>	Final	Production	This datasheet contains the final specifications for products in volume production. The specifications may be changed at any time in order to improve the design, manufacturing and supply. Relevant changes will be communicated via Customer Product Notifications.
4.<n>	Obsolete	Archived	This datasheet contains the specifications for discontinued products. The information is provided for reference only.

### RoHS Compliance

Renesas Electronics' suppliers certify that its products are in compliance with the requirements of Directive 2011/65/EU of the European Parliament on the restriction of the use of certain hazardous substances in electrical and electronic equipment. RoHS certificates from our suppliers are available on request.

---

## Ultra-Low Quiescent Current Buck and LDO

---

### Important Notice and Disclaimer

RENESAS ELECTRONICS CORPORATION AND ITS SUBSIDIARIES ("RENESAS") PROVIDES TECHNICAL SPECIFICATIONS AND RELIABILITY DATA (INCLUDING DATASHEETS), DESIGN RESOURCES (INCLUDING REFERENCE DESIGNS), APPLICATION OR OTHER DESIGN ADVICE, WEB TOOLS, SAFETY INFORMATION, AND OTHER RESOURCES "AS IS" AND WITH ALL FAULTS, AND DISCLAIMS ALL WARRANTIES, EXPRESS OR IMPLIED, INCLUDING, WITHOUT LIMITATION, ANY IMPLIED WARRANTIES OF MERCHANTABILITY, FITNESS FOR A PARTICULAR PURPOSE, OR NON-INFRINGEMENT OF THIRD PARTY INTELLECTUAL PROPERTY RIGHTS.

These resources are intended for developers skilled in the art designing with Renesas products. You are solely responsible for (1) selecting the appropriate products for your application, (2) designing, validating, and testing your application, and (3) ensuring your application meets applicable standards, and any other safety, security, or other requirements. These resources are subject to change without notice. Renesas grants you permission to use these resources only for development of an application that uses Renesas products. Other reproduction or use of these resources is strictly prohibited. No license is granted to any other Renesas intellectual property or to any third party intellectual property. Renesas disclaims responsibility for, and you will fully indemnify Renesas and its representatives against, any claims, damages, costs, losses, or liabilities arising out of your use of these resources. Renesas' products are provided only subject to Renesas' Terms and Conditions of Sale or other applicable terms agreed to in writing. No use of any Renesas resources expands or otherwise alters any applicable warranties or warranty disclaimers for these products.

© 2023 Renesas Electronics Corporation. All rights reserved.

(Rev.1.0 Mar 2020)

## Corporate Headquarters

TOYOSU FORESIA, 3-2-24 Toyosu

Koto-ku, Tokyo 135-0061, Japan

[www.renesas.com](http://www.renesas.com)

### Contact Information

For further information on a product, technology, the most up-to-date version of a document, or your nearest sales office, please visit:

<https://www.renesas.com/contact/>

### Trademarks

Renesas and the Renesas logo are trademarks of Renesas Electronics Corporation. All trademarks and registered trademarks are the property of their respective owners.