

## VC7 Power Supply Filtering Recommendations

Power supply noise will have an impact on the performance (i.e., phase noise) of VC7's output clocks. Board designers are seeking recommendations from the vendor for the power supply filtering schemes. While power supply quality is a generic requirement for almost all ICs, this document recommends a specific implementation of power supply filtering based on our evaluation board designs.

### Contents

<b>1. Power Supply Filtering Topology.....</b>	<b>2</b>
<b>2. Simulations.....</b>	<b>3</b>
2.1 Simulation 1 .....	4
2.2 Simulation 2 .....	5
2.3 Simulation 3 .....	6
2.4 Simulation 4 .....	7
2.5 Simulation 5 .....	8
2.6 Simulation 6 .....	9
2.7 Simulation 7 .....	10
2.8 Simulation 8 .....	11
2.9 Simulation 9 .....	12
<b>3. Observations and Filtering Recommendations.....</b>	<b>13</b>
<b>4. Revision History .....</b>	<b>13</b>
<b>5. References.....</b>	<b>13</b>
<b>Appendix A: Component Models .....</b>	<b>14</b>

# 1. Power Supply Filtering Topology

We recommend a  $\pi$ -shape filtering network consisting of decoupling capacitors of 0.1uF and 10uF with a ferrite bead, as shown in Figure 1. It includes a 0.1uF decoupling capacitor at the left side of the bead [1], followed by the bead, then 2x 10uF capacitors with an optional series resistor in between. The right-most 0.1uF capacitor (C68) is intended to be placed as close to each power pin as possible.

We also recommend that each power rail use such a  $\pi$ -shape filter for VDDA, VDDD, and VDDX/VDDR. For VDDOs, if all the output clocks have the same frequency, one common filter can be shared between the VDDOs. If different output frequencies are used, separated filters are recommended for each VDDO.

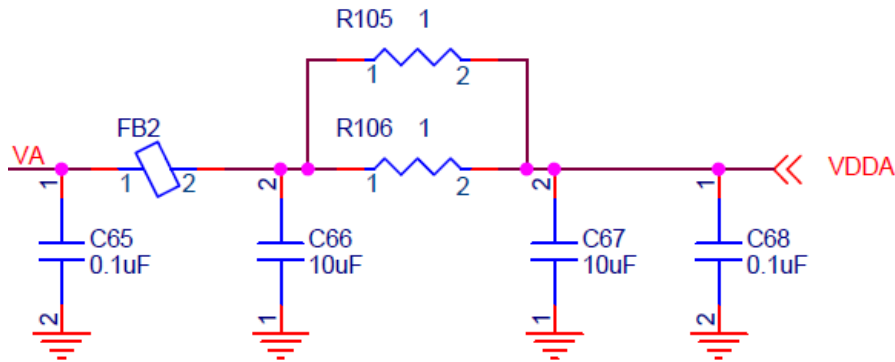

Figure 1.  $\pi$ -Shape Filter Proposed for VC7 Power Supply Rails

This document explores about whether there is any performance (PSNR) difference among different ferrite beads and decoupling capacitors used in Figure 1. The ferrite beads and capacitors used in the simulations are listed below.

Table 1. Ferrite Bead and Decoupling Capacitor Part Numbers and Major Specifications

MPN	Category	Specifications Summary
BLM18AG221SN1	General use	Impedance: 220 $\pm$ 25% (100MHz) Current rating: 700mA DCR: 0.25 $\Omega$ initial 0.35 $\Omega$ testing
BLM18AG601SN1	For general use	Impedance: 600 $\pm$ 25% (100MHz) Current rating: 500mA DCR: 0.38 $\Omega$ initial 0.48 $\Omega$ testing
BLM18PG221SN1	For DC power line	Impedance: 220 $\pm$ 25% (100MHz) Current rating: 1400mA DCR: 0.10 $\Omega$ initial 0.14 $\Omega$ testing
BLM18KG601SN1	For DC power line	Impedance: 600 $\pm$ 25% (100MHz) Current rating: 1300mA DCR: 0.15 $\Omega$ initial 0.165 $\Omega$ testing
GRM033C81E104KE14	Multilayer Ceramic	X6S, 0.1uF $\pm$ 10%, 25V, 0201
GRM188R61E106KA73	Multilayer Ceramic	X5R, 10uF $\pm$ 10%, 25V, 0603
GRM188R60J226MEA0	Multilayer Ceramic	X5R, 22uF $\pm$ 20%, 6.3V, 0603

## 2. Simulations

The capacitor and ferrite beads used in this simulation exercise are from Murata Electronics, which are selected because Murata provides the Pspice models of these components in their website for convenient download. All of the models used are listed in “Appendix A: Component Models.”

Nine simulations were completed in order to compare different topologies and components. The simulations are summarized in the following table.

**Table 2. Simulations Summary**

Simulation	Filter Topology	Component Changes
1	Figure 1	Bead: <b>BLM18AG221SN1</b> Capacitors: 0.1uF left, 2x 10uF, 0.1uF right Series resistor: 0.5Ω
2	Figure 1 with 1x 10uF capacitor	Bead: <b>BLM18AG221SN1</b> Capacitors: 0.1uF, 1x10uF before the resistor Series resistor: 0.5 Ω
3	Figure 1	Bead: <b>BLM18AG601SN1</b> Capacitors: 0.1uF left, 2x 10uF, 0.1uF right Series resistor: 0.5Ω
4	Figure 1	Bead: <b>BLM18PG221SN1</b> Capacitors: 0.1uF left, 2x 10uF, 0.1uF right Series resistor: 0.5Ω
5	Figure 1	Bead: <b>BLM18KG601SN1</b> Capacitors: 0.1uF left, 2x 10uF, 0.1uF right Series resistor: 0.5Ω
6	Figure 1	Bead: <b>BLM18KG601SN1</b> Capacitors: 0.1uF left, 2x 10uF, 0.1uF right Series resistor: 0.5Ω <b>Each capacitor is separately grounded through a lossy transmission line</b>
7	Figure 1 but a 22uF is used to replace 2x 10uF capacitors	Bead: <b>BLM18KG601SN1</b> Capacitors: 0.1uF, 22uF left of resistor, 0.1uF right Series resistor: 0.5Ω
8	Figure 1 but a 22uF is used to replace 2x 10uF capacitors	Bead: <b>BLM18KG601SN1</b> Capacitors: 0.1uF, 22uF right of resistor, 0.1uF right Series resistor: 0.5Ω
9	Figure 1	Bead: <b>BLM18KG601SN1</b> Capacitors: 0.1uF left, 2x 10uF, 0.1uF right Series resistor: 0.025Ω (simulating no series resistor)

## 2.1 Simulation 1

This simulation used the filter as the same circuit in VC7 EVB schematics. Components used are:

- 0.1uF capacitor, Murata P/N: GRM033C81E104KE14
- Ferrite bead: Murata P/N: BLM18AG221SN1
- 10uF capacitor: Murata P/N: GRM188R61E106KA73
- 0.5Ω series resistor
- 10uF capacitor: same as above

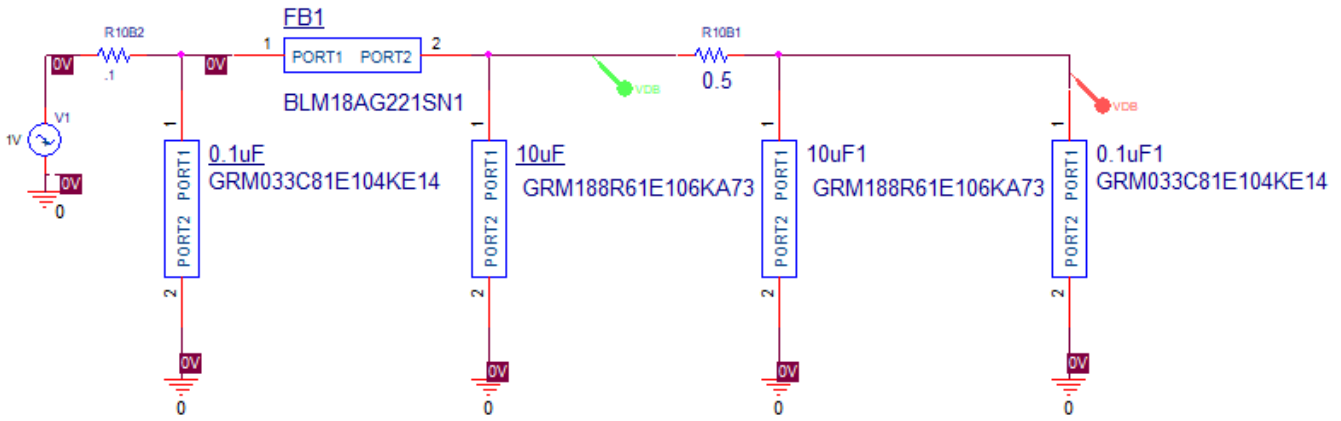

Figure 2. Schematics and Component Models for Simulation 1

Table 3. Simulation 1 Results (1MHz - 100MHz)

Frequency	1MHz	5MHz	10MHz	100MHz
Noise Suppression (dB)	-80	-105	-95	-82

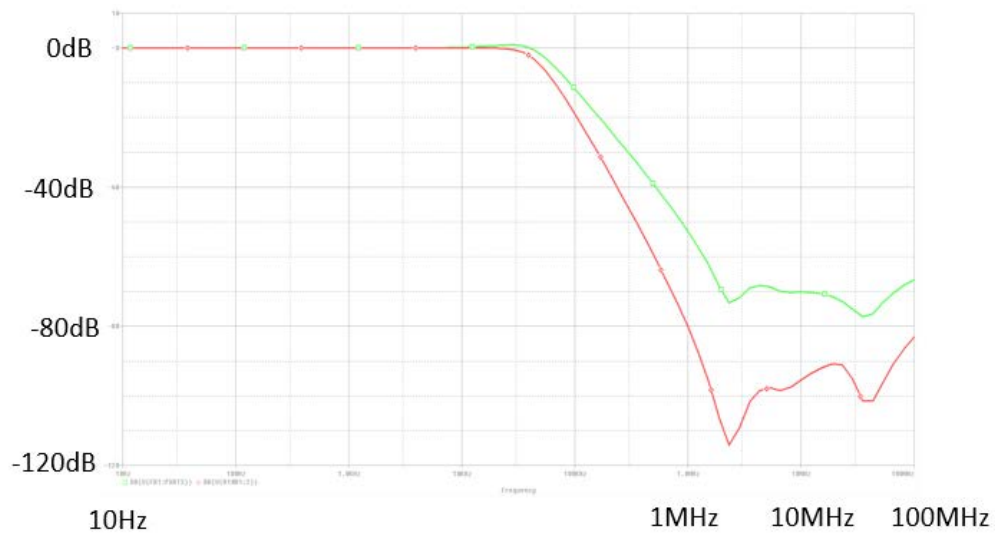

Figure 3. Simulation 1 Results Plot

## 2.2 Simulation 2

Same as simulation 1 but removed the 2<sup>nd</sup> 10uF capacitor, as shown below (removing C67 from Figure 1 schematics).

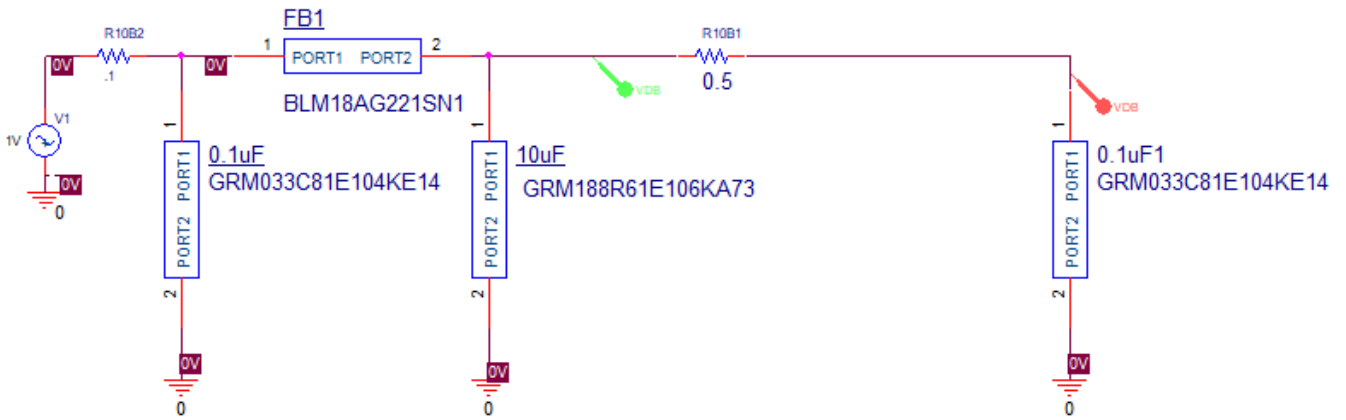

Figure 4. Schematics for Simulation 2

Table 4. Simulation 2 Results

Frequency	1MHz	5MHz	10MHz	100MHz
Noise Suppression (dB)	-52	-72	-78	-80

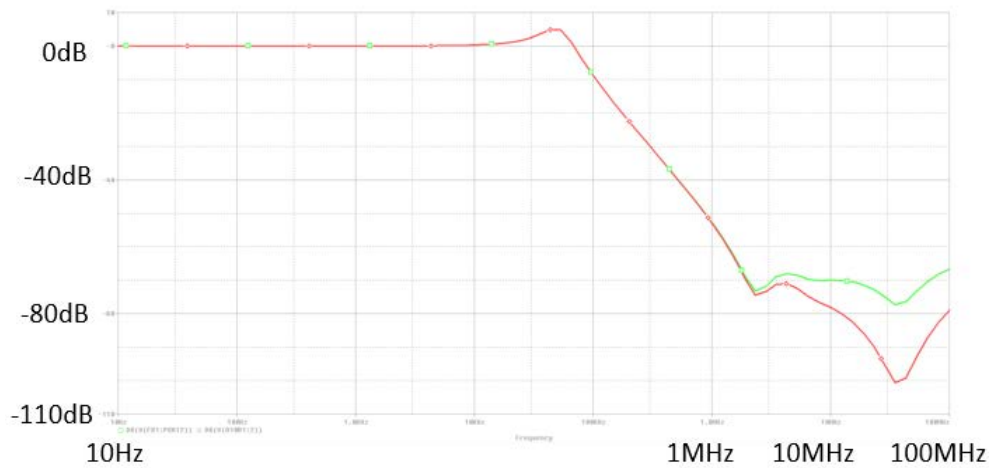

Figure 5. Simulation 2 Results Plot

### 2.3 Simulation 3

Resume the filter to simulation 1 topology (with 2x 10uF capacitors) and changed the ferrite bead to BLM18AG601SN1.

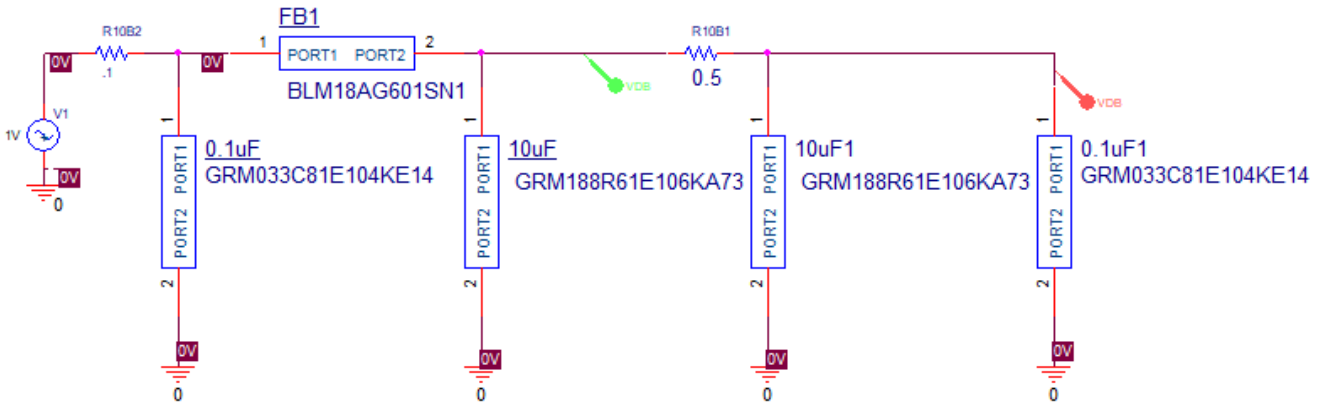

Figure 6. Schematics for Simulation 3

Table 5. Simulation 3 Results

Frequency	1MHz	5MHz	10MHz	100MHz
Noise Suppression (dB)	-88	-115	-102	-92

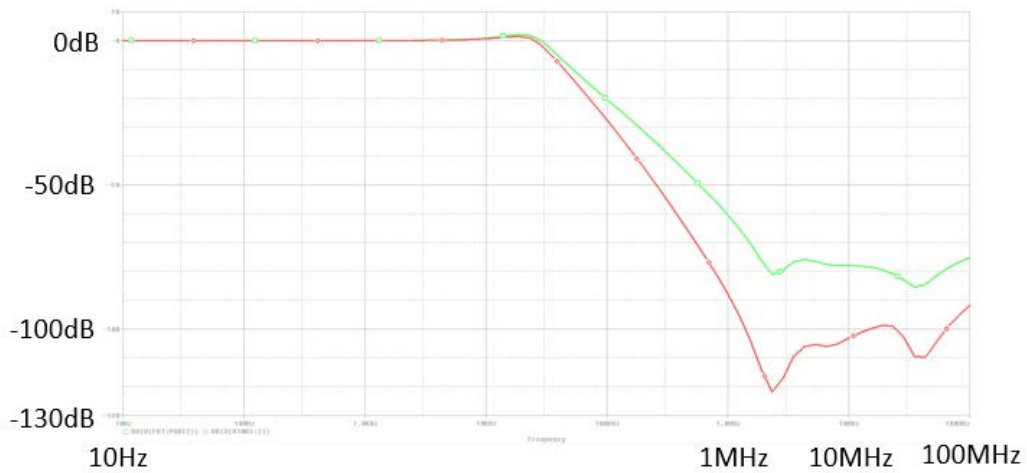

Figure 7. Simulation 3 Results Plot

## 2.4 Simulation 4

Same as simulation 3 but changed to yet another ferrite bead: BLM18PG221SN1, which is categorized as “Used for DC power lines” versus the above two ferrite beads characterized as “used for signal lines” in Murata’s documentation. BLM18PG221SN1 has a DC resistance of  $0.1\Omega$  and a current rating of 1400mA.

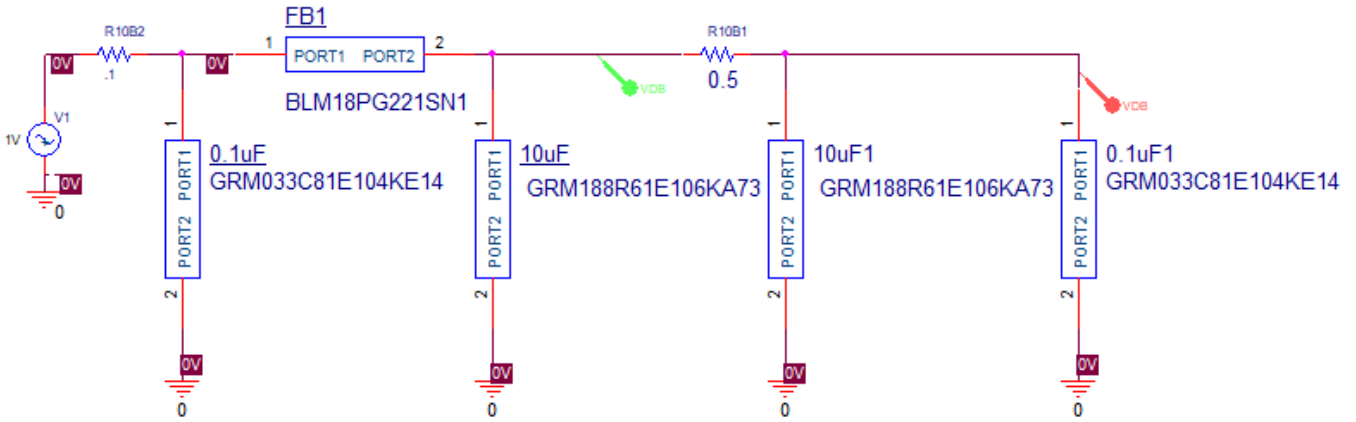

Figure 8. Schematics and Component Model Used in Simulation 4

Table 6. Simulation 4 Results

Frequency	1MHz	5MHz	10MHz	100MHz
Noise Suppression (dB)	-82	-108	-95	-82

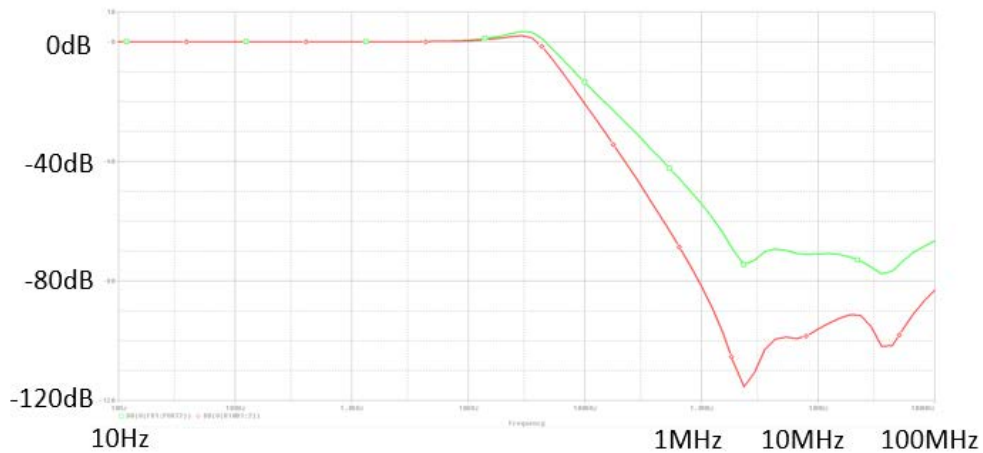

Figure 9. Simulation 4 Results Plot

## 2.5 Simulation 5

The filter schematics is the same as above but replaced BLM18PG221SN1 with BLM18KG601SN1B/D bead. The key spec metrics for this ferrite bead is: DC resistance = 0.14Ω, Current rating = 1300mA, impedance at 100MHz is 600 Ω.

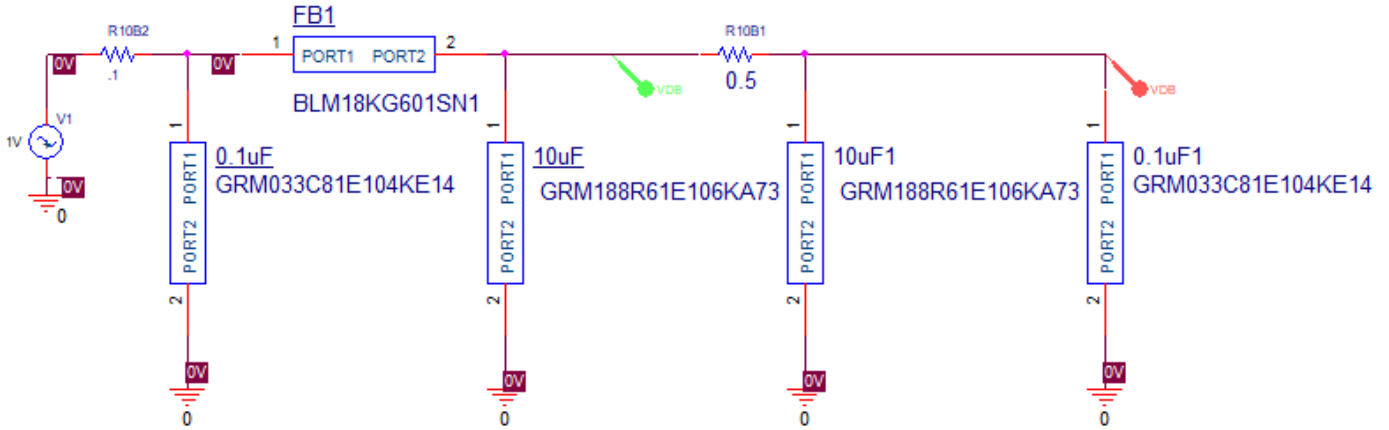

Figure 10. Simulation 5 Filter Schematics

Table 7. Simulation 5 Results

Frequency	1MHz	5MHz	10MHz	100MHz
Noise Suppression (dB)	-90	-115	-103	-92

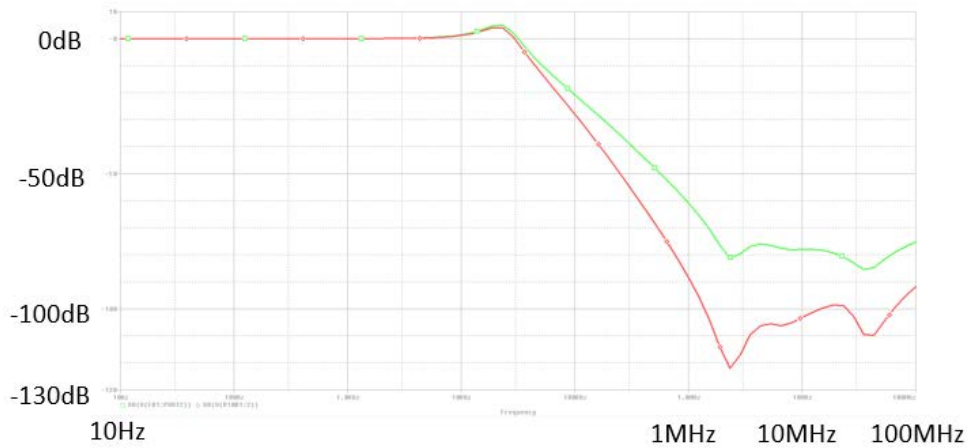

Figure 11. Simulation 5 Results Plot



## 2.6 Simulation 6

This simulation is the same as the above but components' grounding is replaced by lossy TLines. The schematics are shown below.

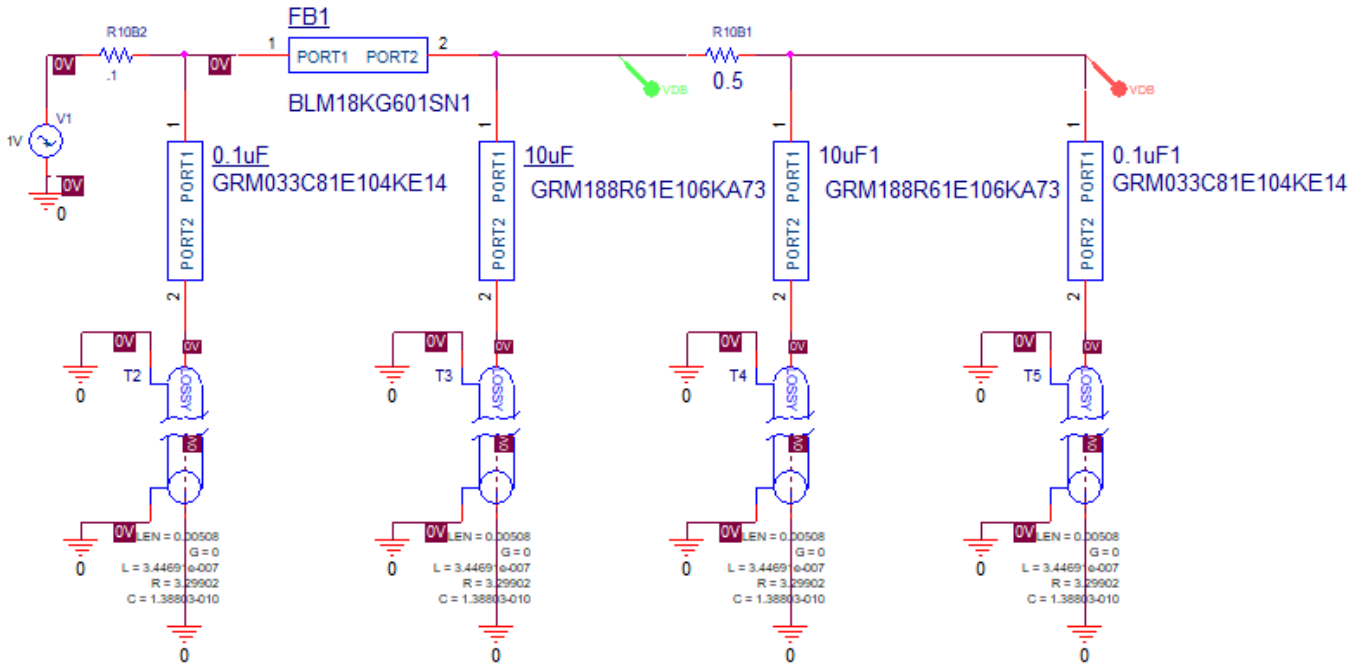

Figure 12. Simulation 6 Filter Schematics

Table 8. Simulation 6 Results

Frequency	1MHz	5MHz	10MHz	100MHz
Noise Suppression (dB)	-88	-115	-103	-92

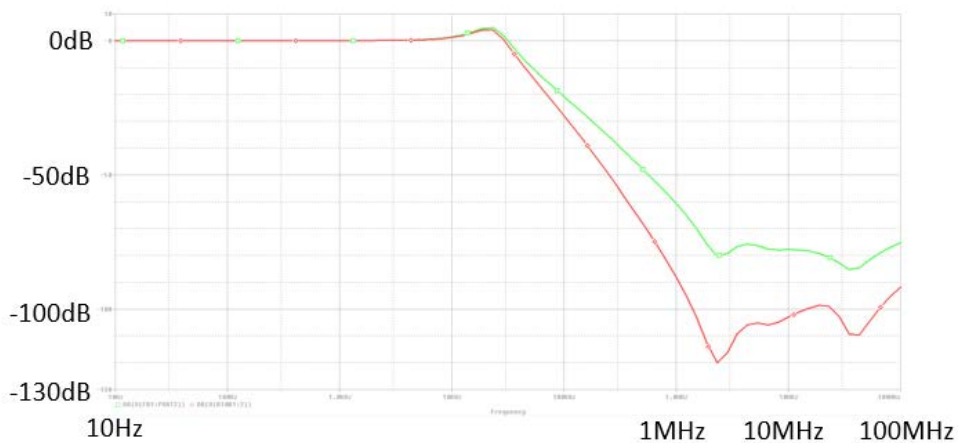

Figure 13. Simulation 6 Results Plot

## 2.7 Simulation 7

This simulation explores if the 2x 10uF capacitors can be replaced a single 22uF capacitor so that the component count is reduced by 1.

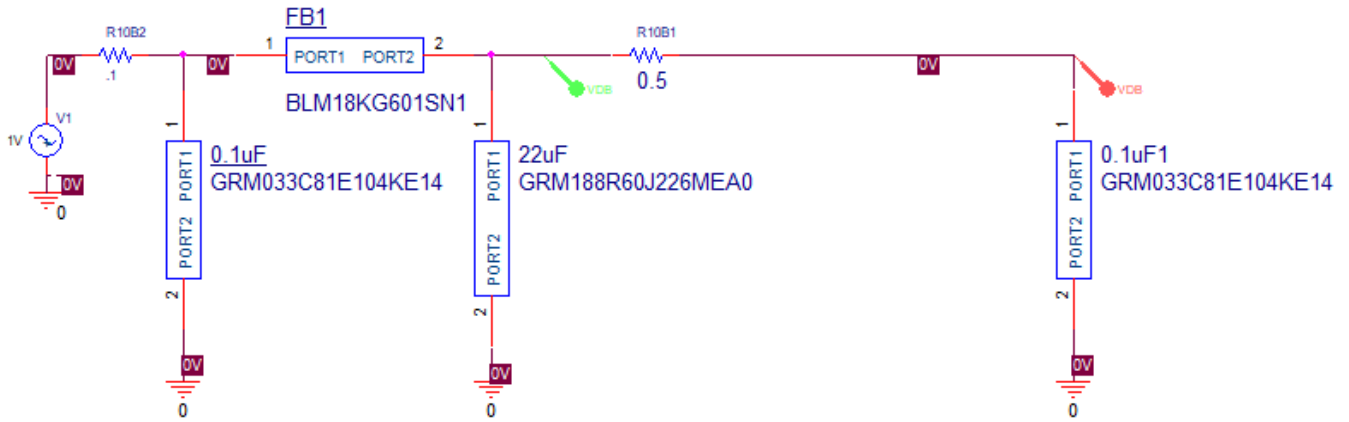

Figure 14. Simulation 7 Filter Schematics

Table 9. Simulation 7 Results

Frequency	1MHz	5MHz	10MHz	100MHz
Noise Suppression (dB)	-71	-78	-86	-88

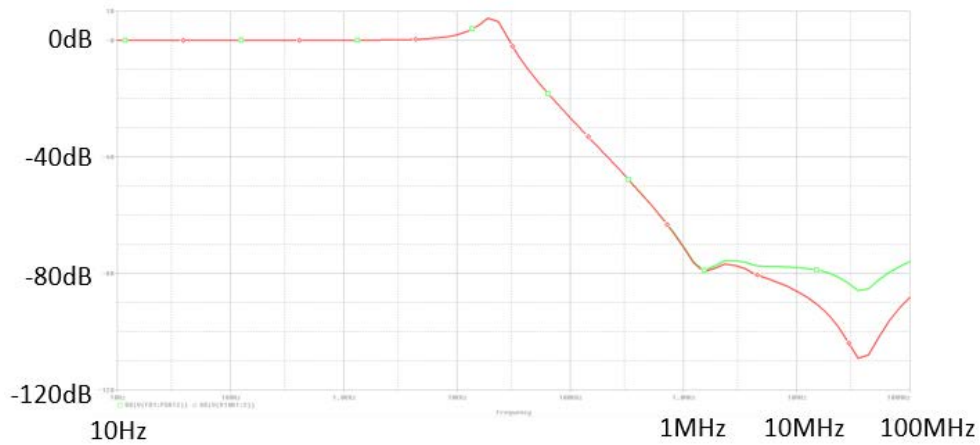

Figure 15. Simulation 7 Results Plot

## 2.8 Simulation 8

Everything else remains the same as the previous simulation; however, 22uF was moved after the series resistor.

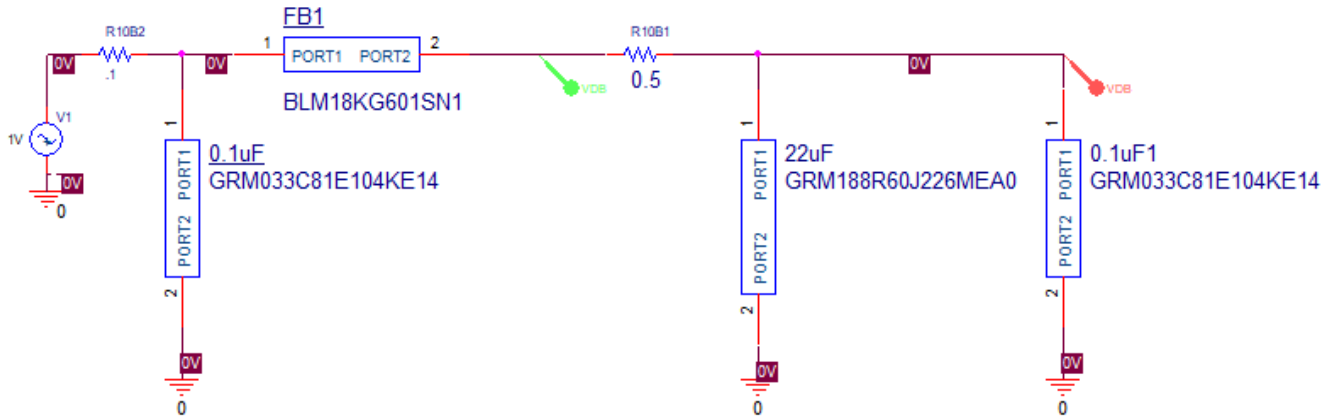

Figure 16. Filter Schematics for Simulation 8

Table 10. Simulation 8 Results

Frequency	1MHz	5MHz	10MHz	100MHz
Noise Suppression (dB)	-71	-76	-77	-82

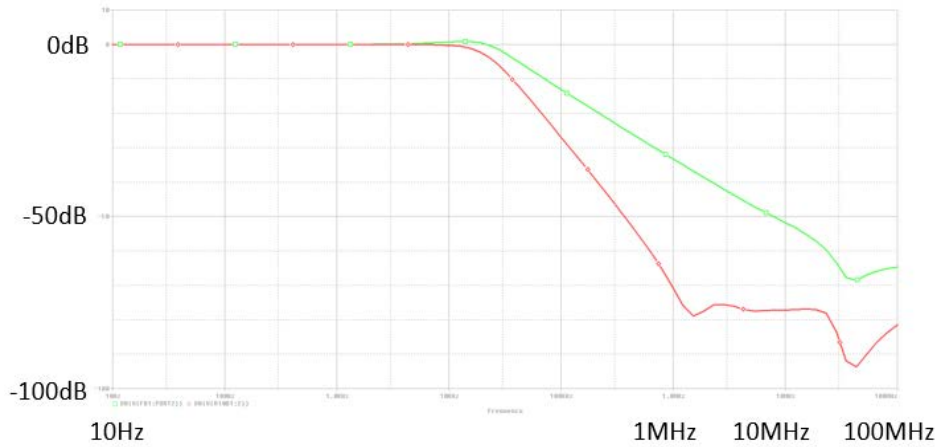

Figure 17. Simulation 8 Results Plot

## 2.9 Simulation 9

Removing the series resistor (0.5Ω). In all previous simulations, green probe is before the series resistor, red probe is after the series resistor. Attenuation level difference is shown between the two probes. This simulation removed the series resistor, changing the resistance from 0.5Ω to 25mΩ.

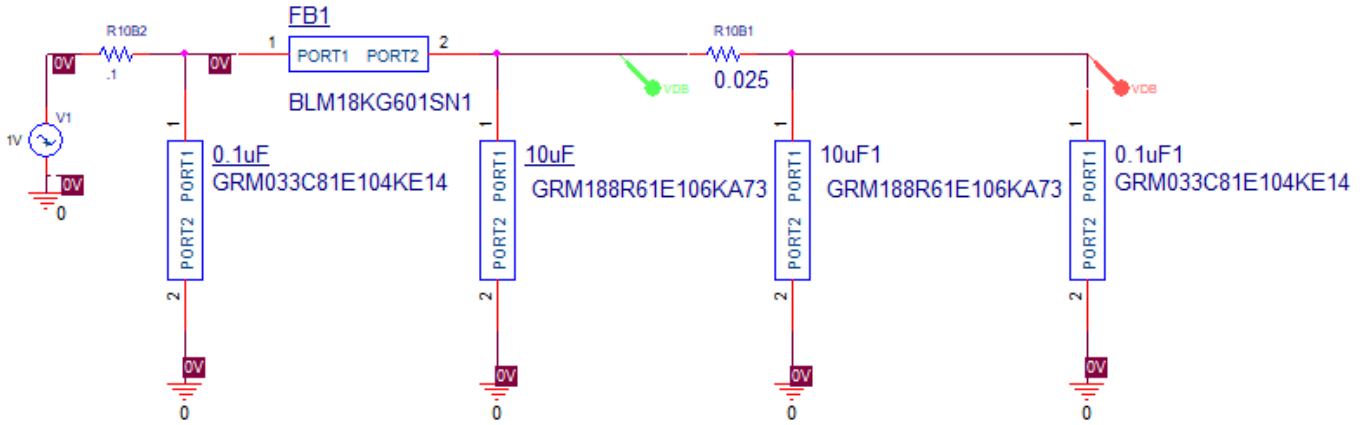

Figure 18. Filter Schematics for Simulation 9

Table 11. Simulation 9 Results

Frequency	1MHz	5MHz	10MHz	100MHz
Noise Suppression (dB)	-70	-92	-86	-85

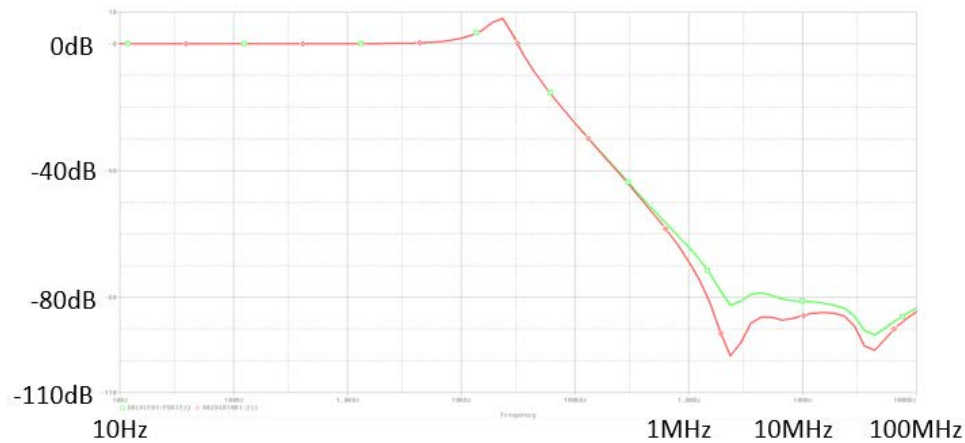

Figure 19. Simulation 9 Results Plot

### 3. Observations and Filtering Recommendations

Based on the results of the nine simulations, the following recommendations are for the VC7's power supply rail filtering:

- Use the filter topology and components in Figure 1 for each power rail that supplies VC7.
- To reduce the number of rails, combine VDDO rails if the output clocks they supply have the same frequency.
- When used as in Figure 1, the 0.5Ω series resistor will help attenuate power noise more than 10dB in the frequency range 1MHz to 100MHz. Therefore, it is recommended to use it in each power rail filtering circuit if DC voltage drop is not critical.
- The DC voltage drop concern exists on VDDA rail, which draws about 140mA in a typical application. When VDDA = 1.8V and there is a < 5% voltage drop requirement (< 90mV), it is suggested to reduce it to 0.2Ω or removing it totally. For other power rails, the current is small, the voltage drop due to this series resistor is not a concern.
- Simulation data show two 10uF capacitors at both sides of the series resistor, together with 0.1uF and the ferrite bead provides a better noise attenuation, when compared to replacing the two 10uF capacitors by a single 22uF capacitor.
- Each decoupling capacitor is grounded through its own individual via. Do not share the same ground via.
- There is no significant difference between ferrite beads of “for signal line use” and “for DC power line use” if specified impedance specified at 100MHz is the same (i.e., 22Ω or 600Ω).
- Data show that ferrite beads with 600Ω impedance at 100MHz attenuates power noise better than 220Ω counterparts from across 1MHz to 100MHz range.
- The last 0.1uF decoupling capacitor (the right-most capacitor in Figure 1) is intended to be placed as close as possible to each power pin.

### 4. Revision History

Revision	Date	Description
1.00	Jul 28, 2022	Initial release.

### 5. References

1. RC21008A/21012A-EVK Schematics
2. [www.murata.com](http://www.murata.com)
3. Hyperlynx V9.4.2

## Appendix A: Component Models

Spice models for the components used in the simulations are provided below.

### 1. 0.1uF capacitor – Murata: GRM033C81E104KE14

- \*-----
- \* SPICE Model generated by Murata Manufacturing Co., Ltd.
  - \* Copyright(C) Murata Manufacturing Co., Ltd.
  - \* Description :0603M(0201)/X6S/0.1uF/25V
  - \* Murata P/N :GRM033C81E104KE14
  - \* Property : C = 0.1[uF]
  - \* Data Generated on Nov 6, 2018

- \*-----
- \* Applicable Conditions:
  - \* Frequency Range = 100Hz-6GHz
  - \* Temperature = 25 degC
  - \* DC Bias Voltage = 0V
  - \* Small Signal Operation
- \*-----

.SUBCKT GRM033C81E104KE14 port1 port2

C1 port1 11 7.79e-8  
L2 11 12 1.58e-10  
R3 12 13 2.90e-2  
C4 13 14 3.39e-6  
R4 13 14 1.17e+3  
C5 14 15 4.20e-6  
R5 14 15 138  
C6 15 16 4.33e-6  
R6 15 16 19.5  
C7 16 17 3.49e-6  
R7 16 17 4.07  
C8 17 18 3.04e-6  
R8 17 18 6.10e-1  
C9 18 19 2.05e-6  
R9 18 19 1.24e-1  
C10 19 20 1.11e-6  
R10 19 20 2.21e-2  
L11 20 21 1.73e-11  
R11 20 21 3.77e-1  
L12 21 22 4.44e-11  
R12 21 22 1.54e-1  
C13 22 23 1.99e-8  
L13 22 23 4.78e-11

R13 22 23 2.86e-2  
C14 23 port2 8.02e-10  
L14 23 port2 8.39e-13  
R14 23 port2 1.03e-1  
R100 port1 11 5.00e+8  
.ENDS GRM033C81E104KE14

\*-----

## 2. Ferrite bead – Murata: BLM18AG221SN1

\*-----

\* SPICE Model generated by Murata Manufacturing Co., Ltd.  
\* Copyright(C) Murata Manufacturing Co., Ltd.  
\* MURATA P/N : BLM18AG221SN1  
\* Property : Z@100MHz = 220[ohm]

\*-----

\* Applicable Conditions:  
\* Frequency Range = 1MHz - 3GHz  
\* Temperature = 25 degC  
\* DC Bias Current = 0 A  
\* Small Signal Operation

\*-----

.SUBCKT BLM18AG221SN1 port1 port2  
R1 port1 1 193.7  
L1 port1 1 3.466e-7  
C2 1 2 2.326e-9  
R2 2 3 58.83  
L2 1 3 8.941e-7  
C1 port1 3 7.867e-13  
R3 3 4 24.83  
L3 3 4 1.561e-7  
R4 4 port2 1.500e-1  
.ENDS BLM18AG221SN1

\*-----

## 3. Ferrite bead – Murata: BLM18AG601SN1

\*-----

\* SPICE Model generated by Murata Manufacturing Co., Ltd.  
\* Copyright(C) Murata Manufacturing Co., Ltd.  
\* MURATA P/N : BLM18AG601SN1  
\* Property : Z@100MHz = 600[ohm]

\*-----

\* Applicable Conditions:  
\* Frequency Range = 1MHz - 3GHz

- \* Temperature = 25 degC
- \* DC Bias Current = 0 A
- \* Small Signal Operation

\*-----  
.SUBCKT BLM18AG601SN1 port1 port2  
R1 port1 1 526.0  
L1 port1 1 9.800e-7  
C2 1 2 6.265e-10  
R2 2 3 157.2  
L2 1 3 1.870e-6  
C1 port1 3 7.195e-13  
R3 3 4 20.19  
L3 3 4 6.138e-7  
R4 4 port2 2.300e-1  
.ENDS BLM18AG601SN1  
\*-----

#### 4. Ferrite bead – Murata: BLM18PG221SN1

- \*-----
- \* SPICE Model generated by Murata Manufacturing Co., Ltd.
  - \* Copyright(C) Murata Manufacturing Co., Ltd.
  - \* MURATA P/N : BLM18PG221SN1
  - \* Property : Z@100MHz = 220[ohm]

\*-----  
\* Applicable Conditions:  
\* Frequency Range = 1MHz - 3GHz  
\* Temperature = 25 degC  
\* DC Bias Current = 0 A  
\* Small Signal Operation  
\*-----

.SUBCKT BLM18PG221SN1 port1 port2  
R1 port1 1 66.41  
L1 port1 1 1.244e-6  
C1 port1 2 5.894e-13  
R2 1 2 185.5  
L2 1 2 3.355e-7  
R3 2 3 29.00  
L3 2 3 1.675e-7  
R4 3 port2 6.000e-2  
.ENDS BLM18PG221SN1  
\*-----



**5. Ferrite bead – Murata: BLM18KG601SN1**

\*-----  
\* SPICE Model generated by Murata Manufacturing Co., Ltd.  
\* Copyright(C) Murata Manufacturing Co., Ltd.  
\* MURATA P/N : BLM18KG601SN1  
\* Property : Z@100MHz = 600[ohm]  
\*-----

\* Applicable Conditions:  
\* Frequency Range = 1MHz - 3GHz  
\* Temperature = 25 degC  
\* DC Bias Current = 0 A  
\* Small Signal Operation  
\*-----

```
.SUBCKT BLM18KG601SN1 port1 port2
R1 port1 1 510.0
L1 port1 1 9.890e-7
C1 port1 2 1.128e-12
R2 1 2 158.4
L2 1 2 2.638e-6
R3 2 3 12.15
L3 2 3 7.302e-8
R4 3 port2 9.000e-2
.ENDS BLM18KG601SN1
```

**6. 10uF capacitor – Murata: GRM188R61E106KA73**

\*-----  
\* SPICE Model generated by Murata Manufacturing Co., Ltd.  
\* Copyright(C) Murata Manufacturing Co., Ltd.  
\* Description :2012M(0805)/B(-25to85[deg])/1.00e+01[uF]/6.3[V]  
\* Murata P/N :GRM219B30J106KE18  
\* Property : C = 1.00e+01[uF]  
\* Data Generated on Mar 28, 2022  
\*-----

\* Applicable Conditions:  
\* Frequency Range = 100[Hz]-6[GHz]  
\* Temperature = 25 degC  
\* DC Bias Voltage = 0V  
\* Small Signal Operation  
\*-----

```
.SUBCKT GRM219B30J106KE18 Port1 Port2
C01 Port1 N01 7.34e-06
R01 Port1 N01 5.00e+06
```

L02 N01 N02 1.11e-10  
R03 N02 N03 3.04e-03  
C04 N03 N04 1.34e-04  
R04 N03 N04 4.05e+01  
C05 N04 N05 1.96e-04  
R05 N04 N05 2.13e+00  
C06 N05 N06 1.90e-04  
R06 N05 N06 2.23e-01  
C07 N06 N07 1.50e-04  
R07 N06 N07 2.84e-02  
C08 N07 N08 1.19e-04  
R08 N07 N08 3.53e-03  
L09 N08 N09 1.21e-11  
R09 N08 N09 7.97e-02  
L10 N09 N10 3.72e-11  
R10 N09 N10 3.54e-02  
L11 N10 N11 3.03e-10  
R11 N10 N11 1.69e-02  
C12 N11 N12 1.83e-05  
L12 N11 N12 4.93e-11  
R12 N11 N12 3.48e-03  
C13 N12 N13 1.78e-05  
L13 N12 N13 2.60e-11  
R13 N12 N13 3.94e-03  
C14 N13 N14 7.85e-12  
L14 N13 N14 7.54e-11  
R14 N13 N14 9.88e+00  
C15 N14 Port2 4.57e-12  
L15 N14 Port2 5.82e-11  
R15 N14 Port2 2.35e+01  
.ENDS GRM219B30J106KE18

\*-----

**7. 22uF capacitor – Murata: GRM188R60J226MEA0**

\*-----

- \* SPICE Model generated by Murata Manufacturing Co., Ltd.
- \* Copyright(C) Murata Manufacturing Co., Ltd.
- \* Description :1608M(0603)/X5R/22uF/6.3V
- \* Murata P/N :GRM188R60J226MEA0
- \* Property : C = 22[uF]
- \* Data Generated on Jun 1, 2021

\*-----

## VC7 Power Supply Filtering Recommendations Application Note

---

\* Applicable Conditions:

\* Frequency Range = 100Hz-6GHz

\* Temperature = 25 degC

\* DC Bias Voltage = 0V

\* Small Signal Operation

\*-----

.SUBCKT GRM188R60J226MEA0 port1 port2

C1 port1 11 1.60e-5

L2 11 12 1.80e-10

R3 12 13 2.72e-3

C4 13 14 1.11e-3

R4 13 14 4.35

C5 14 15 1.33e-3

R5 14 15 5.23e-1

C6 15 16 1.04e-3

R6 15 16 8.80e-2

C7 16 17 1.25e-3

R7 16 17 1.07e-2

C8 17 18 9.81e-4

R8 17 18 1.93e-3

L9 18 19 2.75e-11

R9 18 19 8.50e-2

L10 19 20 6.17e-11

R10 19 20 2.07e-2

L11 20 21 3.13e-10

R11 20 21 1.12e-2

C12 21 22 7.61e-5

L12 21 22 5.07e-11

R12 21 22 1.87e-3

C13 22 23 2.76e-5

L13 22 23 6.98e-11

R13 22 23 2.79e-3

C14 23 24 2.58e-11

L14 23 24 2.60e-11

R14 23 24 1.80

C15 24 port2 2.12e-11

L15 24 port2 1.40e-11

R15 24 port2 2.08

R100 port1 11 2.27e+6

.ENDS GRM188R60J226MEA0

\*-----

## IMPORTANT NOTICE AND DISCLAIMER

RENESAS ELECTRONICS CORPORATION AND ITS SUBSIDIARIES (“RENESAS”) PROVIDES TECHNICAL SPECIFICATIONS AND RELIABILITY DATA (INCLUDING DATASHEETS), DESIGN RESOURCES (INCLUDING REFERENCE DESIGNS), APPLICATION OR OTHER DESIGN ADVICE, WEB TOOLS, SAFETY INFORMATION, AND OTHER RESOURCES “AS IS” AND WITH ALL FAULTS, AND DISCLAIMS ALL WARRANTIES, EXPRESS OR IMPLIED, INCLUDING, WITHOUT LIMITATION, ANY IMPLIED WARRANTIES OF MERCHANTABILITY, FITNESS FOR A PARTICULAR PURPOSE, OR NON-INFRINGEMENT OF THIRD PARTY INTELLECTUAL PROPERTY RIGHTS.

These resources are intended for developers skilled in the art designing with Renesas products. You are solely responsible for (1) selecting the appropriate products for your application, (2) designing, validating, and testing your application, and (3) ensuring your application meets applicable standards, and any other safety, security, or other requirements. These resources are subject to change without notice. Renesas grants you permission to use these resources only for development of an application that uses Renesas products. Other reproduction or use of these resources is strictly prohibited. No license is granted to any other Renesas intellectual property or to any third party intellectual property. Renesas disclaims responsibility for, and you will fully indemnify Renesas and its representatives against, any claims, damages, costs, losses, or liabilities arising out of your use of these resources. Renesas' products are provided only subject to Renesas' Terms and Conditions of Sale or other applicable terms agreed to in writing. No use of any Renesas resources expands or otherwise alters any applicable warranties or warranty disclaimers for these products.

(Disclaimer Rev.1.0 Mar 2020)

### Corporate Headquarters

TOYOSU FORESIA, 3-2-24 Toyosu,  
Koto-ku, Tokyo 135-0061, Japan  
[www.renesas.com](http://www.renesas.com)

### Contact Information

For further information on a product, technology, the most up-to-date version of a document, or your nearest sales office, please visit:  
[www.renesas.com/contact/](http://www.renesas.com/contact/)

### Trademarks

Renesas and the Renesas logo are trademarks of Renesas Electronics Corporation. All trademarks and registered trademarks are the property of their respective owners.