

Contents

1	Introduction.....	2
2	Firmware Update	2
2.1.	Flashing the Communication Board	2
2.2.	Flashing the Mass Calibration Board	4
3	History of SSC CB Firmware Versions.....	7
4	Related Documents.....	7
5	Glossary	7
6	Document Revision History.....	8

List of Figures

Figure 2.1	SSC Communication Board.....	2
Figure 2.2	COM Port and Baud Rate.....	3
Figure 2.3	Selection of Firmware File to Upload.....	3
Figure 2.4	Uploading Firmware.....	4
Figure 2.5	Step 9 – Flashing new Firmware to the SSC CB.....	4
Figure 2.6	Hardware Setup for Different MCB's – Firmware Update.....	5
Figure 2.7	Flashing New Firmware to the MCB.....	6
Figure 2.8	Flashing new Firmware to the MCB.....	6

1 Introduction

This document describes procedures for updating the firmware for the SSC Communication Board (SSC CB) and the Mass Calibration Board (MCB).

Important: This write/update procedure is possible only for CBs and MCBs with firmware versions V2.xx or higher. If the firmware version is lower than 2.0, contact IDT for detailed instructions.

This document is divided in two sections. The first section describes flashing the firmware of the SSC CB, and second is for flashing the firmware of the MCB.

BootLoader.exe is a software tool for flashing the microcontroller (μ C). This tool can be requested from an IDT sales office. The current firmware version for the SSC CB can be downloaded from IDT's website* or requested from an IDT sales office. The current firmware version for the MCB can only be requested from an IDT sales office (see page 8).

Recommendation: If using a Mass Calibration System (MCS) with more than one MCB, update all MCBs to the same firmware version. If this is not possible, contact an IDT sales office for technical details on handling different firmware versions.

2 Firmware Update

2.1. Flashing the Communication Board

Before beginning the flash procedure, verify that after power-up for the SSC CB or execution of a reset via the CB's "reset" button, the D5 LED on the SSC CB flashes several times. If not, contact an IDT sales office as this indicates that the pre-programming for the boot loader, which is included with all SSC CB firmware versions V2.0 and higher, has not been detected.

Figure 2.1 SSC Communication Board

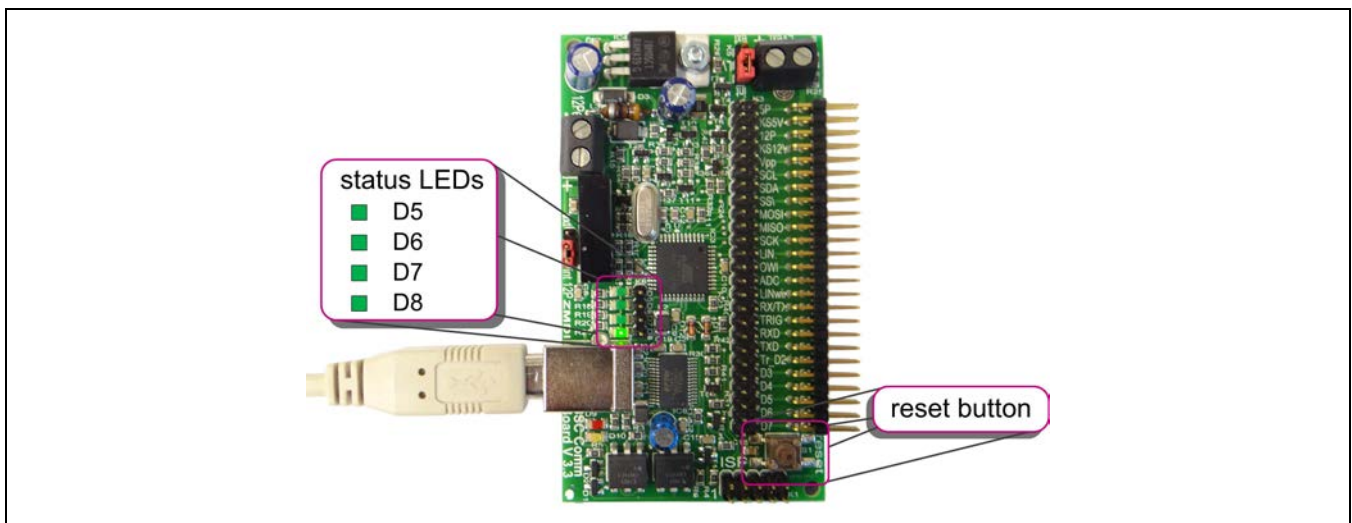

* www.IDT.com .Note: A customer log-in is required to download firmware. The site provides instructions for registering for log-in access.

Use the following steps for updating firmware:

- Step 1: Download the new SSC CB firmware from the IDT website.
- Step 2: Disconnect all boards/connections from the SSC CB.
- Step 3: Connect the PC to the SSC CB via the USB cable.
- Step 4: Start the flash program *BootLoader.exe*.
- Step 5: Verify/adjust the COM port setting and the baud rate of 19200.

Figure 2.2 COM Port and Baud Rate

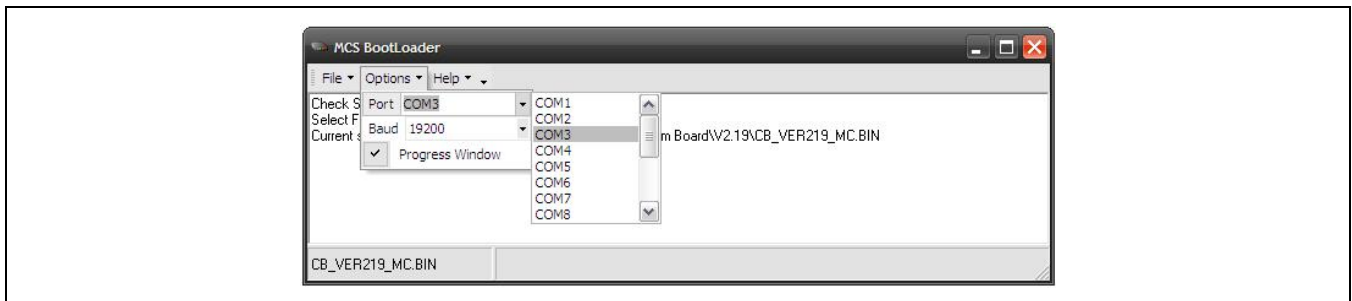

Step 6: In the “File” menu, select the firmware data file to be flashed.

Figure 2.3 Selection of Firmware File to Upload

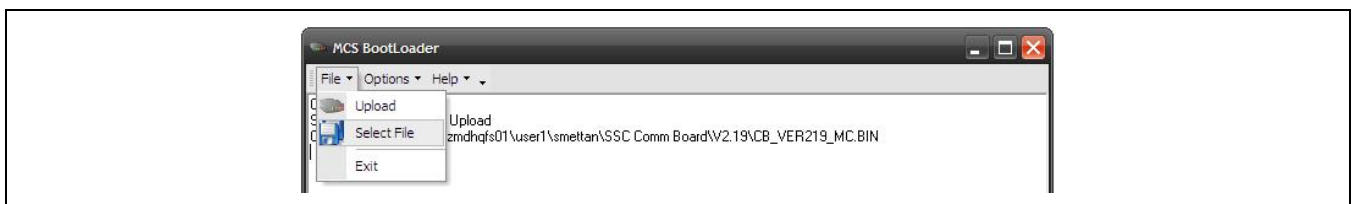

Step 7: Click “Upload” in “File” menu.

Step 8: Wait for the resulting continuous message “Sending #123 ...” in *BootLoader* and then press the “reset” button on the SSC CB (the message will repeat and the flashing will not start until the “reset” button is pushed).

Figure 2.4 Uploading Firmware

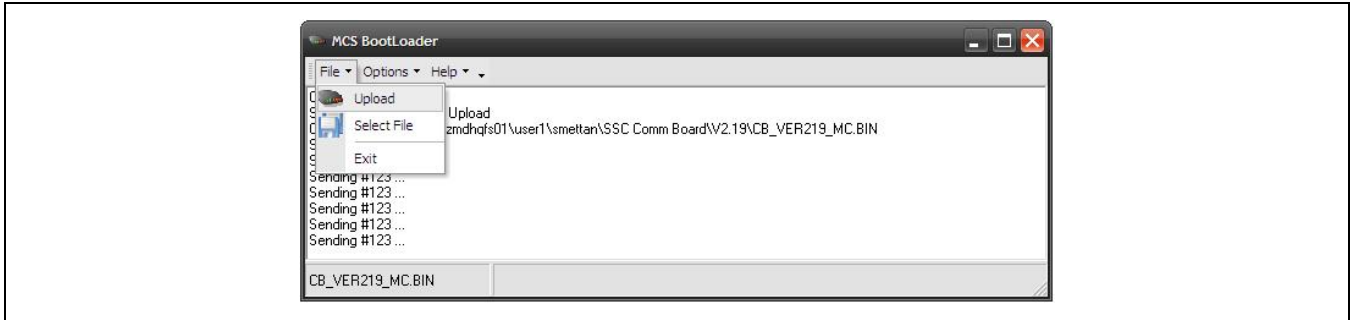

Step 9: As the flash update is processed, the progress is indicated via a status message as shown below in Figure 2.5. When the firmware update is complete, *BootLoader* will return to its main menu.

Figure 2.5 Step 9 – Flashing new Firmware to the SSC CB

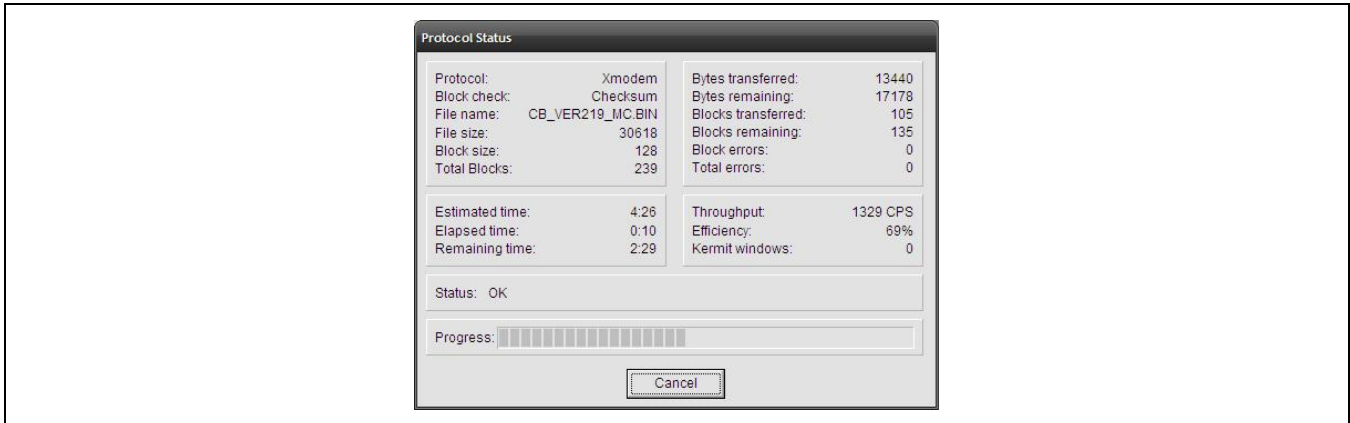

Step 10: Close *BootLoader* after finishing the upload.

2.2. Flashing the Mass Calibration Board

Note: Before beginning the flash procedure for the MCB, verify that after power-up for the MCB or execution of a reset via the MCB’s “reset” button, the D6 LED on the MCB flashes several times. If not, contact an IDT sales office as this indicates that the pre-programming for the boot loader, which is included with all MCB firmware versions V2.00 and higher, has not been detected.

Important: When updating the firmware for multiple MCBs, connect only one MCB to the SSC CB at a time and repeat the process individually for each MCB. The SSC CB must remain in continuous reset for the complete process for the MCB firmware update. This can be done with a jumper on the ISP interface of the SSC CB as shown in Figure 2.6 and explained in Step 5 below. Figure 2.6 shows the setup for different hardware versions of the MCB for firmware updates. The procedure for flashing is the same as for the SSC CB except the hardware setup.

Use the following steps for updating firmware:

- Step 1: Contact IDT for the current MCB firmware file.
- Step 2: Connect only one MCB to the SSC CB and connect the user's PC to the SSC CB via the USB cable.
- Step 3: Connect the power supply at the MCB.
- Step 4: Connect a jumper between pin 5 and 6 on the ISP interface of the SSC CB – refer to Figure 2.6.
Important: The status LED (D8) of the SSC CB must be switched off – refer to Figure 2.6.
- Step 5: The following step depends on the hardware version of the MCB – refer to Figure 2.6.
 - For MCB hardware version 2.1, connect a jumper on the “update MCB” 2-pin connector on the MCB (figure on the left).
 - For MCB hardware version 2.0, connect pin 9 of the ISP interface connector on the MCB to the TXD pin on connector K3 on the SSC CB via a cable (figure on the right).

Figure 2.6 Hardware Setup for Different MCB's – Firmware Update

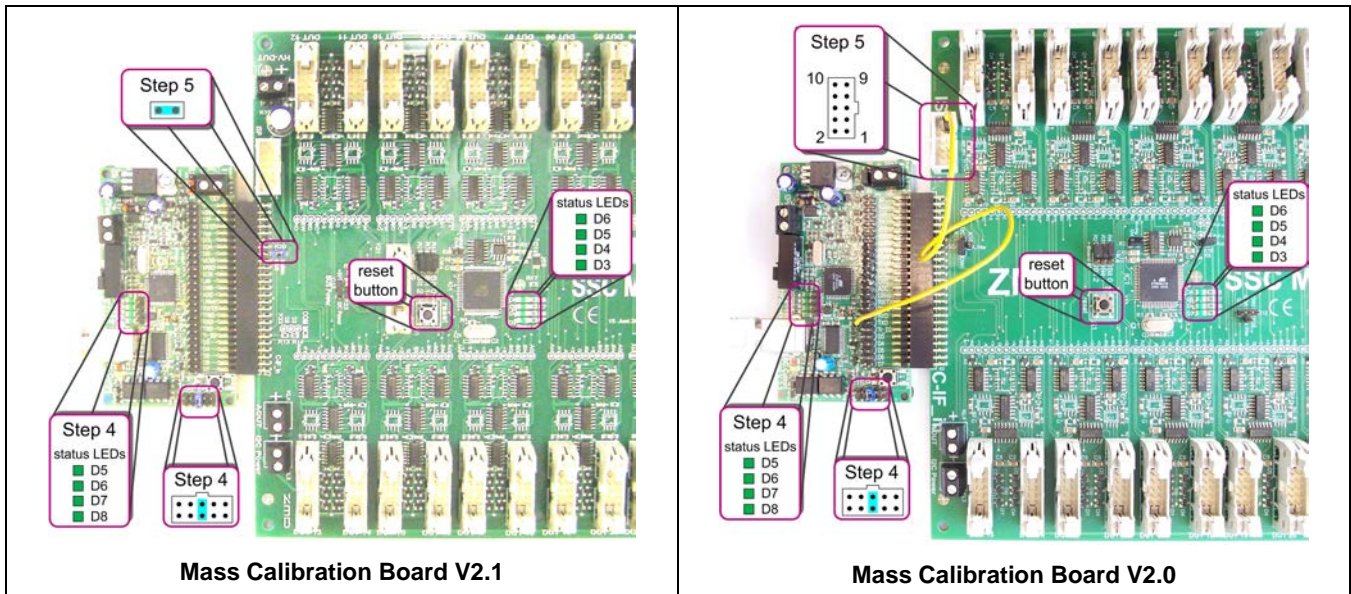

- Step 6: Start the program *BootLoader.exe*.
- Step 7: Verify/adjust the COM port setting and the baud rate of 19200. See Figure 2.2.
- Step 8: In the “File” menu, select the firmware data file to be flashed. See Figure 2.3.

Figure 2.7 Flashing New Firmware to the MCB

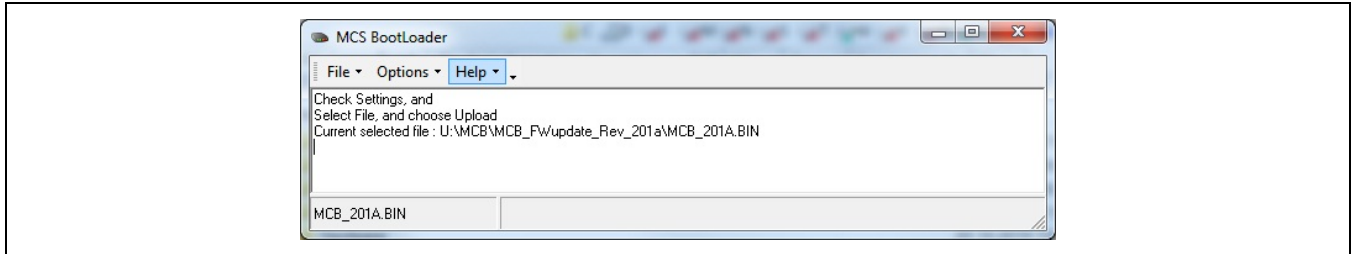

Step 9: Start “Upload” in “File” menu.

Step 10: Wait for the resulting “Sending #123 ...” message in *BootLoader*, and then press the “reset” button on the SSC CB. See Figure 2.4.

Step 11: As the flash update is processed, the progress is indicated via a status message as shown below in Figure 2.8. When the firmware update is complete, *BootLoader* will return to its main menu.

Figure 2.8 Flashing New Firmware to the MCB

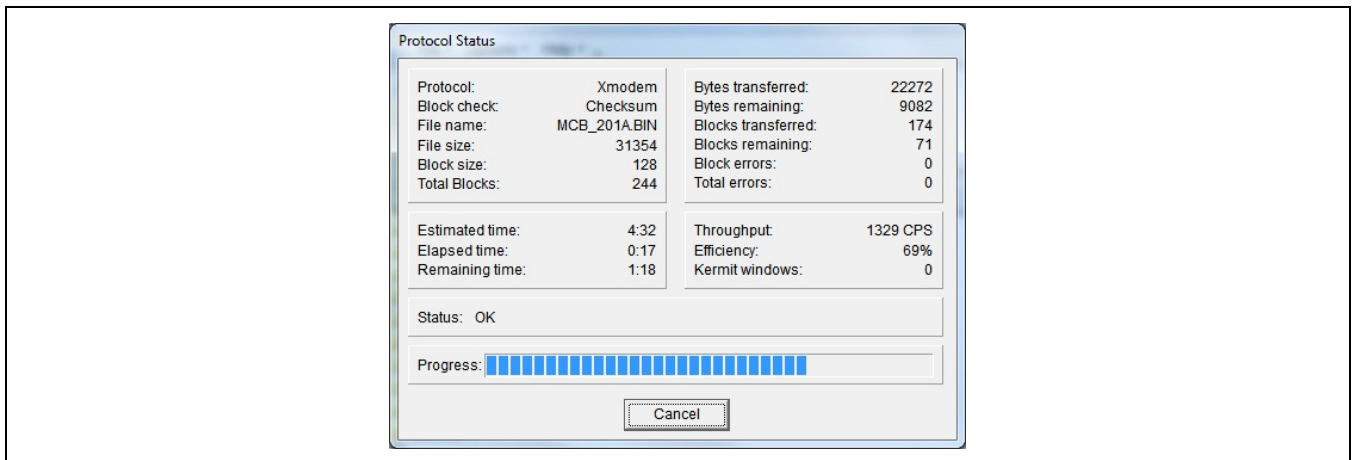

Step 12: Close *BootLoader* after finishing the upload.

3 History of SSC CB Firmware Versions

Version	Changes
V1.00	First revision March 30, 2005.
...	
V2.21	<p>Corrected problem with LIN and I²C™ using the same Timer which had resulted in I²C™ not initializing Timer again and thus different timing could have occurred if LIN communication was used.</p> <p>Improvements implemented:</p> <ul style="list-style-type: none"> I/O stack implemented → refer to <i>SSC Communication Board - Command Syntax</i> for details. Command separator implemented. TWAITLISTxxxxx command implemented. I²C™ “query” command implemented. SPI move command implemented. LIN open interface for LIN mode implemented. Extended version command implemented. ZACwire™ error codes extended.

4 Related Documents

Document
SSC Communication Board - Data Sheet
SSC Mass Calibration Board – Data Sheet
SSC Communication Board – Command Syntax

Visit www.IDT.com/SSC-COMM-BD and www.IDT.com/SSC-MCB or contact your nearest sales office for the latest version of these documents.

5 Glossary

Term	Description
CB	Communication Board
MCB	Mass Calibration Board
SSC	Sensor Signal Conditioner
μC	Microcontroller

6 Document Revision History

Revision	Date	Description
1.00	March 20, 2009	First release.
1.01	April 23, 2009	Added information about MCB firmware version.
1.02	September 23, 2009	Extended information for MCB firmware update to include information about Mass Calibration Board V2.1. Added new sales office (ZMD Far East).
1.03	January 28, 2010	Removed section for boot loader installation. Adjusted to new template. Included information's about CB firmware V2.19.
1.04	July 9, 2010	Extended MCB firmware flash description to avoid reference to CB firmware flash. Extended information about CB firmware V2.19 and include information's about V2.20.
1.05	July 30, 2010	Renamed ZMD31xxx to ZSC31xxx / ZSSC3xxx.
1.06	November 9, 2012	Added information for CB firmware version 2.21. Added new sales office (Zentrum Mikroelektronik Dresden AG, Korea Office). Updated illustrations.
1.07	July 31, 2013	Update for contact information and imagery for cover and header.
	March 30, 2016	Changed to IDT branding.

IMPORTANT NOTICE AND DISCLAIMER

RENESAS ELECTRONICS CORPORATION AND ITS SUBSIDIARIES (“RENESAS”) PROVIDES TECHNICAL SPECIFICATIONS AND RELIABILITY DATA (INCLUDING DATASHEETS), DESIGN RESOURCES (INCLUDING REFERENCE DESIGNS), APPLICATION OR OTHER DESIGN ADVICE, WEB TOOLS, SAFETY INFORMATION, AND OTHER RESOURCES “AS IS” AND WITH ALL FAULTS, AND DISCLAIMS ALL WARRANTIES, EXPRESS OR IMPLIED, INCLUDING, WITHOUT LIMITATION, ANY IMPLIED WARRANTIES OF MERCHANTABILITY, FITNESS FOR A PARTICULAR PURPOSE, OR NON-INFRINGEMENT OF THIRD PARTY INTELLECTUAL PROPERTY RIGHTS.

These resources are intended for developers skilled in the art designing with Renesas products. You are solely responsible for (1) selecting the appropriate products for your application, (2) designing, validating, and testing your application, and (3) ensuring your application meets applicable standards, and any other safety, security, or other requirements. These resources are subject to change without notice. Renesas grants you permission to use these resources only for development of an application that uses Renesas products. Other reproduction or use of these resources is strictly prohibited. No license is granted to any other Renesas intellectual property or to any third party intellectual property. Renesas disclaims responsibility for, and you will fully indemnify Renesas and its representatives against, any claims, damages, costs, losses, or liabilities arising out of your use of these resources. Renesas' products are provided only subject to Renesas' Terms and Conditions of Sale or other applicable terms agreed to in writing. No use of any Renesas resources expands or otherwise alters any applicable warranties or warranty disclaimers for these products.

(Disclaimer Rev.1.0 Mar 2020)

Corporate Headquarters

TOYOSU FORESIA, 3-2-24 Toyosu,
Koto-ku, Tokyo 135-0061, Japan
www.renesas.com

Contact Information

For further information on a product, technology, the most up-to-date version of a document, or your nearest sales office, please visit:
www.renesas.com/contact/

Trademarks

Renesas and the Renesas logo are trademarks of Renesas Electronics Corporation. All trademarks and registered trademarks are the property of their respective owners.