

Renesas RA Family

Securing Data at Rest Utilizing the Renesas Security MPU

Introduction

This application project discusses the considerations for securing **Data at Rest** in an embedded system and provides guidelines on how to use the Security MPU hardware feature of the RA Family MCUs to implement a secure Data at Rest solution. Securing **Data at Rest** refers to the features and services provided to protect sensitive data residing on a device which may or may not be modifiable. At the time of release of this Application Project, the group of RA Family MCUs which include the Security MPU are RA6M3, RA6M2, RA6M1, RA6T1, RA4M1, RA4W1, RA2L1 and RA2A1.

Note: In the following sections within this application note, “RA MCUs” refers to above mentioned MCU Groups.

RA MCUs offer data encryption, authentication schemes, and read/write and write-once access protection from CPU and bus masters for secure Data at Rest designs. In addition, RA MCUs provide security functions that disable control of certain security-related peripherals from non-secure software access.

For internal flash applications, this application project provides usage examples for sensitive data read protection, write protection, read/write protection, write-once protection, and write-once with read protection. For internal SRAM usage, this application project provides usage examples for read and write protection.

Upon completion of this guide, you will be able to use the secure Data at Rest features and solutions provided by RA MCUs in your own design, configure the secure components correctly for the target application, and write code using the included application example code as a reference. This guide provides a step-by-step operational flow for setting up the memory access features to efficiently use the security features of the RA MCU. More detailed hardware feature and API descriptions are available in the hardware user manual and the *Flexible Software Package (FSP) User's Manual* (see References section).

Required Resources

Development tools and software

- The e² studio ISDE v2023-10 or later
- Renesas Flex Software Package (FSP) v5.0.0 or later
- SEGGER J-link® USB driver

The above three software components: the FSP, J-Link USB drivers and e² studio are bundled in a downloadable platform installer available on the FSP webpage at renesas.com/ra/fsp

Other tools

- Visual Studio 2017 Community Version (<https://visualstudio.microsoft.com/downloads/>)
- Download and install Renesas Flash Programmer V3 using <https://www.renesas.com/us/en/software-tool/renesas-flash-programmer-programming-gui#downloads>
- SEGGER J-Link V7.92j or later (segger.com/downloads/jlink/)

Hardware

- EK-RA6M3, Evaluation Kit for RA6M3 MCU Group (renesas.com/ra/ek-ra6m3)
- Workstation running Windows® 10; the Tera Term console, or similar application
- Two USB device cables (type-A male to micro-B male)

Prerequisites and Intended Audience

This application project assumes you have some experience with the Renesas e² studio ISDE and FSP. Before you perform the procedures in this application note, follow the procedure in the EK-RA6M3 Quick Start Guide to build and run the Out of Box program. Doing so enables you to become familiar with e² studio and the FSP and validates that the debug connection to your board functions properly. In addition, this

application project assumes you have some knowledge on RA6M3 flash memory organization and customizing e² studio linker script.

The intended audience are users who are interested in developing secure Data at Rest solutions with RA MCUs.

Contents

1.	Secure Data Overview	4
1.1	Sensitive Data at Rest Topology	4
1.2	Data at Rest Security Measures	4
1.2.1	Data Encryption	4
1.2.2	Data Access Control	4
1.3	Data at Rest Risk Profile and Attack Surface Analysis	6
1.4	Secure Data at Rest with and without Secure Boot Loader	6
2.	RA MCU Features for Secure Data at Rest	6
2.1	Overview of RA MCU Security Elements	7
2.2	Security MPU	7
2.2.1	Secure Data Regions	7
2.3	Flash Access Window (FAW)	11
2.3.1	Using the Security MPU and FAW for Code Flash Write Protection	11
2.4	Debugging Security Considerations	13
2.5	Notes on Arm MPU, Bus Master MPU, Bus Slave MPU	13
2.6	Other Security Elements	13
2.6.1	Secure Crypto Engine (SCE)	13
3.	Configuring the Security Elements	14
3.1	Overview of RA MCU Option-Setting Memory	14
3.2	Configuring the Security MPU	15
3.2.1	Setting up the Security MPU Registers	15
3.2.2	Locating Secure Code/Data to a Specific Memory Region	16
3.2.3	Resetting the Security MPU registers	16
3.3	Configuring the FAW	16
3.3.1	Setting up the FAW Region	16
3.3.2	Clearing the FAW Regions	16
3.4	Permanent Locking of the FAW Region	17
3.5	Setting up the Security Control for Debugging	17
3.5.1	Methods of Setting the OSIS ID Code	19
3.5.2	Method of Setting up the OSIS ID Code for Debugging	20
3.5.3	Method of Resetting the OSIS ID code	20
4.	Operational Flow using Security MPU and FAW	20
4.1	Internal Flash and SRAM Read Protection	20
4.2	Internal Flash Write Protection	21

4.2.1	Operational Flow	22
4.3	Internal Flash and SRAM Read/Write Protection	22
4.3.1	Operational Flow	22
4.4	Internal Flash Write-Once Protection	23
4.4.1	Operational Flow	23
4.5	Internal Flash Write-Once and Read Protection	23
4.5.1	Operational Flow	23
4.6	Operation Notes	24
4.6.1	Memory Allocation	24
4.6.2	Limitations on Programming the Option-Setting Memory	24
4.6.3	Factory Bootloader Accessibility	24
4.6.4	Access Secure Function from Non-Secure Functions	24
4.6.5	Debugger Access to the Security MPU Regions.....	24
5.	Security Application e ² studio Projects: Internal Flash and SRAM	24
5.1	Project 1: e ² studio project - Internal Flash and SRAM Read Write Protection	25
5.1.1	Software Architecture Overview	25
5.1.2	Memory Allocation Arrangement	26
5.1.3	Functionality Description	28
5.1.4	Establishing and Running Software from Secure SRAM Region.....	29
5.1.5	Importing and Building the Project	30
5.1.6	Hardware Setup.....	30
5.1.7	Verifying the Secure Functionalities	30
5.1.8	Migrating to Other RA MCUs.....	37
5.2	Project 2: e ² studio Project - Reset the Security MPU and FAW setting	37
5.3	Project 3: PC Application to Permanently Lock the FAW.....	40
5.4	Example Reset J-Link Script for the Security MPU and FAW.....	42
5.5	J-Link Scripts for Resetting OSIS ID code for RA6M3	43
6.	Secure Data at Rest Next Steps	46
6.1	Secure Data Encryption and Authentication	46
6.2	External Storage Secure Data at Rest	46
6.3	Example using the Security MPU Security Functions	46
7.	References	46
8.	Website and Support	47
	Revision History	48

1. Secure Data Overview

With the dawn of AI, IoT, and Cloud connectivity, digital data security has become the number one priority when protecting trade secrets and personal privacy.

Secure data technology includes **Data in Transit** and **Data at Rest**. **Data in Transit**, or data in motion is data actively moving from one location to another, such as across the internet or through a private network. **Data in Transit protection** is the protection of data while it is traveling from network to network or being transferred from a local storage device to a cloud storage device. **Data at Rest** is data that is not actively moving from device to device or network to network, such as data stored on a hard drive, laptop, flash drive, embedded memory, or archived/stored in some other way. **Data at Rest protection** aims to secure inactive data stored on any device or network. This application project focuses on **Data at Rest design** in an embedded environment using a RA MCU.

Data at Rest protection uses **Data Encryption** and **Data Access Control** as major security measures. This application project provides detailed steps to establish the Write Once and Read/Write Access Control for a RA MCU as well as guidelines for applying these security features to a wide range of secure **Data at Rest** applications. Data Encryption is not covered in this release and may be provided in later releases.

When considering securing **Data at Rest**, one should consider the impact of using a secure boot solution to the overall application design.

1.1 Sensitive Data at Rest Topology

In an embedded system, secure data can reside in volatile data storage (MCU's internal SRAM or external SDRAM) or non-volatile data storage (such as MCU's internal flash storage, external QSPI storage, and external EEPROM storage.) As part of the application security design, one must consider the topology of the data based on its use case. As an example, in a medical device, some data (like blood pressure measured every 5 minutes) can be stored in volatile memory while other types of data (daily blood pressure averages) may need to be stored in non-volatile memory for future use. One should consider the nature of the data and therefore determine its topology before beginning the design as this decision will have an impact on securing the data.

With the first release of this application project, example code will be available to demonstrate how to secure data that resides in an internal SRAM or internal flash storage. The follow-on release of this application project will describe the methodology and provide sample projects to secure data in external storage (QSPI, EEPROM, and so forth.)

1.2 Data at Rest Security Measures

Encryption and **Access Control** are two of the main secure Data at Rest protection schemes that will be discussed in this application project. These two schemes apply to both volatile and non-volatile storage types including internal and external storage. With the first release of this application project, access control for internal storage (both volatile and non-volatile) will be covered with example projects.

1.2.1 Data Encryption

Data Encryption is widely used in both secure **Data at Rest** and **Data in Transit**.

Securing internal data through encryption is increasingly becoming a necessity for small Arm® Cortex MCUs as these devices are used more in networking and communication applications. Secure Data at Rest almost always means the data is encrypted or certain protocols exist that include encryption to protect the data from unauthorized access. The SCE (Secure Crypto Engine) feature of RA MCUs are, for example, used to generate encrypted private keys.

An example use of encryption of Data at Rest is encryption of data in external storage. An embedded system could use an AES key to encrypt sensitive data and code that resides on the external storage. Upon successful authentication, the external code data can be decrypted and used.

1.2.2 Data Access Control

Increased demands for device connectivity as well as increased complexity in embedded systems result in more potential attack surfaces exposed. Controlled access to the secure data effectively reduces the attack surface, thus increasing system security. The following is a brief introduction to possible use cases where access controls provided in RA MCUs can be applied.

1.2.2.1 Read Protection

Sensitive data and code residing in flash and SRAM can have read protection properties set such that only software granted with read permission can access them. RA MCUs have a Security MPU unit that can help establish sensitive regions with read protection.

- Section 2.2 introduces the Security MPU's functionality
- Section 3.2 provides the configuration methods for the Security MPU
- Section 4.1 explains the operational flow of establishing read protection using the Security MPU.

1.2.2.2 Write Protection

It is important to protect sensitive data from being maliciously modified or erased. Volatile and non-volatile data can be write-protected to avoid unauthorized writes by using the memory options setting in RA MCUs.

There are two ways to establish flash write protection:

- The RA MCU Security MPU can disable the flash erase and write access from non-secure software access. See section 2.2 for details.
- The RA MCU Flash Access Window (FAW) can protect sensitive flash data from being modified by secure and non-secure software.
 - Section 2.3 introduces the FAW functionality
 - Section 3.3 provides the configuration methods for the FAW
 - Section 4.2 explains the operational flow of establishing write protection using the FAW.

1.2.2.3 Read/Write Protection

Read/write protection reduces the attack surface from malware and IP theft. For internal flash data, similar to write protection, there are two ways RA MCUs can provide read/write protection:

- The RA Security MPU can disable read and write access to the security MPU flash and SRAM regions from non-secure software.
- When the Security MPU and FAW are used together, the sensitive data in flash can be read and write protected from both secure and non-secure software. An example project for this use case is provided in this release.
 - Section 4.3 explains the operational flow of establishing read and write protection using the Security MPU and FAW.

1.2.2.4 Write-Once Protection

In some use cases, sensitive **Data at Rest** needs to be protected from access or alteration for the lifetime of the device. For example, a secure boot loader must be immutable for the lifetime of the product. For use cases where the data resides on internal flash, FAW settings can be programmed to provide write-once protection.

It is important to note the implication of using a secure boot manager in your design. If your end application uses a secure bootloader, then special consideration must be taken to include the write-once data memory regions for the application with the regions that the secure bootloader reserves for its own. This must be done because setting the Flash Access Window (FAW) properties to implement the write once policy can only be done once for the lifetime of the device. In other words, once the FAW policies are programmed, they cannot be changed.

- Section 4.4 explains the operational flow of establishing write-once secure data and program usage.

1.2.2.5 Write-Once and Read Protection

Write-once protected data can be optionally read protected. When handling sensitive data, read protection can be provided to the write-once protected flash data such that only secure software can read the contents. For RA MCUs, this is realized by using both the Security MPU and FAW.

- Section 4.5 explains the operational flow of establishing write-once and read protection for RA MCUs.

1.3 Data at Rest Risk Profile and Attack Surface Analysis

To fully consider and design for secure Data at Rest in an embedded environment, one should thoroughly consider the following topics:

1. Consider who will have access to the sensitive data in the embedded system.
2. Consider if the CPU bus can access the sensitive data.
3. Consider if other bus masters can access the sensitive data. If so, determine which peripheral the bus master connects to, and what entity this peripheral communicates with.
4. Consider if the debugger can access the sensitive data.
5. Consider the robustness of the application design such that there are measures taken against the application itself to accidentally damage the sensitive data by overwriting the security policies and measures in place.

Reducing the attack surface helps in all of the above situations. Securing the entire MCU's memory may not effectively enhance the overall data security, since a larger attack surface translates to a higher chance that hackers will find a weak point. A good guideline for securing sensitive data is to design the application such that only the minimum amount of data is secured, and access is controlled through strategic interfaces.

The analysis of a system's risk profile and attack surface is outside of the scope of this application note; however, the security measures offered by RA MCUs will be introduced to help in reducing the attack surface and minimizing the system's risk profile.

1.4 Secure Data at Rest with and without Secure Boot Loader

Whether your system will or will not use a secure bootloader solution will have an impact on how to implement secure Data at Rest.

As mentioned before in section 1.2.2 Data Access Control, there may be a need for the application to protect sensitive data for the lifetime of the device and a secure boot manager is being used. In this case, one must consider the setting of FAW (Flash Access Window) properties appropriately to ensure that the application-specific sensitive data can be allocated in the region unmodifiable by FAW and programmed onto the MCU at the same time the secure boot manager is programmed during the manufacturing provisioning process. In addition, if the application must protect sensitive data with read protection only, the Security MPU region needs to be appropriately considered to ensure that the application-specific read-protected sensitive data can be allocated within the Security MPU region.

It is worth noting that RA MCUs allocate the Security MPU setting in the first block of the user flash (which is a block of 8 KB flash). As a result, if there is a need to permanently lock the Security MPU settings, the first 8 KB of internal flash needs to be part of the write-once flash region.

2. RA MCU Features for Secure Data at Rest

RA MCUs provide a rich set of hardware features to address secure Data at Rest needs. From a high level, RA MCUs support the following data protection features:

- Write Once access control for internal flash
- Read/write access control for internal flash
- Read/write access control for internal SRAM
- Data access protection from bus masters and debuggers
- Hardware data encryption support for both volatile and non-volatile, internal and external storage
- Security functions to disable certain peripherals from being accessed by a non-secure program

This chapter will introduce the hardware features that can support the above security features without getting into the operational details. Details on the configurations of these hardware components are provided in section 3.

Integration of the MCU internal data access control with encryption support for external data provides a consistent level of security support for the entire embedded system.

2.1 Overview of RA MCU Security Elements

Following is a list of security elements on the RA MCUs.

- Security MPU
- Flash Access Window (FAW)
- Secure Crypto Engine (SCE)
- Debug Protection with OSIS

Table 1 summarizes the availability of the secure elements on the RA MCUs.

Table 1. Secure Elements of RA MCUs

MCU Groups ►	RA6M3, RA6M2, RA6M1, RA6T1	RA4M1, RA4W1	RA2A1, RA2L1, RA2E1
MCU Feature ▼			
Security MPU	Yes	Yes	Yes
FAW	Yes	Yes	Yes
SCE	Yes (*)	Yes (*)	Yes (*)
OSIS Register	Yes	Yes	Yes

Note: * Refer to section 2.6.1 for details on the SCE support for RA MCU families. RA2A1 MCU hardware user manual named the Security and Encryption hardware block differently compared with the other part.

This section also explains how the Arm® MPU, bus master MPU, and bus slave MPU operation relate to Data at Rest from a high level.

2.2 Security MPU

The Security MPU feature of RA MCUs implements a set of versatile data security policies by creating isolation between different software and hardware components. Identification of secure and non-secure program and data is based on address location.

The Security MPU settings are read and applied before the reset vector is fetched, and therefore apply before any code is executed.

2.2.1 Secure Data Regions

Figure 1 describes the available secure data regions and secure program regions provided by the Security MPU. Each region is defined by a pair of start and end addresses and an enable bit.

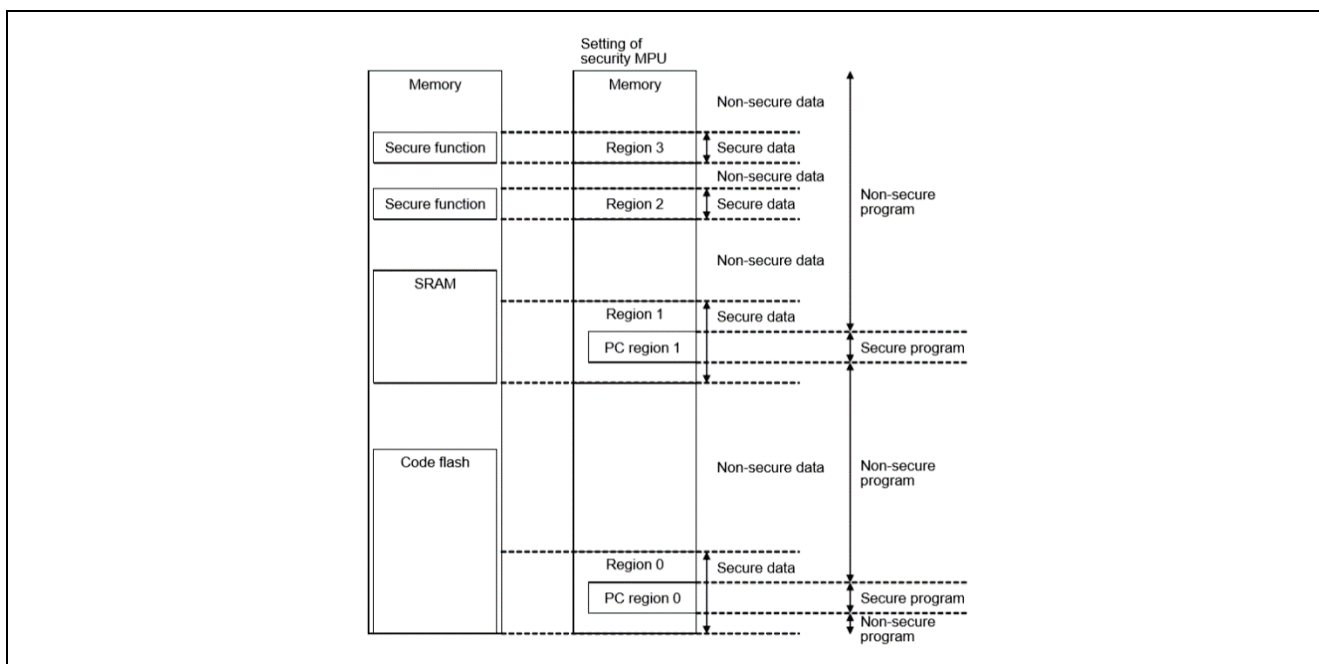

Figure 1. Security MPU Secure Regions

The Security MPU provides four secure data regions, as shown in Figure 1.

- One secure flash data region (located in the MCU's code flash region). Note that in terms of Security MPU usage, the secure flash data region can contain both secure flash data and secure flash program.

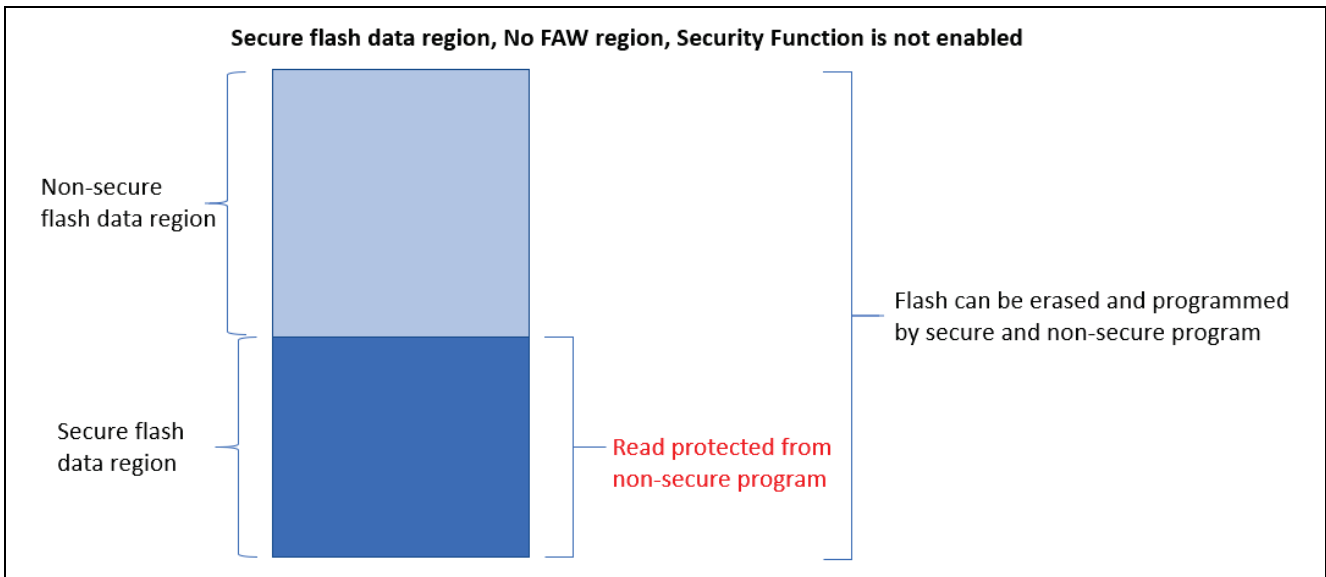

Figure 2. Secure Flash Data Region

- One secure SRAM data region. Note that in terms of Security MPU usage, secure SRAM data region can contain both secure SRAM data and secure SRAM program.

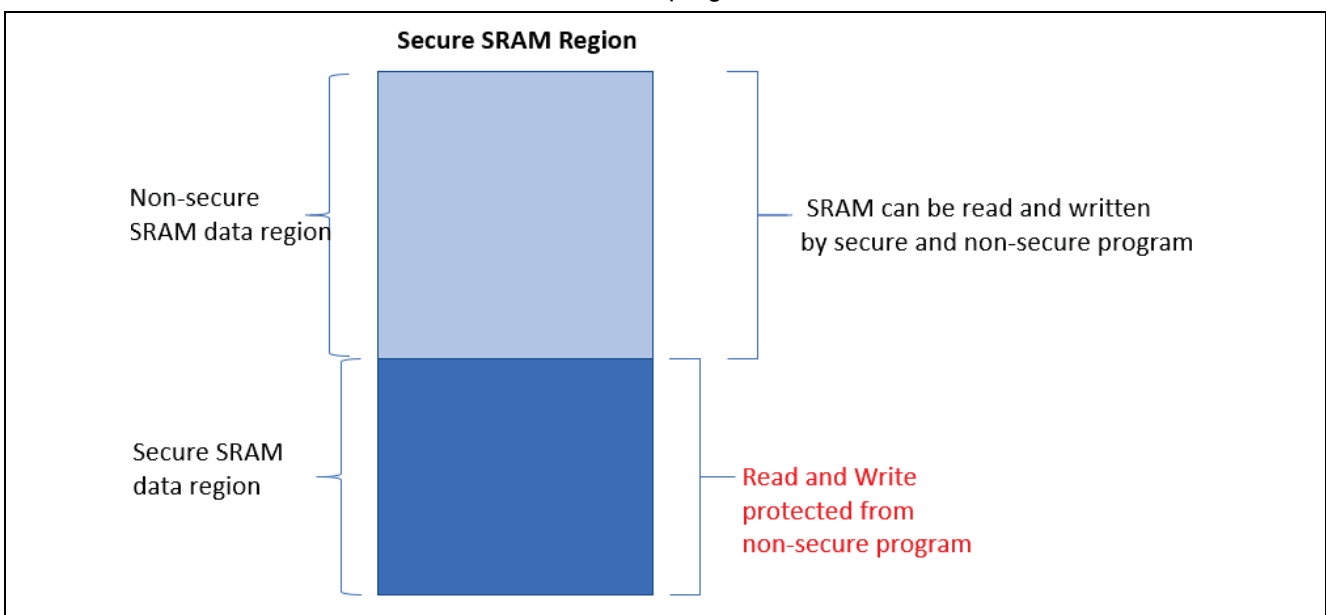

Figure 3. Secure SRAM Data Region

- Two security function regions
 - Security function region for the SCE (Secure Crypto Engine): address 0x400C0000 to 0x400DFFFF
 - This region maps to the RA MCU's internal peripheral bus 7
 - When this security function is enabled, the SCE cannot be controlled from a non-secure program
 - Security function for the flash (code and data) erase and program (E/P): address 0x40100000 to 0x407FFFFF
 - This region maps to the RA MCU's internal peripheral bus 9
 - When this security function is enabled, the flash cannot be put in erase and program mode from a non-secure program
 - Note that this security function does not control TSN even though it is in the same memory space.

Addresses assigned for each bus		
Addresses	Bus	Area
0000 0000h to 01FF FFFFh	Memory bus 1, 3	Code flash memory
1FFE 0000h to 1FFF FFFFh	Memory bus 2, 3	SRAMHS
2000 0000h to 2003 FFFFh	Memory bus 4	SRAM0
2004 0000h to 200F FFFFh	Memory bus 5	SRAM1 and Standby SRAM
4000 0000h to 4001 FFFFh	Internal peripheral bus 1	Peripheral I/O registers
4004 0000h to 4005 FFFFh	Internal peripheral bus 3	
4006 0000h to 4007 FFFFh	Internal peripheral bus 4	
4008 0000h to 4009 FFFFh	Internal peripheral bus 5	
400C 0000h to 400D FFFFh	Internal peripheral bus 7	
400E 0000h to 400F FFFFh	Internal peripheral bus 8	Graphic IPs (JPEG, GLCDC, and DRW)
4010 0000h to 407F FFFFh	Internal peripheral bus 9	Flash memory (in P/E*1), data flash memory and TSN
6000 0000h to 67FF FFFFh	External bus	QSPI area
8000 0000h to 97FF FFFFh	External bus	CS area and SDRAM area

Figure 4. Security Function Regions

2.2.1.1 Secure Program

The Security MPU provides two secure program regions, each defined by a pair of start and end Program Counter (PC) addresses and an enable bit. There can be one secure flash program region and one secure SRAM program region. For security purpose, it is recommended that the secure program regions are located within the secure flash and secure SRAM data region respectively as shown in Figure 1.

Note: The secure program region can reside outside of the secure flash and secure SRAM region; however, in this case, there is a security hole. The secure program in Flash and SRAM can be read by non-secure software.

Non-secure program and secure program can make function calls into each secure and non-secure region, which provides efficiency in embedded system design.

2.2.1.2 Secure Access Monitor and Protection

- The Security MPU monitors and protects secure flash and secure SRAM data regions (Region 0 and Region 1) from unauthorized CPU read from the D Code bus (Data access), as shown in Figure 5. The I Code bus (Instruction access) is not monitored. This allows secure instructions to be accessed by the non-secure program.
- The Security MPU monitors and protects secure SRAM data and security function regions from system bus access (such as debugger access), as shown in Figure 5.
- The Security MPU monitors and protects all four secure data regions from access from the three bus master groups. See the hardware user's manual for definition of the bus master groups.

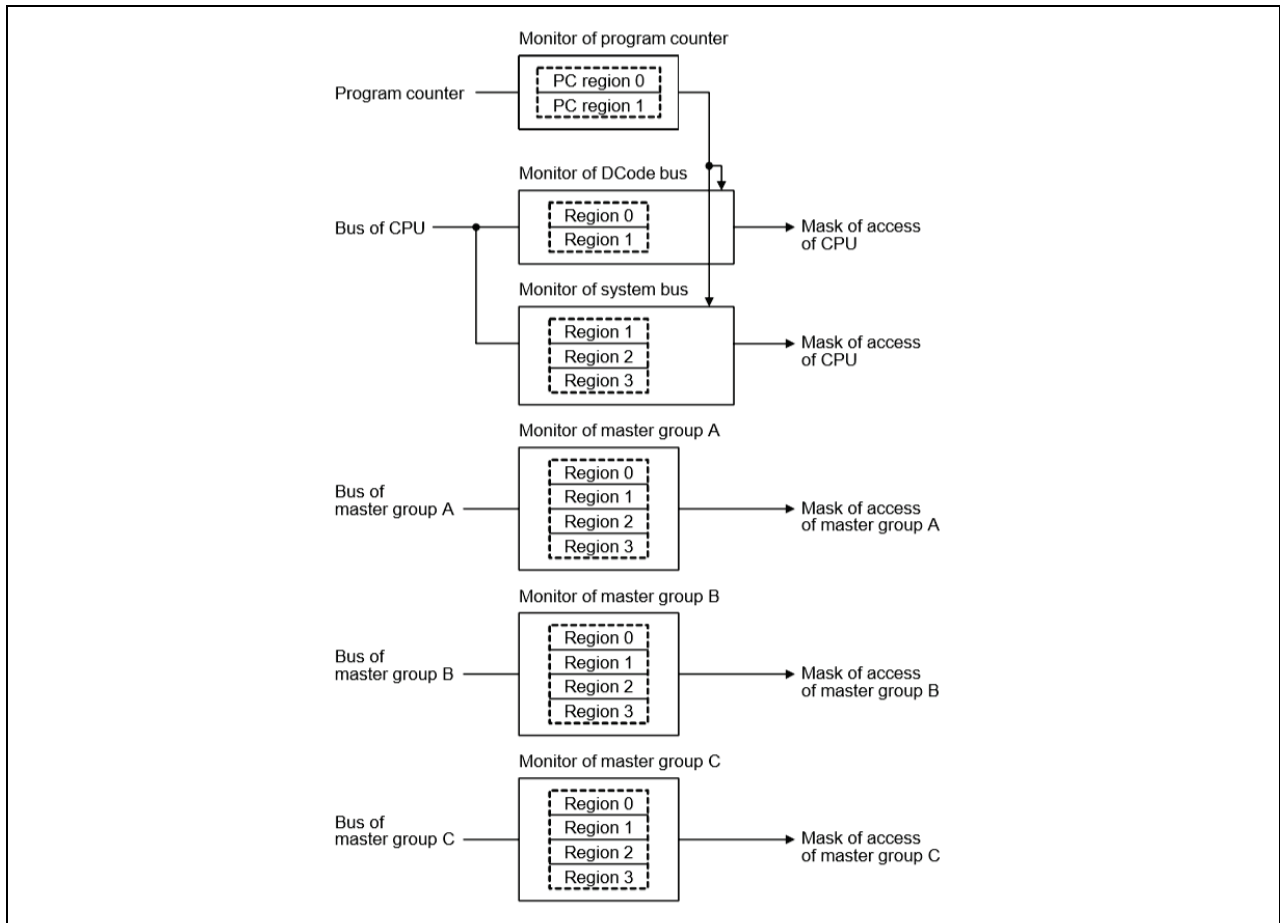

Figure 5. Data Protection for Security MPU Regions

The table in Figure 6 describes the details of CPU access and debugger access to the secure and non-secure regions.

- indicates that the bus master on the left is granted access to the region on the top
- indicates that the bus master on the left is not granted access to the region on the top

Note: The secure program located in the SRAM region other than the SRAMHS region cannot be fetched by a non-secure program as marked by the red box shown in Figure 6.

Configuration details of the Security MPU are described in section 3.2.

PC value	Master access	Slave region 0		Slave region 1				Slave region 2/3	
		FLASH		SRAMHS		Other than SRAMHS		E2P/Flash Cnt./TSIP	
		Sec	Non-sec	Sec	Non-sec	Sec	Non-sec	Sec	Non-sec
Secure	CPU (instruction)	✓	✓	✓	✓	✓	✓	-	-
Non-secure	CPU (instruction)	✓	✓	✓	✓		✓	-	-
Secure	CPU (operand)	✓	✓	✓	✓	✓	✓	✓	✓
Non-secure	CPU (operand)		✓		✓		✓		✓
Secure	Debugger		✓		✓		✓		✓
Non-secure	Debugger		✓		✓		✓		✓
[Don't Care]	DMAC/DTC and others		✓		✓		✓		✓

Figure 6. CPU and Debugger Access Summary

2.3 Flash Access Window (FAW)

The Flash Access Window (FAW) defines one contiguous flash region within the MCU flash space. Within this region, the flash erase and write operation is allowed from both secure and non-secure program. The access window is only valid in the program flash area. The access window provides protection in self-programming mode, serial programming mode, and on-chip debug mode.

The FAW region setting uses flash block boundaries as the start and end addresses of the flash access window. There is one bit (FSPR bit) in the FAW control register that, when cleared, disables any possible update to the flash access window setting for the lifetime of the device. The internal flash write-once protection uses this bit to implement the write-once protection.

Refer to section 3.3 for configuration details on the FAW.

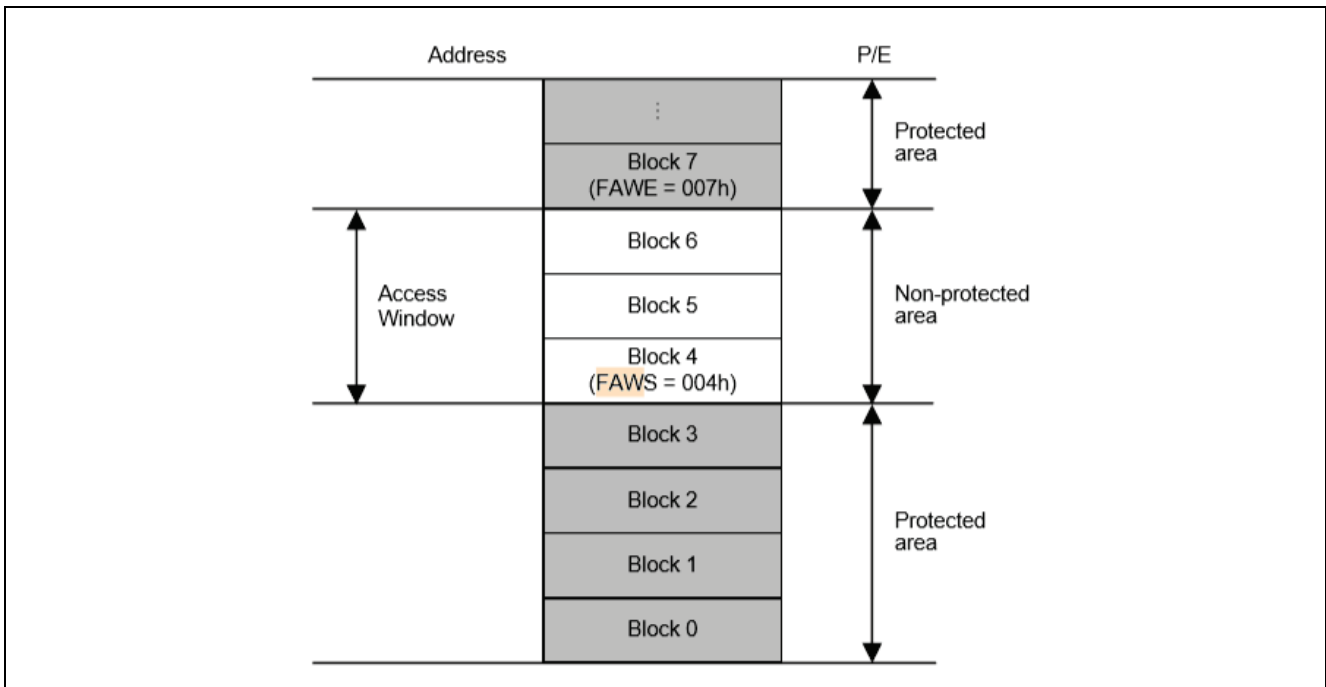
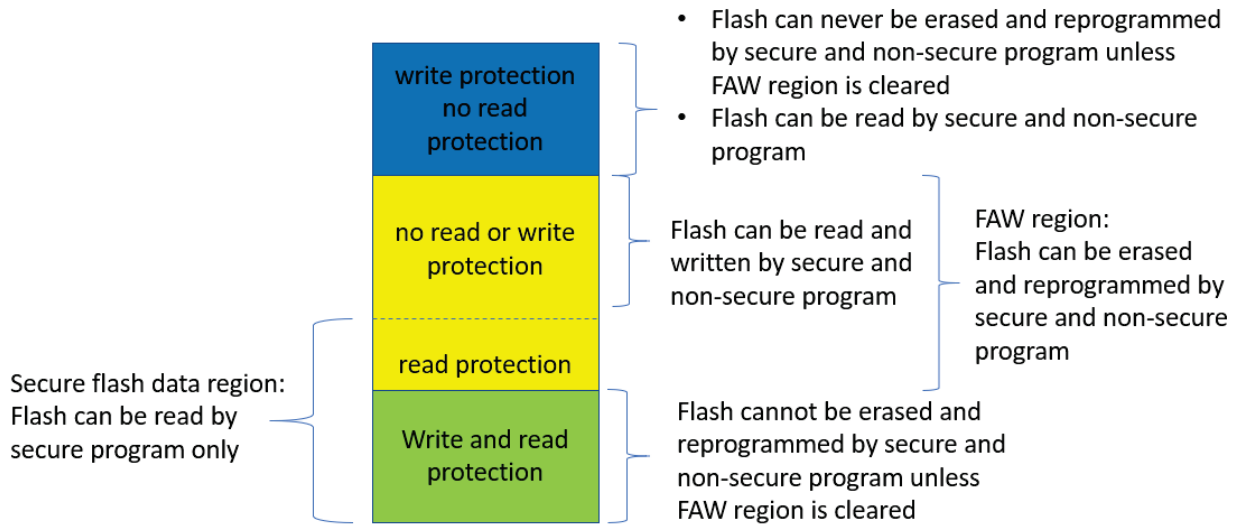

Figure 7. Flash Access Window

2.3.1 Using the Security MPU and FAW for Code Flash Write Protection

As explained in section 1.2.2, there are two ways to establish flash region write protection. In this application project, the FAW is used to establish flash write protection. Figure 8 summarizes the code flash read, erase and programming access control when the Security MPU is used in conjunction with the FAW, and the security function is not enabled.

Case A: Flash Erase/Program Security function not enabled. FAW enabled and but not locked down.



Case B: Flash Erase/Program Security function not enabled. FAW enabled and locked down.

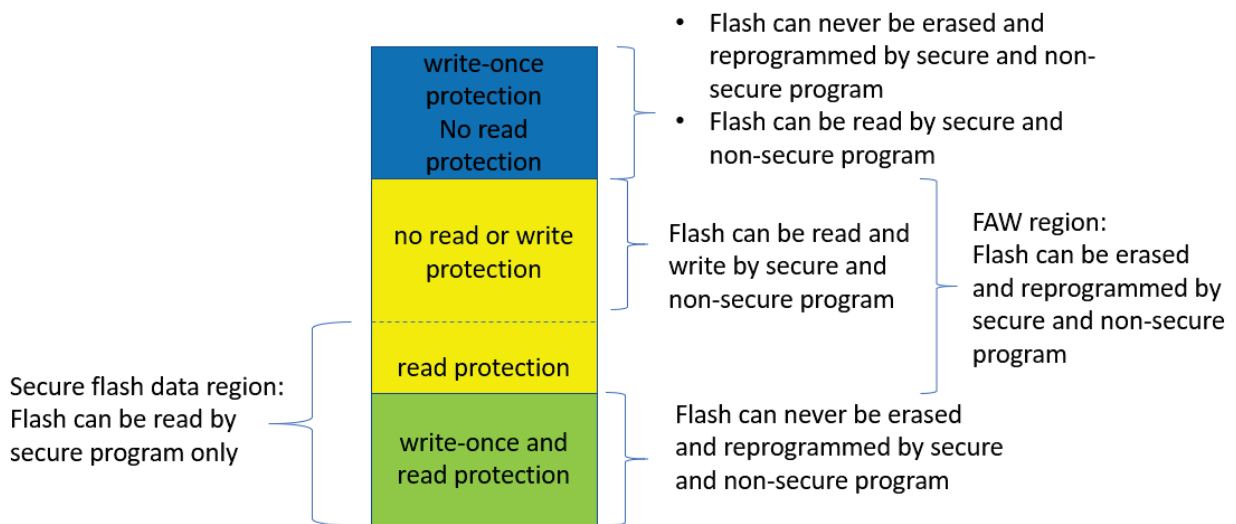

Case C: Flash Erase/Program Security function not enabled. No FAW region established.

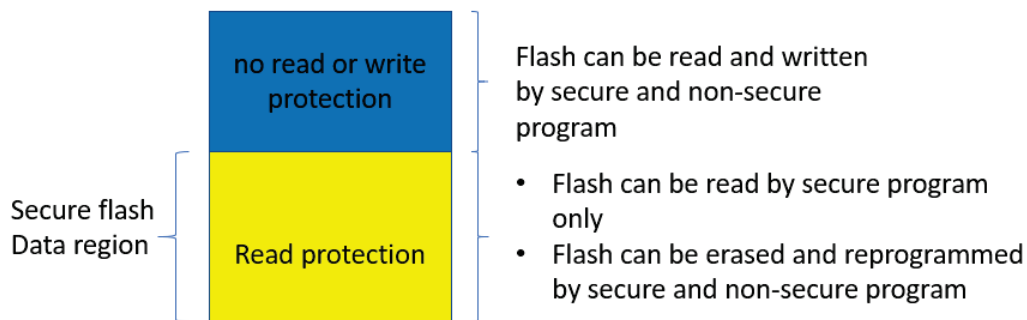

Figure 8. Code Flash Read, Erase, and Program Control when Security Function is not Enabled

2.4 Debugging Security Considerations

The RA MCUs provide OCD/serial programmer ID code protection with the OSIS register. The OSIS register stores the ID for ID code protection of the OCD/serial programmer. Once the OSIS register ID code is set for the MCU, the user must provide the matching ID code when connecting an OCD/serial programmer. If the ID code matches, debugging is allowed; otherwise, the debugging process is not allowed. Configuration of the OSIS ID code protection is described in section 3.5.

2.5 Notes on Arm MPU, Bus Master MPU, Bus Slave MPU

This section explains how the MPU, Bus Master MPU, and Bus Slave MPU relate to Data at Rest design. Refer to the Arm® Cortex technical user manual to understand the definition and settings of the Arm MPU. Refer to RA MCUs hardware user's manuals to understand the definition and settings of the Bus Master and Bus Slave MPUs.

While these three MPUs intend to catch inadvertent accesses to the regions defined by these MPUs, they do not provide protection of reading and updating the register settings from non-secure program. The register settings of these MPUs are not protected from reading by a debugger nor by non-secure programs. Secure and non-secure programs can follow correct procedures to update the registers.

In addition, the MPU regions defined by these three MPUs do not provide the same level of security compared to the protection provided by the Security MPU:

- A debugger can access the protected regions
- A read-protected region (without write protection) can be written by secure and non-secure code
- A write-protected region (without read protection) can be read by secure and non-secure code
- A read/write-protected region cannot be read nor written by either secure or non-secure code

2.6 Other Security Elements

2.6.1 Secure Crypto Engine (SCE)

The Secure Crypto Engine (SCE) hardware block on RA MCUs provides data encryption and authentication capability. Following are the encryption and authentication algorithms supported.

2.6.1.1 Security Algorithms

- Symmetric algorithms: AES
- Asymmetric algorithms: RSA and ECC
- MCU support status:
 - RA6M3, RA6M2, and RA6M1 MCU Groups support all the above symmetric and asymmetric algorithms
 - RA4M1, RA4W1, and RA2A1 support only symmetric algorithms

Configuration details of the SCE is outside the scope of this application project. Refer to the hardware user manual and FSP user manual for operational details.

2.6.1.2 Other Crypto Security Features

- TRNG (True Random Number Generator)
- Hash value generation: SHA1, SHA224, SHA256, GHASH
- 128-bit unique ID
- MCU support:
 - RA6M3, RA6M2, and RA6M1 support this entire group of features
 - RA4M1, RA4W1 supports AES, TRNG and GHASH
 - RA2A1 supports AES and TRNG.

3. Configuring the Security Elements

This section explains the detailed process to setup the Security MPU, FAW, and the OSIS ID register to provide the desired security level for Data at Rest security design. It also explains how to undo the security feature settings in the development stage. In addition, steps needed to lock the security features in the MCU are provided.

3.1 Overview of RA MCU Option-Setting Memory

The Security MPU and the FAW registers are in the MCU Option-Setting Memory, as shown below. The option-setting memory is in the flash user area. Setting these registers requires different procedures compared to erasing and programming the other part of the code and data flash area. Figure 9 is an example location of the option-setting memory based on RA6M3. Other MCUs can have the FAW register located at a different location. Refer to the hardware user’s manual for the exact location for the MCU involved.

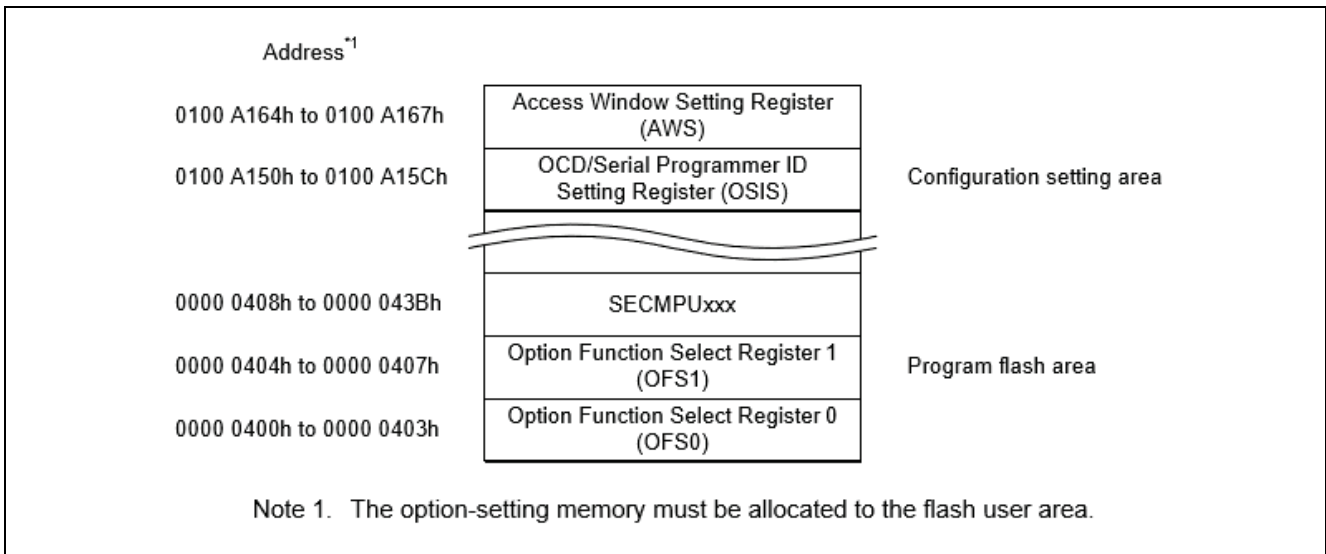

Figure 9. Option-setting Memory Area

As we can see from Figure 9, the Security MPU registers are allocated in the first sector of the program flash area. The FAW register and OSIS register settings are allocated in the configuration setting area.

With FSP 0.8 or lower, we recommend using the following methods to set up the Security MPU and FAW registers:

- Use the RA MCU configurator to define the Security MPU registers. Section 3.2.1 describes this method.
- Use the FSP flash driver API to configure the FAW register when locking the register settings is not required. Use the factory bootloader to lock the FAW register setting. Section 3.3 describes this method.

Other methods of setting the Security MPU and FAW registers include the following:

- Use a J-Link script.
- Use a serial port to communicate with the MCU’s factory bootloader and use the factory bootloader’s utilities (section 3.4 describes using this method to clear the locking bit, FSPR and hence permanently lock the FAW register setting).

3.2 Configuring the Security MPU

This section describes the steps needed to set up and reset the Security MPU registers.

3.2.1 Setting up the Security MPU Registers

Through the RA MCU configurator FSP **BSP** tab, users can define and enable the four secure data regions and the two secure program regions.

Property	Value
Board:	EK-RA6M3
Device:	R7FA6M3AH3CFC
RTOS:	No RTOS
MPU	
Enable or disable PC Region 0	Enabled
PC0 Start	0x00000500
PC0 End	0x0007FFFF
Enable or disable PC Region 1	Enabled
PC1 Start	0x1FFE0000
PC1 End	0x1FFFFFFF
Enable or disable Memory Region 0	Enabled
Memory Region 0 Start	0x00000400
Memory Region 0 End	0x000DFFFF
Enable or disable Memory Region 1	Enabled
Memory Region 1 Start	0x1FFE0000
Memory Region 1 End	0x2002FFFF
Enable or disable Memory Region 2	Disabled
Memory Region 2 Start	0x407FFFC
Memory Region 2 End	0x407FFFFF
Enable or disable Memory Region 3	Disabled
Memory Region 3 Start	0x400DFFFC
Memory Region 3 End	0x400DFFFF

Figure 10. Security MPU Configuration

The following list describes all the regions defined by the above property fields (in bold).

- Secure flash program
 - **PC0 Start** and **PC0 End**: program counter region for the secure flash program
 - **Enable or disable PC Region 0**: enable or disable the secure flash program
- Secure SRAM program
 - **PC1 Start** and **PC1 End**: program counter region for the secure SRAM program
 - **Enable or disable PC Region 1**: enable or disable the secure SRAM program
- Secure flash data region
 - **Memory Region 0 Start** and **Memory Region 0 End**: secure flash data region start and end addresses
 - **Enable or disable Memory Region 0**: enable or disable the secure flash data region
- Secure SRAM data region
 - **Memory Region 1 Start** and **Memory Region 1 End**: secure SRAM data region start and end addresses
 - **Enable or disable Memory Region 1**: enable or disable the secure SRAM data region
- Security Function Region 1
 - **Memory Region 2 Start** and **Memory Region 2 End**: security function 1 start and end addresses (must be the address space for internal peripheral bus 7 or 9, see description that follows)
 - **Enable or disable Memory Region 2**: enable or disable the security function 1
- Security Function Region 2
 - **Memory Region 3 Start** and **Memory Region 3 End**: security function 2 start and end addresses (must be the address space for internal peripheral bus 7 or 9, see description that follows)
 - **Enable or disable Memory Region 3**: enable or disable security function 2

See section 4.1 for the operational flow of using the Security MPU in an application project.

3.2.2 Locating Secure Code/Data to a Specific Memory Region

In addition to setting up the Security MPU registers, one must allocate the secure code and secure data to the intended memory region. This is achieved by customizing the linker script. When you have regions of secure and non-secure program, the default linker is not sufficient. When designing with the Security MPU, you must define multiple flash and/or SRAM regions in the linker script.

Refer to section 5.1.2 for an example of locating secure code/data to a specific memory region.

3.2.3 Resetting the Security MPU registers

Resetting the Security MPU registers is possible if the Security MPU registers are located in the FAW region, or if they are located outside the FAW region, but the FAW region is not permanently locked down.

Resetting the Security MPU requires a flash erase operation for the first block of the MCU flash. Below are the steps to reset the Security MPU setting with a RA MCU e2 studio project:

1. Create an SRAM project to execute from an SRAM region other than SRAMHS.
2. Open the flash HAL driver.
3. If the Security MPU flash region is not part of the FAW region, clear the FAW register setting first. See section 3.3.2 to understand how to clear the FAW region.
4. Erase the first flash block using the flash HAL driver.
5. Close the flash HAL driver.

Reference the example e² studio project `secure_data_at_rest_ek_ra6m3` described in section 5.2 for the implementation of these steps.

3.3 Configuring the FAW

This section describes the steps to set up and clear the FAW regions, and to permanently lock the FAW setting.

3.3.1 Setting up the FAW Region

Call the following FSP FAW API to set up the FAW:

```
err = R_FLASH_HP_AccessWindowSet(&g_flash0_ctrl, FAW_START, FAW_END);
```

where,

- `g_flash0_ctrl` is the instance of this flash HAL driver.
- `FAW_START` is the start address of the FAW window.
- `FAW_END` is the address of the next block acceptable for programming and erasure defined by the access window.

Note: If the FAW is permanently locked prior to running this API, the FAW region cannot be updated using this API.

3.3.2 Clearing the FAW Regions

Call the following FSP FAW API to clear the FAW setting:

```
err = R_FLASH_HP_AccessWindowClear(g_flash0.p_ctrl);
```

The `R_FLASH_HP_AccessWindowClear` API clears the FAW window setting, essentially disabling the FAW control by setting the start address and end address to 0. This routine will work only if the FAW is not permanently locked.

Follow the steps below to clear the FAW setting in the development stage (prior to clear FSPR) in a RA MCU e² studio project:

1. Create an SRAM project to execute from an SRAM region other than SRAMHS.
2. Open the flash HAL driver.
3. Clear the FAW setting using `R_FLASH_HP_AccessWindowClear`.
4. Close the flash HAL drive.

3.4 Permanent Locking of the FAW Region

Permanently locking the FAW region prevents a user from updating the FAW region. This step is needed to establish the write-once flash region.

There are two use cases when a user may want to consider permanently locking the FAW region:

1. To lock critical runtime data in real time when the device is deployed to the field (the use case without secure bootloader).
2. To lock critical data/code during the manufacturing stage (the use case with secure bootloader).

FSP 0.8 or earlier does not support the first use case.

For manufacturing usage, to permanently lock the FAW register, we can use the factory bootloader routines, which implement the FAW register setting and clearing procedure. This application project provides an example PC application `final_program_installer` to program the application and permanently lock the FAW.

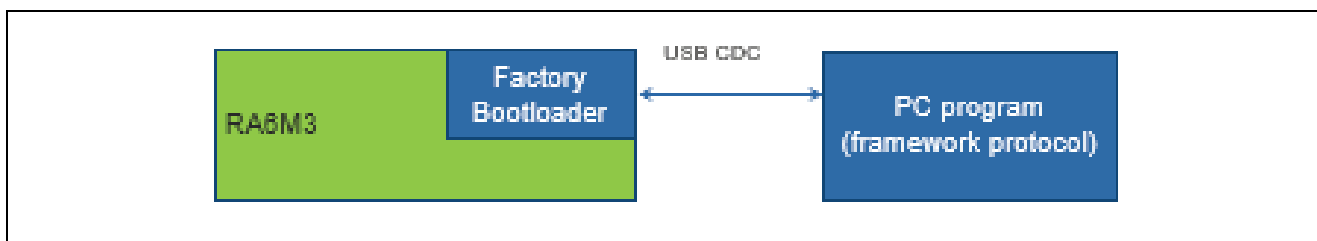

Figure 11. Permanently Locking the FAW

3.5 Setting up the Security Control for Debugging

The OCD/Serial Programming ID Setting Register (OSIS) stores the ID code protection for the OCD/serial programmer. Upon connection, an OCD/serial programmer must provide an ID value so that the MCU can determine whether to permit the connection.

- OSIS
 - 128-bit register holds the ID for authenticating the debugger/programmer.
 - SCI/USB boot mode programming also uses this ID code.

The following table is from the RA2E1 Hardware User's Manual, which is applicable to all the MCU Groups mentioned in the Table 1. Note that not all relevant Hardware User's Manual has been updated to this table yet, that will be taken care of in future releases.

Table 37.13 Specifications for ID code protection

Operating mode on boot up	ID code	State of protection	Operations on connection with the programmer or on-chip debugger
Serial programming mode (SCI boot mode) On-chip debug mode (SWD boot mode)	0xFF, ..., 0xFF (all bytes 0xFF)	Protection disabled	The ID code is not checked, the ID code always matches, and the connection to the serial programmer or on-chip debugger is permitted.
	Bit [127] = 1, bit [126] = 1, and at least one of all 16 bytes is not 0xFF	Protection enabled	Matching ID code indicates that authentication is complete and connection to the serial programmer or the on-chip debugger is permitted. Mismatching ID code indicates transition to the ID code protection wait state. When the ID code sent from the serial programmer or the on-chip debugger is ALeRASE in ASCII code (0x414C_6552_4153_45FF_FFFF_FFFF_FFF_FFFF), the content of the user flash area is erased and all bits in the OSIS register are 1. However, when the AWS.FSPR bit is 0 or security MPU is enabled, the content of the user flash area is not erased.
	Bit [127] = 1 and bit [126] = 0	Protection enabled	Matching ID code indicates that authentication is complete and connection to the serial programmer or the on-chip debugger is permitted. Mismatching ID code indicates transition to the ID code protection wait state.
	Bit [127] = 0	Protection enabled	The ID code is not checked, the ID code is always mismatching, the connection to the serial programmer or the on-chip debugger is prohibited. When the ID code sent from the on-chip debugger is ALeRASE in ASCII code (0x414C_6552_4153_45FF_FFFF_FFFF_FFF_FFFF), the content of the user flash area is erased and all bits in the OSIS register are 1. However, when the AWS.FSPR bit is 0 or security MPU is enabled, the content of the user flash area is not erased.

Figure 12. Specifications for ID Code Protection

There are multiple ways the user can set up the OSIS ID code:

- Use the RA MCU Configurator with the support of the J-Link debugger
- Use Renesas Flash Programming Tool (RFP)
 - See the Reference section for the RFP download link.
- Use a J-Link script
- Use the factory bootloader
- Use the flash HAL driver to program the OSIS ID

3.5.1 Methods of Setting the OSIS ID Code

3.5.1.1 Using the RA MCU Configurator and J-Link Debugger

The RA MCU configurator allows the user to set up the OSIS ID code through the FSP property setting shown in Figure 13.

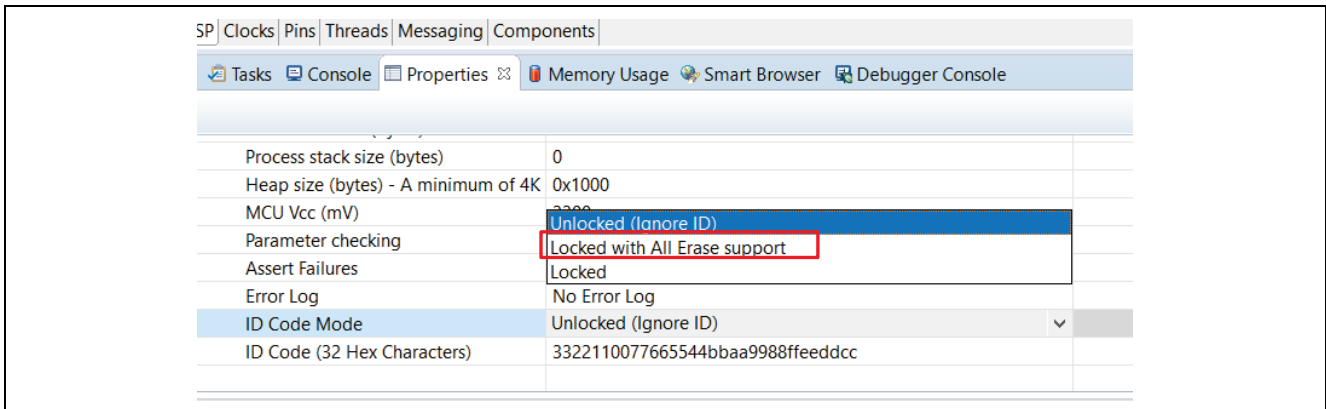

Figure 13. Setting up OSIS ID using RA MCU Configurator

- During development stage, it is recommended to choose “Locked with All Erase support” for the **ID Code Mode** selection. Section 5.5 provides an example a J-Link script which erases the entire flash to reset the ID code setting to all FFs.
- When “Locked” is selected for the ID Code Mode, the device will be disabled from debugging and factory programming.

3.5.1.2 Using a J-Link Script

The J-Link script `SEGGER` can setup the OSIS ID. This application project does not provide an example script for this usage.

3.5.1.3 Using the Factory Bootloader

The factory bootloader has capability of setting up the OSIS ID. This application project does not provide an example for this functionality.

3.5.1.4 Using the Flash Driver

FSP has the capability of setting up the OSIS ID using the flash driver.

```
err = R_FLASH_HP_IdCodeSet(&g_flash0_ctrl, id_bytes, FLASH_ID_CODE_MODE );
```

- `g_flash0_ctrl` is the instance of this flash HAL driver.
- `id_bytes` is the ID code to set.
- `FLASH_ID_CODE_MODE` has three options:
 - `FLASH_ID_CODE_MODE_UNLOCKED`: ID code is ignored;
 - `FLASH_ID_CODE_MODE_LOCKED_WITH_ALL_ERASE_SUPPORT`: ID code is checked. All erase is available;
 - `FLASH_ID_CODE_MODE_LOCKED`: ID code is checked.

This application project does not provide an example using this API.

3.5.2 Method of Setting up the OSIS ID Code for Debugging

With e² studio, a user can set up the ID code using this interface.

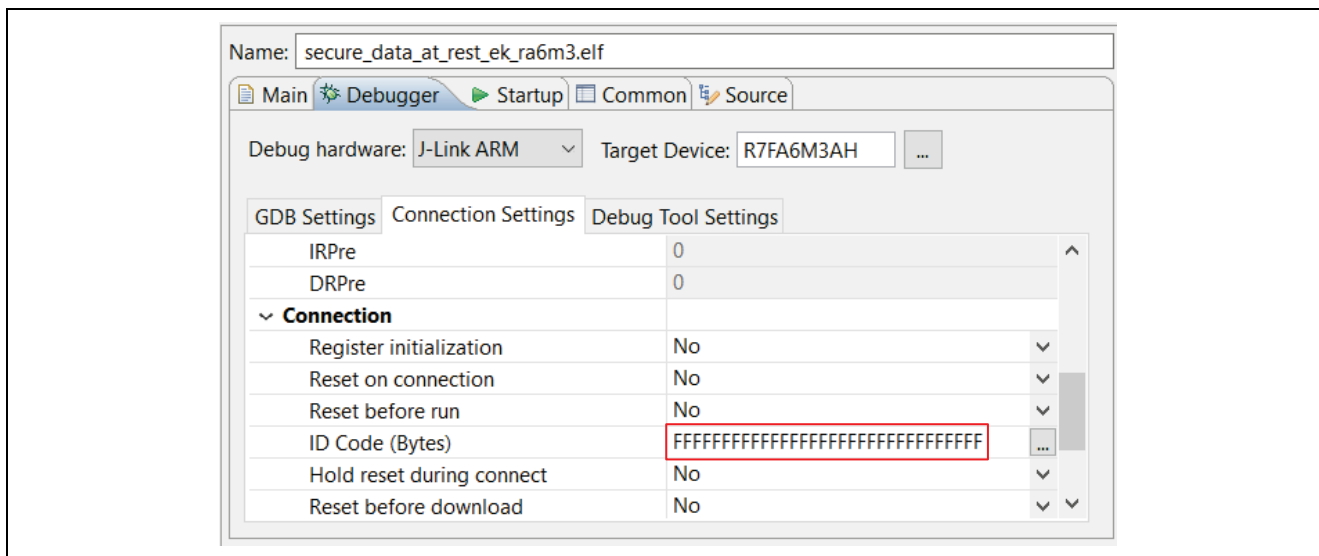

Figure 14. Setting up the ID Code with e² studio

3.5.3 Method of Resetting the OSIS ID code

Following are the methods of resetting the OSIS ID code.

3.5.3.1 Using J-Link Script

This application project includes an example J-Link script to reset the OSIS ID code by erasing the entire flash. Refer to section 5.5 for details on the operation.

3.5.3.2 Using Factory Bootloader

User can use the RFP routine to reset the OSIS ID.

3.5.3.3 Self-programming

Supported by FSP Flash driver.

4. Operational Flow using Security MPU and FAW

This section describes the operational flow for designing a secure application using the RA MCU Security MPU and FAW.

4.1 Internal Flash and SRAM Read Protection

When the Security MPU enables the secure flash data and secure SRAM data regions, these regions gain read protection:

- Secure SRAM regions are read and write protected from non-secure flash and SRAM programs
- Secure flash regions are read protected from non-secure flash and non-secure SRAM programs
- The bus master and debuggers are disabled from access to the secure region

The high-level operational flow of establishing the Security MPU regions is described by the flow diagram in Figure 14. See Figure 8 for examples of internal flash read protection.

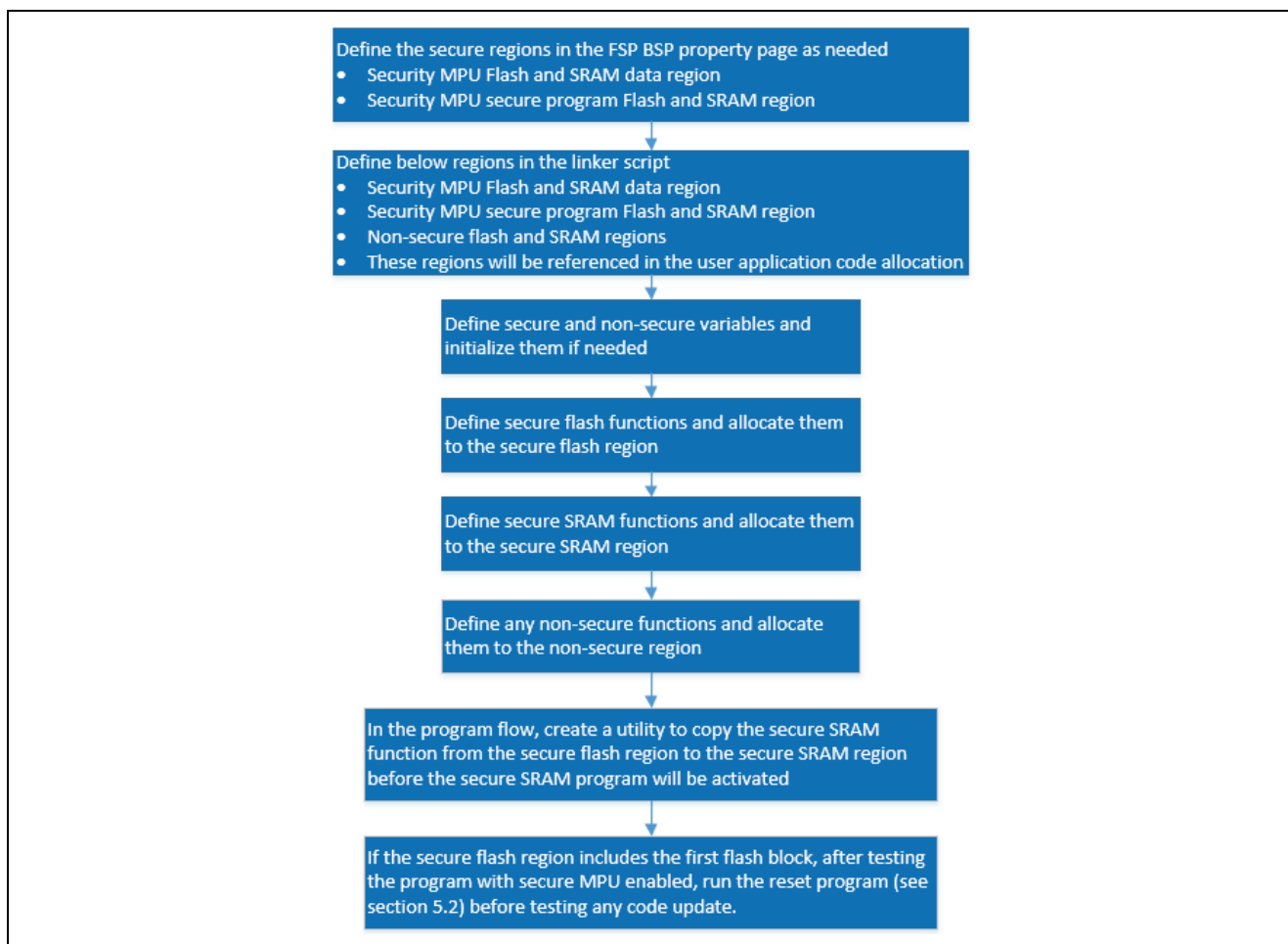

Figure 15. Operational Flow for Using the Security MPU

The following is a summary of setting up the Security MPU for the MCU:

- Use the configurator BSP tab to define secure regions
- Use the linker script to define the secure regions and non-secure regions
- Establish the secure and non-secure functions
- Copy the secure SRAM function (if defined) from the secure flash region to the secure SRAM region
- Test the system.

Note: Once the Security MPU is enabled, the MCU needs to run the reset routine (refer to section 5.2) whenever a new program needs to be programmed on the device.

4.2 Internal Flash Write Protection

As described in section 4.1, the internal SRAM region gains write protection when the Security MPU is enabled for the secure SRAM region. The internal flash region can gain write protection through two methods:

- Set up the FAW region such that it does not include the secure flash region. The entire region (whether it is part of the secure flash region or non-secure flash region) that is not included in the FAW region will have erase and write protection from **secure and non-secure program**. See Figure 8 for an example of internal flash write protection.
- When the Security Function for internal peripheral bus 9 is enabled, the entire flash region, including secure and non-secure flash regions, is protected from erasing and programming by **non-secure flash and non-secure SRAM program**.

In this application project, only the first method is described. See section 5.1 for an example of the implementation.

4.2.1 Operational Flow

The FSP API, `R_FLASH_HP_AccessWindowSet` (see section 3.3.1) must be called from the user application to set up the erase and write enabled region. The rest of the flash region will be disabled for erase and write from both secure and non-secure programs.

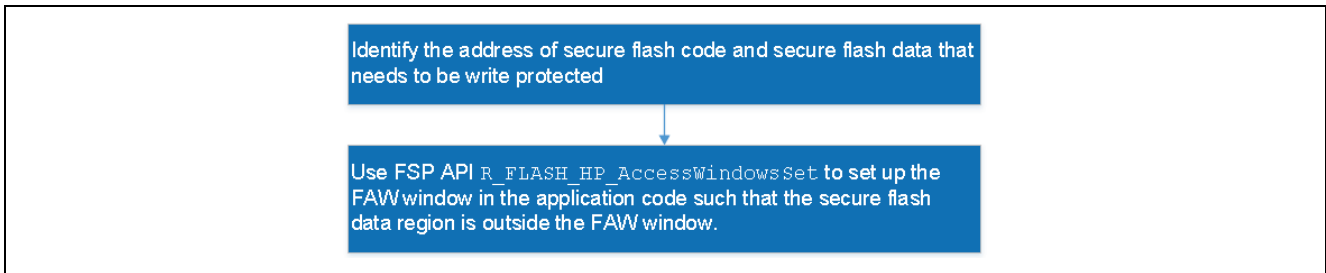

Figure 16. Establish Write Protected Internal Flash Region

4.3 Internal Flash and SRAM Read/Write Protection

When the Security MPU is enabled for the secure SRAM region, the secure SRAM gains read/write protection from non-secure flash and non-secure SRAM programs.

If the write-protected flash region is part of the secure flash region, this secure flash region is read and write protected from non-secure program and write protected from secure program. See Figure 8 for an example of internal flash read and write protection.

4.3.1 Operational Flow

When the internal SRAM region gains read protection by setting up the secure SRAM region, it also gains write protection by the same process. Refer to section 4.1 for details on the operational flow.

If the write protected internal flash region is set up through the FAW, and it is also part of the secure flash data region, this section of the secure flash region is erased and write protected from the secure and non-secure programs. The entire secure flash region is read protected from the non-secure program.

Refer to section 5.1 for an example of the implementation of internal SRAM and flash read and write protection.

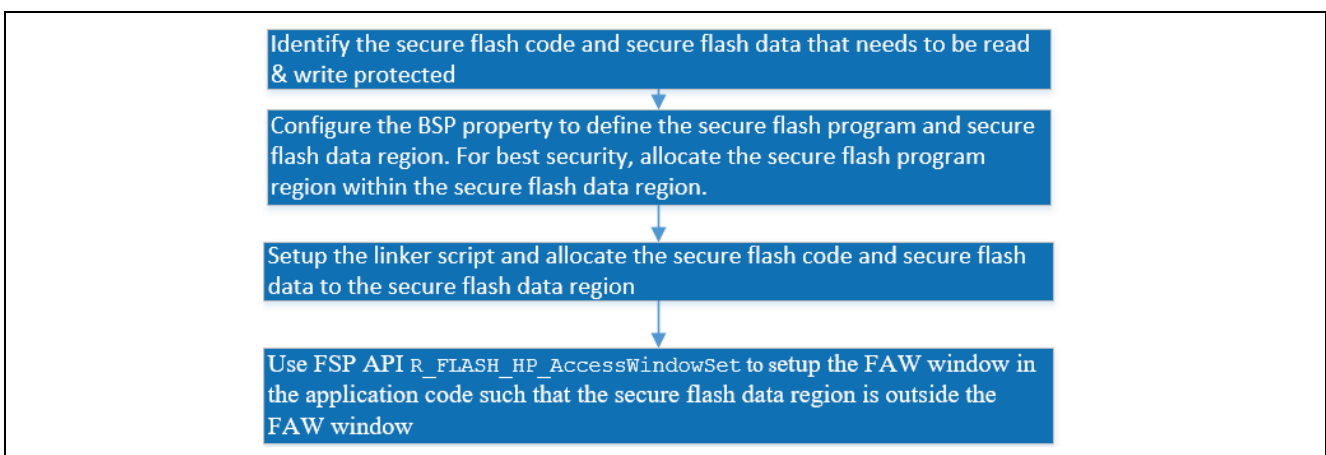

Figure 17. Establish Read/write Protected Internal Flash Region

4.4 Internal Flash Write-Once Protection

When the FSPR bit is cleared in the FAW register, the internal flash region which is not included in the FAW window becomes write-once protected from the secure and non-secure programs. The content within this write-once protected region cannot be altered for the lifetime of the device. See Figure 8 for an example of the internal flash write-once protection.

4.4.1 Operational Flow

Before performing the write-once protection:

- Fully test the critical data and/or code which the application intends to lock down
- Ensure that no other critical data and/or code need to be assigned to the write-once protected region

Figure 17 is the operational flow when operating in a manufacturing stage. Refer to section 5.3 for an implementation of the write-once protection.

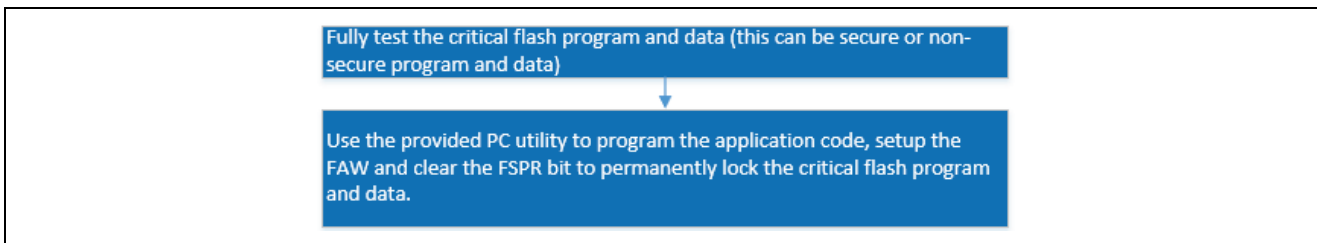

Figure 18. Write-once Protection

As explained in section 3.4, runtime write-once protection by locking the FAW register is not supported by FSP 0.8 or earlier.

4.5 Internal Flash Write-Once and Read Protection

The write-once and read protection can be achieved for secure flash program and data. When a secure flash region gains read/write protection by setting up the Security MPU and FAW region, a user can permanently lock the FAW window such that the corresponding region can never be erased and programmed by any tools, and it is read protected from non-secure software. Erasing and programming this flash region is not possible via the factory boot loader, J-Link script, or self-programming.

Region 8 in Figure 8 is an example of write-once and read protected internal flash region.

4.5.1 Operational Flow

For internal secure flash applications, a user can follow these operational steps to set up regions that are write-once from secure and non-secure program and read protected from non-secure program.

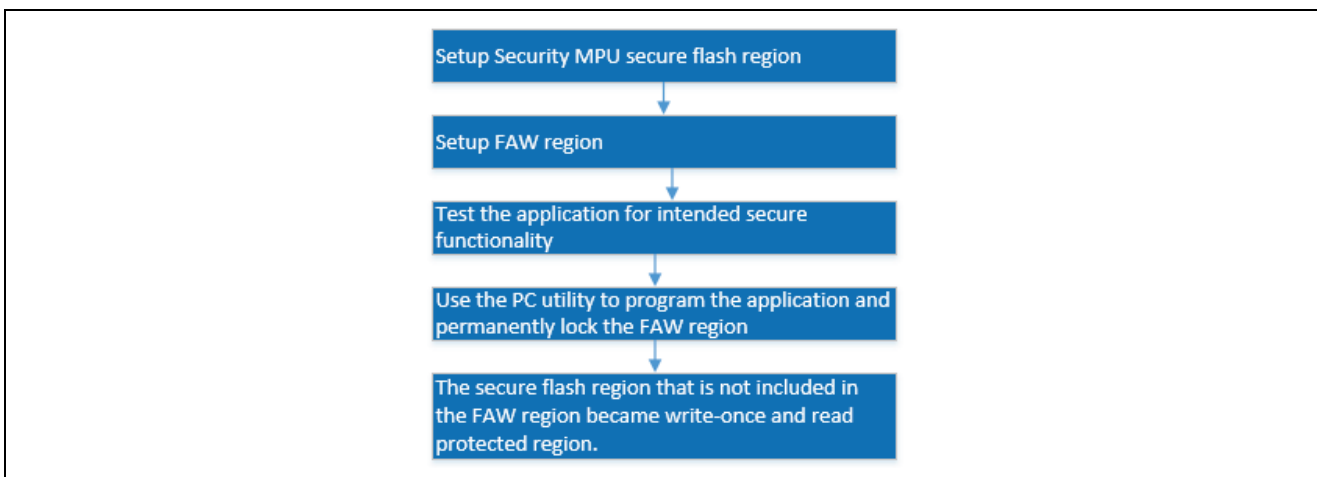

Figure 19. Write-once and Read Protection

Refer to section 5.3 for an example implementation of locking down the FAW region.

4.6 Operation Notes

4.6.1 Memory Allocation

4.6.1.1 Space between Secure and Non-secure Instructions

An address space of greater than 12 bytes is required between the last instruction of a non-secure program and the first instruction of a secure program. If a secure program is stored the area following the non-secure program without the gap, the secure program might be fetched as non-secure program. See hardware user manual for details.

4.6.1.2 Do Not Assign the Memory Mirror Region to the Secure Region

Setting of the memory mirror space (for example, 0200 0000h to 027F FFFFh for RA6M3) for secure region is prohibited.

4.6.1.3 Startup Area of Security MPU Regions

The start address area of the secure flash data region cannot be set at the vector table area.

The start address of the secure SRAM data region cannot be set at the stack area or the vector table area.

4.6.2 Limitations on Programming the Option-Setting Memory

Refer to the hardware user manual section “Changing the option-setting memory by self-programming” and “Debugging through an OCD or programming by a flash writer” to understand the limitations on programming the Option-Setting Memory for flash access window setup and OSIS ID setup.

The application code included in this application project follows the guidelines provided in the user manual.

4.6.3 Factory Bootloader Accessibility

If the Security MPU is enabled, the factory bootloader is not available anymore. Reset of the Security MPU register settings is needed to re-enable the factory bootloader. Refer to section 5.2 for a Security MPU reset example implementation.

4.6.4 Access Secure Function from Non-Secure Functions

Secure functions can be called from non-secure functions (see Figure 6 in 2.2).

The application project implemented in this release calls the secure function directly from the non-secure function.

Special considerations are needed when accessing secure functions located in a secure bootloader:

- Define a group of secure function entry points (function pointers) in the secure flash data region
- Access the secure function from a function pointer stored in the secure function table

4.6.5 Debugger Access to the Security MPU Regions

When the debugger is operating in debug mode, viewing of the Security MPU flash and secure SRAM region contents are disabled. With e² studio, when the secure region is viewed from the ‘memory’ view, the values are shown as “0”.

5. Security Application e² studio Projects: Internal Flash and SRAM

This section introduces the example projects for using the Security MPU and FAW as follows:

- Access secure flash and secure SRAM data from secure flash and secure SRAM code
- Access secure flash and secure SRAM data from non-secure flash

There are three example projects included for the internal flash and SRAM secure Data at Rest application:

- **Project 1:** e² studio RA MCU project (`\embedded\secure_data_at_rest_ek_ra6m3`) that demonstrates the following:
 - Secure flash data read protection
 - Secure and non-secure flash data write protection
 - Secure SRAM read and write protection
- **Project 2:** e² studio RA MCU project (`\embedded\reset_flash_ek_ra6m3`) that demonstrates the following:
 - Reset of the Security MPU
 - Reset of the FAW region

- **Project 3:** PC-based Visual Studio application (`programInstaller.sln`) that downloads the application created from project 1 and provides the option to permanently lock the FAW via the factory bootloader on the MCU, thus realizing the write-once protection of the regions not included in the FAW.

In addition, there are several example J-Link scripts included in this application project, which performs the Security MPU, FAW, and OSIS ID code resetting.

Section 5.4 explains a J-Link script that resets the FAW and Security MPU registers before the FAW region is permanently locked down.

Section 5.5 explains the procedures for setting up the OSIS ID with an e² studio auto generated blinky project and the usage of the J-Link scripts to reset the OSIS ID. The reset OSIS ID script is used in conjunction with the blinky project to demonstrate an end-to-end development for debugging security handling with the RA MCUs using FSP 0.8.

5.1 Project 1: e² studio project - Internal Flash and SRAM Read Write Protection

5.1.1 Software Architecture Overview

Project 1: This project implements four groups of the software components that demonstrate the flash and SRAM read and write protection.

- J-Link RTT Viewer User Interface code
- Secure flash code
- Secure SRAM code
- Non-secure flash code

The J-Link RTT user code runs in the non-secure flash region. It monitors user input from the J-Link RTT Viewer and activates the corresponding secure flash/SRAM and non-secure flash application code. See Figure 19.

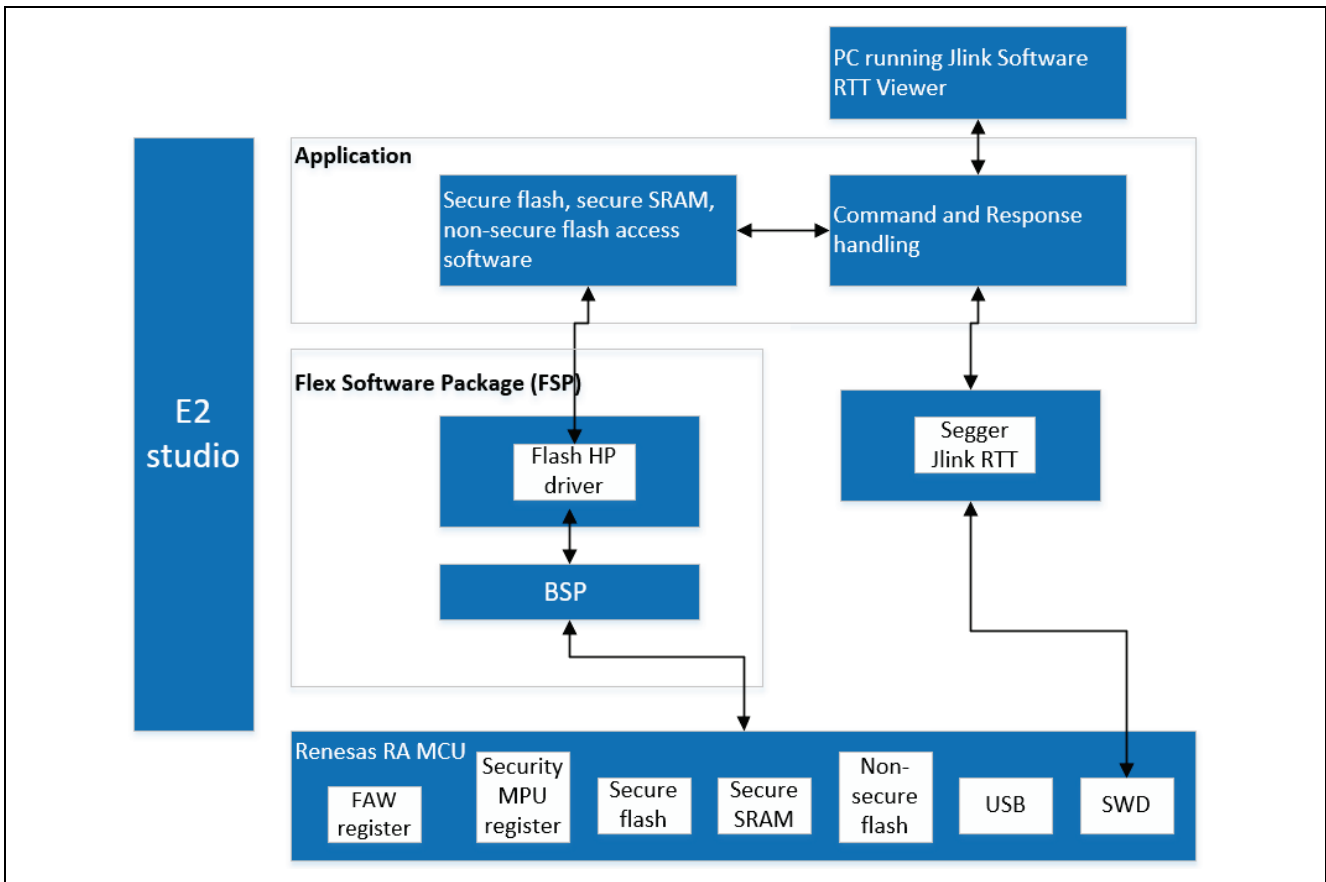

Figure 20. Project 1 Software Block Diagram

5.1.2 Memory Allocation Arrangement

The SRAM and Flash memory regions of the system is controlled by the linker script `\secure_data_at_rest_ek_ra6m3\script\fsp_app.ld`.

The Security MPU regions are defined by the configuration settings under the BSP tab in the RA Smart Configurator as shown Figure 10. Security MPU Configuration.

The FAW region is defined by below two macros `\src\ DAR_utilities.h`.

- `#define FAW_START (0x100000)`
- `#define FAW_END (0x1FFFFFF)`

It is important to note that the RTT Viewer message output included in this application project is based on the default project settings for the SRAM, Flash memory regions, Security MPU regions and default FAW setting as shown below. If these configurations are changed, different outputs are expected. These are not covered in the provided screen shots as the result varies based on the configurations.

The software uses macros defined in `secure_definitions.h` to allocate the different secure and non-secure code.

Figure 21 shows the flash memory allocation based on the flash software components.

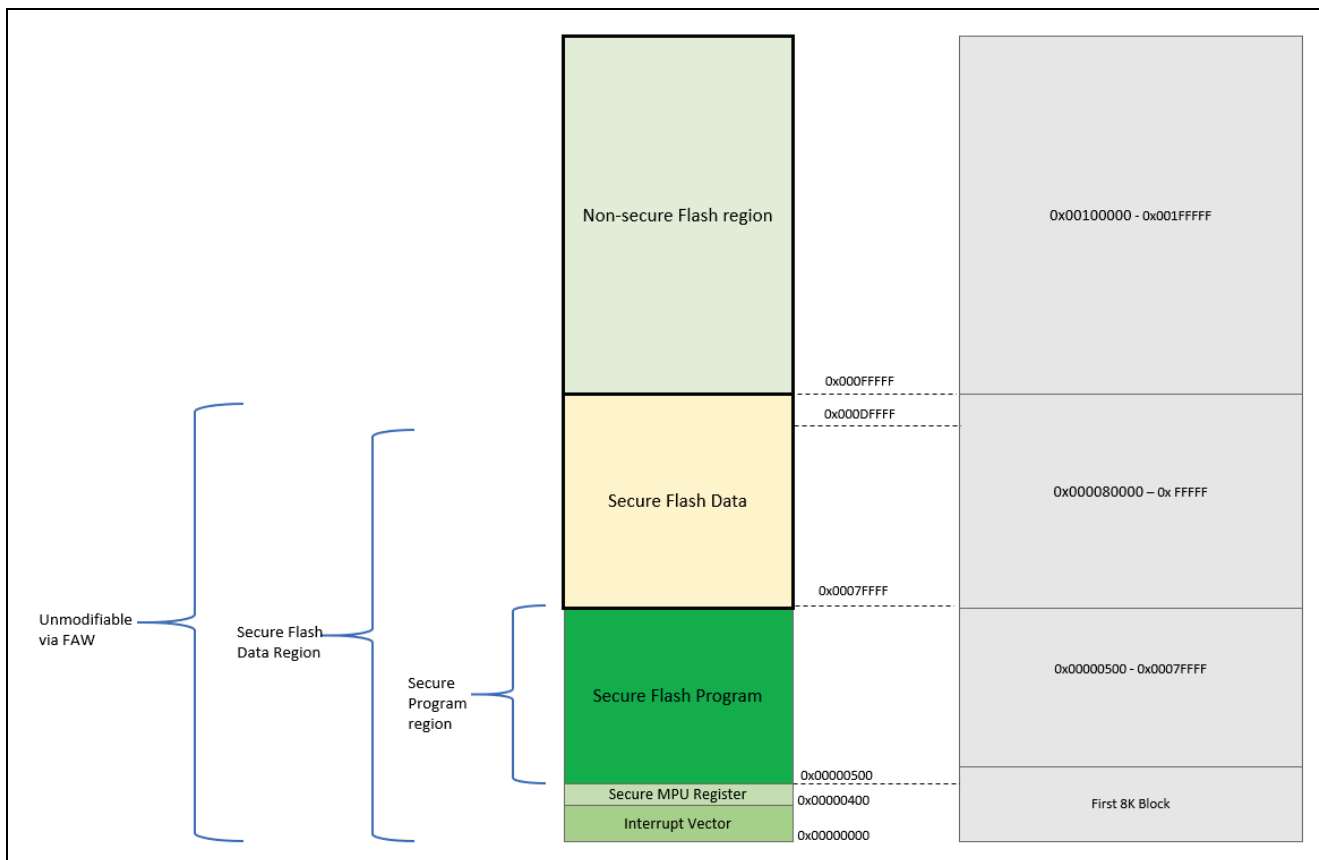

Figure 21. Project 1 Internal Flash

In this example project, the FAW window does not include any Secure MPU defined secure flash region. By setting up the FAW window like this, the Security MPU Registers as well as the secure flash data region are protected from modification from both secure and non-secure code.

If user wishes to have a portion of the secure flash data region inside the FAW window, they can update the `FAW_START` macro definition to adjust the FAW window location.

Note that it is always recommended to exclude the Secure MPU Register settings outside the FAW window, so the Security MPU settings can be protected from modification and thus enhance the security of the system.

Figure 22 shows the SRAM memory allocation based on the different SRAM software components.

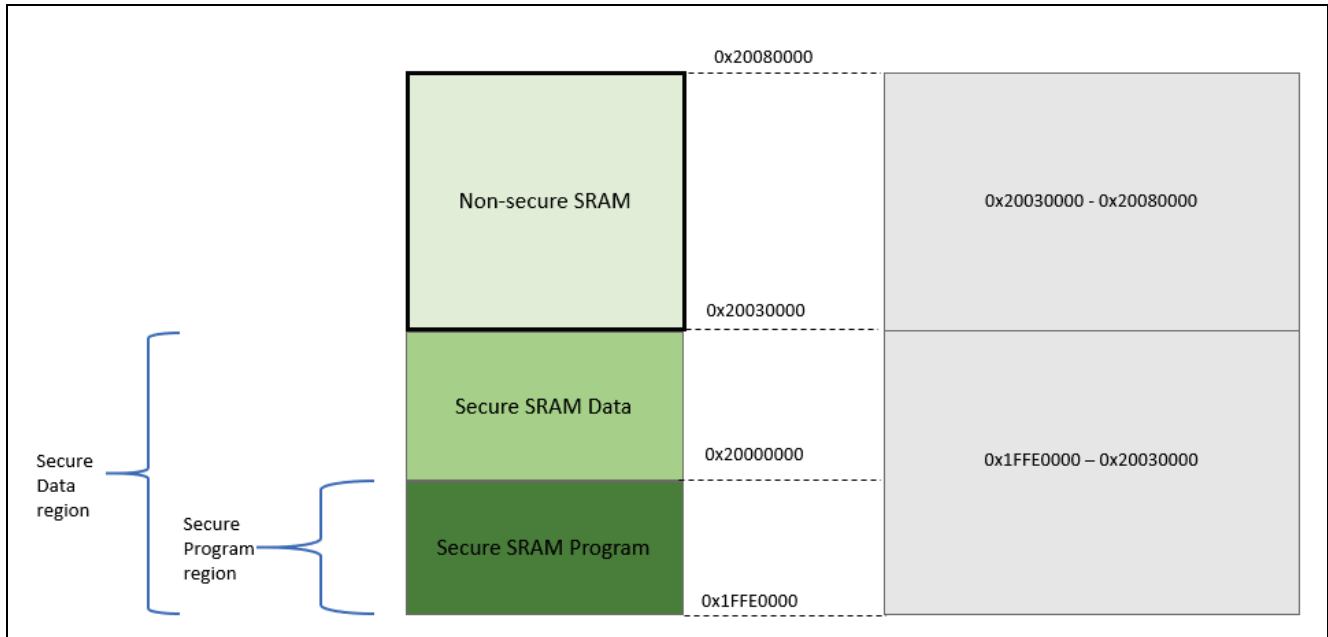

Figure 22. Project 1 Internal SRAM

Following are the memory regions defined by the linker script (\script\fsp_app.ld):

```
/* Linker script to configure memory regions. */
MEMORY
{
    VECTOR_TABLE (rx)      : ORIGIN = 0x00000000, LENGTH = 0x00000400 /*1024 bytes */
    SECURE_PROGRAM (rx)    : ORIGIN = 0x00000400, LENGTH = 0x0007FC00 /* 512K - 1024 bytes */
    SECURE_DATA (rw)      : ORIGIN = 0x00080000, LENGTH = 0x00080000 /* 512K bytes */
    FLASH (rx)           : ORIGIN = 0x00100000, LENGTH = 0x00100000 /* 1MB */
    SECURE_RAM_PROGRAM (rwx) : ORIGIN = 0x1FFE0000, LENGTH = 0x00010000 /* 64K */
    SECURE_RAM (rw)       : ORIGIN = 0x1FFF0000, LENGTH = 0x00040000 /* 256K */
    RAM (rwx)             : ORIGIN = 0x20030000, LENGTH = 0x00050000 /* 320K */
    DATA_FLASH (rx)     : ORIGIN = 0x40100000, LENGTH = 0x00008000 /* 32K */
    QSPI_FLASH (rx)      : ORIGIN = 0x60000000, LENGTH = 0x04000000 /* 64M */
    SDRAM (rwx)          : ORIGIN = 0x90000000, LENGTH = 0x02000000 /* 32M */
}

```

Following are the memory assignment macros used by the secure software and data sections defined by secure_definitions.h:

```
#define SECURE_PROGRAM __attribute__((section (".secure_text")))
#define SECURE_CONST __attribute__((section (".secure_rodata")))
#define SECURE_DATA __attribute__((section (".secure_data")))
#define SECURE_BSS __attribute__((section (".secure_bss")))
#define SECURE_SRAM_PROGRAM __attribute__((section (".secure_sram_program")))

```

Following are the test variables that are used to demonstrate the protection on secure flash data and secure SRAM data.

Global variables are used to allow read and write directly from non-secure program to simulate reading and writing to the secure data area.

Table 2. Test Variables

Data Type	Global Variable Name	Comment for data type	Comment on functionality
Secure flash data example	s_dataConst	Constant	No access function is provided. Access to this variable from non-secure program is not valid.
Secure initialized SRAM data example	s_dataInit	Initialized	No access function is provided. Access to this variable from non-secure program is not valid.
Secure uninitialized SRAM data example	s_dataWritten	Uninitialized	Write to this variable from non-secure flash program and show the write is not valid.

5.1.3 Functionality Description

5.1.3.1 J-Link RTT Viewer user interface

This section of code takes user input from the RTT Viewer, activates the operation and then print the test results on the RTT Viewer.

5.1.3.2 Secure flash program

- Read and write from the secure flash program to the secure SRAM and non-secure SRAM region
 - Show access to all SRAM regions are granted
- Read from the secure flash program to the secure flash data region and non-secure flash data region
 - Show access to all flash regions are granted

5.1.3.3 Secure SRAM program

- Read and write from the secure SRAM program to the secure SRAM and non-secure SRAM region
 - Show access to all SRAM regions are granted
- Read and write from the secure SRAM program to the secure flash and non-secure flash region
 - Show access to all flash regions are granted

5.1.3.4 Non-secure flash program

- Read and write from the non-secure flash program to the secure SRAM and non-secure SRAM region
 - Show access to the non-secure SRAM region is granted
 - Show access to the secure SRAM region is not granted
- Read and write from the non-secure flash program to the secure and non-secure flash region
 - Show that before the FAW is set up, write access to all flash regions is granted. This is an example of internal flash read protection (see section 4.1)
 - Show that after the FAW is set up, write access to the non-FAW region is not granted. This is an example of internal flash write protection (see section 4.2).
 - If this non-FAW region is part of the Security MPU region, this is an example of internal flash read and write protection (see section 4.3)
 - If we lock the FAW setting (via clearing the FSPR bit):
 - The above flash write-protected region becomes a write-once region (see section 4.4)
 - The above flash read/write protected region becomes a write-once and read protected region (see section 4.5)

Special Note on the macro definition for `SECURE_PADDING`: This macro inserts the gap between secure and non-secure code execution as requested by the Security MPU architecture as described in section 4.6.1.1.

Figure 23 shows the source files grouped by functionality.

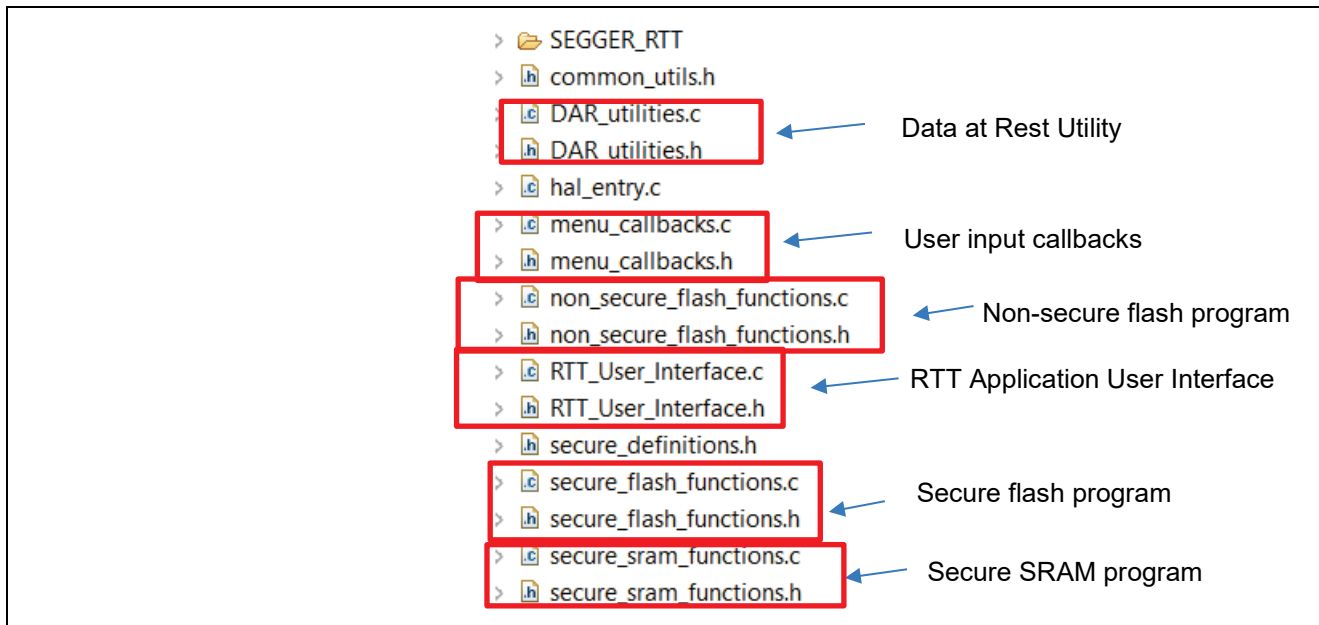

Figure 23. Source Code

Note that the non-secure functions defined in the above source files may call secure subroutines and secure functions defined above may call non-secure subroutines. Security MPU allows cross domain function calls between secure and non-secure domain.

Care should be taken such that the secure information does not leak to the non-secure region via the stack area. Whenever it is possible, design the secure function such that the stack area is not used to store local variables.

5.1.4 Establishing and Running Software from Secure SRAM Region

Running secure programs from the secure SRAM region involves the following actions:

- Set up the secure SRAM region from the linker script, as shown in section 5.1.2
- Relocate the secure SRAM application code (.secure_sram_program region) from the secure flash region to the secure SRAM region in the linker script

```

/* Secure application SRAM code and secure flash driver code are stored in this section. */
.secure_sram_program :
{
    . = ALIGN(8);
    secure_sram_program_start = .;
    KEEP(*(.secure_sram_program*))

    Code_In_RAM_Start = .;
    KEEP(*(.code_in_ram*))
    __Code_In_RAM_End = .;

    __secure_sram_program_end = .;
} > SECURE_RAM_PROGRAM AT>SECURE_PROGRAM
    
```

Figure 24. Allocate Code to Secure SRAM

- Copy the secure SRAM code from the secure flash region to the secure SRAM region using application code. Refer to the secure_sram_section_copy function (in secure_flash_functions.c) for implementation
 - The .code_in_ram FSP code section relocates the flash writing routine to RAM. In this application project, we allocated this section of the code in the secure SRAM section as shown above.

5.1.5 Importing and Building the Project

Create a new workspace and import the `\embedded\secure_data_at_rest_ek_ra6m3` project into e² studio, build, and run the project. **Note that once this program is run, the Security MPU is set up, user must run the Reset program (using 5.2) or the Reset Script (using section 5.4) prior to programming a new application or program an updated version of this `secure_data_at_rest_ek_ra6m3` application.**

5.1.6 Hardware Setup

Connect J10 using the micro-USB cable to the workstation to provide power and debugging capability using the on-board debugger.

5.1.7 Verifying the Secure Functionalities

Launch 'J-Link RTT Viewer' V7.92j or later.



Figure 25. Launch J-Link RTT Viewer

Select 'USB' as connection type. Click on the '...' button to select 'R7FA6M3AH' as the device.

If the host PC has more than one J-Link debugger connected to the PC, set the 'Serial No' (by default Serial No is set to 0).

Click 'Next' to establish the connection.

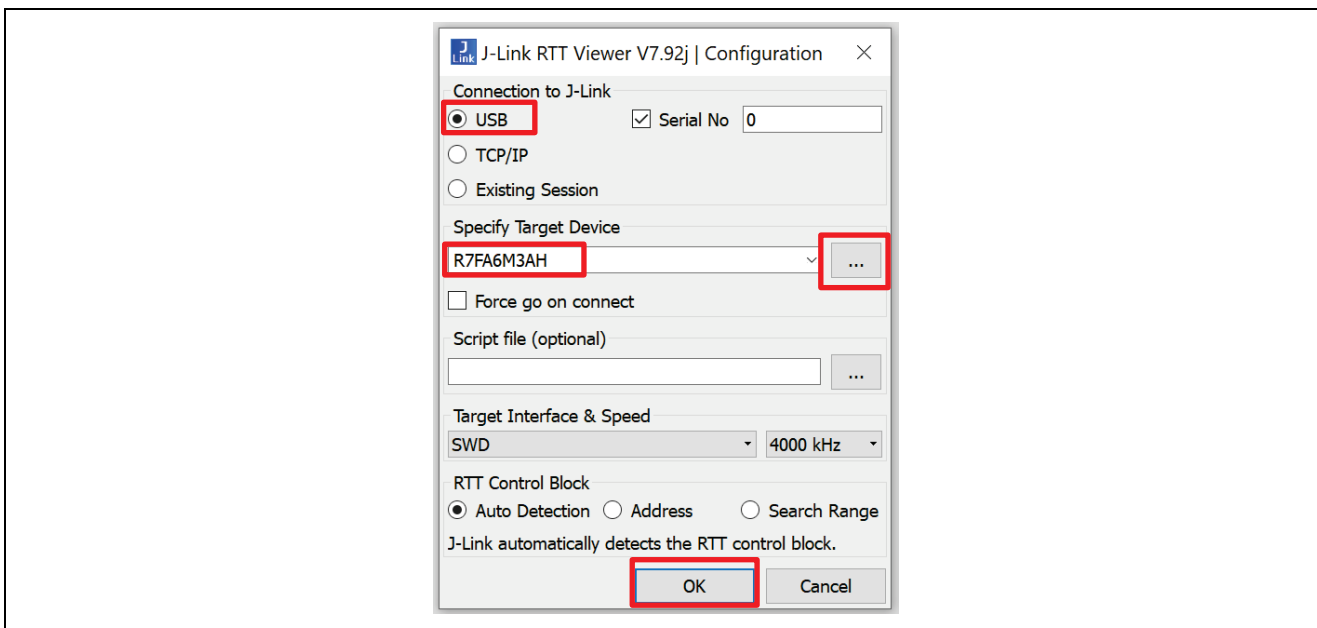

Figure 26. Launch SEGGER RTT Viewer

Step 1: The main menu items are printed on the RTT Viewer Terminal 0.

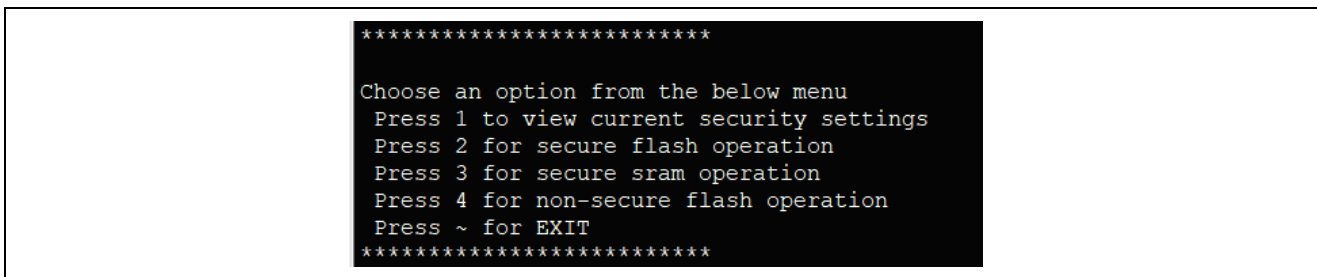

Figure 27. Main Menu

Step 2: Input '1' on RTT Viewer Terminal 0 and view the default Security MPU and FAW settings (Function `read_secure_settings` performs this task).

```

*****

Security MPU settings

PC Region 0: enabled [0x    500 | 0x   7FFF]
PC Region 1: enabled [0x1FFE0000 | 0x1FFEFFFF]
Secure Region 0: enabled [0x    400 | 0x   DFFF]
Secure Region 1: enabled [0x1FFE0000 | 0x2002FFFF]
Secure Region 2: disabled
Secure Region 3: disabled
Access Window: disabled
Enter r to go back to the main menu

```

Figure 28. Security Setting

Step 3: Input '2' on RTT Viewer Terminal 0 to view the secure flash functions (functions running in secure flash region).

```

*****

Choose an option from the below menu for secure flash operation
Press a to read
Press b to write
Press c to setup faw
Press d to reset faw
*****
Enter r to go back to the main menu

```

Figure 29. Secure Flash Program Operation Menu

Input 'a' to read the secure flash, secure SRAM, non-secure flash, non-secure SRAM region from the secure flash functions and confirm that read accesses are granted. Function `secure_code_read()` verifies this functionality.

```

*****

Secure code reads...running from secure flash

PASS! secure flash program can read secure flash

PASS! secure flash program can read secure ram

PASS! secure flash program can read non-secure flash

PASS! secure flash program can read non-secure ram

Enter r to go back to the main menu

```

Figure 30. Secure Flash Program Read

Input 'b' to perform writing of the secure SRAM, non-secure SRAM regions from the secure flash functions and confirm the write accesses are granted. Function `secure_code_write()` performs this function.

```
*****
Secure code writes...running from secure flash
PASS! secure flash program can write secure sram data
PASS! secure flash program can write non-secure sram data
Enter r to go back to the main menu
```

Figure 31. Secure Flash Program Writes

Input 'c' to set up the FAW. Figure 31 shows the default FAW region set up by the example project. Input '1' to confirm FAW is set up.

```
*****
Setup Flash Access Window...running from flash
PASS secure program => faw is setup from 0x100000 to 0x1FFFFF
Enter r to go back to the main menu

*****

Security MPU settings

PC Region 0: enabled [0x 500 | 0x 7FFFF]
PC Region 1: enabled [0x1FFE0000 | 0x1FFEFFFF]
Secure Region 0: enabled [0x 400 | 0x DFFFF]
Secure Region 1: enabled [0x1FFE0000 | 0x2002FFFF]
Secure Region 2: disabled
Secure Region 3: disabled
Access Window: enabled [0x 100000 | 0x 200000]
Enter r to go back to the main menu
```

Figure 32. Set up the FAW (from 0x100000 to 0x1FFFFF)

Input '2' and then 'd' to reset the FAW from secure flash program.

```

*****
Choose an option from the below menu for secure flash operation
Press a to read
Press b to write
Press c to setup faw
Press d to reset faw
*****

Enter r to go back to the main menu

*****

Reset Flash Access Window...running from flash

PASS secure program => faw is reset

*****

Enter r to go back to the main menu

```

Figure 33. Reset the FAW

Input '1' to confirm the FAW region is disabled.

```

*****

Security MPU settings

PC Region 0: enabled [0x    500 | 0x   7FFF]
PC Region 1: enabled [0x1FFE0000 | 0x1FFEFFFF]
Secure Region 0: enabled [0x    400 | 0x   DFFF]
Secure Region 1: enabled [0x1FFE0000 | 0x2002FFFF]
Secure Region 2: disabled
Secure Region 3: disabled
Access Window: disabled

Enter r to go back to the main menu

```

Figure 34. Confirm FAW is Disabled

Step 4: Input '3' to view the secure SRAM functions (functions running out of the secure SRAM region).

```

*****

Choose an option from the below menu for secure sram operation
Press g to read
Press h to write
*****

Enter r to go back to the main menu

```

Figure 35. Secure SRAM Program

Input 'g' to read the secure flash, secure SRAM, non-secure flash, non-secure SRAM region from the secure SRAM functions and confirm read accesses are granted. Function `secure_sram_code_read` performs this function.

```

*****
Secure sram code reads...running from secure sram
PASS! secure sram program can read secure flash
PASS! secure sram program can read secure ram
PASS! secure sram program can read non-secure flash
PASS! secure sram program can read non-secure ram
Enter r to go back to the main menu

```

Figure 36. Secure SRAM Program Read

Input 'h' to write to the secure flash, secure SRAM, non-secure flash, non-secure SRAM regions from the secure SRAM functions **with FAW region enabled** from 0x100000 to 0x1FFFFFF. Function `secure_sram_code_write` performs this function.

```

< h
00> *****
00>
00> Secure sram code writes...running from secure sram
00>
00> Access Window:  enabled [0x A0000 | 0x 200000]
00>
00> PASS! secure sram program can write secure sram data
00>
00> PASS! secure sram program can write non-secure sram data
00>
00>
00> PASS! secure sram program can write to secure flash FLASH_WRITE_TEST_BLOCK1
00>
00>     which is modifiable based on FAW setting.
00>
00>
00> PASS! secure sram program can write to non-secure flash FLASH_WRITE_TEST_BLOCK2
00>
00>     which is modifiable based on FAW setting.
00>
00> Enter r to go back to the main menu
00>

```

Figure 37. Secure SRAM Program Write

Step 5: Input 'r' then '4' to view the non-secure flash functions (functions running out of non-secure flash region).

```
*****
Choose an option from the below menu
Press 1 to view current security settings
Press 2 for secure flash operation
Press 3 for secure sram operation
Press 4 for non-secure flash operation
Press ~ for EXIT
*****

Enter r to go back to the main menu

*****

Choose an option from the below menu for non_secure flash operation
Press m to read
Press n to write
*****

Enter r to go back to the main menu
```

Figure 38. Non-secure Flash Program Functions

Input 'm' to read the secure flash, secure SRAM, non-secure flash, non-secure SRAM region from the non-secure flash functions and confirm that reading secure memory is not valid. Function `non_secure_code_read` performs this function.

```
*****

non-secure code reads...running from non-secure flash

PASS! non-secure program cannot read secure flash

PASS! non-secure program cannot read secure sram

PASS! non-secure program can read non-secure flash

PASS! non-secure program can read non-secure sram

Enter r to go back to the main menu
```

Figure 39. Read Operation from Non-secure Flash Program

Input 'n' to write the secure flash, secure SRAM, non-secure flash, non-secure SRAM regions from non-secure flash program **with FAW region enabled** from 0x100000 to 0x1FFFFFF and show that secure flash memory should be protected with FAW to prevent non-secure code writing. Function `non_secure_code_write` performs this function.

```

< n
00> *****
00>
00> non-secure flash code tests...running from non-secure flash
00>
00> Access Window:   enabled [0x 100000 | 0x 200000]
00>
00> PASS! non-secure flash program cannot write secure sram data
00>
00> PASS! non-secure flash program can write to non-secure sram data
00>
00> PASS! non-secure flash program cannot write to secure flash region FLASH_WRITE_TEST_BLOCK1
00>
00>         which is unmodifiable based on FAW setting.
00>
00>
00> PASS! non-secure flash program can write to non-secure flash region FLASH_WRITE_TEST_BLOCK2
00>
00>         which is modifiable based on FAW setting
00>
00> Enter r to go back to the main menu
00>

```

Figure 40. Write Operation from Non-secure Flash Program

Step 6: Input 'd' to reset the FAW setting and verify the operation by input '1'.

```

*****
Reset Flash Access Window...running from flash
PASS secure program => faw is reset
*****
Enter r to go back to the main menu

*****

Security MPU settings

PC Region 0: enabled [0x    500 | 0x   7FFFF]
PC Region 1: enabled [0x1FFE0000 | 0x1FFEFFFFF]
Secure Region 0: enabled [0x    400 | 0x   DFFFF]
Secure Region 1: enabled [0x1FFE0000 | 0x2002FFFFF]
Secure Region 2: disabled
Secure Region 3: disabled
Access Window: disabled
Enter r to go back to the main menu

```

Figure 41. Reset FAW and Confirm FAW is Reset

Note that once this program is run, the Security MPU is set up, user must run the Reset program (using 5.2) or the Reset Script (using section 5.4) prior to program a new application or program an updated version of this `secure_data_rest_ek_ra6m3` application.

5.1.7.1 Summary of the Functionalities Provided in this Application Project:

- Establish read/write protection to the secure flash and secure SRAM regions using Security MPU and FAW setting.
- Shield secure data from the debugger. For demonstration, try to view the memory of the secure data region from the debugger, value “0” is presented. The protection from debugger is effective after first power recycle.

Address	0 - 3	4 - 7	8 - B	C - F
000000000000400	00000000	00000000	00000000	00000000
000000000000410	00000000	00000000	00000000	00000000
000000000000420	00000000	00000000	00000000	00000000
000000000000430	00000000	00000000	00000000	00000000
000000000000440	00000000	00000000	00000000	00000000
000000000000450	00000000	00000000	00000000	00000000
000000000000460	00000000	00000000	00000000	00000000
000000000000470	00000000	00000000	00000000	00000000
000000000000480	00000000	00000000	00000000	00000000
000000000000490	00000000	00000000	00000000	00000000
0000000000004A0	00000000	00000000	00000000	00000000
0000000000004B0	00000000	00000000	00000000	00000000
0000000000004C0	00000000	00000000	00000000	00000000
0000000000004D0	00000000	00000000	00000000	00000000
0000000000004E0	00000000	00000000	00000000	00000000
0000000000004F0	00000000	00000000	00000000	00000000
000000000000500	00000000	00000000	00000000	00000000
000000000000510	00000000	00000000	00000000	00000000
000000000000520	00000000	00000000	00000000	00000000

Figure 42. Secure Data Region is not Viewable from Debugger

- Establish a blueprint of how to implement secure flash and secure SRAM regions with read and write protection of the secure SRAM and secure flash regions.

5.1.8 Migrating to Other RA MCUs

Each MCU group and each MCU within a group may have different internal flash and SRAM size.

Follow these steps to migrate this application:

1. Modify the BSP Security MPU region settings to fit the memory size.
2. Copy over the fsp_app.ld and rename to confirm to the new RA MCU.
3. Modify the linker script to take care of the new secure flash and SRAM regions defined in the BSP tab.
4. Modify the FAW region range if needed in the application code based on the flash size of the new MCU.
5. The entire application code size is about 22 kB flash and 5 kB of SRAM. Please use these numbers as reference when migrating to other RA MCU devices. No application code update is needed when migrating to RA6M1 and RA6M2.

5.2 Project 2: e² studio Project - Reset the Security MPU and FAW setting

This e² studio project `\embedded\reset_ek_ra6m3` provides an example to reset the Security MPU and FAW setting using the FSP Flash HAL driver. **The user must run this project or the Reset script provided in 5.4 every time they update a project with the Security MPU enabled, or load a new project.**

Usage Notes for this Project

There is a compiling error generated when this project is compiled. User can safely ignore this compiling error. It is being fixed in future e² studio releases.

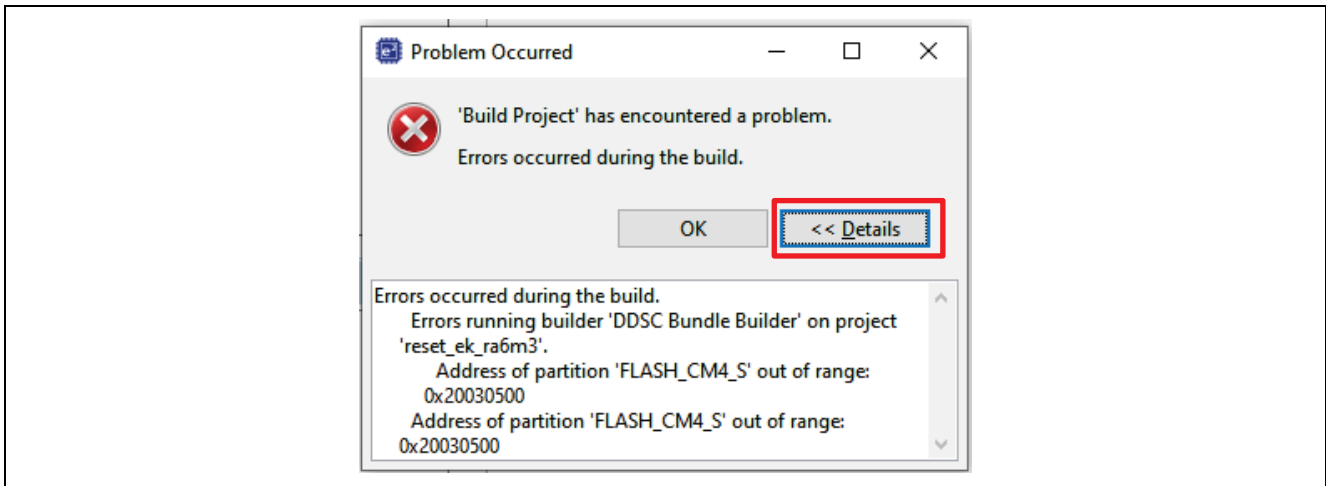

Figure 43. Compiling Error that Can be Ignored on the First Build

Note that subsequent build will not show this error message anymore.

Also, the linker script is updated from the default to assign both program and data section to SRAM.

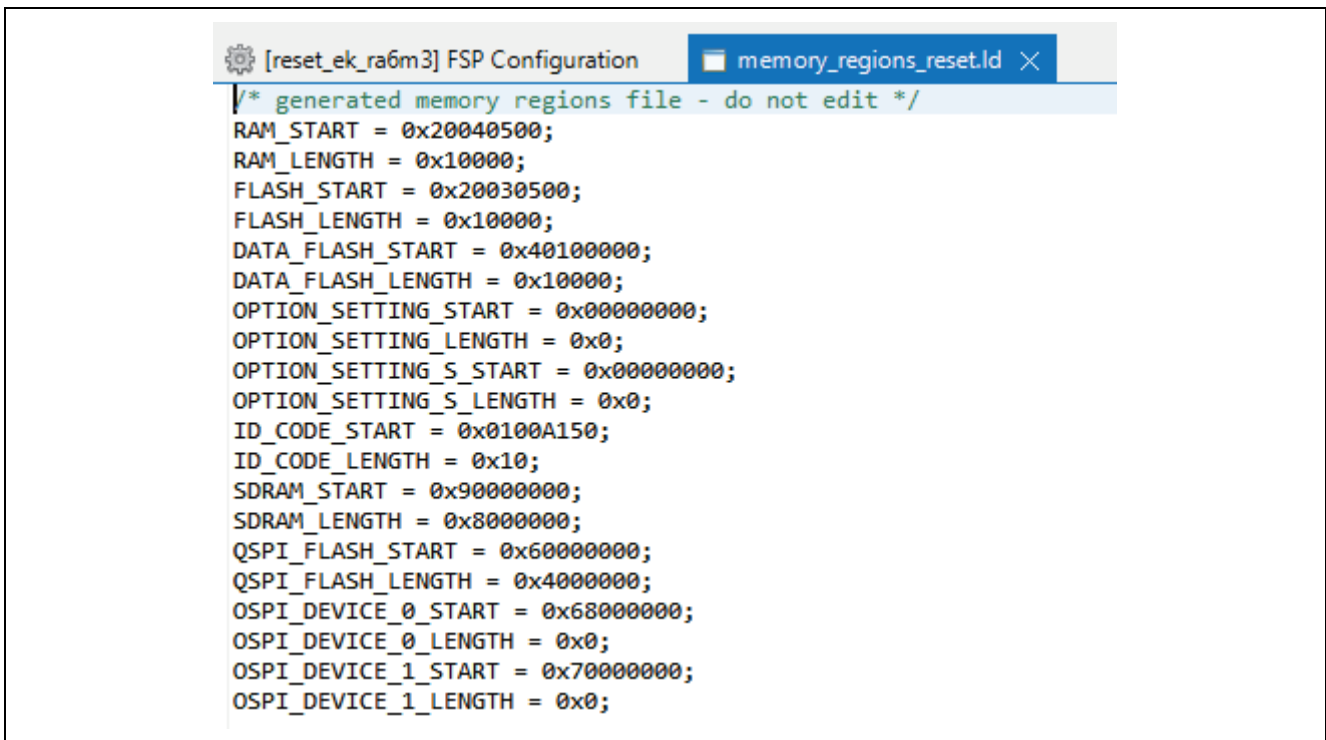

Figure 44. Customized Linker Script for reset_ek_ra6m3 Project

In addition, the stack pointer and Program counter need to update to match the new memory layout based on the linker script.

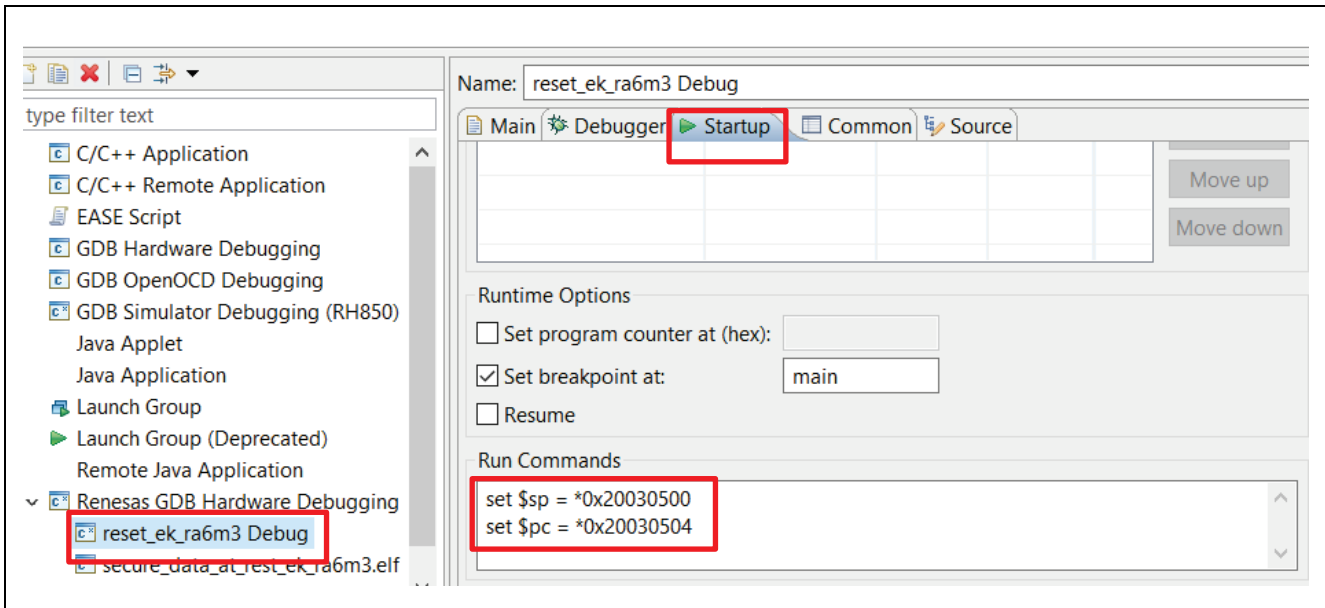

Figure 45. Set up the SP and PC

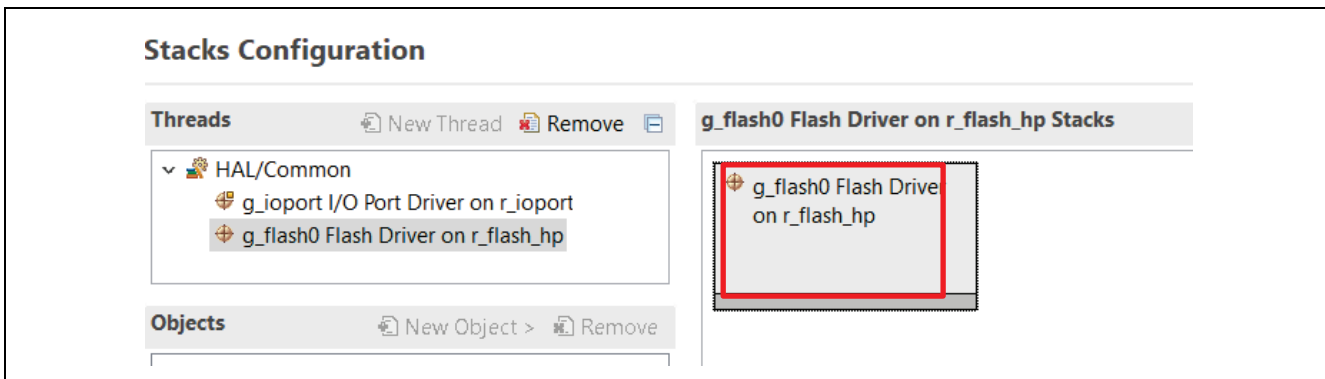

Figure 46. Flash Driver on r_flash_hp

After these preparations, call the routines in Figure 47 to clear the FAW region setting. Build and run the project. Pause the project, it should have reached: `while(1);` after successful flash erase.

```

/* Configure and open the Flash API */
err = R_FLASH_HP_Open(&g_flash0_ctrl, &g_flash0_cfg);
APP_ERR_TRAP(err);

/* Remove any prior access window */
err = R_FLASH_HP_AccessWindowClear(&g_flash0_ctrl);
APP_ERR_TRAP(err);

/* erase SECMPUAC at 0x00000438 */
err = R_FLASH_HP_Erase(&g_flash0_ctrl, reg_secureMPUAccessControl, NUMBER_OF_SECTOR);
APP_ERR_TRAP(err);

/* close flash API */
err = R_FLASH_HP_Close(&g_flash0_ctrl);
APP_ERR_TRAP(err);

while(1);
    
```

Figure 47. Resetting Security MPU and FAW Settings

5.3 Project 3: PC Application to Permanently Lock the FAW

The workstation utility that permanently locks the FAW uses the MCU's factory loader as shown in Figure 11.

Factory Boot Loader Mode:

Connect Jumper J12 to 2 and 3 to enable USB FS Device mode of RA6M3. Connect J11 to PC using the micro USB cable.

- Connecting jumper J16 and power cycle the board, the RA6M3 boots with the factory bootloader in USB program mode, which enables you to load a program directly to the internal microcontroller flash through the USB device interface (CDC Class).

To use this tool, follow the steps below:

Step 1: Exercise the default evaluation content which programs the default program to EK-RA6M3. The default program installer.exe under \pc program\final_program_installer_script does not lock down the FAW. It does set up the FAW region.

- Put the RA MCU in factory bootloader mode.
- Open the device manager and find the enumerated COM port number for "USB Serial Device".
- Run the deploy_app.bat file and provide the enumerated COM port number as the argument. See example output in Figure 48.

```
C:\MyProjects\RA\Data at Rest Repo\ra_solutions\Data-at-Rest-Dev\pc
program\final_program_installer_script>deploy_app.bat 12

C:\MyProjects\RA\Data at Rest Repo\ra_solutions\iotsg-2712-secure-data-at-rest-dev\pc
program\final_program_installer_script>REM script to download application and setup FAW

C:\MyProjects\RA\Data at Rest Repo\ra_solutions\iotsg-2712-secure-data-at-rest-dev\pc
program\final_program_installer_script>echo off
Parsed SREC file: secure_data_at_rest_ek_ra6m3.srec (0x0..0x103513)
Initialising flash programming connection to port COM12
Established flash programming connection
Disabling flash access window (0x0..0xFFFFFFFF)
Flash access window is now disabled
Erasing flash
Flash erased OK
Writing flash for secure_data_at_rest_ek_ra6m3.srec region (bufferOffset=0x0, 0x103513
bytes)
Flash region written OK
Flash Access Window configured for start=0x100000, end=0x1fffff
Completed OK
```

Figure 48. Program the Application without Locking the FAW Region (needs update)

Note: Every time before reprogramming the application, the reset routine must be performed successfully.

Step 2: Proceed with locking the FAW region if needed by following steps:

- Open the Visual Studio project program_installer.sln (\pc program\final_program_installer_src\pc\apps\program_installer\program_installer.sln).
- Open the project properties. Under C/C++>Preprocessor, add a Preprocessor definition for ACTIVATE_THE_FSPR.

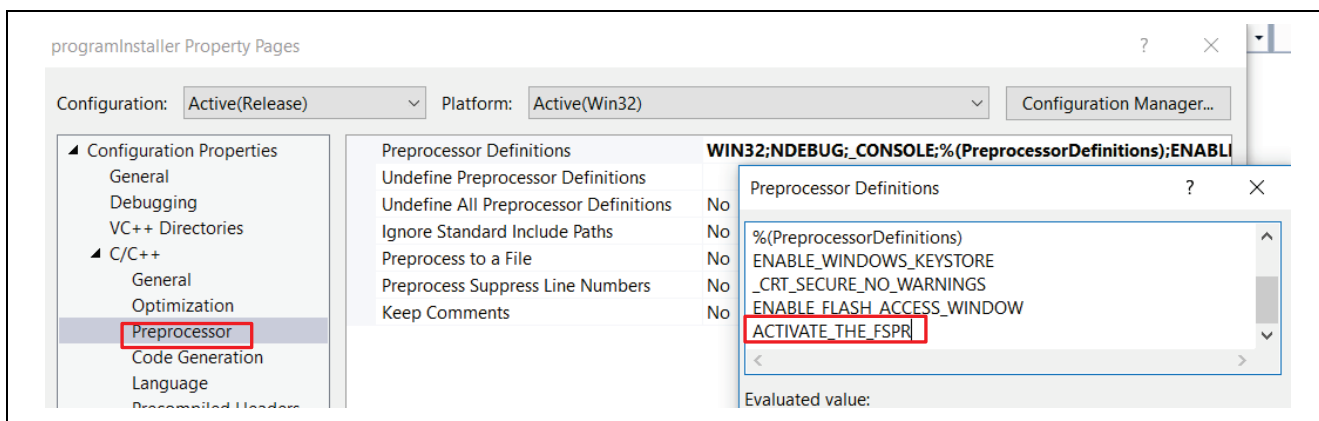

Figure 49. Set up the FAW Locking

3. Compile Program_Installer project.
If you are using Visual Studio 2017 professional or enterprise version, you will run into following error message.

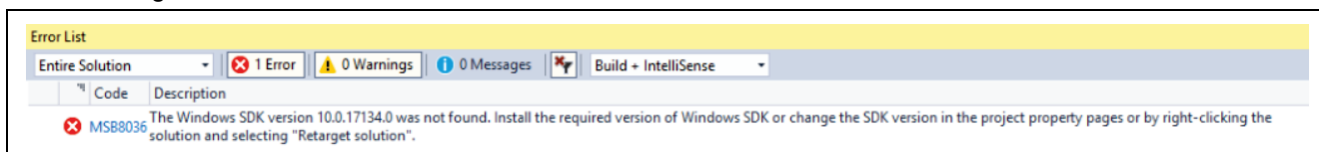

Figure 50. Compiling the Program Installer

To resolve this error message, right-click on the project and select **Retarget Projects**. Then choose the SDK version you are using. Proceed to compiling.

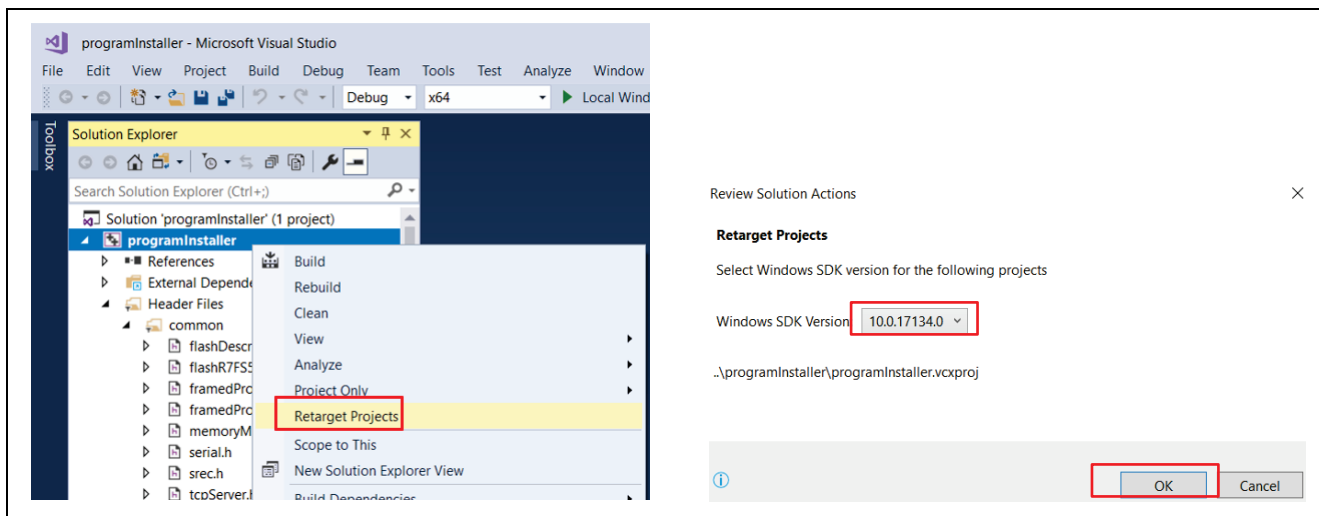

Figure 51. Retarget the Solution

4. Compile the application Project 1 \embedded\secure_data_at_rest_ek_ra6m3 with ID code region removed. This is a limitation of this tool. If you do not change secure_data_at_rest_ek_ra6m3, there is no need to take this action as there is a copy of the default .srec file included in the script folder.
5. Put the generated secure_data_at_rest_ek_ra6m3.srec and newly built programInstaller.exe in the same folder as the deploy_app.bat file (pc program\final_program_installer_script).
6. Proceed to use the same steps from 1 to 3 in Step 1 in this section to program the final application.

Warning: The unmodifiable flash region will be permanently locked down with the current image (from 0x0 to 0xFFFFF).

```

Writing flash for secure_data_at_rest_ek_ra6m3.srec region (bufferOffset=0x0, 0x10BBE8
bytes)
Flash region written OK
Flash Access Window configured for start=0x100000, end=0x1ffffff
Completed OK

```

Figure 52. Lock the FAW Region

5.4 Example Reset J-Link Script for the Security MPU and FAW

In the `\reset_scripts` folder, there is the Security MPU and FAW region reset J-Link Script under `\smpu_aws_reset_script`. This script resets the Security MPU and FAW settings before the FSPR bit is cleared (that is, the FAW region is permanently locked down). Under `\smpu_aws_reset_script`, there are two files (Figure 53).

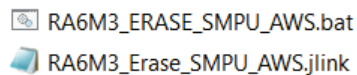

Figure 53. Security MPU and FAW Reset Script

Open `RA6M3_ERASE_SMPU_AWS.bat` and update the SEGGER J-Link version to match your J-Link version by updating the folder name.

```

set PATH=%PATH%;"C:\Program Files (x86)\SEGGER\JLink"
jlink -CommanderScript RA6M3_Erase_SMPU_AWS.jlink
pause

```

Figure 54. Update the SEGGER J-Link Version

The script performs the following functions:

1. Reset the device.
2. Reprogram the Flash Access Window configuration area (0x0100A160 for RA6M3) to all FFs.
3. Reset the device.
4. Erase the first block of code flash.
5. Reset the device.

To run the reset script, put RA6M3 into Normal Boot mode and open a command line window, navigate to the location of the `.bat` file, and run the `RA6M3_ERASE_SMPU_AWS.bat`. The last portion of the output from running this script is included below:

Normal Boot: Removing jumper J16 and power cycle the board, the RA6M3 starts execution from internal flash (ROM). This is the normal mode of operation.

```
J-Link Command File read successfully.
Processing script file...

J-Link connection not established yet but required for command.
Connecting to J-Link via USB...O.K.
Firmware: J-Link OB-S124 compiled Feb 23 2017 17:01:55
Hardware version: V1.00
S/N: 831004110
VTref=3.300V

Selecting SWD as current target interface.

Selecting 2000 kHz as target interface speed

Device "R7FA6M3AH" selected.
..... (omitted the middle portion of the output)

Writing AA00 -> 407FE084

00000000 = FFFFFFFF FFFFFFFF FFFFFFFF FFFFFFFF
00000010 = FFFFFFFF FFFFFFFF FFFFFFFF FFFFFFFF
00000020 = FFFFFFFF FFFFFFFF FFFFFFFF FFFFFFFF
00000030 = FFFFFFFF FFFFFFFF FFFFFFFF FFFFFFFF
00000040 = FFFFFFFF FFFFFFFF FFFFFFFF FFFFFFFF
00000050 = FFFFFFFF FFFFFFFF

Unknown command. '?' for help.

Reset delay: 0 ms
Reset type NORMAL: Resets core & peripherals via SYSRESETREQ & VECTRESET bit.
Reset: Halt core after reset via DEMCR.VC_CORERESET.
Reset: Reset device via AIRCR.SYSRESETREQ.

Script processing completed.
C:\MyProjects\RA\Data at Rest Repo\ra_solutions\iotsg-2712-secure-data-at-rest-dev\reset_scripts\smmu_aws_reset_script>pause
Press any key to continue . . .
```

Figure 55. Running the Security MPU and FAW Reset Script

5.5 J-Link Scripts for Resetting OSIS ID code for RA6M3

Under `\reset_scripts\osis_id_resetting_script`, there are three files:

- `ID_Code_ERASEALL_RA6M3.bat`
- `IDCode_ALeRASE_RV40_ph2.jlinkscript`
- `RA6M3_connect.jlink`

Follow the steps below to exercise these reset scripts.

Step 1: If you don't have the SEGGER tools installed, go to <https://www.segger.com/downloads/J-Link/> and download and stall the latest J-Link software.

Step 2: Create a blinky project using the e² studio.

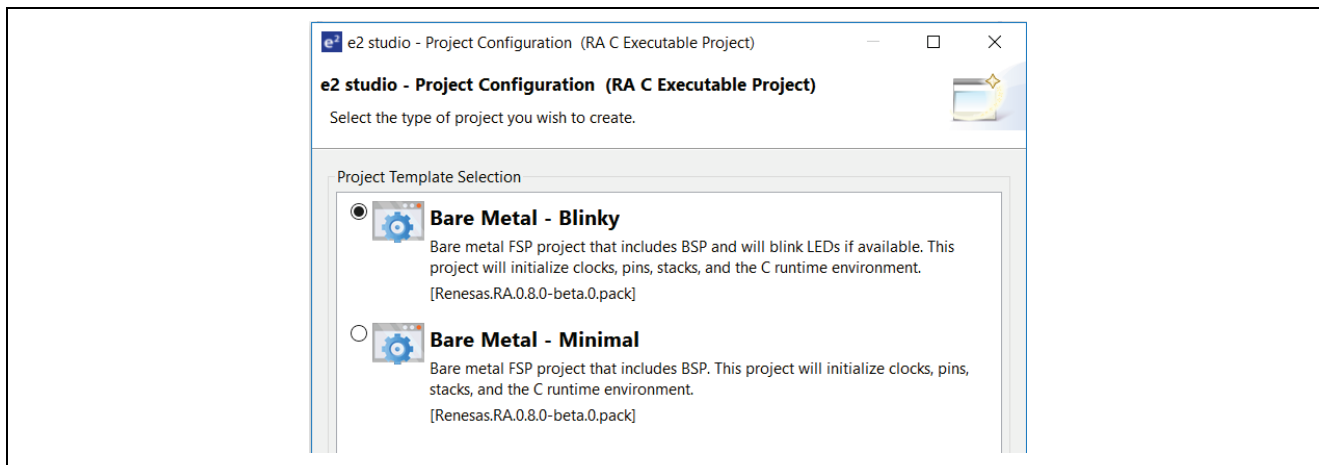

Figure 56. Create a Blinky Project

Step 3: Setup the ID code in the “Property” field under the BSP tab. Note bit 127 and bit 126 are both set to 1.

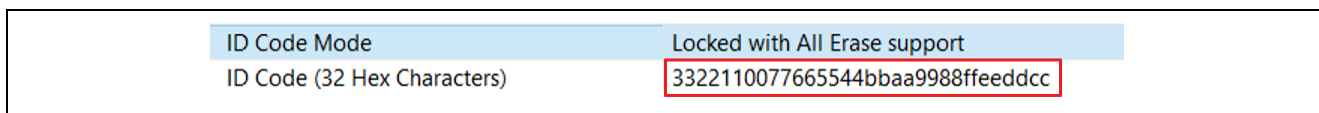

Figure 57. Setup ID Code in Configurator

Step 4: Click **Generate Project Content**, and compile the project.

Step 5: Open the debug configuration **Debugger>Connection Settings**, input the OSIS ID below. Click **Apply>Debug**.

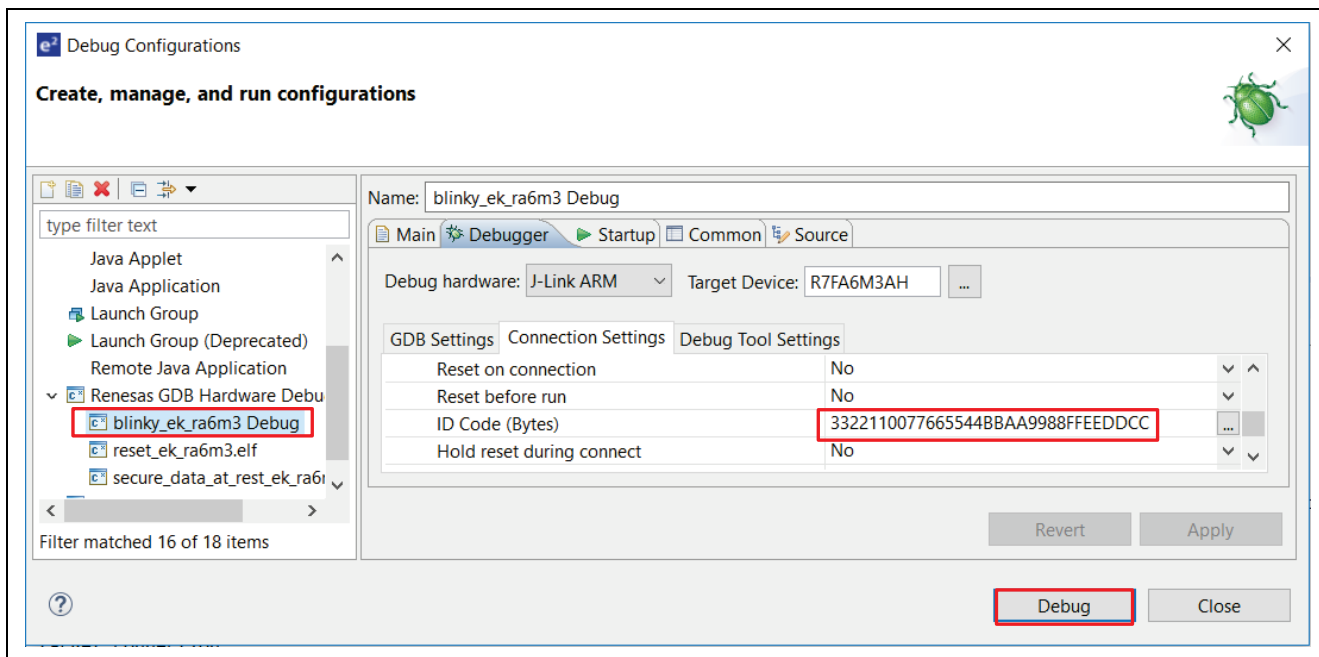

Figure 58. Setup Matching ID Code in Debug Configuration

Step 6: Debug the project. If the debugging is happening, it is a proof that the ID code matched up.

Step 7: Stop the project.

The next couple of steps shows how to reset the OSIS ID code using the script included.

Step 8: Open a command prompt and navigate to the folder where you extracted the script files.

Step 9: Set the path to the version of J-Link that you are using for the RA projects:

```
set PATH=%PATH%;"C:\Program Files (x86)\SEGGER\JLink"
```

Step 10: Run the batch file `ID_Code_ERASEALL_RA6M3.bat` you should see output similar to the output below:

```
C:\MyProjects\RA\ra_solutions\application_projects\secure_data_at_rest\source\reset_scripts\osis_id_resetting_script>
jlink -JlinkScriptFile IDCode_ALeRASE_RV40_ph2.JlinkScript -CommanderScript RA6M3_connect.jlink
SEGGER J-Link Commander V6.52a (Compiled Oct  2 2019 10:30:12)
DLL version V6.52a, compiled Oct  2 2019 10:29:16

J-Link Command File read successfully.
Processing script file...

J-Link connection not established yet but required for command.
Connecting to J-Link via USB...O.K.
Firmware: J-Link OB-S124 compiled Feb 23 2017 17:01:55
Hardware version: V1.00
S/N: 831004110
VTref=3.300V

Selecting SWD as current target interface.

Selecting 4000 kHz as target interface speed

Device "R7FA6M3AH" selected.

Connecting to target via SWD
InitTarget() start

Synergy ALeRASE J-Link script InitTarget

ALeRASE CMD
SWO:

DAP-CtrlStat: 0x00000040
DAP-CtrlStat: 0xF0000040
DAP-CtrlStat: 0xC0000040
RESET assert
RESET de-assert
SWO:

DAP-CtrlStat: 0xF0000040
MCUSTAT: 0x00000000
MCUSTAT: 0x00000000
MCUSTAT: 0x00000000
MCUSTAT: 0x00000000
MCUSTAT: 0x00000000
MCUSTAT: 0x00000000
MCUSTAT: 0x00000002
RESET assert
RESET de-assert
DAP-CtrlStat: 0xF0000040
DAP-CtrlStat: 0xF0000040
MCUSTAT: 0x00000001
InitTarget() end
Found SW-DP with ID 0x5BA02477
Scanning AP map to find all available APs
AP[2]: Stopped AP scan as end of AP map has been reached
AP[0]: AHB-AP (IDR: 0x24770011)
AP[1]: APB-AP (IDR: 0x44770002)
Iterating through AP map to find AHB-AP to use
AP[0]: Core found
AP[0]: AHB-AP ROM base: 0xE00FF000
CPUID register: 0x410FC241. Implementer code: 0x41 (ARM)
Found Cortex-M4 r0p1, Little endian.
FPUnit: 6 code (BP) slots and 2 literal slots
CoreSight components:
ROMTbl[0] @ E00FF000
ROMTbl[0][0]: E000E000, CID: B105E00D, PID: 000BB00C SCS-M7
ROMTbl[0][1]: E0001000, CID: B105E00D, PID: 003BB002 DWT
ROMTbl[0][2]: E0002000, CID: B105E00D, PID: 002BB003 FPB
ROMTbl[0][3]: E0000000, CID: B105E00D, PID: 003BB001 ITM
ROMTbl[0][4]: E0040000, CID: B105900D, PID: 000BB9A1 TPIU
ROMTbl[0][5]: E0041000, CID: B105900D, PID: 000BB925 ETM
ROMTbl[0][6]: E0042000, CID: B105900D, PID: 002BB908 CSTF
ROMTbl[0][7]: E0043000, CID: B105900D, PID: 001BB961 TMC
ROMTbl[0][8]: E0044000, CID: B105F00D, PID: 001BB101 TSG

Synergy ALeRASE J-Link script SetupTarget

MCUSTAT: 0x00000001
MCUCTRL: 0x00000000
SYOCDR: 0x00000080
Memory Address 0: 0xFFFFFFFF
OSIS 1: 0xFFFFFFFF
OSIS 2: 0xFFFFFFFF
OSIS 3: 0xFFFFFFFF
OSIS 4: 0xFFFFFFFF
Cortex-M4 identified.

Script processing completed.
```

Figure 59. Erase Entire Flash and Reset the OSIS ID Code

The following two steps confirm the OSIS ID reset is successfully done.

Step 11: Reset the OSIS ID to all FFs in the configurator for the blinky project (see Figure 57) and compile the project.

Step 12: Reset the OSIS ID for the debugger configuration to all FFs (see Figure 58) and confirm the debugging works.

6. Secure Data at Rest Next Steps

6.1 Secure Data Encryption and Authentication

A future release of this application project will cover secure data encryption and authentication.

6.2 External Storage Secure Data at Rest

A future release of this application project will cover external storage data encryption and authentication as well as access control.

6.3 Example using the Security MPU Security Functions

As explained in section 2.2, there are two security functions that can be controlled by the Security MPU.

One security function controls the access to the Secure Crypto Engine (SCE). When this security function is enabled, only secure program can access the SCE.

The other security function controls the access to the code and data flash Erase and Programming (E/P). When this security function is enabled, only secure program can perform internal flash E/P.

This application project does not provide an example of using these security functions.

7. References

1. Renesas Flash Programmer: <https://www.renesas.com/us/en/products/software-tools/tools/programmer/renesas-flash-programmer-programming-gui.html#downloads>
2. *Arm®v7-M Architecture Reference Manual* (ARM DDI 0403D)
3. *Arm® Cortex®-M4 Processor Technical Reference Manual* (ARM DDI 0439D)
4. *Arm® Cortex®-M4 Devices Generic User Guide* (ARM DUI 0553A)

8. Website and Support

Visit the following URLs to learn about the RA family of microcontrollers, download tools and documentation, and get support.

EK-RA6M3 Resources	renesas.com/ra/ek-ra6m3
RA Product Information	renesas.com/ra
Flexible Software Package	renesas.com/ra/fsp
RA Product Support Forum	renesas.com/ra/forum
Renesas Support	renesas.com/support

Revision History

Rev.	Date	Description	
		Page	Summary
1.00	Oct.04.19	-	First release document
1.10	May 14.20	-	Update to FSP v1.1.0
1.20	July 15.20	-	Update to FSP v1.2.0, title updated
1.30	Dec.15.20	-	Update to FSP v2.2.0
1.40	Aug.01.22	-	Update to FSP v3.7, linker script and ID Code usage note updated
1.50	Mar.04.24	-	Update to FSP v5.0.0

Notice

1. Descriptions of circuits, software and other related information in this document are provided only to illustrate the operation of semiconductor products and application examples. You are fully responsible for the incorporation or any other use of the circuits, software, and information in the design of your product or system. Renesas Electronics disclaims any and all liability for any losses and damages incurred by you or third parties arising from the use of these circuits, software, or information.
2. Renesas Electronics hereby expressly disclaims any warranties against and liability for infringement or any other claims involving patents, copyrights, or other intellectual property rights of third parties, by or arising from the use of Renesas Electronics products or technical information described in this document, including but not limited to, the product data, drawings, charts, programs, algorithms, and application examples.
3. No license, express, implied or otherwise, is granted hereby under any patents, copyrights or other intellectual property rights of Renesas Electronics or others.
4. You shall be responsible for determining what licenses are required from any third parties, and obtaining such licenses for the lawful import, export, manufacture, sales, utilization, distribution or other disposal of any products incorporating Renesas Electronics products, if required.
5. You shall not alter, modify, copy, or reverse engineer any Renesas Electronics product, whether in whole or in part. Renesas Electronics disclaims any and all liability for any losses or damages incurred by you or third parties arising from such alteration, modification, copying or reverse engineering.
6. Renesas Electronics products are classified according to the following two quality grades: "Standard" and "High Quality". The intended applications for each Renesas Electronics product depends on the product's quality grade, as indicated below.

"Standard": Computers; office equipment; communications equipment; test and measurement equipment; audio and visual equipment; home electronic appliances; machine tools; personal electronic equipment; industrial robots; etc.

"High Quality": Transportation equipment (automobiles, trains, ships, etc.); traffic control (traffic lights); large-scale communication equipment; key financial terminal systems; safety control equipment; etc.

Unless expressly designated as a high reliability product or a product for harsh environments in a Renesas Electronics data sheet or other Renesas Electronics document, Renesas Electronics products are not intended or authorized for use in products or systems that may pose a direct threat to human life or bodily injury (artificial life support devices or systems; surgical implantations; etc.), or may cause serious property damage (space system; undersea repeaters; nuclear power control systems; aircraft control systems; key plant systems; military equipment; etc.). Renesas Electronics disclaims any and all liability for any damages or losses incurred by you or any third parties arising from the use of any Renesas Electronics product that is inconsistent with any Renesas Electronics data sheet, user's manual or other Renesas Electronics document.
7. No semiconductor product is absolutely secure. Notwithstanding any security measures or features that may be implemented in Renesas Electronics hardware or software products, Renesas Electronics shall have absolutely no liability arising out of any vulnerability or security breach, including but not limited to any unauthorized access to or use of a Renesas Electronics product or a system that uses a Renesas Electronics product. RENESAS ELECTRONICS DOES NOT WARRANT OR GUARANTEE THAT RENESAS ELECTRONICS PRODUCTS, OR ANY SYSTEMS CREATED USING RENESAS ELECTRONICS PRODUCTS WILL BE INVULNERABLE OR FREE FROM CORRUPTION, ATTACK, VIRUSES, INTERFERENCE, HACKING, DATA LOSS OR THEFT, OR OTHER SECURITY INTRUSION ("Vulnerability Issues"). RENESAS ELECTRONICS DISCLAIMS ANY AND ALL RESPONSIBILITY OR LIABILITY ARISING FROM OR RELATED TO ANY VULNERABILITY ISSUES. FURTHERMORE, TO THE EXTENT PERMITTED BY APPLICABLE LAW, RENESAS ELECTRONICS DISCLAIMS ANY AND ALL WARRANTIES, EXPRESS OR IMPLIED, WITH RESPECT TO THIS DOCUMENT AND ANY RELATED OR ACCOMPANYING SOFTWARE OR HARDWARE, INCLUDING BUT NOT LIMITED TO THE IMPLIED WARRANTIES OF MERCHANTABILITY, OR FITNESS FOR A PARTICULAR PURPOSE.
8. When using Renesas Electronics products, refer to the latest product information (data sheets, user's manuals, application notes, "General Notes for Handling and Using Semiconductor Devices" in the reliability handbook, etc.), and ensure that usage conditions are within the ranges specified by Renesas Electronics with respect to maximum ratings, operating power supply voltage range, heat dissipation characteristics, installation, etc. Renesas Electronics disclaims any and all liability for any malfunctions, failure or accident arising out of the use of Renesas Electronics products outside of such specified ranges.
9. Although Renesas Electronics endeavors to improve the quality and reliability of Renesas Electronics products, semiconductor products have specific characteristics, such as the occurrence of failure at a certain rate and malfunctions under certain use conditions. Unless designated as a high reliability product or a product for harsh environments in a Renesas Electronics data sheet or other Renesas Electronics document, Renesas Electronics products are not subject to radiation resistance design. You are responsible for implementing safety measures to guard against the possibility of bodily injury, injury or damage caused by fire, and/or danger to the public in the event of a failure or malfunction of Renesas Electronics products, such as safety design for hardware and software, including but not limited to redundancy, fire control and malfunction prevention, appropriate treatment for aging degradation or any other appropriate measures. Because the evaluation of microcomputer software alone is very difficult and impractical, you are responsible for evaluating the safety of the final products or systems manufactured by you.
10. Please contact a Renesas Electronics sales office for details as to environmental matters such as the environmental compatibility of each Renesas Electronics product. You are responsible for carefully and sufficiently investigating applicable laws and regulations that regulate the inclusion or use of controlled substances, including without limitation, the EU RoHS Directive, and using Renesas Electronics products in compliance with all these applicable laws and regulations. Renesas Electronics disclaims any and all liability for damages or losses occurring as a result of your noncompliance with applicable laws and regulations.
11. Renesas Electronics products and technologies shall not be used for or incorporated into any products or systems whose manufacture, use, or sale is prohibited under any applicable domestic or foreign laws or regulations. You shall comply with any applicable export control laws and regulations promulgated and administered by the governments of any countries asserting jurisdiction over the parties or transactions.
12. It is the responsibility of the buyer or distributor of Renesas Electronics products, or any other party who distributes, disposes of, or otherwise sells or transfers the product to a third party, to notify such third party in advance of the contents and conditions set forth in this document.
13. This document shall not be reprinted, reproduced or duplicated in any form, in whole or in part, without prior written consent of Renesas Electronics.
14. Please contact a Renesas Electronics sales office if you have any questions regarding the information contained in this document or Renesas Electronics products.

(Note1) "Renesas Electronics" as used in this document means Renesas Electronics Corporation and also includes its directly or indirectly controlled subsidiaries.

(Note2) "Renesas Electronics product(s)" means any product developed or manufactured by or for Renesas Electronics.

(Rev.5.0-1 October 2020)

Corporate Headquarters

TOYOSU FORESIA, 3-2-24 Toyosu,
Koto-ku, Tokyo 135-0061, Japan
www.renesas.com

Trademarks

Renesas and the Renesas logo are trademarks of Renesas Electronics Corporation. All trademarks and registered trademarks are the property of their respective owners.

Contact information

For further information on a product, technology, the most up-to-date version of a document, or your nearest sales office, please visit:
www.renesas.com/contact/.