

RL78/G23

DALI-2 Input Device Basic (103) Sample Application

Introduction

This application note describes a sample application that performs DALI (Digital Addressable Lighting Interface) communication using the RL78/G23 microcontroller.

The sample application operates as an Input Device. The supported DALI standards are as follows:

- IEC 62386-101 Edition2.1 (101ed.2.1 hereafter)
- IEC 62386-103 Edition1.0 (103ed.1.0 hereafter)

The sample application processes Manchester coded DALI signal waveforms by using peripheral functions included in RL78/G23 to implement communication compliant with the standard.

This application note is intended for individuals with knowledge of DALI. For details about the DALI standards, see 6. Reference Documents.

Operation Confirmation Device

RL78/G23

Note: When you apply the sample application to another MCU, modify the sample application according to the MCU's specifications, and then perform appropriate evaluation.
DALI-2 authentication does not test semiconductors or software. Evaluation of the sample application requires an input device capable of DALI-2 authentication.

Contents

1. Overview of Specifications.....	4
2. Operation Confirmation Conditions.....	5
3. Hardware Description.....	6
3.1 System Configuration.....	6
3.2 List of Pins.....	8
4. Software Description.....	9
4.1 How to Set Up the Environment (CC-RL).....	9
4.1.1 Downloading software.....	9
4.1.2 Installing e2 studio.....	9
4.1.3 Installing Renesas Flash Driver RL78 Type 01 for RL78/G23.....	9
4.1.4 Installing EEPROM emulation software RL78 Type01 for RL78/G23.....	9
4.1.5 Installing the DALI Master Controller GUI.....	9
4.1.6 Importing the sample application.....	9
4.1.7 Allocating Renesas Flash Driver and EEPROM emulation software.....	10
4.1.8 How to build the sample application.....	11
4.1.9 How to connect the sample application hardware and setting switches.....	11
4.1.10 How to debug the sample application.....	12
4.2 Setting up the Environment (IAR).....	13
4.2.1 Downloading software.....	13
4.2.2 IAR Embedded Workbench for Renesas RL78.....	13
4.2.3 Installing the DALI Master Controller GUI.....	13
4.2.4 Importing the sample application.....	13
4.2.5 Allocating Renesas Flash Driver and EEPROM emulation software.....	13
4.2.6 How to build the sample application.....	15
4.2.7 How to connect the sample application hardware and setting switches.....	15
4.2.8 How to debug the sample application.....	15
4.3 Overview of Operation.....	16
4.4 Operation procedure.....	18
4.5 Functional Overview.....	20
4.5.1 Functional Block Diagram.....	20
4.5.2 Lower-level driver layer.....	21
4.5.2.1 CGC.....	21
4.5.2.2 PORT.....	22
4.5.2.3 TAU.....	24
4.5.2.4 TRNG.....	24
4.5.2.5 SMS.....	25
4.5.2.6 TML32.....	26

RL78/G23 DALI-2 Input Device Basic (103) Sample Application

4.5.2.7	CTSU	26
4.5.2.8	SAU	27
4.5.2.9	WDT	27
4.5.2.10	RFD	27
4.5.3	Upper-level driver layer	28
4.5.3.1	DALI101 communication driver	28
4.5.3.2	TOUCH	30
4.5.3.3	EES	30
4.5.4	Library layer	30
4.5.5	Application layer	31
4.5.5.1	Allocating Input Device entities	31
4.5.5.2	Input Device application	31
4.5.6	Thresholds and calibration	33
4.5.6.1	Thresholds	33
4.5.6.2	Calibration	38
4.6	Software Structure	44
4.6.1	Folder structure	44
4.6.2	Option byte setting list	45
4.6.3	Flowchart	46
4.6.3.1	Main flow	46
4.6.3.2	Initialization	47
4.6.3.3	Reading NVM	48
4.6.3.4	Start processing	49
4.6.3.5	Input Device task processing	50
5.	Precautions	51
6.	Reference Documents	51
	Revision History	52

1. Overview of Specifications

This application note describes the sample application that implements the Input Device features defined in 103ed1.0. The sample application input device has one instance (Instance Type 0). A touch key is associated with the instance so that pressing the touch key issues an Input Notification Event indicating the touch key status.

An Input Notification Event is a forward frame that notifies the status of the signal processing unit. If you want to perform operation such as lighting control for Control Gears on the DALI subnet, you need to install an application that sends 16-bit forward frames associated with Input Notification Events by using Application Controller on the DALI subnet.

Figure 1-1 Overview of operation of 103ed.1.0 Input Device sample application

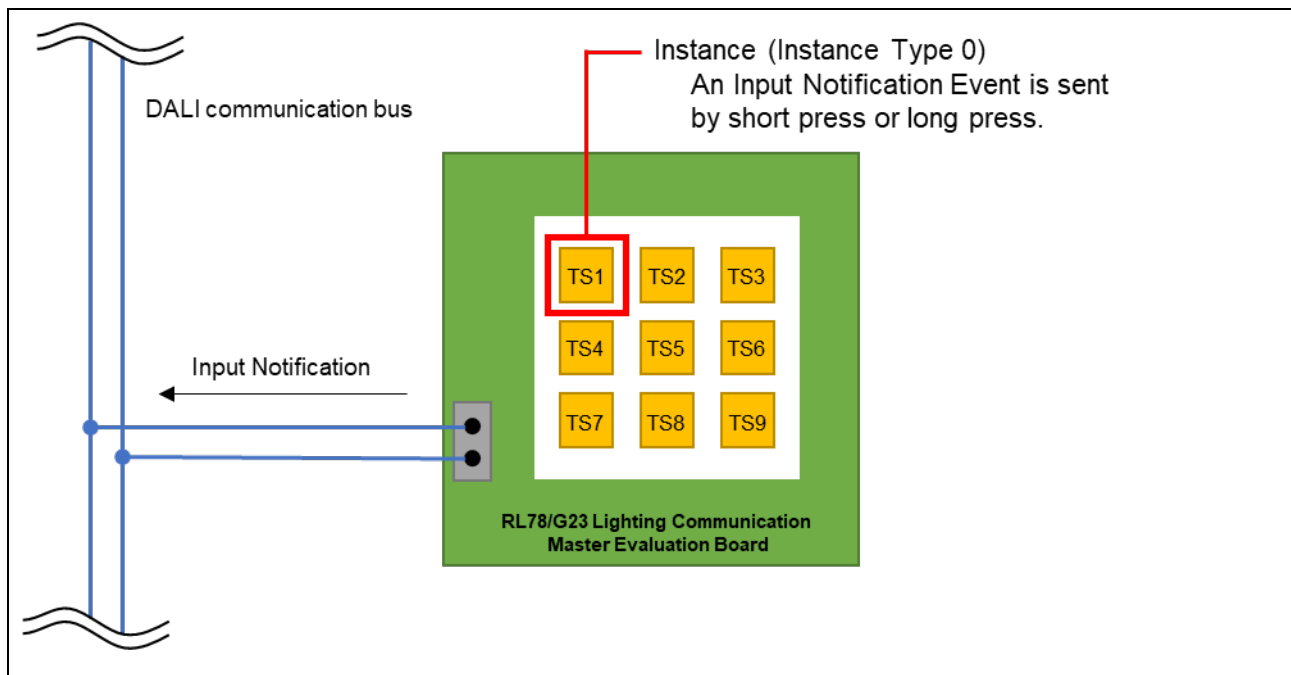

2. Operation Confirmation Conditions

The sample application has been confirmed to operate correctly in the following environment.

Table 2.1 Operating Environment

Item	Description
MCU used	RL78/G23 (R7F100GGG2DFB)
Board used	RL78/G23 Lighting Communication Master Evaluation Board (RTK7RL23LMP00000BJ)
Operation frequency	High-speed on-chip oscillator clock: 32 MHz
Operating voltage	3.3 V
Maximum current consumption (when a DALI command is issued)	31.30 mA
Integrated Development Environment (e2 studio)	From Renesas Electronics Corporation: e2 studio 2022-04
C Compiler (e2 studio)	From Renesas Electronics Corporation: CC-RL V1.11.00
Integrated Development Environment (IAR)	From IAR Systems: IAR Embedded Workbench IDE V8.5.2.7561
C Compiler (IAR)	From IAR Systems: IAR C/C++ Compiler for Renesas RL78 V4.21.4
Library	From Renesas Electronics Corporation: Renesas Flash Driver RL78 Type 01 V1.00 From Renesas Electronics Corporation: EEPROM emulation software RL78 Type01 V1.00 From Renesas Electronics Corporation: DALI103i library Gen2 V1.00 (CC-RL) DALI103i library Gen2 V1.00 (IAR)
Smart Configurator (SC)	V1.3.0 Components used Board Support Package (BSP) V1.20 SNOOZE Mode Sequencer (SMS) V1.0.1 Capacitive Sensing Unit driver (CTSU) V1.20 Touch middleware (TOUCH) V1.20

3. Hardware Description

3.1 System Configuration

The following describes a system configuration example.

The sample application performs input device operations corresponding to RL78/G23 Lighting Communication Master Evaluation Board. The Input Device (a kind of master device in the DALI system) collects information about signal processing units (such as sensors and switches), and then notifies the information to the DALI system.

The DALI system configuration that uses the input device also requires Application Controller and Control Gear.

In this application note, RX65N Cloud Kit+DALI-2 option board or RL78/G23 Lighting Communication Master Evaluation Board is used as the Application Controller, and EZ-0012+EZ-0012 expansion board is used as a Control Gear.

Figure 3-1 System configuration example (using RX65N Cloud Kit + DALI-2 option board)

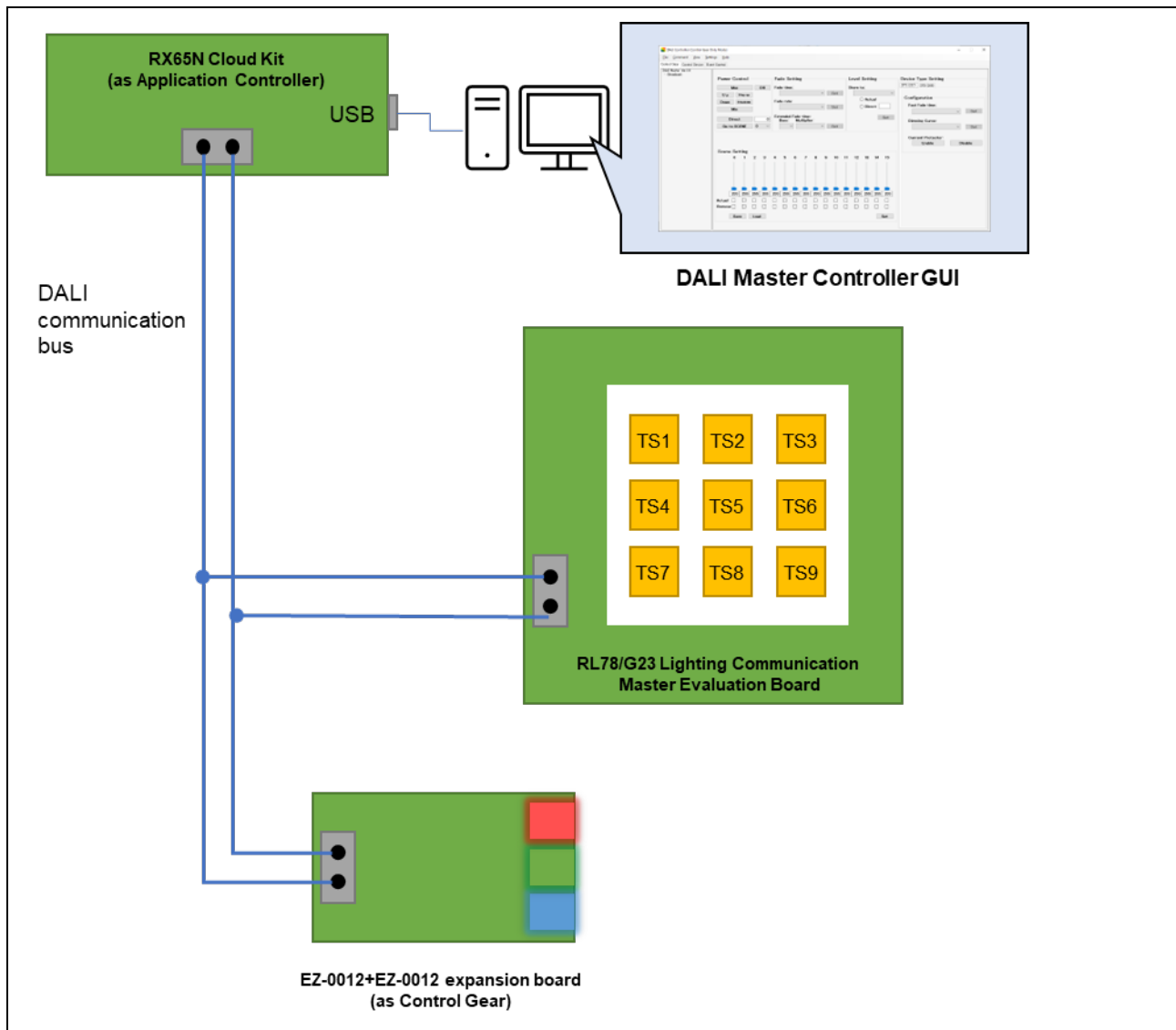
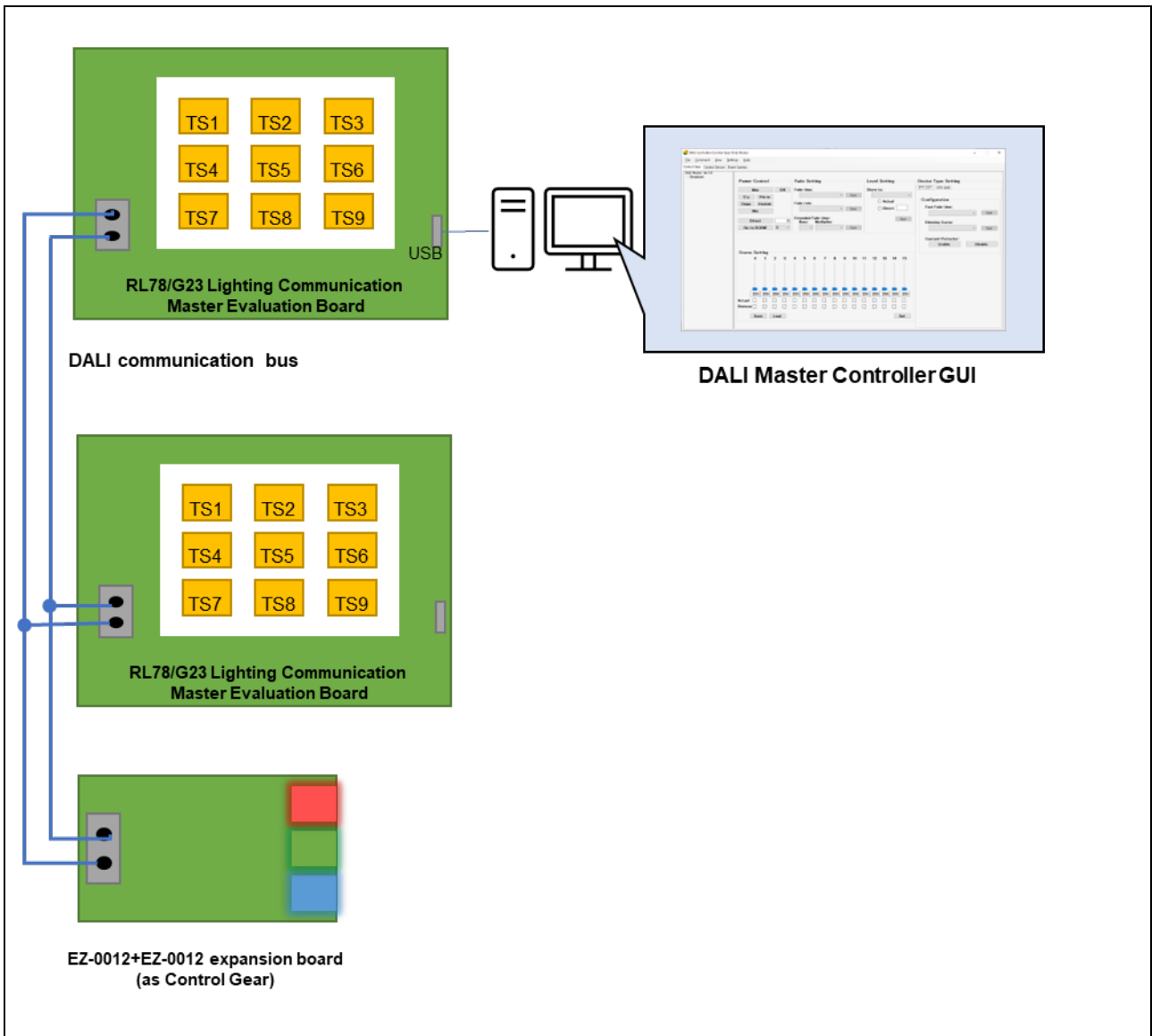

Figure 3-2 System configuration example (using RL78/G23 Lighting Communication Master Evaluation Board)



3.2 List of Pins

The following indicates the pins for use with the sample application and their functions.

Table 3.1 Pins and functions

Pin name	Input/output	Description
P10	Output	DALI communication (transmission)
P16/TI01	Input	DALI communication (reception)
P31/TS01	Output	Touch key scan output 1
P71/TS03	Input	Touch key scan Input 2

For details about other functions related to RL78/G23 Lighting Communication Master Evaluation Board, see the following.

- RL78/G23 Lighting Communication Master Board: Initial Firmware Application Note (R01AN6460)

4. Software Description

4.1 How to Set Up the Environment (CC-RL)

4.1.1 Downloading software

The following software products are required to operate the sample application.

Download them from the website of Renesas Electronics.

- e2 studio
- Renesas Flash Driver RL78 Type 01 for RL78/G23
- EEPROM emulation software RL78 Type01 for RL78/G23
- DALI Master Controller GUI V3.00 or later

4.1.2 Installing e2 studio

e2 studio is required to perform program development and on-chip debugging for the sample application.

For details about installation and other basic operations, see the following user's manual.

- e2 studio 2020-04 and e2 studio v7.8 User's Manual: Getting Started (R20UT4819)

4.1.3 Installing Renesas Flash Driver RL78 Type 01 for RL78/G23

The sample application does not include Renesas Flash Driver. Therefore, you need to download the software from the website of Renesas Electronics, and then register files.

For details about installation, see the following user's manual. For details about how to register files, see 4.1.7.

- Renesas Flash Driver RL78 Type01 for RL78/G23 User's Manual (R20UT4830)

4.1.4 Installing EEPROM emulation software RL78 Type01 for RL78/G23

The sample application does not include EEPROM emulation software. Therefore, you need to download the software from the website of Renesas Electronics, and then register files.

For details about installation, see the following user's manual. For details about how to register files, see 4.1.7.

- EEPROM Emulation Software RL78 Type01 for RL78/G23 User's Manual (R20UT5008)

4.1.5 Installing the DALI Master Controller GUI

The DALI Master Controller GUI is required when evaluating the sample application.

For details about the installation procedure, see the following user's manual.

- DALI Master Controller GUI User's Manual (R20UT0715)

4.1.6 Importing the sample application

1. Unzip and store the provided project file in the desired location (folder).
2. Start e² studio and, in Project Explorer, right-click and then select [Import], or click the [File] tab, and then select [Import].
3. From [General], select [Existing Projects into Workspace], and then click [Next].
4. Select [Select Root Directory], and then from [Browse], select the project file stored in step 1.
5. Select the sample application.
6. Click [End].

4.1.7 Allocating Renesas Flash Driver and EEPROM emulation software

After importing the sample application, store the following files of Renesas Flash Driver and EEPROM emulation software (downloaded from Renesas Electronics) in the following directory.

Table 4.1 Files and folders

\Dali103i_sample<DIR>	
\Library<DIR>	
\RFD<DIR>	This folder stores Renesas Flash Driver (RFD).
\userown	Configured according to this sample application
r_rfd_common_userown.c	
\include	Copy these folders from RFD.
\source	
\EES<DIR>	This folder stores EEPROM emulation software (EES).
\userown	Configured according to this sample application
r_ees_descriptor.c	
r_ees_descriptor.h	
r_ees_user_types.h	
\include	Copy these files from EES.
\source	

4.1.8 How to build the sample application

1. In Project Explorer, right-click the project, and then select [Build Projects].
2. Build starts and the build progress is displayed on Console. When a message "Build Finished" appears, the build is complete.

Note: When regenerating the code by SmartConfigurator, src/smc_gen/r_pincfg directory will be removed from the include file search path. Please add the directory to the project settings again.

4.1.9 How to connect the sample application hardware and setting switches

When operating this sample application, you must configure the jumpers and switches of RL78/G23 Lighting Communication Master Evaluation Board as shown below.

Figure 4-1 RL78/G23 Lighting Communication Master Evaluation Board component

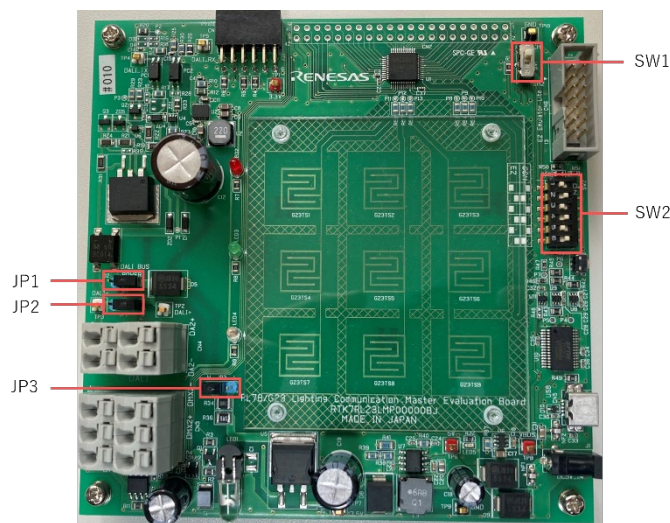



Table 4.2 List of switch settings

JP/SW No.	Setting
JP1	Open
JP2	Open
JP3	Shorted with the H side
SW1	Don't care
SW2-1	OFF
SW2-2	ON
SW2-3	OFF
SW2-4	ON
SW2-5	OFF
SW2-6	ON

4.1.10 How to debug the sample application

1. After importing the sample application with e2 studio, download the program to the MCU by clicking the  button.
2. Select [Run], and then [Debug Configurations...]. The Debugging Configurations window opens.
3. In the Debug Configurations window, expand the display of the debug configuration under "Renesas GDB Hardware Debugging", and then click an existing debug configuration.
4. In [the Debugger] tab, click the [Connection Settings] tab, and then make sure that the settings are specified as shown below.

Note: When using E2 emulator Lite, select [E2 Lite (RL78)] for [Debug hardware].

Figure 4-2 Settings in the Debug window

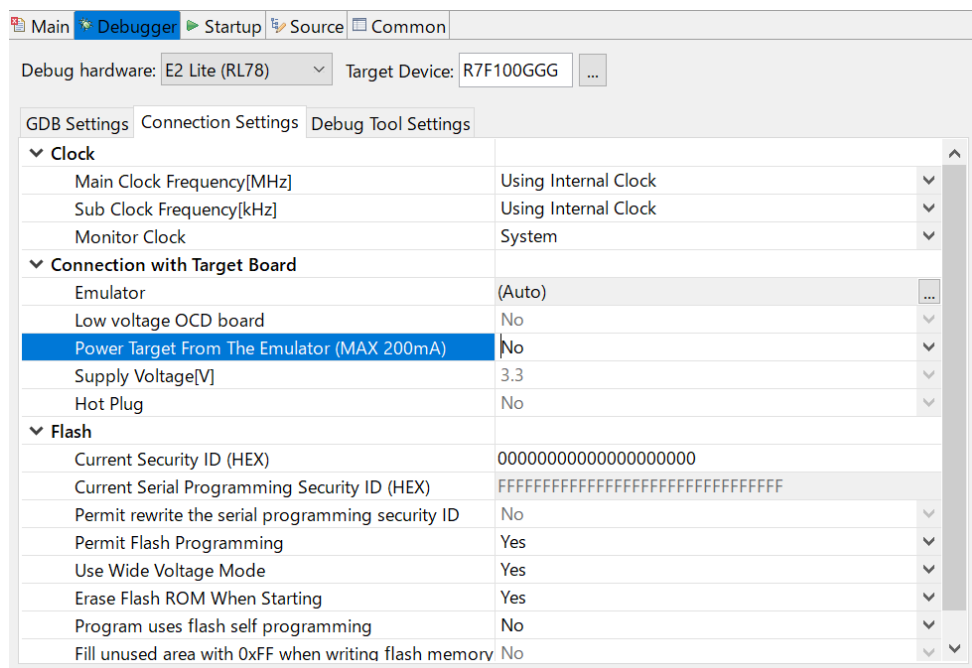

5. Select [Start Debug]. When the [Debug] view appears, debugging is ready.
For details about debugging and other basic operations, see the following user's manual.
 - e2 studio 2020-04 and e2 studio v7.8 User's Manual: Getting Started (R20UT4819)

4.2 Setting up the Environment (IAR)

4.2.1 Downloading software

The following software products are required to operate the sample application.

Download the software from the website of IAR Systems.

4.2.2 IAR Embedded Workbench for Renesas RL78

- IAR Embedded Workbench for Renesas RL78 is required to perform program development and on-chip debugging for the sample application.

For details about installation, see the video at the following link

[Using Smart Configurator in IAR Embedded Workbench for RL78 \(1/2\): Installation](#)

4.2.3 Installing the DALI Master Controller GUI

The DALI Master Controller GUI is required when evaluating the sample application.

For details about the installation procedure, see the following user's manual.

- DALI Master Controller GUI User's Manual (R20UT0715)

4.2.4 Importing the sample application

1. Start IAR Embedded Workbench for Renesas RL78.
2. Click the [File] tab, and then select [New Workspace].
3. From the [File] menu, select [Save Workspace As], and then store the workspace with the name of your choice in the desired location (folder).
4. Unzip and store the provided project file in the workspace (folder) you created.
5. From [Project], select [Add to Existing Project], and then select the project file (EWP file) stored in step 3.
6. From [File], click [End].

4.2.5 Allocating Renesas Flash Driver and EEPROM emulation software

After importing the sample application, store the following files of Renesas Flash Driver and EEPROM emulation software (downloaded from Renesas Electronics) in the following directory.

Table 4.3 Pins and functions

\Dali103i_sample<DIR>		
\Library<DIR>		
\RFD<DIR>		This folder stores Renesas Flash Driver (RFD).
\userown	r_rfd_common_userown.c	Configured according to this sample application
\include		Copy these folders from RFD.
\source		
\EES<DIR>		This folder stores EEPROM emulation software (EES).
\userown		Configured according to this sample application
r_ees_descriptor.c		
r_ees_descriptor.h		
r_ees_user_types.h		
\include		Copy these folders from EES.
\source		

4.2.6 How to build the sample application

1. In the workspace, right-click the project, and then select [Make].
2. Build starts and the build progress is displayed on Console. When the message "Total error count: 0" appears, the build is complete.

4.2.7 How to connect the sample application hardware and setting switches

When operating this sample application, you must configure the jumpers and switches of RL78/G23 Lighting Communication Master Evaluation Board as shown below.

Figure 4-3 RL78/G23 Lighting Communication Master Evaluation Board component

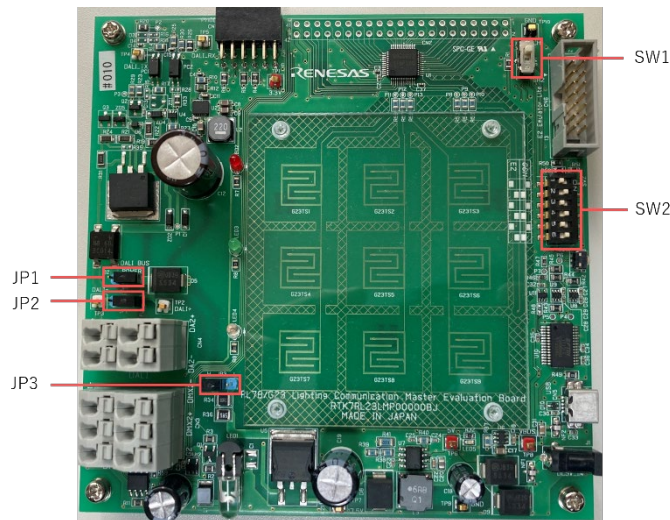



Table 4.4 List of switch settings

JP/SW No.	Setting
JP1	Open
JP2	Open
JP3	Shorted with the H side
SW1	Don't care
SW2-1	OFF
SW2-2	ON
SW2-3	OFF
SW2-4	ON
SW2-5	OFF
SW2-6	ON

4.2.8 How to debug the sample application

1. After importing the sample application with IAR Embedded Workbench for Renesas RL78, download the program to the MCU by clicking the  button.

4.3 Overview of Operation

This section provides an overview of sample application operations.

Figure 4-4 System configuration example (using RX65N Cloud kit + DALI-2 option board)

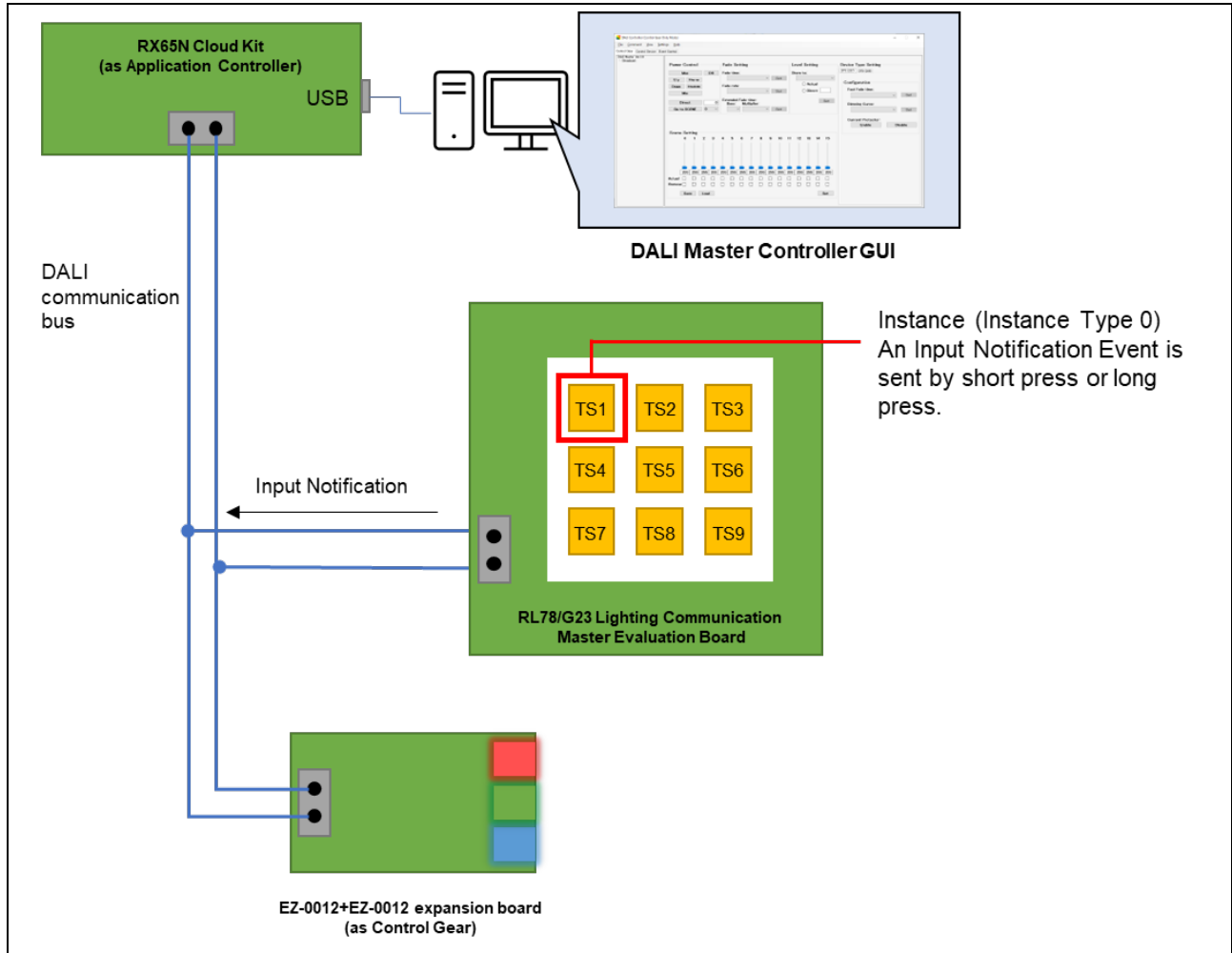

This sample application operates as an input device in the DALI standard. The sample application input device has one instance (Instance Type 0). Each instance is associated with a touch key, and an Input Notification Event is sent to the DALI communication bus depending on how the touch key is pressed. Table 4.5 shows Correspondence between the instance and touch key.

Table 4.5 Correspondence between the instance and touch key

Instance Number	Resolution (bit)	Input Signal	Associated touch key
0	1	0 : Not pressed, 1: Pressed	TS1

In addition, event information for the instance with Instance Type 0 is not defined in the DALI standard. Therefore, the following event information is defined as the original implementation of this sample application so that an Input Notification Event is generated when one of the following event conditions is satisfied.

Table 4.6 Event Information list

Event Information		Event condition
Event details	Event Info value (binary)	
Short press	00 0000 0001	An event is generated when the pressed state changes to unpressed state after less than 500 [ms].
Long press	00 0000 0010	An event is generated when the pressed state continues for at least 500 [ms]. After that, the event is generated every 200 [ms] as long as the pressed state continues.

Note that processing corresponding to Event Messages issued by the sample application input device (such as sending a dimming instruction command for a Control Gear) must be implemented in Application Controller on the same DALI subnet.

4.4 Operation procedure

This section describes the procedure for operating the sample application by using the DALI Master Controller GUI.

The following provides an example of using the RX65N Cloud kit + DALI-2 option board as Application Controller.

When using RL78/G23 Lighting Communication Master Evaluation Board as Application Controller, connect the devices by referring to 3.1. Connect the AC adapter to the RX65N Cloud kit + DALI-2 option board and specify the settings to ensure that sufficient power is supplied to the DALI bus.

Figure 4-5 System configuration example (using RX65N Cloud kit + DALI-2 option board)

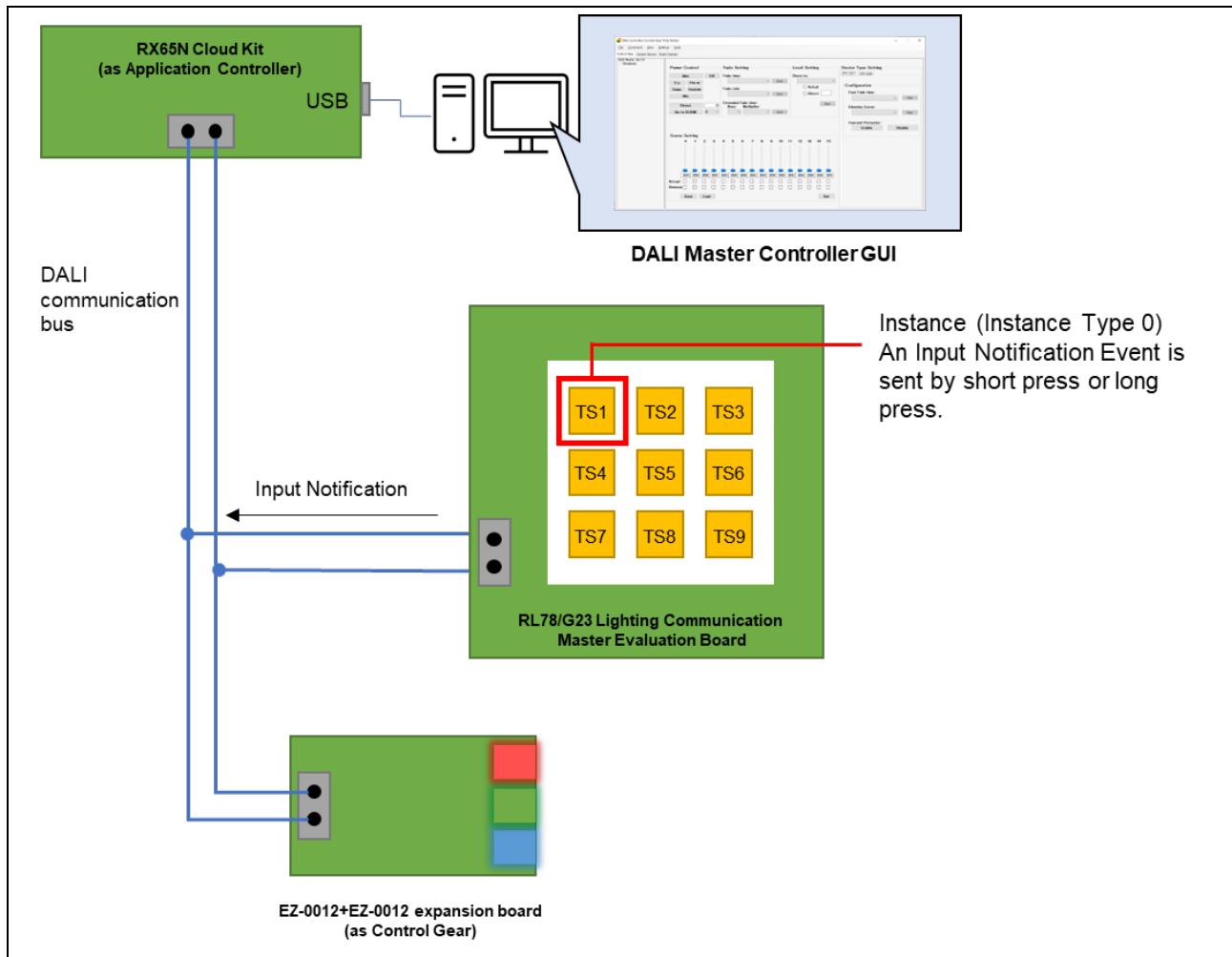

[Procedure]

1. Connect the RX65N Cloud kit + DALI-2 option board or RL78/G23 Lighting Communication Master Evaluation Board as Application Controller and the EZ-0012+EZ-0012 expansion board. Supply power to each device.
2. After building the sample application, download the program from the debugger to RL78/G23 Lighting Communication Master Evaluation Board, and then perform debugging.
3. Start the DALI Master Controller GUI, and then connect it to the RX65N Cloud kit + DALI-2 option board.
4. On the [Control Device] tab of the DALI Master Controller GUI, assign a short address, group number, and instance group number to RL78/G23 Lighting Communication Master Evaluation Board.
5. Select the [Event Control] tab of the DALI Master Controller GUI.
6. Short-press [TS1] of RL78/G23 Lighting Communication Master Evaluation Board (for less than 500 [ms]).
7. An event message is automatically registered in "Receive Event" on the [Event Control] tab of the DALI Master Controller GUI. Click the [Setting] button, and then specify the send frame for the received event message. (A)
8. Press and hold [TS1] of RL78/G23 Lighting Communication Master Evaluation Board (for at least 500 [ms]).
9. An event message is automatically registered in "Receive Event" on the [Event Control] tab of the DALI Master Controller GUI. Click the [Setting] button, and then specify the send frame for the received event message. (B)
10. Select all [Enable] check boxes on the [Event Control] tab of the DALI Master Controller GUI.
11. Short-press [TS1] of RL78/G23 Lighting Communication Master Evaluation Board (for less than 500 [ms]).
The DALI command specified in (A) is issued from the DALI Master Controller GUI to the EZ-0012+EZ-0012 expansion board.
12. Press and hold [TS1] of RL78/G23 Lighting Communication Master Evaluation Board (for at least 500 [ms]).
The DALI command specified in (B) is issued from the DALI Master Controller GUI to the EZ-0012+EZ-0012 expansion board.

4.5 Functional Overview

4.5.1 Functional Block Diagram

The following indicates the functional block diagram of the sample application.

Figure 4-6 Functional block diagram

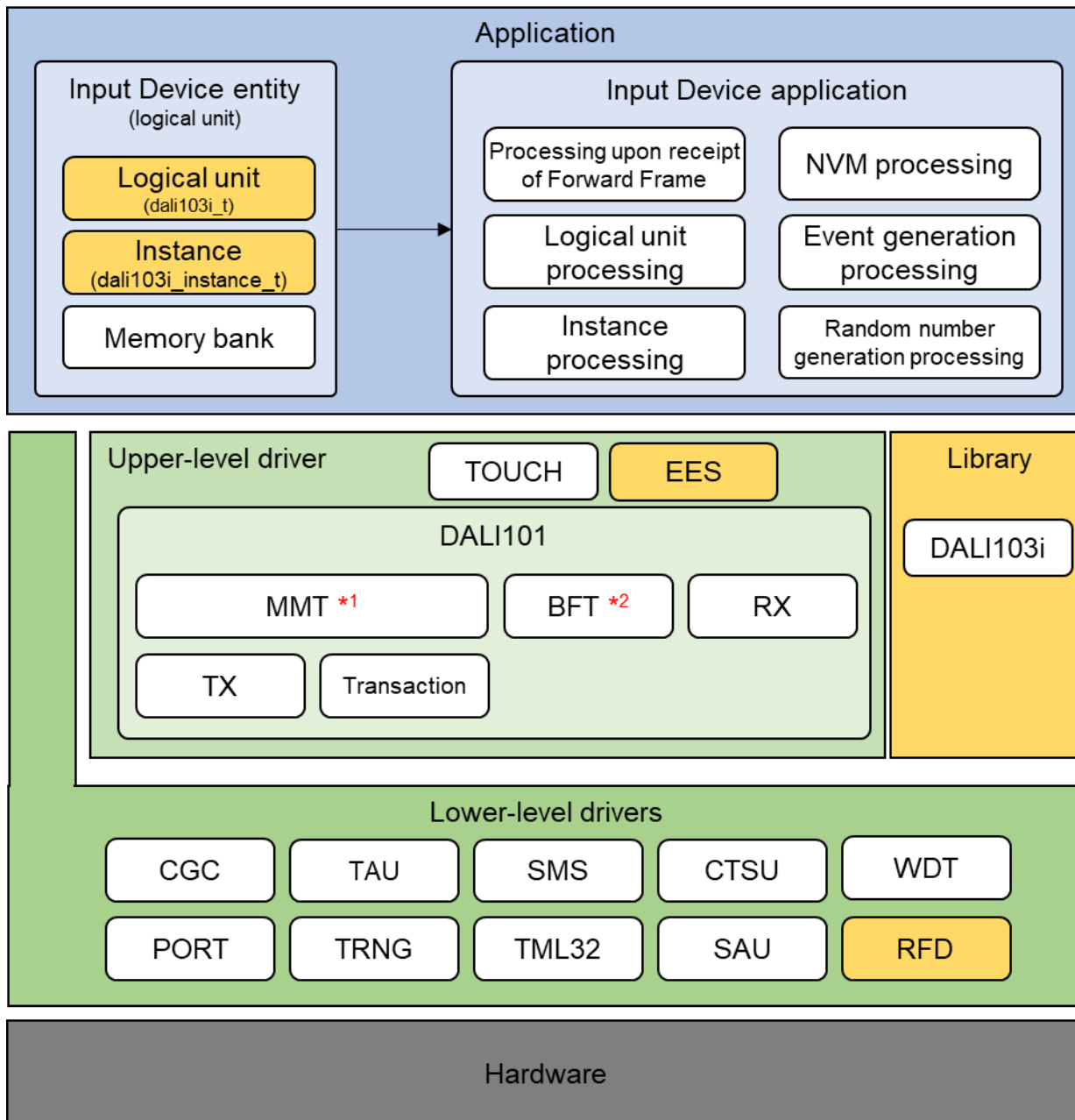

Notes: 1. MMT: Multi Master Transmitter
 2. BFT: Backward Frame Transmitter

4.5.2 Lower-level driver layer

A simple driver layer using RL78/G23 peripheral functions

4.5.2.1 CGC

A driver that generates clock signals. In this sample application, the following settings are specified by using the Smart Configurator (SC).

Figure 4-7 Clock settings

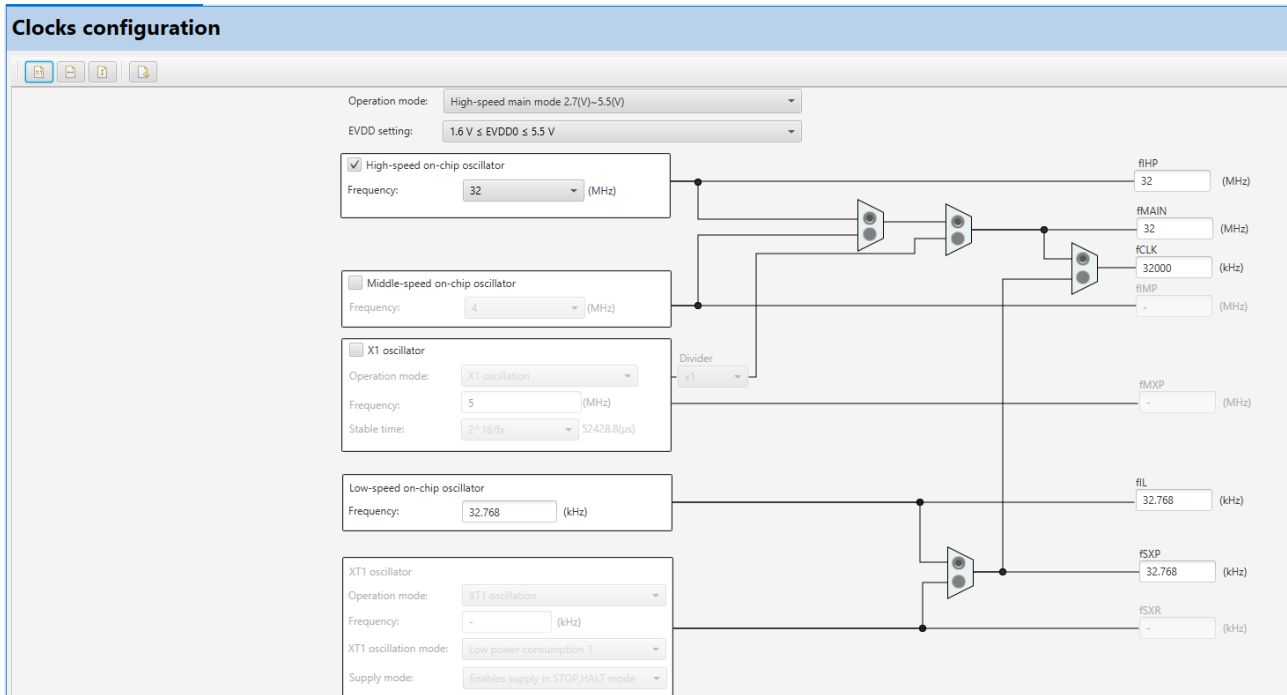

4.5.2.2 PORT

A driver that controls the ports of the RL78/G23 MCU. In this sample application, drivers that can control all ports of the mounted MCU are implemented and called as necessary.

Table 4.7 Port settings

Items	Input/output	Usage
P01/RxD1	Input	For DMX512
P00/TxD1	Output	For DMX512
P10	Output	For DALI transmission
P11	Input	For debugger connection
P12	Output	For debugger connection
P13	Output	Unused
P14	Output	Unused
P15	Output	Unused
P16/TI01	Input	For DALI reception (input pulse width measurement)
P17	Output	Unused
P20	Output	DMX512
P21	Output	PMOD
P22	Output	PMOD
P23	Output	PMOD
P24	Output	PMOD
P25	Input	Unused
P26	Output	Unused
P27	Output	Unused
P30	Input	Unused
P31/TS01	Output	Touch key scan output 1
P40/TOOL0	Input	For debugger connection
P41/TO07	Output	Unused
P50/TS00	Input	Touch key scan input 3
P51	Output	Unused
P60/SCLA0	Output	PMOD
P61/SDAA0	Output	PMOD
P62	Output	LED (red)
P63	Output	LED (green)
P70/TS02	Input	Touch key scan input 2
P71/TS03	Input	Touch key scan input 1

P72/TS04	Output	LED (white)
P73/TS05	Output	Unused
P74/TS06	Output	Touch key scan output 3
P75/TS07	Output	Touch key scan output 2
P120	Output	Unused
P121	Output	Unused
P122	Output	Unused
P123	Input (input-only port)	Unused
P124	Input (input-only port)	Unused
P130	Output (output-only port)	Unused
P137//INTP0	Input (input-only port)	Unused
P140	Output	Unused
P146	Output	Unused
P147	Output	Unused
RESET	-	Unused
REGC	-	Unused
VSS	-	Unused
VDD	-	Unused

4.5.2.3 TAU

A driver for timer control by using a timer array unit. In this sample application, the channels are configured as follows according to the application.

Table 4.8 Timer array unit settings

Channel	Setting	Interrupt priority	Usage
TAU0 CH0	Interval timer (1 ms)	Interrupts not used	Synchronization of 1 ms periodic processing of the application
TAU0 CH1	Input pulse width measurement	Priority 0	Pulse width measurement of the DALI RxD pin
TAU0 CH2	Interval timer (50 us)	Priority 1	DALI RxD pin's Idle/Active state continuation time measurement
TAU0 CH3	Interval timer (1458 us)	Priority 3	Corrupted Backward Frame's Active State send time
TAU0 CH4	Interval timer (optional)	Priority 3	For processing when a collision occurs - tBreak Active State send time (1200-1400 us) - Loop-back time until the waveform sent from the DALI TxD pin is received at the DALI RxD pin (50 ms)
TAU0 CH5	Unused	-	-
TAU0 CH6	Unused	-	-
TAU0 CH7	Unused	-	-

4.5.2.4 TRNG

A drive that uses a true random number generator.

4.5.2.5 SMS

A driver that uses SNOOSE Mode Sequencer (hereafter SMS). This sample application uses SMS for modulation of DALI transmission. The following settings are specified by using Smart Configurator (SC).

Figure 4-8 SMS settings

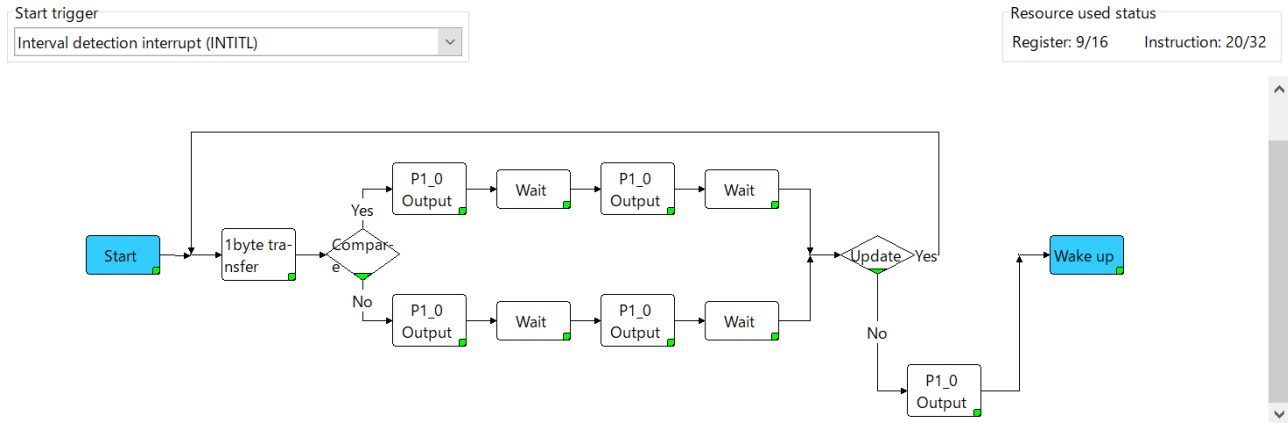

The following describes the specifications of processing that is performed with the above settings.

Table 4.9 SMS settings

Overview	DALI waveform output processing by SMS
Description	<ol style="list-style-type: none"> SMS is started by an INTITL interrupt. Each bit of data is checked based on the argument to send a waveform appropriate for the data. <ul style="list-style-type: none"> Bit data == 0: Output to P10 (DALI TxD pin) in the order of 1 and 0 with the Wait time width Bit data == 1: Output to P10 (DALI TxD pin) in the order of 0 and 1 with the Wait time width When all data is sent, P10 port output is set to High and an SMS end interrupt (INTSMSE) is generated by the Wakeup function.
Arguments	address_d: Send data start address address_e: Send data end address
Return value	None
Remarks	The bit width of the waveform that is output based on the DALI TxD pin varies depending on the rising or falling delay in the DALI communication circuit of the MCU. Adjustment is required so that the waveforms output to the DALI communication bus comply with the standard. Perform adjustment by referring to (1) Transmission Half bit width.

4.5.2.6 TML32

A driver that uses a 32-bit interval timer. In this sample application, the channels are configured as follows in 4-channel 8-bit counter mode according to the application.

Table 4.10 32-bit interval timer settings

Channel	Setting	Interrupt priority	Usage
TML32 CH0	Interval timer (16 us)	Interrupts not used	SMS start trigger
TML32 CH1	Unused		-
TML32 CH2	Unused		-
TML32 CH3	Unused		-

4.5.2.7 CTSU

A driver that uses a capacitive sensor unit. In this sample application, the following settings are specified by using Smart Configurator (SC).

Figure 4-9 CTSU settings

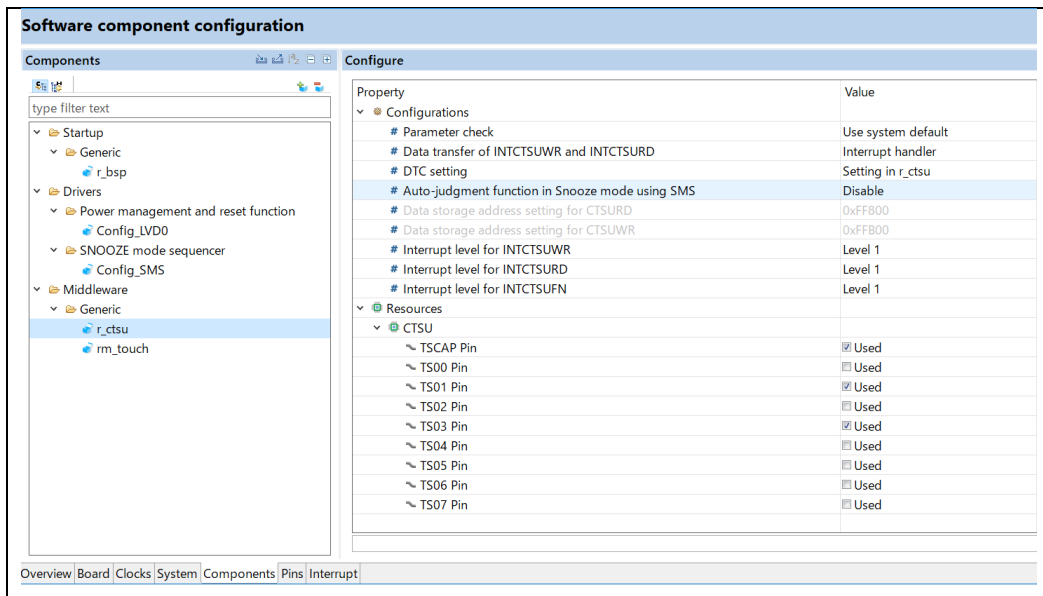

4.5.2.8 SAU

A driver that uses a serial array unit.

4.5.2.9 WDT

A driver that uses a watchdog timer. This driver restarts the watchdog timer.

For details about the watchdog timer settings, see 4.6.2 Option byte setting list.

4.5.2.10 RFD

A driver that reads to and writes data from data flash of RL78/G23. This sample application uses Renesas Flash Driver from Renesas Electronics.

For details, see the *Renesas Flash Driver RL78 Type01 for RL78/G23 User's Manual (R20UT4830)*.

4.5.3 Upper-level driver layer

The upper-level driver is an advanced driver implemented by combining lower-level drivers.

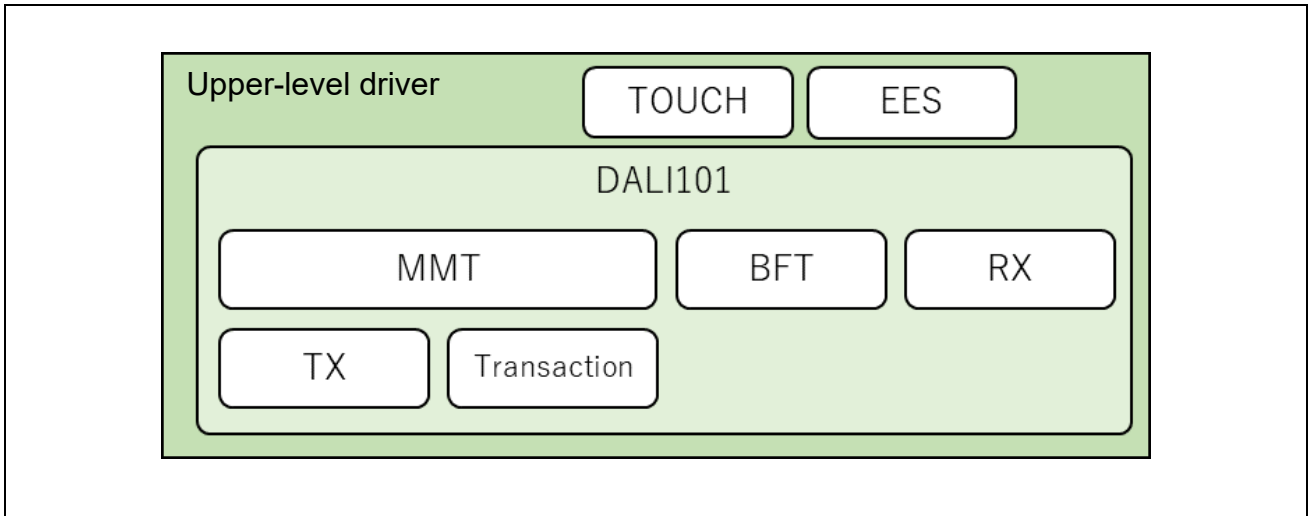

4.5.3.1 DALI101 communication driver

The DALI communication driver of this sample application has the following configuration.

Figure 4-10 Configuration of the DALI101 communication driver

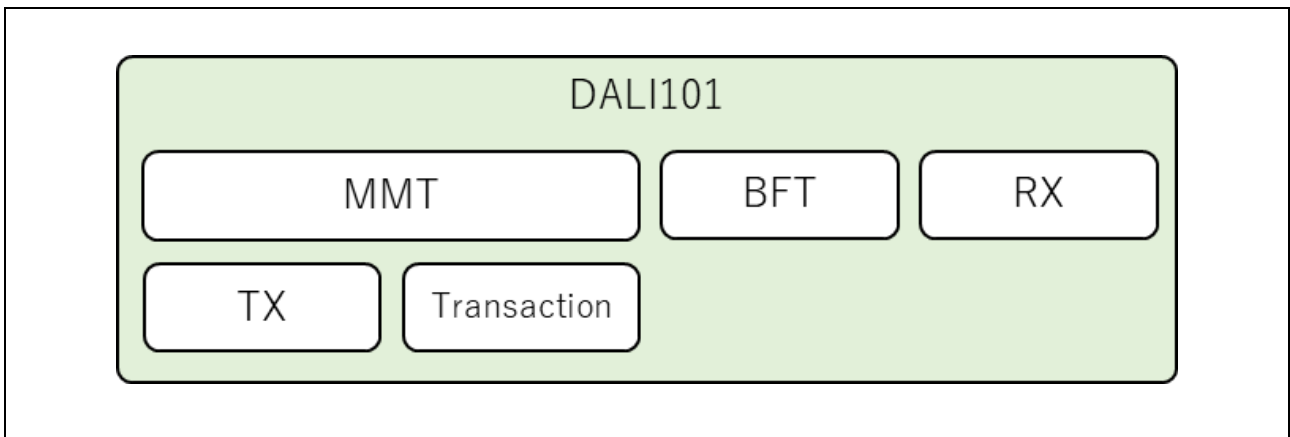

(1) DALI101

A group of API functions of the DALI101 communication driver.

In this module, implement a function that acquires the status of the DALI RxD pin (RxD level continuation time and receive bit width) and passes the status to the MMT and RX described later.

- Measurement of the DALI RxD level continuation time

Start or restart of the 50-us interval timer (timer array unit 0, channel 2) is triggered by an edge detection of the DALI RxD pin. The continuation time of the RxD level (High/Low) is measured by adding 50 us to the continuation time with the interrupt handler of this timer.

- Measurement of the DALI RxD receive bit width

The receive bit width at the DALI RxD pin is measured by using the input pulse interval measurement function of the timer array unit.

However, each measured time is based on the MCU pin standard and varies depending on the rising or falling delay in the DALI communication circuit outside the MCU. This might cause an error in the acquisition time. Therefore, considering the delay in the DALI communication circuit, data is corrected before being passed to MMT and RX.

For details about corrections and thresholds, see 4.5.6 Thresholds and calibration.

In addition, a function that wraps MMT, BFT, and RX functions is implemented.

(2) Multi-Master Transmitter (MMT)

A module that implements DALI Multi-Master Transmitter regulations.

This module starts sending a user-registered DALI Frame with the settling time appropriate for the priority. It also checks the loop-back receive data being sent to see if no collision occurred.

If a collision occurs, the module stops transmission and performs appropriate recovery processing.

(3) Backward Frame Transmitter (BFT)

A module for sending a Backward Frame.

This module sends a valid 8-bit Backward Frame by using Transmitter (TX) (described later). It also sends a Corrupted Backward Frame by setting the DALI TxD pin to Low output for 1.458 ms and then setting it back to High output.

Note that a Corrupted Backward Frame is generated by collision of multiple Backward Frames. When DALI equipment contains multiple logical DALI devices with different Backward Frame data contents, the Backward Frames of those devices are consolidated and sent as a Corrupted Backward Frame.

(4) Receiver (RX)

A module that implements DALI Receiver regulations.

The DALI RxD receive bit width and bit level (High/Low) received from the upper-level driver DALI101 are sequentially stored in the ring buffer. Then, a Stop Condition or System Failure is detected based on the DALI RxD level continuation time.

When a Stop Condition is detected, this module determines that frame reception is complete, and checks whether the frame satisfies the DALI standard based on the bit width and bit level (High/Low) information currently stored in the ring buffer.

RL78/G23 DALI-2 Input Device Basic (103) Sample Application

If the frame is normal, information including whether the same frame was received within the preceding 100 ms is provided.

(5) Transaction (TRANSACTION)

A Frame transmission buffer module that contains the transaction specifications (frame group consisting of a meaningful series of frames)

(6) Transmitter (TX)

A module that sends a frame of up to 32 bits by using SMS and TML32.

4.5.3.2 TOUCH

This is middleware that handles a touch key. In this sample application, the following settings are specified by using Smart Configurator (SC).

Figure 4-11 TOUCH settings

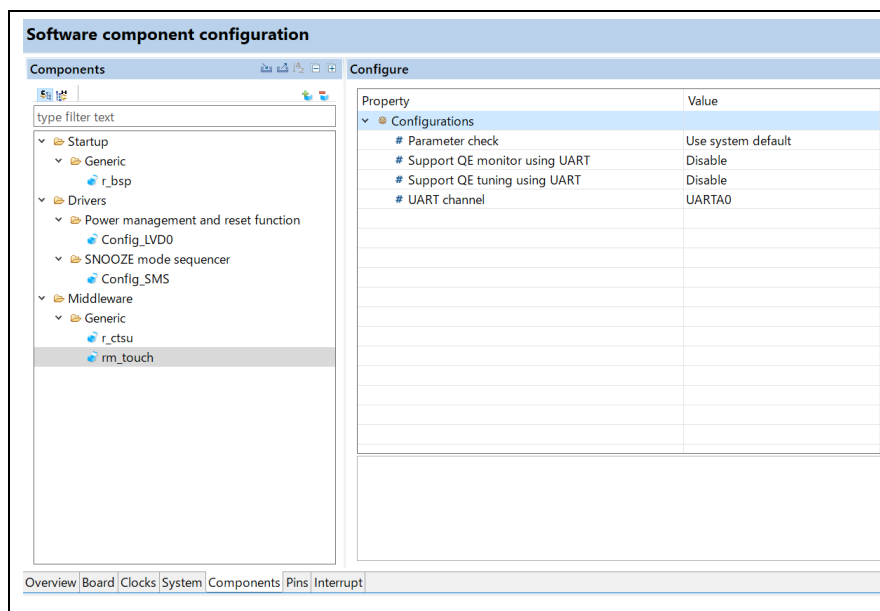

4.5.3.3 EES

This is software for performing EEPROM emulation by using the data flash of RL78/G23. This sample application uses EEPROM emulation software from Renesas Electronics.

For details, see the *EEPROM Emulation Software RL78 Type01 for RL78/G23 User's Manual (R20UT5008)*.

4.5.4 Library layer

The DALI103i library is used as an Input Device library in DALI communication.

4.5.5 Application layer

4.5.5.1 Allocating Input Device entities

Allocate an entity of the instance and logical unit according to the Input Device specifications. In this sample application, the elements required for one logical unit are collected into one structure before the entity is allocated.

4.5.5.2 Input Device application

(1) Processing when receiving a Forward Frame

The application analyzes the received Forward Frame, executes commands, and sends a Backward Frame.

(2) Logical unit processing

This sample application is a single logical unit. If more than 32 instances are required, multiple logical units can be implemented.

(3) Instance processing

The application performs processing of the signal processing unit. Implement the processing according to the signal processing unit to be used.

This sample application uses touch keys.

(4) NVM processing

The application performs data flash save processing. This processing is implemented in the EES and RFD libraries in this sample application.

(a) Auto save

For NVM variables of the DALI standard, the status must be saved at last 30 seconds before the power is turned off. Therefore, this sample application automatically saves data every seconds if any NVM variable is changed. If you want to reduce the number of writes to the data flash, reduce the frequency of saving data or specify the setting so that data is written only when a power-off is detected.

(b) Auto save

If you want to explicitly save NVM variables, issue the SAVE PERSISTENT VARIABLES command from the Application Controller.

All NVM variables must be saved within 300 ms after this command is received.

(5) Event processing

(a) POWER NOTIFICATION

An event that notifies that the power is turned on again.

Send this event at a random timing from 1.3 s to 5 s after power supply to the Input Device starts.

(b) INPUT NOTIFICATION

An event can be issued according to the status of the signal processing unit. Instance Types 1 to 31 can be implemented according to the corresponding standards (from 301 to 331). When Instance Type 0 is implemented, the user must define the specifications.

(6) Random number generation processing

The application generates random numbers used in the DALI103i library. The generated random numbers must satisfy the following conditions:

- The random numbers are generated in the range from 0x000000 to 0xFFFFFE.
- If generation is repeated at least the number of logical units, the same value is not generated.

Note: When implementing pseudo random numbers, use seed values as true random numbers.

4.5.6 Thresholds and calibration

When performing DALI communication, correction of the transmission/reception range might be required if the rising or falling delay is large in the DALI communication circuit outside the MCU.

4.5.6.1 Thresholds

The IEC62386-101 ed2.0 standard contains the bit width specifications for data sent and received with DALI. The specifications also contain the definition of a Grey area. A Grey area is used to determine thresholds to separate adjacent areas (such as valid half bit and Destroy area), and can exist anywhere within the relevant area.

This section describes how to set thresholds in the sample application for the logical bit definition table defined in the standard. For details about the definitions, also see the IEC62386-101 ed.2.0 standard.

(1) Prerequisite knowledge

The bit width of the DALI waveform is largely classified into two area types.

On the basis of the intermediate edge used for determining data values in Manchester coding, a half bit before the edge is called "starting at the beginning of a logical bit" (blue arrow in Figure 4-12), and a half bit after the edge is called "starting at an edge inside of a logical bit" (orange arrow in Figure 4-12).

The DALI standards define the separate time specifications for each of these two areas.

Figure 4-12 Logical bit determination criteria

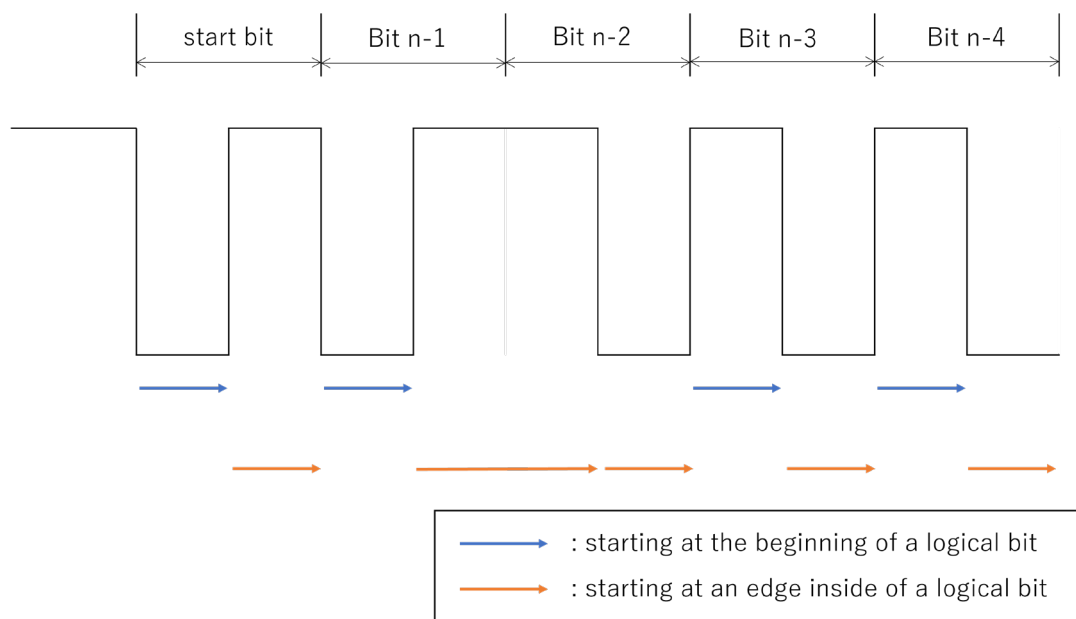

(2) Grey areas in Multi-master Transmitter

The DALI device containing the Multi-master driver performs the following bit timing check for the loop-back reception result of the sent Forward Frame, and performs processing according to the check results.

The bit timing check is based on Table 23 and Table 24 of the ICE62386-101 ed2.0 standard. The results of the bit timing check are categorized into the following, and the corresponding operation must be performed.

Table 4.11 bit timing check results and process according to the check results

bit timing check results	process
valid half bit	If the transmitted bit width is valid half bit, it is regarded as normal reception and transmission continues. Otherwise, detect collision, stop transmission and return to collision avoidance.
2 valid half bit	If the transmitted bit width is 2 valid half bit, it is regarded as normal reception and transmission continues. Otherwise, detect collision, stop transmission and return to collision avoidance.
Grey area	Detect collision, stop transmission and return to collision avoidance.
Destroy area	Detect collision, stop transmission and execute collision break.

However, it is necessary to separate the gray areas in Table 23 and Table 24 into "grey area" and "area to extend adjacent area". In this case, the "area to extend the adjacent area" should be set to **the uncertain time** of the receive delay generated through the DALI circuit(e.g., individual differences in the elements that make up the circuit). For detailed specifications on uncertain time, please refer to Clarifications & Recommendations for IEC 62386 provided by DiiA.

The Grey area rule that separates the valid half bit (valid half bit, 2 valid half bit) from the Destroy area and its settings in this sample application are as follows.

Figure 4-13 Definition in the standard for Multi-master Transmitter and the sample application setting (starting at the beginning of a logical bit)

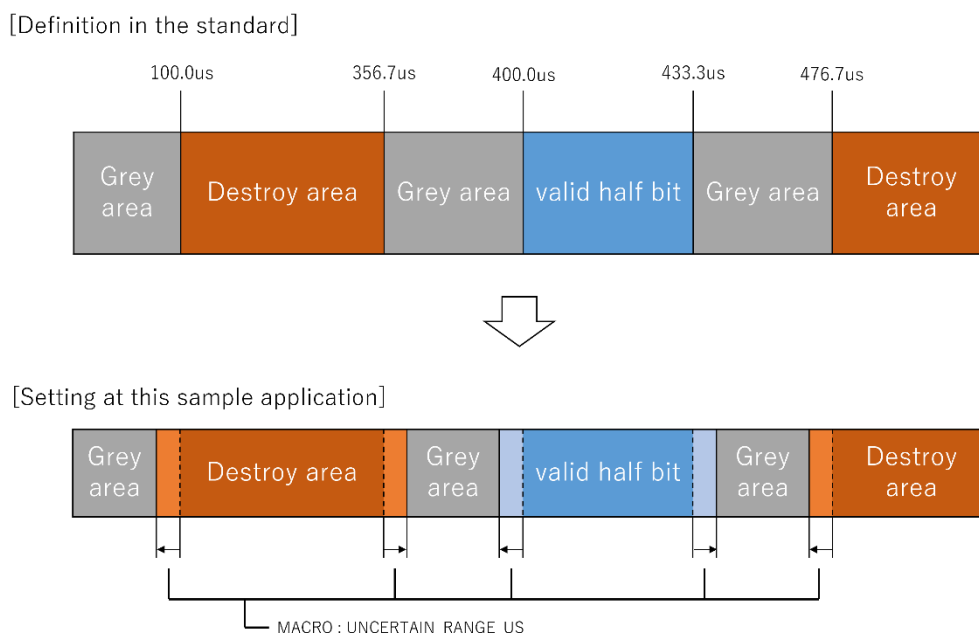
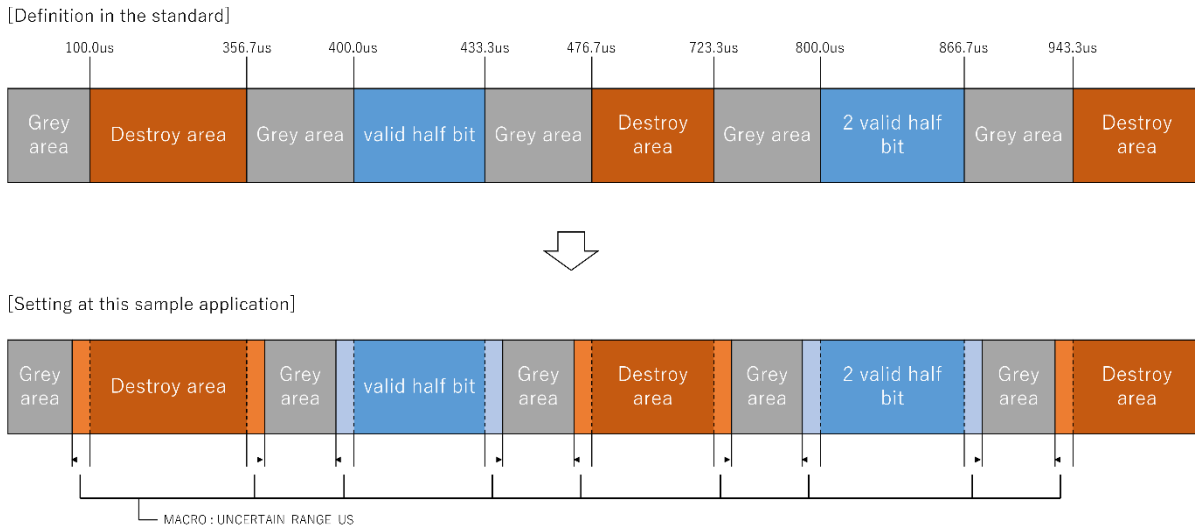

Figure 4-14 Definition in the standard for Multi-master Transmitter and the sample application setting (starting at an edge inside of a logical bit)



In this case, UNCERTAIN_RANGE_US are macros defined in r_dali101_mmt.c, and the thresholds can be changed in the sample application according to the macro settings.

Adjust the values of UNCERTAIN_RANGE_US macros within the range of a Gray area defined in the standard.

Table 4.12 Multi-master Transmitter threshold setting macros

Macro name	Description
UNCERTAIN_RANGE_US	the uncertain time of reception delay time generated through DALI circuit [us]

(3) Grey areas in the Receiver

The DALI device containing the Receiver driver performs the following bit timing check on the received DALI frames, and if there is a bit timing violation, it will be detected as an invalid frame. Also, if it is a stop condition, it detects the end of the received frame.

The following indicates the definition of Grey areas that separate valid half bit areas (half bit or 2 half bit) from Bit timing violation/Stop condition areas and the setting in this sample application.

Figure 4-15 Definition in the standard for Receiver and the sample application setting (starting at the beginning of a logical bit)

[Definition in the standard]

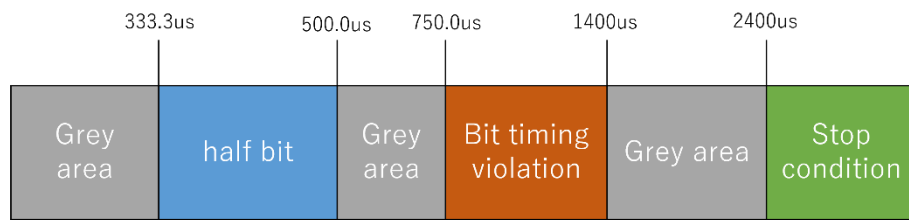

[Setting at this sample application]

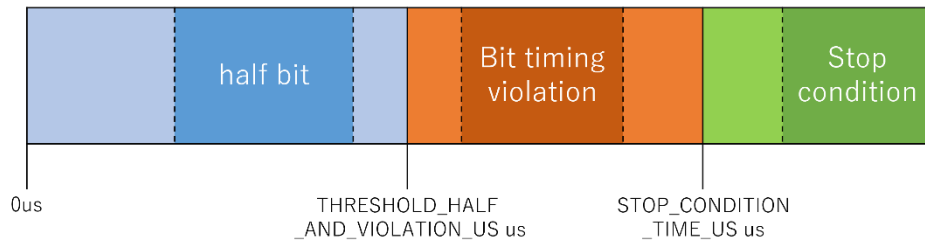
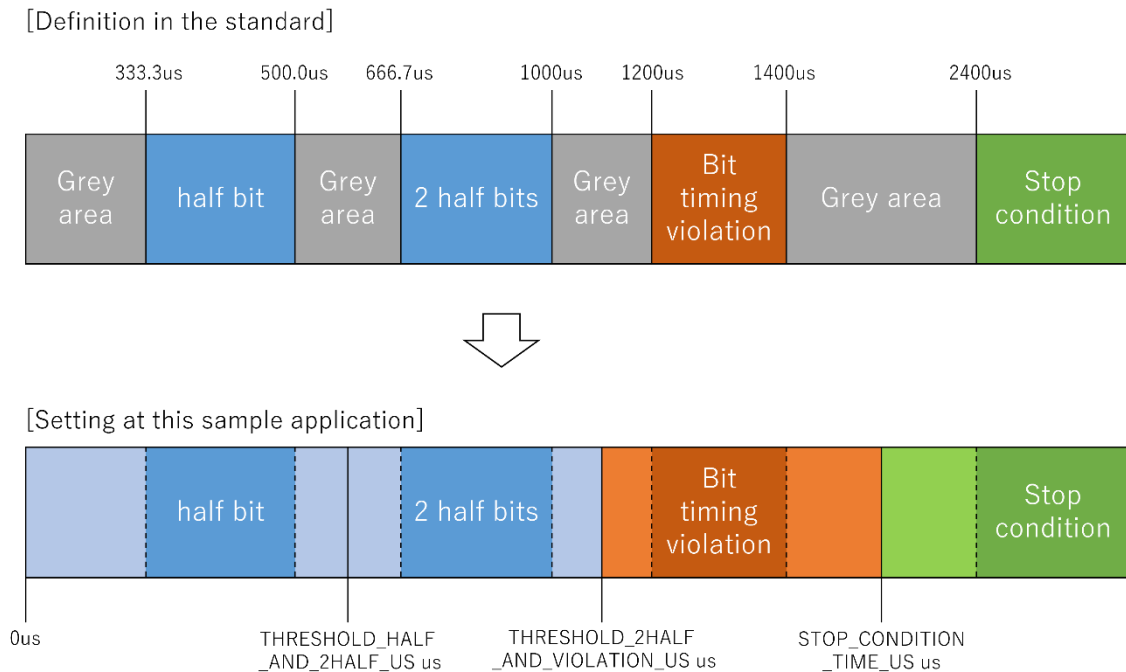

Figure 4-16 Definition in the standard for Receiver and the sample application setting (starting at an edge inside a logical bit)



In this case, THRESHOLD_HALF_AND_VIOLATION_US, THRESHOLD_HALF_AND_2HALF_US and THRESHOLD_2HALF_AND_VIOLATION_US are macros defined in r_dali101_rx.c, and the thresholds can be changed in the sample application according to the macro settings. The whole Gray area at the left end of the valid half bit area is assumed as a valid half bit area in this sample application. The Grey area on the left end of the half bit treat to half bit in this sample application.

Adjust the values of macros within the range of a Gray area defined in the standard.

In addition, the thresholds of the Grey area between the Bit timing violation area and Stop condition area can be changed by using the STOP_CONDITION_TIME_US macro defined in r_dali101_common.h.

Table 4.13 Receiver threshold setting macros

Macro name	Description
THRESHOLD_HALF_AND_VIOLATION_US	Threshold to split between half bit and bit timing violation at starting at the beginning of a logical bit [us]
THRESHOLD_HALF_AND_2HALF_US	Threshold to divide between half bit and 2 half bit at starting at an edge inside of a logical bit [us]
THRESHOLD_2HALF_AND_VIOLATION_US	Threshold to split between 2 half bit and bit timing violation at starting at an edge inside of a logical bit [us]
STOP_CONDITION_TIME_US	Stop condition detection time [us] with the threshold between Bit timing violation and Stop condition Note: The setting must be specified in 100 us units due to convenience of implementation.

4.5.6.2 Calibration

This section provides an example of calibration using an oscilloscope.

(1) Transmission Half bit width

This sample application sends DALI data by using SMS. The Low/High width of the Half bit to be sent is specified with the Wait instruction of SMS. Therefore, the value of this Wait instruction is the target of correction.

Because this sample application is a DALI driver containing Multi-Master Transmitter, the bit width must be within the range indicated in Table 4.14 Multi-master Transmitter bit Timing.

Table 4.14 Multi-master Transmitter bit Timing

Description	Minimum	Typical	Maximum
Half bit	400.0 μ s	416.7 μ s	433.3 μ s

The following describes the calibration procedure.

[Procedure]

1. Download and execute the sample application.
2. Connect the RX65N Cloud kit + DALI-2 option board (connected with the DALI Master Controller GUI) and RL78/G23 Lighting Communication Master Evaluation Board by using DALI, and then turn on the power.
3. Use two channels of the oscilloscope to configure the connection as follows.

Table 4.15 Oscilloscope connection settings (for adjustment of the transmission Half bit width)

Channel	Connection destination	Setting
Channel 1	TP4 (DALI TxD pin) on the target board	Voltage range: 2 V/div
Channel 2	DALI communication bus	Voltage range: 5V/div
Other settings		
<ul style="list-style-type: none"> • The recommended time range is approximately 100 us/div. • Channel 1 must be configured so that a trigger occurs around the falling 1.65 V. 		

4. Send the QUERY RESET STATE command from the DALI Master Controller GUI in Broadcast mode.
5. Measure the two points from the channel 2 waveform obtained by triggering.
 - (1) Low width: From the falling 8 V point to the rising 8 V point
 - (2) High width: From the rising 8 V point to the falling 8 V point
6. Change the Wait time of SMS so that the measurement results for Low and High values in Table 4.14 are close to the Typical value.

Figure 4-17 Transmission Half-bit waveform measurement result (Low width)

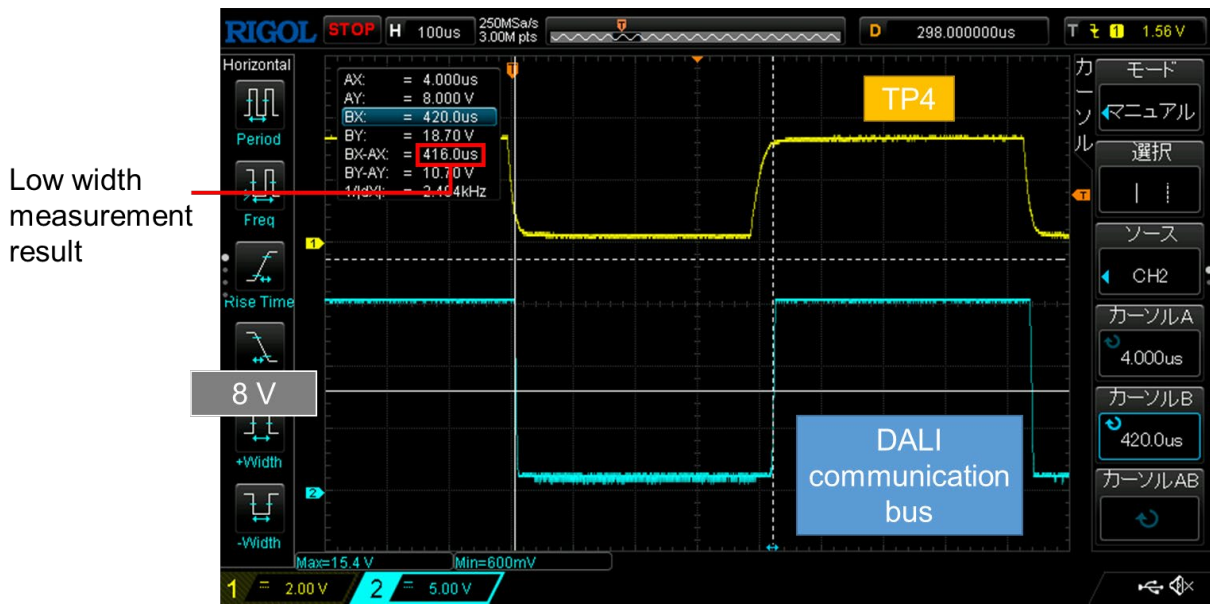
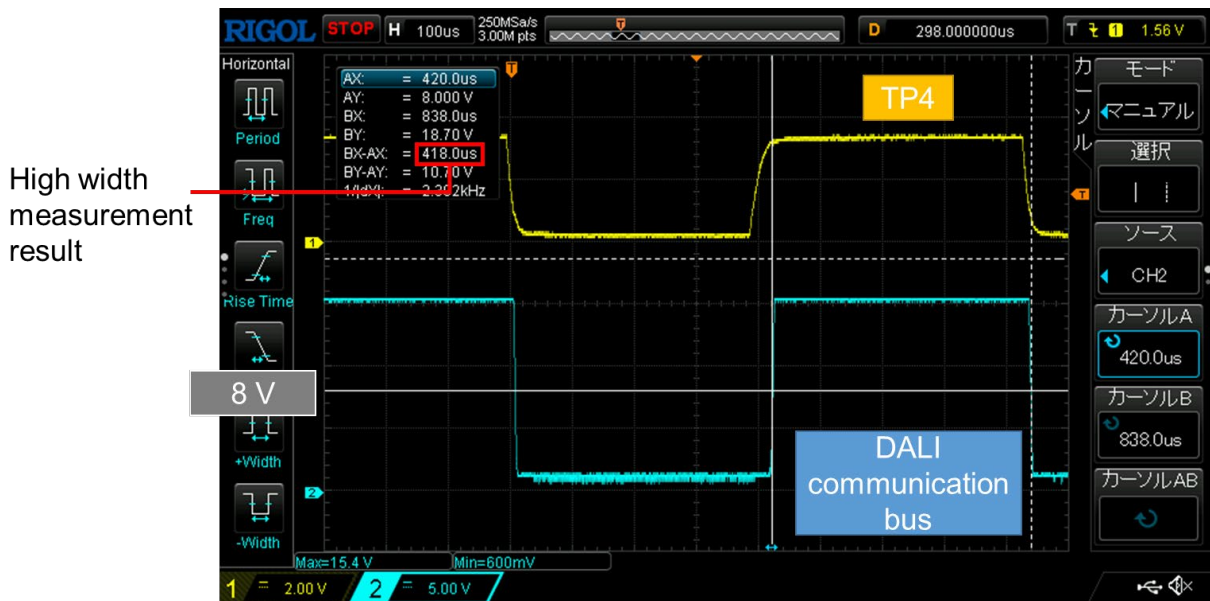

Figure 4-18 Transmission Half-bit waveform measurement result (High width)



(2) Rise time and fall time of the DALI RxD pin

The DALI standard specifies that the bit width must be determined based on the DALI communication bus standard. If the rising or falling delay is large in the DALI communication circuit outside the MCU, correct determination might be disabled due to a large difference between the waveform on the DALI communication bus and the waveform at the pin point.

This sample application has a function that enables correct determination by correcting the measured High/Low continuation time and receive bit width.

Making corrections requires the rise time and fall time based on the DALI RxD pin. The following describes the procedure for measuring and applying those times.

[Procedure]

1. Download and execute the sample application.
2. Connect the RX65N Cloud kit + DALI-2 option board (connected with the DALI Master Controller GUI) and RL78/G23 Lighting Communication Master Evaluation Board by using DALI, and then turn on the power.
3. Use two channels of the oscilloscope to configure the connection as follows.

Table 4.16 Oscilloscope connection settings (for adjustment of the transmission Half bit width)

Channel	Connection destination	Setting
Channel 1	TP5 (DALI RxD pin) on the target board	Voltage range: 500 mV/div
Other settings		
<ul style="list-style-type: none"> • The recommended time range is approximately 50 us/div. • Channel 1 must be configured so that a trigger occurs around the falling 1.65 V. 		

4. Send the QUERY RESET STATE command from the DALI Master Controller GUI in Broadcast mode.
5. Measure the two points from the channel 1 waveform obtained by triggering.
 - (1) Fall time: From the beginning of a fall to the 2.0 V point
 - (2) Rise time: From the beginning of a rise to the 0.5 V point
6. Apply the measurement results as the macro values in Table 4.17 Rise/fall time setting macros defined in r_dali101.h.

Table 4.17 Rise/fall time setting macros

Macro name	Description
RX_TRISE_US	Rise time of the DALI RxD pin [ns]
RX_TFALL_US	Fall time of the DALI RxD pin [ns]

Figure 4-19 DALI RxD pin fall time measurement result

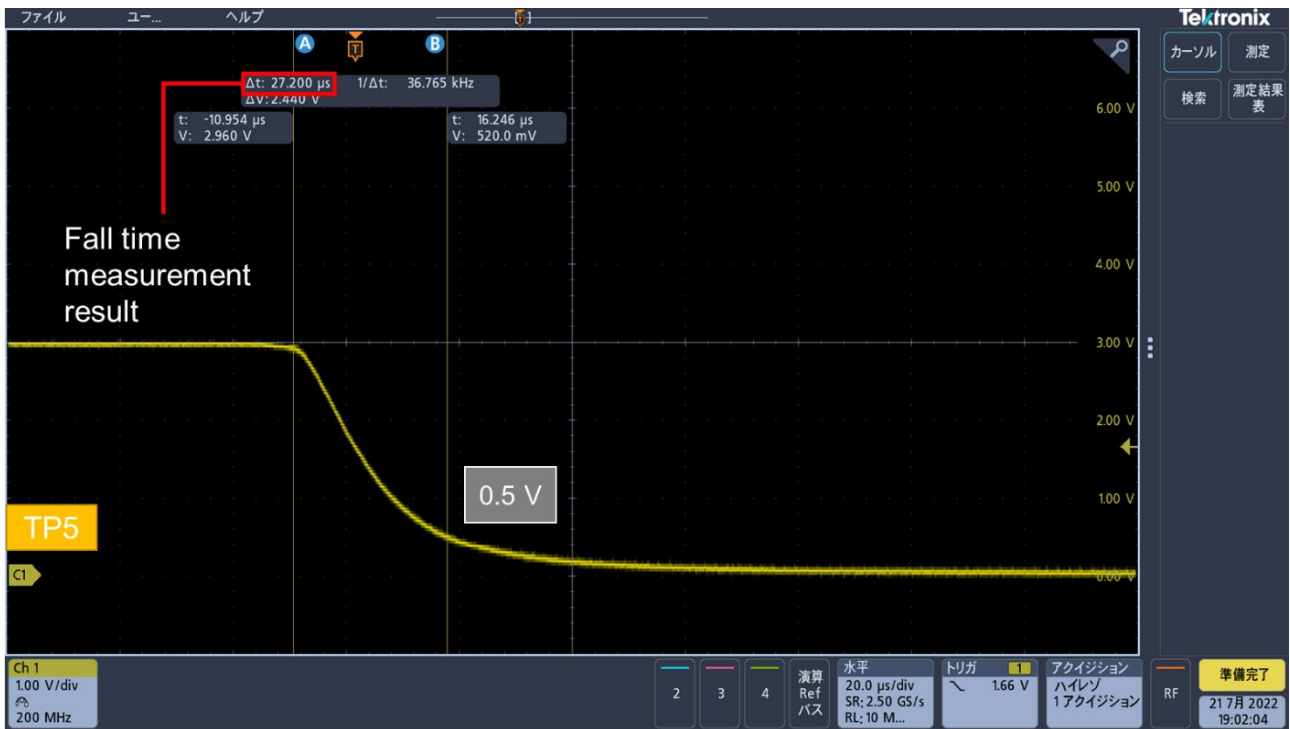

Note: EVDD = 3.3 V

Figure 4-20 DALI RxD pin rise time measurement result

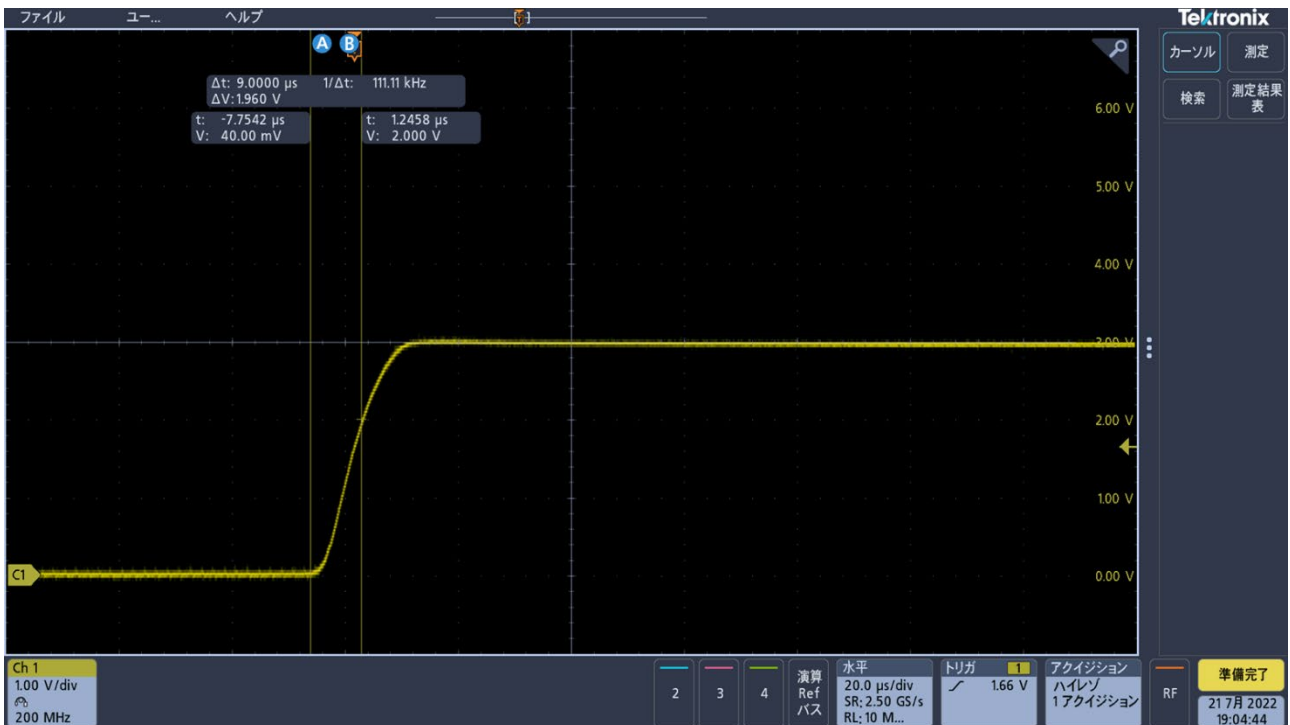

(3) Loop-back time for sent waveforms

The DALI standard specifies that if a collision occurs, Low output must continue for the tBREAK time and then return to High output. At this time, it must be determined whether the DALI output bus has been set to High level triggered by High output of the local device. Because subsequent processing varies depending on the check result, the check must be performed after the High output is applied to the DALI communication bus.

In this sample application, an appropriate value must be set for the waiting time after DALI TxD pin output is set to High until the input is applied to the DALI RxD pin via the DALI communication bus (hereafter called the loop-back time).

The following describes the procedure for measuring the loop-back time.

[Procedure]

1. Download and execute the sample application.
2. Connect the RX65N Cloud kit + DALI-2 option board (connected with the DALI Master Controller GUI) and RL78/G23 Lighting Communication Master Evaluation Board by using DALI, and then turn on the power.
3. Use two channels of the oscilloscope to configure the connection as follows.

Table 4.18 Oscilloscope connection settings (for adjustment of the transmission Half bit width)

Channel	Connection destination	Setting
Channel 1	TP4 (DALI TxD pin) on the target board	Voltage range: 2 V/div
Channel 2	TP5 (DALI RxD pin) on the target board	Voltage range: 2 V/div
Other settings		
<ul style="list-style-type: none"> • The recommended time range is approximately 20 us/div. • Configure channel 1 so that a trigger occurs around the rising 1.65 V. 		

4. Send the QUERY RESET STATE command from the DALI Master Controller GUI in Broadcast mode.
5. Measure the two points from the waveform obtained by triggering.
 - (1) Loop-back time: From the rising point of channel 1 to the 2.0 V point of channel 2
6. Apply the measurement results as the macro values in Table 4.19 Loop-back time setting macro defined in r_dali101_common.h.

Note: Considering measurement errors, we recommend that you set a value including some margins in the positive direction.

Table 4.19 Loop-back time setting macro

Macro name	Description
LOOPBACK_TIME_US	Loop-back time [us]

Figure 4-21 Loop-back time measurement results



Note: EVDD = 3.3 V

4.6 Software Structure

This section describes the software structure of the sample application.

4.6.1 Folder structure

The following indicates the folder structure of the sample application.

Table 4.20 Folder structure (1/2)

Folder or file name	Description
DALI103i_sample	Folder of the sample application
\App	Application program storage folder
r_common.h	Common definition header file
r_input_device.c	Source file of the Input Device module
r_input_device.h	Header file of the Input Device module
r_main.c	Main source file
r_memory_bank.c	Source file of the memory bank module
r_memory_bank.h	Header file of the memory bank module
r_memory_banks.c	Source file of the module that manages multiple memory banks
r_memory_banks.h	Header file of the module that manages multiple memory banks
r_nvm.c	Source file of the NVM module that supports data flash libraries
r_nvm.h	Header file of the NVM module that supports data flash libraries
r_random.c	Source file of the random number generation module
r_random.h	Header file of the random number generation module
r_unit0_memory_bank.c	Source file for unit0 definition of the memory bank
r_unit0_memory_bank.h	Header file for unit0 definition of the memory bank
r_user_instance.c	User instance source file
r_user_instance.h	User instance header file
\Driver	Driver program storage folder
r_dali101.c	Source file for DALI101ed.2.0 support drivers
r_dali101.h	Header file for DALI101ed.2.0 support drivers
r_dali101_bft.c	Source file for DALI101ed.2.0 support drivers (Backward Frame transmission)
r_dali101_bft.h	Header file for DALI101ed.2.0 support drivers (Backward Frame transmission)
r_dali101_common.h	DALI101ed.2.0 common definition header file
r_dali101_mmt.c	Source file for DALI101ed.2.0 support drivers (multi-master transmission)
r_dali101_mmt.h	Header file for DALI101ed.2.0 support drivers (multi-master transmission)
r_dali101_rx.c	Source file for DALI101ed.2.0 support drivers (reception)
r_dali101_rx.h	Header file for DALI101ed.2.0 support drivers (reception)
r_dali101_transaction.c	Source file for DALI101ed.2.0 support drivers (transaction)
r_dali101_transaction.h	Header file for DALI101ed.2.0 support drivers (transaction)
r_dali101_tx.c	Source file for DALI101ed.2.0 support drivers (transmission)
r_dali101_tx.h	Source file for DALI101ed.2.0 support drivers (transmission)
r_port.c	PORT source file
r_port.h	PORT header file
r_sau.c	SAU source file
r_sau.h	SAU header file
r_tau.c	TAU source file
r_tau.h	TAU header file
r_tml32.c	TML32 source file
r_tml32.h	TML32 header file

Table 4.21 Folder structure (2/2)

Folder or file name	Description
DALI103i_sample	Folder of the sample application
\Driver	Driver program storage folder
r_trng.c	TRNG source file
r_trng.h	TRNG header file
r_wdt.c	WDT source file
r_wdt.h	WDT header file
\HardwareDebug	Project file storage folder
DALI103i_sample.mot	File of Motorola S type format used for writing to firmware
\Library	Library storage folder
\DALI103i	DALI103ed1.0 support library storage folder
\EES	EES library storage folder
\RFD	RFD library storage folder
\QE-Touch	Touch key configuration file storage folder
DALI103i_sample.tifcfg	Touch key configuration file
\qe_gen	QE automatically generated file storage folder
qe_touch_config.c	Touch configuration definition source file
qe_touch_config.h	Touch configuration definition header file
qe_touch_define.h	Touch configuration definition header file
\src	Smart Configurator generation file storage folder
smc_gen	Smart Configurator generation folder
Utility	Common program storage folder
r_timer16.c	Source file of the timer module
r_timer16.h	Header file of the timer module
r_usertype.h	Type definition header file

4.6.2 Option byte setting list

The following indicates the option byte settings of the sample application.

Table 4.22 Option byte setting list

Address	Settings	Description
000C0H / 040C0H	11101111B	Watchdog timer operation enabled - The count stops after the reset is canceled. - Overflow time: $2^{17}/f_{IL}$ (3478.26 ms)
000C1H / 040C1H	11111101B	LVD reset mode (fall: 2.91 V, rise: 2.97 V)
000C2H / 040C2H	11101000B	HS mode, high-speed on-chip oscillator: 32 MHz
000C3H / 040C3H	10000100B	On-chip debugging enabled

4.6.3 Flowchart

4.6.3.1 Main flow

The following indicates the main flow of the sample application.
After the initialization is complete, Input Device processing starts.

Figure 4-22 Main flowchart

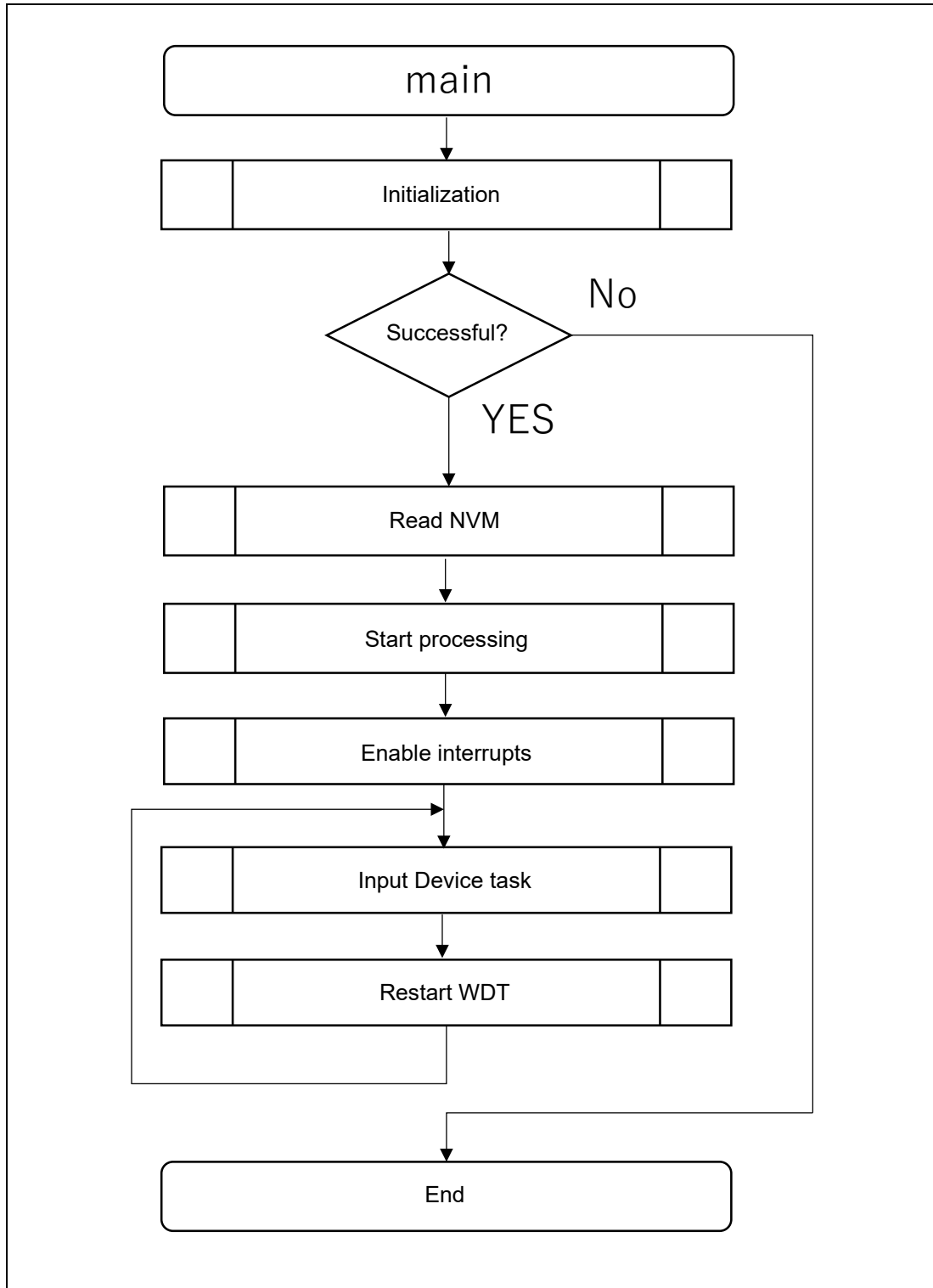

4.6.3.2 Initialization

The following shows the initialization flow.

Figure 4-23 Initialization flowchart

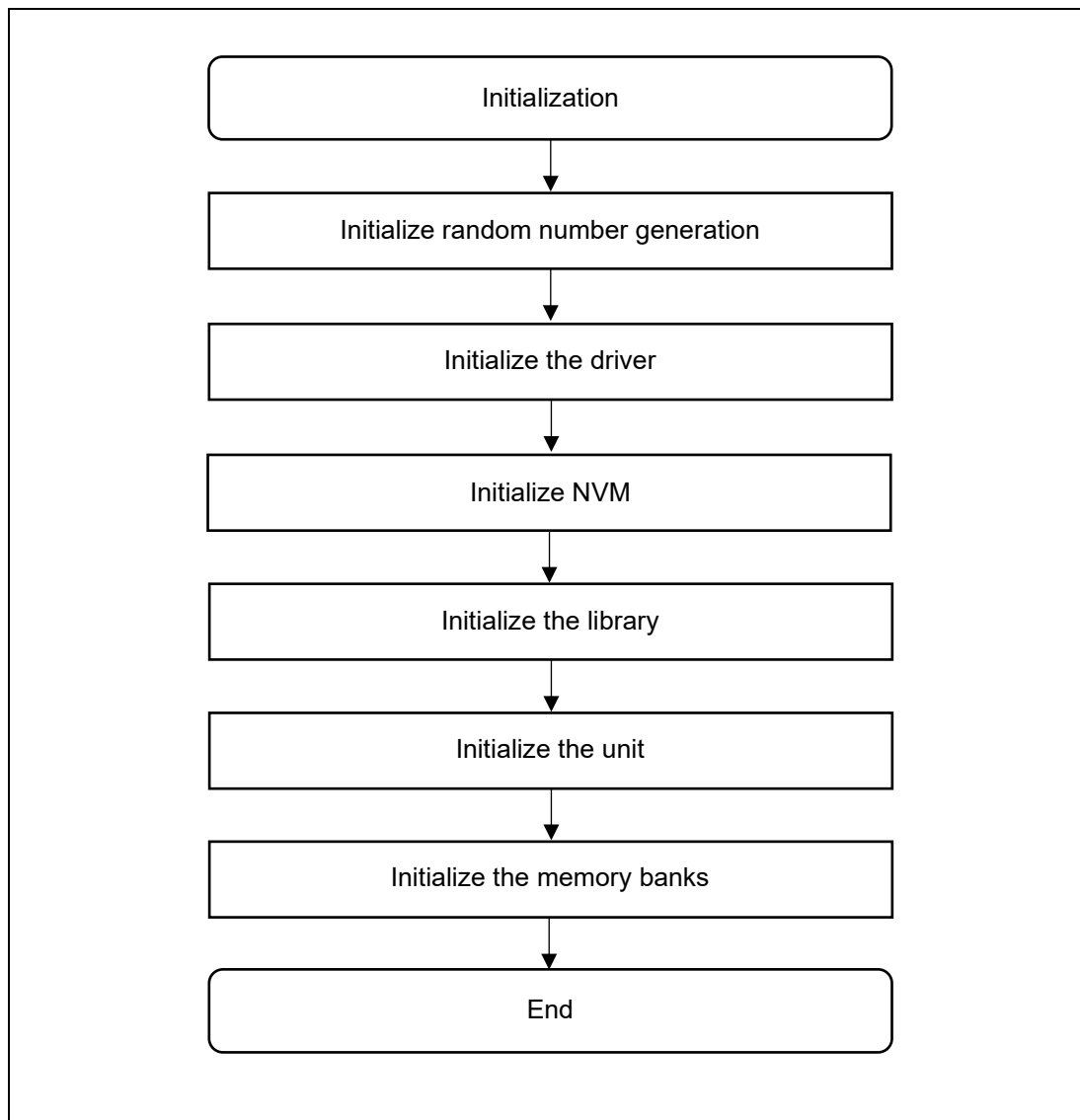

4.6.3.3 Reading NVM

The following shows the flow of NVM read processing performed after the initialization processing.

Figure 4-24 NVM read flowchart

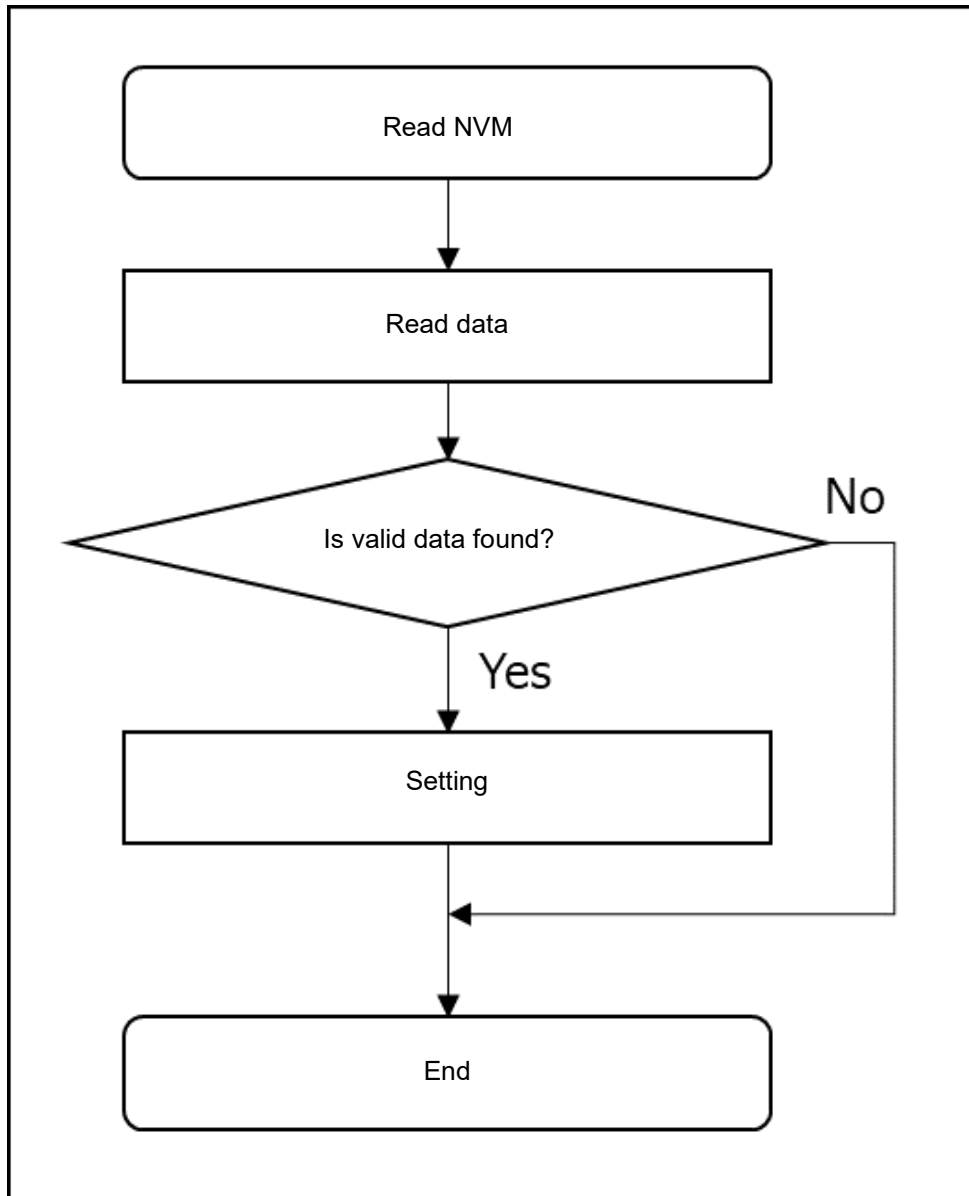

4.6.3.4 Start processing

The following shows the flow of start processing performed after the NVM read processing.

Figure 4-25 Flow for starting processing

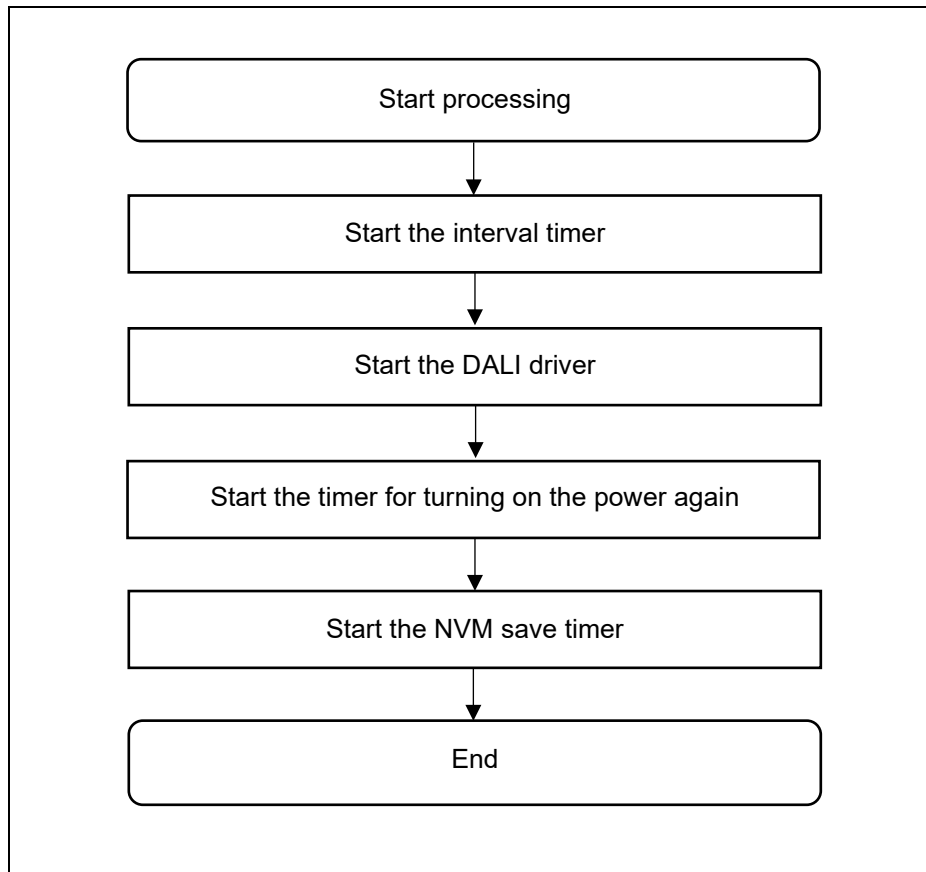

4.6.3.5 Input Device task processing

The following shows the flow of Input Device task processing.

Figure 4-26 Input Device task processing flow chart

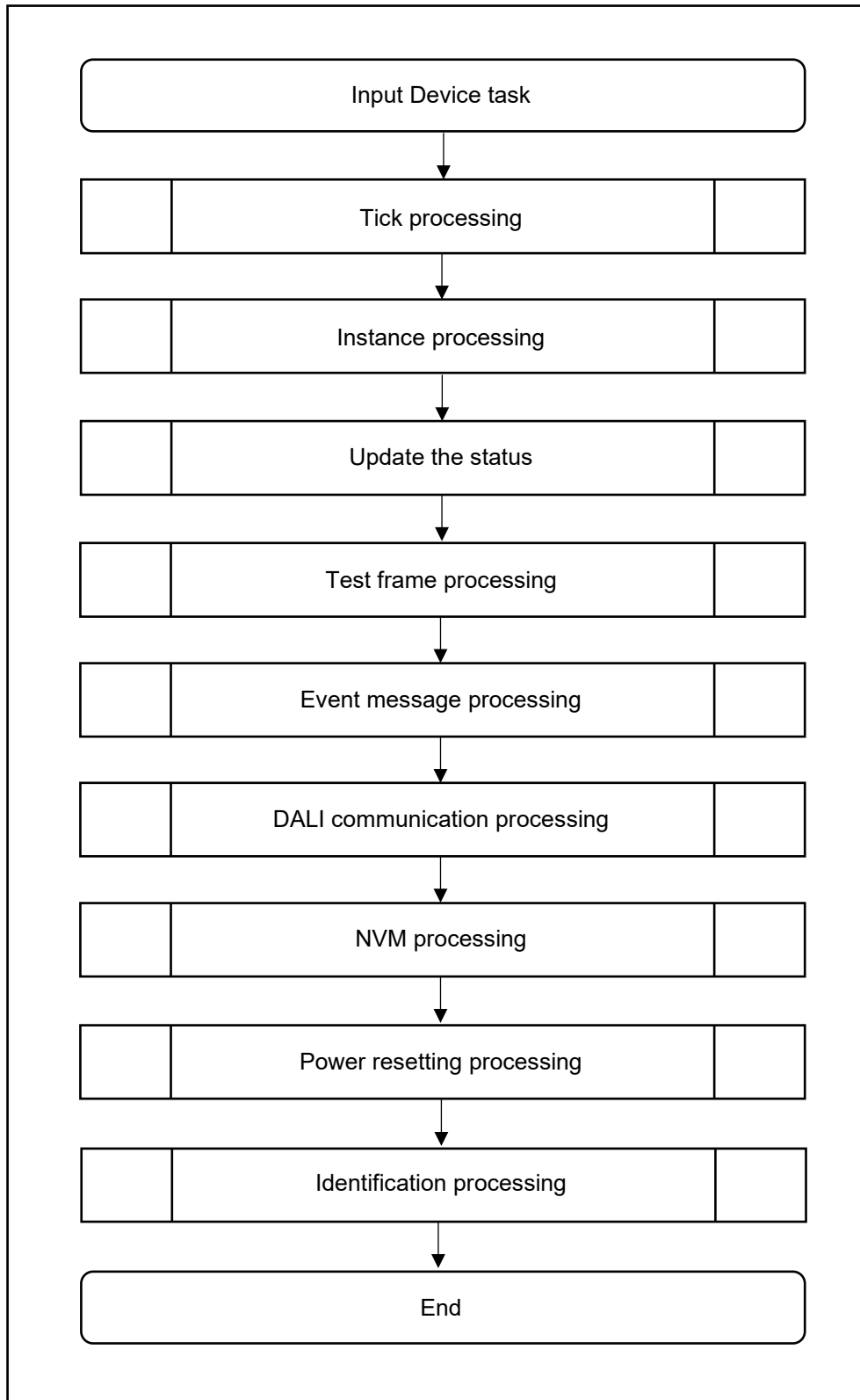

5. Precautions

- The configuration and operation of this sample application are designed in accordance with the Board RL78/G23 Lighting Communication Master Evaluation Board.
- This sample application provides sample operations only. The application layer requires the design change and evaluation according to the purpose of use.

6. Reference Documents

RL78/G23 User's Manual: Hardware (R01UH0896JJ0110)

RL78 Family User's Manual: Software (R01US0015J)

e2 studio 2020-04 and e2 studio v7.8 User's Manual: Getting Started (R20UT4819)

DALI Master Controller GUI User's Manual (R20UT0715)

EZ-0012 RL78/I1A DC/DC LED Control Evaluation Board User's Manual (R01UH0363)

(Obtain the latest version from the website of Renesas.)

Technical updates and technical news

(Obtain information about the latest version from the website of Renesas.)

DALI Standards

IEC 62386-101:2014+AMD1:2018 CSV Consolidated version (ed.2.1)

IEC 62386-103:2014+AMD1:2018 CSV Consolidated version (ed.1.1)

Revision History

Rev.	Date	Description	
		Page	Summary
1.00	Nov. 08, 2022	All	First edition issued.

General Precautions in the Handling of Microprocessing Unit and Microcontroller Unit Products

The following usage notes are applicable to all Microprocessing unit and Microcontroller unit products from Renesas. For detailed usage notes on the products covered by this document, refer to the relevant sections of the document as well as any technical updates that have been issued for the products.

1. Precaution against Electrostatic Discharge (ESD)

A strong electrical field, when exposed to a CMOS device, can cause destruction of the gate oxide and ultimately degrade the device operation. Steps must be taken to stop the generation of static electricity as much as possible, and quickly dissipate it when it occurs. Environmental control must be adequate. When it is dry, a humidifier should be used. This is recommended to avoid using insulators that can easily build up static electricity.

Semiconductor devices must be stored and transported in an anti-static container, static shielding bag or conductive material. All test and measurement tools including work benches and floors must be grounded. The operator must also be grounded using a wrist strap. Semiconductor devices must not be touched with bare hands. Similar precautions must be taken for printed circuit boards with mounted semiconductor devices.

2. Processing at power-on

The state of the product is undefined at the time when power is supplied. The states of internal circuits in the LSI are indeterminate and the states of register settings and pins are undefined at the time when power is supplied. In a finished product where the reset signal is applied to the external reset pin, the states of pins are not guaranteed from the time when power is supplied until the reset process is completed. In a similar way, the states of pins in a product that is reset by an on-chip power-on reset function are not guaranteed from the time when power is supplied until the power reaches the level at which resetting is specified.

3. Input of signal during power-off state

Do not input signals or an I/O pull-up power supply while the device is powered off. The current injection that results from input of such a signal or I/O pull-up power supply may cause malfunction and the abnormal current that passes in the device at this time may cause degradation of internal elements. Follow the guideline for input signal during power-off state as described in your product documentation.

4. Handling of unused pins

Handle unused pins in accordance with the directions given under handling of unused pins in the manual. The input pins of CMOS products are generally in the high-impedance state. In operation with an unused pin in the open-circuit state, extra electromagnetic noise is induced in the vicinity of the LSI, an associated shoot-through current flows internally, and malfunctions occur due to the false recognition of the pin state as an input signal become possible.

5. Clock signals

After applying a reset, only release the reset line after the operating clock signal becomes stable. When switching the clock signal during program execution, wait until the target clock signal is stabilized. When the clock signal is generated with an external resonator or from an external oscillator during a reset, ensure that the reset line is only released after full stabilization of the clock signal. Additionally, when switching to a clock signal produced with an external resonator or by an external oscillator while program execution is in progress, wait until the target clock signal is stable.

6. Voltage application waveform at input pin

Waveform distortion due to input noise or a reflected wave may cause malfunction. If the input of the CMOS device stays in the area between V_{IL} (Max.) and V_{IH} (Min.) due to noise, for example, the device may malfunction. Take care to prevent chattering noise from entering the device when the input level is fixed, and also in the transition period when the input level passes through the area between V_{IL} (Max.) and V_{IH} (Min.).

7. Prohibition of access to reserved addresses

Access to reserved addresses is prohibited. The reserved addresses are provided for possible future expansion of functions. Do not access these addresses as the correct operation of the LSI is not guaranteed.

8. Differences between products

Before changing from one product to another, for example to a product with a different part number, confirm that the change will not lead to problems. The characteristics of a microprocessing unit or microcontroller unit products in the same group but having a different part number might differ in terms of internal memory capacity, layout pattern, and other factors, which can affect the ranges of electrical characteristics, such as characteristic values, operating margins, immunity to noise, and amount of radiated noise. When changing to a product with a different part number, implement a system-evaluation test for the given product.

Notice

1. Descriptions of circuits, software and other related information in this document are provided only to illustrate the operation of semiconductor products and application examples. You are fully responsible for the incorporation or any other use of the circuits, software, and information in the design of your product or system. Renesas Electronics disclaims any and all liability for any losses and damages incurred by you or third parties arising from the use of these circuits, software, or information.
2. Renesas Electronics hereby expressly disclaims any warranties against and liability for infringement or any other claims involving patents, copyrights, or other intellectual property rights of third parties, by or arising from the use of Renesas Electronics products or technical information described in this document, including but not limited to, the product data, drawings, charts, programs, algorithms, and application examples.
3. No license, express, implied or otherwise, is granted hereby under any patents, copyrights or other intellectual property rights of Renesas Electronics or others.
4. You shall be responsible for determining what licenses are required from any third parties, and obtaining such licenses for the lawful import, export, manufacture, sales, utilization, distribution or other disposal of any products incorporating Renesas Electronics products, if required.
5. You shall not alter, modify, copy, or reverse engineer any Renesas Electronics product, whether in whole or in part. Renesas Electronics disclaims any and all liability for any losses or damages incurred by you or third parties arising from such alteration, modification, copying or reverse engineering.
6. Renesas Electronics products are classified according to the following two quality grades: "Standard" and "High Quality". The intended applications for each Renesas Electronics product depends on the product's quality grade, as indicated below.
 - "Standard": Computers; office equipment; communications equipment; test and measurement equipment; audio and visual equipment; home electronic appliances; machine tools; personal electronic equipment; industrial robots; etc.
 - "High Quality": Transportation equipment (automobiles, trains, ships, etc.); traffic control (traffic lights); large-scale communication equipment; key financial terminal systems; safety control equipment; etc.Unless expressly designated as a high reliability product or a product for harsh environments in a Renesas Electronics data sheet or other Renesas Electronics document, Renesas Electronics products are not intended or authorized for use in products or systems that may pose a direct threat to human life or bodily injury (artificial life support devices or systems; surgical implantations; etc.), or may cause serious property damage (space system; undersea repeaters; nuclear power control systems; aircraft control systems; key plant systems; military equipment; etc.). Renesas Electronics disclaims any and all liability for any damages or losses incurred by you or any third parties arising from the use of any Renesas Electronics product that is inconsistent with any Renesas Electronics data sheet, user's manual or other Renesas Electronics document.
7. No semiconductor product is absolutely secure. Notwithstanding any security measures or features that may be implemented in Renesas Electronics hardware or software products, Renesas Electronics shall have absolutely no liability arising out of any vulnerability or security breach, including but not limited to any unauthorized access to or use of a Renesas Electronics product or a system that uses a Renesas Electronics product. RENESAS ELECTRONICS DOES NOT WARRANT OR GUARANTEE THAT RENESAS ELECTRONICS PRODUCTS, OR ANY SYSTEMS CREATED USING RENESAS ELECTRONICS PRODUCTS WILL BE INVULNERABLE OR FREE FROM CORRUPTION, ATTACK, VIRUSES, INTERFERENCE, HACKING, DATA LOSS OR THEFT, OR OTHER SECURITY INTRUSION ("Vulnerability Issues"). RENESAS ELECTRONICS DISCLAIMS ANY AND ALL RESPONSIBILITY OR LIABILITY ARISING FROM OR RELATED TO ANY VULNERABILITY ISSUES. FURTHERMORE, TO THE EXTENT PERMITTED BY APPLICABLE LAW, RENESAS ELECTRONICS DISCLAIMS ANY AND ALL WARRANTIES, EXPRESS OR IMPLIED, WITH RESPECT TO THIS DOCUMENT AND ANY RELATED OR ACCOMPANYING SOFTWARE OR HARDWARE, INCLUDING BUT NOT LIMITED TO THE IMPLIED WARRANTIES OF MERCHANTABILITY, OR FITNESS FOR A PARTICULAR PURPOSE.
8. When using Renesas Electronics products, refer to the latest product information (data sheets, user's manuals, application notes, "General Notes for Handling and Using Semiconductor Devices" in the reliability handbook, etc.), and ensure that usage conditions are within the ranges specified by Renesas Electronics with respect to maximum ratings, operating power supply voltage range, heat dissipation characteristics, installation, etc. Renesas Electronics disclaims any and all liability for any malfunctions, failure or accident arising out of the use of Renesas Electronics products outside of such specified ranges.
9. Although Renesas Electronics endeavors to improve the quality and reliability of Renesas Electronics products, semiconductor products have specific characteristics, such as the occurrence of failure at a certain rate and malfunctions under certain use conditions. Unless designated as a high reliability product or a product for harsh environments in a Renesas Electronics data sheet or other Renesas Electronics document, Renesas Electronics products are not subject to radiation resistance design. You are responsible for implementing safety measures to guard against the possibility of bodily injury, injury or damage caused by fire, and/or danger to the public in the event of a failure or malfunction of Renesas Electronics products, such as safety design for hardware and software, including but not limited to redundancy, fire control and malfunction prevention, appropriate treatment for aging degradation or any other appropriate measures. Because the evaluation of microcomputer software alone is very difficult and impractical, you are responsible for evaluating the safety of the final products or systems manufactured by you.
10. Please contact a Renesas Electronics sales office for details as to environmental matters such as the environmental compatibility of each Renesas Electronics product. You are responsible for carefully and sufficiently investigating applicable laws and regulations that regulate the inclusion or use of controlled substances, including without limitation, the EU RoHS Directive, and using Renesas Electronics products in compliance with all these applicable laws and regulations. Renesas Electronics disclaims any and all liability for damages or losses occurring as a result of your noncompliance with applicable laws and regulations.
11. Renesas Electronics products and technologies shall not be used for or incorporated into any products or systems whose manufacture, use, or sale is prohibited under any applicable domestic or foreign laws or regulations. You shall comply with any applicable export control laws and regulations promulgated and administered by the governments of any countries asserting jurisdiction over the parties or transactions.
12. It is the responsibility of the buyer or distributor of Renesas Electronics products, or any other party who distributes, disposes of, or otherwise sells or transfers the product to a third party, to notify such third party in advance of the contents and conditions set forth in this document.
13. This document shall not be reprinted, reproduced or duplicated in any form, in whole or in part, without prior written consent of Renesas Electronics.
14. Please contact a Renesas Electronics sales office if you have any questions regarding the information contained in this document or Renesas Electronics products.

(Note1) "Renesas Electronics" as used in this document means Renesas Electronics Corporation and also includes its directly or indirectly controlled subsidiaries.

(Note2) "Renesas Electronics product(s)" means any product developed or manufactured by or for Renesas Electronics.

(Rev.5.0-1 October 2020)

Corporate Headquarters

TOYOSU FORESIA, 3-2-24 Toyosu,
Koto-ku, Tokyo 135-0061, Japan
www.renesas.com

Trademarks

Renesas and the Renesas logo are trademarks of Renesas Electronics Corporation. All trademarks and registered trademarks are the property of their respective owners.

Contact information

For further information on a product, technology, the most up-to-date version of a document, or your nearest sales office, please visit:
www.renesas.com/contact/.