

RA4W1 Group

Evaluation Kit for RA4W1 Microcontroller Group
EK-RA4W1
Quick Start Guide

Renesas RA Family
RA4 Series

All information contained in these materials, including products and product specifications, represents information on the product at the time of publication and is subject to change by Renesas Electronics Corp. without notice. Please review the latest information published by Renesas Electronics Corp. through various means, including the Renesas Electronics Corp. website (<http://www.renesas.com>).

Notice

1. Descriptions of circuits, software and other related information in this document are provided only to illustrate the operation of semiconductor products and application examples. You are fully responsible for the incorporation or any other use of the circuits, software, and information in the design of your product or system. Renesas Electronics disclaims any and all liability for any losses and damages incurred by you or third parties arising from the use of these circuits, software, or information.
 2. Renesas Electronics hereby expressly disclaims any warranties against and liability for infringement or any other claims involving patents, copyrights, or other intellectual property rights of third parties, by or arising from the use of Renesas Electronics products or technical information described in this document, including but not limited to, the product data, drawings, charts, programs, algorithms, and application examples.
 3. No license, express, implied or otherwise, is granted hereby under any patents, copyrights or other intellectual property rights of Renesas Electronics or others.
 4. You shall not alter, modify, copy, or reverse engineer any Renesas Electronics product, whether in whole or in part. Renesas Electronics disclaims any and all liability for any losses or damages incurred by you or third parties arising from such alteration, modification, copying or reverse engineering.
 5. Renesas Electronics products are classified according to the following two quality grades: "Standard" and "High Quality". The intended applications for each Renesas Electronics product depends on the product's quality grade, as indicated below.
 - "Standard": Computers; office equipment; communications equipment; test and measurement equipment; audio and visual equipment; home electronic appliances; machine tools; personal electronic equipment; industrial robots; etc.
 - "High Quality": Transportation equipment (automobiles, trains, ships, etc.); traffic control (traffic lights); large-scale communication equipment; key financial terminal systems; safety control equipment; etc.
- Unless expressly designated as a high reliability product or a product for harsh environments in a Renesas Electronics data sheet or other Renesas Electronics document, Renesas Electronics products are not intended or authorized for use in products or systems that may pose a direct threat to human life or bodily injury (artificial life support devices or systems; surgical implantations; etc.), or may cause serious property damage (space system; undersea repeaters; nuclear power control systems; aircraft control systems; key plant systems; military equipment; etc.). Renesas Electronics disclaims any and all liability for any damages or losses incurred by you or any third parties arising from the use of any Renesas Electronics product that is inconsistent with any Renesas Electronics data sheet, user's manual or other Renesas Electronics document.
6. When using Renesas Electronics products, refer to the latest product information (data sheets, user's manuals, application notes, "General Notes for Handling and Using Semiconductor Devices" in the reliability handbook, etc.), and ensure that usage conditions are within the ranges specified by Renesas Electronics with respect to maximum ratings, operating power supply voltage range, heat dissipation characteristics, installation, etc. Renesas Electronics disclaims any and all liability for any malfunctions, failure or accident arising out of the use of Renesas Electronics products outside of such specified ranges.
 7. Although Renesas Electronics endeavors to improve the quality and reliability of Renesas Electronics products, semiconductor products have specific characteristics, such as the occurrence of failure at a certain rate and malfunctions under certain use conditions. Unless designated as a high reliability product or a product for harsh environments in a Renesas Electronics data sheet or other Renesas Electronics document, Renesas Electronics products are not subject to radiation resistance design. You are responsible for implementing safety measures to guard against the possibility of bodily injury, injury or damage caused by fire, and/or danger to the public in the event of a failure or malfunction of Renesas Electronics products, such as safety design for hardware and software, including but not limited to redundancy, fire control and malfunction prevention, appropriate treatment for aging degradation or any other appropriate measures. Because the evaluation of microcomputer software alone is very difficult and impractical, you are responsible for evaluating the safety of the final products or systems manufactured by you.
 8. Please contact a Renesas Electronics sales office for details as to environmental matters such as the environmental compatibility of each Renesas Electronics product. You are responsible for carefully and sufficiently investigating applicable laws and regulations that regulate the inclusion or use of controlled substances, including without limitation, the EU RoHS Directive, and using Renesas Electronics products in compliance with all these applicable laws and regulations. Renesas Electronics disclaims any and all liability for damages or losses occurring as a result of your noncompliance with applicable laws and regulations.
 9. Renesas Electronics products and technologies shall not be used for or incorporated into any products or systems whose manufacture, use, or sale is prohibited under any applicable domestic or foreign laws or regulations. You shall comply with any applicable export control laws and regulations promulgated and administered by the governments of any countries asserting jurisdiction over the parties or transactions.
 10. It is the responsibility of the buyer or distributor of Renesas Electronics products, or any other party who distributes, disposes of, or otherwise sells or transfers the product to a third party, to notify such third party in advance of the contents and conditions set forth in this document.
 11. This document shall not be reprinted, reproduced or duplicated in any form, in whole or in part, without prior written consent of Renesas Electronics.
 12. Please contact a Renesas Electronics sales office if you have any questions regarding the information contained in this document or Renesas Electronics products.

(Note1) "Renesas Electronics" as used in this document means Renesas Electronics Corporation and also includes its directly or indirectly controlled subsidiaries.

(Note2) "Renesas Electronics product(s)" means any product developed or manufactured by or for Renesas Electronics.

(Rev.4.0-1 November 2017)

Corporate Headquarters

TOYOSU FORESIA, 3-2-24 Toyosu,
Koto-ku, Tokyo 135-0061, Japan
www.renesas.com

Trademarks

Renesas and the Renesas logo are trademarks of Renesas Electronics Corporation. All trademarks and registered trademarks are the property of their respective owners.

Contact information

For further information on a product, technology, the most up-to-date version of a document, or your nearest sales office, please visit:
www.renesas.com/contact/

Renesas EK-RA4W1 Disclaimer

By using this EK-RA4W1, the User accepts the following terms, which are in addition to, and control in the event of disagreement, with Renesas' General Terms and Conditions available at <https://www.renesas.com/en-us/legal/disclaimer.html>.

The EK-RA4W1 is not guaranteed to be error free, and the entire risk as to the results and performance of the EK-RA4W1 is assumed by the User. The EK-RA4W1 is provided by Renesas on an "as is" basis without warranty of any kind whether express or implied, including but not limited to the implied warranties of good workmanship, fitness for a particular purpose, title, merchantability, and non-infringement of intellectual property rights. Renesas expressly disclaims any implied warranty.

Renesas does not consider the EK-RA4W1 to be a finished product and therefore the EK-RA4W1 may not comply with some requirements applicable to finished products, including, but not limited to recycling, restricted substances and electromagnetic compatibility regulations. Refer to Certifications section, for information about certifications and compliance information for the EK-RA4W1. It is the kit User's responsibility to make sure the kit meets any local requirements applicable to their region.

Renesas or its affiliates shall in no event be liable for any loss of profit, loss of data, loss of contract, loss of business, damage to reputation or goodwill, any economic loss, any reprogramming or recall costs (whether the foregoing losses are direct or indirect) nor shall Renesas or its affiliates be liable for any other direct or indirect special, incidental or consequential damages arising out of or in relation to the use of this EK-RA4W1, even if Renesas or its affiliates have been advised of the possibility of such damages.

Renesas has used reasonable care in preparing the information included in this document, but Renesas does not warrant that such information is error free nor does Renesas guarantee an exact match for every application or parameter to part numbers designated by other vendors listed herein. The information provided in this document is intended solely to enable the use of Renesas products. No express or implied license to any intellectual property right is granted by this document or in connection with the sale of Renesas products. Renesas reserves the right to make changes to specifications and product descriptions at any time without notice. Renesas assumes no liability for any damages incurred by you resulting from errors in or omissions from the information included herein. Renesas cannot verify, and assumes no liability for, the accuracy of information available on another company's website.

Precautions

This Evaluation Kit is only intended for use in a laboratory environment under ambient temperature and humidity conditions. A safe separation distance should be used between this and any sensitive equipment. Its use outside the laboratory, classroom, study area, or similar such area invalidates conformity with the protection requirements of the Electromagnetic Compatibility Directive and could lead to prosecution.

The product generates, uses, and can radiate radio frequency energy and may cause harmful interference to radio communications. There is no guarantee that interference will not occur in a particular installation. If this equipment causes harmful interference to radio or television reception, which can be determined by turning the equipment off or on, you are encouraged to try to correct the interference by one or more of the following measures:

- Ensure attached cables do not lie across the equipment.
- Reorient the receiving antenna.
- Increase the distance between the equipment and the receiver.
- Connect the equipment into an outlet on a circuit different from that which the receiver is connected.
- Power down the equipment when not in use.
- Consult the dealer or an experienced radio/TV technician for help.

Note: It is recommended that wherever possible shielded interface cables are used.

The product is potentially susceptible to certain EMC phenomena. To mitigate against them it is recommended that the following measures be undertaken:

- The user is advised that mobile phones should not be used within 10 m of the product when in use.
- The user is advised to take ESD precautions when handling the equipment.

The Evaluation Kit does not represent an ideal reference design for an end product and does not fulfill the regulatory standards for an end product.

Renesas RA Family

EK-RA4W1
Contents

1. Introduction.....	6
1.1 Assumptions and Advisory Notes.....	7
2. Kit Connection	7
3. Overview of the Quick Start Example Project.....	8
4. Running the Quick Start Example Project.....	9
4.1 Connecting and Powering Up the EK-RA4W1 Board	10
4.2 Startup Confirmation.....	10
5. Checking Operation	10
5.1 Setting up Communication with a Smartphone	11
6. Evaluating the Functionality	15
6.1 Programming HCI Firmware.....	15
6.2 Connecting BTTS	15
7. Restoring Factory Settings.....	16
8. Website and Support	16
Revision History	17

Figures

Figure 1. EK-RA4W1 Board (Top View).....	6
Figure 2. EK-RA4W1 Kit Contents	7
Figure 3. Operating Flow	8
Figure 4. USB Connector CN5	10
Figure 5. USB Serial Driver Installation Message	10
Figure 6. LED Blinking	10
Figure 7. Connect to this Product	11
Figure 8. Filter Function.....	11
Figure 9. Confirmation of Connection Establishment.....	12
Figure 10. Selecting Switch State Characteristic	12
Figure 11. Allowing Notifications	13
Figure 12. Switch Status Notification.....	13

Figure 13. Selecting LED Blink Rate Characteristic	14
Figure 14. LED Blink Control	14
Figure 15. Connecting to PC for Programming HCI Firmware	15
Figure 16. Connecting to PC for Connecting BTTS	15
Figure 17. Connecting to PC for Programming Factor Software.....	16

1. Introduction

This Quick Start Guide (QSG) provides:

- An overview of the Quick Start example project that the EK-RA4W1 board comes pre-programmed with.
- Instructions for running the Quick Start example project.
- Instructions for importing, modifying, and building the Quick Start example project using Flexible Software Package (FSP) and e² studio Integrated Development Environment (IDE).
- Bluetooth communication with your smartphone.
- Preparation for Bluetooth functionality evaluation.
- Restoring factory software.

Figure 1 illustrates the top view of the EK-RA4W1 board.

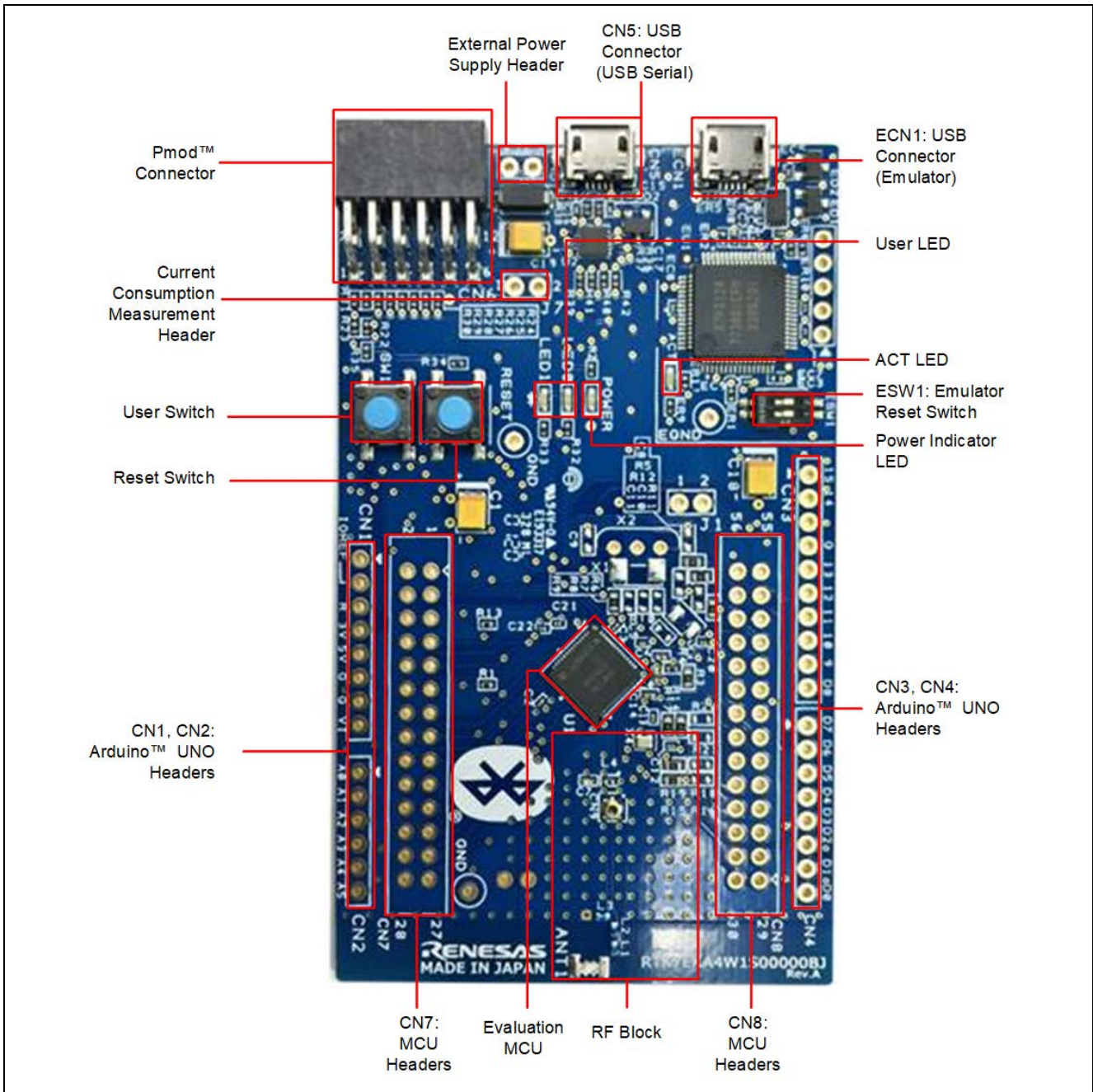

Figure 1. EK-RA4W1 Board (Top View)

For details of this product, refer to RA4W1 Group EK-RA4W1 User's Manual (R20UT4683xxxxxx).

1.1 Assumptions and Advisory Notes

1. Tool experience: It is assumed that the user has prior experience working with IDEs such as e² studio and terminal emulation programs such as Tera Term.
2. Subject knowledge: It is assumed that the user has basic knowledge about microcontrollers, embedded systems, and FSP to modify the example project described in this document.
3. Prior to running the Quick Start example project or programming the EK-RA4W1 board, default jumper settings must be used. Refer to the EK-RA4W1 user's manual for the default jumper settings.
4. The screen shots provided throughout this document are for reference. The actual screen content may differ depending on the version of software and development tools used.

2. Kit Connection

The kit contains the EK-RA4W1 board that is connected to the host PC using a USB cable (not included in the kit). The IDE can be installed from the URL, renesas.com/IDE/e2studio on to the host PC. The installer automatically installs all the required drivers along with the IDE.

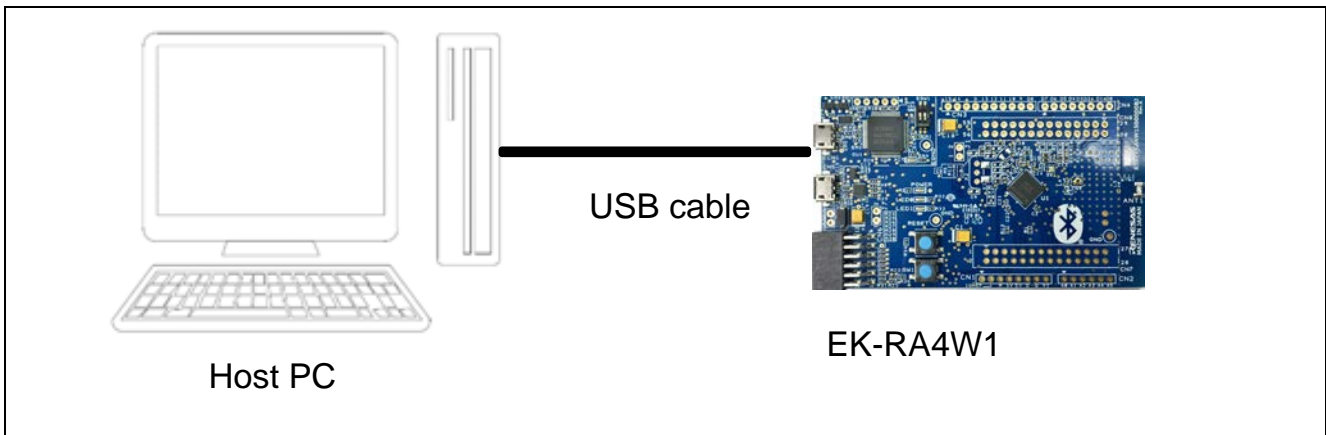

Figure 2. EK-RA4W1 Kit Contents

Overview of the Quick Start Example Project shows the operating flow of this example project.

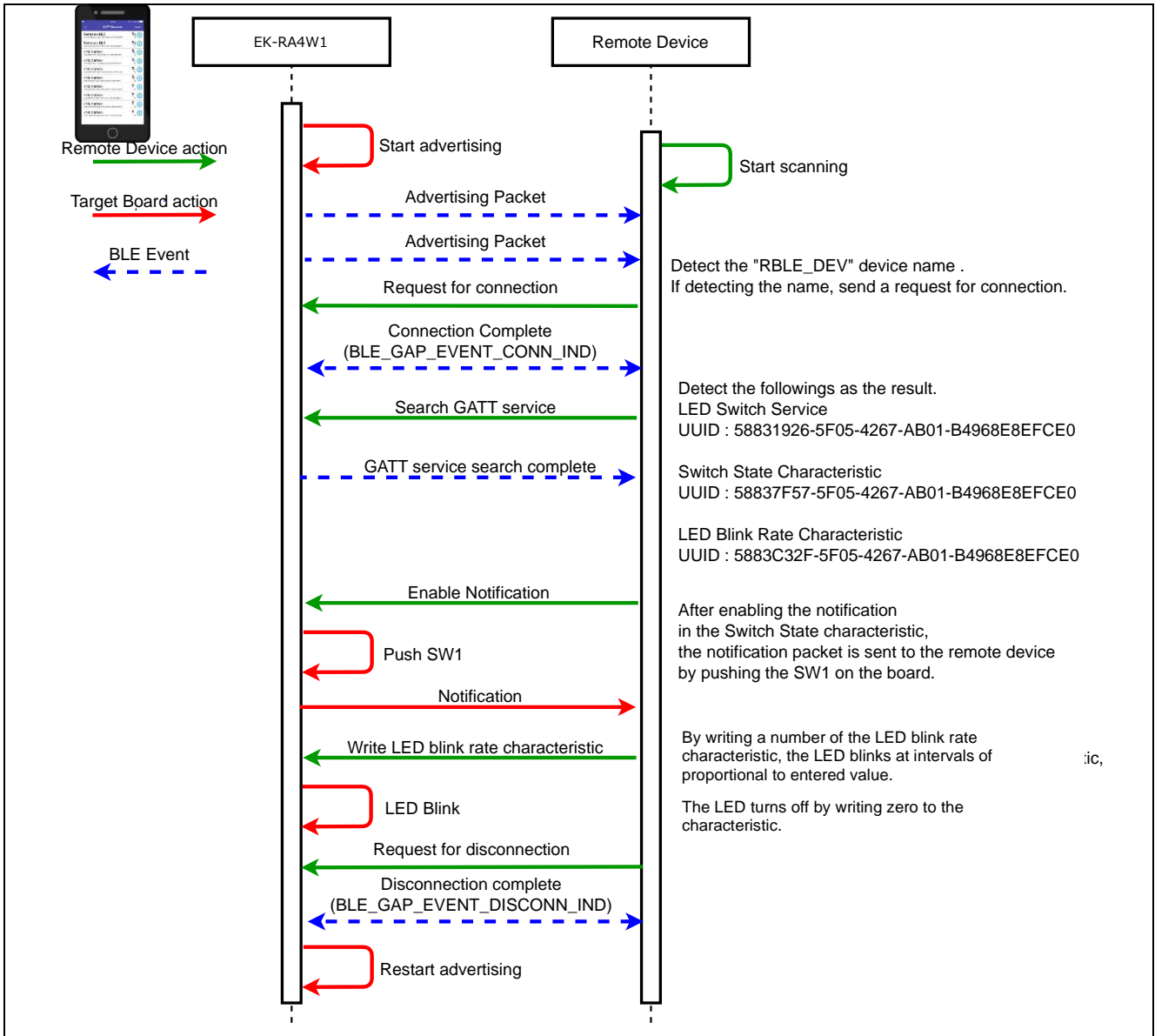

Figure 3. Operating Flow

3. Running the Quick Start Example Project

This section lists the requirements and instructions to power up the EK-RA4W1 board and run the Quick Start example project.

Hardware and Software Requirements

- EK-RA4W1 board
- Micro USB device cable (not included with this kit)
- A PC with at least 1 USB port
- A smartphone with the following OS and the smartphone App “GATTBrowser” from Renesas Electronics (shown in the following graphics).
 - iOS version 9.0 or later
 - Android 5.0.1 or later

GATTBrowser



iOS version:



<https://itunes.apple.com/app/gattbrowser/id1163057977>

Android version:



<https://play.google.com/store/apps/details?id=com.renesas.ble.gattbrowser>

- Windows® 10 operating system
- USB Serial Drivers (included in Windows® 10)
- Tera Term (or similar) terminal console application
- [SEGGER J-Link® firmware](#)

3.1 Connecting and Powering Up the EK-RA4W1 Board

This product supports USB power supply. Confirm that ESW1-2 is OFF and connect USB connector CN5 to the USB port of your PC (or other power supply) with a USB cable.

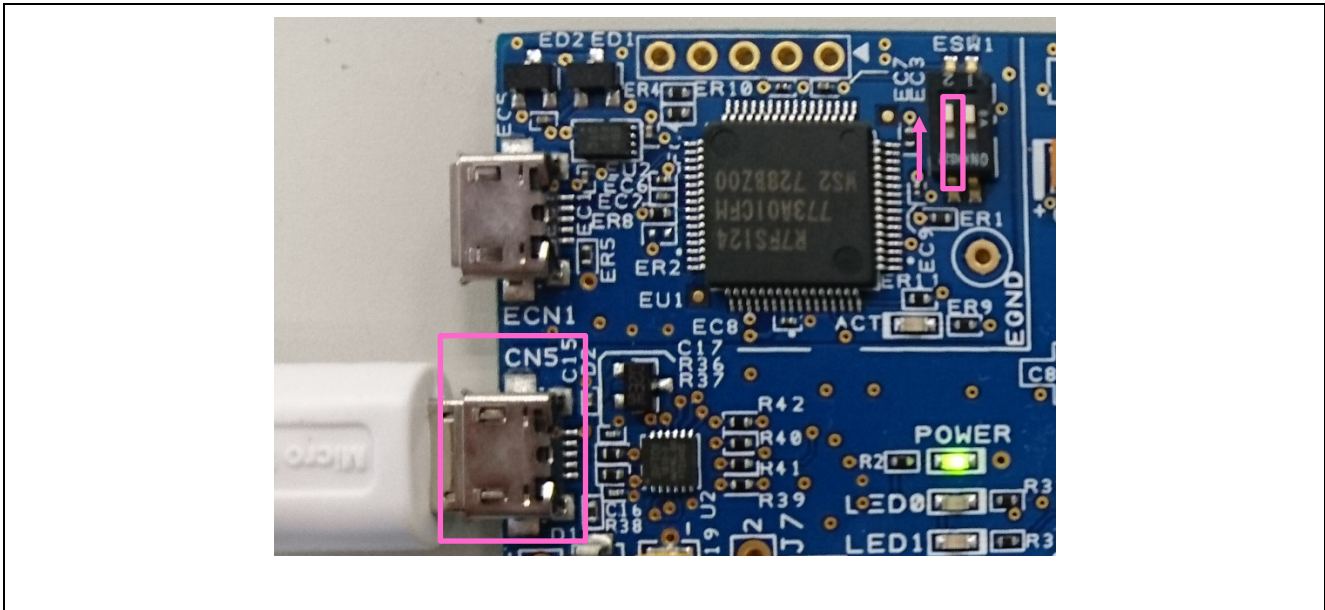

Figure 4. USB Connector CN5

When connecting to your PC for the first time, a driver installation message will appear on the PC screen as shown in Figure 5. After that, the driver installation completion message is displayed on your PC.

Note: The display may vary depending on the PC OS.

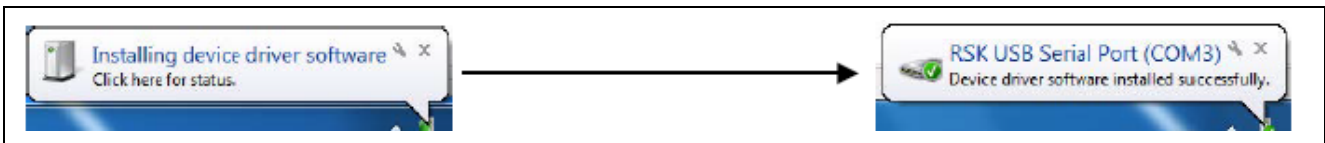

Figure 5. USB Serial Driver Installation Message

3.2 Startup Confirmation

After turning on the power, confirm that LED0 blinks. If it does not blink, check that the USB connector (CN5) to be connected is correct or that ESW1-2 is OFF.

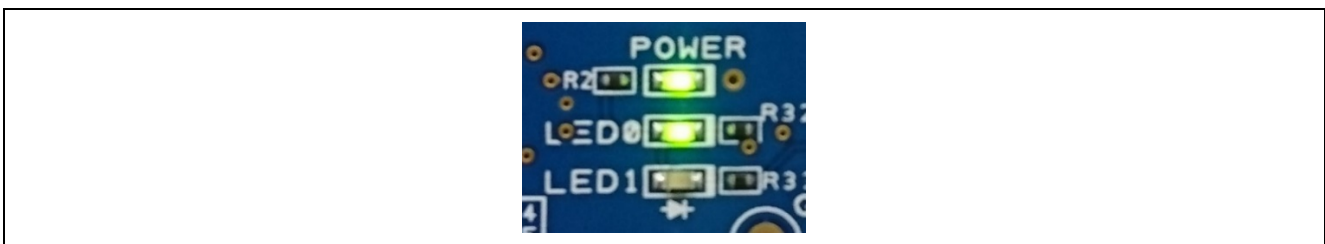

Figure 6. LED Blinking

4. Checking Operation

Software stored at the time of shipment to this product will start advertising to be connected after the power is turned on. After pairing, it communicates with a remote device such as a smartphone to exchange information about user switch operation and allows the user to control LED0 state. See Figure 3 for the flow of operation of this product.

4.1 Setting up Communication with a Smartphone

Note: The smartphone display varies depending on the OS. In this document, the Android version **GATTBrowser** screen is used for explanation.

To operate this product from a smartphone, use the following steps:

1. Turn on this product.
2. Start **GATTBrowser** on your smartphone.
3. Tap the arrow icon  of the device displayed as **RBLE-DEV** on **GATTBrowser** to connect.

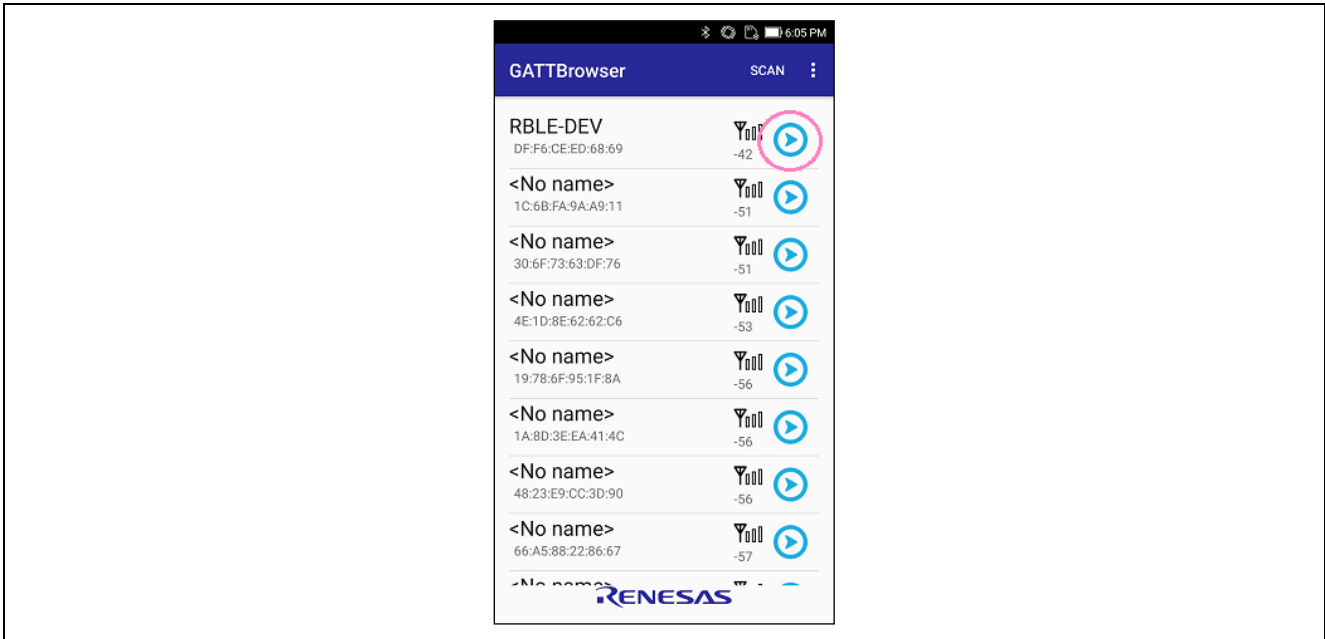

Figure 7. Connect to this Product

4. If many devices are discovered and difficult to find, enable the filter function.

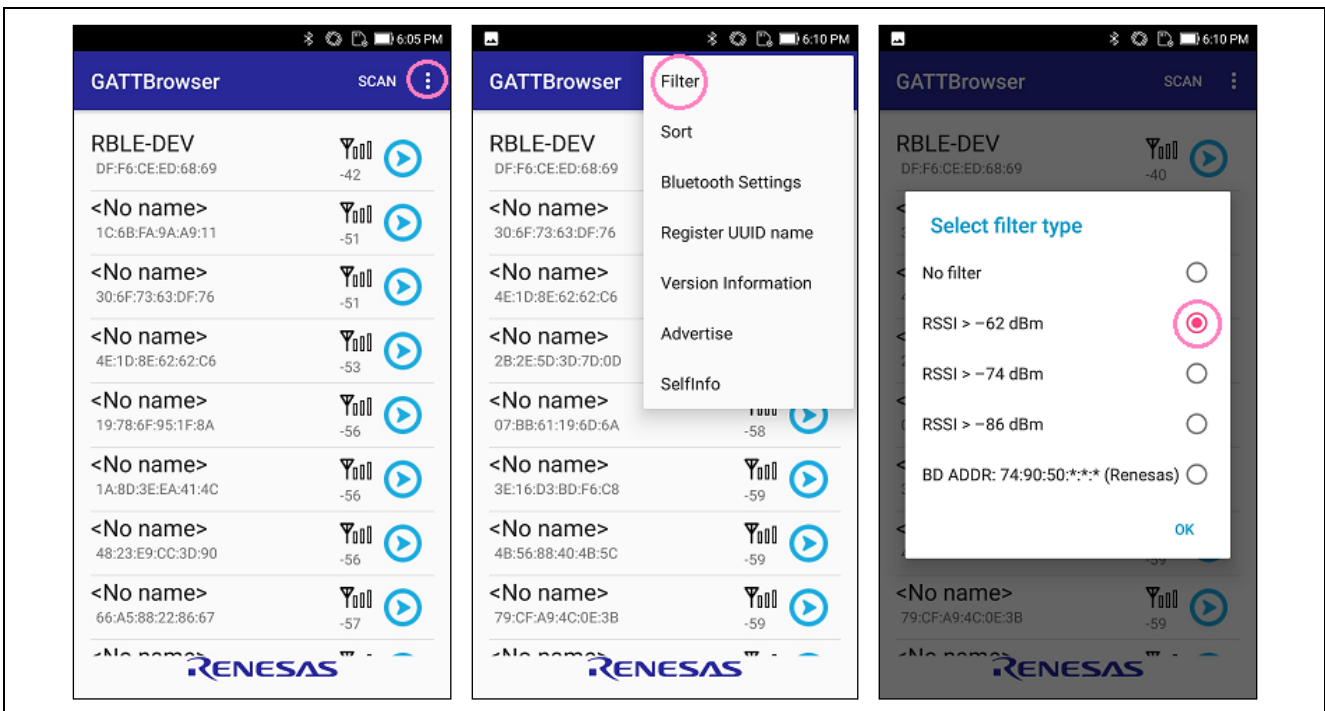

Figure 8. Filter Function

5. Confirm that the following are detected:

- LED Switch Service (UUID: 5883**1926**-5F05-4267-AB01-B4968E8EFCE0)
- Switch State Characteristic (UUID: 5883**7F57**-5F05-4267-AB01-B4968E8EFCE0)
- LED Blink Rate Characteristic (UUID: 5883**C32F**-5F05-4267-AB01-B4968E8EFCE0)

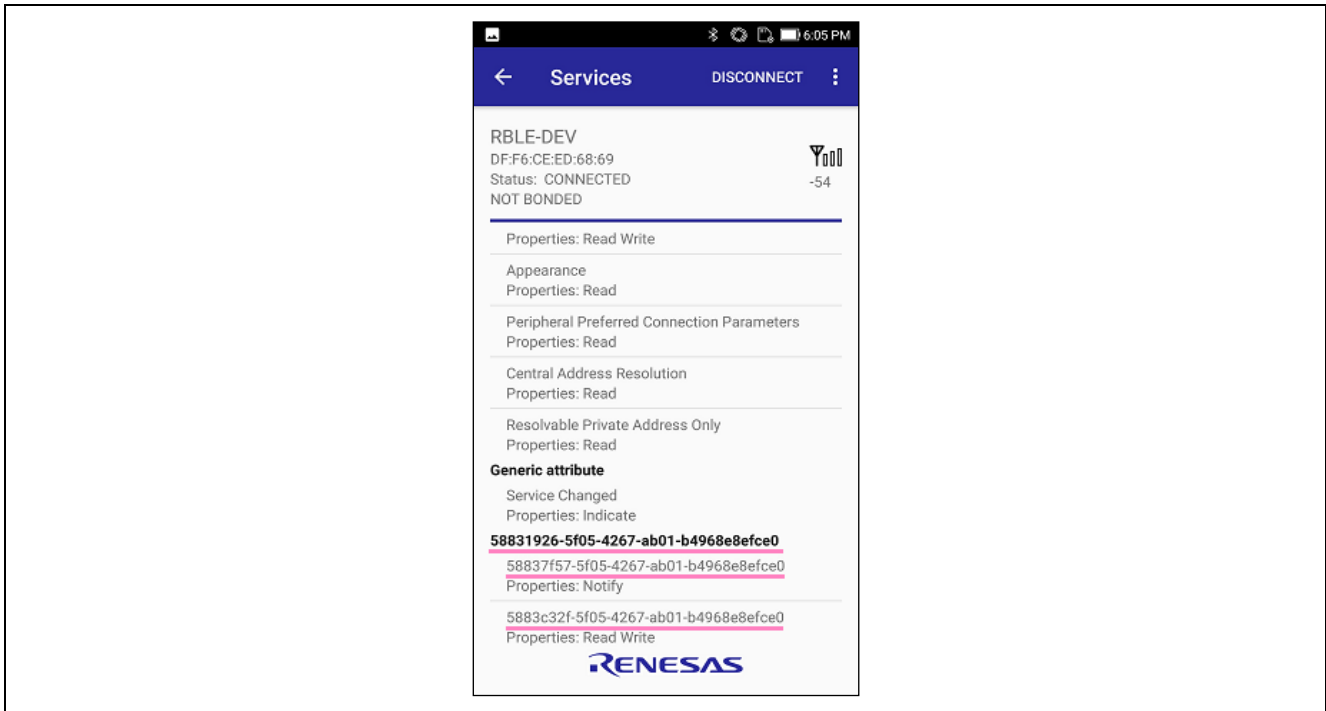

Figure 9. Confirmation of Connection Establishment

6. Tap the Switch State characteristic to notify the smartphone of pressing **SW1** on this product.

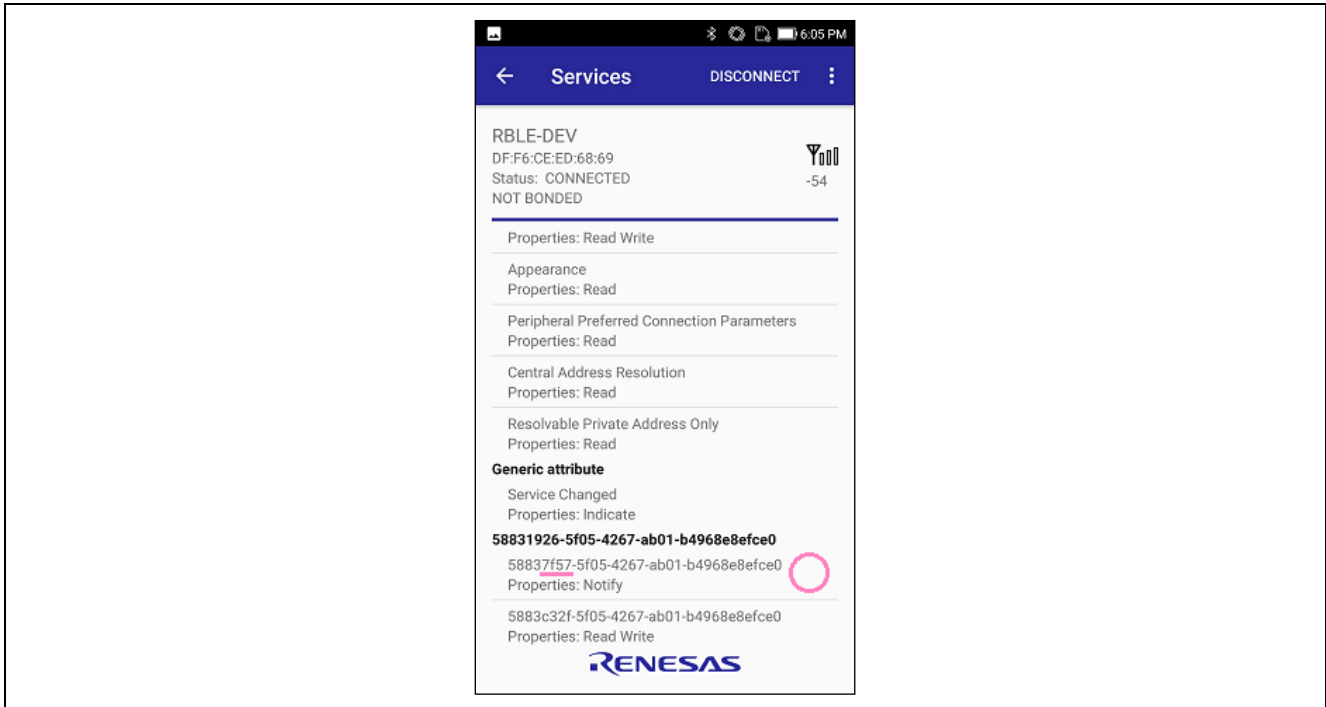

Figure 10. Selecting Switch State Characteristic

7. Allow notifications from your smartphone. Tap the **Notification Off** button to change the display to **Notification On**.

Note: In the iOS version of **GATTBrowser**, tapping the **Enable Notification** button will change the display to **Disable Notification**.

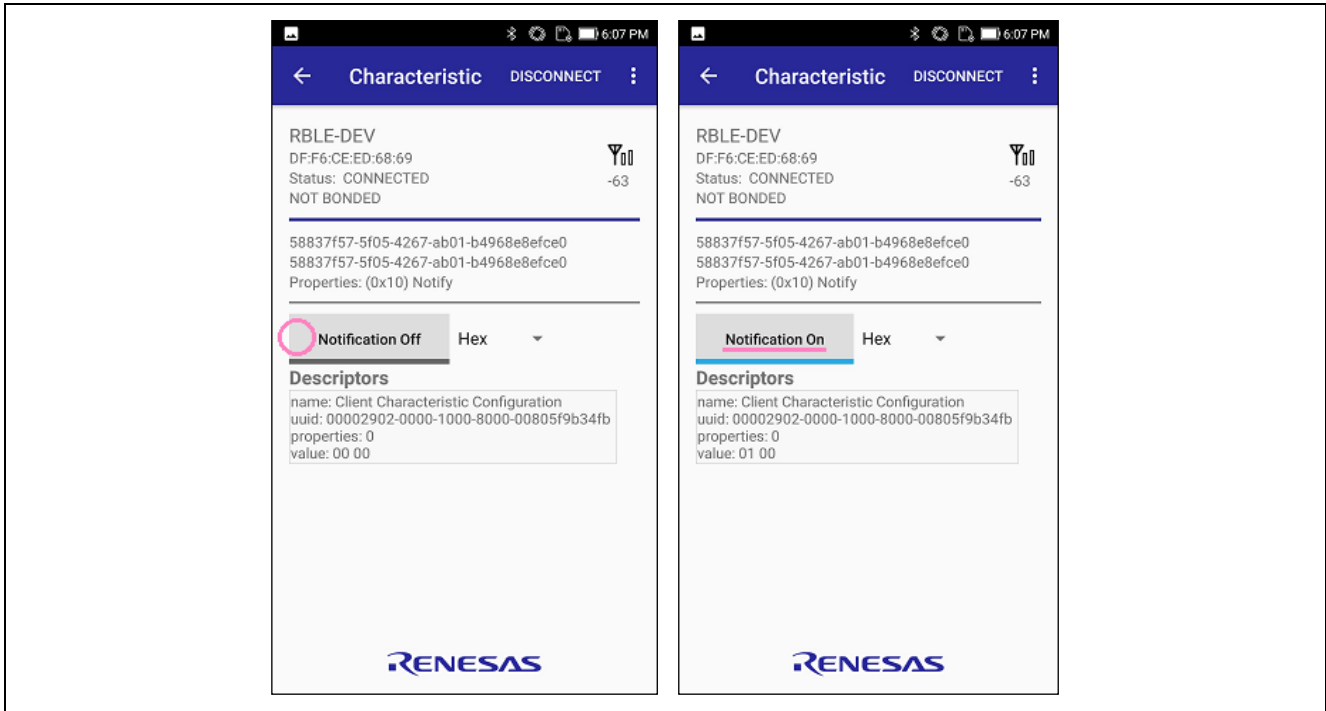

Figure 11. Allowing Notifications

8. When **SW1** on this product is pressed, "01" is notified to **GATTBrowser**.

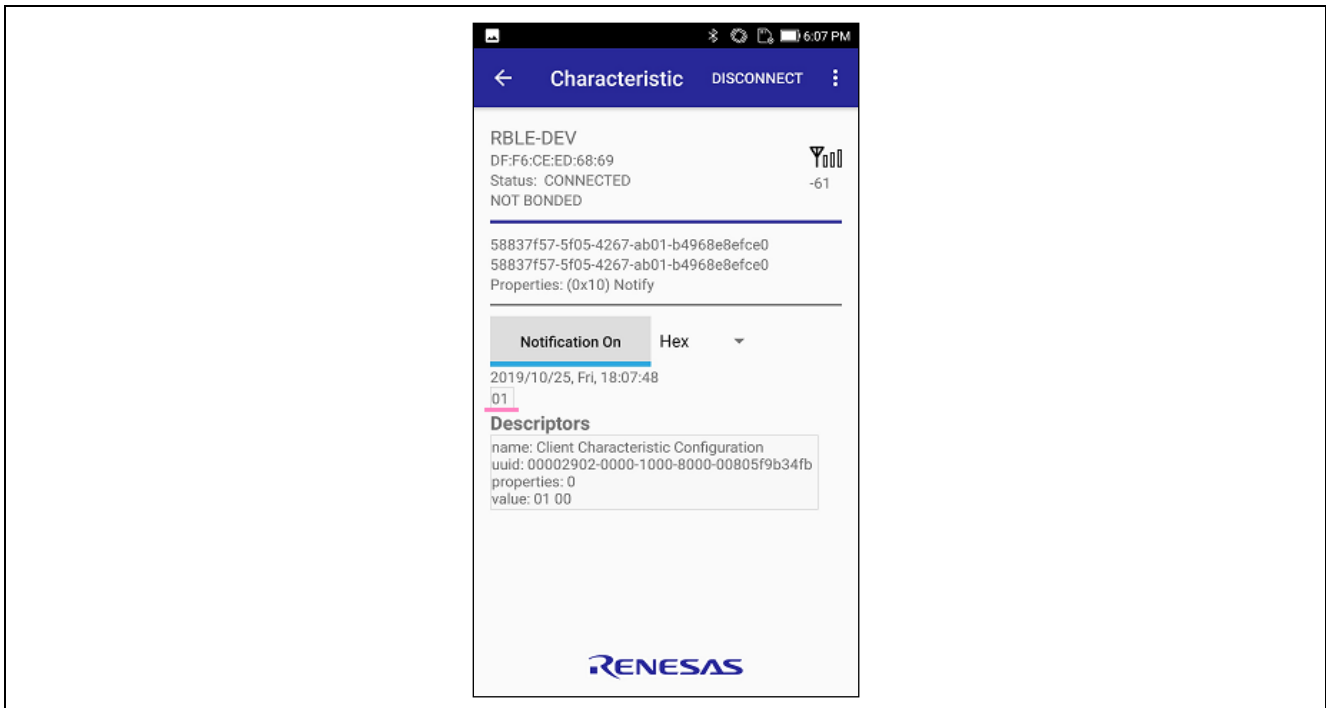

Figure 12. Switch Status Notification

- 9. Return to the previous screen.
- 10. Tap the LED Blink Rate characteristic to change the LED0 blink rate from your smartphone.

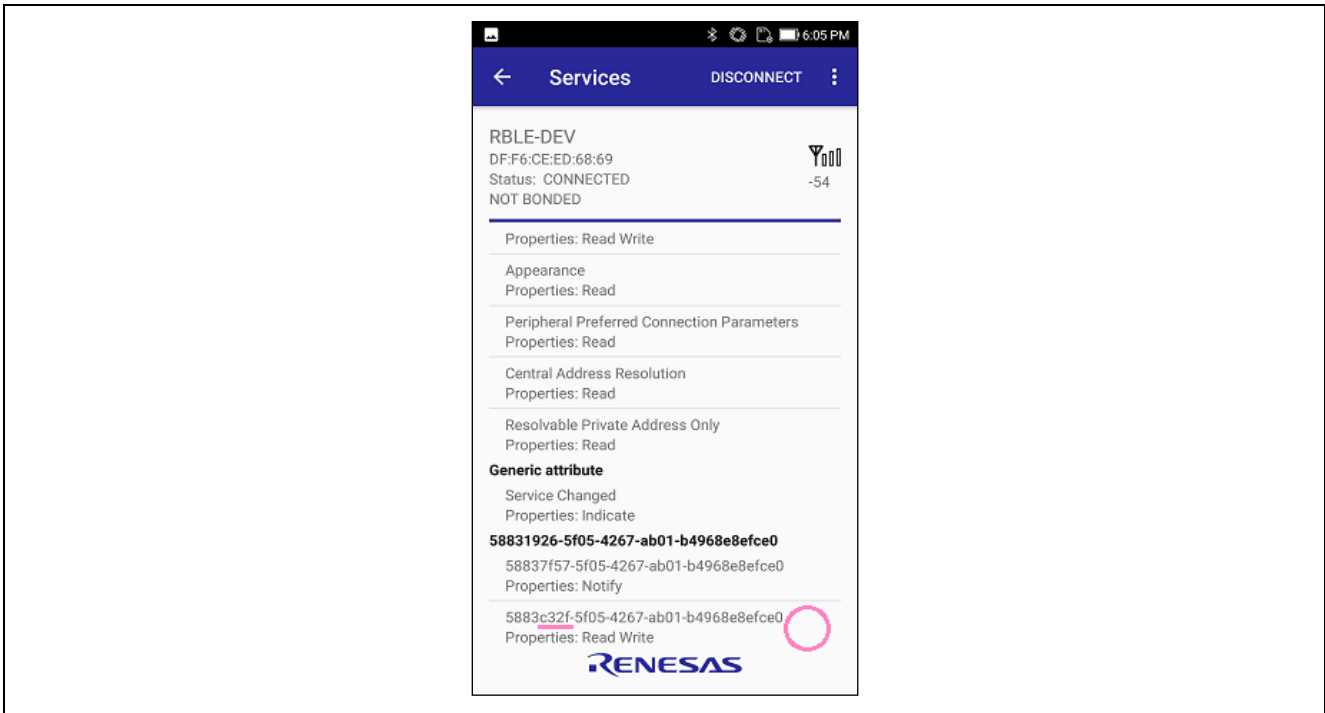

Figure 13. Selecting LED Blink Rate Characteristic

- 11. Enter a 2-digit hexadecimal number in the text box and tap the **Write** button. LED0 blinks at intervals proportional to the entered value. Entering 00 turns off LED0.

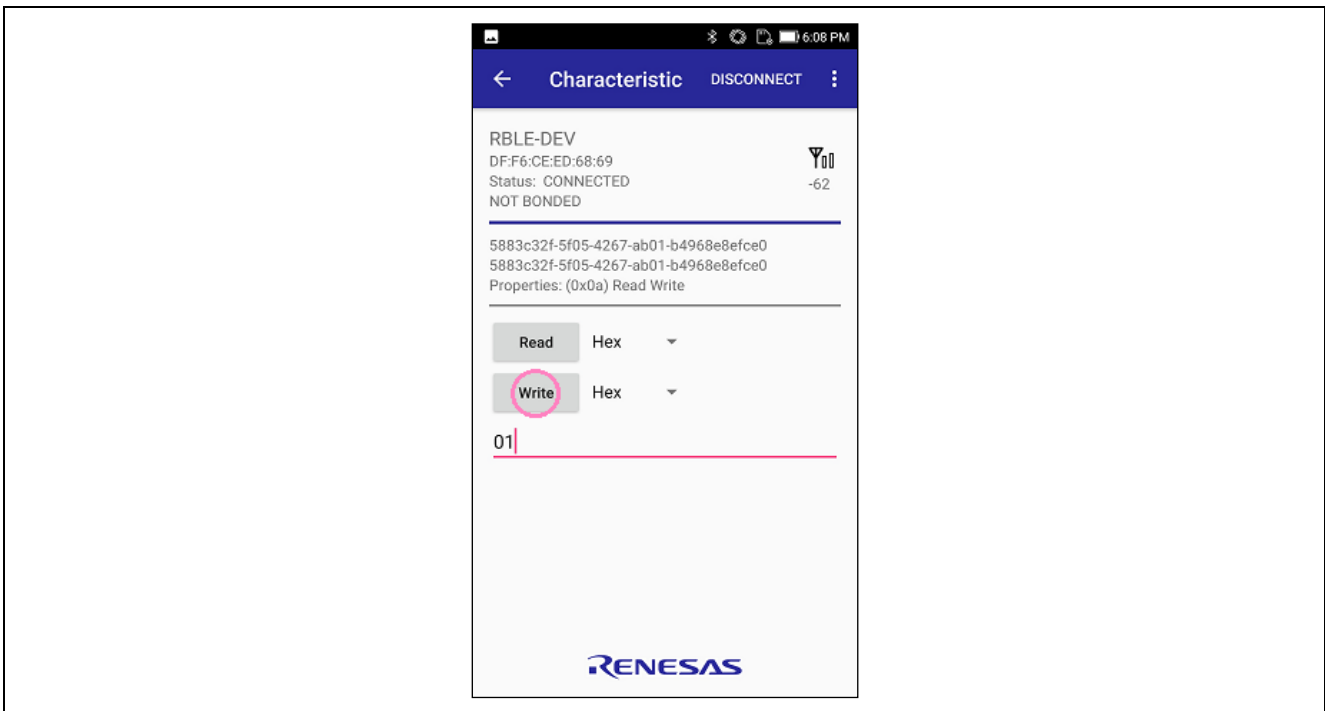

Figure 14. LED Blink Control

- 12. When disconnected, this product will return LED0 to blinking and restart Advertising.

5. Evaluating the Functionality

This section describes how to connect the RA4W1 evaluation tool Bluetooth Test Tool Suite (hereafter referred to as **BTTS**) for Bluetooth function evaluation. Obtain the BTTS package in advance for the following procedure - Bluetooth Test Tool Suite package (R01AN4554).

5.1 Programming HCI Firmware

To use BTTS, it is necessary to program HCI firmware to this product. The on-board programming functionality is provided using Renesas S124 Debug MCU and [SEGGER J-Link® firmware](#). Programming USB Micro-B connector (ECN1) connects the S124 Debug MCU, allowing re-programming the target RA MCU firmware.

1. Change ESW1-2 of this product to ON and connect your PC and ECN1 connector with an A – micro B type USB cable.

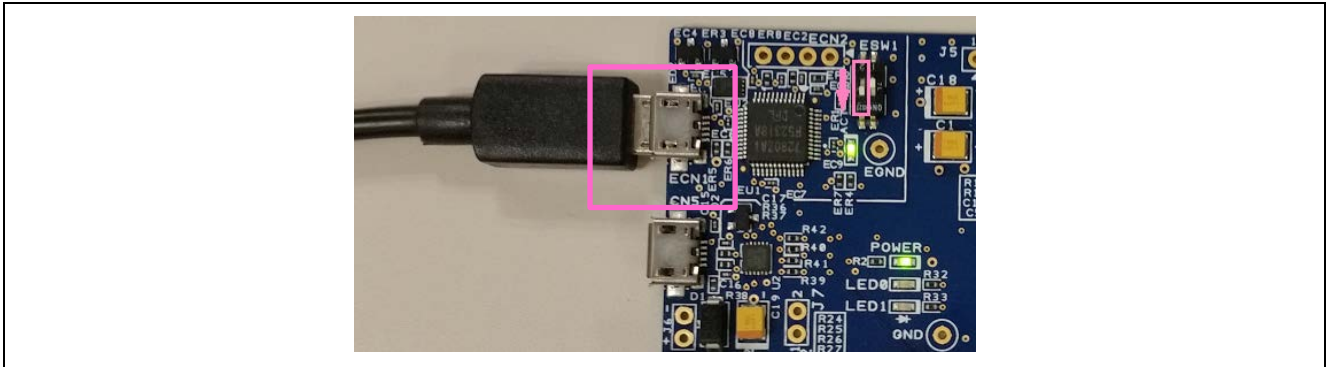

Figure 15. Connecting to PC for Programming HCI Firmware

2. Binary files of HCI firmware are shown as follows. These files include this document. Select the correct file for the preferred UART baud rate, then program the evaluation MCU.

File Name	SCI port No. / Baud rate
ra4w1_uart_hci_sci4_br115k_v1.00.srec	SCI4 / 115200 bps
ra4w1_uart_hci_sci4_br2000k_v1.00.srec	SCI4 / 2000000 bps

3. After programming is complete, disconnect the USB cable that connects this product to your PC.

5.2 Connecting BTTS

1. Change ESW1-2 of this product to OFF and connect your PC and CN5 connector with an A – micro B type USB cable.

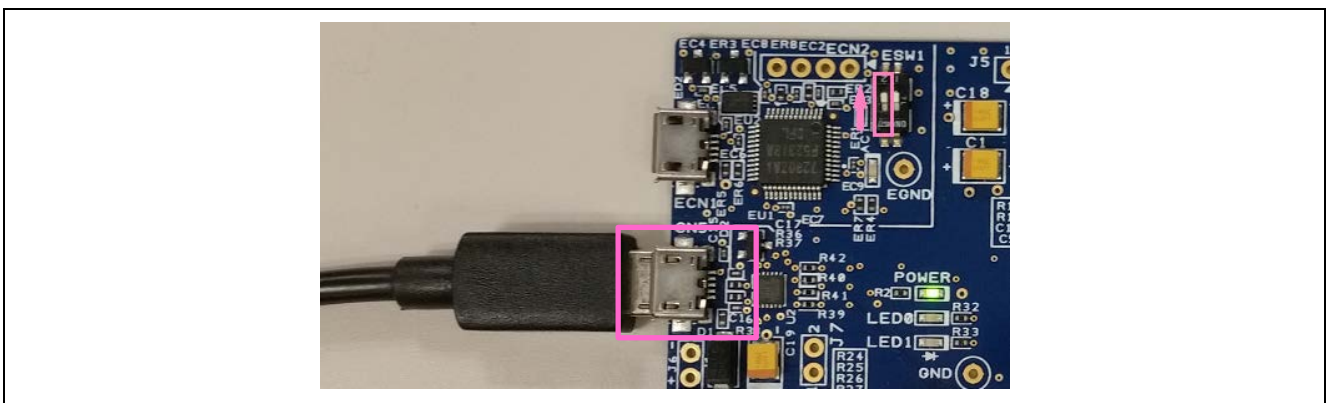

Figure 16. Connecting to PC for Connecting BTTS

2. Refer to the Bluetooth Test Tool Suite operating instructions included in the BTTS package for PC settings and BTTS operation.

6. Restoring Factory Settings

To restore the factory software after programming the HCI firmware and other user programs to this product, use the following steps:

1. The factory software is included in this document archive. If you do not have it already, search for the document “EK-RA4W1 Quick Start Guide (R20QS0015)” on Renesas Electronics website (<https://www.renesas.com/>) and get the accompanying software from the list of downloads.
2. Change ESW1-2 of this product to ON and connect your PC and ECN1 connector with an A – micro B type USB cable.

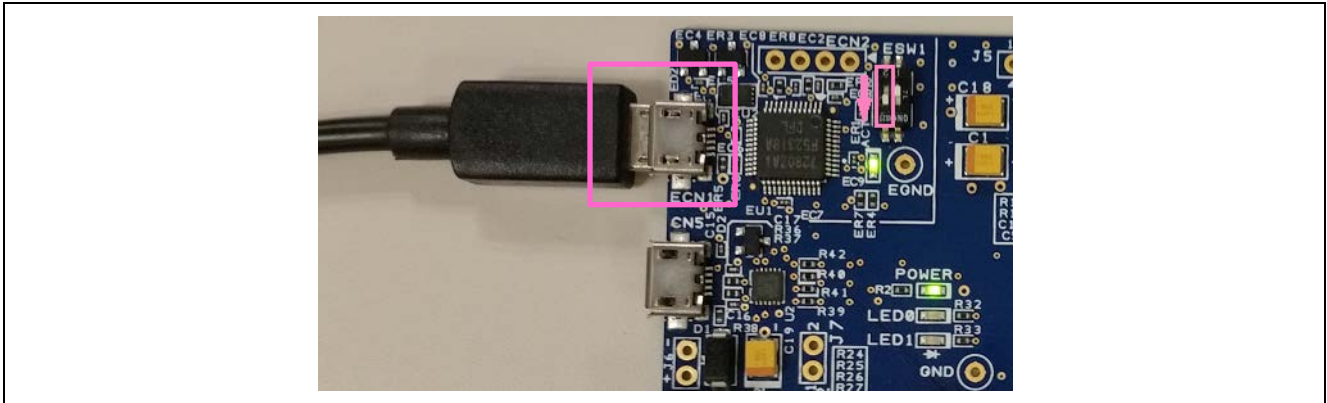

Figure 17. Connecting to PC for Programming Factor Software

3. Program the evaluation MCU using the factory software obtained in step 1 (`./bin/r20qs0015.srec`). The J-Link Software “J-Flash” or “J-Flash Lite” should be used to reprogram the factory software.

7. Website and Support

Visit the following URLs to learn about the kit and the RA family of microcontrollers, download tools and documentation, and get support.

EK-RA4W1 Resources	renesas.com/ra/ek-ra4w1
RA Product Information	renesas.com/ra
RA Product Support Forum	renesas.com/ra/forum
Renesas Support	renesas.com/support

Revision History

Rev.	Date	Description	
		Page	Summary
1.00	Apr.16.20	—	Initial release
1.01	May.22.20	—	Updated link to download IDE in section 2

EK-RA4W1 – Quick Start Guide

Publication Date: May.22.20

Published by: Renesas Electronics Corporation

EK-RA4W1 – Quick Start Guide