

Ground Potential Differences: Origin and Remedies

Introduction

Industrial RS-485 networks often span long distances. A single bus segment, which is the direct link between remote bus nodes without a repeat function in between, can reach up to 1200m (4000ft) in length.

Since bus nodes receive their voltage supplies from different locations within the electrical installation, nodes remotely located from one another can experience large differences in ground potential.

Ground Potential Differences (GPDs) are the main contributor to the overall Common-Mode Voltage, V_{CM} , on a data link (Figure 1), and thus present the main cause for corrupted data transmission and even transceiver damage, when exceeding the transceiver Common-Mode Voltage Range (CMVR).

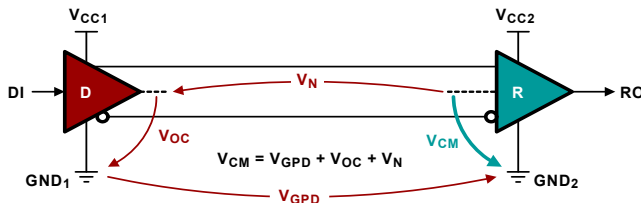

FIGURE 1. COMMON-MODE VOLTAGES IN A DATA LINK

Ground potential differences originate as voltage differences between remote Protective Earth (PE) locations within the electrical installation or mains system. The voltage differences are caused by the large neutral currents of nonlinear loads. Depending on the applied earthing system, these voltages appear at the various PE locations as attenuated or non-attenuated voltage potentials.

The PE potentials are then projected onto the bus node ground through the bus node power supply, whose DC output ground is usually connected to the local PE.

To help designers develop networks immune to ground potential differences, this application note explains the origin and waveforms of GPDs in detail, and suggests design solutions for various common-mode voltage ranges.

Linear and Nonlinear Loads

Office and factory buildings typically operate a large number of linear and nonlinear loads. The category of linear loads mainly consists of incandescent lamps. Nonlinear loads however, consists of a wide range of diverse equipment, including PCs, laser printers, fluorescent tubes, heater controls, uninterruptible power supplies, and variable speed drives.

While the phase currents of linear loads are sinusoidal, nonlinear loads often introduce large harmonics that distort phase currents, see Figure 2.

This harmonic content mainly consists of the 3rd and 5th harmonics of the 50/60Hz mains frequency. At peak

consumption times, the vector sum of a distorted phase current, consisting of the fundamental and all harmonics, can exceed the fundamental phase current by more than 100%.

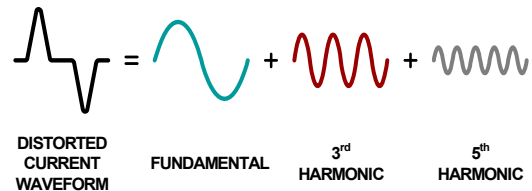

FIGURE 2. HARMONIC CONTENT OF A DISTORTED PHASE CURRENT

Since the neutral conductors of the electrical installation merge into one large conductor near the transformer (Figures 5 and 6), the magnitude of the total neutral current depends on the load type.

For linear loads, this current is small as the neutral currents of different phases cancel each other. The remaining current is mainly due to load imbalance (Figure 3).

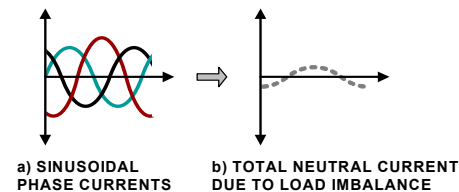

FIGURE 3. SINUSOIDAL PHASE CURRENTS AND TOTAL NEUTRAL CURRENT FOR LINEAR LOADS

In the case of nonlinear loads, however, the sum of the individual distorted neutral currents of different phases, results in a total neutral current, mainly consisting of the 3rd harmonic of the 50/60Hz mains frequency (Figure 4).

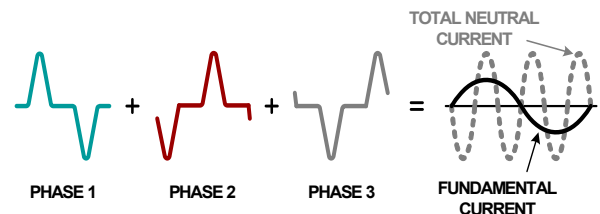

FIGURE 4. TOTAL NEUTRAL CURRENT MAINLY CONSISTS OF 3RD HARMONICS

Generally, it can be said that the neutral currents of nonlinear loads generate higher voltage drops across the line resistances within the electrical installation than linear loads.

Earthing Systems

The two most commonly applied earthing schemes are the TN-C-S and TN-C systems, shown in Figures 5 and 6.

TN stands for French Terre Neutral, meaning the Neutral is grounded to Earth at the mains transformer. The letter C indicates the combined use of Protective Earth and Neutral via one conductor, from the transformer to the service entrance, designated as PEN. The letter S indicates the separate runs of PE and neutral conductors through the entire installation.

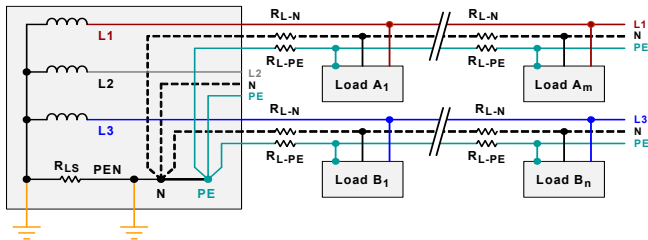

FIGURE 5. TN-C-S SYSTEM WITH LOW GPDS

The TN-C-S system largely removes ground potential differences by combining all PE-conductors to a star within the distribution panel. In addition, the star connections of the system's neutral and PE conductors receives a second grounding to Earth, thus reducing the equipotential at this point and counteracting the otherwise large voltage drop across the source line resistance R_{LS} of the PEN.

The TN-C system is an older grounding scheme, which has regained in interest due to the cost savings achieved by avoiding the run of a separate PE conductor.

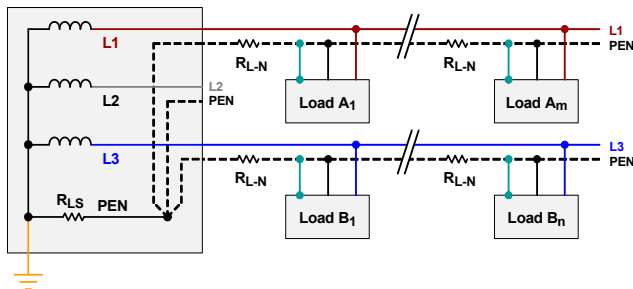

FIGURE 6. TN-C SYSTEM WITH HIGHER GPDS

Here the PEN runs through the entire system up to a distribution point, such as a sub-panel, close to the actual loads, where it is split into separate PE and neutral conductors that directly connect to the loads.

This grounding method has a major drawback. Since the split into PE and neutral occurs close to a load, the PE acts as a voltage sensor, tracking the voltage drop across the line resistance of the neutral conductor, R_{L-N} .

The voltage at this point can be large due to the flow of high neutral currents generated by nonlinear loads. TN-C systems, therefore, have the potential to cause large PE potential differences between remote loads.

For a given contingent of nonlinear loads, TN-C earthing will generate larger differences in PE potentials than the TN-C-S scheme. Making matters more complex, many companies have applied both earthing schemes during the various expansion stages of their mains system.

DC-Ground to Mains Link

The link between the transceiver ground of a bus node and the local PE is provided by the bus node power supply, converting the line voltage into the required transceiver supply.

Figure 7 shows a simplified block diagram of a typical Switched-Mode Power Supply (SMPS), utilized in computers, printers and other equipment.

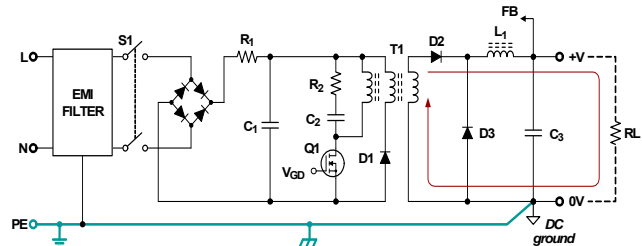

FIGURE 7. SIMPLIFIED SMPS BLOCK DIAGRAM

In most SMPS applications, the DC ground (0V) of the SMPS output connects to the local PE either via an internal connection to the SMPS chassis or through an external wire. With each bus node ground reflecting its local PE potential, the earth potential differences of the mains are thus projected onto the data link as ground potential differences.

Data Link Design

Because layout, wiring, and performance of an electrical installation are outside the designer's control, it is assumed that ground potential differences exist. Therefore, there is the option to either identify bus transceivers that can tolerate large GPDs, or electrically isolate the entire data link from its mains-powered bus node supplies.

Ground potential differences are commonly determined through measurements at various locations in the electrical installation during peak-usage hours. In building and factory automation, GPDs can range from 2V up to 20V. For these applications, Intersil offers various transceiver families with an extended Common-Mode Voltage Range (CMVR), listed in Table 1.

TABLE 1. INTERSIL TRANSCEIVERS WITH EXTENDED CMVR

FAMILY	CMVR (V)	OVP (V)	CABLE INV.	V _{CC} (V)
ISL3243X	±15	±40	Y	3 - 5
ISL3247X	±15	±60	N	5
ISL3245X	±20	±60	Y	3 - 5
ISL3248X	±25	±60	Y	5
ISL3249X	±25	±60	N	5

Figure 8 shows a typical application of a 250kbps data link using ISL32492E. This transceiver operates reliably over a common-mode voltage range of $\pm 25V$. The device also provides fault protection of up to $\pm 60V$ to protect its bus terminals against overvoltages from 24V DC power lines that might get shorted to adjacent running bus lines due to wiring faults or breaks in the cable insulation.

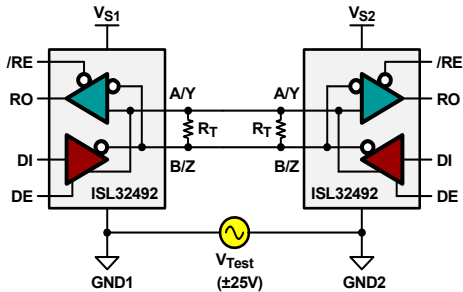

FIGURE 8. 250kbps DATA LINK DESIGN AND TEST FOR $\pm 25V$ GPD USING ISL32492E

In applications, such as variable frequency drives of motor controls, GPDs can reach up to several hundreds of volts. Here the bus node design requires a galvanically isolated transceiver that electrically separates its supply and data lines on the bus side from the ones on the control side (Figure 9).

Since isolation removes the direct link between transceiver ground and local PE, the PE potentials of the mains are no longer projected onto the data link. The transceiver grounds are, therefore, floating and have no common-mode relation between one another.

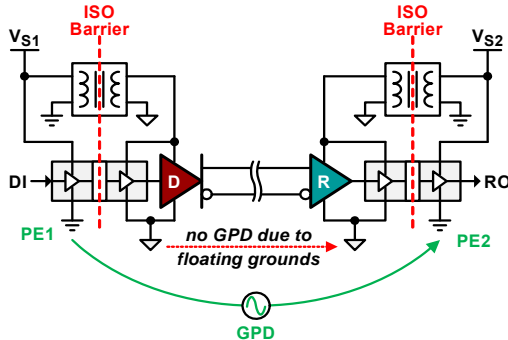

FIGURE 9. GALVANIC ISOLATION PRINCIPLE

Isolated RS-485 transceivers can reliably operate over a common-mode voltage range that is only determined by the isolator's working voltage, which is typically in the range of $\pm 400V$ to $\pm 600V$.

Their design contains a digital signal isolator that blocks high common-mode voltages across the isolation barrier and an RS-485 transceiver with standard CMVR ($-7V$ to $+12V$).

Integrated designs containing both, the isolator and the transceiver dies within the same package, provide significant space savings in space constrained applications.

Figure 10 shows an isolated PROFIBUS interface using the 40Mbps transceiver, IL3685 (NVE Corporation).

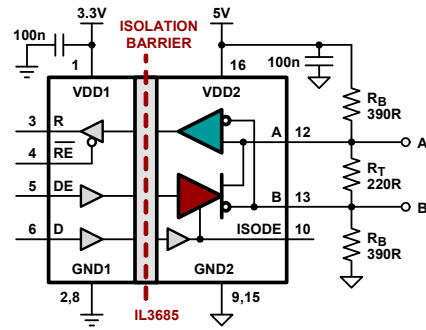

FIGURE 10. ISOLATED PROFIBUS INTERFACE WITH IL3685

Discrete designs utilize stand-alone digital isolators and transceivers. While more space consuming, a discrete design allows the individual selection of isolator and transceiver components based on a device's specific performance features. This enables the fine tuning of certain parameters, such as low-power, low emissions, and maximum drive capability, to the requirements of the respective application.

For example, Figure 11 shows the combination of the ultra-low power, magnetic isolator, ADuM1441, and the micropower transceiver, ISL32601E, for a low-power application with total supply current of $300\mu A$ at 10kbps.

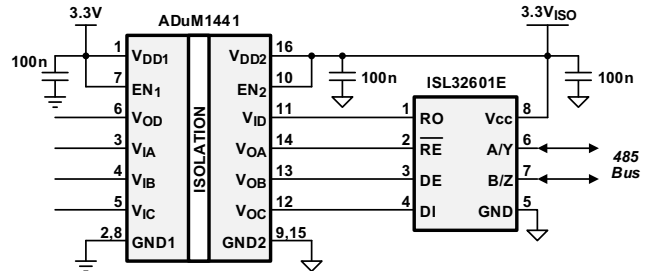

FIGURE 11. ISOLATED LOW-POWER INTERFACE WITH TOTAL SUPPLY CURRENT OF $300\mu A$ AT 10kbps

Figure 12 shows the GMR isolator, IL717, in combination with an ISL3152E transceiver for minimum radiated emissions passing CISPR-22B requirements and a maximum drive capability of $V_{OD-min} = 1.5V$ across a 15Ω differential load, equivalent to a DC load of 12800 ISL3152E transceivers, or a maximum cable length of 8660ft (2640m).

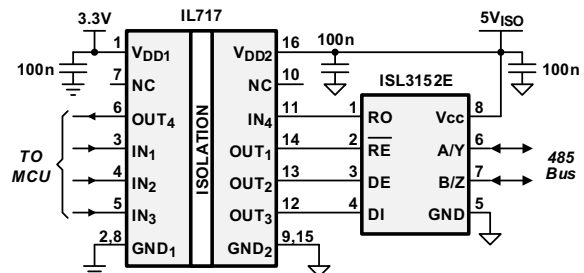

FIGURE 12. ISOLATED RS-485 NODE PASSING CISPR-22B WITH MAXIMUM DRIVE CAPABILITY OF UP TO 12800 TRANSCEIVERS, OR 8660ft (2640m) OF CABLE LENGTH

Summary

Earth potential differences of the mains are projected onto the RS-485 data link via the bus node power supplies. Transceivers with extended common-mode range can operate over ground potential differences of up to $\pm 25\text{V}$. Higher GPDs require isolated transceivers, electrically separating the data link from the mains.

Notice

1. Descriptions of circuits, software and other related information in this document are provided only to illustrate the operation of semiconductor products and application examples. You are fully responsible for the incorporation or any other use of the circuits, software, and information in the design of your product or system. Renesas Electronics disclaims any and all liability for any losses and damages incurred by you or third parties arising from the use of these circuits, software, or information.
2. Renesas Electronics hereby expressly disclaims any warranties against and liability for infringement or any other claims involving patents, copyrights, or other intellectual property rights of third parties, by or arising from the use of Renesas Electronics products or technical information described in this document, including but not limited to, the product data, drawings, charts, programs, algorithms, and application examples.
3. No license, express, implied or otherwise, is granted hereby under any patents, copyrights or other intellectual property rights of Renesas Electronics or others.
4. You shall not alter, modify, copy, or reverse engineer any Renesas Electronics product, whether in whole or in part. Renesas Electronics disclaims any and all liability for any losses or damages incurred by you or third parties arising from such alteration, modification, copying or reverse engineering.
5. Renesas Electronics products are classified according to the following two quality grades: "Standard" and "High Quality". The intended applications for each Renesas Electronics product depends on the product's quality grade, as indicated below.
"Standard": Computers; office equipment; communications equipment; test and measurement equipment; audio and visual equipment; home electronic appliances; machine tools; personal electronic equipment; industrial robots; etc.
"High Quality": Transportation equipment (automobiles, trains, ships, etc.); traffic control (traffic lights); large-scale communication equipment; key financial terminal systems; safety control equipment; etc.
Unless expressly designated as a high reliability product or a product for harsh environments in a Renesas Electronics data sheet or other Renesas Electronics document, Renesas Electronics products are not intended or authorized for use in products or systems that may pose a direct threat to human life or bodily injury (artificial life support devices or systems; surgical implantations; etc.), or may cause serious property damage (space system; undersea repeaters; nuclear power control systems; aircraft control systems; key plant systems; military equipment; etc.). Renesas Electronics disclaims any and all liability for any damages or losses incurred by you or any third parties arising from the use of any Renesas Electronics product that is inconsistent with any Renesas Electronics data sheet, user's manual or other Renesas Electronics document.
6. When using Renesas Electronics products, refer to the latest product information (data sheets, user's manuals, application notes, "General Notes for Handling and Using Semiconductor Devices" in the reliability handbook, etc.), and ensure that usage conditions are within the ranges specified by Renesas Electronics with respect to maximum ratings, operating power supply voltage range, heat dissipation characteristics, installation, etc. Renesas Electronics disclaims any and all liability for any malfunctions, failure or accident arising out of the use of Renesas Electronics products outside of such specified ranges.
7. Although Renesas Electronics endeavors to improve the quality and reliability of Renesas Electronics products, semiconductor products have specific characteristics, such as the occurrence of failure at a certain rate and malfunctions under certain use conditions. Unless designated as a high reliability product or a product for harsh environments in a Renesas Electronics data sheet or other Renesas Electronics document, Renesas Electronics products are not subject to radiation resistance design. You are responsible for implementing safety measures to guard against the possibility of bodily injury, injury or damage caused by fire, and/or danger to the public in the event of a failure or malfunction of Renesas Electronics products, such as safety design for hardware and software, including but not limited to redundancy, fire control and malfunction prevention, appropriate treatment for aging degradation or any other appropriate measures. Because the evaluation of microcomputer software alone is very difficult and impractical, you are responsible for evaluating the safety of the final products or systems manufactured by you.
8. Please contact a Renesas Electronics sales office for details as to environmental matters such as the environmental compatibility of each Renesas Electronics product. You are responsible for carefully and sufficiently investigating applicable laws and regulations that regulate the inclusion or use of controlled substances, including without limitation, the EU RoHS Directive, and using Renesas Electronics products in compliance with all these applicable laws and regulations. Renesas Electronics disclaims any and all liability for damages or losses occurring as a result of your noncompliance with applicable laws and regulations.
9. Renesas Electronics products and technologies shall not be used for or incorporated into any products or systems whose manufacture, use, or sale is prohibited under any applicable domestic or foreign laws or regulations. You shall comply with any applicable export control laws and regulations promulgated and administered by the governments of any countries asserting jurisdiction over the parties or transactions.
10. It is the responsibility of the buyer or distributor of Renesas Electronics products, or any other party who distributes, disposes of, or otherwise sells or transfers the product to a third party, to notify such third party in advance of the contents and conditions set forth in this document.
11. This document shall not be reprinted, reproduced or duplicated in any form, in whole or in part, without prior written consent of Renesas Electronics.
12. Please contact a Renesas Electronics sales office if you have any questions regarding the information contained in this document or Renesas Electronics products.
(Note 1) "Renesas Electronics" as used in this document means Renesas Electronics Corporation and also includes its directly or indirectly controlled subsidiaries.
(Note 2) "Renesas Electronics product(s)" means any product developed or manufactured by or for Renesas Electronics.

(Rev.4.0-1 November 2017)



SALES OFFICES

Renesas Electronics Corporation

<http://www.renesas.com>

Refer to "<http://www.renesas.com/>" for the latest and detailed information.

Renesas Electronics America Inc.
1001 Murphy Ranch Road, Milpitas, CA 95035, U.S.A.
Tel: +1-408-432-8888, Fax: +1-408-434-5351

Renesas Electronics Canada Limited
9251 Yonge Street, Suite 8309 Richmond Hill, Ontario Canada L4C 9T3
Tel: +1-905-237-2004

Renesas Electronics Europe Limited
Dukes Meadow, Millboard Road, Bourne End, Buckinghamshire, SL8 5FH, U.K
Tel: +44-1628-651-700, Fax: +44-1628-651-804

Renesas Electronics Europe GmbH
Arcadiastrasse 10, 40472 Düsseldorf, Germany
Tel: +49-211-6503-0, Fax: +49-211-6503-1327

Renesas Electronics (China) Co., Ltd.
Room 1709 Quantum Plaza, No.27 ZhichunLu, Haidian District, Beijing, 100191 P. R. China
Tel: +86-10-8235-1155, Fax: +86-10-8235-7679

Renesas Electronics (Shanghai) Co., Ltd.
Unit 301, Tower A, Central Towers, 555 Langao Road, Putuo District, Shanghai, 200333 P. R. China
Tel: +86-21-2226-0888, Fax: +86-21-2226-0999

Renesas Electronics Hong Kong Limited
Unit 1601-1611, 16/F., Tower 2, Grand Century Place, 193 Prince Edward Road West, Mongkok, Kowloon, Hong Kong
Tel: +852-2265-6688, Fax: +852-2886-9022

Renesas Electronics Taiwan Co., Ltd.
13F, No. 363, Fu Shing North Road, Taipei 10543, Taiwan
Tel: +886-2-8175-9600, Fax: +886-2-8175-9670

Renesas Electronics Singapore Pte. Ltd.
80 Bendemeer Road, Unit #06-02 Hyflux Innovation Centre, Singapore 339949
Tel: +65-6213-0200, Fax: +65-6213-0300

Renesas Electronics Malaysia Sdn.Bhd.
Unit 1207, Block B, Menara Amcorp, Amcorp Trade Centre, No. 18, Jln Persiaran Barat, 46050 Petaling Jaya, Selangor Darul Ehsan, Malaysia
Tel: +60-3-7955-9390, Fax: +60-3-7955-9510

Renesas Electronics India Pvt. Ltd.
No.777C, 100 Feet Road, HAL 2nd Stage, Indiranagar, Bangalore 560 038, India
Tel: +91-80-67208700, Fax: +91-80-67208777

Renesas Electronics Korea Co., Ltd.
17F, KAMCO Yangjae Tower, 262, Gangnam-daero, Gangnam-gu, Seoul, 06265 Korea
Tel: +82-2-558-3737, Fax: +82-2-558-5338