

Transient Voltage Suppressors: Operation and Features

Introduction

Modern Transient Voltage Suppressors (TVS) or TVS diodes are the most commonly utilized protection components in data transmission systems due to their fast response time, low clamping voltage, and longevity. These solid state P-N junction devices are specifically designed to protect sensitive semiconductors from the damaging effects of transient overvoltages.

TVS diodes are parallel protection elements. Under normal operating conditions they are high-impedance, appearing as an open circuit to the protected component, although a small amount of leakage current is present. During a transient event, the TVS diode junction avalanches providing a low-impedance path for the transient current. Thus, the transient current is diverted away from the protected component and shunted through the TVS diode to ground. The voltage across the protected device is limited to the clamping voltage of the TVS. Once the transient has passed, the TVS returns into high-impedance state.

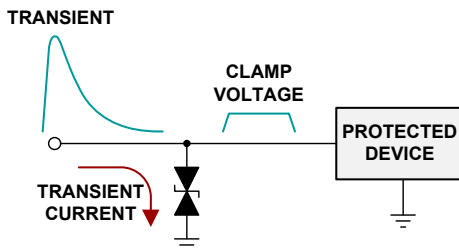

FIGURE 1. TVS SHUNTS PROTECTED DEVICE DURING TRANSIENTS

TVS diodes neither wear out nor degrade parametrically as long as they are operated within specified limits. This robustness along with fast response time and low clamping voltage make TVS diodes ideal for use as board level protectors for RS-485 bus nodes.

The electrical characteristics of TVS diodes are determined by factors such as junction area, doping concentration and substrate resistivity. Their power and surge capability are proportional to the junction area. TVS diodes are constructed with large cross sectional area junctions for absorbing high transient currents. While the I-V characteristic is similar to that of a Zener diode, TVS diodes are specifically designed, characterized and tested for transient suppression, unlike Zener diodes, which are designed and specified for voltage regulation.

TVS diodes are available in a wide range of device structures, operating voltages and junction capacitances. Legacy devices often present single TVS designs for unidirectional or bidirectional operation, with operating voltages from 5V to 440V and junction capacitance of up to 1000pF. Modern TVS designs range from single diodes to diode arrays, can operate down to 2.8V, and possess low junction capacitances of as little as 3pF, thus enabling the transient protection of every single bus node.

Unidirectional TVS Devices

The most basic TVS design is that of a unidirectional TVS diode, shown in Figure 2. Here the TVS diode is reverse-biased during a positive transient. The TVS acts in avalanche mode as the transient current I_1 flows. The spike is clamped at or below the maximum clamping voltage of the device.

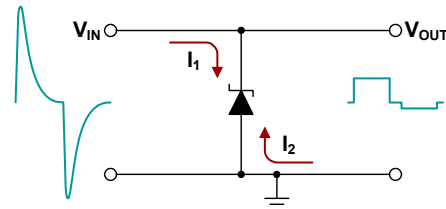

FIGURE 2. CLAMPING ACTION OF A UNIDIRECTIONAL TVS

During the negative transient, the TVS diode is forward-biased and the spike is clamped to one diode drop as the device conducts I_2 in the forward direction.

The V-I characteristic of a unidirectional TVS diode is shown in Figure 3. Because the TVS diode is reverse-biased for positive transient voltages, the V-I characteristic for this mode is drawn in the first quadrant of the diagram.

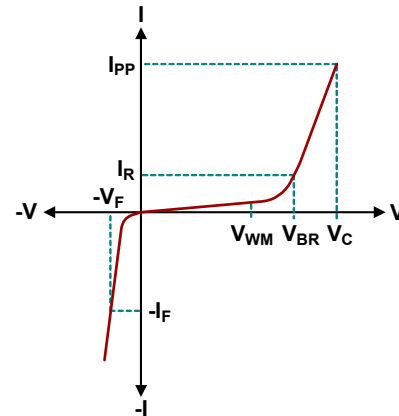

FIGURE 3. V-I CHARACTERISTIC OF A UNIDIRECTIONAL TVS

Here, V_{WM} is the TVS standoff voltage at which the device draws a leakage of maximum $1\mu A$. Thus, V_{WM} is also the maximum possible line voltage of the application up to which the TVS operation does not impact the performance of the protected circuit. The breakdown voltage, V_{BR} , is the voltage where the TVS starts conducting and a TVS current of 1mA flows. V_C is the maximum TVS clamping voltage measured across the device during the application of a pulse current, I_{PP} , for a specified waveform, such as an 8/20 μs or 10/1000 μs transient pulse.

For negative transient voltages the TVS is forward biased. The V-I characteristic for this mode is therefore shown in the third quadrant. Here, V_F is the forward voltage measured across the device for a specified forward current, I_F .

Unidirectional TVS diodes are used across DC power and DC signal lines to protect CMOS components which are highly vulnerable to negative transient voltages below their ground (0V) reference level.

Bidirectional TVS Devices

A bidirectional TVS diode, shown in [Figure 4](#), is reverse biased during both positive and negative transients. Thus, the TVS always acts in Avalanche mode as the transient currents I_1 or I_2 flow. Positive and negative transient voltages are clamped at or below the maximum clamping voltages of the device.

During the positive transient, D_1 conducts in the forward direction and D_2 is reverse biased conducting in avalanche mode. The action is reversed during the negative transient.

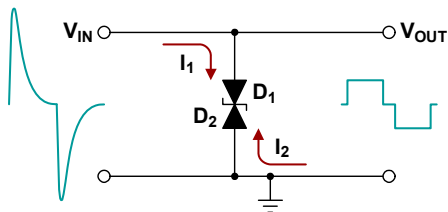

FIGURE 4. CLAMPING ACTION OF A BIDIRECTIONAL TVS

The V-I characteristic of most bidirectional TVS diodes is symmetrical as shown in [Figure 5](#). Bidirectional TVS diodes are used to protect components with symmetric, positive and negative supply rails, and data lines operating over extended common-mode voltage ranges.

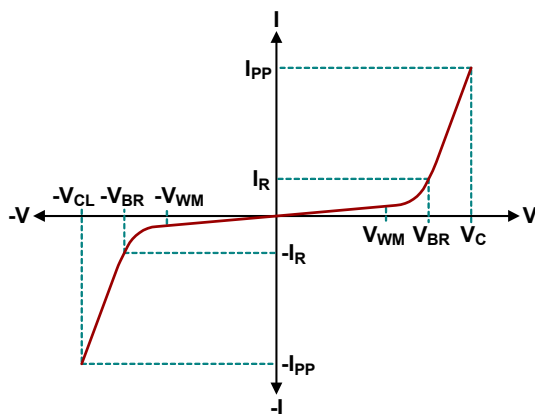

FIGURE 5. V-I CHARACTERISTIC OF A BIDIRECTIONAL TVS

TVS Peak Pulse Power vs Pulse Duration

The peak-pulse power ratings of integrated TVS devices designed for surge suppression ranges from 200W up to 15kW. Most of these devices are rated for the long 10/1000μs current waveform used in telecom applications. Surge tests applied to RS-485 networks however, utilize the much shorter 8/20μs pulse. Therefore, intuitively a TVS rated for a long pulse width should be able to tolerate significantly more power over a much shorter pulse width.

To easily convert the peak-pulse power level from one pulse width to another, TVS datasheets provide a pulse-power versus pulse-width characteristic. An example of a curve for a TVS rated at 200W for a 10/1000μs pulse is shown in [Figure 6](#).

To determine the TVS peak power for an 8/20μs pulse, we start from the initial 200W power level at the 1000μs mark (A), and follow the power rating curve to the 20μs mark (B). Moving horizontally to the left axis yields the new peak pulse power of 0.95kW.

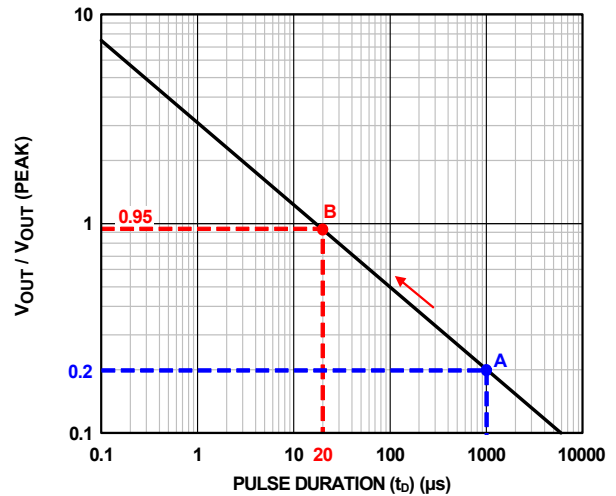

FIGURE 6. PEAK PULSE POWER vs PULSE DURATION

To determine the corresponding peak-pulse current, the new peak-pulse power is divided by the TVS peak clamping voltage, which, according to TVS manufacturers, can be assumed constant for all pulse durations.

The datasheet for the TVS in [Figure 6](#) specifies its peak clamping voltage with 21.5V, thus yielding a peak pulse current of $200W/21.5V = 9.3A$ for the 10/1000μs waveform. For the much shorter 8/20μs waveform, the new peak pulse current is $950W/21.5V = 44.2A$. These results are summarized in [Table 1](#).

TABLE 1. DEVICE PARAMETERS OF 200W TVS, SMF13CA

PART NUMBER	PULSE DURATION, t_D (μs)	PEAK PULSE POWER P_{PP} (W)		MAX. CLAMPING VOLTAGE V_C AT I_{PP} (V)	PEAK PULSE CURRENT I_{PP} (A)	
		+25°C	+85°C		+25°C	+85°C
SMF13CA	10/1000	200	120	21.5	9.3	5.6
	8/20	950	570	21.5	44.2	26.5

TVS Power Derating vs Temperature

TVS datasheets specify peak pulse power ratings for an ambient temperature of $T_A = +25^\circ C$. To prevent the TVS from thermal overload when operating at elevated temperatures, datasheets often provide a pulse-power derating versus temperature curve, shown in [Figure 7](#). Thus, to operate the TVS in [Table 1](#) at +85°C, its peak pulse power and current must be derated to 60% of the specified values at +25°C.

For the 10/1000 μ s pulse, the derated values are $P_{PP-85} = 120W$ and $I_{PP-85} = 5.6A$, and for the 8/20 μ s pulse, $P_{PP-85} = 570W$ and $I_{PP-85} = 26.5A$ (see [Table 1](#)).

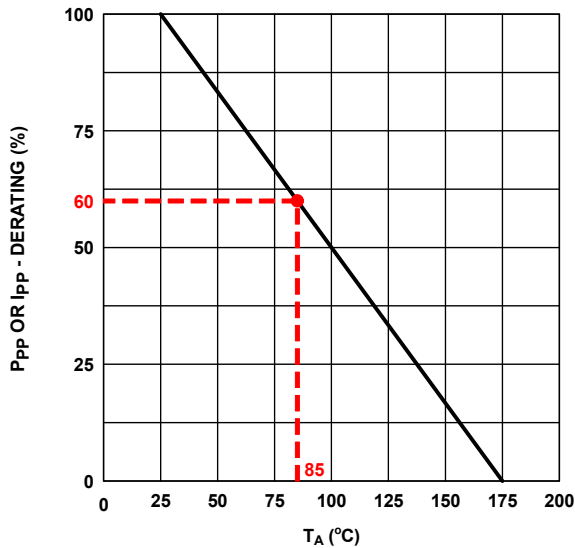

FIGURE 7. PEAK PULSE POWER DERATING vs TEMPERATURE

TVS Junction Capacitance

A TVS device has a junction capacitance resulting from mobile electrons and holes on opposite sides of the P-N junction and depletion layer. This is equivalent to parallel plates with an intervening dielectric layer of silicon in between, thus constituting a basic capacitor. Applying a reverse bias voltage widens the depletion region and decreases the capacitance as the bias voltage is increased.

Low voltage TVS devices with high dopant concentration have a narrow depletion region, producing higher capacitance values. Progressively higher voltage devices have exponentially decreasing levels of dopant and wider depletion regions with a corresponding reduction in capacitance. [Figure 8](#) depicts capacitance versus breakdown voltage for unidirectional and bidirectional, 400W rated TVS devices of the low-cost SMAJ series. The bidirectional TVS diodes have two p-n junctions in series, thus further reducing capacitance.

Similar capacitance graphs for different power rated TVS devices vary proportionally to their rated Peak Pulse Power (P_{PP}). Thus, a 1000W TVS has typically 2.5 times the capacitance of a 400W device with the same standoff voltage rating.

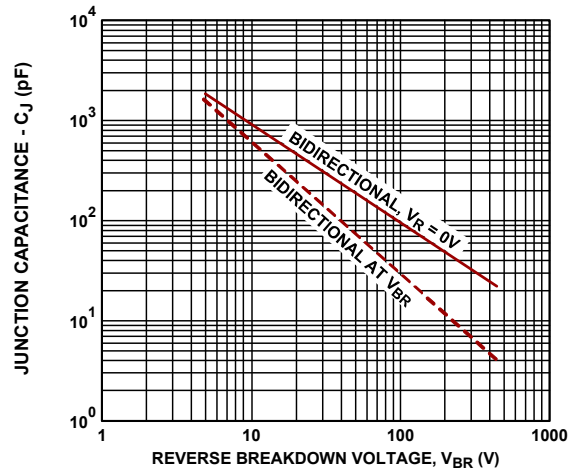

FIGURE 8. CAPACITANCE vs BREAKDOWN VOLTAGE

Typical values for capacitance versus reverse-bias voltage are shown in [Figure 9](#) for five devices of various stand-off voltages, often found in RS-485 applications. Here the junction capacitance drops exponentially as bias voltage is increased since the depletion layer is widening as reverse bias is increased.

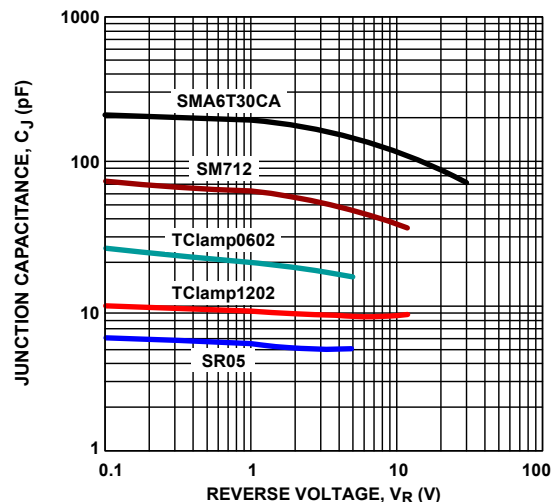

FIGURE 9. CAPACITANCE vs REVERSE BIAS VOLTAGE

At DC operating voltage and low frequencies, the capacitance of a TVS does not affect performance. At higher frequencies however, signal attenuation occurs.

For data transmission applications, such as RS-485, capacitive loading can be effectively reduced by using a low-capacitance rectifier diode in series and in opposite direction to the TVS, as shown in the left leg of the circuit in [Figure 10A](#). With both diodes in series, the total capacitance of the left leg is reduced to the capacitance of the single rectifier diode.

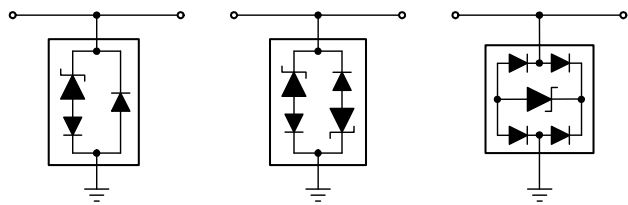

FIGURE 10A. UNIDIRECTIONAL TVS
FIGURE 10B. BIDIRECTIONAL TVS
FIGURE 10C. BIDIRECTIONAL TVS ARRAY

FIGURE 10. LOW CAPACITANCE TVS CONFIGURATIONS

This combination however, only clamps positive transients, for negative transients the left leg remains high-impedance. To protect a data line from positive and negative transients, a second low capacitance diode is added in parallel, thus making the total device capacitance twice that of a single, low capacitance diode.

For symmetrical, bidirectional protection, two of the low capacitance TVS-diode combinations are integrated in an anti-parallel configuration, as shown in Figure 10B. Here the total TVS capacitance will also be twice that of an individual rectifier diode.

Because positive and negative signal or data pulses can affect the charging and discharging of the large capacitance of the avalanche TVS diode, modern TVS designs utilize low capacitance steering diodes in a full-wave rectifier bridge configuration to maintain the TVS capacitance charged and to inherently protect the diodes from either polarity of high voltage transients. The overall capacitance of this combination, shown in Figure 10C, has approximately the same value as that of the low-capacitance TVS in Figure 10A.

TVS Design Cautions

Application examples of transient protected RS-485 nodes often have the TVS diodes directly connected to the transceiver bus terminals. Depending on the transceiver type, standard or fault-protected transceiver, its internal ESD protection circuits might or might not interfere with the clamping action of the external TVS devices during a transient event.

Fault-protected or overvoltage protected (OVP) transceivers, such as Intersil's ISL3245xE and ISL3249xE families, have high stand-off voltages of $V_{I/O} = \pm 60V$ and ESD trigger levels of $V_T = \pm 70V$, which do not impact the operation of external TVS components.

Standard RS-485 transceivers however, have ESD trigger levels close to the TVS breakdown voltage, V_{BR} , thus making an interaction between ESD cells and TVS diodes inevitable.

ESD structures with Zener switching characteristics share the high transient current with the TVSs, while those with snap-back characteristics can actually turn the TVS diodes off, thus being forced to absorb the transient energy by themselves.

Since a surge transient has about 8 million times the energy of an ESD transient of the same peak pulse voltage, an ESD cell is at risk of damage by high surge currents, even when paralleled by an external TVS.

Figures 11 and 12 depict the interactions between a standard transceiver's internal ESD protection and an external TVS for positive transient voltages.

The ESD structure in Figure 11 has a Zener characteristic, similar to the one of the external TVS. Although both clamping structures share the surge current, the energy created within the ESD Zener is far beyond its absorption capability and the Zener burns out.

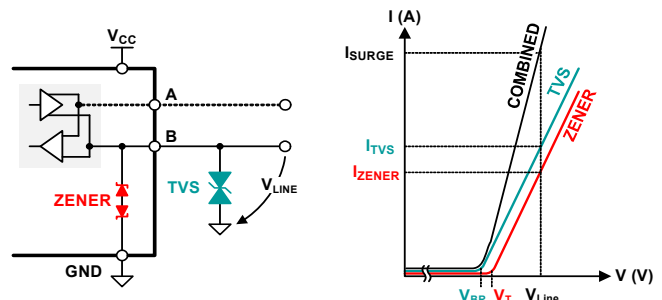

FIGURE 11. TRANSCEIVER DAMAGE DUE TO ZENER SHARING HIGH TRANSIENT CURRENT WITH TVS

The ESD structure in Figure 12 consists of a Silicon Controlled Rectifier (SCR) with snap-back characteristics.

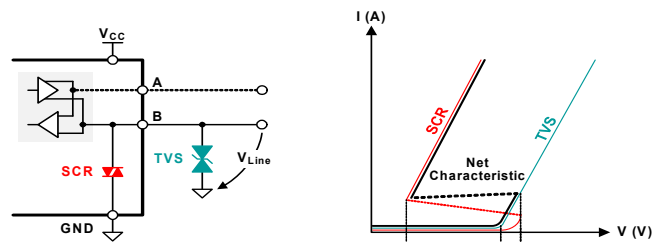

FIGURE 12. TRANSCEIVER DAMAGE DUE TO SCR SHUNTING TVS

Because the TVS breakdown (V_{BR}) is lower than the SCR trigger level (V_T) the TVS starts conducting first. Increasing current causes its clamping voltage, V_C , to rise until it reaches V_T . At this moment, the SCR snaps back to a clamping voltage, V_{SCR} that is below the TVS breakdown, thus turning the TVS off. Again, the energy created within the SCR is beyond its absorption capability and the SCR burns out.

Because of the unfavorable outcome for ESD structures, designers are strongly discouraged from connecting TVSs directly to the bus terminals of standard transceivers.

To design a robust transient protection scheme for RS-485 nodes, designers have two options to choose from:

1. Add current limiting components in series with the bus terminals of standard transceivers, which is discussed in application note AN1978 "Surge Protection for Intersil's Standard RS-485 Transceivers".
2. Use Overvoltage Protected (OVP) transceivers with high stand-off capability, which tolerate high TVS voltages. This is discussed in application note AN1979 "Surge Protection Simplified with Intersil's Overvoltage Protected (OVP) Transceivers".

Notice

1. Descriptions of circuits, software and other related information in this document are provided only to illustrate the operation of semiconductor products and application examples. You are fully responsible for the incorporation or any other use of the circuits, software, and information in the design of your product or system. Renesas Electronics disclaims any and all liability for any losses and damages incurred by you or third parties arising from the use of these circuits, software, or information.
 2. Renesas Electronics hereby expressly disclaims any warranties against and liability for infringement or any other claims involving patents, copyrights, or other intellectual property rights of third parties, by or arising from the use of Renesas Electronics products or technical information described in this document, including but not limited to, the product data, drawings, charts, programs, algorithms, and application examples.
 3. No license, express, implied or otherwise, is granted hereby under any patents, copyrights or other intellectual property rights of Renesas Electronics or others.
 4. You shall not alter, modify, copy, or reverse engineer any Renesas Electronics product, whether in whole or in part. Renesas Electronics disclaims any and all liability for any losses or damages incurred by you or third parties arising from such alteration, modification, copying or reverse engineering.
 5. Renesas Electronics products are classified according to the following two quality grades: "Standard" and "High Quality". The intended applications for each Renesas Electronics product depends on the product's quality grade, as indicated below.
"Standard": Computers; office equipment; communications equipment; test and measurement equipment; audio and visual equipment; home electronic appliances; machine tools; personal electronic equipment; industrial robots; etc.
"High Quality": Transportation equipment (automobiles, trains, ships, etc.); traffic control (traffic lights); large-scale communication equipment; key financial terminal systems; safety control equipment; etc.
Unless expressly designated as a high reliability product or a product for harsh environments in a Renesas Electronics data sheet or other Renesas Electronics document, Renesas Electronics products are not intended or authorized for use in products or systems that may pose a direct threat to human life or bodily injury (artificial life support devices or systems; surgical implantations; etc.), or may cause serious property damage (space system; undersea repeaters; nuclear power control systems; aircraft control systems; key plant systems; military equipment; etc.). Renesas Electronics disclaims any and all liability for any damages or losses incurred by you or any third parties arising from the use of any Renesas Electronics product that is inconsistent with any Renesas Electronics data sheet, user's manual or other Renesas Electronics document.
 6. When using Renesas Electronics products, refer to the latest product information (data sheets, user's manuals, application notes, "General Notes for Handling and Using Semiconductor Devices" in the reliability handbook, etc.), and ensure that usage conditions are within the ranges specified by Renesas Electronics with respect to maximum ratings, operating power supply voltage range, heat dissipation characteristics, installation, etc. Renesas Electronics disclaims any and all liability for any malfunctions, failure or accident arising out of the use of Renesas Electronics products outside of such specified ranges.
 7. Although Renesas Electronics endeavors to improve the quality and reliability of Renesas Electronics products, semiconductor products have specific characteristics, such as the occurrence of failure at a certain rate and malfunctions under certain use conditions. Unless designated as a high reliability product or a product for harsh environments in a Renesas Electronics data sheet or other Renesas Electronics document, Renesas Electronics products are not subject to radiation resistance design. You are responsible for implementing safety measures to guard against the possibility of bodily injury, injury or damage caused by fire, and/or danger to the public in the event of a failure or malfunction of Renesas Electronics products, such as safety design for hardware and software, including but not limited to redundancy, fire control and malfunction prevention, appropriate treatment for aging degradation or any other appropriate measures. Because the evaluation of microcomputer software alone is very difficult and impractical, you are responsible for evaluating the safety of the final products or systems manufactured by you.
 8. Please contact a Renesas Electronics sales office for details as to environmental matters such as the environmental compatibility of each Renesas Electronics product. You are responsible for carefully and sufficiently investigating applicable laws and regulations that regulate the inclusion or use of controlled substances, including without limitation, the EU RoHS Directive, and using Renesas Electronics products in compliance with all these applicable laws and regulations. Renesas Electronics disclaims any and all liability for damages or losses occurring as a result of your noncompliance with applicable laws and regulations.
 9. Renesas Electronics products and technologies shall not be used for or incorporated into any products or systems whose manufacture, use, or sale is prohibited under any applicable domestic or foreign laws or regulations. You shall comply with any applicable export control laws and regulations promulgated and administered by the governments of any countries asserting jurisdiction over the parties or transactions.
 10. It is the responsibility of the buyer or distributor of Renesas Electronics products, or any other party who distributes, disposes of, or otherwise sells or transfers the product to a third party, to notify such third party in advance of the contents and conditions set forth in this document.
 11. This document shall not be reprinted, reproduced or duplicated in any form, in whole or in part, without prior written consent of Renesas Electronics.
 12. Please contact a Renesas Electronics sales office if you have any questions regarding the information contained in this document or Renesas Electronics products.
- (Note 1) "Renesas Electronics" as used in this document means Renesas Electronics Corporation and also includes its directly or indirectly controlled subsidiaries.
(Note 2) "Renesas Electronics product(s)" means any product developed or manufactured by or for Renesas Electronics.

(Rev.4.0-1 November 2017)



SALES OFFICES

Renesas Electronics Corporation

<http://www.renesas.com>

Refer to "<http://www.renesas.com/>" for the latest and detailed information.

Renesas Electronics America Inc.
1001 Murphy Ranch Road, Milpitas, CA 95035, U.S.A.
Tel: +1-408-432-8888, Fax: +1-408-434-5351

Renesas Electronics Canada Limited
9251 Yonge Street, Suite 8309 Richmond Hill, Ontario Canada L4C 9T3
Tel: +1-905-237-2004

Renesas Electronics Europe Limited
Dukes Meadow, Millboard Road, Bourne End, Buckinghamshire, SL8 5FH, U.K
Tel: +44-1628-651-700, Fax: +44-1628-651-804

Renesas Electronics Europe GmbH
Arcadiastrasse 10, 40472 Düsseldorf, Germany
Tel: +49-211-6503-0, Fax: +49-211-6503-1327

Renesas Electronics (China) Co., Ltd.
Room 1709 Quantum Plaza, No.27 ZhichunLu, Haidian District, Beijing, 100191 P. R. China
Tel: +86-10-8235-1155, Fax: +86-10-8235-7679

Renesas Electronics (Shanghai) Co., Ltd.
Unit 301, Tower A, Central Towers, 555 Langao Road, Putuo District, Shanghai, 200333 P. R. China
Tel: +86-21-2226-0888, Fax: +86-21-2226-0999

Renesas Electronics Hong Kong Limited
Unit 1601-1611, 16/F., Tower 2, Grand Century Place, 193 Prince Edward Road West, Mongkok, Kowloon, Hong Kong
Tel: +852-2265-6688, Fax: +852-2886-9022

Renesas Electronics Taiwan Co., Ltd.
13F, No. 363, Fu Shing North Road, Taipei 10543, Taiwan
Tel: +886-2-8175-9600, Fax: +886-2-8175-9670

Renesas Electronics Singapore Pte. Ltd.
80 Bendemeer Road, Unit #06-02 Hyflux Innovation Centre, Singapore 339949
Tel: +65-6213-0200, Fax: +65-6213-0300

Renesas Electronics Malaysia Sdn.Bhd.
Unit 1207, Block B, Menara Amcorp, Amcorp Trade Centre, No. 18, Jln Persiaran Barat, 46050 Petaling Jaya, Selangor Darul Ehsan, Malaysia
Tel: +60-3-7955-9390, Fax: +60-3-7955-9510

Renesas Electronics India Pvt. Ltd.
No.777C, 100 Feet Road, HAL 2nd Stage, Indiranagar, Bangalore 560 038, India
Tel: +91-80-67208700, Fax: +91-80-67208777

Renesas Electronics Korea Co., Ltd.
17F, KAMCO Yangjae Tower, 262, Gangnam-daero, Gangnam-gu, Seoul, 06265 Korea
Tel: +82-2-558-3737, Fax: +82-2-558-5338