

## Introduction

This app note will explain how to create an Unlocked Quadrature Decoder with a GreenPAK4 device. Quadrature Decoders translate signals received from Quadrature Encoders similar to the one shown in Figure 1. They are used in a mechanical system to determine rotation around an axis.

Since this Quadrature Decoder is unlocked, it will consume less power than a clocked version. The GreenPAK design shown in Section 2 of this App Note only includes digital components, so when the inputs are static the device has very low current consumption.

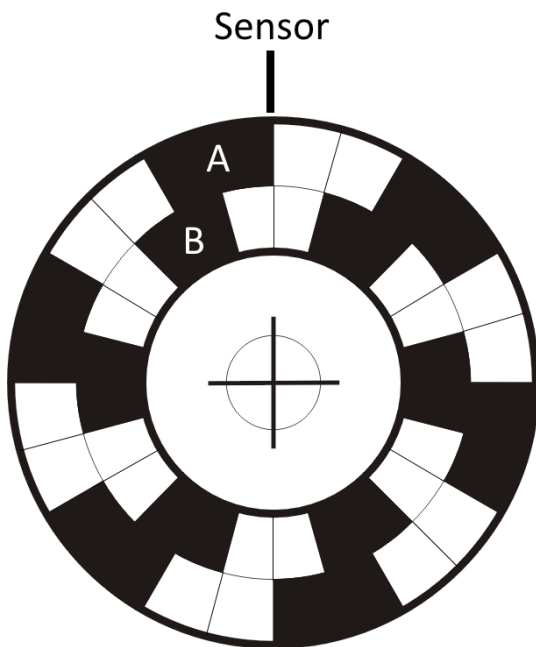

Figure 1. Quadrature Encoder

## Quadrature Decoder

Think of the dial controller used in to control the volume in a digital radio. As you turn the dial clockwise and counterclockwise, you are able to increase and decrease the volume of the radio. Quadrature signals are used to interface between the dial rotation information and the radio's microcontroller.

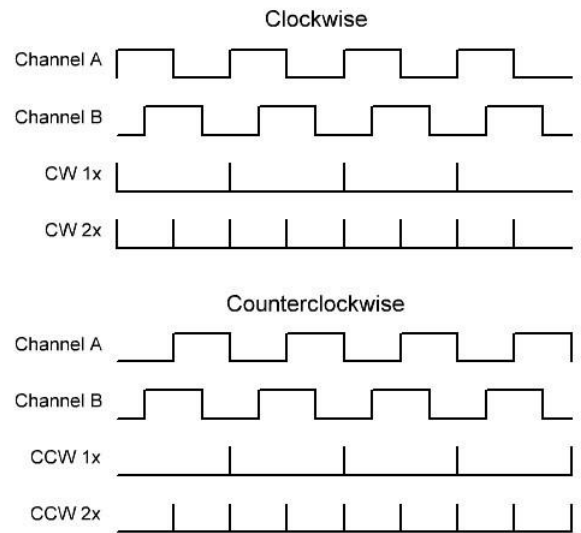

Figure 2. Quadrature signals

Quadrature decoders generate two square waves, which are typically designated as Channel A and Channel B. These signals have a 90 degree phase difference as shown in Figure 2. The state transition outputs, or the rising and falling edges of Channel A, can be used to determine the degree of dial rotation or number of steps moved. In this application, there are two possible units of measurement: 1x and 2x.

Take a look back at Figure 1. When Channel A's rising edge leads Channel B, the rotation around the axis is in the clockwise direction. Alternately, when Channel B leads Channel A, the rotation occurs in the counterclockwise direction. In Figure 2, if you count the number of rising edges on Channel A in the clockwise direction, you can conclude that the axis moved by 4 steps. However, if you count both rising and falling edges of Channel A, the axis moved by 8 steps. The further the mechanical dial turns, the more pulses are generated.

Figure 3 illustrates the transitions and outputs for a Quadrature Decoder in a state machine format.

In this App Note we will design a system that receives three inputs and has two outputs. The first two inputs are the Channel A and Channel B quadrature signals, while the third input is a selector bit to control whether the outputs will be 1x or 2x as shown in Figure 2. One output indicates clockwise movement (CW) and the other counterclockwise movement (CCW).

### GreenPAK Design

In order to create our output pulses, we need to look at state transitions. We used 2-L0 and 2-L1 to create a delayed version of the Channel A signal, and did the same thing with 2-L2 and 2-L3 for Channel B. This technique allows us to compare the previous state to the current state.

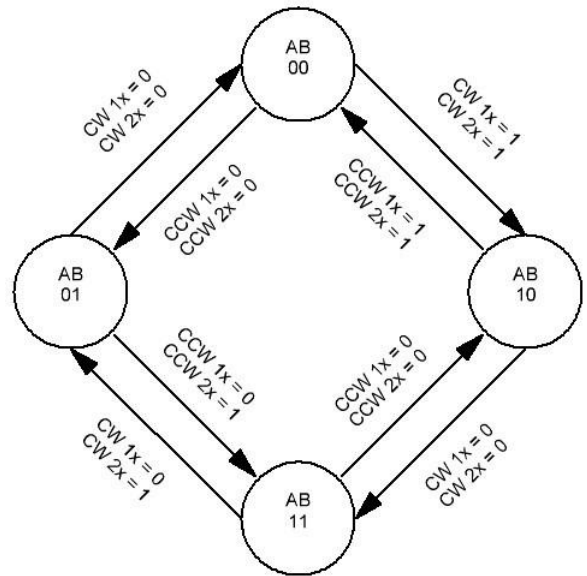

Figure 3. Quadrature Decoder State Machine

Input 1x/2x from Pin 2 is a selector bit used in Look-Up Tables 3-bit LUT4 and 3-bit LUT5 to determine whether the outputs should have 1x resolution or 2x resolution. When Pin 2 is LOW, the resolution is 1x. When it is HIGH, the resolution is 2x.

Figure 4 lists the conditions under which the four LUTs will go HIGH. These LUT outputs generate the bits which determine when the CW and CCW outputs will go HIGH. Each output is dependent on the signals A\_DEL, B\_DEL, A, and B. (A\_DEL and B\_DEL are the delayed A and B signals.)

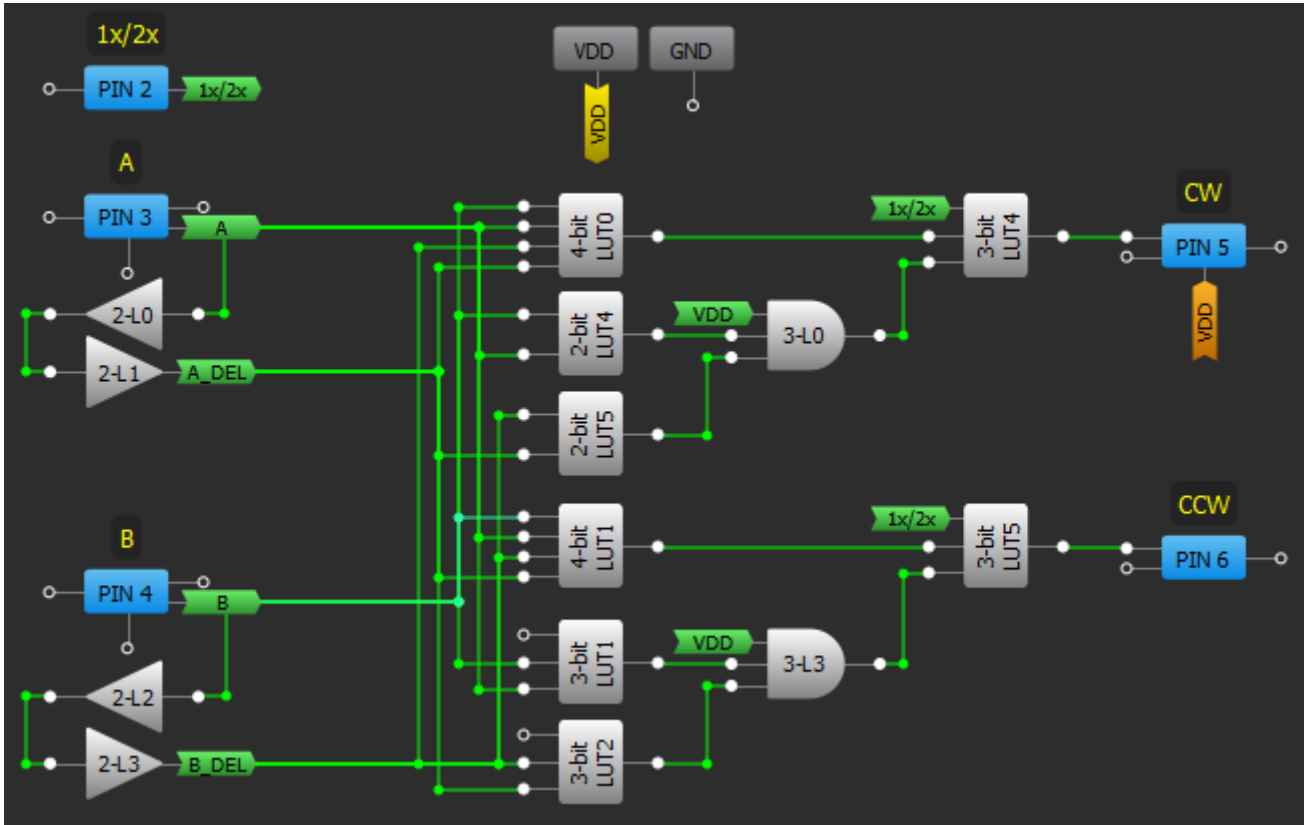

Figure 4. GreenPAK Designer File

LUT	A_DEL	B_DEL	A	B	OUTPUT
4-bit LUT0	1	1	0	1	CW 2x
3-bit LUT0	0	0	1	0	CW 1x
4-bit LUT1	0	1	1	1	CCW 2x
3-bit LUT3	1	0	0	0	CCW 1x

Table 1. LUT Inputs and Outputs

## Waveforms

- D0 – PIN#2 Input 1x/2x
- D1 – PIN#3 Input A
- D2 – PIN#4 Input B
- D3 – PIN#5 Output CW
- D4 – PIN#6 Output CCW

Since the 1x/2x signal stays low in Table 1, the output pulses occur once every period. With 1x/2x enabled in Figure 5, the output pulses occur twice per period.

Figure 7 and Figure 8 show what happens if the dial is moved back and forth over a very small degree of rotation.

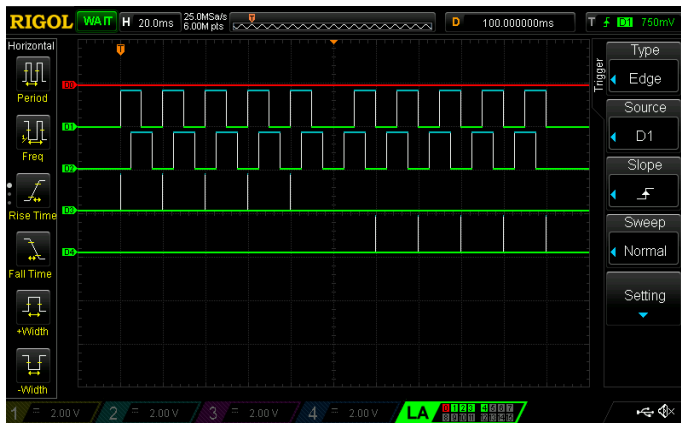

Figure 5. 1x Back and Forth Rotation

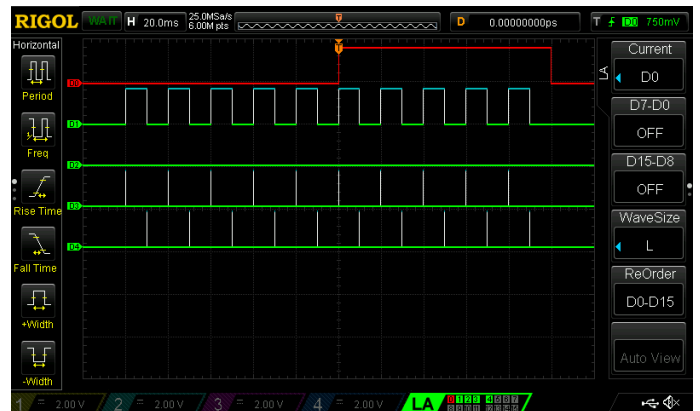

Figure 7. Small Degree Rotation Scenario 1

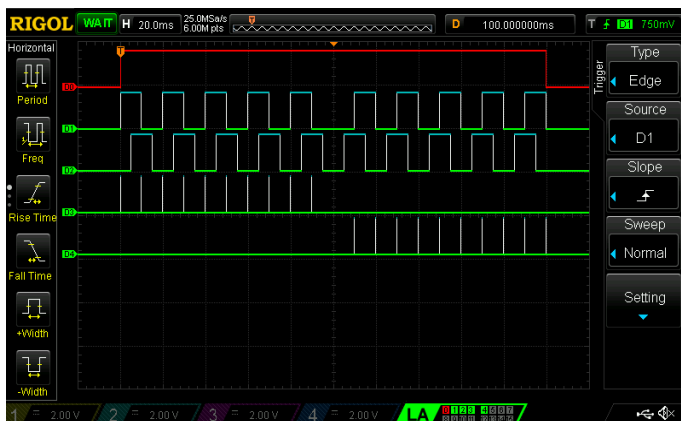

Figure 6. 2x Back and Forth Rotation

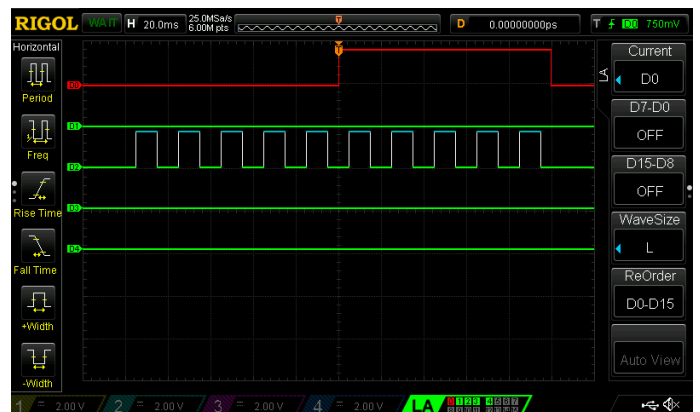

Figure 8. Small Degree Rotation Scenario 2

Figure 5 and Figure 6 illustrate back and forth rotation where Channel A and Channel B follow typical alternating patterns.

In both cases the CW and CCW rotations cancel each other out, leaving us with an equal number of pulses on each output.

### Conclusion

In this App Note we explored using a GreenPAK4 device to create an Unlocked Quadrature Decoder with 1x and 2x resolution capabilities. This chip can be used

to interface between a microcontroller and a rotating dial or axis. This Quadrature Decoder design is one of the many applications for which the GreenPAK platform can be used thanks to its high flexibility and configurability.

## IMPORTANT NOTICE AND DISCLAIMER

RENESAS ELECTRONICS CORPORATION AND ITS SUBSIDIARIES (“RENESAS”) PROVIDES TECHNICAL SPECIFICATIONS AND RELIABILITY DATA (INCLUDING DATASHEETS), DESIGN RESOURCES (INCLUDING REFERENCE DESIGNS), APPLICATION OR OTHER DESIGN ADVICE, WEB TOOLS, SAFETY INFORMATION, AND OTHER RESOURCES “AS IS” AND WITH ALL FAULTS, AND DISCLAIMS ALL WARRANTIES, EXPRESS OR IMPLIED, INCLUDING, WITHOUT LIMITATION, ANY IMPLIED WARRANTIES OF MERCHANTABILITY, FITNESS FOR A PARTICULAR PURPOSE, OR NON-INFRINGEMENT OF THIRD PARTY INTELLECTUAL PROPERTY RIGHTS.

These resources are intended for developers skilled in the art designing with Renesas products. You are solely responsible for (1) selecting the appropriate products for your application, (2) designing, validating, and testing your application, and (3) ensuring your application meets applicable standards, and any other safety, security, or other requirements. These resources are subject to change without notice. Renesas grants you permission to use these resources only for development of an application that uses Renesas products. Other reproduction or use of these resources is strictly prohibited. No license is granted to any other Renesas intellectual property or to any third party intellectual property. Renesas disclaims responsibility for, and you will fully indemnify Renesas and its representatives against, any claims, damages, costs, losses, or liabilities arising out of your use of these resources. Renesas' products are provided only subject to Renesas' Terms and Conditions of Sale or other applicable terms agreed to in writing. No use of any Renesas resources expands or otherwise alters any applicable warranties or warranty disclaimers for these products.

(Rev.1.0 Mar 2020)

### Corporate Headquarters

TOYOSU FORESIA, 3-2-24 Toyosu,  
Koto-ku, Tokyo 135-0061, Japan  
[www.renesas.com](http://www.renesas.com)

### Contact Information

For further information on a product, technology, the most up-to-date version of a document, or your nearest sales office, please visit:  
[www.renesas.com/contact/](http://www.renesas.com/contact/)

### Trademarks

Renesas and the Renesas logo are trademarks of Renesas Electronics Corporation. All trademarks and registered trademarks are the property of their respective owners.