

User Manual

SmartBond Production Line Tool

UM-B-041

Abstract

This document describes the SmartBond Production Line Tool (PLT). The various software applications, as well as the PLT hardware are explained in detail. The purpose of this document is to guide users in the use of it.

Contents

Abstract	1
Contents	2
Figures	6
Tables	10
1 Terms and Definitions	13
2 References	15
3 New version features	16
4 Introduction	17
5 Hardware	18
5.1 Hardware Block Diagram	18
5.2 Printed Circuit Board Layout	19
5.3 PLT Power Supply	20
5.4 DUT Connector	20
5.5 DA14531 Single Wire UART Connections.....	21
5.6 Data Streaming	22
5.7 Golden Unit	23
5.7.1 GU Reset	24
5.8 Current Measurements	24
5.9 Jumper Settings	25
5.9.1 J26 - Current Measurements.....	25
5.9.2 J42 - DA1458x OTP Burning Voltage.....	25
5.9.3 J47, J46 - GU Reset.....	26
5.9.4 J37 - GU Programming.....	27
5.10 PLT Functional Blocks	28
6 Software	29
6.1 Introduction	29
6.2 Software Package Contents	30
6.3 Prerequisites	33
6.4 System Requirements.....	34
6.5 Limitations	34
6.6 Building the Code.....	35
6.7 Executing the Applications.....	37
6.8 Test Sequence	42
6.8.1 DA1458x Test Sequence.....	42
6.8.2 DA1469x Test Sequence.....	46
6.9 VBAT/Reset Signals Operation.....	50
6.9.1 VBAT Only	50
6.9.1.1 Firmware download	50
6.9.1.2 Current measurement.....	50
6.9.2 VBAT On with Reset.....	51
6.9.2.1 Firmware download	51
6.9.2.2 Current measurement.....	51
6.10 Custom Memory Data	51
6.10.1 Homekit Hash Setup Code	52

SmartBond Production Line Tool

6.10.2	Custom data CSV file format	54
6.11	Golden Unit Scan Test.....	55
6.12	Creating PLT Firmware Files	56
6.12.1	Golden Unit Firmware.....	56
6.12.2	DA14531 Firmware.....	57
6.12.3	DA14681/2/3 Firmware.....	57
7	Applications.....	59
7.1	Introduction	59
7.2	CFG PLT Application	59
7.2.1	XML and XSD Files	61
7.2.2	Hardware Setup.....	63
7.2.2.1	Test Station.....	63
7.2.2.2	Device IC	63
7.2.2.3	Active DUTs.....	63
7.2.2.4	DUT COM Ports.....	64
7.2.2.5	Golden Unit.....	64
7.2.2.6	VBAT/Reset Mode	65
7.2.3	General	66
7.2.3.1	Statistics	66
7.2.3.2	Test Options	66
7.2.4	BD Addresses.....	69
7.2.4.1	BD Address Assignment.....	69
7.2.5	DUT Hardware Setup (DA14531).....	74
7.2.5.1	UART Boot Pins Setup	74
7.2.5.2	UART Baud Rate	74
7.2.5.3	SPI Flash Configuration.....	75
7.2.5.4	I2C EEPROM Configuration	76
7.2.6	Test Settings (DA14531)	77
7.2.6.1	GPIO Watchdog Operation.....	77
7.2.6.2	VBAT Level Log.....	77
7.2.6.3	OTP Timestamp Read.....	77
7.2.6.4	DC-DC Converter Level Test.....	78
7.2.6.5	XTAL Trim.....	78
7.2.6.6	Scan DUT Advertise Test.....	79
7.2.6.7	RF Tests	79
7.2.6.8	GPIO/LED Test.....	86
7.2.6.9	GPIO Connection Test	87
7.2.6.10	Sensor Test	88
7.2.6.11	Custom Test	89
7.2.6.12	External 32 kHz Test	89
7.2.6.13	Current Measurement Test.....	90
7.2.6.14	Temperature Measurement Test.....	93
7.2.6.15	Scan Test.....	94
7.2.7	Memory Functions (DA14531).....	95
7.2.7.1	OTP Memory	95
7.2.7.2	SPI Flash Memory	96
7.2.7.3	I2C EEPROM Memory	98

SmartBond Production Line Tool

7.2.7.4	Memory read.....	99
7.2.8	Memory Header (DA14531)	100
7.2.8.1	General.....	100
7.2.8.2	BD Address.....	101
7.2.8.3	Custom Memory Data.....	102
7.2.8.4	OTP Configuration Script.....	104
7.2.9	DUT Hardware Setup (DA1469x).....	106
7.2.9.1	UART Baud Rate.....	106
7.2.10	Test Settings (DA1469x)	106
7.2.10.1	VBAT Level Log.....	106
7.2.10.2	OTP Timestamp Read.....	106
7.2.10.3	XTAL Trim.....	107
7.2.10.4	GPIO Watchdog operation	107
7.2.10.5	Scan DUT Advertise Test.....	108
7.2.10.6	RF Tests	108
7.2.10.7	GPIO/LED Test.....	114
7.2.10.8	GPIO Connection Test	115
7.2.10.9	Sensor Test	116
7.2.10.10	Custom Test	117
7.2.10.11	External 32 kHz Test	117
7.2.10.12	Current Measurement Test.....	118
7.2.10.13	Temperature Measurement Test.....	121
7.2.10.14	Scan Test.....	122
7.2.11	Memory Functions (DA1469x).....	123
7.2.11.1	OTP Memory	123
7.2.11.2	QSPI Flash Memory	124
7.2.11.3	Memory read.....	125
7.2.12	Memory Header (DA1469x).....	126
7.2.12.1	QSPI Header - BD Address.....	126
7.2.12.2	Custom Memory Data.....	126
7.2.13	Debug Settings	128
7.2.14	Security	129
7.3	GUI PLT Application.....	130
7.3.1	GUI PLT Settings.....	132
7.3.2	Barcode Scanner Mode.....	133
7.3.2.1	Homekit Setup Code Scan Example	135
7.3.3	Running the GUI PLT and Executing Tests	139
7.3.4	Debug Console	142
7.3.5	DUT Log File.....	143
7.3.6	CSV File.....	144
7.4	CLI PLT Application	145
7.4.1	CLI Commands.....	145
7.4.2	Running the CLI and Executing Tests	147
7.4.3	Using CLI Commands with Arguments.....	150
7.5	GU Upgrade Application	151
8	Example Usage.....	157
	Appendix A Top View of PLT PCB Version D.....	163

SmartBond Production Line Tool

Appendix B Electrical Schematics	164
Appendix C Hardware Modifications PLT Version D	168
Appendix D Application Hardware Design Considerations	169
Appendix E Suggestions about Hardware and Cabling	170
Appendix F RF Path Losses Calibration	172
F.1 Prerequisites	172
F.2 Setup	173
F.3 Procedure	175
Appendix G Hex2Bin	181
Appendix H Bin2Image	182
Appendix I Automatic GU COM Port Find	183
Appendix J Improving Cabling between PLT and DUTs	185
Appendix K DA14583 Internal SPI Flash Memory	187
Appendix L DA14586 Internal SPI Flash Memory	188
Appendix M Honeywell Xenon 1900 Barcode Scanner Setup	189
Appendix N Golden Unit Upgrade Using Smart Snippets Toolbox	190
Appendix O Connecting a Speaker to the Golden Unit for Audio Test	191
Appendix P FTDI Driver Removal and Installation	192
Appendix Q DA1458x DK Pro Motherboard Connection	193
Appendix R DA1468x DK Pro Motherboard Connection	194
Appendix S Connecting DA1468x DK Pro Motherboard for Current Measurements	195
Appendix T Connecting DUT with Battery Supply	196
Appendix U User Interfaces Shortcut Keys	197
Appendix V DA1458x Supported SPI Flash\EEPROM Memories	198
Appendix W DA14531 Supported SPI Flash Memories	199
Appendix X DA1468x Supported QSPI Flash Memories	200
Appendix Y DA1469x Supported QSPI Flash Memories	200
Appendix Z BLE Tester Measurement Results	201
Appendix AA Memory programming	205
AA.1 DA14580/1/2/3/5/6 Memory Programming Tests	205
AA.2 DA1468x Memory Programming Operation	208
Appendix BB CSV Log File Contents	210
Appendix CC DUT Status Codes	223
Appendix DD Golden Unit Status Codes	233
Revision History	237

SmartBond Production Line Tool

Figures

Figure 1: Production Line Tool Hardware.....	17
Figure 2: Production Line Tool Hardware Board Block Diagram	18
Figure 3: Top View of the PLT Hardware Board	19
Figure 4: PLT Hardware Power Connections.....	20
Figure 5: Production Line Tool DUT Connections.....	20
Figure 6: DA14531 Single Wire UART Connections.....	21
Figure 7: CPLD UART Data Streams	22
Figure 8: CPLD XTAL Trim Pulse Data Stream	22
Figure 9: CPLD UART Loopback Data Stream	23
Figure 10: Golden Unit	23
Figure 11: GU Reset Circuit	24
Figure 12: VBAT DUT Current Measurement Setup	25
Figure 13: Connections for 'Floating Current' Measurements.....	25
Figure 14: VPP Control Circuit Schematic	26
Figure 15: Location of the VPP Jumper J42.....	26
Figure 16: Location of J46 Jumper	26
Figure 17: Location of J47 Jumper	27
Figure 18: J37 - GU Programming Jumper Schematics	27
Figure 19: Location of J37 Jumper	27
Figure 20: PLT Functional Blocks	28
Figure 21: Production Line Tool Software Block Diagram	29
Figure 22: SmartBond PLT Software Package Contents.....	30
Figure 23: DA14531 Test Sequence	45
Figure 24: DA1469x Test Sequence	49
Figure 25: VBAT only	50
Figure 26: VBAT On with Reset	51
Figure 27: Custom Memory Data CSV File Example	54
Figure 28: Golden Unit Scan Test.....	55
Figure 29: Golden Unit Scan Test Example Parameters	55
Figure 30: Binaries	56
Figure 31: Folder Contents of 'fw_files'	56
Figure 32: CFG PLT Startup Screen	59
Figure 33: CFG PLT with Erroneous Configuration Parameter.....	60
Figure 34: XSD Schema File Example	62
Figure 35: Station Identification.....	63
Figure 36: Device IC	63
Figure 37: Active DUTs	63
Figure 38: DUT COM Ports	64
Figure 39: Golden Unit COM Port	64
Figure 40: VBAT/Reset Mode Selection.....	65
Figure 41: Statistics	66
Figure 42: Test Options	66
Figure 43: BD Address Assignment	69
Figure 44: Example for Load from File Mode	70
Figure 45: UART Boot Pins Setup - DA14531	74
Figure 46: UART Baud Rate - DA14531	74
Figure 47: SPI Flash Configuration - DA14531	75
Figure 48: I2C EEPROM Configuration - DA14531	76
Figure 49: GPIO Watchdog Operation – DA14531	77
Figure 50: VBAT Level Log - DA14531	77
Figure 51: OTP Timestamp Read - DA14531	77
Figure 52: DC-DC Converter Level Test - DA14531	78
Figure 53: XTAL Trim - DA1458x	78
Figure 54: Scan DUT Advertise Test - DA14531	79
Figure 55: Golden Unit RF Tests - DA14531	80
Figure 56: BLE Tester General Settings - DA1458x	81
Figure 57: BLE Tester TX Power - DA14531	82
Figure 58: BLE Tester Frequency Offset - DA14531	83

SmartBond Production Line Tool

Figure 59: BLE Tester Modulation Index - DA14531	84
Figure 60: BLE Tester RX Sensitivity - DA14531	85
Figure 61: Path Losses per DUT - DA14531	86
Figure 62: GPIO/LED Tests - DA14531	86
Figure 63: GPIO Connection Test - DA14531	87
Figure 64: Sensor Test - DA14531	88
Figure 65: Custom Test - DA14531	89
Figure 66: External 32 kHz Test - DA14531	89
Figure 67: Current Measurement Test - DA14531	90
Figure 68: Temperature Measurement Test - DA14531	93
Figure 69: Scan Test - DA14531	94
Figure 70: OTP Memory - DA14531	95
Figure 71: Different Image per DUT Folder Example	96
Figure 72: SPI Flash Memory - DA14531	96
Figure 73: I2C EEPROM Memory - DA1458x	98
Figure 74: Memory Read Test - DA14531	99
Figure 75: Memory Read Test Example Log File - DA14531	99
Figure 76: OTP Header - DA14531	100
Figure 77: BD Address - DA14531	101
Figure 78: Custom Memory Data - DA14531	102
Figure 79: OTP Configuration Script - DA14531	104
Figure 80: UART Baud Rate - DA1469x	106
Figure 81: VBAT Level Log - DA1469x	106
Figure 82: OTP Timestamp Read - DA1469x	106
Figure 83: XTAL Trim - DA1469x	107
Figure 84: GPIO Watchdog operation - DA1469x	107
Figure 85: Scan DUT Advertise Test - DA1469x	108
Figure 86: Golden Unit RF Tests - DA1469x	108
Figure 87: BLE Tester General Settings - DA1469x	109
Figure 88: BLE Tester TX Power - DA1469x	110
Figure 89: BLE Tester Frequency Offset - DA1469x	111
Figure 90: BLE Tester Modulation Index - DA1469x	112
Figure 91: BLE Tester RX Sensitivity - DA1469x	113
Figure 92: Path Losses per DUT - DA1469x	114
Figure 93: GPIO/LED Tests - DA1469x	114
Figure 94: GPIO Connection Test - DA1469x	115
Figure 95: Sensor Test - DA1469x	116
Figure 96: Custom Test - DA1469x	117
Figure 97: External 32 kHz Test - DA1469x	117
Figure 98: Current Measurement Tests - DA1469x	118
Figure 99: Temperature Measurement Test - DA1469x	121
Figure 100: Scan Test - DA1469x	122
Figure 101: OTP Memory - DA1469x	123
Figure 102: QSPI Flash - DA1469x	124
Figure 103: Memory Read Test - DA1469x	125
Figure 104: Memory Read Test Example Log File - DA1469x	125
Figure 105: QSPI Header BD Address - DA1469x	126
Figure 106: Custom Memory Data - DA1469x	126
Figure 107: Debug Settings	128
Figure 108: Security	129
Figure 109: GUI PLT Main Screen	130
Figure 110: GUI PLT Settings	132
Figure 111: Barcode Scan Option in GUI PLT	134
Figure 112: Barcode Scanner Controls	134
Figure 113: Barcode Scan - BD Address Assignment	134
Figure 114: GUI PLT - Erroneous Messages in “run scripts before testing starts”	139
Figure 115: GUI PLT OTP Burn Warning Message	140
Figure 116: GUI PLT Testing (1 of 2)	140
Figure 117: GUI PLT Testing (2 of 2)	141

SmartBond Production Line Tool

Figure 118: GUI PLT Tests Finished.....	141
Figure 119: GUI PLT Retry Failed DUTs Message.....	142
Figure 120: Debug Console	142
Figure 121: DUT Log File	143
Figure 122: CSV File	144
Figure 123: CLI Software Start Screen	145
Figure 124: CLI PLT Print Settings (x Command).....	147
Figure 125: CLI PLT DUT COM Port Enumeration ('p' Command).....	148
Figure 126: CLI PLT Read and Compare BD Address in QSPI ('v' Command)	148
Figure 127: CLI PLT Testing	149
Figure 128: CLI PLT Testing Finished.....	149
Figure 129: CLI with Commands as Arguments	150
Figure 130: GU Upgrade - Introduction page.....	151
Figure 131: GU Upgrade - Exit Message	151
Figure 132: GU Upgrade - Hardware Version	152
Figure 133: GU Upgrade - Hardware Version Compatibility	152
Figure 134: GU Upgrade - Power Supply.....	153
Figure 135: GU Upgrade - Power Supply Pop-Up	153
Figure 136: GU Upgrade - Golden Unit Reset	154
Figure 137: GU Upgrade - Golden Unit Reset Message for Manual Mode	154
Figure 138: GU Upgrade - GU COM Port	155
Figure 139: GU Upgrade - Burn Firmware	155
Figure 140: GU Upgrade - Burn Firmware Pop-Up Message	156
Figure 141: GU Upgrade - Burn Firmware Success	156
Figure 142: Top View of PLT PCB Version D	163
Figure 143: VBAT and VPP Control from CPLD	164
Figure 144: CPLD DUT UART Connections	164
Figure 145: CPLD FTDI and GU Control Connections	165
Figure 146: FTDI Chip for USB UART to DUTs 1, 2, 3 and 4	165
Figure 147: Quad USB HUB.....	166
Figure 148: Golden Unit - Dedicated USB Port and FTDI Chip	166
Figure 149: Golden Unit - GU LED and SPI Flash Memory.....	167
Figure 150: VBAT_DUT and VDDIO Supplies	167
Figure 151: GU Supply and VPP Generation.....	167
Figure 152: DA14580_RD_tester Version D	168
Figure 153: Jumper J47 Added Next to Golden Unit Socket	168
Figure 154: R365 (10 kΩ) Added Next to Reset Button.....	168
Figure 155: R365, J47 and RESET Shown in Electrical Schematic	168
Figure 156: Possible Solution of Antenna on Cable and Fixed Radius of DUTs to Antenna.....	170
Figure 157: Possible Solution of Antenna on Cable and DUTs Put in Line	170
Figure 158: Example Locations and RSSI Readouts of Horizontal Antenna	171
Figure 159: Setup Diagram	173
Figure 160: Hex2Bin Example Directory with Files	181
Figure 161: Hex2Bin.exe Example.....	181
Figure 162: Bin2Image Example Directory with Files	182
Figure 163: Bin2Image Example	182
Figure 164: Example of Twisted Pair Cable with 4 Pairs and Ferrite.....	185
Figure 165: Location of Pull-Down Resistors	185
Figure 166: Anti-Ringing Solution.....	186
Figure 167: Pin Assignment of DA14583 – QFN40	187
Figure 168: Pin Assignment of DA14586 - QFN40	188
Figure 169: Speaker Connection for Audio Test.	191
Figure 170: DA14580/5 Pro Motherboard DK Wiring.	193
Figure 171: DA14680/1/2/3 Pro Motherboard DK Wiring.....	194
Figure 172: DA1468x PRO DK Ammeter Connection with PLT.....	195
Figure 173: DA1468x DK PRO Current Measurement Settings	195
Figure 174: CSV File Entries (1/4)	215
Figure 175: CSV File Entries (2/4)	216
Figure 176: CSV File Entries (3/4)	220

SmartBond Production Line Tool

Figure 177: CSV File Entries (4/4) 222

SmartBond Production Line Tool

Tables

Table 1: SmartBond_PLT_v4.4 added features	16
Table 2: Power Supply Requirements	20
Table 3: PLT Connections to Applications	21
Table 4: Jumpers	25
Table 5: PLT User Interface Application Executables	30
Table 6: Executables Folder Description	30
Table 7: Production Line Tool Prerequisites	33
Table 8: Minimum System Requirements	34
Table 9: Opening the PLT Visual Studio 2017 Express Source Code Solution	35
Table 10: SmartBond_CFG_PLT.exe Application Execution	37
Table 11: SmartBond_GUI_PLT.exe Application Execution	39
Table 12: SmartBond_CLI_PLT.exe Application Execution	40
Table 13: GU_fw_upgrade.exe Application Execution	41
Table 14: DA14531 Test Sequence	42
Table 15: DA1469x Test Sequence	46
Table 16: Custom Memory Data Input Modes	51
Table 17: Homekit Setup Code Format	52
Table 18: Homekit Setup Code Checksum Algorithm	53
Table 19: CFG PLT Main Menu Options	60
Table 20: CFG PLT Bottom Strip Options	60
Table 21: XML File Parts	61
Table 22: Station Identification	63
Table 23: Device IC	63
Table 24: Active DUTs	64
Table 25: DUT COM Ports	64
Table 26: Set the GU COM Port	65
Table 27: Golden Unit Firmware Version Upgrade	65
Table 28: VBAT/Reset Mode	65
Table 29: Statistics	66
Table 30: BD Address Assignment - Standard Mode	70
Table 31: BD Address Assignment Options - Range Mode	70
Table 32: BD Address Assignment Options - Load from File Mode	71
Table 33: BD Address Assignment Options - Scan Mode	73
Table 34: UART TX-RX Pins - DA1458x	74
Table 35: UART Baud Rate - DA1458x	74
Table 36: SPI Pin Setup - DA14531	75
Table 37: SPI Flash Configuration - DA14531	75
Table 38: I2C Pin Setup - DA14531	76
Table 39: I2C EEPROM Configuration – EEPROM Memory Options - DA14531	77
Table 40: GPIO Watchdog Configuration Options – DA14531	77
Table 41: DC-DC Converter Level Test Options - DA14531	78
Table 42: XTAL Trim - DA1458x	78
Table 43: Scan DUT Advertise Test - DA1458x	79
Table 44: Golden Unit RF Tests - DA14531	80
Table 45: BLE Tester General Settings - DA1458x	81
Table 46: BLE Tester TX Power - DA14531	82
Table 47: BLE Tester Frequency Offset - DA14531	83
Table 48: BLE Tester Modulation Index - DA14531	84
Table 49: BLE Tester RX Sensitivity - DA14531	85
Table 50: Path Losses per DUT from RF Tests DA14531 Options	86
Table 51: GPIO/LED Tests - DA14531	86
Table 52: GPIO Connection Test - DA14531	87
Table 53: Sensor Tests - DA14531	88
Table 54: Custom Tests - DA14531	89
Table 55: External 32 kHz Test - DA14531	89
Table 56: Current Measurement Test – General Settings - DA14531	91
Table 57: Peripheral Current Measurement - DA14531	91
Table 58: Current Measurement Test - Sleep Current Measurement - DA14531	92

SmartBond Production Line Tool

Table 59: Temperature Measurement Test - DA14531	93
Table 60: Scan Test DA14531 Options	94
Table 61: OTP Memory - DA14531	95
Table 62: SPI Flash Erase - DA14531	97
Table 63: SPI Flash Image Write - DA14531	97
Table 64: I2C EEPROM Image Write - DA1458x.....	98
Table 65: Memory Read Test - DA14531.....	99
Table 66: OTP Header - DA14531	100
Table 67: BD Address - DA14531	101
Table 68: Custom Memory Data - DA14531	103
Table 69: OTP Configuration Script - DA14531	104
Table 70: UART Baud Rate - DA1469x.....	106
Table 71: XTAL Trim - DA1469x	107
Table 72: GPIO Watchdog operation - DA1469x.....	107
Table 73: Scan DUT Advertise Test - DA1469x.....	108
Table 74: Golden Unit RF Tests - DA1469x.....	109
Table 75: BLE Tester General Settings - DA1469x	109
Table 76: BLE Tester TX Power - DA1469x.....	110
Table 77: BLE Tester Frequency Offset - DA1469x.....	111
Table 78: BLE Tester Modulation Index - DA1469x.....	112
Table 79: BLE Tester RX Sensitivity - DA1469x.....	113
Table 80: Path Losses per DUT from RF Tests DA1469x Options.....	114
Table 81: GPIO/LED Tests - DA1469x.....	114
Table 82: GPIO Connection Test - DA1469x	115
Table 83: Sensor Tests - DA1469x	116
Table 84: Custom Tests DA1469x Options.....	117
Table 85: External 32 kHz Tests DA1469x Options.....	117
Table 86: Current Measurement Tests - DA1469x	119
Table 87: Current Measurement Test – Peripheral Current Measurement - DA1469x	119
Table 88: Current Measurement Test - Sleep Current Measurement - DA1469x.....	120
Table 89: Temperature Measurement Test - DA1469x.....	121
Table 90: Scan Test DA1469x Options	122
Table 91: OTP Memory - DA1469x	123
Table 92: QSPI Flash Erase - DA1469x.....	124
Table 93: QSPI Flash Image Write - DA1469x.....	124
Table 94: Memory Read Test - DA1469x.....	125
Table 95: QSPI Header BD Address - DA1469x.....	126
Table 96: Custom Memory Data - DA1469x	127
Table 97: Debug Settings.....	128
Table 98: Security Options	129
Table 99: GUI PLT Main Screen Description	130
Table 100: GUI PLT Settings	133
Table 101: Homekit Setup Code Scan Example.....	135
Table 102: CLI Commands.....	145
Table 103: DA14580 PLT Example Usage	157
Table 104: RF Test RSSI Results	171
Table 105: Prerequisites.....	172
Table 106: Calibration Setup.....	173
Table 107: Procedure Steps.....	175
Table 108: FTDI "DialogSemi" Serial Number	183
Table 109: DA14583 Internal SPI Flash Connections.....	187
Table 110: DA14586 Internal SPI Flash Connections.....	188
Table 111: User Interface Shortcut Keys	197
Table 112: DA1458x Supported SPI Flash Memories	198
Table 113: DA14531 Supported SPI Flash Memories	199
Table 114: DA1468x Supported QSPI Flash Memories.....	200
Table 115: DA1469x Supported QSPI Flash Memories.....	200
Table 116: MT8852B Supported Command Codes.....	201
Table 117: MT8852B – BLE TX Output Power Test Results	201

SmartBond Production Line Tool

Table 118: MT8852B – BLE Carrier Frequency Offset and Drift Test Results	202
Table 119: MT8852B – BLE Modulation Characteristics Test Results	202
Table 120: MT8852B – Error List	203
Table 121: DA1458x Memory Programming – OTP Memory	205
Table 122: DA1458x Memory Programming - SPI Flash	205
Table 123: DA1458x Memory Programming – EEPROM Memory	207
Table 124: DA1468x Memory Programming – OTP Memory	208
Table 125: Memory Programming – QSPI Memory	209
Table 126: CSV File Contents	210
Table 127: CSV File Entries (1/4)	215
Table 128: CSV File Entries (2/4)	216
Table 129: CSV File Entries (3/4)	220
Table 130: CSV File Entries (4/4)	222
Table 131: DUT Status Codes	223
Table 132: Golden Unit Status Codes	233

SmartBond Production Line Tool

1 Terms and Definitions

API	Application Programming Interface
BD	Bluetooth Device
.bin	Firmware files in binary format
BLE	Bluetooth low energy
CFG	Configuration
CLI	Command Line Interface
COM	Communication port
CPLD	Complex Programmable Logic Device
CRC	Cyclic redundancy check
CS	Configuration Script
CSV	Comma Separated Values
DLL	Dynamic Link Library
DMA	Direct Memory Access
DMM	Digital Multi-meter
DTM	Direct Test Mode (as specified by the BLE Core standard)
DUT	Device Under Test
DVM	Digital Voltage Meter
EEPROM	Electrically Erasable Programmable Read-Only Memory
.exe	Executable file
FTDI	Future Technology Devices International Ltd.
GPIO	General Purpose Input-Output
GU	Golden Unit
GUI	Graphical User Interface
Hex	Firmware file in ASCII format
HW	hardware
IC	Integrated Circuit
IDE	Integrated Development Environment
I2C	Inter-Integrated Circuit
JTAG	Joint Test Action Group
OS	Operating System
OTP	One Time Programmable (memory)
PC	Personal Computer
PCB	Printed circuit board
PER	Packet Error Rate
PLT	Production Line Tool
PLTD	Production Line Tool DLL
POR	Power-On Reset
RAM	Random Access Memory
RCX	Resistor Crystal Oscillator
RF	Radio Frequency
RX	Receive
SCPI	Standard Commands for Programmable Instruments
SoC	System on Chip
SDK	Software Development Kit
SPI	Serial Peripheral Interface
SW	Software

SmartBond Production Line Tool

TCS	Trim and Calibration Section
TX	Transmit
UART	Universal Asynchronous Receiver/Transmitter
UI	User Interface
USB	Universal Serial Bus
VISA	Virtual Instrument Software Architecture
VPP	Programming supply voltage (pin)
XML	Extensible Markup Language
XTAL	Crystal
XSD	XML Schema Definition

SmartBond Production Line Tool

2 References

- [1] UM-B-040, DA1458x/DA1468x Production Line Tool Libraries v4.2s, User manual, Dialog Semiconductor.
- [2] UM-B-014, DA1458x Bluetooth Smart Development Kit - Expert, User Manual, Dialog Semiconductor
- [3] [FT4232H – Hi-Speed Quad USB UART IC](#), FTDI Chip.
- [4] [FT232 – USB UART IC](#), FTDI Chip
- [5] Anritsu MT8852B, <https://www.anritsu.com/en-US/test-measurement/products/mt8852b>
- [6] Keysight 34401A, <http://www.keysight.com/en/pd-1000001295%3Aepsg%3Apro-pn-34401A/digital-multimeter-6-digit?cc=US&lc=eng>
- [7] Keithley 2000, <http://www.tek.com/tektronix-and-keithley-digital-multimeter/keithley-2000-series-6%C2%BD-digit-multimeter-scanning>
- [8] Papouch TMU USB thermometer, <https://www.papouch.com/en/shop/product/tmu-usb-thermometer/>
- [9] NI USB TC-01, <http://sine.ni.com/nips/cds/view/p/lang/en/nid/208177>
- [10] Honeywell Xenon 1900, <https://www.honeywellaidc.com/products/barcode-scanners/general-duty/xenon-1900g-1902g>
- [11] Zebra/Motorola LS2208, <https://www.zebra.com/us/en/products/scanners/general-purpose-scanners/handheld/ls2208.html>
- [12] AN-B-020, DA14580 End product testing and programming guidelines, Application Note, Dialog Semiconductor
- [13] Litepoint IQXel-M, <http://www.litepoint.com/test-solutions-for-manufacturing/iqxel-m/>
- [14] NI USB-6009 DAQ, <http://sine.ni.com/nips/cds/view/p/lang/en/nid/201987>
- [15] Keysight 34461A, <http://www.keysight.com/en/pd-2270273-pn-34461A/digital-multimeter-6-digit-34401a-replacement-truevolt-dmm?cc=GR&lc=eng>

SmartBond Production Line Tool
3 New version features

This manual explains the usage of the 16 channels SmartBond™ Production Line Tool (PLT). It refers to the SmartBond_PLT_v4.4 software release, which compared to DA1458x_DA1468x_PLT_v4.3 has the added features illustrated in [Table 1](#).

Table 1: SmartBond_PLT_v4.4 added features

#	Features	Description
1	Application rename	Applications were renamed from DA1458x_DA1468x_PLT_vX.X to SmartBond_PLT_vX.X.
2	DA14531-AE/AF support	New chipset support.
3	DA1469x support	New chipset support.
4	Tester-ID	Added Tester ID. Tester ID is shown in the SmartBond™ Production Line Tool GUI, in the DUT logs and in the CSV log file.
5	Reset duration	Reset duration can now be more than 50 ms. In previous versions the reset duration was fixed at 50 ms. Now, this can be adjusted between 10 ms and 1000 ms.
6	Single wire UART	Single wire UART support for DA14531 devices, at either P03 or P05 GPIOs.
7	VBAT measure	Measure VBAT and log it, using internal ADC.
8	OTP timestamp	Read IC specific OTP timestamp and log it.
9	DC-DC converter level	DA14531 DC-DC converter level test.
10	BLE scan test at all advertisement channels	BLE scan test at all advertisement channels. If 'All channels' is selected, three different tests are performed, at CH37, CH38 and at CH39. Before, if 'All channels' was selected, the Bluetooth LE stack selected the advertisement channel according to the Bluetooth® specification.
11	'No short' GPIO connection test	Added 'No short' GPIO connection test. If 'No short' checkbox is selected, the tool will return an error if the two GPIOs are found to be shorted.
12	TX power control for DA14531 devices	Added TX power control for DA14531 devices. The TX power control can be adjusted in the 'Scan DUT Advertise Test' and in all TX Bluetooth LE tester tests.
13	UART RX pin select as XTAL trim GPIO input	The UART RX pin can now be selected as XTAL trim GPIO input pulse pin. Previously, the user had to select the specific GPIO (e.g. P05).
14	'Single Device' current measurement test	Added 'Single Device' current measurement test. This is to be used during PLT production setup and not in the actual production line, to find the average current measurement limits, by first measuring multiple devices.
15	'Skip if written' in all OTP writes	Added 'Skip if written' in all OTP writes. If this option is selected the tool will first read the OTP area to be written. If the area contains data, it will not write new data and proceed to the next operation without error.
16	Extend memory read size to 64 Mbytes	The memory read size has been extended by more than 256 bytes to 64 Mbytes. If the size to be read is more than 256 bytes, the read data will be saved on a file under 'mem_read_test' folder.
17	OTP configuration script	OTP configuration script support for DA14531 and DA1469x.

4 Introduction

By using the PLT, it is possible to test, calibrate and load firmware for 16 different devices under test (DUTs) in parallel.

The following are a list of parts delivered with the tool:

- Hardware
 - Main board (Figure 1) together with a DA14580-QFN48 Golden Unit
 - Electrical schematics
 - Gerber files
 - Bill of Materials
- Software
 - Source code files organized in a Microsoft® Visual Studio Express 2017 solution
 - Application executables and required DLLs
- Documents

An example of a sequence of actions the tool performs is given below. All actions are performed in parallel for up to 16 devices.

1. Download the production test firmware (e.g. prod_test_531.bin).
2. Perform automatic crystal (XTAL) trimming.
3. Perform RF RSSI test.
4. Download and burn the customer firmware (into OTP, SPI flash, QSPI flash or I2C EEPROM).
5. Burn the OTP header.
6. Perform Scan test. Reset the DUTs and set the GU to scan for the DUT BLE advertisements.

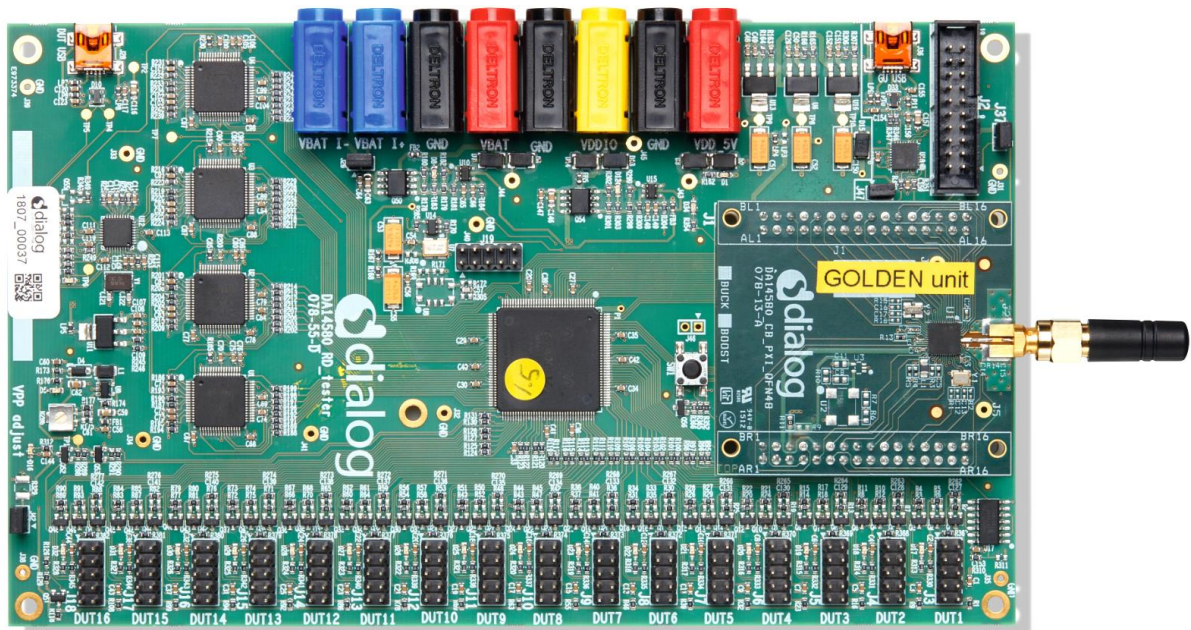

Figure 1: Production Line Tool Hardware

5 Hardware

5.1 Hardware Block Diagram

The Production Line Tool hardware consists of various blocks, as illustrated in Figure 2. These blocks are explained below.

- **Blue blocks:** USB-to-UART interfaces
 - Four **FT4232 FTDI QUAD** USB-to-UART interfaces are used for a 16-channel USB-to-UART conversion
 - The GU is connected to the PC via an **FT232 FTDI** USB-to-UART interface
- **Red block:** A **CPLD** that has the following purpose
 - Switch UART signals between the PC USB-UART and DUTs
 - Switch DUTs VBAT signal
 - Switch DUTs VPP signal (only when VBAT is enabled)
 - Produce Reset signal to the DUTs
 - Produce 500 ms XTAL calibration pulse
- **Orange block:** A **Golden Unit** (GU) is mounted, which has the following functionality:
 - CPLD control using custom commands
 - Transceiver for Bluetooth RF signals to and from the DUTs
 - Produce an audio tone using PWM, used for audio testing
 - Scan for device BLE advertisements, after the customer firmware has been programmed
- **Purple blocks:** Sixteen (16) device connectors

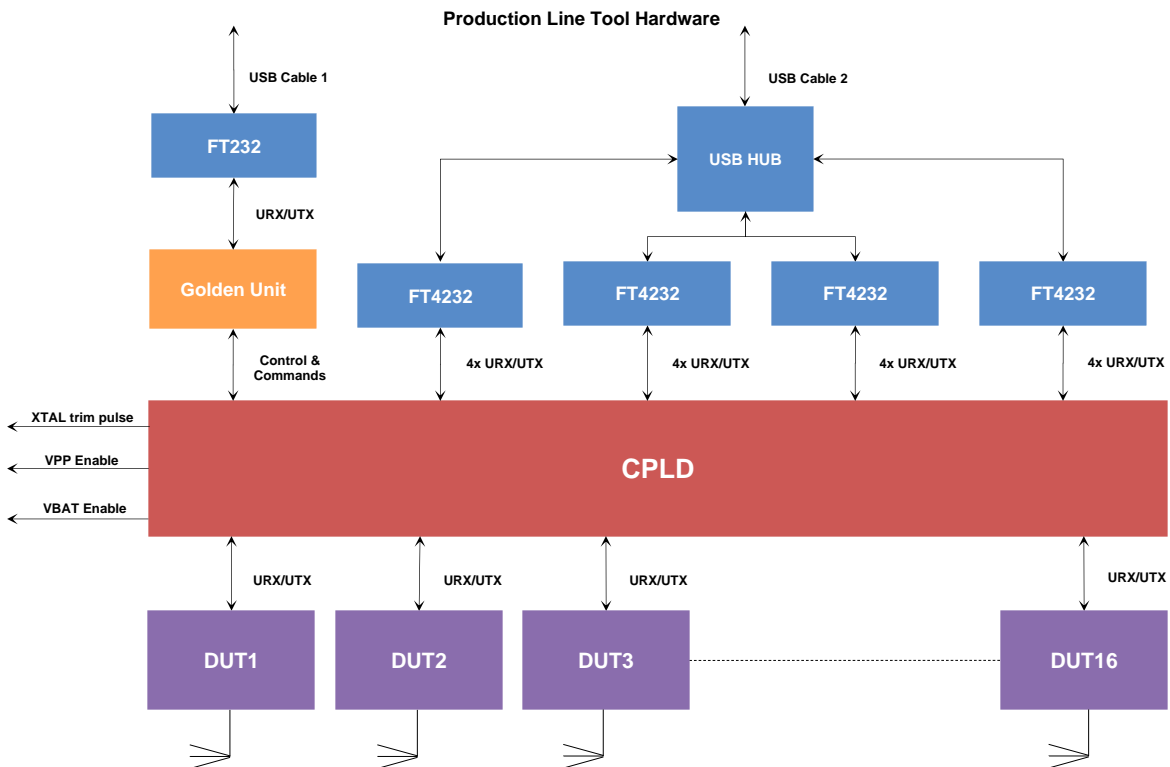

Figure 2: Production Line Tool Hardware Board Block Diagram

SmartBond Production Line Tool

5.2 Printed Circuit Board Layout

In **Figure 3**, the top view of the PLT board is illustrated. The important parts are pointed by the orange boxes. The *VPP jumper* and the *Current jumper* are colored in blue.

The Golden Unit has a DA14580 QFN48-die soldered. Most of the 48 pins are basically used to connect to the CPLD. The CPLD is programmed during the production of the PLT board via the CPLD socket. No need for the users to use the CPLD socket.

The black banana sockets are all connected to the same ground (GND) plane.

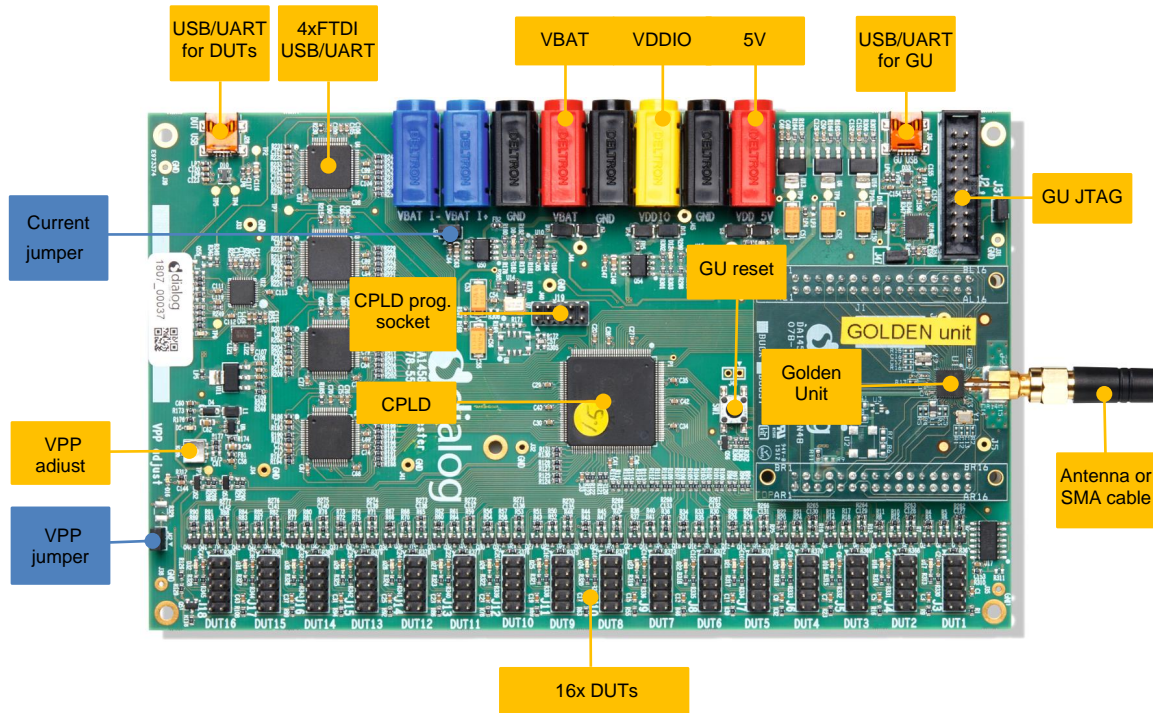

Figure 3: Top View of the PLT Hardware Board

SmartBond Production Line Tool

5.3 PLT Power Supply

External power supply is needed for the PLT to run. This should be connected to the banana sockets as shown in Figure 4.

Table 2 shows the voltage and current requirements for each power supply. The blue banana sockets can be used for device current measurements.

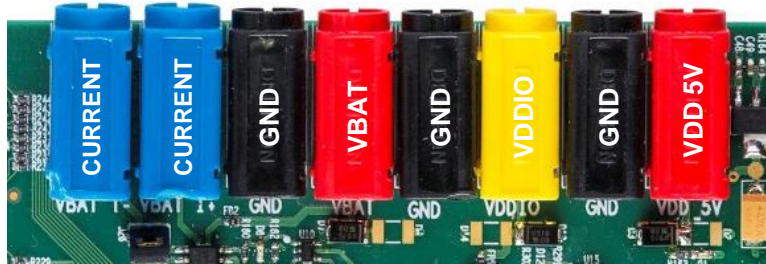

Figure 4: PLT Hardware Power Connections

Table 2: Power Supply Requirements

Power Supply	Voltage (V)	Current (mA)	
		Buck Mode	Boost Mode
VBAT (Buck mode)	2.4 ... 3.3	16 x 20	
VBAT (Boost mode)	1.5 ... 3.3		16 x 20
VDDIO	2.4 ... 3.3	70	70
VDD 5V	4.75 ... 5.25	~335	~335
VPP	6.6 ... 6.8	16 x 2	16 x 2

5.4 DUT Connector

The BLE devices are connected to the PLT using the DUT1-16 connectors at the edge of the PLT board. Figure 5 shows the pin-header connections from the Production Line Tool hardware board to the DUTs. Table 3 describes the purpose of each pin.

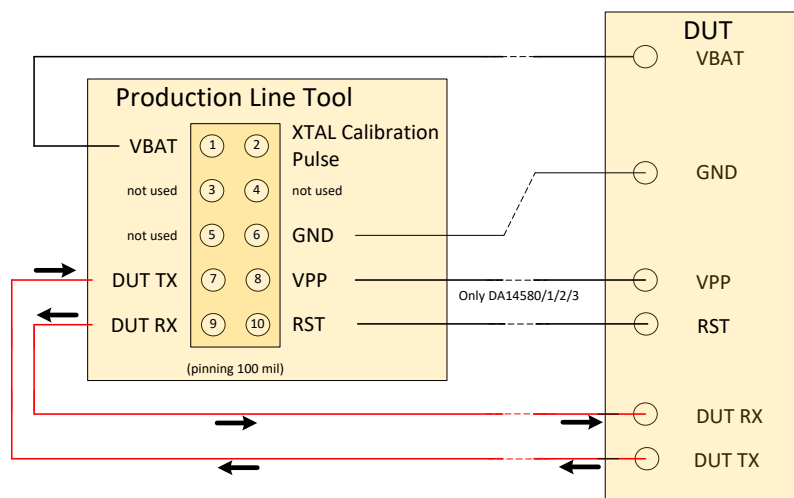

Figure 5: Production Line Tool DUT Connections

SmartBond Production Line Tool

Table 3: PLT Connections to Applications

Header Pin	Name	Description
1	VBAT	Depending on the VBAT/Reset Signals Operation mode this can be used as Voltage supply for the DUT or as Reset signal. Due to this connection, no external power supply is needed for the DUTs. This pin must be connected if there is no other power supply (e.g. battery).
2	XTAL Calibration Pulse	This pin can be used as a reference pulse during the automatic crystal calibration. More details are given in 7.2.6.5 for DA14531 devices and in 7.2.10.3 for DA1469x devices. The crystal trim pulse can also be supplied in the UART RX device pin. This is the most common scenario. However, there may be hardware limitations where the UART RX pin cannot be used. In such cases, this particular PLT header pin is used.
6	GND	Ground pin. This pin must be connected.
7	DUT TX	This is connected to the device UART TX pin. This pin must be connected.
8	VPP	This pin provides the 6.8 V required to program the OTP in the DA14580/1/2/3 devices. Note: This option is not available with the 'VBAT as Reset' mode.
9	DUT RX	This is connected to the device UART RX pin. This pin can also provide the crystal calibration reference pulse for the automatic crystal (XTAL) trim procedure, as described in 7.2.6.5 for DA1458x devices and in 7.2.10.3 for DA1468x devices. This pin must be connected.
10	RST	The reset signal must be connected if battery powered devices are used. A power cycle of VBAT will produce a Power on Reset (POR), so a RESET is given to the DUT. In that case the RST-wire is not needed. In summary, when no battery is used, the POR will RESET the DUT.

5.5 DA14531 Single Wire UART Connections

DA14531 supports single wire UART. For this purpose, DA14531 GPIO P05 or P03 can be used. The UART pin connections to PLT are as shown in [Figure 6](#). The 100 Ohm resistor in the device is optional. The PLT hardware does not need any modifications. The only requirement is to short circuit the PLT DUT RX and DUT TX pins as close to PLT as possible. The resistors shown in the PLT block already exist.

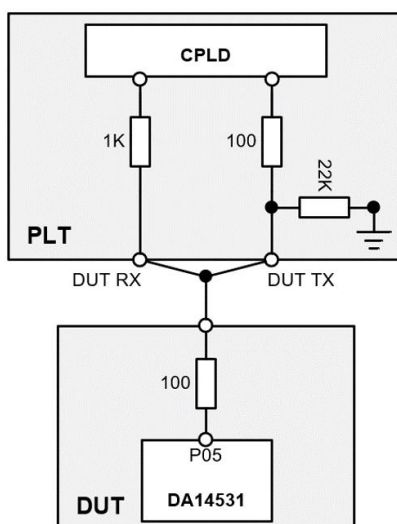

Figure 6: DA14531 Single Wire UART Connections

Note 1 The 100 Ohm resistor in the device is optional.

5.6 Data Streaming

Figure 7, Figure 8 and Figure 9 illustrate the three possible data streams through the CPLD. The CPLD switches S1, S2, S3 and S4 are controlled by the software via the Golden Unit.

Normal Operation (Figure 7):

UART-RxD data is transported via the RED arrows (AA):

PC → USB → USB HUB → Quad UART → CPLD signal 'AA' → DUT RxD (programmed as RxD).

UART-TxD data is transported via the BLUE arrows (BB):

PC ← USB ← USB HUB ← Quad UART ← CPLD signal 'BB' ← DUT TxD.

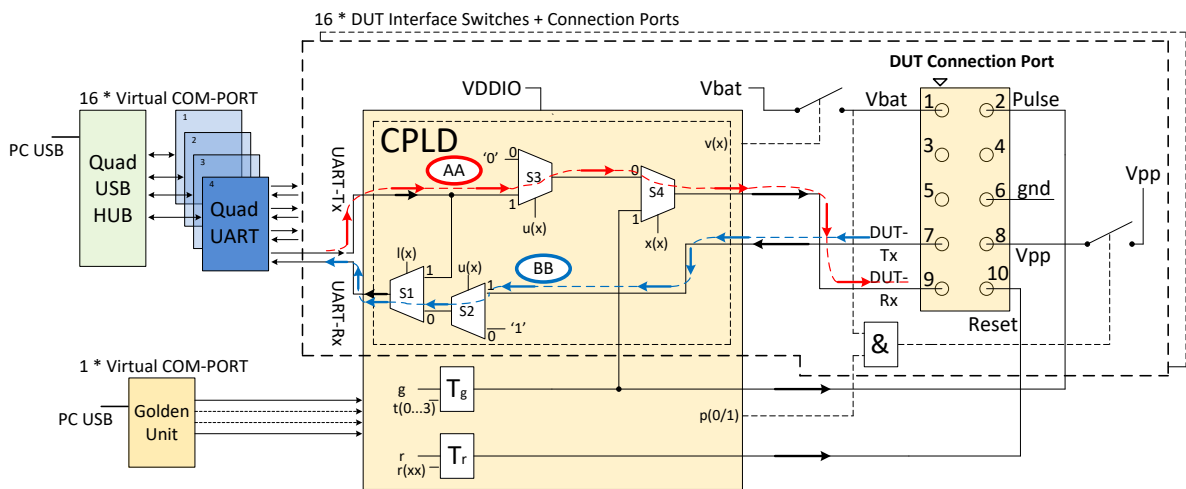

Figure 7: CPLD UART Data Streams

Crystal Trimming (Figure 8):

The XTAL calibration pulse (500 ms) is transported via the PURPLE arrows (CC):

CPLD TIMER T_g → CPLD S4 → DUT RxD (programmed as GPIO).

UART-TxD data is transported via the BLUE arrows (BB):

PC ← USB ← USB HUB ← Quad UART ← CPLD signal 'BB' ← DUT TxD.

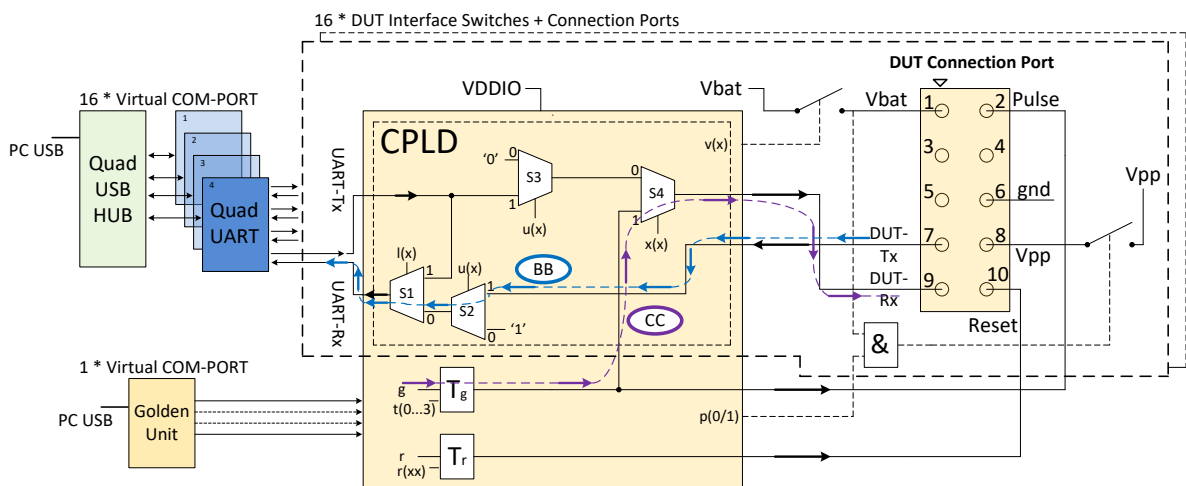

Figure 8: CPLD XTAL Trim Pulse Data Stream

SmartBond Production Line Tool

Loopback Operation (Figure 9):

Loopback operation is used during the start of the tests. The PC PLT software uses this feature to automatically find the numbers of the Virtual COM ports in the Windows PC.

The UART loopback data is transported via the GREEN arrows (DD):

PC → USB → USB HUB → Quad UART → CPLD signal 'DD' SW1 → Quad UART → USB HUB → USB → PC.

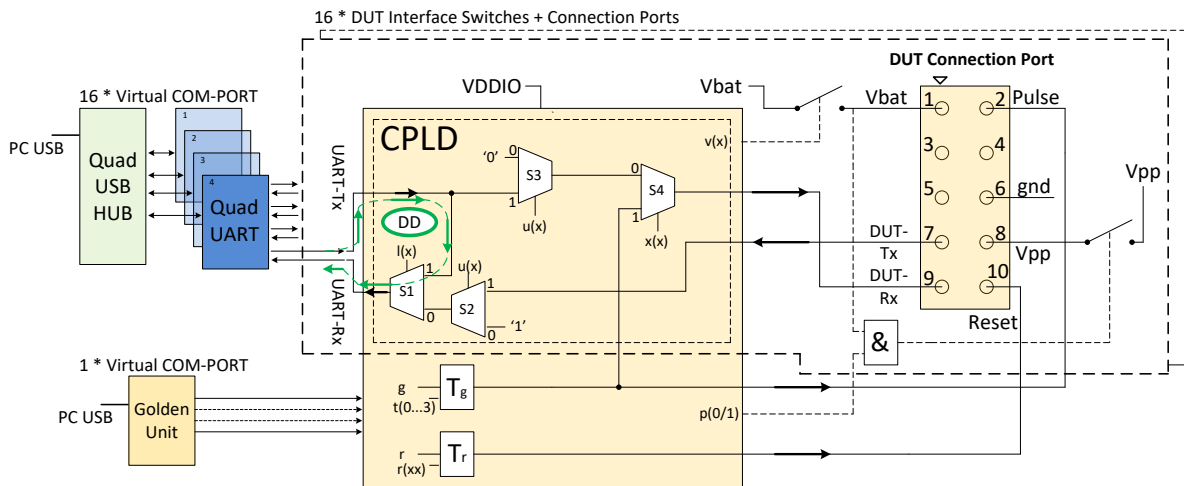

Figure 9: CPLD UART Loopback Data Stream

Note: The CPLD is also used to switch the UART signals between the QUAD FTDIs and the DUTs. When the VBAT is switched off and the UART wires are not disconnected, a 'rest voltage' may be present on the product. This could cause problems with the power-on reset (POR) and the product might not boot correctly. The CPLD will switch off the UART signals when the VBAT is not present.

5.7 Golden Unit

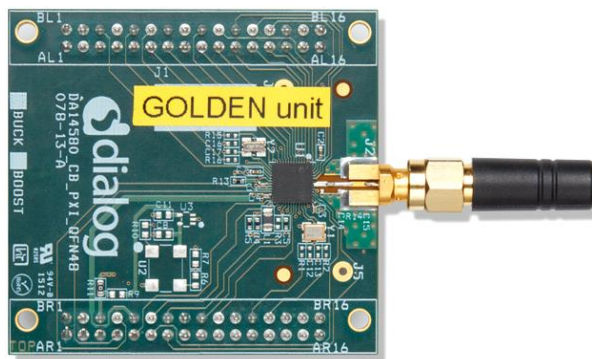

Figure 10: Golden Unit

The Golden Unit (GU) is a 'daughter' board mainly used in the Expert Development Kit [2]. In the PLT, the GU is used for various purposes:

- RF transmitter for the RF RSSI DUT test.
- RF Receiver for the device BLE advertisement scan test.
- Audio tone generator for the audio test.
- Controlling the CPLD.

The GU uses an SPI Flash memory mounted on the PLT board. The SPI Flash is pre-programmed with a specific production test firmware. If required, there are several ways to upgrade the GU

SmartBond Production Line Tool

firmware, either via the PLT's GU JTAG connector, via the UART or using a new GUI application executable (GU_fw_upgrade.exe) as explained in 7.5. The latest GU firmware can be found inside the latest PLT software release, under the executables\binaries\GU folder.

Note: PLT v4.3 and onwards requires the latest firmware version of the Golden Unit. If the Golden Unit firmware is not updated, then the PLT applications will not run.

Note: The Golden Unit is calibrated during PLT production. It is delivered with a calibration characterization document.

5.7.1 GU Reset

The Golden Unit includes a hardware reset circuit. The GU reset signal is connected to an FTDI FT232 GPIO pin.

Figure 11 illustrates the electrical schematics of the GU reset circuit. Section 5.9.3 illustrates the jumper positions on the PLT PCB.

The red line is the connection between the FTDI IC GPIO pin (DTR) and the GU reset signal on the PLT GU connector header. The PLT software controls this pin via the FTDI DLL driver ftd2xx.dll. Making pin DTR low for a short period of time will reset the GU. Every time the PLT tests start, a hardware reset is issued to the Golden Unit. Jumper J47 should be ON and J46 OFF for this reset method to operate.

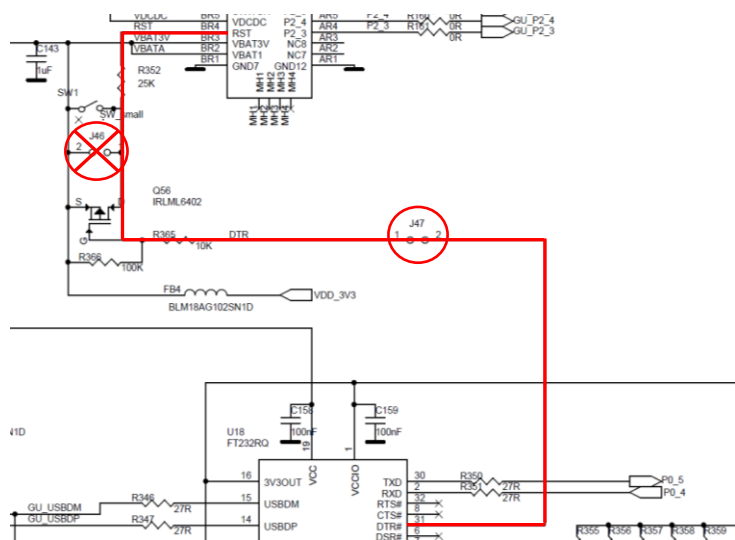

Figure 11: GU Reset Circuit

5.8 Current Measurements

The PLT board provides connections to perform DUT current measurements (see Figure 12). By connecting a current meter to the blue banana sockets, the combined VBAT current of all DUTs can be measured. Jumper J26 should be removed when a current meter is connected. If no current meter is used, jumper J26 should be mounted. See also section 5.9.

The connection shown in Figure 12 can only be used with the VBAT Only and VBAT On with Reset (when the VBAT lines are used to power the DUTs) modes. If the DUTs are powered using a single external power supply, then the multi-meter should be connected on that power supply in a similar way as described before with the PLT. If the DUTs are powered independently (e.g. each one with its own battery) the current measurement procedure cannot be used.

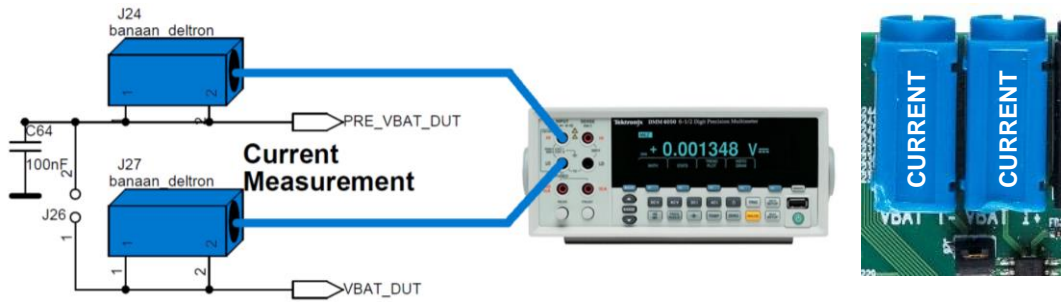

Figure 12: VBAT DUT Current Measurement Setup

5.9 Jumper Settings

This section describes the PLT hardware jumper settings.

Table 4: Jumpers

Jumper	PLT HW version	Description
J26	A, B, C, D	Connects the VBAT line from the PLT power supply to the DUTs. This jumper can be used when there is no multi-meter instrument connected for current measurement.
J37	B, C, D	This jumper sets the Golden Unit's SPI Flash chip select (CS) pin to high. This jumper is needed placed when the Golden Unit should NOT boot from the SPI flash.
J42	B, C, D	Feeds the VPP lines of the DUT connectors with VPP voltage used for OTP burning in DA14580/1/2/3 DUTs.
J46	C, D	This jumper can be used to reset the Golden Unit. The two pins on the jumper are the same as the ones in the GU reset switch next to the jumper.
J47	D	This jumper connects the Golden Unit's FTDI DTR line to the Golden Unit's reset pin. With this jumper on the PLT, software can reset the Golden Unit on-demand.

5.9.1 J26 - Current Measurements

As shown in Figure 13, jumper J26 should be mounted when no external current meter is attached. Otherwise, when a current meter is connected via the blue banana sockets to measure the device current, the J26 jumper should be removed.

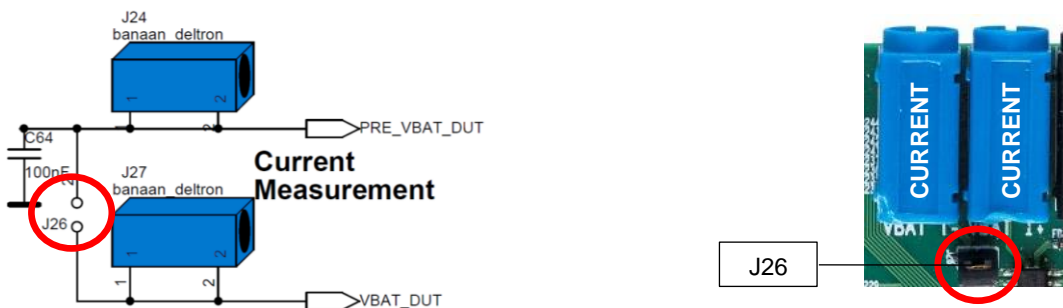

Figure 13: Connections for 'Floating Current' Measurements

5.9.2 J42 - DA1458x OTP Burning Voltage

If DA14580/1/2/3 OTP programming is required, the VPP line should be connected between the PLT DUT connector and the actual DUT (Figure 5). Jumper J42 on the PLT board should also be

SmartBond Production Line Tool

mounted. [Figure 15](#) shows the jumper position on the PLT hardware board. [Figure 14](#) illustrates the electrical schematics of the VPP and the location of the J42 jumper.

DA14585/6 and DA1468x devices do not need an external voltage for the OTP to be burned. Therefore, the VPP line from the PLT DUT connector ([Figure 5](#)) should not be connected to the DA1468x DUT.

Note: The VPP line feature **cannot** be used with the 'VBAT as Reset' mode, because of the fact that the VPP line will not operate when VBAT is not switched on. It is secured in the hardware.

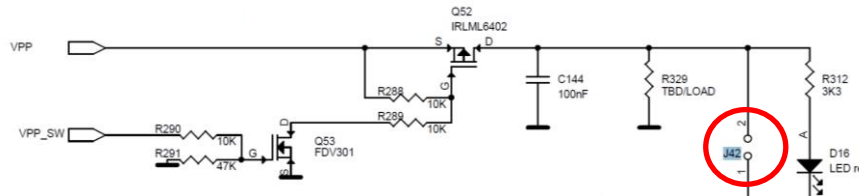

Figure 14: VPP Control Circuit Schematic

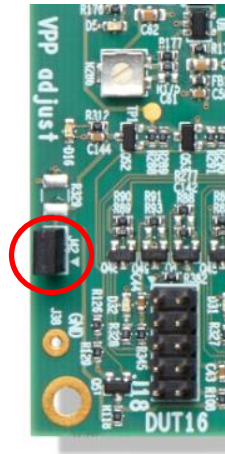

Figure 15: Location of the VPP Jumper J42

5.9.3 J47, J46 - GU Reset

For a GU hardware reset, jumper J47 should be mounted and jumper J46 should be removed. These two jumpers are involved in the circuit illustrated in [Figure 11](#). In this way, the PLT software will control the GU hardware reset. [Figure 16](#) shows the jumper placement on the actual PCB.

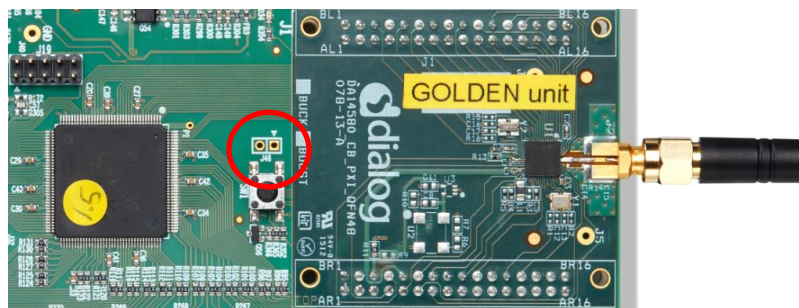

Figure 16: Location of J46 Jumper



Figure 17: Location of J47 Jumper

5.9.4 J37 - GU Programming

Jumper J37 connects the Chip Select of the GU SPI Flash to a logic high level. This causes the GU not to boot from the already programmed SPI Flash, allowing the GU to load different code into its System-RAM via the JTAG connector or via UART. Figure 18 shows the circuit schematic and Figure 19 shows the location of jumper J37 on the PLT PCB.

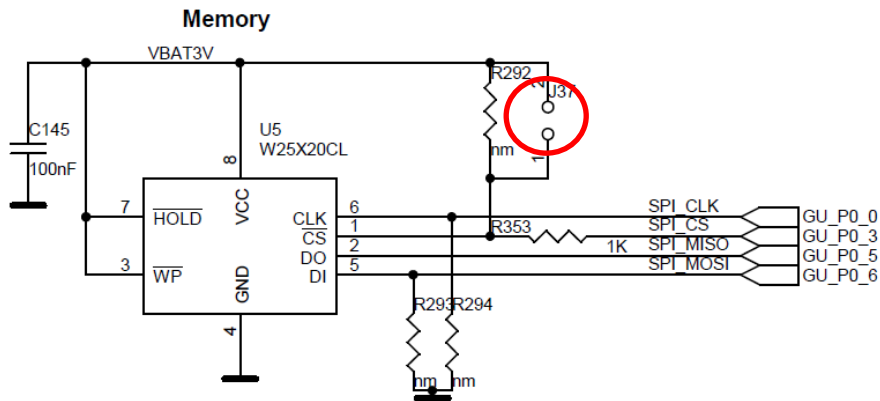

Figure 18: J37 - GU Programming Jumper Schematics



Figure 19: Location of J37 Jumper

5.10 PLT Functional Blocks

Figure 20 shows an overview of the PLT hardware functions. For detailed electrical schematics, see Appendix B.

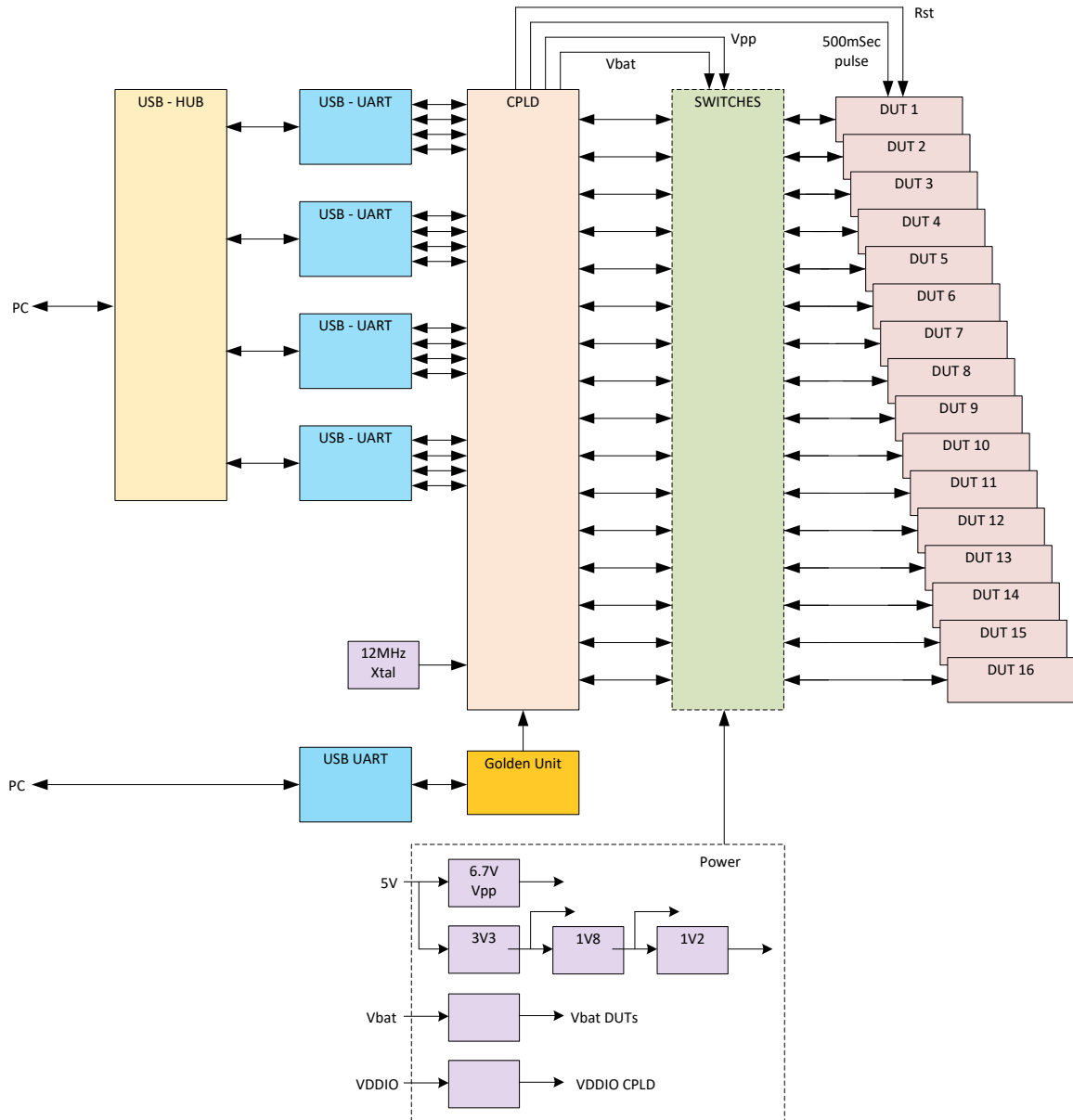

Figure 20: PLT Functional Blocks

6 Software

6.1 Introduction

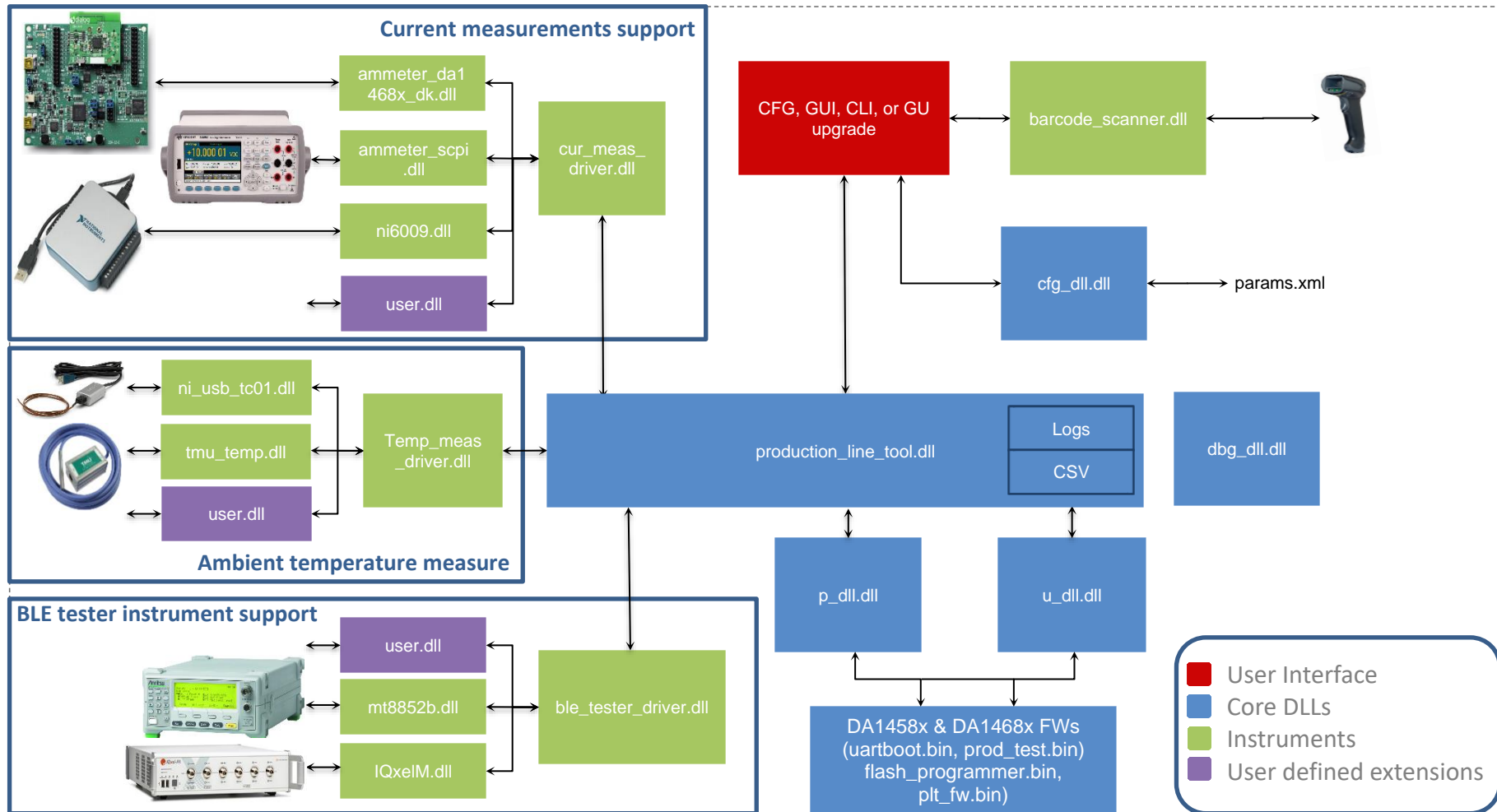

Figure 21: Production Line Tool Software Block Diagram

SmartBond Production Line Tool

The Production Line Tool software is a collection of software blocks that interact with each other, as shown in [Figure 21](#). Its main purpose is to communicate with the PLT hardware and the DUTs to be able to run the production tests and perform memory operations. The software blocks can be arranged in four main groups:

- **Red blocks:** User Interface (UI) applications.
- **Blue blocks:** Core libraries.
- **Green blocks:** Instrument interface libraries.
- **Purple blocks:** User defined extensions.

Core libraries, instrument interface libraries and user-defined extension APIs can be found in the HTML help inside the source PLT directory. The User Interface applications block consists of four application executables. For details, see section [Applications](#).

Table 5: PLT User Interface Application Executables

Short Name	File Name	Description
CFG PLT	SmartBond_CFG_PLT.exe	Configuration application. Load, edit and save the test parameters and the memory actions to be performed during device testing.
GUI PLT	SmartBond_GUI_PLT.exe	Graphical User Interface (GUI) application. Performs the actual device validation and memory programming. Provides a visual indication of the test results and access to the result logs.
CLI PLT	SmartBond_CLI_PLT.exe	The same as the GUI PLT but console based.
GU Upgrade	GU_fw_upgrade.exe	A Graphical User Interface (GUI) application, which is used to easily upgrade the firmware of the Golden Unit.

6.2 Software Package Contents

The PLT software release package comes in a compressed folder `SmartBond_PLT_v_X.X.zip`, where 'X' represents the version number of the current PLT release.

[Figure 22](#) illustrates the main folders of the PLT software package. Folder `executables` holds all the executables and libraries needed for the PLT to run on a Windows 7/8/8.1/10 machine. Folder `source` contains the entire source code of the PLT, organized in a Visual Studio Express 2015 solution.

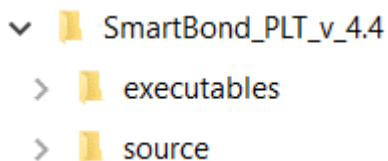

Figure 22: SmartBond PLT Software Package Contents

[Table 6](#) gives a short description of the files and folders contained in the `executables` directories.

Table 6: Executables Folder Description

File or Folder	Description
<code>ammeter_instr_plugins/</code>	Contains the current measurement instrument DLLs, used during the current measurement tests.
<code>ammeter_instr_plugins/ni6009.dll</code>	This is the DLL for the NI-6009 DAQ [14] that could be used in the current measurements. The usage of this instrument for measuring the current requires an external shunt resistor and things complicate when the measurement switches from many DUTs to one DUT. We only recommend using this instrument if one DUT per run

SmartBond Production Line Tool

File or Folder	Description
	is tested.
ammeter_instr_plugins/ammeter_sspi.dll	This is the DLL for taking current measurements using a DMM that supports the standard SCPI commands. NI-VISA is also used for this purpose. Example DMM instruments are the Keysight 34401A [6], the Keithely 2000 [7] or the Keysight 34461A [15]. The PLT has been tested with all three instruments.
ammeter_instr_plugins/ammeter_da1468x_dk.dll	This is the DLL for taking current measurements using the current measurement module placed on the DA1469x pro motherboard.
binaries/	Contains the necessary firmware binaries used during testing. Additionally, the SetupCode_Generator_680.exe application used in homekit products to create a specific hash key is included.
binaries/GU/prod_test_GU.bin	Contains the Golden Unit latest firmware binary. Users should better upgrade their PLT hardware with the GU firmware contained in this folder.
ble_tester_instr_plugins/	Contains the BLE tester instrument DLLs.
ble_tester_instr_plugins/mt8852b.dll	This is the DLL that performs the Direct Test Mode RF tests using the Anritsu MT8852B instrument [5]. Note: There is an issue in Anritsu MT8852B firmware version 4.20.000 and should be upgraded to the latest one. Latest MT8852B instrument firmware can be downloaded from the following link: https://www.anritsu.com/en-US/test-measurement/support/downloads?model=MT8852B
ble_tester_instr_plugins/IQxelM.dll	This is the DLL that performs the Direct Test Mode RF tests using the Litepoint IQxel-M instrument [13].
icons/	Contains pictures used by the PLT applications.
IQmeasure_3.1.2/	Contains specific Litepoint IQxel-M DLLs as released by Litepoint.
params/	Contains the configuration params.xml file, the XML schema params.xsd and a sample of BD address file named bd_address.ini.
params/custom_mem_data.csv	This is a sample CSV file to be used in the custom memory burn action. Users could edit this file and add their own specific memory data to be burned by the PLT. The PLT will match the entries in the CSV file using the BD addresses. The format of the file is explained later.
scripts/	Contains sample batch script files. User can select batch script files to be executed by the PLT before and after each test.
scripts/run_before_tests.cmd	An example script that copies and renames binaries from a directory to a folder required by the PLT when 'Different image per DUT' is selected. This folder is accessed by the PLT to read and burn different binary per DUT.
scripts/run_after_tests.cmd	An example script that moves all logs files, except the ones with the current date, to a specific folder.
temp_meas_instr_plugins/	Contains the temperature measurement instrument DLLs.
temp_meas_instr_plugins/ni_usb_tc01.dll	The ni_usb_tc01.dll is the DLL used to interface a NI USB TC01 [9] temperature sensor for temperature measurements.

SmartBond Production Line Tool

File or Folder	Description
temp_meas_instr_plugins/tmu_temp_sens.dll	The <code>tmu_temp_sens.dll</code> is the DLL used to interface a Papouch TMU sensor [7] for temperature measurements.
volt_meter_instr_plugins/	Contains the voltage meter instrument DLLs. These are used only in DA14681-00 silicon for ADC calibration purposes.
volt_meter_instr_plugins /volt_meter_scp.dll	The <code>volt_meter_scp.dll</code> is a DLL that implements basic interface with a DVM using SCPI commands through NI-VISA libraries and GPIB interface. Has been tested with Keithley 2000 [7] and Keysight 34401A [6].
SmartBond_CFG_PLT.exe	This is the configuration application. It is a graphical user interface application used to edit the PLT test configuration parameters, saved in an XML file, <code>params.xml</code> .
SmartBond_CLI_PLT.exe	This is the command line interface tool. It performs the production tests and memory programming through a console.
SmartBond_GUI_PLT.exe	This is the graphical user interface tool. It performs the production tests and memory programming through a graphical user interface.
GU_fw_upgrade.exe	This is the Golden Unit firmware upgrade application.
ammeter_driver.dll/.lib	This DLL loads and accesses all DMM instrument DLLs from inside the <code>ammeter_instr_plugins</code> . It acts as an intermediate layer between the <code>prod_line_tool_dll</code> and the instrument DLLs.
barcode_scanner.dll/.lib	This DLL receives BD addresses from a barcode scanner with USB to serial interface. Has been tested with Honeywell Xenon 1900 and the Motorola LS2208 barcode scan readers [10] [11].
ble_tester_driver.dll/.lib	This DLL loads and accesses all BLE tester instrument DLLs from inside <code>ble_tester_instr_plugins</code> folder.
cfg_dll.dll/.lib	This is the configuration parameter handling DLL. It can validate, load and save parameters from a given XML file.
dbg_dll.dll/.lib	The <code>dbg_dll.dll</code> file is a DLL used to print debug messages to a file or to a debug console.
ftd2xx.dll	This is the FTDI DLL. Used to hard reset the Golden Unit from the application whenever needed through an FTDI GPIO pin.
p_dll.dll/.lib	This is the production test DLL that performs device functional tests.
prod_line_tool_dll.dll/.lib	This is the core DLL. The heart of the system that performs the state machines for all tests and memory actions to be executed. It is responsible to log the results and notify the user interfaces about the current device test status.
temp_meas_driver.dll/.lib	This is the temperature measurement driver DLL. It loads and accesses all temperature measurement DLLs from inside the <code>temp_meas_instr_plugins</code> folder.
u_dll.dll/.lib	This is the DLL that performs the memory actions, like the memory programming, erasing, etc.
vc_redist.x86.exe/vc_redist.x64.exe	These are the Visual Studio 2017 Express redistributable packages for 32 and 64-bit machines. For installing these, users should agree to the license requirements described during the installation of any of these packages and also

SmartBond Production Line Tool

File or Folder	Description
	found here: https://www.visualstudio.com/license-terms/mt171551/ .
volt_meter_driver.dll/.lib	This is the voltage meter driver DLL. It loads and accesses all voltage meter DLLs from inside the volt_meter_instr_plugins folder.

6.3 Prerequisites

Before building and running the code, the packages indicated in Table 7 should be installed on the PC. Some are required and others are optional depending on the tests or actions needed.

Table 7: Production Line Tool Prerequisites

Item	Optional	Description
Visual Studio 2017 Express	Yes	The IDE used to edit and debug the Production Line Tool. This is only required if users would like to edit the software.
vc_redist.x86.exe	No	Already described in Table 6. Users should agree to the license requirements described during the installation of any of these packages and also found here: https://www.visualstudio.com/license-terms/mt171551/ .
MSXML6	No	Installed by default in Win 7/8/8.1/10.
.NET framework 4.5	No	Needed for the graphical user interface applications.
Latest FTDI drivers	No	Tested with FTDI v2.12.24, v2.12.26 and v2.12.28 drivers.
Honeywell Xenon 1900 drivers	Yes	Needed if the barcode scanner is going to be used for scanning the devices BD addresses and/or custom memory data. Other types of barcode scanners could also be used.
Motorola LS2208 drivers	Yes	Used if a barcode scanner is going to be used for scanning the device BD addresses and/or custom memory data.
NI-VISA 15.5	Yes	Used for optional instrument control, like BLE tester and voltage meter. NI-VISA 15.5 can be downloaded from http://www.ni.com/download/ni-visa-15.5/5846/en/
NI-488.2 15.5	Yes	Used for instrument control, like BLE tester and DMM. NI-488.2 15.5 can be downloaded from http://www.ni.com/download/ni-488.2-15.5/5859/en/
NI-DAQmx	Yes	Used for optional instrument control like temperature measurements using the NI USB TC01 sensor.

SmartBond Production Line Tool

6.4 System Requirements

Table 8 contains the minimum system requirements for the PLT to operate.

Table 8: Minimum System Requirements

Item	Minimum Requirements	
Operating system	Windows 7/8/8.1/10	
CPU	Quad Core CPU	
Memory	4 GB RAM or larger. Each device log can reach up to 40 kB.	
Hard drive	For 100000 devices, at least 4 GB of available hard disk is required.	
Monitor resolution	1280 x 768 or higher	
Monitor DPI	Smaller - 100% = 96 DPI	Supported
	Medium - 125% = 120 DPI	Supported
	Larger - 150% = 144 DPI	Not supported

6.5 Limitations

Parallel control of multiple PLT hardware boards on the same PC is **not supported**.

However, by correctly setting up the system, two or more PLT hardware boards could be connected and controlled by multiple GUI PLT application instances on the same PC, but the tests should only be executed **sequentially**. The main reasons for this limitation are indicated below:

- The GU FT232 FTDI IC is programmed to have a special serial string, "DialogSemi" (see [Table 108](#)). This is used in the 'GU COM port find' PLT operation. This operation searches all PC connected FTDIs to find the serial string "DialogSemi". When found, it saves it as the GU COM port number to be used by the PLT. The 'GU COM port find' operation will open and lock, for a short period of time, all Windows COM ports, one by one, even the ones used by the other PLT hardware. If the second GUI PLT application instance is performing test operations at the same time and wants to open its DUT COM ports, the operation may fail.
- When the GUI PLT application starts the test operations, it performs a DUT COM port enumeration. During this process, the GU sets the CPLD in UART loopback mode. It opens all PC COM ports one by one and sends a specific word, while trying to see if it receives it back. During this process, other PLTs may need to work with 'their' DUT COM ports, which may happen to be currently used by the 'DUT COM port enumeration' process of the first PLT.
- GU hardware reset. In every PLT test run a GU HW reset is issued from the PLT software using a specific GU FTDI GPIO pin. To access the GU FTDI, the FTDI API is used from `ftd2xx.dll`. To access the FTDI hardware and read the serial number through the FTDI `ftd2xx.dll` the `FT_Open` API is used on all PC COM ports, one by one. Since `FT_Open` is used in all PC COM ports, conflicts could arise if other PLTs would also like to use these COM ports.
- BD addresses handling. Usually, the PLT automatically sets the DUT BD addresses by increasing them one by one. Special care should be taken to work with multiple PLT hardware and software. Most probably, two different BD address files should be used for each PLT hardware.













SmartBond Production Line Tool

6.6 Building the Code

The PLT software release package contains not only application executables for directly performing the tests out of the box, but also the entire source code of the tools. This is organized in a Visual Studio 2017 Express solution.

To open the Visual Studio 2017 Express PLT source code solution the following steps should be executed (see Table 9).

Table 9: Opening the PLT Visual Studio 2017 Express Source Code Solution

Step	Description
1	Download the latest PLT software package (e.g. SmartBond_PLT_v_4.x.zip)
2	<p>Extract the software package. The following two folders should exist.</p> <pre>> SmartBond_PLT_v_4.4</pre> <hr/> <p>Name</p> <ul style="list-style-type: none">  executables  source  licensing.txt
3	<p>Go to folder 'source\production_line_tool'. The following files and folders should exist.</p> <pre>> SmartBond_PLT_v_4.4 > source > production_line_tool ></pre> <hr/> <p>Name</p> <ul style="list-style-type: none">  .vs  core_dlls  DA14531_DA1469x_Release  Debug  fw_files  help  instruments  UI  VS2017_redist  production_line_tool.sln
4	Double click the production_line_tool.sln Visual Studio 2017 Express solution file. The Visual Studio 2017 Express application will start and the PLT Solution Explorer should be shown.

SmartBond Production Line Tool

Step	Description
	<p>The screenshot shows the Solution Explorer for a solution named 'production_line_tool' containing 22 projects. The structure is as follows:</p> <ul style="list-style-type: none"> core_dlls <ul style="list-style-type: none"> ftdi_dll cfg_dll dbg_dll p_dll prod_line_tool_dll u_dll instruments <ul style="list-style-type: none"> ammeters <ul style="list-style-type: none"> ammeter_da1468x_dk ammeter_driver ammeter_scpi ni6009 barcode_scanner <ul style="list-style-type: none"> barcode_scanner ble_testers <ul style="list-style-type: none"> ble_tester_driver IQxelM mt8852b temp_sensors <ul style="list-style-type: none"> ni_usb_tc01 temp_meas_driver tmu_temp_sens voltmeters <ul style="list-style-type: none"> volt_meter_driver volt_meter_scpi UI <ul style="list-style-type: none"> common cfg_gui CLI_plt GU_fw_upgrade GUI_plt
5	<p>To build the code follow the process described in the <i>UM-B-040</i> document [1].</p> <p>Note: There is no need to unload any projects for the solution to be built. This was fixed in PLT v4.4 by dynamically linking DLLs.</p>

SmartBond Production Line Tool

6.7 Executing the Applications

To execute the Production Line Tool applications, the process described in the following tables should be followed.

Table 10: SmartBond_CFG_PLT.exe Application Execution

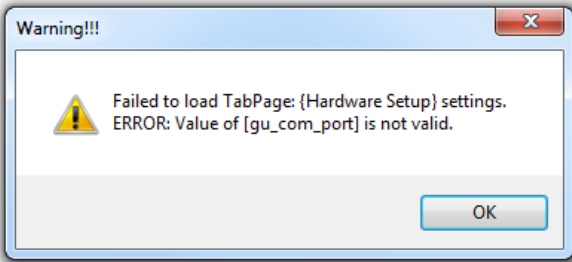
Step	Description																																												
1	Download the latest PLT software package (e.g. SmartBond_PLT_v_x.x.zip).																																												
2	<p>Extract the software package. The following two folders should exist.</p> <p>> SmartBond_PLT_v_4.4</p> <table border="1"> <thead> <tr> <th>Name</th> </tr> </thead> <tbody> <tr> <td>executables</td> </tr> <tr> <td>source</td> </tr> <tr> <td>licensing.txt</td> </tr> </tbody> </table>	Name	executables	source	licensing.txt																																								
Name																																													
executables																																													
source																																													
licensing.txt																																													
3	<p>Go to folder 'executables'. This folder should contain the following files and sub-folders.</p> <p>> SmartBond_PLT_v_4.4 > executables</p> <table border="1"> <tbody> <tr> <td>ammeter_instr_plugins</td> <td>SmartBond_CLI_PLT.exe</td> <td>p_dll.dll</td> <td>ni_daqmx_shim.lib</td> </tr> <tr> <td>binaries</td> <td>SmartBond_GUI_PLT.exe</td> <td>prod_line_tool_dll.dll</td> <td>ni_visa_shim.lib</td> </tr> <tr> <td>ble_tester_instr_plugins</td> <td>vc_redist.x86.exe</td> <td>temp_meas_driver.dll</td> <td>p_dll.lib</td> </tr> <tr> <td>icons</td> <td>ammeter_driver.dll</td> <td>u_dll.dll</td> <td>prod_line_tool_dll.lib</td> </tr> <tr> <td>IQmeasure_3.1.2</td> <td>barcode_scanner.dll</td> <td>volt_meter_driver.dll</td> <td>temp_meas_driver.lib</td> </tr> <tr> <td>params</td> <td>ble_tester_driver.dll</td> <td>ammeter_driver.lib</td> <td>u_dll.lib</td> </tr> <tr> <td>scripts</td> <td>cfg_dll.dll</td> <td>barcode_scanner.lib</td> <td>volt_meter_driver.lib</td> </tr> <tr> <td>temp_meas_instr_plugins</td> <td>dbg_dll.dll</td> <td>ble_tester_driver.lib</td> <td></td> </tr> <tr> <td>volt_meter_instr_plugins</td> <td>ftd2xx.dll</td> <td>cfg_dll.lib</td> <td></td> </tr> <tr> <td>GU_fw_upgrade.exe</td> <td>ni_daqmx_shim.dll</td> <td>dbg_dll.lib</td> <td></td> </tr> <tr> <td>SmartBond_CFG_PLT.exe</td> <td>ni_visa_shim.dll</td> <td>ftd2xx.lib</td> <td></td> </tr> </tbody> </table>	ammeter_instr_plugins	SmartBond_CLI_PLT.exe	p_dll.dll	ni_daqmx_shim.lib	binaries	SmartBond_GUI_PLT.exe	prod_line_tool_dll.dll	ni_visa_shim.lib	ble_tester_instr_plugins	vc_redist.x86.exe	temp_meas_driver.dll	p_dll.lib	icons	ammeter_driver.dll	u_dll.dll	prod_line_tool_dll.lib	IQmeasure_3.1.2	barcode_scanner.dll	volt_meter_driver.dll	temp_meas_driver.lib	params	ble_tester_driver.dll	ammeter_driver.lib	u_dll.lib	scripts	cfg_dll.dll	barcode_scanner.lib	volt_meter_driver.lib	temp_meas_instr_plugins	dbg_dll.dll	ble_tester_driver.lib		volt_meter_instr_plugins	ftd2xx.dll	cfg_dll.lib		GU_fw_upgrade.exe	ni_daqmx_shim.dll	dbg_dll.lib		SmartBond_CFG_PLT.exe	ni_visa_shim.dll	ftd2xx.lib	
ammeter_instr_plugins	SmartBond_CLI_PLT.exe	p_dll.dll	ni_daqmx_shim.lib																																										
binaries	SmartBond_GUI_PLT.exe	prod_line_tool_dll.dll	ni_visa_shim.lib																																										
ble_tester_instr_plugins	vc_redist.x86.exe	temp_meas_driver.dll	p_dll.lib																																										
icons	ammeter_driver.dll	u_dll.dll	prod_line_tool_dll.lib																																										
IQmeasure_3.1.2	barcode_scanner.dll	volt_meter_driver.dll	temp_meas_driver.lib																																										
params	ble_tester_driver.dll	ammeter_driver.lib	u_dll.lib																																										
scripts	cfg_dll.dll	barcode_scanner.lib	volt_meter_driver.lib																																										
temp_meas_instr_plugins	dbg_dll.dll	ble_tester_driver.lib																																											
volt_meter_instr_plugins	ftd2xx.dll	cfg_dll.lib																																											
GU_fw_upgrade.exe	ni_daqmx_shim.dll	dbg_dll.lib																																											
SmartBond_CFG_PLT.exe	ni_visa_shim.dll	ftd2xx.lib																																											
4	<p>Double click the SmartBond_CFG_PLT.exe application executable. Most probably, the following warning will be shown.</p>  <p>During start-up, the SmartBond_CFG_PLT.exe application loads the Hardware configuration parameters from the params.xml file. These parameters also contain the GU COM port. The default params.xml file has the GU COM port set to 4. If this COM port number does not exist in the PC, then this warning message will be shown. Therefore, this warning message indicates that the default GU COM port set in the params.xml file is not valid or that the GU USB cable is not connected to the PC.</p> <p>Press 'OK' if the warning message appears.</p>																																												

SmartBond Production Line Tool

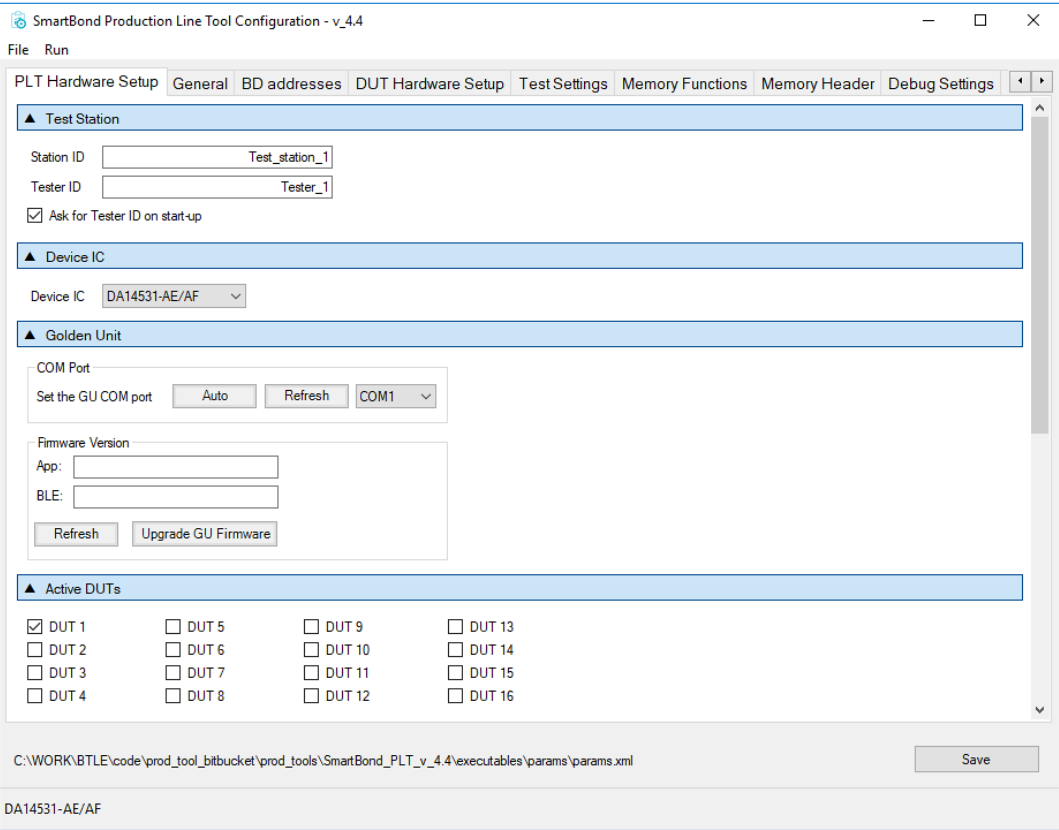
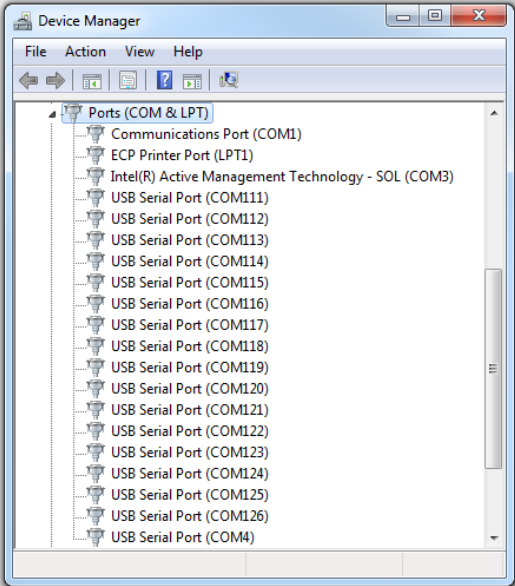
Step	Description
5	<p>The application will start, and the initial <i>Hardware Setup</i> screen will be shown.</p> 
6	<p>Connect the PLT HW to the PC. Connect the GU and the DUT USB cables to the PC. Check the Windows Device Manager that 17 new COM ports were found, 16 for the DUTs and 1 for the GU. The following screenshot is an example of a Device Manager COM ports for a PC that has the PLT connected.</p> 

SmartBond Production Line Tool

Step	Description
7	<p>On the SmartBond_CFG_PLT.exe Hardware Setup initial screen click Auto to automatically find the GU COM port among the 17 Windows enumerated COM ports. The Auto button will turn green if successful. Press Save* to save the new GU COM port in the params.xml file.</p>

Table 11: SmartBond_GUI_PLT.exe Application Execution

Step	Description
1	To successfully start the SmartBond_GUI_PLT.exe application, the SmartBond_CFG_PLT.exe should be executed first in order to set up the system and perform the required tests. See Table 10.
2	<p>Go to folder 'executables'. This folder should contain the following files and sub-folders. Double click on SmartBond_GUI_PLT.exe.</p>
3	<p>A new window will ask for the Tested ID name. Enter the name and click OK.</p>
3	The following initial screen will appear.

SmartBond Production Line Tool

Step	Description
	<p>The screenshot shows the SmartBond Production Line Tool interface. On the left, there are configuration fields for 'Start BD address', 'Next BD address', and 'End BD address', all set to '00:00:00:00:00:01'. Below these are 'Statistics' (Pass: 0, Fail: 0, Total: 0, Left: 0, Runs: 0) and 'IC' (DA14531-AE/AF). There are checkboxes for 'COM Enum', 'GU Check', 'VBAT/UART', and 'UART check'. A large 'START' button is centered at the bottom. The status bar at the bottom right shows 'Retest failed: Disabled' and 'Test Time: 00:00:00'.</p>
4	By clicking the keyboard spacebar, the START button will be pressed and the preconfigured tests and memory actions will start to be executed.

Table 12: SmartBond_CLI_PLT.exe Application Execution

Step	Description																																												
1	To successfully start the SmartBond_CLI_PLT.exe application, the SmartBond_CFG_PLT.exe should be executed first, in order to set up the system and perform the required tests. See Table 10 .																																												
2	<p>Go to folder 'executables'. This folder should contain the following files and sub-folders.</p> <pre>> SmartBond_PLT_v_4.x > executables</pre> <table border="0"> <tr> <td>ammeter_instr_plugins</td> <td>SmartBond_CLI_PLT.exe</td> <td>p_dll.dll</td> <td>ni_daqmx_shim.lib</td> </tr> <tr> <td>binaries</td> <td>SmartBond_GUI_PLT.exe</td> <td>prod_line_tool_dll.dll</td> <td>ni_visa_shim.lib</td> </tr> <tr> <td>ble_tester_instr_plugins</td> <td>vc_redist.x86.exe</td> <td>temp_meas_driver.dll</td> <td>p_dll.lib</td> </tr> <tr> <td>icons</td> <td>ammeter_driver.dll</td> <td>u_dll.dll</td> <td>prod_line_tool_dll.lib</td> </tr> <tr> <td>IQmeasure_3.1.2</td> <td>barcode_scanner.dll</td> <td>volt_meter_driver.dll</td> <td>temp_meas_driver.lib</td> </tr> <tr> <td>params</td> <td>ble_tester_driver.dll</td> <td>ammeter_driver.lib</td> <td>u_dll.lib</td> </tr> <tr> <td>scripts</td> <td>cfg_dll.dll</td> <td>barcode_scanner.lib</td> <td>volt_meter_driver.lib</td> </tr> <tr> <td>temp_meas_instr_plugins</td> <td>dbg_dll.dll</td> <td>ble_tester_driver.lib</td> <td></td> </tr> <tr> <td>volt_meter_instr_plugins</td> <td>ftd2xx.dll</td> <td>cfg_dll.lib</td> <td></td> </tr> <tr> <td>GU_fw_upgrade.exe</td> <td>ni_daqmx_shim.dll</td> <td>dbg_dll.lib</td> <td></td> </tr> <tr> <td>SmartBond_CFG_PLT.exe</td> <td>ni_visa_shim.dll</td> <td>ftd2xx.lib</td> <td></td> </tr> </table>	ammeter_instr_plugins	SmartBond_CLI_PLT.exe	p_dll.dll	ni_daqmx_shim.lib	binaries	SmartBond_GUI_PLT.exe	prod_line_tool_dll.dll	ni_visa_shim.lib	ble_tester_instr_plugins	vc_redist.x86.exe	temp_meas_driver.dll	p_dll.lib	icons	ammeter_driver.dll	u_dll.dll	prod_line_tool_dll.lib	IQmeasure_3.1.2	barcode_scanner.dll	volt_meter_driver.dll	temp_meas_driver.lib	params	ble_tester_driver.dll	ammeter_driver.lib	u_dll.lib	scripts	cfg_dll.dll	barcode_scanner.lib	volt_meter_driver.lib	temp_meas_instr_plugins	dbg_dll.dll	ble_tester_driver.lib		volt_meter_instr_plugins	ftd2xx.dll	cfg_dll.lib		GU_fw_upgrade.exe	ni_daqmx_shim.dll	dbg_dll.lib		SmartBond_CFG_PLT.exe	ni_visa_shim.dll	ftd2xx.lib	
ammeter_instr_plugins	SmartBond_CLI_PLT.exe	p_dll.dll	ni_daqmx_shim.lib																																										
binaries	SmartBond_GUI_PLT.exe	prod_line_tool_dll.dll	ni_visa_shim.lib																																										
ble_tester_instr_plugins	vc_redist.x86.exe	temp_meas_driver.dll	p_dll.lib																																										
icons	ammeter_driver.dll	u_dll.dll	prod_line_tool_dll.lib																																										
IQmeasure_3.1.2	barcode_scanner.dll	volt_meter_driver.dll	temp_meas_driver.lib																																										
params	ble_tester_driver.dll	ammeter_driver.lib	u_dll.lib																																										
scripts	cfg_dll.dll	barcode_scanner.lib	volt_meter_driver.lib																																										
temp_meas_instr_plugins	dbg_dll.dll	ble_tester_driver.lib																																											
volt_meter_instr_plugins	ftd2xx.dll	cfg_dll.lib																																											
GU_fw_upgrade.exe	ni_daqmx_shim.dll	dbg_dll.lib																																											
SmartBond_CFG_PLT.exe	ni_visa_shim.dll	ftd2xx.lib																																											

SmartBond Production Line Tool

Step	Description
3	<p>Double click the SmartBond_CLI_PLT.exe application executable. The following initial screen will appear.</p>  <pre> SmartBond Production Line Tool - v_4.4 SmartBond Production Line Tool v_4.4 Command list: t <531-AE-AF/69x-01> --> Select the IC for device under test. i <configuration file path> --> Import new configuration settings. All DLLs will be reinitialized with the new parameters. x --> Print the configuration parameters from the currently used XML file. a <FFFF-0000> --> Bitwise DUT activation. b <xx:xx:xx:xx:xx:xx> --> BD address to be used in the first active DUT of the next PLT test run. c <on/off> --> Graphics enable or disable. r <qspi/otp> --> DUT BD address read. v <qspi/otp> --> DUT BD address read and compare with given BD address. p --> DUT COM port enumeration. g --> GU COM port find. l --> GU check by blinking its LED. m <1FFFF-00000> --> MSB=1 init. Next 16 bits are for bitwise DUT VBAT/UART set/reset. d <file> --> Enable Error and Info prints. Printed on file. q <otp/spi/eeprom/qspi> <address(hex otp->DA14531-AE-AF=0-7FFF, DA1469x-01=10080000-1008FFFF)><size in decimal> --> Read me mory data. Prints up to 14 bytes. s --> Start the tests. u <9600/19200/57600/115200/1000000> --> Run the UART check procedure. w <number of tests> --> Command used only for tool evaluation. Runs multiple tests, one after the other, without stopping. z --> Reset all parameters to their defaults. h --> Print this help. e --> Exit. >_ </pre>
4	Type 's' then click Enter. The preconfigured tests and memory actions will start to be executed.

Table 13: GU_fw_upgrade.exe Application Execution

Step	Description
1	GU_fw_upgrade.exe can be started by either opening the application from the executables folder or by pressing the 'Upgrade GU Firmware' button in the PLT Hardware Setup tab in SmartBond_CFG_PLT.exe.
2	<p>Go to folder 'executables'. This folder should contain the following files and sub-folders.</p>  <pre> > SmartBond_PLT_v_4x > executables > ├── ammeter_instr_plugins ├── binaries ├── ble_tester_instr_plugins ├── icons ├── IQmeasure_3.1.2 ├── params ├── scripts ├── temp_meas_instr_plugins ├── volt_meter_instr_plugins ├── GU_fw_upgrade.exe └── SmartBond_CFG_PLT.exe SmartBond_CLI_PLT.exe SmartBond_GUI_PLT.exe vc_redist.x86.exe ammeter_driver.dll barcode_scanner.dll ble_tester_driver.dll cfg_dll.dll dbg_dll.dll ftd2xx.dll ni_daqmx_shim.dll ni_visa_shim.dll p_dll.dll prod_line_tool_dll.dll temp_meas_driver.dll u_dll.dll volt_meter_driver.dll ammeter_driver.lib barcode_scanner.lib ble_tester_driver.lib cfg_dll.lib dbg_dll.lib ftd2xx.lib ni_daqmx_shim.lib ni_visa_shim.lib p_dll.lib prod_line_tool_dll.lib temp_meas_driver.lib u_dll.lib volt_meter_driver.lib </pre>

SmartBond Production Line Tool

Step	Description
3	<p>Double click the <code>GU_fw_upgrade.exe</code> application executable. The following initial screen will appear.</p> 
4	<p>Follow the instructions to guide you to successfully configure and select the Golden Unit. A detailed procedure is explained in Chapter 7.5.</p>

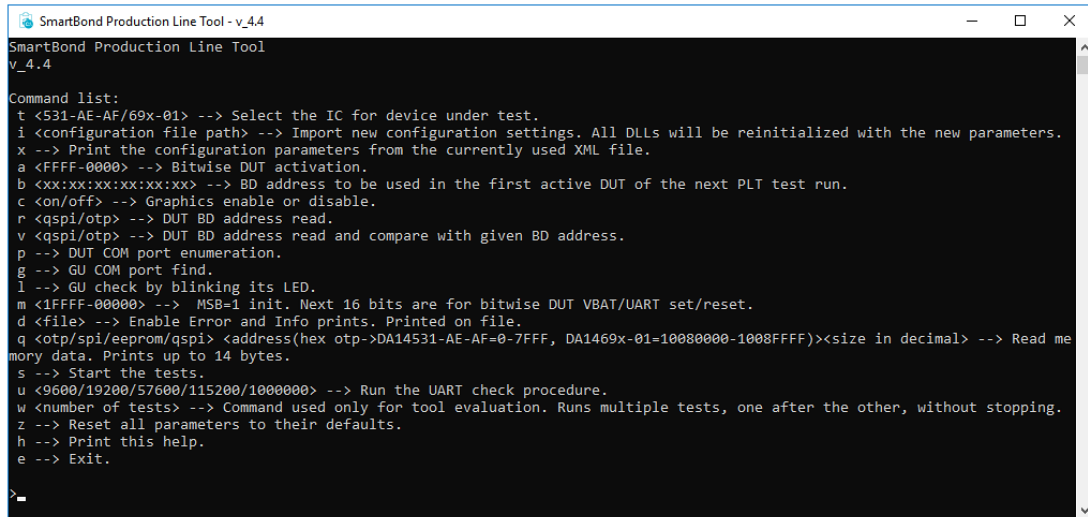
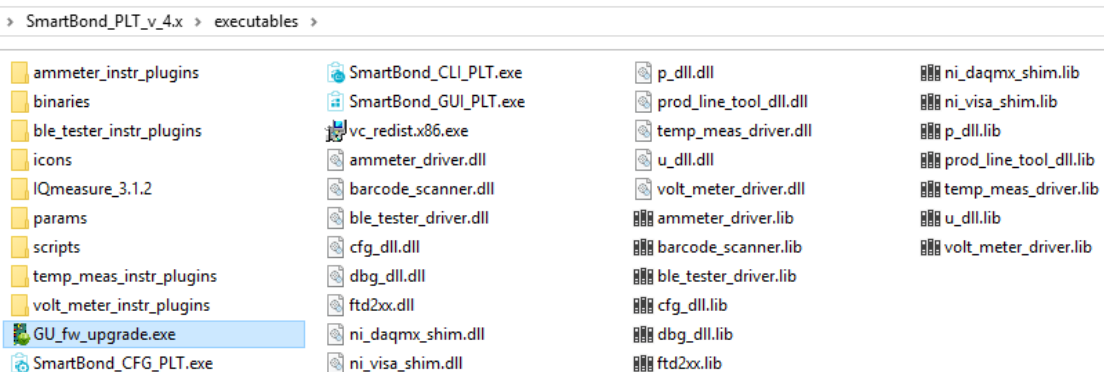
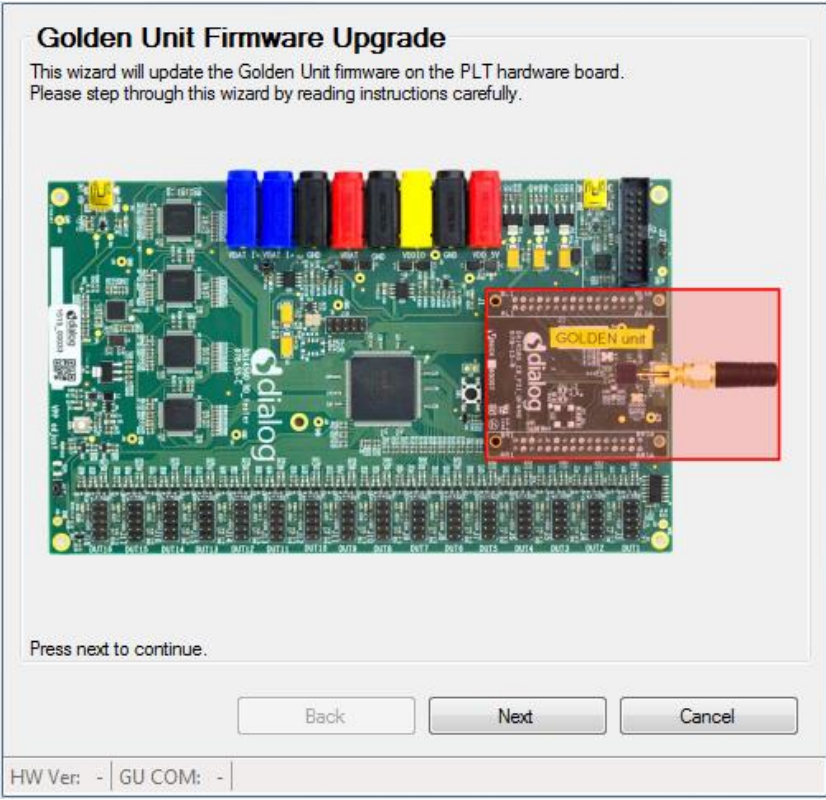
6.8 Test Sequence

This section describes the sequence of steps involved for the DA14531 and DA1469x device testing. It outlines all the steps the PLT follows to successfully test a device.

6.8.1 DA1458x Test Sequence

Table 14 describes each step the PLT undertakes for DA1453x devices. Some of the steps are optional and will only be executed if the equivalent actions are enabled in the configuration parameters. Additionally, some of the steps are supported only for specific DA1458x IC versions.

The entire test sequence for the DA1453x DUTs is shown in Figure 23.

Table 14: DA14531 Test Sequence

Step	Action	Opt	Description
1	Statistics update	No	Update the total tests executed.
2	BD addresses	No	Update the BD addresses for all DUTs.
3	Configuration parameters	No	Configuration parameters are passed from the CLI or GUI to the <code>prod_line_tool_dll</code> . If any of the parameters is not valid, an error will occur.
4	Reset GU	No	Golden Unit hardware reset by controlling an FT232 pin.
5	Initialize CPLD	No	Set the CPLD to an initial known state.
6	Check temperature sensor instrument	Yes	Check whether the temperature measurement instrument is online, only if the temperature measurement test is active.

SmartBond Production Line Tool

Step	Action	Opt	Description
7	Check BLE tester instrument	Yes	Check whether the BLE tester instrument is online, only if any of the BLE tester test operations is active.
8	Check ammeter instrument	Yes	Check whether the ammeter is online, only if any of the current measurement tests is active.
9	Toggle GU LED	No	Toggle the GU red LED on the PLT hardware to indicate that the GU is alive.
10	Check DUT COM ports	No	Check whether the PLT has identified the DUT COM ports and if not run the automatic DUT COM port identification.
11	Temperature measure	Yes	If the temperature measurement test is active, take a measurement and log it to all DUT logs and in the CSV file.
12	Download <code>prod_test_531.bin</code>	Yes	If any of the production tests is active (e.g. RF tests, XTAL trim, etc.) download the <code>prod_test_531.bin</code> to the devices.
13	Open the devices COM ports and get the <code>prod_test_531.bin</code> firmware version.	Yes	After <code>prod_test_531.bin</code> has been downloaded to the DUTs, test commands can be sent to it. First, the Windows DUTs COM ports are opened. Then a command to get the <code>prod_test_531.bin</code> firmware version is sent to the devices. If there is a problem in the firmware or in the device, then this is the first failure to happen. The FW version get action will fail.
14	GPIO Watchdog	Yes	If the GPIO watchdog option is enabled, the firmware will begin a periodic GPIO toggling during the whole production test procedure.
15	VBAT level measure	Yes	PLT will send a command to each DUT to measure VBAT for each one, using the internal ADC. VBAT level will be logged for debugging purposes.
16	OTP Timestamp read	Yes	PLT will send a command to measure the DA14531 IC production date and time from the OTP. It will log it for testing purposes.
17	DC-DC Converter level test	Yes	The first test is to measure the DC-DC converter level using the internal ADC. If the level is outside the user defined limits a possible HW error exists.
18	XTAL trim	Yes	Perform the XTAL trim procedure, if this is active.
19	XTAL trim OTP burn	Yes	If the 'Burn to OTP' option is selected in the CFG PLT, then the calculated XTAL trim value will be burned to the OTP Header.
20	UART resync	Yes	If the XTAL trim procedure was performed in the UART RX pin, then a special UART resync procedure takes place to resynchronize the device's UART RX path, as it may have entered into a baud rate error state due to the 500ms XTAL trim pulse received.
21	Scan advertise test	Yes	If the Scan DUT Advertise test is active, a BLE scan test using HCI triggered advertisements will be performed. This is to measure DUTs TX power level.
22	BLE tester TX power	Yes	If the BLE tester TX Power test is active, then perform the test using the external BLE tester instrument.
23	BLE tester TX carrier offset	Yes	If the BLE tester TX carrier offset test is active, then perform the test using the external BLE tester instrument.
24	BLE tester TX modulation index	Yes	If the BLE tester TX modulation index test is active, then perform the test using the external BLE tester instrument.
25	BLE tester RSSI	Yes	If the BLE tester RSSI test is active, then perform the test using the external BLE tester instrument.
26	GU RSSI test	Yes	If the RSSI test using the GU as transmitter is active, then perform the test.
27	GPIO/LED	Yes	Perform the GPIO/LED test, if the test is active.
28	GPIO connection test	Yes	Perform a GPIO continuity or voltage level test, if the test is active.

SmartBond Production Line Tool

Step	Action	Opt	Description
29	Sensor test	Yes	Perform the sensor tests only if these are enabled.
30	Custom test	Yes	Perform any active custom test.
31	External 32kHz	Yes	Check whether the external 32kHz crystal operates correctly.
32	Current measure peripheral	Yes	Perform any active current measurement test for peripherals.
33	Current measure sleep	Yes	Perform the sleep current measurement.
34	Open COM port and perform firmware download	Yes	If any memory action is active (e.g. SPI Flash burn, erase etc.), download the <code>flash_programmer_531.bin</code> to the devices.
35	Get <code>flash_programmer.bin</code> version.	Yes	After <code>flash_programmer_531.bin</code> has been downloaded, commands can be sent. A command to get the <code>flash_programmer_531.bin</code> firmware version is sent to the devices.
36	GPIO watchdog	Yes	If the GPIO watchdog option is enabled, the firmware will begin a periodic GPIO toggling during the whole memory programming procedure.
37	Initialize SPI Flash memory	Yes	If any SPI flash operation is enabled, initialize memory.
38	SPI erase	Yes	Erase the SPI Flash, either entirely or part of it depending on the configuration.
39	SPI check empty	Yes	Depending on the configuration, check whether the SPI Flash is empty to verify the Flash erase procedure.
40	SPI image write	Yes	If enabled, write the SPI Flash with the customer image. If verify is enabled, the contents of the Flash will be read back and compared to the original image downloaded.
41	Initialize I2C EEPROM memory	Yes	If any EEPROM operation is enabled, initialize memory.
42	I2C EEPROM write	Yes	Write the I2C EEPROM with the customer image. If verify is enabled, the contents of the EEPROM will be read back and compared to the original image downloaded.
43	Custom memory data	Yes	Write custom memory data, taken from a barcode scanner, entered manually or through a CVS file.
44	OTP image write	Yes	Write the OTP image with the customer image. If verify is enabled, the contents of the OTP memory will be read back and compared to the original image downloaded.
45	OTP CS write	Yes	If enabled, the OTP configuration script will be burned.
46	OTP header write	Yes	If enabled, the OTP header fields will be burned.
47	Memory read	Yes	Up to ten memory read tests can be performed.
48	Scan test	Yes	If enabled, the GU will scan for device BLE advertisements. For the DUTs to be scanned a valid firmware must be burned into the OTP, SPI Flash or EEPROM that sends BLE advertisements after power up. Additionally, the BD address should be burned into the OTP by the PLT. PLT expects to find devices in the air with the BD addresses programmed by the same tool, so it can match the BD addresses returned by the GU.

SmartBond Production Line Tool

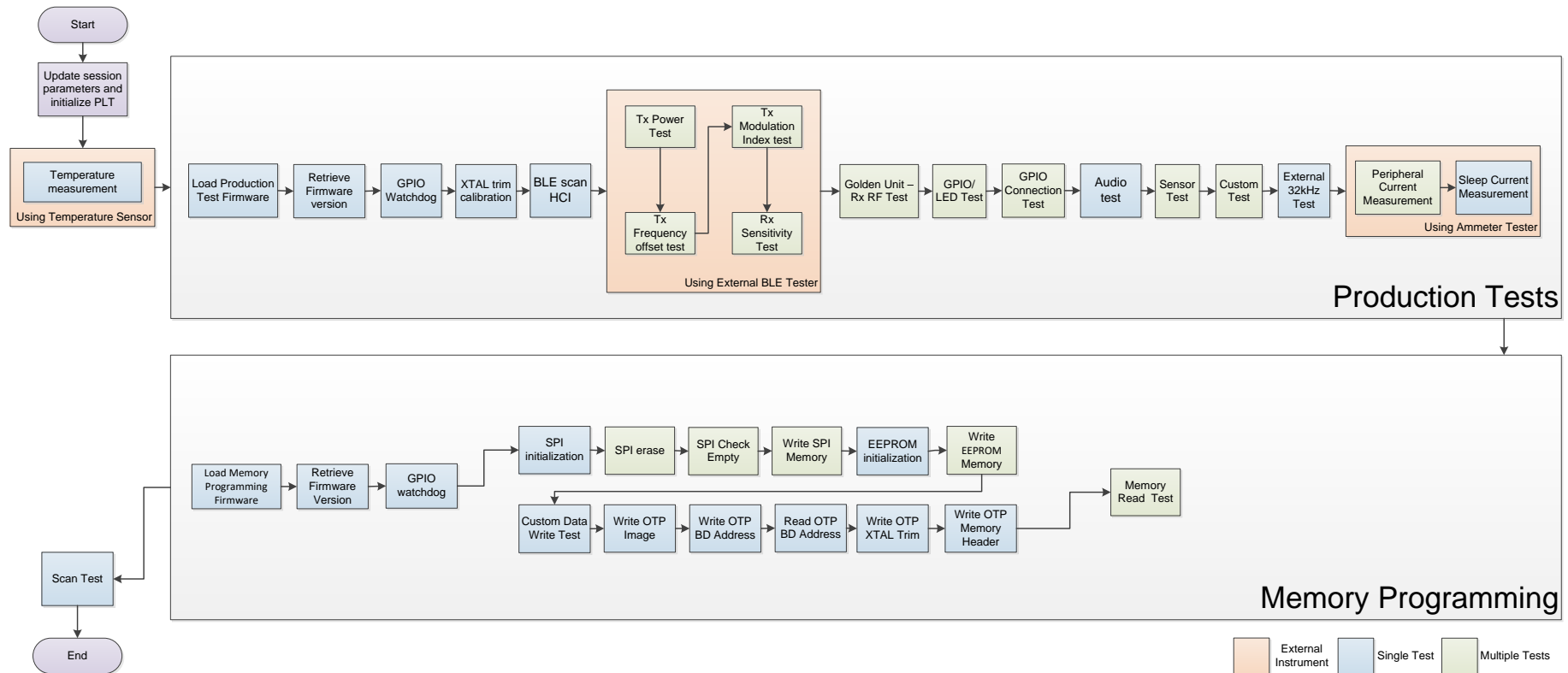

Figure 23: DA14531 Test Sequence

SmartBond Production Line Tool
6.8.2 DA1469x Test Sequence

Table 15 describes each step that the PLT undertakes to validate and program DA1469x based devices. Some of the steps are optional and will only be executed if the equivalent actions are enabled in the configuration parameters. Additionally, some of the steps are supported only for specific DA1469x IC versions.

The entire test sequence for the DA1469x DUTs is shown in Figure 24.

Table 15: DA1469x Test Sequence

Step	Action	Opt	Description
1	Statistics update	No	Update the total tests executed.
2	BD addresses	No	Update the BD addresses for all DUTs.
3	Configuration parameters	No	Configuration parameters are passed from the CLI or GUI to the <code>prod_line_tool_dll</code> . If any of the parameters is not valid, an error will occur.
4	Reset GU	No	GU hardware reset by controlling an FT232 pin.
5	Initialize CPLD	No	The GU will set the CPLD to an initial known state.
6	Check temperature sensor instrument	Yes	Check whether the temperature measurement instrument is online, only if the temperature measurement test is active.
7	Check BLE tester instrument	Yes	Check whether the BLE tester instrument is online, only if any of the BLE tester test operations is active.
9	Check ammeter instrument	Yes	Check whether the ammeter is online, only if any of the current measurement tests is active.
10	Toggle GU LED	No	Toggle the GU red LED on the PLT hardware to indicate that the GU is alive.
11	Check DUT COM ports	No	Check whether the PLT has identified the DUT COM ports and if not run the automatic DUT COM port identification.
12	Temperature measure	Yes	If the temperature measurement test is active, take a measurement and log it to all DUT logs and in the CSV file.
13	Download <code>uartboot_69x.bin</code>	Yes	If any of the production tests is active the <code>uartboot_69x.bin</code> will be downloaded and then the production test firmware. In addition, if the GPIO watchdog option is enabled, it will start toggling after the <code>uartboot_69x.bin</code> is loaded and right before the production test download.
14	GPIO Watchdog	Yes	If the GPIO watchdog option is enabled, then firmware will start the toggling after the <code>uartboot_69x.bin</code> is loaded and right before the production test download.
15	Download <code>prod_test_69x.bin</code>	Yes	If any of the production tests is active (e.g. RF tests, XTAL trim, etc.) download the <code>prod_test_69x.bin</code> to the devices.
16	Open the devices COM ports and get the <code>prod_test_69x.bin</code> firmware version	Yes	After <code>prod_test_69x.bin</code> has been downloaded, commands can be sent to it. First, the Windows DUTs COM ports are opened. Then, a command to get the <code>prod_test_69x.bin</code> firmware version is sent to the devices. If there is a problem in the firmware or in the device, then this is the first failure to happen. The FW version get action will fail.
17	GPIO watchdog	Yes	If the GPIO watchdog option is enabled, the firmware will begin a periodic GPIO toggling during the whole production test procedure.
18	OTP timestamp	Yes	PLT will read the IC production timestamp and log it.
19	VBAT level measure	Yes	PLT will send a command to each DUT to measure VBAT for each

SmartBond Production Line Tool

Step	Action	Opt	Description
			one, using the internal ADC. VBAT level will be logged for debugging purposes.
20	XTAL trim	Yes	Perform the XTAL trim procedure, if this is active.
21	UART resync	Yes	If the XTAL trim procedure was performed in the UART RX pin, then a special UART resync procedure takes place to resynchronize the device's UART RX path as it may have entered in a baud rate error state due to the 500ms received XTAL trim pulse.
22	BLE scan HCI	Yes	If the Scan DUT Advertise test is active, then perform a BLE scan test using HCI triggered advertisements.
23	BLE tester TX power	Yes	If the BLE tester TX Power test is active, then perform the test using the external BLE tester instrument.
24	BLE tester TX carrier offset	Yes	If the BLE tester TX carrier offset test is active, then perform the test using the external BLE tester instrument.
25	BLE tester TX modulation index	Yes	If the BLE tester TX modulation index test is active, then perform the test using the external BLE tester instrument.
26	BLE tester RSSI	Yes	If the BLE tester RSSI test is active, then perform the test using the external BLE tester instrument.
27	GU RSSI test	Yes	If the RSSI test using the GU as transmitter is active, then perform the test.
28	GPIO/LED	Yes	Perform the GPIO/LED test, if the test is active.
29	GPIO Connection test	Yes	Perform a GPIO continuity or voltage level test, if the test is active.
30	Sensor test	Yes	Perform the sensor tests only if these are enabled.
31	Custom test	Yes	Perform any active custom test.
32	External 32kHz	Yes	Check whether the external 32kHz crystal operates correctly.
33	Current measure peripheral	Yes	Perform any active current measurement test for peripherals.
34	Current measure sleep	Yes	Perform the sleep current measurement.
35	Open COM port and download <code>uartboot_69x.bin</code>	Yes	If any of the memory actions is active (e.g. QSPI burn, QSPI erase, etc.) download the <code>uartboot_69x.bin</code> to the devices.
36	Get <code>uartboot_69x.bin</code> version.	Yes	After <code>uartboot_69x.bin</code> has been downloaded, commands can be sent to it. A command to get the <code>uartboot_69x.bin</code> firmware version is sent to the devices.
37	GPIO watchdog	Yes	If the GPIO watchdog option is enabled, the firmware will begin a periodic GPIO toggling during the whole memory programming procedure.
38	QSPI memory initialization	Yes	If any QSPI operation is enabled, initialize memory.
39	QSPI erase	Yes	Erase the QSPI, either the entire or part of it depending on the configuration.
40	QSPI check empty	Yes	Depending on the configuration, check whether the QSPI is empty to verify the QSPI erase procedure.
41	QSPI image write	Yes	If enabled, write the QSPI with the customer image. If verify is enabled, the contents of the QSPI will be read back and compared to the original image downloaded.
42	QSPI BD address write	Yes	If enabled, the device BD address is programmed to a specific QSPI flash address.
43	QSPI BD address read	Yes	If enabled, the PLT will read the BD address field from the QSPI.

SmartBond Production Line Tool

Step	Action	Opt	Description
			This will be printed in the GUI, CLI screen and in the device logs. An additional test can be enabled to compare the read BD address to the one supplied by the tool.
44	Custom memory data	Yes	Write custom memory data, taken from a barcode scanner, entered manually or through a CVS file.
45	OTP image write	Yes	Write the OTP image with the customer image. If verify is enabled, the contents of the OTP memory will be read back and compared to the original image downloaded.
46	OTP CS write	Yes	If enabled, PLT will program the OTP configuration script area
47	Memory read	Yes	Up to 10 memory read tests can be performed with up to 256 bytes in length.
48	Scan test	Yes	If enabled, the GU will scan for device BLE advertisements. For the DUTs to be scanned a valid firmware must be burned into the OTP or QSPI flash that sends BLE advertisements after power up. Additionally, the BD address should be burned into the OTP or the QSPI by the PLT. The PLT expects to find devices in the air with the BD addresses programmed by the same tool, so it can match the BD addresses returned by the GU.

SmartBond Production Line Tool

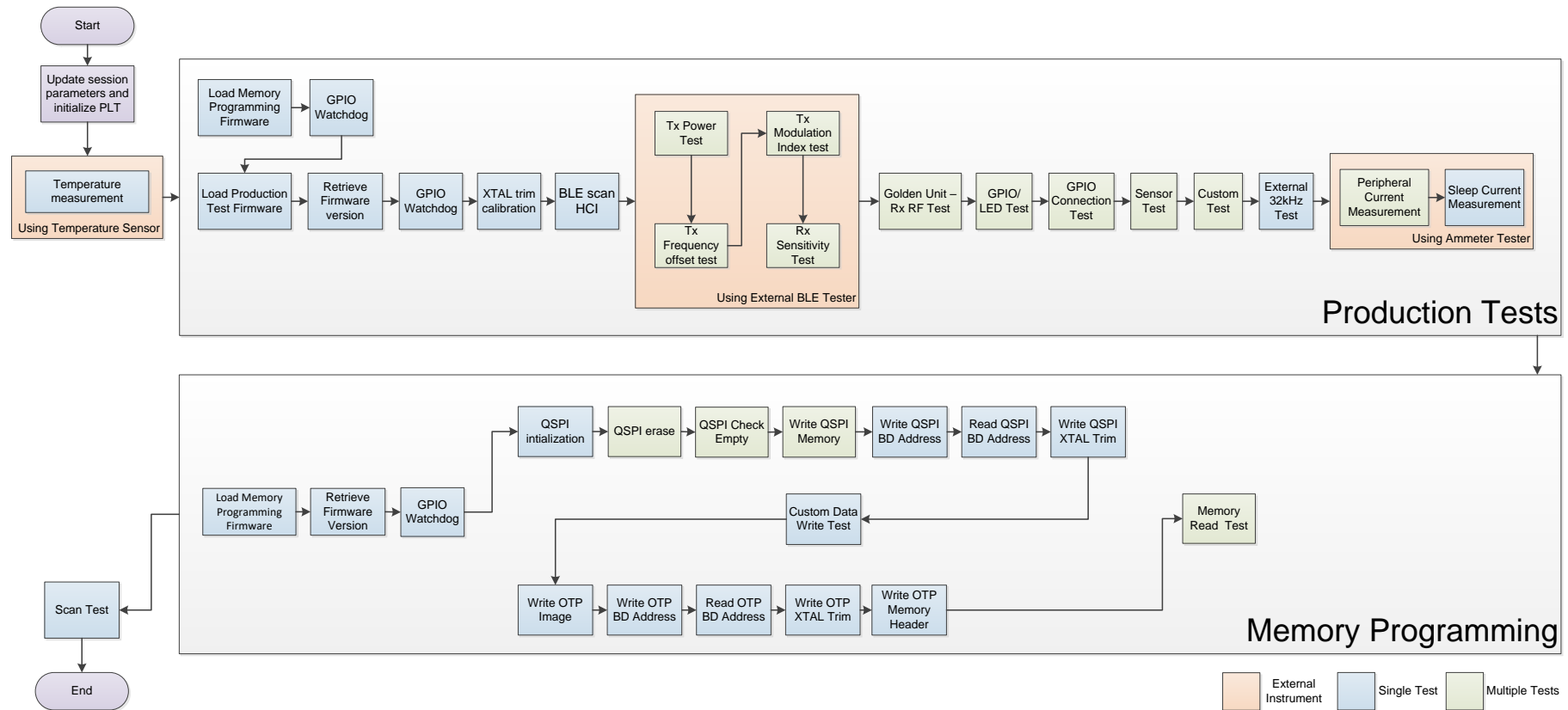

Figure 24: DA1469x Test Sequence

6.9 VBAT/Reset Signals Operation

The following chapter describes the PLT hardware VBAT and Reset signal operation during the DUT [Test Sequence](#).

There are two different modes available to power and reset the DUTs using a combination of the PLT VBAT and Reset lines. These are described next.

6.9.1 VBAT Only

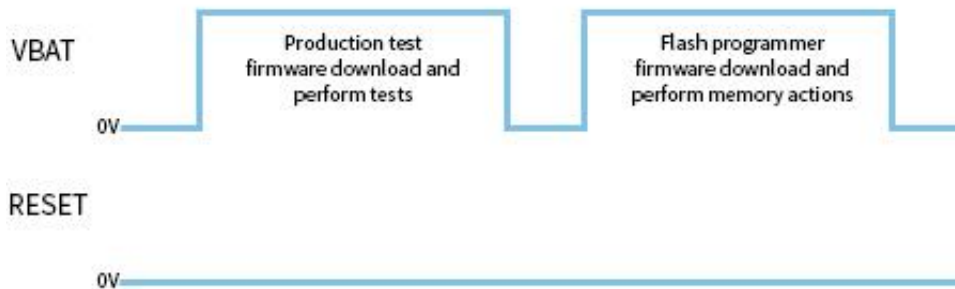

Figure 25: VBAT only

In this mode only the VBAT line is used, as shown in [Figure 25](#). Only the VBAT signal from the PLT hardware board to the DUT should be connected. The Reset signal is not driven. The DUTs are powered independently from their VBAT lines connected to the PLT HW and when reset is needed, the PLT software toggles the VBAT line low to perform a POR to each device.

Battery powered DUTs or DUTs with an external power supply are not supported in this mode. PLT to DUT VBAT line connection is mandatory. PLT Reset line connection is not required.

6.9.1.1 Firmware download

When the firmware download procedure begins, the PLT VBAT line will power the DUTs and the UART connections will open. This will result to a POR for all active devices. The POR will activate the DUTs UART booting procedure and the PLT software will be able to download the test firmware.

If there are devices that failed the test firmware download procedure, PLT will perform a VBAT POR to retry the firmware download procedure only for those that failed. During the extra attempts to download firmware to the failed devices, the VBAT lines of the devices that succeeded will remain active. After maximum of three retry attempts, the PLT VBAT lines will remain active only for the devices that have succeeded. The retry operation and the amount of retries can be configured by the user. Check [7.2.3.2](#) for more details.

When the production testing has finished the above procedure will be repeated for the memory programming, as a different firmware needs to be downloaded to the DUTs.

6.9.1.2 Current measurement

Since the DUTs will be powered through the PLT HW using the VBAT line, the [Current Measurement Test](#) for DA14531 and the

[Current Measurement Test](#) for the DA1469x are supported as described in the [Current Measurements](#) chapter.

SmartBond Production Line Tool

6.9.2 VBAT On with Reset

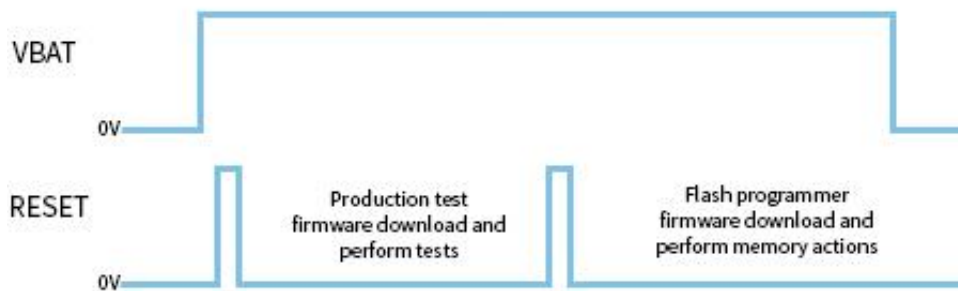

Figure 26: VBAT On with Reset

In this mode the reset of the DUTs will be performed by the PLT Reset line as shown in Figure 26. During this mode, the PLT VBAT line continuously provides power to the DUTs and the DUTs are reset using the PLT Reset line.

Power supply can be provided to the DUTs if the PLT VBAT line is connected to the DUTs. However, for battery powered DUTs or for DUTs with an external power supply VBAT should not be connected. For such devices, only the connection to the PLT Reset line is mandatory.

6.9.2.1 Firmware download

When the firmware download procedure begins, PLT will reset the DUTs using the PLT Reset line. The VBAT line is already active and remains active for the entire PLT test and memory programming procedure. If there are devices that failed to download firmware, the PLT will reset all the DUTs again and retry to download firmware to all of them even if these have succeeded. This is different approach from the VBAT Only procedure, since the Reset line is a single hardware line that cannot be differently controlled for each DUT, as opposed to the VBAT lines. The retry operation and the amount of retries can be configured by the user. Check 7.2.3.2 for more details.

When the production testing has finished, the above procedure will be repeated for the memory programming, as a different firmware needs to be downloaded to the DUTs.

6.9.2.2 Current measurement

If the DUTs are powered through the PLT HW using the VBAT line, or if they are powered using a single common line from an external power supply, the Current Measurement Test for DA14531 and the

Current Measurement Test for the DA1469x are supported as described in the Current Measurements chapter. If the DUTs are powered independently or have their own power supply (e.g. battery) then the current measurement tests are not supported.

6.10 Custom Memory Data

The following chapter describes the PLT 'Custom Memory Data' configuration and programming procedure.

The PLT supports programming custom user data of any size up to 256 bytes, to any memory and from any start address. Custom data can be entered to the PLT by the three input methods described in Table 16.

Table 16: Custom Memory Data Input Modes

Input Modes	Description
Barcode scanner	Prior to starting the PLT tests, before pressing the START button in the PLT GUI, users can use a barcode scanner to enter custom memory data; different for each DUT. A new GUI screen is used to scan DUT barcodes and save the barcode scanned data to the PLT. The PLT will then burn these data to the user specified memory and address.

SmartBond Production Line Tool

Input Modes	Description
	Duplicate scan data protection can be enabled to protect scanning same data for different DUTs in the same test.
CSV file	Users can provide a path to a CSV file that will contain the custom memory data for each DUT. The format of the CSV file is specific and is provided in Custom data CSV file format .
Manual	Users can manually edit the custom memory data prior of each PLT test run. The edit can be done in the PLT GUI or in the params.xml file using an external application or script. If different data per DUT is required, then the update of the custom memory data should be done before every PLT test run.

Chapter [Custom Memory Data](#) explains in detail the various configuration parameters of the ‘Custom Memory Data’ programming PLT feature.

6.10.1 Homekit Hash Setup Code

The PLT supports the hashing and programming of homekit setup codes. This feature is only supported for DA1469x DUTs and can be enabled in the [Custom Memory Data](#) test using the `Homekit binary generator` option. For this to work users should input to the PLT a specific format of the setup code and device serial number. The format should be as described in [Table 17](#).

Table 17: Homekit Setup Code Format

Homekit Setup Code format	Description		
XXXXXXXXYYYYAAZZZZZZZZZZC	Part	Length	Description
	XXXXXXXX	8 digits	Homekit setup code without the dashes.
	YYYY	4 characters	Setup ID
	AA	1 byte	Accessory category
	ZZZZZZZZZZZZ	12 characters	Serial number
	C	1 character	Checksum of the previous characters
<p>Example: Consider a device with setup code 50867478, setup id 70SX, accessory category 03 and serial number 112233445566. The input to the PLT should be given as 5086747870SX03112233445566R. The final character ‘R’ is the checksum of the previous characters. The algorithm of the checksum is given in Table 18.</p>			

The homekit setup code characters can be taken from either input mode described in [Table 16](#). The PLT will read the data and will apply it as input argument to the `SetupCode_Generator_680.exe` application found under the `binaries` folder. The `SetupCode_Generator_680.exe` application will create, in the same `binaries` folder, a binary image with the name `XXXXXXXXYYYYAAZZZZZZZZZZZ.bin`. The PLT will burn this file to the DUT memory and start address that the user has configured.

SmartBond Production Line Tool
Table 18: Homekit Setup Code Checksum Algorithm**Homekit Setup Code Checksum Algorithm**

```

const char checkCharList[] = "0123456789ABCDEFGHIJKLMNOPQRSTUVWXYZ";
/**
 *
 * @brief Homekit specific setup code and serial number checksum check function.
 * This checksum algorithm is similar to EAN, ILN and NVE but with alphanumeric instead of numbers
 *
 * @param[in] *inString          The string to check its checksum.
 * @param[in] *inLength         The length of the string.
 *
 * @return The checksum character.
 *
 */
char hmkt_setupcode_chksm(const char *inString, int inLength)
{
    char check = 0;
    int index = 0;
    unsigned int sum = 0;
    const char *characters = inString;

    for (index=0; index<inLength && characters[index]!=0; index++) {
        if ((index % 2) == 0)
            sum += characters[index];
        else sum += characters[index] * 3;
    }

    sum = sum % 36;

    if (sum != 0)
        sum = 36 - sum;

    check = checkCharList[sum];

    return check;
}

```

6.10.2 Custom data CSV file format

This section describes the format of the CSV file used in *CSV file input mode* of the [Custom Memory Data](#) test.

	A	B	C	D	E	F	G	H	I	J	K	L	M
1	80:EA:CA:80:00:01	OTP	0	5	5566778801	SPI	8000	10	112233445566778899A1				
2	80:EA:CA:80:00:02	OTP	0	5	5566778802	SPI	8000	10	112233445566778899A2				
3	80:EA:CA:80:00:03	OTP	0	5	5566778803	SPI	8000	10	112233445566778899A3				
4	80:EA:CA:80:00:04	OTP	0	5	5566778804	SPI	8000	10	112233445566778899A4				
5	80:EA:CA:80:00:05	OTP	0	5	5566778805	SPI	8000	10	112233445566778899A5	SPI	2	9000	5501
6	80:EA:CA:80:00:06	OTP	0	5	5566778806	SPI	8000	10	112233445566778899A6	SPI	2	9000	5502
7	80:EA:CA:80:00:07	OTP	0	5	5566778807	SPI	8000	10	112233445566778899A7				
8	80:EA:CA:80:00:08	OTP	0	5	5566778808	SPI	8000	10	112233445566778899A8				
9	80:EA:CA:80:00:09	OTP	0	5	5566778809	SPI	8000	10	112233445566778899A9				
10	80:EA:CA:80:00:0A	OTP	0	5	556677880A	SPI	8000	10	112233445566778899AA				
11	80:EA:CA:80:00:0B	OTP	0	5	556677880B	SPI	8000	10	112233445566778899AB				
12	80:EA:CA:80:00:0C	OTP	0	5	556677880C	SPI	8000	10	112233445566778899AC				
13	80:EA:CA:80:00:0D	OTP	0	5	556677880D	SPI	8000	10	112233445566778899AD				
14	80:EA:CA:80:00:0E	OTP	0	5	556677880E	SPI	8000	10	112233445566778899AE				
15	80:EA:CA:80:00:0F	OTP	0	5	556677880F	SPI	8000	10	112233445566778899AF				

Figure 27: Custom Memory Data CSV File Example

Each line in the CSV file corresponds to a specific DUT, which is bound to a BD address. The BD address is written in the first column of the CSV file. After the DUT BD address, up to five memory operations can exist.

Each of these operations must have the following columns in the correct order as described below:

- Memory type (DA14531 can have OTP, SPI, EEPROM and DA1469x can have OTP and QSPI),
- Start address
- Size of data in bytes
- Data to be written.

Figure 27 shows an example of a CSV file targeted for DA14531 DUTs. In this particular example the CSV file contains information for DUTs with BD addresses 80:EA:CA:80:00:01 to 80:EA:CA:80:00:13. For BD addresses 80:EA:CA:80:00:05–06 there are three tests and two for the rest.

- The first operation, which is similar for all BD addresses with only the Data field to be different, is to write in the OTP Header memory of the DA14531 DUTs five bytes, in OTP address 0x0000 (OTP image area).
- The second operation is configured to write into the SPI flash address 0x8000 10 bytes (0x112233445566778899AA1-AF).
- Finally, the third operation only applies for BD addresses 80:EA:CA:80:00:05 and 80:EA:CA:80:00:06. This will write 2 bytes of data in address 0x9000 of the SPI flash memory.

6.11 Golden Unit Scan Test

This section describes the PLT scan test procedure using the Golden Unit as scanner device.

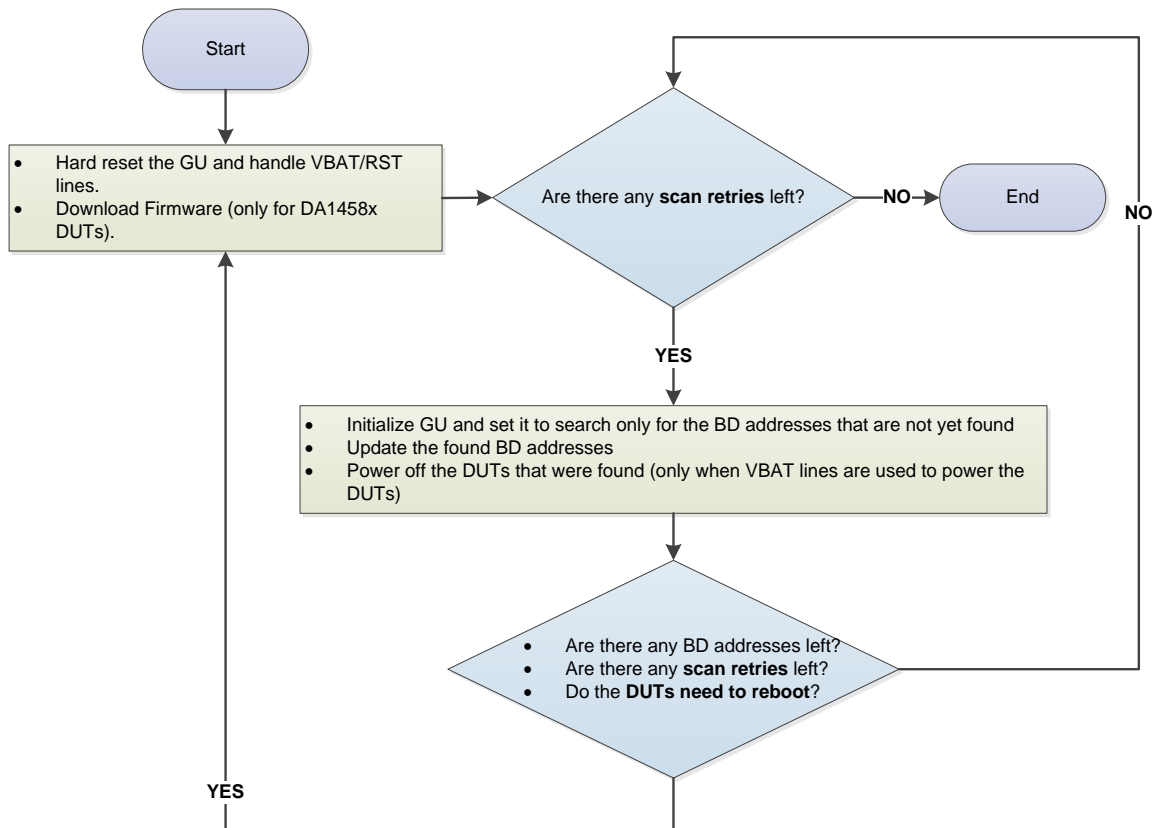

Figure 28: Golden Unit Scan Test

User can set various scan properties to adjust the Scan test procedure. The available properties that apply to the DA14531 devices are described [Table 60](#) and for the DA1469x devices in [Table 90](#).

Figure 28 shows the scan sequence. First, the Golden Unit and the DUTs are reset. At this stage, if the *Firmware load enable* is active (option is available only in DA14531 DUTs) the PLT will download the selected firmware. Then, the GU will begin scanning for the BD addresses of all active DUTs. After each scan cycle, the already found BD addresses are removed from the search list of the GU and the appropriate DUTs will be powered off. This procedure will continue until the retries have reached the *Scan retries* set by the user. The PLT will reset the GU after a specific number or retries, given in *DUT reboot* option. Finally, the parameters *DUT reboot time* and *DUT reboot difference* set the DUT time needed to perform a POR with a small delay between the DUTs if needed.

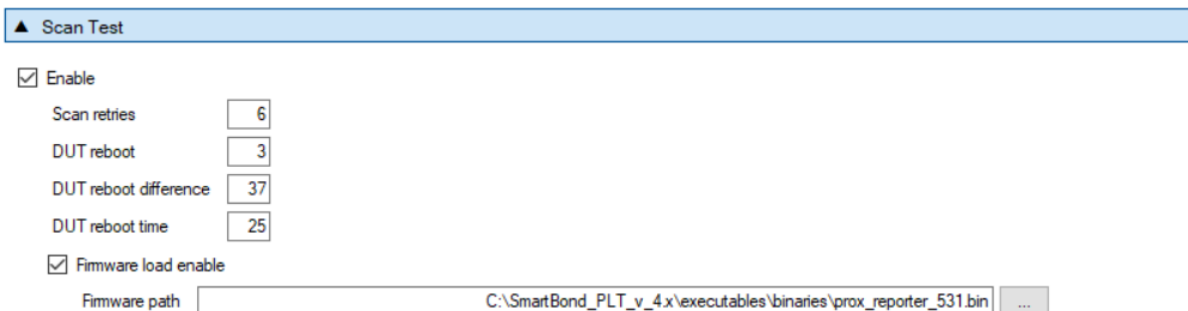

Figure 29: Golden Unit Scan Test Example Parameters

Figure 29 shows an example for DA14531 DUT connected with *VBAT only* mode as described in [VBAT/Reset Signals Operation](#). For this example, the following steps will be executed:

SmartBond Production Line Tool

- Reset the GU in order to be in a clear state, power off the DUTs and wait for 2500ms (DUT reboot time). Power on and load `prox_reporter_531.bin` firmware to each DUT with a 37ms time difference between them
- Execute three GU scan procedures. After each scan procedure is finished, power off the found DUTs
- Again, reset the GU, power off the DUTs and wait for 2500ms (DUT reboot time). Power on and load `prox_reporter_531.bin` firmware to each DUT with a 37ms time difference between them
- Continue with another three GU scan procedures and after each scan procedure power off the found DUTs

6.12 Creating PLT Firmware Files

For the PLT to successfully operate, various firmware files are used based on the device type (GU or DUT), the chipset flavor (DA14531 or DA1469x) or the purpose of the firmware (different firmware for production tests and for memory programming).

All these firmware files are kept under the `binaries` folder in the PLT software package, as shown in [Figure 30](#). In order to create these firmware files, the SDK packages should be downloaded from the customer portal and apply the source code patches located under the `fw_files` folder in the PLT software package as shown in [Figure 31](#).

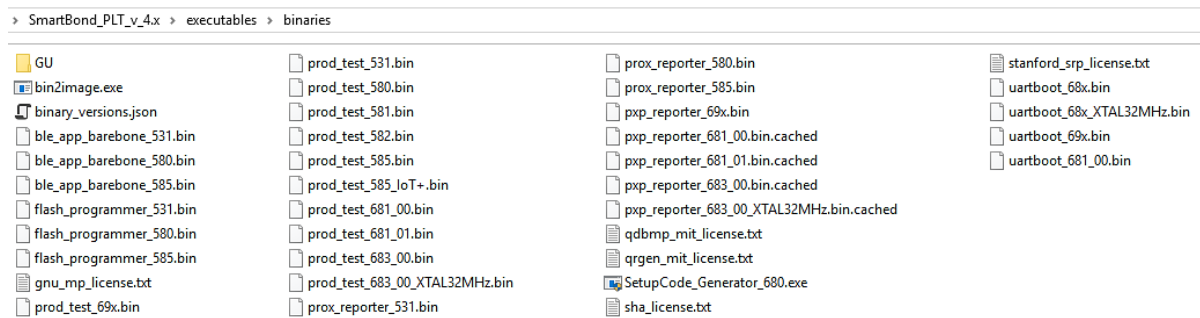

Figure 30: Binaries

The source code patches maintain the folder structure of the SDK they are targeting, in order to apply the source code patch using a simple copy and replace to the files needed. After patching, the projects contain all the necessary changes and the same firmware files can be built as those in the `binaries` folder of the PLT software package.

The '`fw_files`' folder has two main categories. Firmware targeted for the GU and for the DUTs. Under each category there is a folder indicating the IC target and the SDK used.

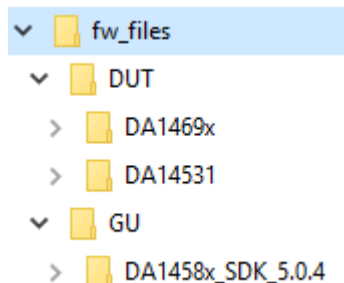

Figure 31: Folder Contents of 'fw_files'

Applying a source code patch for each one of the binaries is described below.

6.12.1 Golden Unit Firmware

The Golden Unit is a DA14580 device. A modified version of the `prod_test_580.bin` firmware is used.

SmartBond Production Line Tool

This patch contains all the changes needed to re-create the following firmware.

- prod_test_GU.bin

To re-create the exact source code of the prod_test_GU.bin firmware:

1. Use a clean copy of the DA1458x_SDK_5.0.4 SDK from the customer portal.
2. Copy the contents of the ‘...\fw_files\GU\DA1458x_SDK_5.0.4\DA1458x_SDK\5.0.4\’ folder to the default SDK.
3. The Keil v5 project file of the prod_test_GU.bin is the ‘prod_test.uvprojx’ under the folder ‘\5.0.4\projects\target_apps\prod_test\prod_test\Keil_5\’.

6.12.2 DA14531 Firmware

This patch contains all the changes needed to re-create the following firmware:

- prod_test_531.bin
- flash_programmer_531.bin
- prox_reporter_531.bin
- ble_app_barebone_531.bin

To re-create the exact source code of the above firmware:

1. Use a clean copy of the SDK_6.0.14.1114 from the Dialog Semiconductor customer portal.
2. Copy the contents of the ‘fw_files\DUT\DA14531\6.0.14.1114’ folder to the SDK SDK_6.0.14.1114\DA145xx_SDK\6.0.14.1114 folder.
3. The Keil v5 project file of the prod_test_531.bin is the ‘prod_test.uvprojx’ under ‘SDK_6.0.14.1114\DA145xx_SDK\6.0.14.1114\projects\target_apps\prod_test\prod_test\Keil_5’ folder.
4. The Keil v5 project file of the flash_programmer_531.bin is the ‘programmer.uvprojx’ under the ‘SDK_6.0.14.1114\DA145xx_SDK\6.0.14.1114\utilities\flash_programmer’ folder. Make sure that ‘programmer_uart’ option is selected under “Select Target”.
5. The Keil v5 project file of the prox_reporter_531.bin is the ‘prox_reporter.uvprojx’ under the ‘SDK_6.0.14.1114\DA145xx_SDK\6.0.14.1114\projects\target_apps\ble_examples\prox_reporter\Keil_5’ folder.
6. The Keil v5 project file of the ble_app_barebone_531.bin is the ‘ble_app_barebone.uvprojx’ under the ‘SDK_6.0.14.1114\DA145xx_SDK\6.0.14.1114\projects\target_apps\ble_examples\ble_app_barebone\Keil_5’ folder.

6.12.3 DA14681/2/3 Firmware

This patch contains all the changes needed to re-create the following firmware:

- prod_test_69x.bin
- uartboot_69x.bin
- pxp_reporter_69x.bin

To re-create the exact source code of the above firmware:

1. Use a clean copy of the SDK_10.0.8.105 from the customer portal.
2. Copy the contents from ‘fw_files\DUT\DA1469x\SDK_10.0.8.105’ folder to the default SDK.

SmartBond Production Line Tool

3. The Smart Snippets Studio project file of the `prod_test_69x.bin` is the 'plt_fw' project under 'SDK_10.0.8.105\projects\dk_apps\reference_designs\plt_fw' folder. To create each binary, select from the drop-down menu the "Release RAM" option for each chip.
4. The Smart Snippets Studio project file of the `uartboot_69x.bin` is the 'uartboot' under the folder 'SDK_10.0.8.105\sdk\bsp\system\loaders\uartboot'. To create the binary, select from the drop-down menu the "Release" option.
5. The Smart Snippets Studio project file of the `pxp_reporter_69x.bin` is the 'pxp_reporter' under the folder 'SDK_10.0.8.105\projects\dk_apps\demos\pxp_reporter'. To create each binary, select from the drop-down menu the 'QSPI_Release' option for each chip.

Each binary will be created under the project folder in a folder having the same name as the selected option.

SmartBond Production Line Tool

7 Applications

7.1 Introduction

The PLT software includes four different applications (Table 5). The CFG PLT is used to setup the system according to the device hardware options and select the required tests and memory actions to be performed. The GU Upgrade is used to update the Golden Unit firmware. The GUI and the CLI PLT applications are used to perform the tests, monitor their progress in real-time and view the test results.

7.2 CFG PLT Application

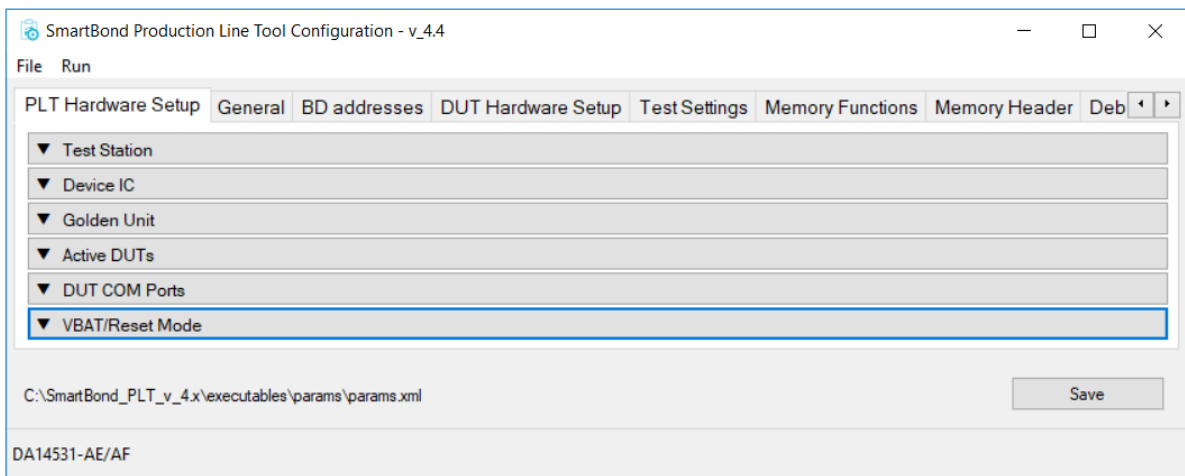

Note 1 Each field can be minimized by clicking on it, but it will not be disabled. The tests will run if they are enabled, even when the test field is minimized and not shown.

Figure 32: CFG PLT Startup Screen

The CFG PLT application (`SmartBond_CFG_PLT.exe`) is a GUI application tool, which is mainly used to appropriately configure the tests and memory operations the tool will perform. Depending on the selected device chipset and the enabled actions, only appropriate options are enabled and shown. Any change made by the user is validated before being saved to the XML file, with the use of a schema XSD file. This prevents erroneous values to be stored in the XML file that would harm the production procedure.

Figure 32 shows the initial CFG PLT screen. The Main Menu options are described in Table 19 and the bottom strip information is described in Table 20. The application begins with the Hardware Setup tab (see section 7.2.2). Users can navigate to the other PLT configurable options by selecting the different tabs.

When a tab is selected, the settings of this tab are reloaded from the XML file. If there is an error in the configuration XML file, a warning message will be shown indicating which of the parameters has error. Additionally, the related graphic entry in the CFG application for the erroneous configuration parameter will be highlighted in red.

An example is given in Figure 33. Configuration parameter `dut_num_1` has wrong value (error instead of either `false` or `true`) in the `params.xml` file. When the Hardware Setup CFG tab is selected the warning message will be displayed. If OK is pressed, the Hardware Setup tab will be loaded with the DUT 1 checkbox in red. The displayed value will be the default value taken from the XML schema document (`params.xsd`).

SmartBond Production Line Tool

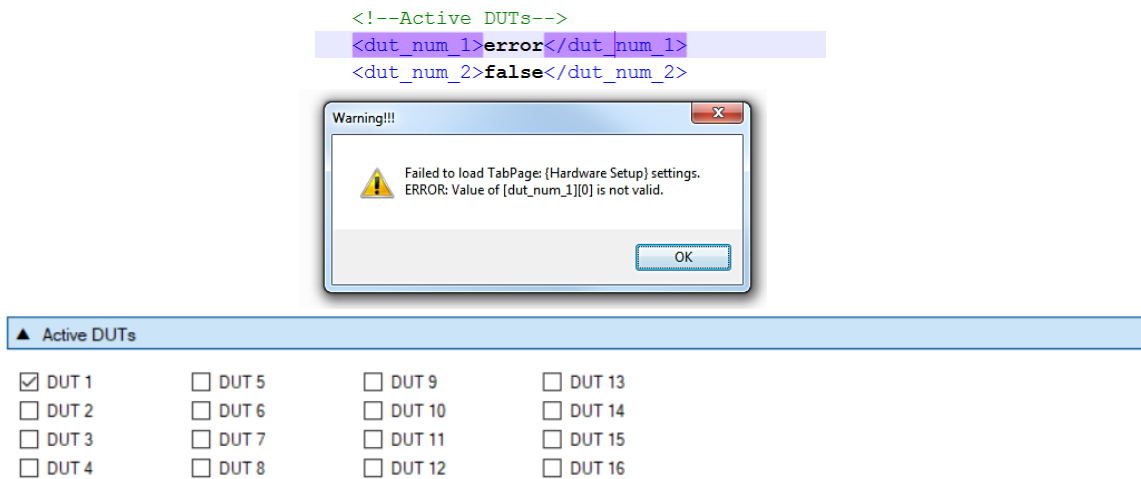

Figure 33: CFG PLT with Erroneous Configuration Parameter

When the user makes a change, the *Save* button will become *Save** to indicate that a save is required.

In case of a configuration parameter error, pressing *Save* will save the default parameter value, overwriting the erroneous value.

Table 19: CFG PLT Main Menu Options

Region	Option	Description
File	Open XML file	Opens a new XML file and loads the settings. The full path of the new XML file is shown at the bottom end of the screen.
	View XML file	Opens the XML file in notepad.
	Save as...	Exports all settings to a new XML file. The full path of the new XML file is shown at the bottom end of the screen.
	Reset to defaults	Overwrites all parameters options in the XML file with their default values taken from the XSD file.
	Exit	Exits the CFG PLT application.
Run	Run GUI PLT	Opens the GUI PLT application.
	Run CLI PLT	Opens the CLI PLT application.

Table 20: CFG PLT Bottom Strip Options

Option	Description
C:\SmartBond_PLT_v_4.x\executables\params\params.xml	Shows the full path of the XML file currently used.
DA14531-AE/AF	Shows the selected device IC.
Save	Saves the options of the selected tab. E.g. If General settings tab is selected, then only the settings for this tab will be saved. Note: A shortcut for this button is the Ctrl+S key combination.

SmartBond Production Line Tool

7.2.1 XML and XSD Files

The CFG PLT application is a front-end user interface for the `cfg_dll.dll` library (Figure 21). The `cfg_dll.dll` library, explained in detail in [1], is an XML parser, editor and parameter validator. It has an easy-to-use API for reading and manipulating the `params.xml` file. File `params.xsd` is the XML schema used for parameter validation.

In the CFG PLT application, all user selectable options are loaded and saved inside the XML file, by effectively using the `cfg_dll.dll` library API. The XSD schema file `params.xsd` is not edited in any way but only read by the `cfg_dll.dll` library API, whenever a parameter validation is needed.

The `params.xml` file is separated into three main parts as explained in Table 21.

Table 21: XML File Parts

Part Name	Example	Description
Common part	<pre><programming_enable>true</programming_enable> <tests_enable>true</tests_enable> <retest_failed>false</retest_failed> <!-- --> <!-- BD Addresses --> <!-- --> <bd_addr_mode>0</bd_addr_mode> <bd_addr_file_path>params\bd_address.ini</bd_addr_file_path> <start_bd_addr>00:00:00:00:01</start_bd_addr> <next_bd_addr>00:00:00:00:01</next_bd_addr> <end_bd_addr>00:00:00:00:01</end_bd_addr> <scanner_iface>COM21</scanner_iface> <scan_mode_auto>1</scan_mode_auto></pre>	The main top part of the XML file contains parameters common to any DUT, like the BD address mode, the COM ports and which device is enabled or disabled. It also holds the debug parameters, the test statistics and the test station name used in the logs.
DA14531	<pre><!-- DA1458x --> <config_params_da1458x> <!-- --> <!-- UART --> <!-- --> <uart_boot_pins>4</uart_boot_pins> <uart_change_pins>false</uart_change_pins> <uart_pin_tx>P0_4</uart_pin_tx> <uart_pin_rx>P0_5</uart_pin_rx> <uart_baud_rate>1000000</uart_baud_rate></pre>	The second XML part, with the element name <code>config_params_da1458x</code> , holds parameters used for DA14531 devices. Under this part, the entire test and memory action settings are stored.
DA1469x	<pre><!-- DA1468x --> <config_params_da1468x> <!-- --> <!-- UART --> <!-- --> <uart_boot_pins>4</uart_boot_pins> <uart_baud_rate>1000000</uart_baud_rate> <!-- --></pre>	The third and final XML part, with the element name <code>config_params_da1468x</code> , holds parameters used for DA1469x devices. Under this part, the entire test and memory action settings are stored.

The XSD schema file, `params.xsd`, holds information about the overall structure of the `params.xml` file, the default and valid values a parameter can take and useful help information about the purpose of each parameter. An example part of the XSD file is given in Figure 34.

SmartBond Production Line Tool

```

<xs:element name="next_bd_addr"
  type="x:cfg_hex_array_6_bytes"
  x:use="required"
  x:default="00:00:00:00:00:01"
  x:info="The BD address of the first active DUT that will be used in the next test run. "/>
<!--cfg_hex_array_6_bytes-->
<xs:simpleType name="cfg_hex_array_6_bytes">
  <xs:restriction base="xs:string">
    <xs:pattern value="([0-9A-Fa-f][0-9A-Fa-f][0-9A-Fa-f])(:([0-9A-Fa-f][0-9A-Fa-f][0-9A-Fa-f])){5}"/>
  </xs:restriction>
</xs:simpleType>

<xs:element name="RF_path_loss_DUT_1"
  type="x:cfg_dut_path_losses"
  x:use="required"
  x:default="0"
  x:info="Set the RF path losses in dB between the device and the GU or the BLE tester instrument."/>
<!--cfg_dut_path_losses-->
<xs:simpleType name="cfg_dut_path_losses">
  <xs:restriction base="xs:float">
    <xs:minInclusive value="0"/>
    <xs:maxInclusive value="40"/>
  </xs:restriction>
</xs:simpleType>

```

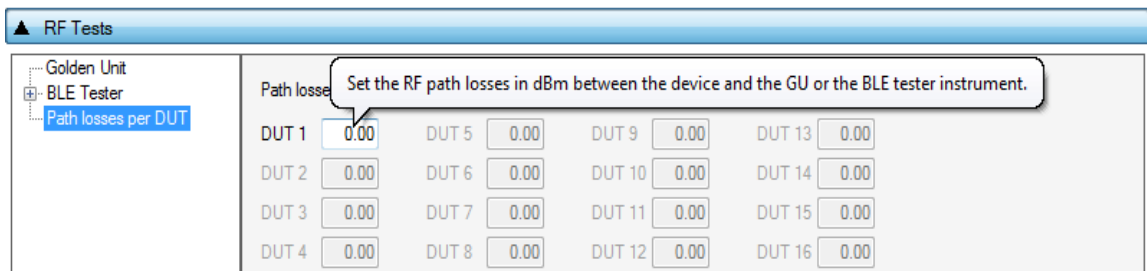

Figure 34: XSD Schema File Example

Element `next_bd_addr` holds the Next BD address, as described in section 7.2.4.1 and Table 30. It has a default value of `x:default="00:00:00:00:00:01"`. This default value will be returned by the `cfg_dll.dll` API if the XML file has an error entry in the equivalent `next_bd_addr` element, since the validation of the parameter will fail.

The `x:info="The BD address ..."` value will be loaded by the `cfg_dll.dll` API and be used in the CFG PLT tooltips. The `type="x:cfg_hex_array_6_bytes"` defines the parameter type. This is the actual XSD entry that is used for the parameter validation. The `cfg_hex_array_6_bytes` type is defined later in the file and has a rather complicated pattern defined with `<xs:pattern value="([0-9A-Fa-f]...)" />`. If the `next_bd_addr` element in the XML file has a value that does not match this pattern, the validation of the parameter will fail and the `cfg_dll.dll` API will return the default value (00:00:00:00:01). In the CFG PLT, the default value will be shown in red, indicating that an error exists in the `params.xml` file for this parameter. It will not change the erroneous value in the `params.xml` file until the user presses the **Save** button, in which case the default value will overwrite the erroneous value.

In the second example of Figure 34, the `RF_path_loss_DUT_1` XSD element is shown. This element is used in the `Path Losses per DUT` as shown in Figure 62. This element has a default value of 0 and the allowed values are floats, between `<xs:minInclusive value="0"/>` and `<xs:maxInclusive value="40"/>`, as shown in the `cfg_dut_path_losses` type description. The `x:info="Set the RF path .." />` will be loaded by the `cfg_dll.dll` API and used in the CFG PLT tooltips as shown in the bottom part of Figure 34.

SmartBond Production Line Tool

7.2.2 Hardware Setup

This section describes the Hardware Setup settings available for the PLT hardware board, as shown in [Figure 32](#).

7.2.2.1 Test Station

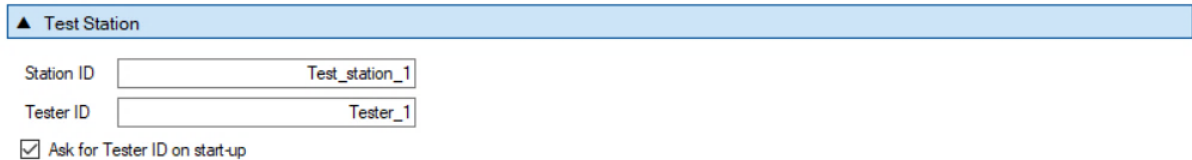

Figure 35: Station Identification

These fields hold the station ID and tester ID names to distinguish between different test stations and users. The values of these fields are written into the DUT logs and CSV files. [Table 22](#) describes the available options for the *Station Identification*.

Table 22: Station Identification

Option	Description
Station ID	The name of the PLT test station.
Tester ID	The PLT tester ID name.
Ask for Tester ID on start-up	When SmartBond_PLT_GUI.exe starts it will ask for the tester ID name.

7.2.2.2 Device IC

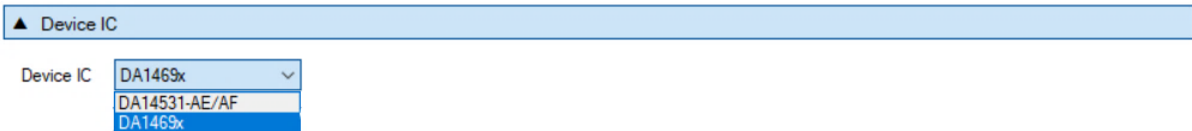

Figure 36: Device IC

Users can select the device IC type. This option will also change any IC related graphics, such as selectable tabs and tests. [Table 23](#) describes the available options for the *Device IC*.

Table 23: Device IC

Option	Description
Device IC	The Dialog BLE chipset used in the device under test.

7.2.2.3 Active DUTs



Figure 37: Active DUTs

Enables or disables the testing for each DUT. [Table 24](#) describes the available options for the *Active DUT*.

SmartBond Production Line Tool

Table 24: Active DUTs

Option	Description
DUT1-16	Enables the specific DUT device placed on connector DUT1-DUT16.

7.2.2.4 DUT COM Ports

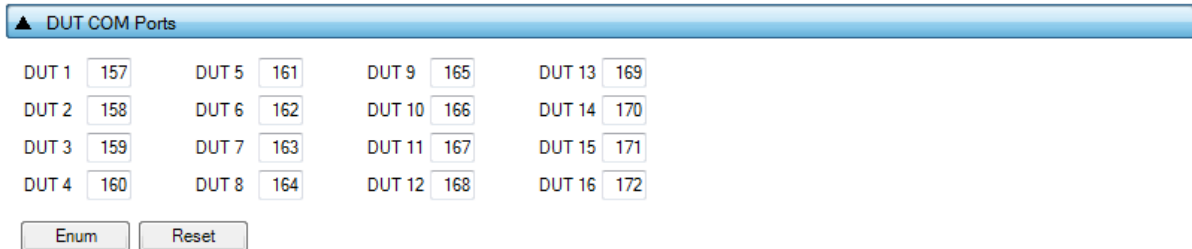

Figure 38: DUT COM Ports

This field shows the Windows COM port assigned to each DUT. The table is filled only when the 'COM Enum' action has been performed by the CFG or the GUI PLT applications, or when non-zero entries exist in the `com_port_x` params.xml options. When the 'COM Enum' action is performed, the tools will automatically find the DUT COM ports and save them in the `params.xml` file. These values will be read by the CFG PLT application and be displayed here. When a 'COM Enum' action has not been performed, the GUI PLT will automatically run it once in every first test execution.

Note: Great care must be taken when the `params.xml` file is shared across different stations, where different DUT COM Ports will probably exist. The 'COM Enum' action should then be performed again, so the new COM ports of the new PC system are identified and updated in the XML file.

Table 25 describes the available options for the *DUT COM Ports*.

Table 25: DUT COM Ports

Option	Description
DUT1-16	Shows the Windows COM port assigned to a specific DUT.
Reset	Sets all values to zero.
Enum	Executes the COM port enumeration procedure. The found COM ports are shown before being saved.

7.2.2.5 Golden Unit

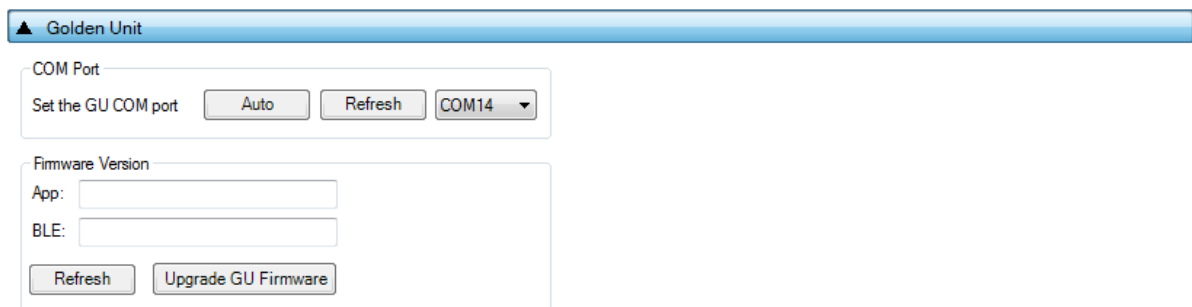

Figure 39: Golden Unit COM Port

This field holds the Golden Unit COM port. Manual or automatic COM port find can be selected.

The Golden Unit COM port can be manually selected from the list with all the available COM ports existing in the system. Additionally, it can automatically be found by pressing the `Auto` button. The

SmartBond Production Line Tool

automatic procedure searches the serial number of all system COM ports to find the “DialogSemi” string. Details on how to program the serial number in the GU FTDI can be found in [Appendix I](#).

Table 26: Set the GU COM Port

Option	Description
Auto	Initiates the automatic Golden Unit COM port find procedure.
Refresh	Refreshes the dropdown menu with all the available system COM ports.
Dropdown Menu	Manually select the Golden Unit COM port from all the available system COM ports.

Table 27: Golden Unit Firmware Version Upgrade

Option	Description
Refresh	Retrieves the current BLE and application versions of the connected Golden Unit.
Upgrade GU Firmware	Opens the GU Upgrade application, which is used to update the GU firmware.

7.2.2.6 VBAT/Reset Mode

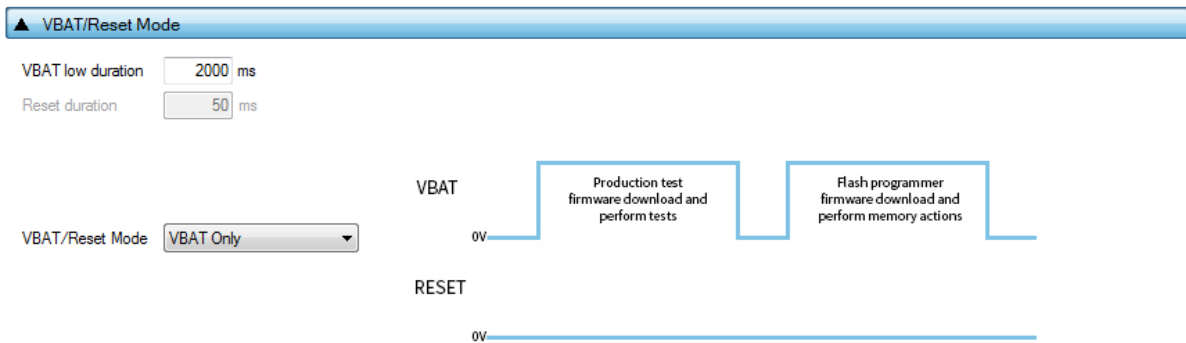

Figure 40: VBAT/Reset Mode Selection

This field holds the VBAT/Reset mode selections. This option sets the PLT VBAT and PLT Reset line modes for the DUT power supply and reset during the PLT test sequence. [Table 28](#) describes the available selections.

Table 28: VBAT/Reset Mode

Option	Description
VBAT/Reset Mode	Select the operation for VBAT/Reset signals. Available options are: <ul style="list-style-type: none"> • VBAT Only • VBAT On with Reset VBAT/Reset Signals Operation chapter describes each mode in detail. Default setting is <i>VBAT only</i> .

SmartBond Production Line Tool

7.2.3 General

7.2.3.1 Statistics

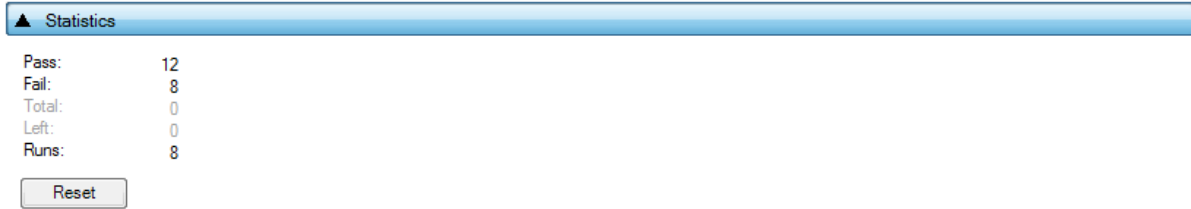

Figure 41: Statistics

This field holds the test result statistics. Table 29 describes the *Statistics* field.

Table 29: Statistics

Option	Description
Pass	Shows the number of DUTs that have successfully passed all the tests.
Fail	Shows the number of DUTs that have failed the tests.
Total	Shows the number of DUTs that will be tested. This option is available only when <i>Range</i> mode is enabled in the BD Address Assignment .
Left	Shows how many DUTs are still to be tested. This option is available only when <i>Range</i> mode is enabled in the BD Address Assignment .
Runs	Shows the number of test runs the PLT has performed.
Reset	Pressing the <code>Reset</code> button clears all statistics values to their defaults. Values <i>Pass</i> , <i>Fail</i> and <i>Runs</i> will be set to zero. If <i>Range</i> mode is enabled in the BD Address Assignment , the <i>Total</i> and <i>Left</i> values will be set as the difference of <i>Next</i> and <i>End BD address</i> , otherwise will be set to zero.

7.2.3.2 Test Options

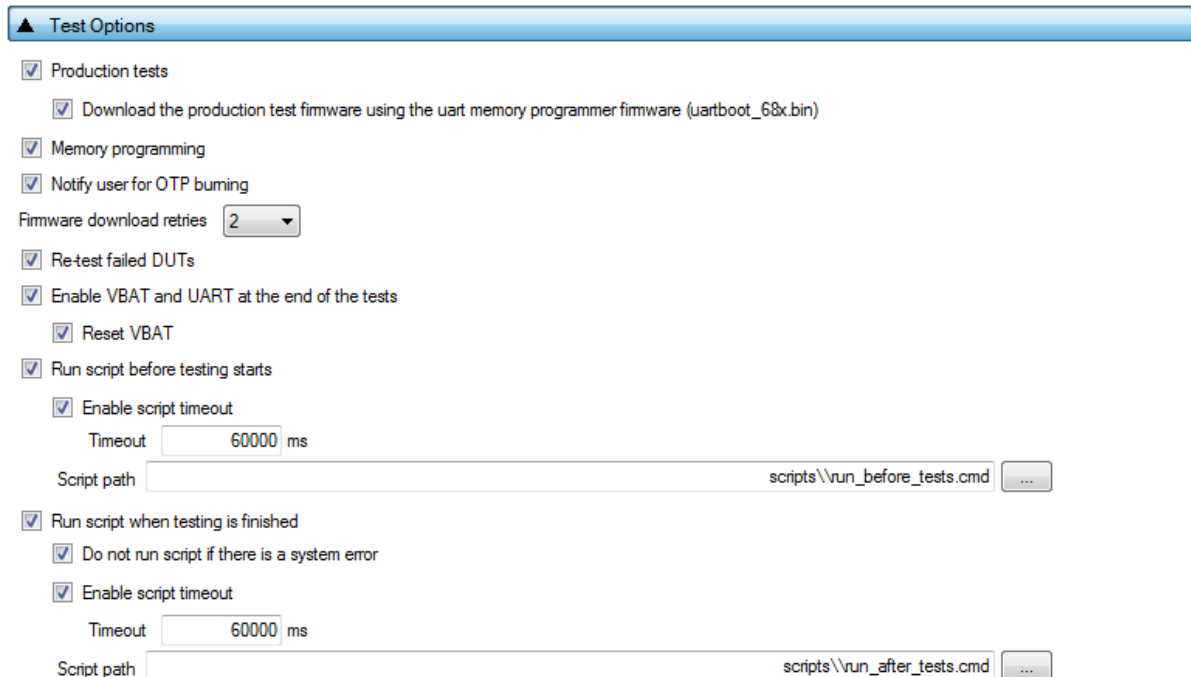

Figure 42: Test Options

SmartBond Production Line Tool

This field holds generic PLT test procedure options. The PLT procedure is split into two main parts: *Production tests* and *Memory programming*.

Production tests include all the tests under [Test Settings \(DA14531\)](#) or [Test Settings \(DA1469x\)](#).
Memory Programming includes all the tests under [Memory Functions \(DA14531\)](#) or [Memory Functions \(DA1469x\)](#) and

SmartBond Production Line Tool

Memory Header (DA14531) or

Memory Header (DA1469x) describes the available settings for the *Test Options*.

Option	Description
Production tests	This option enables the production test operations.
Memory programming	This option enables the memory programming operations.
Notify user for OTP burning	When this option is enabled, PLT informs the user with all the OTP burning tests that are enabled. A pop-up message appears, prompting the user whether or not to proceed with the tests.
Firmware download retries	Configures the firmware download retries in case of an error during firmware download.
Re-test failed DUTs	When this option is enabled, any DUT that failed will immediately be retested with the exact same options, including the <i>BD address</i> . This option is the same to the <i>Retest failed DUTs - Enable</i> under GUI PLT Settings .
Enable VBAT and UART at the end of the tests	Enables the VBAT lines and UART communication between the PC and the devices after all the tests have finished. If enabled, DUTs will remain powered after the end of the tests.
Reset VBAT	If this option is enabled the VBAT line will be toggled. If not selected, the DUTs will keep in their system RAM the last test firmware downloaded by the PLT.
Run script before testing starts	This option enables the execution of a batch or an executable before the device testing procedure starts. As described in Running the GUI PLT and Executing Tests , the success return code should be a value between 0 and 100 for the tool not to report an error. Any other value will be taken as error and prevent the tool from running the tests.
Enable script timeout	Enables a wait timeout for the script to finish. The time to wait is set in the <i>timeout</i> field below. If this option is disabled PLT will wait until the script ends.
Timeout	The time to wait for the script to finish.
Script path	The path of file to execute when the <i>Run script before testing starts</i> option is enabled.
Run script when testing is finished	This option enables the execution of a batch or an executable after the device testing procedure has finished. The success return code should be 0 for the tool not to report an error.
Enable script timeout	Enables a wait timeout for the script to finish. The time to wait is set in the <i>timeout</i> field below. If this option is disabled, PLT will wait until the script ends.
Timeout	The time to wait for the script to finish.
Script path	The path of file to execute when the <i>Run script when testing is finished</i> option is enabled.

SmartBond Production Line Tool

7.2.4 BD Addresses

7.2.4.1 BD Address Assignment

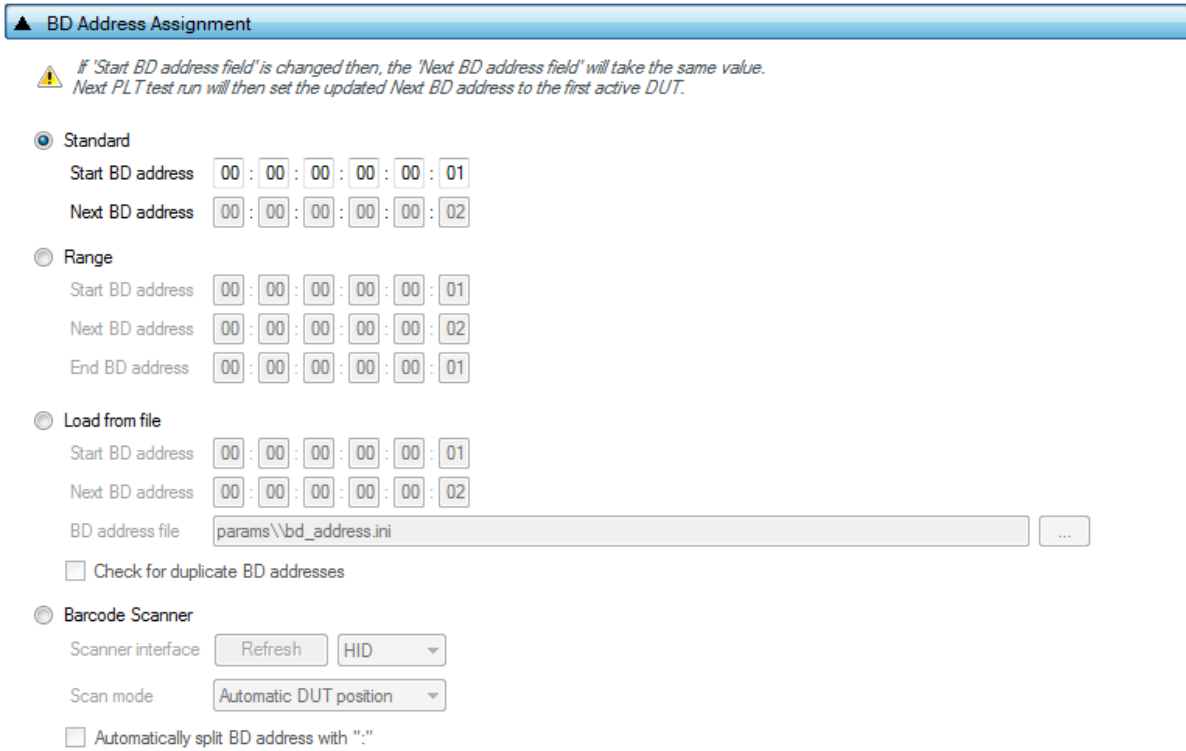

Figure 43: BD Address Assignment

The *BD Address Assignment* field defines different ways the PLT can handle the device BD address. The available modes are *Standard*, *Range*, *Load from file* and *Scan mode*.

The *Standard*, *Range*, and *Load from file* modes are similar. These have a *Start BD address*, which is the initial address that the PLT session begins. The *Next BD address* field holds the BD address that will be used on the next PLT run, so the BD address assignment can be continued even after the GUI PLT is closed. For that reason, the user cannot alter the *Next BD address*. The *Next BD address* initial value is the same as the *Start BD address* when the PLT session begins.

For *Scan mode*, an external barcode scanner is needed to assign the device BD addresses.

Note: In CFG PLT only the Start BD address is given. The assignment of the actual device BD addresses occurs in the GUI PLT at the beginning of each test run.

Note: The only invalid BD address is 00:00:00:00:00:00.

Standard Mode

Table 30 describes the available options for the *Standard* mode. In this mode, the first active DUT takes the *Next BD address*. This BD address is incremented by one and assigned to the next active DUT until all active DUTs have a BD address assigned to them.

This assignment mode never runs out of BD addresses and it will continue assigning addresses until the *Next BD address* reaches FF:FF:FF:FF:FF:FF.

SmartBond Production Line Tool

Table 30: BD Address Assignment - Standard Mode

Option	Description
Start BD address	The BD address that the PLT session has started with.
Next BD address	The BD address that will be used in the first active DUT of the next PLT run.

Range Mode

Table 31 describes the available options for the *Range* mode. This mode is the same as *Standard* mode except for the additional *End BD address*.

Since a 'Start BD address' and an 'End BD address' exist, the total amount of devices to be tested can be calculated. Therefore, this mode enables the *Total* and *Left* fields in the [Statistics](#), where *Total* is the number of the BD addresses to be used from *Start BD address* to *End BD address* and *Left* is the number of BD addresses remaining.

Note: The *End BD address* must always be greater than the *Start BD address*. In addition, when *Left* BD addresses are not enough for the remaining active DUTs, the PLT will not run.

Table 31: BD Address Assignment Options - Range Mode

Option	Description
Start BD address	The BD address that the PLT session has started with.
Next BD address	The BD address that will be used in the first active DUT of the next PLT run.
End BD address	The BD address that the PLT session will end with.

Load from File Mode

Table 32 describes the available options for the *Load from file* mode. In this mode, the *Start BD address* and the *Next BD address* have the same roles as before. The difference in this mode is that the BD addresses are loaded from a file in the order as they are written in that file, not using the automatic incremental method of the previous modes. In every test run, the PLT will search for the first occurrence of the *Next BD address* in the file and will load it along with the BD addresses that follow, until all active DUTs have a BD address.

```

1  00:00:00:44:33:0a
2  00:00:00:44:33:09
3  00:00:00:44:33:08
4  00:00:00:11:22:08
5  00:00:00:11:22:06
6  00:00:00:11:22:05
7  00:00:00:11:22:04
8  00:00:00:11:22:03
9  00:00:00:11:22:02

```

Figure 44: Example for Load from File Mode

For example, consider three active DUTs: DUT3, DUT6, and DUT 9 and the *Next BD address* to be 00:00:00:11:22:08. Figure 44 shows the beginning of the BD address file used in this example. The PLT will search for the *Next BD address* in the file and load it to the first active DUT: DUT3. It will then continue with 00:00:00:11:22:06 for DUT6 and 00:00:00:11:22:05 for DUT9. It will also return 00:00:00:11:22:04 as the *Next BD address* to be used in the next PLT test run.

Note: The BD address file should always end with a zero BD address (00:00:00:00:00:00) and a new line at the end.

SmartBond Production Line Tool

Table 32: BD Address Assignment Options - Load from File Mode

Option	Description
Start BD address	The BD address that the PLT session has started with.
Next BD address	The BD address from file that will be used in the first active DUT of the next PLT run.
BD address file	Path to the file that contains the BD addresses. Use button [...] on the right to navigate and select a file.
Check for duplicate BD addresses	Before any BD address is assignment happens, there will be a check to find double BD addresses in the selected BD address file.

Scan Mode

[Table 33](#) describes the available options for the *Scan* mode. For this option a USB-to-Serial barcode scanner should be used to scan for BD address barcodes with 'xx:xx:xx:xx:xx:xx' format.

The barcode scanner options are the same as those used for the barcode scanner mode in [Custom Memory Data](#) for the DA1458x devices and in [Custom Memory Data](#) for the DA1468x devices.

Note: Barcode scanner mode is only available with

SmartBond Production Line Tool

GUI PLT Application. CLI PLT Application does **NOT** support this feature.

SmartBond Production Line Tool

Table 33: BD Address Assignment Options - Scan Mode

Option	Description
Scanner Interface	<p>Selection of the Barcode scanner input. Both HID and COM port interfaces are supported. This dropdown list provides an HID and all the available system COM ports as input options.</p> <p>For the HID interface, any HID device is supported that includes newline (CR-LF) characters at the end of the scanned data.</p> <p>For the COM port interface, a common USB to UART barcode scanner is supported. PLT has been tested with Honeywell Xenon 1900. Appendix M describes the setup procedure.</p> <p>This option is the exact same option as for the DA14531 devices in Custom Memory Data and the DA1469x devices in Custom Memory Data.</p>
Scan mode	<ul style="list-style-type: none"> • Scan DUT position: In this mode the users must first scan the DUT position number and then the BD address. The string used for the position of each DUT is "TEST POSITION 0xx" where "xx" is the DUT position number. • Automatic DUT position: Scanned BD address will be assigned to the selected DUT. The DUT selection is automatically been made, starting from the first active DUT and selecting the next one after a successful BD address scan. Users can change the selected DUT using the controls on the GUI PLT screen shown in Figure 112. <p>This option is the exact same option as for the DA14531 devices in Custom Memory Data and the DA1469x devices in Custom Memory Data.</p>
Automatically split BD address with ':'	<p>When this option is enabled, the input data will be automatically delimited with colon marks. E.g. To enter the '11:22:33:44:55:66' BD address the input string should be '112233445566'.</p>

SmartBond Production Line Tool

7.2.5 DUT Hardware Setup (DA14531)

7.2.5.1 UART Boot Pins Setup

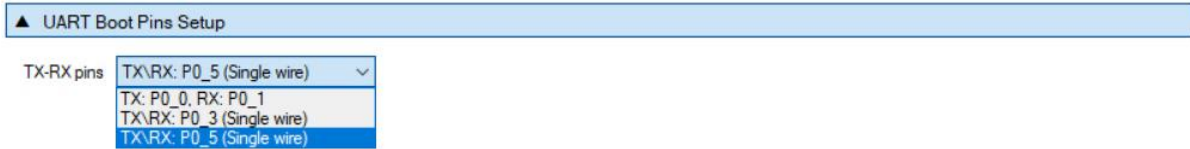

Figure 45: UART Boot Pins Setup - DA14531

Table 34 describes the available options for the *TX-RX pins* of the *UART Boot Pins Setup* DA1458x options. The *TX-RX pins* selection defines the UART pins and the baud rate that will be used for firmware downloading to the DA1458x during boot.

Table 34: UART TX-RX Pins - DA1458x

Option	Description
TX: P0_0, RX: P0_1	Sets UART TX pin to P0_0, UART RX pin to P0_1 and Baud rate to 115200 bit/s.
TX\RX: P0_3 (single wire)	Sets UART TX and RX pins to P0_3. Boot baud rate will be 115200 bit/s.
TX\RX: P0_5 (single wire)	Sets UART TX and RX pins to P0_3. Boot baud rate will be 115200 bit/s.

Note: The baud rate is fixed during device boot, since it is controlled by the device ROM bootloader.

7.2.5.2 UART Baud Rate

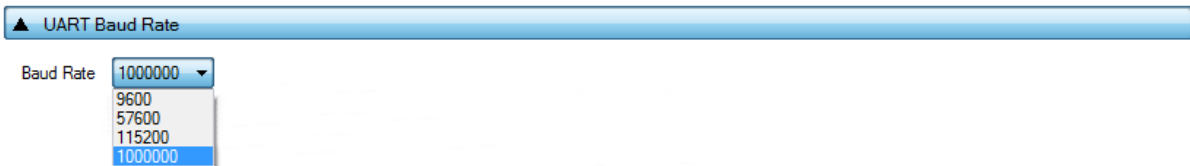

Figure 46: UART Baud Rate - DA14531

Table 35 shows the available options for the *UART baud rate*.

The *Baud Rate* selected here is used after the initial firmware (*flash_programmer_531.bin*) has been downloaded to the DUT. The software sends a command to the DUT to change the UART baud rate to the one selected. All following UART communications with the DUT is performed using the new baud rate. Please note that this only happens during memory programming where the *flash_programmer_531.bin* is used. During tests (RF tests, XTAL trimming, etc.), where the production test firmware is used (*prod_test_531.bin*), the baud rate is fixed at 115200 bit/s.

Table 35: UART Baud Rate - DA1458x

Option	Description
Baud Rate	<ul style="list-style-type: none"> 9600 [bit/s] 57600 [bit/s] 115200 [bit/s] 1000000 [bit/s] <p>Note: 1 Mbit/s is the fastest and safest with 0% baud rate error.</p>

SmartBond Production Line Tool

7.2.5.3 SPI Flash Configuration

▲ SPI Flash Configuration

SPI pin setup

CLK MISO MOSI CS

Enable pin

Pin

SPI flash options

SPI bus parameters

Word length

Mode type

SPI clock idle polarity

SPI sampling edge

SPI interrupt

SPI clock divider

Memory parameters

Total size 0x

Page size 0x

Jedec ID 0x

Jedec ID mask 0x

Memory protection 0x

Figure 47: SPI Flash Configuration - DA14531

Table 36 describes the available options for the *SPI Pin Setup*.

Table 36: SPI Pin Setup - DA14531

Option	Description
SPI pin setup	This option enables the SPI flash memory pin selections.
CLK	Sets the GPIO for the CLK pin of the SPI bus. Default GPIO pin is P0_0.
MISO	Sets the GPIO for the MISO pin of the SPI bus. Default GPIO pin is P0_5.
MOSI	Sets the GPIO for the MOSI pin of the SPI bus. Default GPIO pin is P0_6.
CS	Sets the GPIO for the CS pin of the SPI bus. Default GPIO pin is P0_3.
Enable pin	Sets a specific GPIO to high state during any SPI flash operation.
Pin	Sets the GPIO to be used as the enable pin.

Table 37 describes the available options for the DA14531 *SPI Flash Configuration*. To setup the SPI flash configuration properly, refer to the datasheet of the memory to be used.

Note: If the memory to be used is listed in the supported memories (Appendix U), then the SPI pin setup configuration option can be disabled.

Table 37: SPI Flash Configuration - DA14531

Option	Description
SPI flash options	Enables the on-demand SPI flash configuration.
Word length	Shows the length of each word in the SPI-bus.
Mode type	Shows the SPI-bus role of the chip.

SmartBond Production Line Tool

Option	Description
SPI clock idle polarity	Sets the level of the idle state of the clock.
SPI sampling edge	Sets the SPI-bus sampling edge.
SPI interrupt	Enables the SPI interrupt. Note: This interrupt may be shared with other interrupts.
SPI clock divider	Sets the SPI-bus clock frequency.
Total size	Sets the SPI Flash size in bytes.
Page size	Sets the size of each page of the SPI Flash memory.
Jedec ID	Sets the SPI Flash Jedec ID.
Jedec ID mask	Sets the bitmask of the Jedec ID.
Memory protection	Sets the SPI Flash protection value.

7.2.5.4 I2C EEPROM Configuration

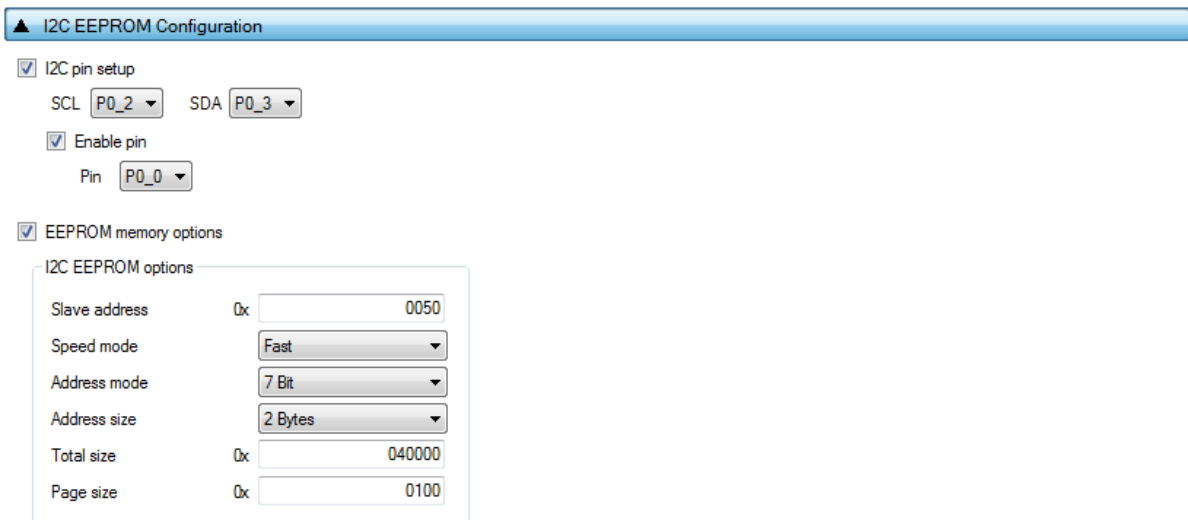

Figure 48: I2C EEPROM Configuration - DA14531

Table 38 describes the available options for the *I2C Pin Setup*.

Table 38: I2C Pin Setup - DA14531

Option	Description
I2C pin setup	This option enables the I2C pin selections. If this option is disabled, the default pin configuration will be used.
SCL	Sets the GPIO for the SCL pin of the I2C bus. Default GPIO pin is P0_2.
SDA	Sets the GPIO for the SDA pin of the I2C bus. Default GPIO pin is P0_3.
Enable pin	Sets a specific GPIO to high state during any EEPROM operation.
Pin	Sets the GPIO to be used as the enable pin.

Table 39 describes the available options for the DA14531 *I2C EEPROM Configuration*. In order to properly setup the I2C EEPROM configuration, refer to the datasheet of the memory to be used.

Note: If the memory to be used is listed in the supported memories (Appendix U), then the on demand I2C EEPROM configuration option is not needed.

SmartBond Production Line Tool

Table 39: I2C EEPROM Configuration – EEPROM Memory Options - DA14531

Option	Description
EEPROM memory options	Enables the on demand EEPROM memory configuration.
Slave address	Sets the I2C-bus slave address of the EEPROM memory to be used.
Speed mode	Sets the I2C-bus speed.
Address mode	Sets the I2C-bus addressing mode.
Address size	Sets the I2C-bus number of bytes used for address.
Total size	Sets the EEPROM size in bytes.
Page size	Sets the size of each page of the EEPROM memory.

7.2.6 Test Settings (DA14531)

7.2.6.1 GPIO Watchdog Operation

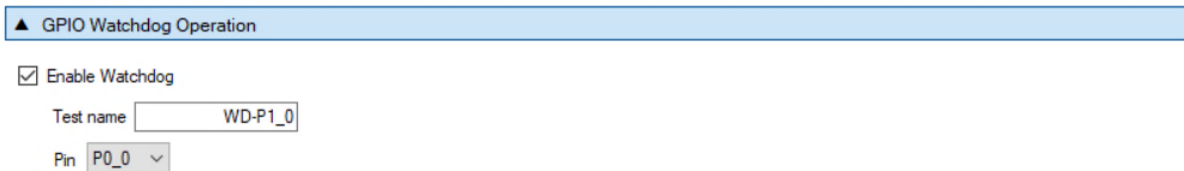

Figure 49: GPIO Watchdog Operation – DA14531

Table 40 describes the GPIO watchdog configuration options. When this feature is enabled, firmware will continuously toggle the selected GPIO at specific intervals, less than four seconds.

Table 40: GPIO Watchdog Configuration Options – DA14531

Option	Description
Enable Watchdog	The checkbox enables the operation. It enables the continuous toggling of a GPIO during the whole production testing and memory programming procedure, except during firmware download. The pulse on the GPIO has approximately 1.5% duty cycle and 0.48 Hz frequency.
Test name	The test name to be used for logging purposes
Pin	The GPIO to toggle

7.2.6.2 VBAT Level Log

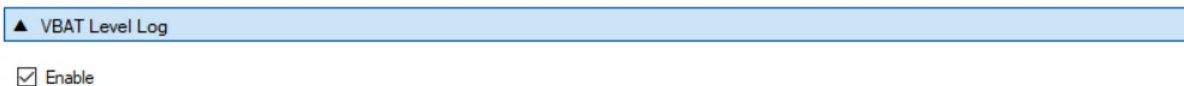

Figure 50: VBAT Level Log - DA14531

When this feature is enabled, PLT will send a command to the device to measure VBAT using its internal ADC. The VBAT level will then be logged. No, pass or fail limits exist for this test. It is only used for logging purposes.

7.2.6.3 OTP Timestamp Read

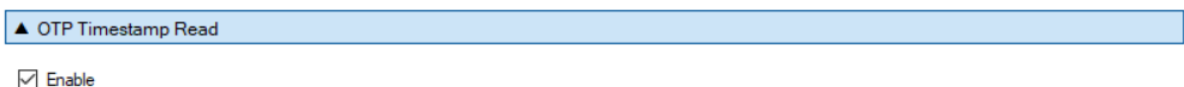

Figure 51: OTP Timestamp Read - DA14531

SmartBond Production Line Tool

If this option is enabled, PLT will read the device timestamp from the OTP memory and log it. This operation is mainly used for logging purposes.

7.2.6.4 DC-DC Converter Level Test

Figure 52: DC-DC Converter Level Test - DA14531

When this test is enabled, PLT will send a command to the device to measure the DC-DC converter level. It will then compare it to the limits given by the user. [Table 41](#) describes the user configurable options.

Table 41: DC-DC Converter Level Test Options - DA14531

Option	Description
Enable	The checkbox enables the test
Low limit	The low limit of the DC-DC converter level test. If result is lower test will fail.
High limit	The high limit of the DC-DC converter level test. If the result is higher test will fail.

7.2.6.5 XTAL Trim

Figure 53: XTAL Trim - DA1458x

[Table 42](#) describes the available options for the DA1458x *XTAL Trim* operation.

Table 42: XTAL Trim - DA1458x

Option	Description
Enable	This option enables the automatic crystal oscillator frequency calibration procedure.
GPIO input pulse pin	The GPIO on which the DUT will receive the reference pulse during calibration. The UART RX pin can be used for this purpose without any additional connection from the PLT hardware to the DUT.
Burn to OTP	When this option is selected, the XTAL trim value calculated from the automated calibration process will be written into the OTP XTAL trim header field and the OTP XTAL calibration flag will be set.

SmartBond Production Line Tool

7.2.6.6 Scan DUT Advertise Test

▲ Scan DUT Advertise Test

Enable

Settings

Channel CH37 ▾

Scan retries

Tx power 0 dBm ▾

Limits

RSSI limit >= dBm

Figure 54: Scan DUT Advertise Test - DA14531

Table 43 describes the available options for the DA14531 *Scan DUT Advertise Test* operation. In this test, the Golden Unit acts as a scanner and the DUTs start advertising using HCI commands.

Table 43: Scan DUT Advertise Test - DA1458x

Option	Description
Enable	This option enables the <i>Scan DUT Advertise Test</i> operation.
Channel	The BLE channel frequency used in the RF RX test using the Golden Unit.
Scan retries	The number of retries to perform the test.
TX power	Set the device output TX power.
RSSI limit	The RSSI limit for pass/fail criteria in the RF RX test using the Golden Unit. If the average RSSI of the device after it has received the packets transmitted from the Golden Unit is less than that the test will be considered as failed.

7.2.6.7 RF Tests

This section refers to various RF tests conducted between the DUTs and the Golden Unit or an external BLE tester.

These tests can have multiple instances with different settings. Tests can be added and removed using the two buttons (e.g. and in Figure 55) at the bottom right side of each panel.

Note: When adding or removing a test, all settings are refreshed with the values written to the XML file, meaning that any unsaved settings will be lost.

SmartBond Production Line Tool

Golden Unit

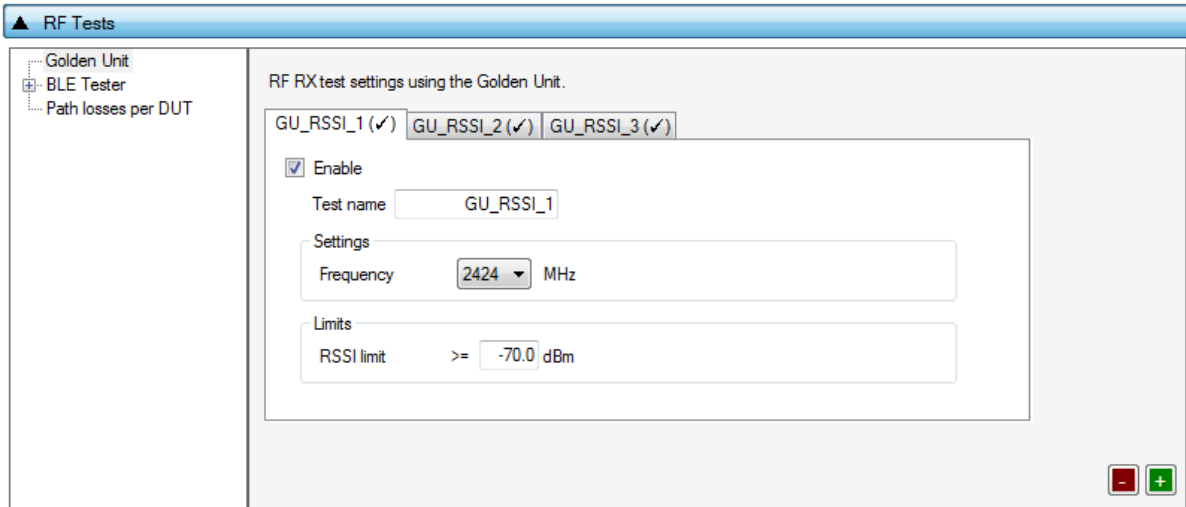

Figure 55: Golden Unit RF Tests - DA14531

Table 44 describes the available options for the *RF RX* test using the *Golden Unit* as a transmitter.

In the *RF RX* test, the *Golden Unit* sends 500 packets on the selected BLE channel. The *DUTs* are set in receive mode and the *RSSI* is measured. If the *RSSI* measured by the *DUT* reception is less than the specified *RSSI limit* value, the device will fail and the tests will stop for that particular device.

Table 44: Golden Unit RF Tests - DA14531

Option	Description
Enable	This option enables the specific <i>RF RX</i> test using the <i>Golden Unit</i> as a transmitter.
Test name	The name assigned to each test. The assigned name will be shown on the tab and next to it an indication showing whether the specific test is enabled or not.
Frequency	The BLE channel frequency used in the <i>RF RX</i> test using the <i>Golden Unit</i> .
RSSI limit	The <i>RSSI</i> limit for pass/fail criteria in the <i>RF RX</i> test using the <i>Golden Unit</i> . If the average <i>RSSI</i> of the device, after it has received the packets transmitted from the <i>Golden Unit</i> , is less than the value entered here the test will fail.

SmartBond Production Line Tool

BLE Tester

In the *BLE Tester* panel, several tests can be enabled that require an external BLE tester instrument.

BLE Tester – General Settings

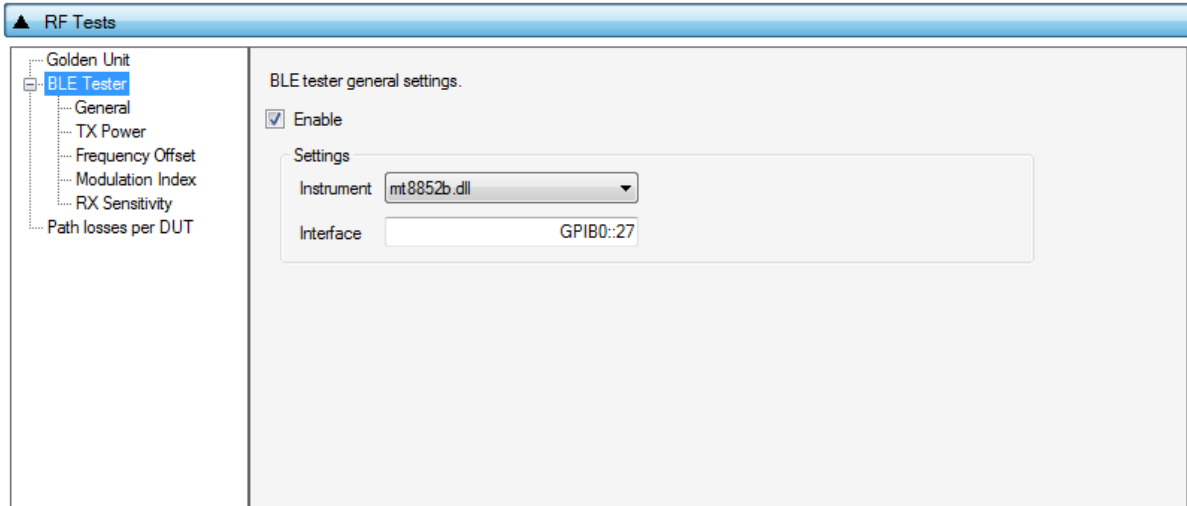

Figure 56: BLE Tester General Settings - DA1458x

Table 45 describes the general settings for the *BLE Tester* supported tests. Any available external instrument found by the `ble_tester_driver` DLL and their interfaces can be selected.

Table 45: BLE Tester General Settings - DA1458x

Option	Description
Enable	This option enables all the <i>BLE Tester</i> tests, which include: <ul style="list-style-type: none"> • BLE Tester TX Power • Frequency Offset • Modulation Index • RX Sensitivity
Instrument	Select the BLE tester DLL name. Names are shown only if a BLE tester instrument DLL exists in the project <code>ble_tester_instr_plugins</code> folder.
Interface	The interface of the instrument to be used by the driver.

SmartBond Production Line Tool

BLE Tester - TX Power

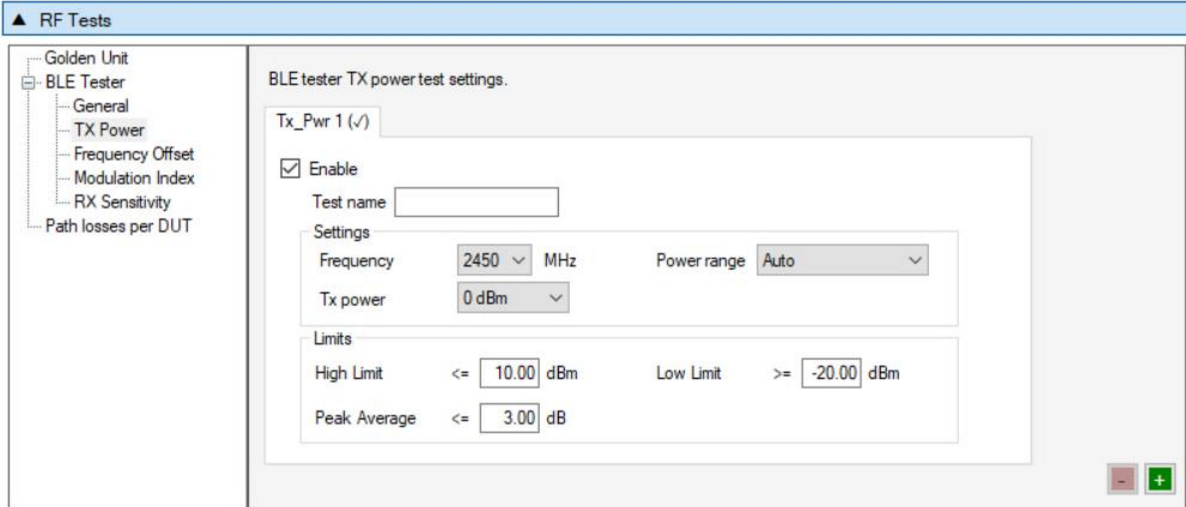

Figure 57: BLE Tester TX Power - DA14531

Table 46 describes the available options for the TX Power test using a BLE Tester instrument.

Table 46: BLE Tester TX Power - DA14531

Option	Description
Enable	This option enables the specific TX power test using a BLE tester instrument.
Test name	The name assigned to each test. The assigned name will be shown on the tab and next to it an indication showing whether the specific test is enabled or not.
Frequency	The BLE channel frequency used in the BLE TX power test.
Power range	Set the device TX output power range. Available options are: <ul style="list-style-type: none"> • Auto (No auto option for Litepoint IQxel-M. Sets the instrument to trigger at -25dBm) • +22 dBm to +7 dBm • +9 dBm to -3 dBm • +5 dBm to -7 dBm • -4 dBm to -16 dBm • -12 dBm to -26 dBm • -24 dBm to -35 dBm Default value is <i>Auto</i> .
TX power	Set the device output TX power as supported by DA14531.
High limit	Set the average high-power limit for the BLE TX output power pass/fail test criteria.
Low limit	Set the average low power limit for the BLE TX output power pass/fail test criteria.
Peak average	Set the peak-to-average power limit for the BLE TX output power pass/fail test criteria.

SmartBond Production Line Tool

BLE Tester - Frequency Offset

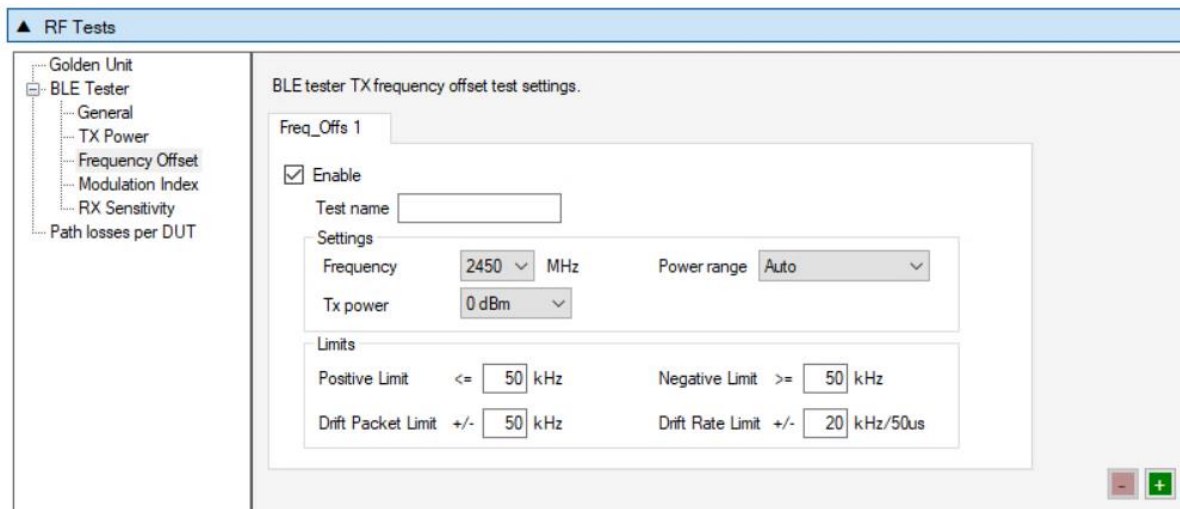

Figure 58: BLE Tester Frequency Offset - DA14531

Table 47 describes the available options for the *Frequency Offset* test using a BLE Tester instrument.

Table 47: BLE Tester Frequency Offset - DA14531

Option	Description
Enable	This option enables the specific TX frequency offset test using a BLE tester instrument.
Test name	The name assigned to each test. The assigned name will be shown on the tab and next to it an indication showing whether the specific test is enabled or not.
Frequency	The BLE channel frequency used in the BLE TX frequency offset test.
Power range	Set the device TX output power range. Available options are: <ul style="list-style-type: none"> • Auto • +22 dBm to +7 dBm • +9 dBm to -3 dBm • +5 dBm to -7 dBm • -4 dBm to -16 dBm • -12 dBm to -26 dBm • -24 dBm to -35 dBm Default value is <i>Auto</i> .
TX power	Set the device output TX power as supported by DA14531.
Positive limit	Set the maximum positive offset limit in kHz for the TX carrier frequency offset pass/fail test criteria.
Negative limit	Set the maximum negative offset limit in kHz for the TX carrier frequency offset pass/fail test criteria.
Drift packet limit	Set the overall packet drift in kHz for the TX drift pass/fail test criteria.
Drift rate limit	Set the drift rate limit in kHz/50 μs for the TX drift pass/fail test criteria.

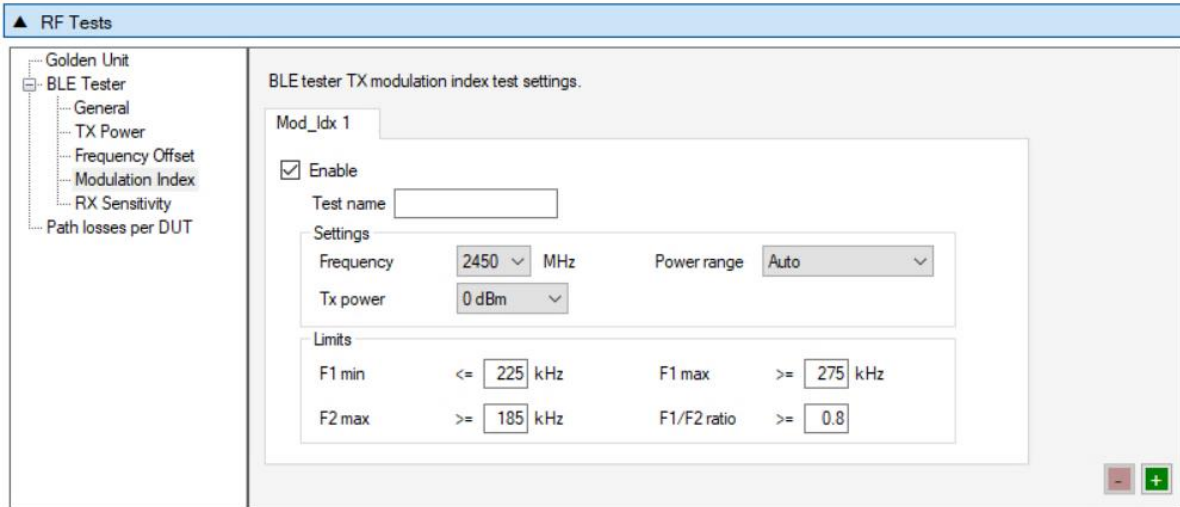

Figure 59: BLE Tester Modulation Index - DA14531

Table 48 describes the available options for the *Modulation Index* test using a BLE Tester instrument.

Table 48: BLE Tester Modulation Index - DA14531

Option	Description
Enable	This option enables the specific TX modulation index test using a BLE tester instrument.
Test name	The name assigned to each test. The assigned name will be shown on the tab and next to it an indication showing whether the specific test is enabled or not.
Frequency	The BLE channel frequency used in the BLE TX modulation index offset test.
Power range	Set the device TX output power range. Available options are: <ul style="list-style-type: none"> • Auto • +22 dBm to +7 dBm • +9 dBm to -3 dBm • +5 dBm to -7 dBm • -4 dBm to -16 dBm • -12 dBm to -26 dBm • -24 dBm to -35 dBm Default value is <i>Auto</i> .
TX power	Set the device output TX power as supported by DA14531.
F1 min	Set the F1 minimum average limit in kHz for the TX modulation index pass/fail test criteria.
F1 max	Set the F1 maximum average limit in kHz for the TX modulation index pass/fail test criteria.
F2 max	Set the F2 maximum limit in kHz for the TX modulation index pass/fail test criteria.
F1/F2 ratio	Set the F1/F2 maximum average ratio limit for the TX modulation index pass/fail test criteria.

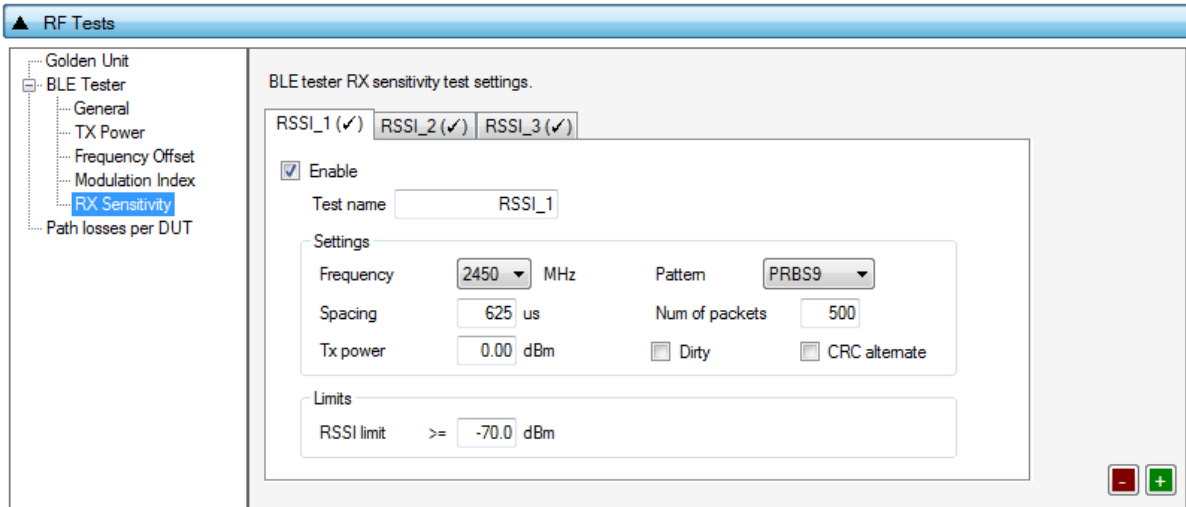

Figure 60: BLE Tester RX Sensitivity - DA14531

Table 49 describes the available options for the *RX Sensitivity* test using a BLE Tester instrument.

Table 49: BLE Tester RX Sensitivity - DA14531

Option	Description
Enable	This option enables the specific RX sensitivity test using a BLE tester instrument.
Test name	The name assigned to each test. The assigned name will be shown on the tab and next to it an indication showing whether the specific test is enabled or not.
Frequency	The BLE channel frequency used in the BLE RX sensitivity test.
Pattern	The bit pattern of the TX data. Available options are: <ul style="list-style-type: none"> • PRBS9 • 10101010 • 11110000
Spacing	The packet spacing in μ s.
Num of packets	The number of packets the BLE tester instrument to transmit.
Tx power	The TX output power of the BLE tester instrument. Suggested values are 0 to -10 dBm.
Dirty	When enabled, the BLE tester packet generator can use a dirty table to transmit.
CRC alternate	When enabled, the BLE tester will alternately send packets with CRC correct and CRC incorrect.
RSSI limit	The RSSI limit for pass/fail criteria in the RF RX sensitivity test. If the average RSSI of the device after it has received the transmitted packets is less than this value, the test will be considered as failed.

SmartBond Production Line Tool

Path Losses per DUT

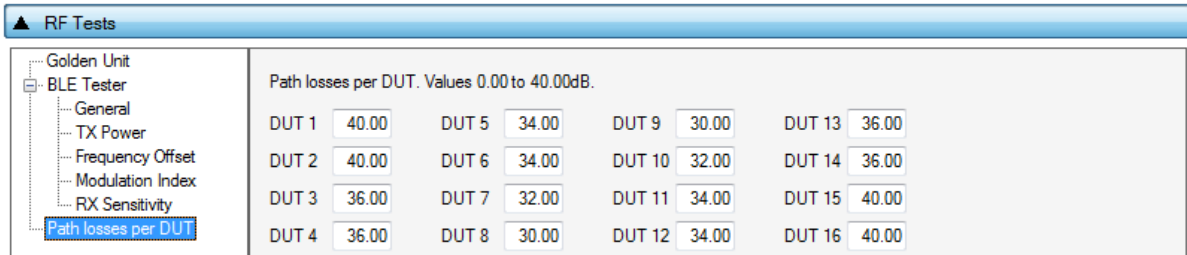

Figure 61: Path Losses per DUT - DA14531

Table 50 describes the available options for the *Path losses per DUT*.

Based on the relative position of each DUT during RF tests and since the RF tests are performed over the air, values can be used to correct for any path losses. These values are added to the limits of the TX Power and RSSI tests. Additional information can be found in [Appendix D](#) and [Appendix F](#).

Table 50: Path Losses per DUT from RF Tests DA14531 Options

Option	Description
DUT1-16	Set the calibrated path loss value for each DUT. These will be added as corrections to the limits of the TX Power and RF RX RSSI tests.

7.2.6.8 GPIO/LED Test

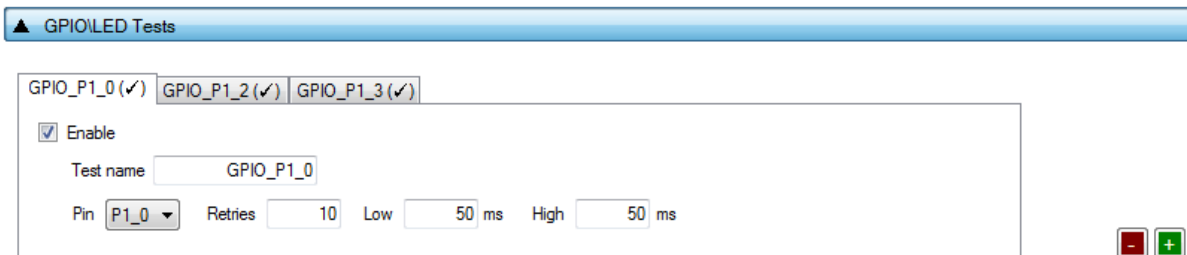

Figure 62: GPIO/LED Tests - DA14531

GPIO/LED Tests can have multiple instances with different settings. Tests can be added or removed using the two buttons (e.g. and in [Figure 62](#)) at the bottom right side of each panel.

Note: When adding or removing a test, all settings are refreshed with the values written to the XML file, meaning that any unsaved settings will be lost.

[Table 51](#) describes the available options for the *GPIO/LED Tests* DA14531 Options.

In these tests, selected GPIO can be toggled and any LED connected to it can be visually tested.

Table 51: GPIO/LED Tests - DA14531

Option	Description
Enable	This option enables the GPIO/LED toggling. Can be used for visual LED testing.
Test name	The name assigned to each test. The assigned name will be shown on the tab and next to it an indication showing whether the specific test is enabled or not.
Pin	The GPIO that will be used for the specific test.
Retries	Number of pulses to be generated for the specific test.
Low	Sets the amount of the OFF time of the pulse in ms for the specific test.

SmartBond Production Line Tool

Option	Description
High	Sets the amount of the ON time of the pulse in ms for the specific test.

7.2.6.9 GPIO Connection Test

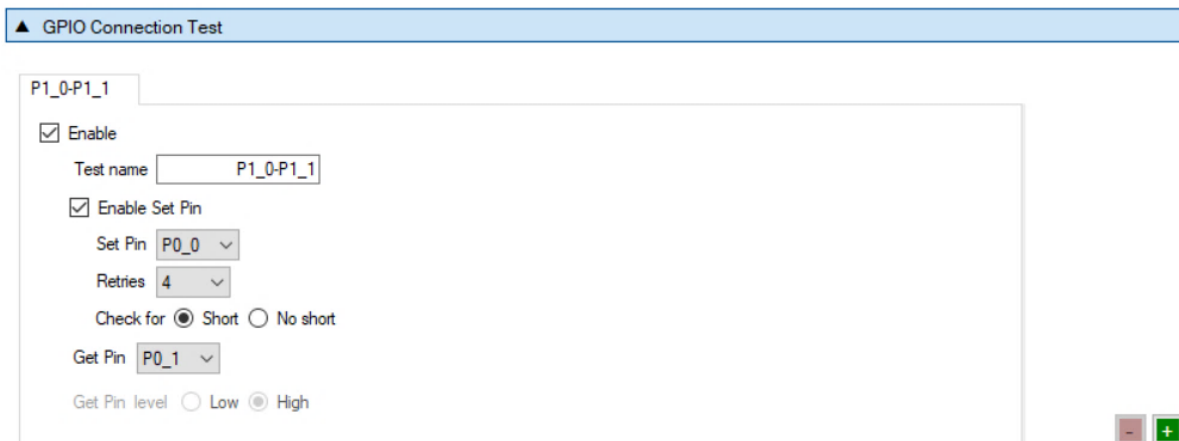

Figure 63: GPIO Connection Test - DA14531

GPIO Connection Tests can have multiple instances with different settings. Tests can be added and removed using the two buttons (e.g. and in Figure 63) at the bottom right side of each panel.

Note: When adding or removing a test all settings are refreshed with the values written to the XML file, meaning that any unsaved settings will be lost.

Table 52 describes the available options for the DA14531 GPIO Connection Test.

When enabled, the PLT software will check the connection of the specified GPIO (Get Pin) by either checking its state or the connection with another pin (Set Pin). In the latter case, the user gives the Set Pin and the state to check. It will also check for shorts between given GPIOs.

Table 52: GPIO Connection Test - DA14531

Option	Description
Enable	This option enables the specific custom test.
Test name	The name assigned to each test. The assigned name will be shown on the tab and next to it an indication showing whether the specific test is enabled or not.
Enable Set Pin	Enables the use of the secondary GPIO to drive the GPIO under test. When this option is set, the Get Pin level option will be disabled.
Set Pin	Select the GPIO to be tested
Retries	How many times the software will check for GPIO connection or short. In every retry it will change the Set Pin level and check the Get Pin level.
Check for Short/No short	If Short is selected, PLT will check whether the Set Pin has the same level with the Get Pin for all Retries tested. If No short is selected, PLT will check whether Get Pin is always low no matter what the Set Pin level is.
Get Pin	Select the GPIO to be tested.
Get Pin level	Sets the GPIO state the test awaits to see in the Get Pin. This option is disabled if the Set Pin mode is enabled.

7.2.6.10 Sensor Test

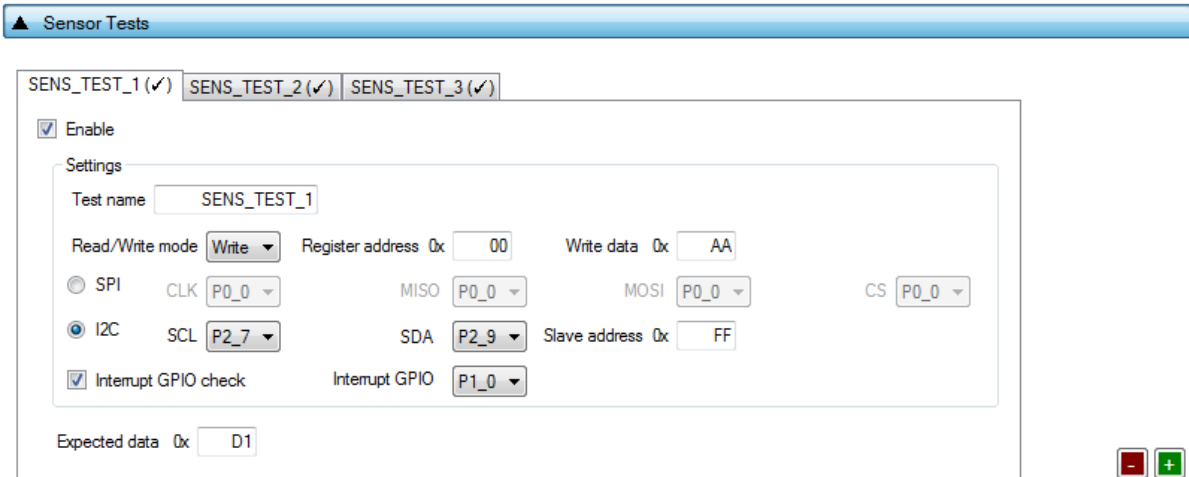



Figure 64: Sensor Test - DA14531

Sensor Tests can have multiple instances with different settings. Tests can be added and removed using the two buttons (e.g.  and  in Figure 64) at the bottom right side of each panel.

Note: When adding or removing a test all settings are refreshed with the values written to the XML file, meaning that any unsaved settings will be lost.

Table 53 describes the available options for the Sensor Tests DA14531 Options.

Table 53: Sensor Tests - DA14531

Option	Description
Enable	This option enables the specific sensor test.
Test name	The name assigned to each test. The assigned name will be shown on the tab and next to it an indication showing whether the specific test is enabled or not.
Read / Write mode	Select the sensor test procedure, to read or write.
Register address	The sensors register address to read or write data.
Write data	The byte to be written at the sensor register.
SPI / I2C	Select the interface that the sensor is connected to.
SPI - CLK	Select the GPIO for the sensor SPI CLK.
SPI - MISO	Select the GPIO for the sensor SPI MISO.
SPI - MOSI	Select the GPIO for the sensor SPI MOSI.
SPI - CS	Select the GPIO for the sensor SPI CS.
I2C - SCL	Select the GPIO for the sensor I2C SCL.
I2C - SDA	Select the GPIO for the sensor I2C SDA.
Slave address	The sensor I2C bus slave address.
Interrupt GPIO check	Enables the sensor interrupt signal test via GPIO.
Interrupt GPIO	Select the GPIO to be used as a sensor interrupt.
Expected data	The received sensor byte that will be expected on a successful operation.

SmartBond Production Line Tool

7.2.6.11 Custom Test

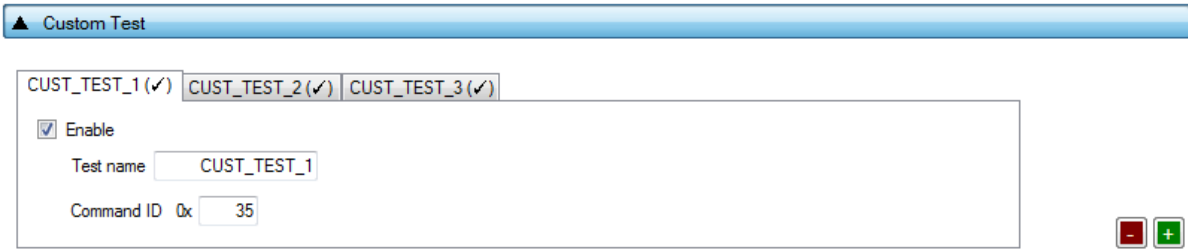



Figure 65: Custom Test - DA14531

Custom Tests can have multiple instances with different settings. Tests can be added and removed using the two buttons (e.g.  and  in Figure 65) at the bottom right side of each panel.

Note: When adding or removing a test all settings are refreshed with the values written to the XML file, meaning that any unsaved settings will be lost.

Table 54 describes the available options for the DA14531 Custom Tests.

When enabled, the PLT software will send an HCI command over UART to activate a customer defined test that will be executed on the DUTs. The HCI custom test command will contain a single byte as data (the Command ID byte), to be used mainly as identification for the specific test in the customized firmware. The default functionality of the production test firmware is to respond with the same Command ID. Otherwise, PLT will consider the test as failed.

Table 54: Custom Tests - DA14531

Option	Description
Enable	This option enables the specific custom test.
Test name	The name assigned to each test. The assigned name will be shown on the tab and next to it an indication showing whether the specific test is enabled or not.
Command ID	The byte that will be sent to the device running the production test firmware.

7.2.6.12 External 32 kHz Test

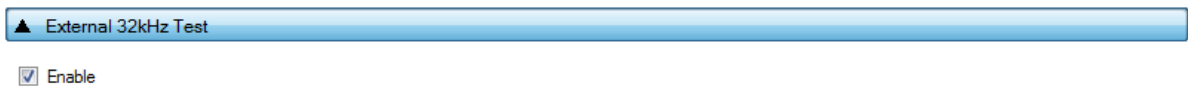

Figure 66: External 32 kHz Test - DA14531

Table 55 describes the available options for the DA1458x External 32 kHz Test.

When enabled, the PLT software will verify the correct operation of the External 32 kHz crystal on each DUT.

Table 55: External 32 kHz Test - DA14531

Option	Description
Enable	This option enables the External 32 kHz test.

SmartBond Production Line Tool

7.2.6.13 Current Measurement Test

▲ Current Measurement Test

Current measurement general settings

Enable

Instrument Settings

Instrument ammeter_scpi.dll

Interface GPIO::16

Enable single DUT current measurement when failed

Peripheral Current Measurement

Periph Test 1

Enable

Test name

Single Device

Ammeter Setup

Settings

Shunt resistor 0.00 Ohms Wait time 2000 mSecs

Range 0.01 Amps Resolution 0.0001 Amps

Samples 10 SCPI cmd CURR:DC:NPLC 1

Limits per device

Upper limit <= 0.00 Amps

Low limit >= 0.00 Amps

Test Options

GPIO GPIO Pin P0_0 GPIO state High

PWM frequency 0 KHz PWM duty 0 %

Custom Test Custom test

Start Command ID 0x 00 Stop Command ID 0x 00

Sleep Current Measurement

Enable

Settings

Single device

Sleep mode Extended Deep

Shunt resistor 0.00 Ohms Wait time 2000 mSecs Sleep time 5 Secs

Range 0.001 Amps Resolution 0.0001 Amps Up to 1200s of sleep time is supported.

Samples 10 SCPI cmd CURR:DC:NPLC 1

Limits per device

Upper limit <= 0.000002 Amps

Low limit >= 0.000017 Amps



Figure 67: Current Measurement Test - DA14531

In this test, an external ammeter can be used to calculate the total current consumption of all the active DUTs at the time of the sampling. The ammeter can be connected in the blue banana plugs as described in [Current Measurements](#) or to an external power supply (if present) depending the selected [VBAT/Reset Mode](#).

SmartBond Production Line Tool

During measurement, PLT controls the instrument using the `ammeter_driver` DLL [1]. Table 56 describes the instrument selection settings found by the `ammeter_driver` DLL, Table 57 describes the settings used for each of the peripheral current measurement tests, and Table 58 describes the current measurement options for each sleep state.

Note: Modifications in the production test firmware are mandatory to achieve the correct current consumption of a specific hardware design. Running the default firmware without any modifications may result in increased current consumption.

Peripheral Current Measurement Tests can have multiple instances with different settings. Tests can be added and removed using the two buttons (e.g.  and  in Figure 67) at the bottom right side of each panel.

Note: When adding or removing a test, all settings are refreshed with the values written to the XML file, meaning that any unsaved settings will be lost.

Table 56: Current Measurement Test – General Settings - DA14531

Option	Description
Enable	This option enables all Current Measurement tests, which include: <ul style="list-style-type: none"> • Idle Current Measurement • Extended Sleep Current Measurement • Deep Sleep Current Measurement Only one of the Extended/Deep sleep current measurements can be selected, meaning that the other one will be disabled.
Instrument	Select the Ammeter instrument DLL name. Names are shown only if an ammeter DLL exists in the project <code>ammeter_instr_plugins</code> folder.
Interface	The interface of the instrument to be used by the driver.
Enable single DUT current measurement when failed	If this option is enabled and if the measurement taken is outside of the limits, PTL will reset all devices and begin a firmware download and measure the current to each device separately, in order to identify which exact device failed.

Table 57: Peripheral Current Measurement - DA14531

Option	Description
Enable	This option enables the specific peripheral current measurement test.
Test name	The name assigned to each test. The assigned name will be shown on the tab and next to it an indication showing whether the specific test is enabled or not.
Single Device	If this option is enabled, PLT will measure the current consumption one device at a time. Initially, it will power-off all DUTs. It will then power-on one by one, download firmware and measure the current individually. This procedure is time consuming. It should only be used for production setup purposes, to identify the correct limits by measuring multiple DUTs and taking the average.
Shunt resistor	The value of the shunt resistor used for peripheral measurement. Applicable only if a voltmeter or a NI-DAQ is used to measure current instead of a DMM. Values from 0 to 9999 are supported.
Wait time	The time in milliseconds the PLT waits before taking a current measurement after it has sent an instruction to the DUTs to go into sleep state. Supported values are 1 to 500000 ms.
Range	The range in Amperes the ammeter measures. Supported values are 0 to 9999 with a default value of 0.001 A. When the <code>ammeter_scpi.dll</code> is used, if this value is set to zero, the instrument will use automatic range functionality.
Resolution	The ammeter resolution value in Amperes.
Samples	The number of samples the ammeter will read and average, 1 to 1000 is supported.

SmartBond Production Line Tool

Option	Description	
SCPI cmd	A SCPI command to be passed to the ammeter just before the measurement is taken. Supports multiple commands separated with a column. Up to 256 characters are supported.	
Upper limit	The upper limit value for a single DUT. Next to this input field the total upper limit current consumption for all the enabled DUTs is shown, which is the value to be used during testing. Note: Some DUTs may fail before the current measurement test start. PLT will automatically re-calculate the total upper limit by using the value given for a single DUT multiplied with the number of the remaining DUTs at the time that the test will run.	
Low limit	The low limit value for a single DUT. Next to this input field the total low limit current consumption for all enabled DUTs is shown, which is the actual value to be used during testing. Note: Some DUTs may fail before the current measurement test starts. PLT will automatically re-calculate the total low limit by using the value given for a single DUT multiplied with the number of the remaining DUTs at the time that the test will run.	
Test Options	Select between a PWM GPIO test and custom test. Note: For the custom tests to work, a modified production test firmware must be created with tests that set the DUTs to specific states before the current measurement test. Each test must be assigned to a specific opcode. The custom tests are the exact same as in Custom Test .	
Test Options - GPIO	Pin	Sets the GPIO to toggle with the PWM pulse.
	GPIO state	Sets the active state of the GPIO.
	PWM frequency	Sets the PWM frequency.
	PWM duty	Sets the PWM duty cycle.
Test Options – Custom Test	Start Command ID	The opcode of the custom test that sets the state of the DUT.
	Stop Command ID	The opcode of the custom test that restores the DUT to its original state.

Table 58: Current Measurement Test - Sleep Current Measurement - DA14531

Option	Description
Enable	This option enables the specific current measurement using the ammeter provided in the <i>Instrument</i> section.
Single Device	If this option is enabled, PLT will measure the current consumption one device at the time. Initially, it will power off all DUTs. It will then power on one by one, download firmware and measure the current individually. This procedure takes a lot of time. It should only be used for production setup purposes, to identify the correct limits by measuring multiple DUTs and taking the average.
Sleep mode	User can select either the Extended or the Deep sleep mode.
Shunt resistor	The value of the shunt resistor used for sleep current measurement. Applicable only if a voltmeter or a NI-DAQ is used to measure current instead of a DMM. Values from 0 to 9999 are supported.
Wait time	The time in ms the PLT will wait before taking a current measurement, after it has sent an instruction to the DUTs to go into a specific sleep state. Supported values are 1 to 500000ms.
Sleep time	The time in seconds that the DUTs will remain in sleep mode. A timer in the production test firmware will wake up the devices. Supported values are 1 to 9sec for DA14580/1/2/3 and up to 1200sec for the rest.
Range	The range value in Ampere units that the ammeter will operate. Supported values are 0 to 9999 and default value is 0.001A. When the <code>ammeter_scpi.dll</code> is used, if this value is set to zero, the instrument will use the automatic range functionality.

SmartBond Production Line Tool

Option	Description
Resolution	The ammeter resolution value in Ampere units.
Samples	The number of samples that the ammeter will read and average. 1 to 1000 is supported.
SCPI cmd	An SCPI command to be passed to the ammeter just before the measurement is taken. Supports multiple commands separated with a column. Up to 256 characters are supported.
Upper limit	The upper limit value for a single DUT. Next to this input field the total upper limit current consumption for all the enabled DUTs is shown, which is the value to be used during testing. Note: Some DUTs may fail before the current measurement test starts. PLT will automatically re-calculate the total low limit by using the value given for a single DUT multiplied with the number of the remaining DUTs at the time that the test will run.
Low limit	The low limit value for a single DUT. Next to this input field the total upper limit current consumption for all the enabled DUTs is shown, which is the value to be used during testing. Note: Some DUTs may fail before the current measurement test starts. PLT will automatically re-calculate the total low limit by using the value given for a single DUT multiplied with the number of the remaining DUTs at the time that the test will run.

7.2.6.14 Temperature Measurement Test

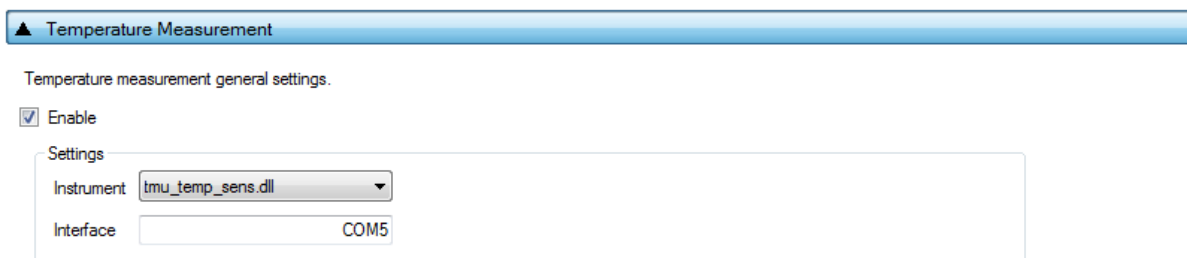

Figure 68: Temperature Measurement Test - DA14531

Table 59 describes the available options of the DA14531 *Temperature Measurement Test*.

Table 59: Temperature Measurement Test - DA14531

Option	Description
Enable	This option enables the temperature measurement test.
Instrument	Selects the temperature measurement DLL. Names are shown only if a temperature measurement instrument DLL exists in the project folder <code>temp_meas_instr_plugins</code> .
Interface	The interface of the instrument to be used by the driver.

SmartBond Production Line Tool

7.2.6.15 Scan Test

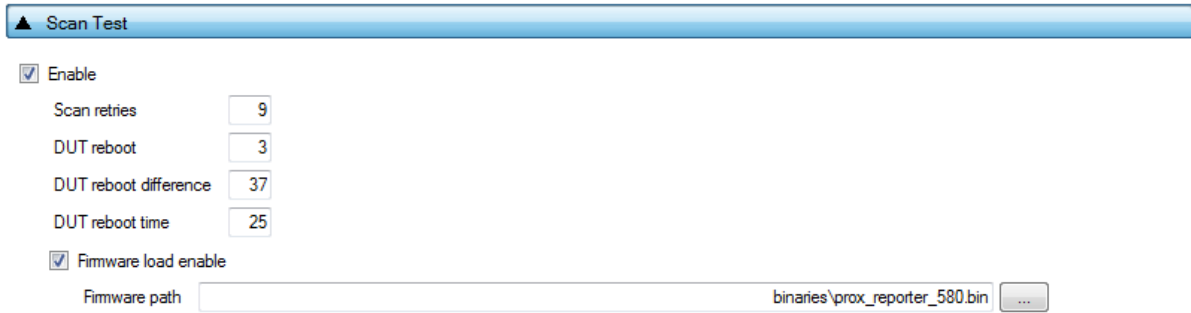

Figure 69: Scan Test - DA14531

Table 60 describes the available options for the DA14531 *Scan Test*.

By enabling this test, the Golden Unit will scan for the DUT’s BD addresses advertised after the customer firmware has been burned. For this test to work, a bootable firmware with the ability to advertise with the BD address given by the PLT must be burned into each DUT. Additionally, the BD addresses provided by the PLT should be burned into OTP memory, such that the devices advertise with the BD addresses that the tool uses.

Table 60: Scan Test DA14531 Options

Option	Description
Enable	This option enables the Scan test.
Scan retries	The total number of BLE advertising scans the Golden Unit will perform.
DUT reboot	Define after how many retries the PLT will reboot the DUTs.
DUT reboot difference	Set the time difference between each DUT when the PLT reboots the devices, in order to avoid air collisions.
DUT reboot time	The time the VBAT will remain low during the device reboot. This value is time in ms*100 (e.g. 15 is 1500 ms).
Firmware load enable	By enabling this option, a new image will be downloaded to all active DUTs before scanning for BLE advertising devices.
Firmware path	The path of the binary file to download to the devices for the scan test.

SmartBond Production Line Tool

7.2.7 Memory Functions (DA14531)

This section describes the Memory Functions settings available when using DA14531 devices. Memory functions include OTP, SPI Flash, and I2C EEPROM memory programming.

7.2.7.1 OTP Memory

This test enables the OTP memory programming. Table 61 describes the available options for the OTP Memory image write operation.

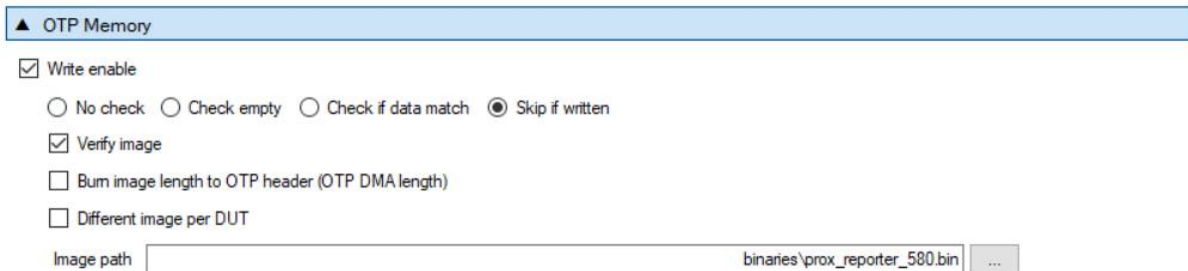

Figure 70: OTP Memory - DA14531

Note: If the binary is larger than the available OTP image area (OTP memory excluding the header area), the PLT software will split the binary into two parts. The first part will contain only the OTP image area. The second part will contain the OTP header fields, split in OTP words. PLT will burn the non-zero words one by one, as single OTP entries in the OTP header area. The check empty feature will handle the first part as an OTP image binary. The second part will be checked word by word.

Table 61: OTP Memory - DA14531

Option	Description
Write enable	This option enables the OTP image write operation.
<ul style="list-style-type: none"> No check Check empty Check if data match Skip if written 	<p>Memory protection options:</p> <p>No check: No protection is enabled. PLT will attempt to burn the OTP memory without running any check.</p> <p>Check empty: PLT will first check if the OTP memory is empty.</p> <p>Check if data match: PLT will first check if the memory to be burned is empty. If it is not, it will compare the contents with the data to be burned. If the data are not the same the test will fail without making any changes to the memory. If the data are the same, PLT will not burn the memory to prevent using the OTP repair memory and continue with success.</p> <p>Skip if written: PLT will read the contents of OTP memory. If it contains any data, it will skip writing without producing any error.</p>
Verify image	If this option is enabled, PLT will read back the contents of the OTP memory and compare them to the original image file. If these do not match it will fail.
Burn image length to OTP header (OTP DMA length)	If this option is selected, PLT software will calculate the length in OTP words and burn it to the Memory Header (DA14531) – OTP DMA length. When selected, it will disable the OTP DMA length option in Memory header tab.
Different image per DUT	If this option is selected, a different image per DUT can be burned into the OTP. The image name must be specific for each DUT, as described below.
Image path	<p>Via this field, the user specifies the image file to be burned into the OTP. A .bin binary file of any name can be selected.</p> <p>Depending on the size of the selected binary, PLT will inform the user if the binary contains both the image and the header part or if it exceeds the maximum supported size.</p> <p>If <i>Different image per DUT</i> is selected, the user only selects the directory of the images. In that case, the binary file names must have the following format: <code>img_xx.bin</code>, where 'X' denotes the DUT number. For example, if the user has activated DUTs 1, 5 and 10 then <code>img_01.bin</code>, <code>img_05.bin</code> and <code>img_10.bin</code> binary</p>

SmartBond Production Line Tool

Option	Description
	files should exist in the selected OTP image path as shown in Figure 71 . Range of numbers is img_01.bin ... img_16.bin.

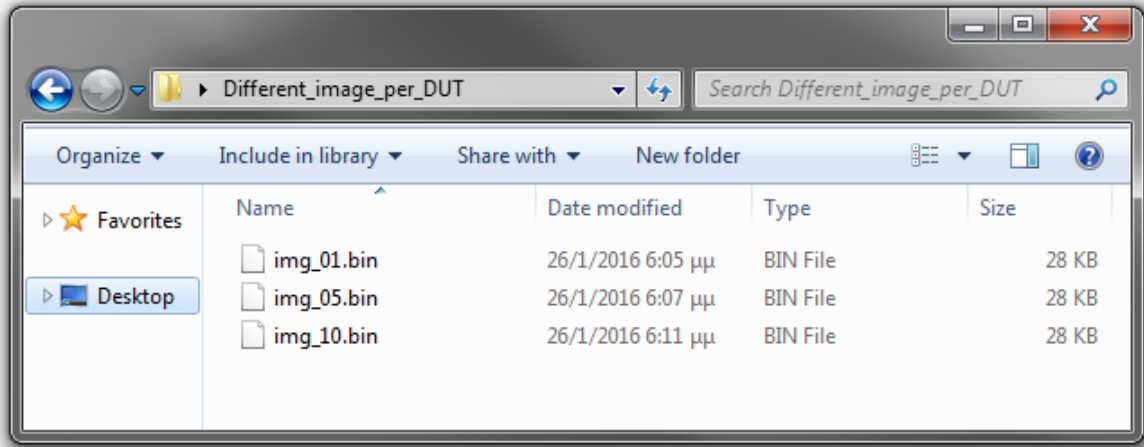

Figure 71: Different Image per DUT Folder Example

7.2.7.2 SPI Flash Memory

This section explains the settings of the SPI Flash Memory operations.

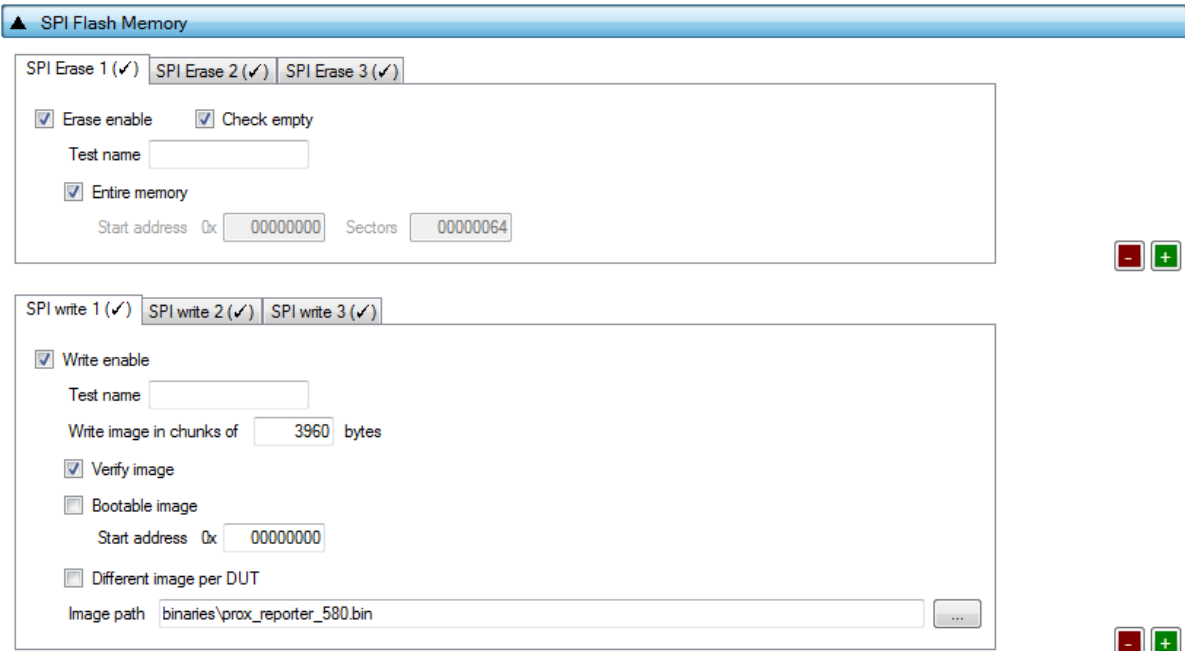



Figure 72: SPI Flash Memory - DA14531

Both erase and write tests can have multiple instances with different settings. Tests can be added and removed using the two buttons (e.g.  and  in [Figure 72](#)) at the bottom right side of each panel.

Note: When adding or removing a test all settings are refreshed with the values written to the XML file, meaning that any unsaved settings will be lost.

The SPI Flash memory should be erased before any image is written to it. [Table 62](#) describes the available options for the *SPI Flash Erase* operation.

SmartBond Production Line Tool

Table 62: SPI Flash Erase - DA14531

Option	Description
Erase enable	This option will enable the SPI flash erase operation.
Check empty	After flash erasure, the PLT software can verify the erasure result by sending a specific command to the <code>flash_programmer_531.bin</code> firmware running in the DUT. The firmware will read the SPI flash memory and check if it is empty. The result will be returned to the PLT software.
Test name	The name assigned to each test. The assigned name will be shown on the tab and next to it an indication showing whether the specific test is enabled or not.
Entire memory	If selected, the entire memory will be erased. Otherwise, the user can give a start address and a specific number of sectors to be erased.
Start address	The user can enter a specific start address for the SPI flash erasure operation.
Sectors	The number of sectors to erase, starting from the <i>Start address</i> as explained above.

After all the SPI flash erase operations have finished, the SPI image write tests will begin. [Table 63](#) describes the available options for the *SPI Flash Image Write* operation.

Table 63: SPI Flash Image Write - DA14531

Option	Description
Write enable	This will enable the specific SPI flash image programming operation.
Test name	The name assigned to each test. The assigned name will be shown on the tab and next to it an indication showing whether the specific test is enabled or not.
Write image in chunks of "user_input" bytes.	During memory programming, PLT will split the image into chunks of size defined in this field. Values from 1 byte to 28664 bytes are supported.
Verify image	By selecting this option, the PLT software will read back the contents of the SPI flash memory, after an image was burned. It will compare them to the original image file. If these do not match the SPI memory programming will fail.
Bootable image	If this is enabled PLT will write a boot header at SPI address 0 and burn the image at SPI address 0x8.
Start address	Users can configure the SPI flash start address image write operation. If <i>Bootable image</i> is selected, this option is disabled.
Different image per DUT	If this option is selected, a different image per DUT will be burned into the SPI flash. The image name must be specific for each DUT, as described below.
Image path	Via this field, the user specifies the image file to be burned into the SPI Flash memory. A <code>.bin</code> binary file of any name can be selected. If option <i>Different image per DUT</i> is selected the user only selects the directory of the images. In that case, the binary file names must have the following format: <code>img_0X.bin</code> , where 'X' denotes the DUT number. For example, if the user has activated DUTs 1, 5 and 10 then <code>img_01.img</code> , <code>img_05.img</code> and <code>img_10.img</code> binary files should exist in the selected SPI image path, as shown in Figure 71 .

SmartBond Production Line Tool

7.2.7.3 I2C EEPROM Memory

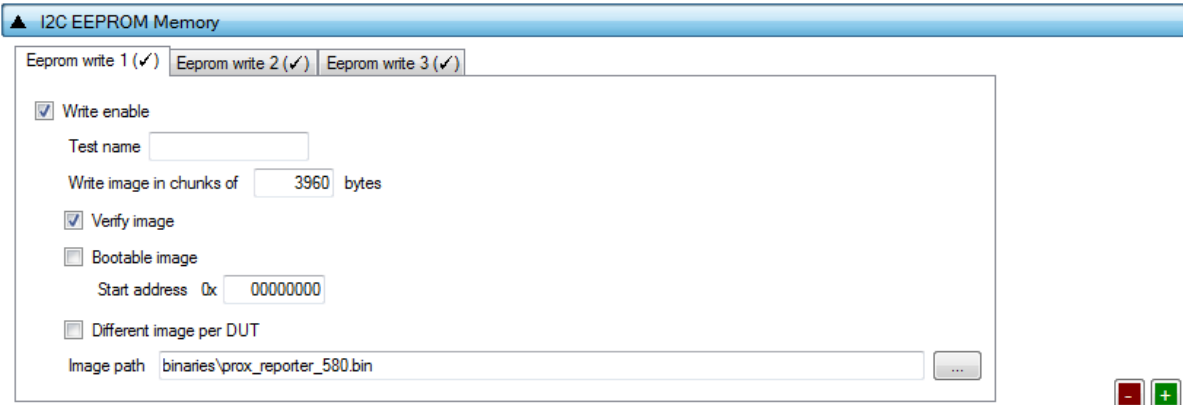

Figure 73: I2C EEPROM Memory - DA1458x

In this section, an I2C EEPROM memory can be programmed. The I2C EEPROM image write tests can be performed multiple times with different settings each time. Tests can be added and removed using the two buttons (e.g. and in Figure 73) at the bottom right side of each panel.

Note: When adding or removing a test all settings are refreshed with the values written to the XML file, meaning that any unsaved settings will be lost.

Table 64 describes the available options for the *I2C EEPROM Image Write* operation.

Table 64: I2C EEPROM Image Write - DA1458x

Option	Description
Write enable	This will enable the specific I2C/EEPROM image programming test.
Test name	The name assigned to each test. The assigned name will be shown on the tab and next to it an indication showing whether the specific test is enabled or not.
Write image in chunks of "user_input" bytes.	During memory programming, PLT will split the image into chunks of size defined in this field. Values from 1 byte to 32760 bytes are supported.
Verify image	By selecting this option, the PLT software will read back the contents of the EEPROM and compare them to the original image file. If these do not match the EEPROM memory programming will fail.
Bootable image	Is this is enabled PLT will write a boot header at EEPROM address 0 and burn the image at the EERPOM address 0x20.
Start address	Users can configure the EEPROM start address image write operation. If <i>Bootable image</i> is selected, this option is disabled.
Different image per DUT	If this option is selected, a different image per DUT will be burned into the EEPROM memory. The image name must be specific for each DUT, as described below.
Image path	This field specifies the image file to be burned into the EEPROM memory. A .bin binary file of any name can be selected. If option <i>Different image per DUT</i> is selected, the user only selects the directory of the images. In that case, the binary file names must have the following format: <i>img_0X.bin</i> , where 'X' denotes the DUT number. For example, if the user has activated DUTs 1, 5 and 10 then <i>img_01.img</i> , <i>img_05.img</i> and <i>img_10.img</i> binary files should exist in the selected image path, as shown in Figure 71.

SmartBond Production Line Tool

7.2.7.4 Memory read

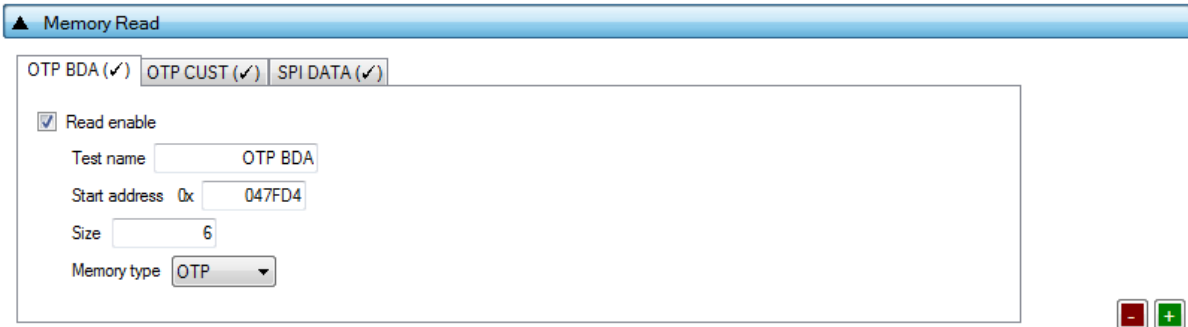

Figure 74: Memory Read Test - DA14531

Memory Read Tests can have multiple instances with different settings. Tests can be added or removed using the two buttons (e.g. and in Figure 74) at the bottom right side of each panel.

Note: When adding or removing a test, all settings are refreshed with the values written to the XML file, meaning that any unsaved settings will be lost.

Table 65 describes the memory read test options. With this test, the user can read up to 64 MBytes of data from any address and any available memory, such as OTP, SPI Flash and EEPROM. An example of how the data appears in the log file is shown in Figure 75. If data to be read are greater than 256 bytes, then a file will be created to store the data under folder mem_read_test in the PLT execution path.

```
Memory read operation initialized. Memory read test name=[OTP BDA].
Memory read operation started. Memory read test name=[OTP BDA].
Memory read operation ended OK. Test name [OTP BDA]. Memory=[OTP]. Addr=[0x47fd4]. Size=[6]. Data=[0a0000808080].
```

Figure 75: Memory Read Test Example Log File - DA14531

Table 65: Memory Read Test - DA14531

Option	Description
Read enable	This will enable the memory read test.
Test name	The name assigned to each test. The assigned name will be shown on the tab and next to it an indication showing whether the specific test is enabled or not.
Start address	Configures the start address for the read test. DA14580/1/2/3 OTP memory 0x40000 offset should be used (e.g. BD address is written in 0x47FD4). DA14585/6 OTP memory offset is at 0x0 (e.g. BD address is written in 0xFFA8). DA14580/1/2/3 OTP valid address is 0x40000 to 0x47FFF and DA14585/6 OTP address 0x0000-0x10000.
Size	Number of bytes to read, up to 64 MBytes. If data to be read are greater than 256 bytes, then a file will be created to store the data under folder mem_read_test in the PLT execution path.
Memory type	The type of memory to read the data from. Available options are OTP, SPI FLASH, and I2C EEPROM. Note: For the SPI FLASH and EEPROM memories, the pin configurations are taken from the SPI Flash Configuration and I2C EEPROM Configuration sections.

SmartBond Production Line Tool

7.2.8 Memory Header (DA14531)

This section describes the OTP header programming settings.

7.2.8.1 General

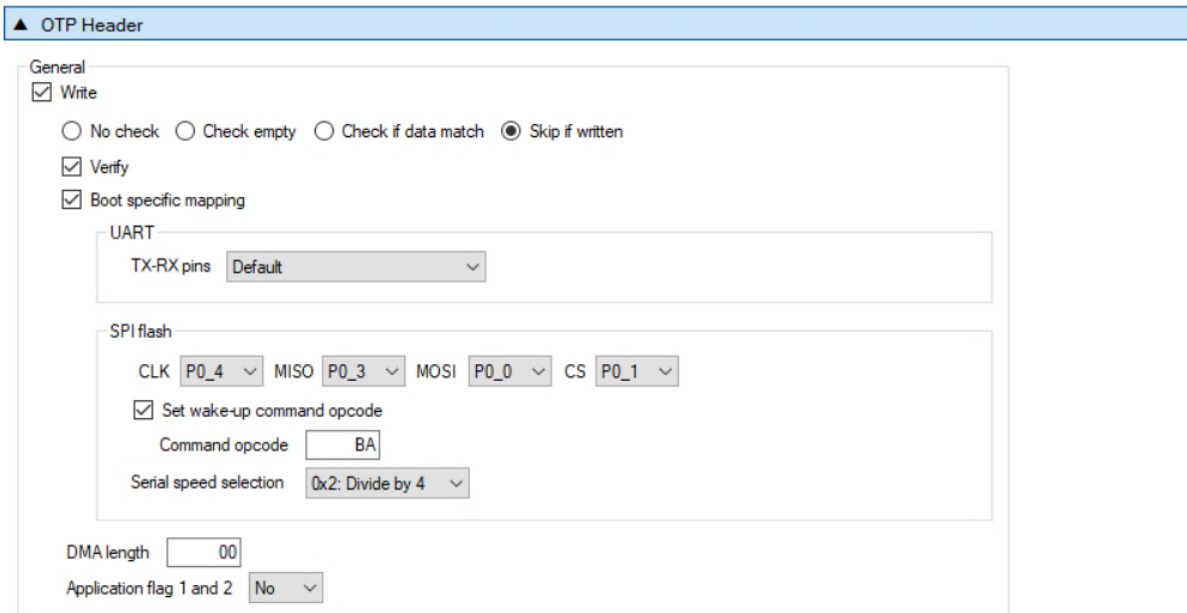

Figure 76: OTP Header - DA14531

Table 66 describes the available options for DA1458x *OTP Header* programming.

Table 66: OTP Header - DA14531

Option	Description
Write	This option enables the OTP header programming.
<ul style="list-style-type: none"> No check Check empty Check if data match Skip if written 	<p>Memory protection options:</p> <p>No check: No protection is enabled. PLT will attempt to burn the OTP memory without running any check.</p> <p>Check empty: PLT will first check if the OTP memory to be burned is empty. If it is empty will burn it.</p> <p>Check if data match: PLT will first check if the memory to be burned is empty. If it is not, it will compare the contents with the data to be burned. If the data are not the same the test will fail without making any changes to the memory. If the data are the same, PLT will not burn the memory to prevent using the OTP repair memory and continue with success.</p> <p>Skip if written: PLT will read the contents of OTP memory. If it contains any data, it will skip writing without producing any error.</p>
Verify	Read back each OTP header value and compared with the original one to verify a successful write.
Boot specific mapping	Enables external booting from a specific SPI interface or UART pin configuration.
UART TX-RX pins	Select which pins will be used to boot from an external device through UART
SPI CLK	Sets the GPIO for the CLK pin of the SPI bus.
SPI MISO	Sets the GPIO for the MISO pin of the SPI bus.
SPI MOSI	Sets the GPIO for the MOSI pin of the SPI bus.
SPI CS	Sets the GPIO for the CS pin of the SPI bus.

SmartBond Production Line Tool

Option	Description
Set wake-up command opcode	Default wake-up command opcode is "AB". If a different one is needed to be used, it can be set using this flag and the following field.
Command opcode	The command opcode to be used for the wake-up.
Serial speed selection	Division factor for SPI.
32 kHz source	Selects the low power 32 kHz clock source.
DMA length	The size (in words) for the DMA controller to copy from OTP to system RAM during boot. Should match the OTP image size. Max value for the DA14531 devices is 0x1FF0. Note: This option will be disabled if Burn image length to OTP header option in OTP Memory is enabled.
Application flag 1 and 2	If this option is set, the device will boot only from the OTP memory. Used for a production ready device. There is no other means to access the device apart from JTAG, if this is still enabled in the OTP header.

7.2.8.2 BD Address

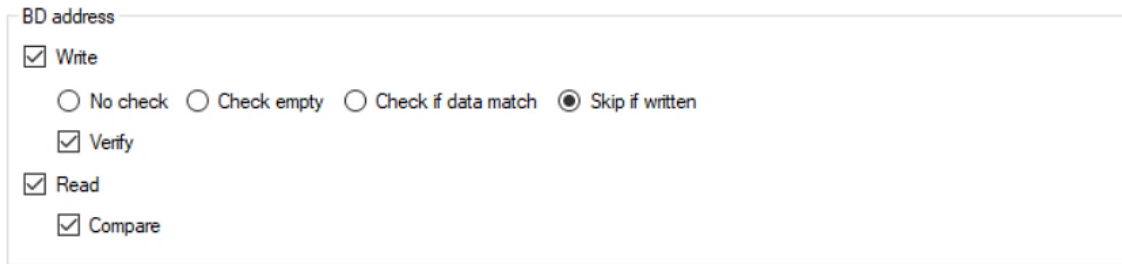

Figure 77: BD Address - DA14531

The BD address can be written independently from the rest of the OTP header fields described before. [Table 67](#) describes the available options for the *BD Address* programming.

Table 67: BD Address - DA14531

Option	Description
Write	When selected, the BD address will be written in the OTP Header.
<ul style="list-style-type: none"> • No check • Check empty • Check if data match • Skip if written 	Memory protection options: No check: No protection is enabled. PLT will attempt to burn the OTP memory without running any check. Check empty: PLT will first check if the OTP memory to be burned is empty. If it is empty will burn it. Check if data match: PLT will first check if the memory to be burned is empty. If it is not, it will compare the contents with the data to be burned. If the data are not the same the test will fail without making any changes to the memory. If the data are the same, PLT will not burn the memory to prevent using the OTP repair memory. Skip if written: PLT will read the contents of OTP memory. If it contains any data, it will skip writing without producing any error.
Verify	When selected, the BD address will be read back from the OTP Header and will be compared to the original.
Read	This option will read the BD address written in the OTP Header field. It is a standalone memory operation. It does not depend on the previous tests to run, but it is necessary for the following <i>Compare</i> test.
Compare	If the <i>Read</i> option is enabled, a comparison will be performed between the read BD address and the BD address entered in the DUT by the PLT, as described in the BD address DUT assignment method.

SmartBond Production Line Tool

7.2.8.3 Custom Memory Data

▲ Custom Memory Data

Custom Memory Data

Write enable

OTP Data
 No check
 Check empty
 Check if data match

Verify data

Input

Barcode scanner
 Scanner interface:
 Scan mode:

CSV file
 CSV file path:

Manual
 Edit data:

Memory: *Memory configuration will be taken from the 'DUT Hardware Setup' tab!*

Start address 0x:

Data size:

Figure 78: Custom Memory Data - DA14531

Table 68 describes the *Custom Memory* data test options. With this test, the user can write any data to any address to any available memory for DA14531 devices, such as OTP, SPI flash and EEPROM. Data input modes can be a Barcode Scanner, a CSV file or data entered manually.

SmartBond Production Line Tool

Table 68: Custom Memory Data - DA14531

Option	Description								
Write enable	This option enables the custom data programming.								
Verify data	When selected, the data written will be read back and compared to the original.								
<ul style="list-style-type: none"> No check Check empty Check if data match Skip if written (Only available when OTP memory or CSV file as input is selected)	Memory protection options: No check: No protection is enabled. PLT will attempt to burn the OTP memory without running any check. Check empty: PLT will first check if the OTP memory to be burned is empty. If it is empty will burn it. Check if data match: PLT will first check if the memory to be burned is empty. If it is not, it will compare the contents with the data to be burned. If the data are not the same the test will fail without making any changes to the memory. If the data are the same, PLT will not burn the memory to prevent using the OTP repair memory. Skip if written: PLT will read the contents of OTP memory. If it contains any data, it will skip writing without producing any error.								
<ul style="list-style-type: none"> Barcode scanner CSV file Manual data 	<p>Note: Barcode scanner mode is only available with GUI PLT Application. CLI PLT Application does NOT support this feature.</p> <table border="1"> <tr> <td>Scanner interface (Barcode scanner)</td> <td> Selection of the Barcode scanner input. Both HID and COM port interfaces are supported. This list provides an HID and all available COM ports as selectable options. Any HID device is supported that includes newline (CR-LF) characters at the end of the scanned data. For the COM port interface, a common USB to UART barcode scanner is supported. PLT has been tested with Honeywell Xenon 1900. Appendix M describes the setup procedure. This option is the exact same option as in Scan Mode and the DA1469x devices in Custom Memory Data. </td> </tr> <tr> <td>Scan mode (Barcode scanner)</td> <td> Scan DUT position: In this mode, users must first scan the DUT position number and then the BD address. The string for the position of each DUT is "TEST POSITION 0xx". "xx" is the position number. Automatic DUT position: Scanned BD address will be assigned to the selected DUT. The DUT selection is automatically been made, starting from the first active DUT and selecting the next one after a successful BD address scan. Users can change the selected DUT using the controls on the GUI PLT screen shown in Figure 112. This option is the exact same option as in Scan Mode and the DA1469x devices in Custom Memory Data. </td> </tr> <tr> <td>CSV file path (CSV file)</td> <td>Path to the CSV file containing data for each device discriminated using BD addresses. The CSV file format is described in Custom data CSV file format.</td> </tr> <tr> <td>Edit data (Manual data)</td> <td>Hexadecimal data input of up to 256 bytes. These data will be burned to all active DUTs.</td> </tr> </table>	Scanner interface (Barcode scanner)	Selection of the Barcode scanner input. Both HID and COM port interfaces are supported. This list provides an HID and all available COM ports as selectable options. Any HID device is supported that includes newline (CR-LF) characters at the end of the scanned data. For the COM port interface, a common USB to UART barcode scanner is supported. PLT has been tested with Honeywell Xenon 1900. Appendix M describes the setup procedure. This option is the exact same option as in Scan Mode and the DA1469x devices in Custom Memory Data .	Scan mode (Barcode scanner)	Scan DUT position: In this mode, users must first scan the DUT position number and then the BD address. The string for the position of each DUT is "TEST POSITION 0xx". "xx" is the position number. Automatic DUT position: Scanned BD address will be assigned to the selected DUT. The DUT selection is automatically been made, starting from the first active DUT and selecting the next one after a successful BD address scan. Users can change the selected DUT using the controls on the GUI PLT screen shown in Figure 112 . This option is the exact same option as in Scan Mode and the DA1469x devices in Custom Memory Data .	CSV file path (CSV file)	Path to the CSV file containing data for each device discriminated using BD addresses. The CSV file format is described in Custom data CSV file format .	Edit data (Manual data)	Hexadecimal data input of up to 256 bytes. These data will be burned to all active DUTs.
Scanner interface (Barcode scanner)	Selection of the Barcode scanner input. Both HID and COM port interfaces are supported. This list provides an HID and all available COM ports as selectable options. Any HID device is supported that includes newline (CR-LF) characters at the end of the scanned data. For the COM port interface, a common USB to UART barcode scanner is supported. PLT has been tested with Honeywell Xenon 1900. Appendix M describes the setup procedure. This option is the exact same option as in Scan Mode and the DA1469x devices in Custom Memory Data .								
Scan mode (Barcode scanner)	Scan DUT position: In this mode, users must first scan the DUT position number and then the BD address. The string for the position of each DUT is "TEST POSITION 0xx". "xx" is the position number. Automatic DUT position: Scanned BD address will be assigned to the selected DUT. The DUT selection is automatically been made, starting from the first active DUT and selecting the next one after a successful BD address scan. Users can change the selected DUT using the controls on the GUI PLT screen shown in Figure 112 . This option is the exact same option as in Scan Mode and the DA1469x devices in Custom Memory Data .								
CSV file path (CSV file)	Path to the CSV file containing data for each device discriminated using BD addresses. The CSV file format is described in Custom data CSV file format .								
Edit data (Manual data)	Hexadecimal data input of up to 256 bytes. These data will be burned to all active DUTs.								
Memory	Memory type selection to burn the data. Available options are OTP, SPI and EEPROM. Note: For the FLASH and EEPROM memories, the pin configurations are taken from the SPI Flash Configuration and I2C EEPROM Configuration sections. These options must be enabled in order for the <i>Memory Read</i> test to operate successfully.								
Start address	Memory address offset to begin burning the data. DA14531 OTP valid address is 0x0000 to 0x7FFF.								
Data size	The size of the memory data to burn. In barcode scanner, the data size is the number of scanned ASCII characters. In manual data, data size is the number of bytes.								

SmartBond Production Line Tool

7.2.8.4 OTP Configuration Script

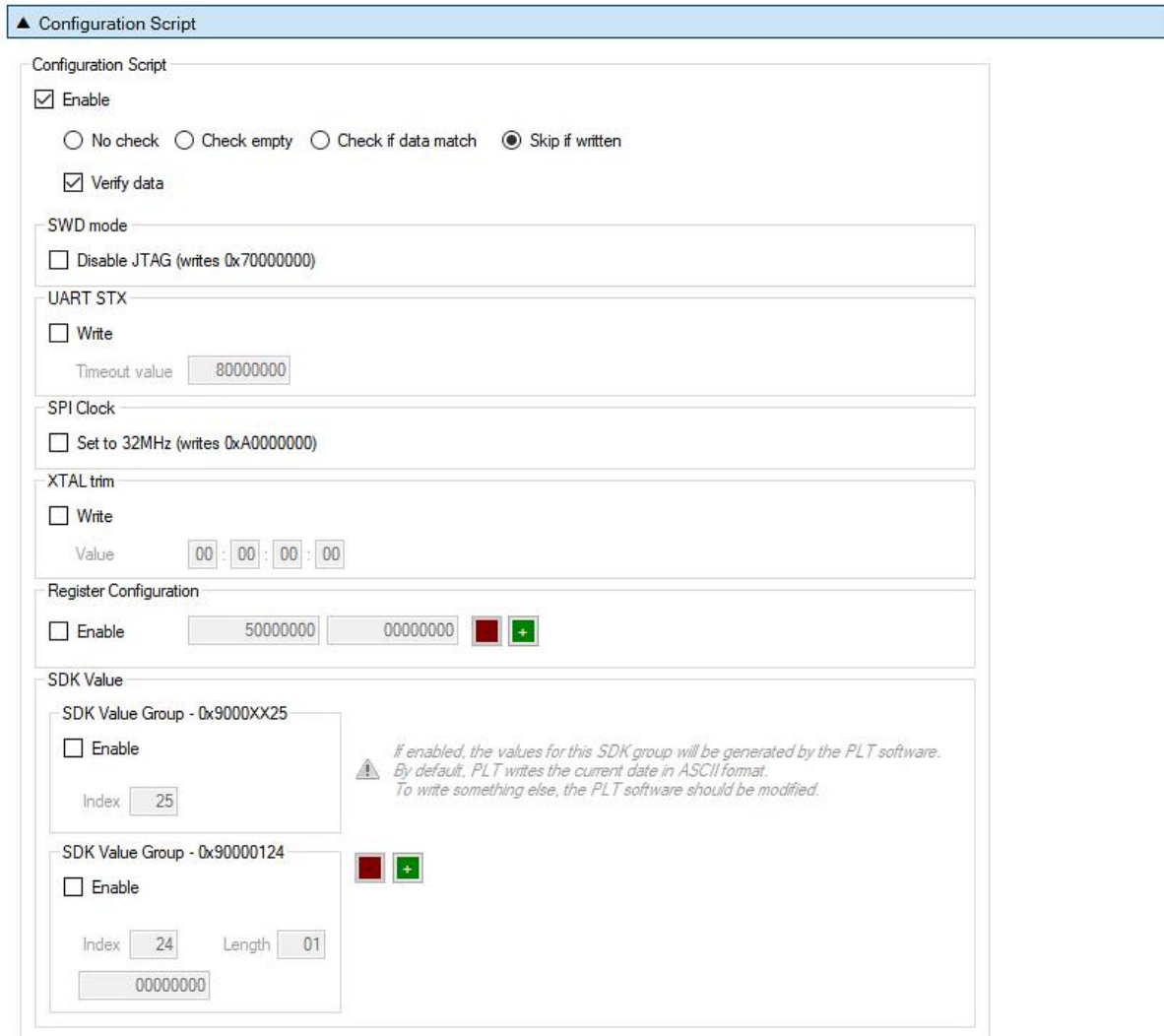

Figure 79: OTP Configuration Script - DA14531

Table 69 describes the *OTP Configuration Script* test options. With this option is enabled user has the option to program the Configuration Script (CS) with appropriate data.

Table 69: OTP Configuration Script - DA14531

Option	Description
Enable	When selected, Configuration Script options will be enabled.
<ul style="list-style-type: none"> No check Check empty Check if data match Skip if written 	<p>OTP memory protection options:</p> <p>No check: No protection is enabled. PLT will attempt to burn the OTP memory without running any check.</p> <p>Check empty: PLT will first check if the OTP memory to be burned is empty. If it is empty will burn it.</p> <p>Check if data match: PLT will first check if the memory to be burned is empty. If it is not, it will compare the contents with the data to be burned. If the data are not the same the test will fail without making any changes to the memory. If the data are the same, PLT will not burn the memory to prevent using the OTP repair memory.</p> <p>Skip if written: PLT will read the contents of OTP memory. If it contains any data, it will skip writing without producing any error.</p>
Verify	When selected, the BD address will be read back from the OTP Header and will be

SmartBond Production Line Tool

Option	Description
	compared to the original.
SWD mode	If selected JTAG will be disabled. Word 0x70000000 will be written in OTP CS.
UART STX	If this option is enabled user can program the STM timeout in multiple of 100ms. So, for example, value 0x80000028 is 40x100 us = 4 ms.
SPI Clock	If this option is enabled, it will overwrite the default 2-MHz clock speed of the SPI boot path and set it to 32 MHz
XTAL trim	User can manually set an XTAL trim calibration value. This value will be applied to all DUTs. It is suggested to have this disabled and use the automatic XTAL trim operation that finds the best trim value for each DUT.
Register Configuration	<p>If this option is enabled, user can program in OTP CS a value that will be set to a specific register during boot. It contains:</p> <ul style="list-style-type: none"> • A 32-bit word containing an address of an existing register • A 32-bit word containing the data value of the register <p>These are always in pairs with the address sitting in even memory addresses.</p>
SDK Value Group - 0x9000YYXX	<p>These are mainly used for device specific calibration values, used by the SDK. It contains one 32-bit word, equal to 0x9000YYXX.</p> <ul style="list-style-type: none"> • 9: Indicates that the following word(s) are not to be stored in registers but will be used by the SDK software. • YY: Length - Indicates that YY amount of words follow • XX: Index - An increasing value, used for indexing by the SW application. If YY > 1, XX will not be increased for the words that belong to the same value.

SmartBond Production Line Tool

7.2.9 DUT Hardware Setup (DA1469x)

7.2.9.1 UART Baud Rate



Figure 80: UART Baud Rate - DA1469x

Table 70 shows the available options for the DA1469x *UART Baud Rate* used during memory programming only.

The *Baud Rate* selected here is used after the firmware (`uartboot_69x.bin`) has been downloaded to the DUT. The software will send a command to the DUT to change the UART baud rate to the one selected. All following UART communications with the DUT will be performed using the new baud rate. Note that this is happening only during memory programming where `uartboot_69x.bin` is used. During tests (RF tests, XTAL trimming, etc.), where the production test firmware is used, the baud rate is fixed to 115200 bit/s.

Table 70: UART Baud Rate - DA1469x

Option	Description
Baud Rate	<ul style="list-style-type: none"> ● 9600 (bit/s) ● 19200 (bit/s) ● 57600 (bit/s) ● 115200 (bit/s) ● 230400 (bit/s) ● 1000000 (bit/s) <p>Note: 1 Mbit/s is the fastest and safest with 0% baud rate error.</p>

7.2.10 Test Settings (DA1469x)

7.2.10.1 VBAT Level Log

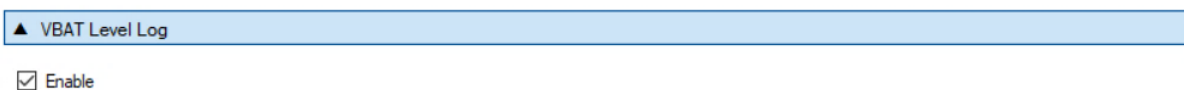

Figure 81: VBAT Level Log - DA1469x

When this feature is enabled, PLT will send a command to the device to measure VBAT using its internal ADC. The VBAT level will then be logged. No, pass or fail limits exist for this test. It is only used for logging purposes.

7.2.10.2 OTP Timestamp Read

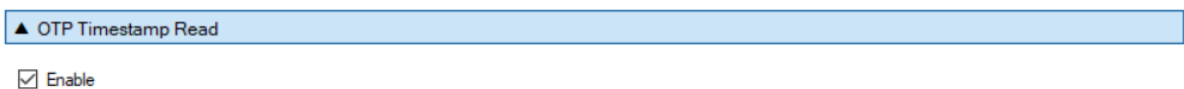

Figure 82: OTP Timestamp Read - DA1469x

If this option is enabled, PLT will read the device timestamp from the OTP memory and log it. This operation is mainly used for logging purposes.

SmartBond Production Line Tool

7.2.10.3 XTAL Trim

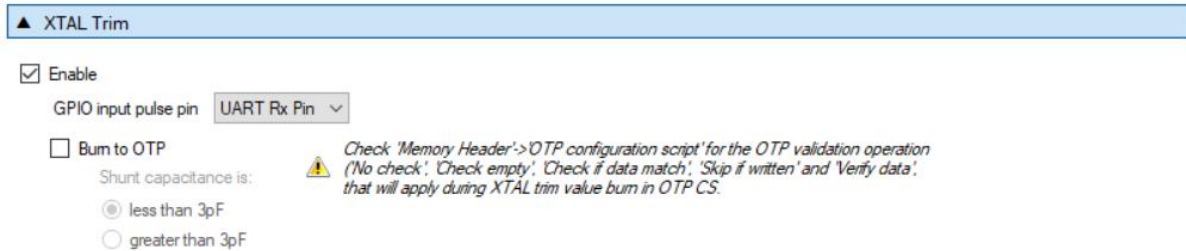

Figure 83: XTAL Trim - DA1469x

Table 71 describes the available options for the DA1469x XTAL Trim operation.

Table 71: XTAL Trim - DA1469x

Option	Description
Enable	This option enables the automatic crystal oscillator frequency calibration procedure.
GPIO input pulse pin	The DUT GPIO to receive the reference pulse during calibration. UART RX pin can be used without any additional connection from the PLT hardware to the DUT.
Burn to OTP	If <i>Burn to OTP</i> option is selected, the XTAL trim value calculated from the automated calibration process will be written in the OTP XTAL trim header field.
Shunt capacitance is: <ul style="list-style-type: none"> Less than 3 pF Greater than 3 pF 	Depending on the 32 MHz crystal oscillator C0 capacitance, additional settings will be burned to the OTP to highly improve boot time. The value of the C0 capacitance can be found from the crystal oscillator datasheet.

7.2.10.4 GPIO Watchdog operation

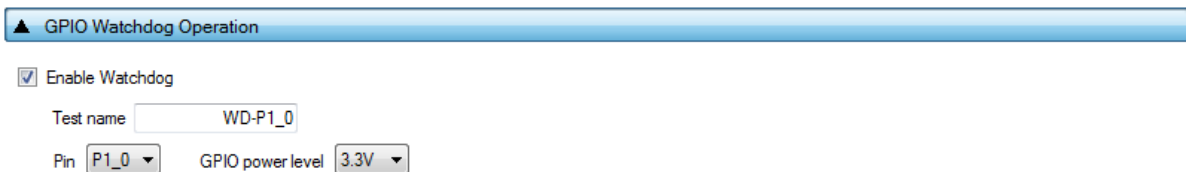

Figure 84: GPIO Watchdog operation - DA1469x

Table 72 describes the available options for the DA1469x GPIO Watchdog operation.

Table 72: GPIO Watchdog operation - DA1469x

Option	Description
Enable Watchdog	This option enables the continuous toggling of a GPIO during the whole production testing and memory programming procedure, except during firmware download. The pulse on the GPIO has approximately 0.75 % duty cycle and 0.5 Hz frequency. Note: Production test firmware is downloaded through <code>uartboot_69x</code> firmware. After the <code>uartboot_69x</code> firmware is downloaded, the watchdog pin will be pulsed.
Test name	The name assigned for this test.
Pin	Select the GPIO that will be toggled.
GPIO power level	Sets the power level of the GPIOs.

SmartBond Production Line Tool

7.2.10.5 Scan DUT Advertise Test

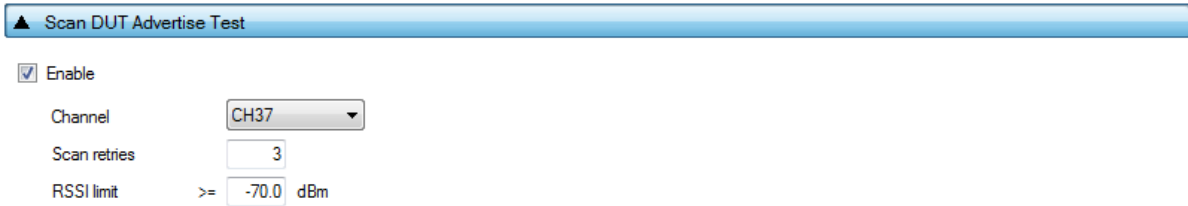

Figure 85: Scan DUT Advertise Test - DA1469x

Table 73 describes the available options for the DA1469x *Scan DUT Advertise Test* operation.

Table 73: Scan DUT Advertise Test - DA1469x

Option	Description
Enable	This option enables the <i>Scan DUT Advertise Test</i> operation.
Channel	The BLE channel frequency used in the RF RX test using the Golden Unit.
Scan retries	The number of retries to perform the test.
RSSI limit	The RSSI limit for pass/fail criteria in the RF RX test using the Golden Unit. If the average RSSI of the device, after it has received the packets transmitted from the Golden Unit is less than that the test will be considered as failed.

7.2.10.6 RF Tests

This section refers to various RF tests conducted between the DUTs and the Golden Unit or an external BLE tester.

The following tests can have multiple instances with different settings. Tests can be added and removed using the two buttons (e.g. and in Figure 86) at the bottom right side of each panel.

Note: When adding or removing a test all settings are refreshed with the values written to the XML file, meaning that any unsaved settings will be lost.

Golden Unit

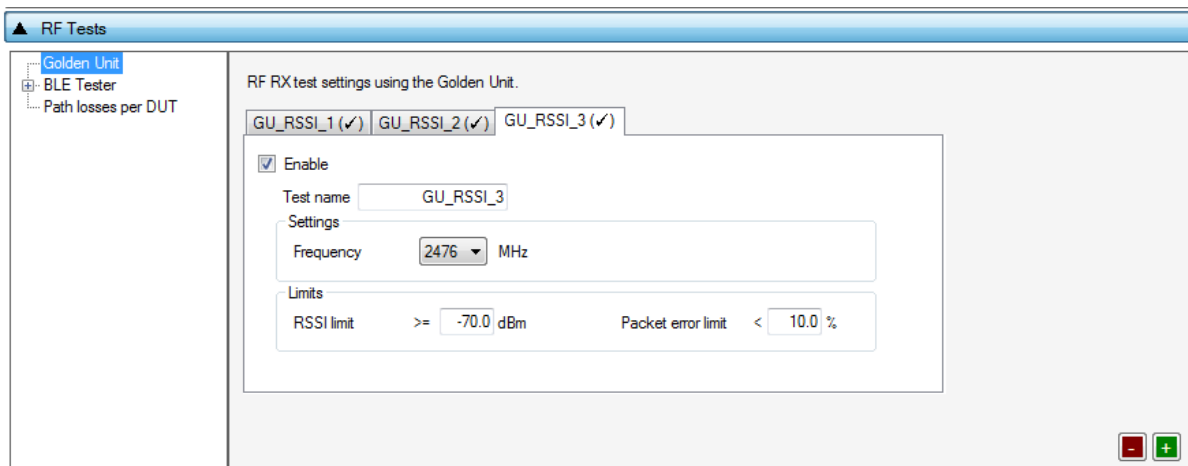

Figure 86: Golden Unit RF Tests - DA1469x

Table 74 describes the available options for the DA1469x *RF RX* test using the *Golden Unit* as a transmitter.

SmartBond Production Line Tool

In the RF RX test, the Golden Unit sends 500 packets. The DUTs are set in receive mode and the RSSI is measured. If the RSSI measured by the DUT reception is less than the specified *RSSI limit*, the device will fail and the tests will stop for that particular device.

Table 74: Golden Unit RF Tests - DA1469x

Option	Description
Enable	This option enables the specific RF RX test using the Golden Unit as a transmitter.
Test name	The name assigned to each test. The assigned name will be shown on the tab and next to it an indication showing whether the specific test is enabled or not.
Frequency	The BLE channel frequency used in the RF RX test using the Golden Unit.
RSSI limit	The RSSI limit for pass/fail criteria in the RF RX test using the Golden Unit. If the average RSSI of the device after it has received the packets transmitted from the Golden Unit is less than this value, the test will be considered as failed.
Packet error limit	This configures the PER limit for pass/fail criteria. If the percentage of the correct packets received is less than the value entered here, the test will fail.

BLE Tester

In the *BLE Tester* panels, a number of tests can be enabled that require an external BLE tester instrument. More detailed information about the BLE tester can be found in [1]

BLE Tester - General

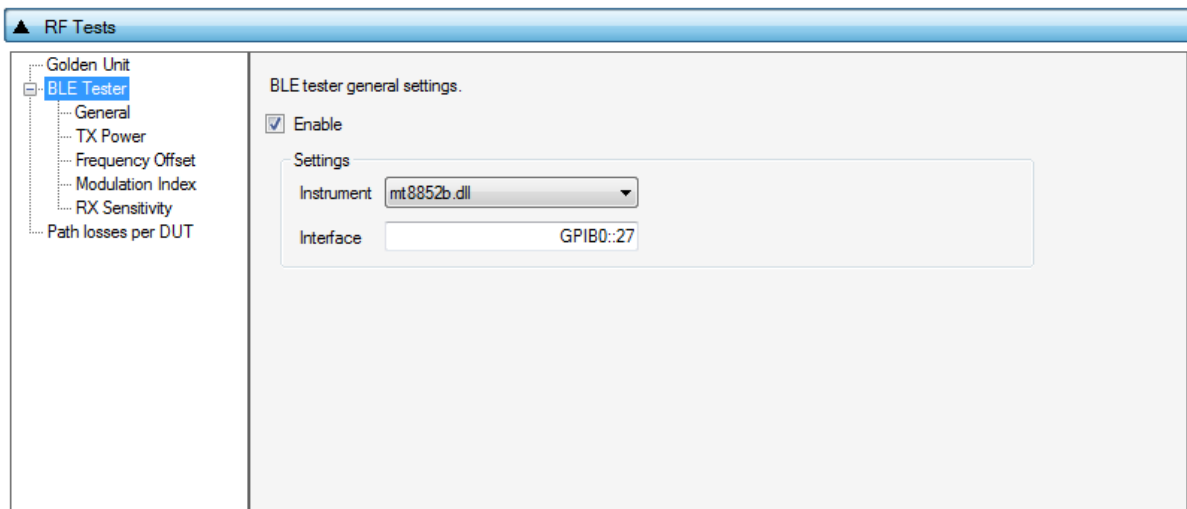

Figure 87: BLE Tester General Settings - DA1469x

Table 75 describes the *General* settings for the *BLE Tester* supported tests. Any available external instrument found by the `ble_tester_driver` DLL and their interfaces can be selected.

Table 75: BLE Tester General Settings - DA1469x

Option	Description
Enable	This option enables all of the <i>BLE Tester</i> tests, which include: <ul style="list-style-type: none"> • BLE Tester TX Power • Frequency Offset • Modulation Index • RX Sensitivity

SmartBond Production Line Tool

Option	Description
Instrument	Selects the BLE tester DLL. Names are shown only if a BLE tester instrument DLL exists in the project folder <code>ble_tester_instr_plugins</code> .
Interface	The interface of the instrument to be used by the driver.

BLE Tester - TX Power

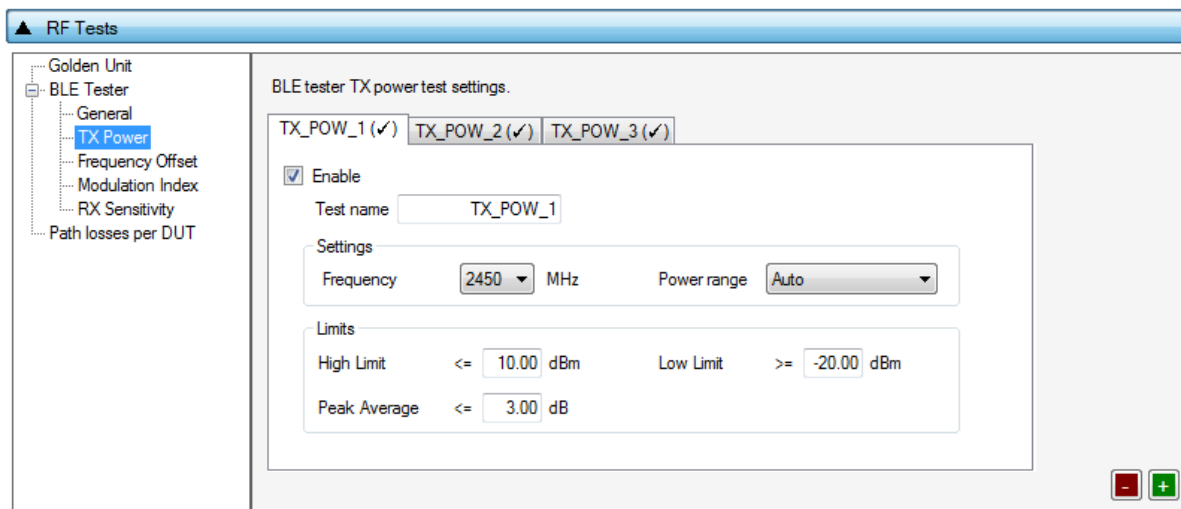

Figure 88: BLE Tester TX Power - DA1469x

Table 76 describes the available options for the DA1469x TX Power test using a BLE Tester instrument.

Table 76: BLE Tester TX Power - DA1469x

Option	Description
Enable	This option enables the specific TX power test using a BLE tester instrument.
Test name	The name assigned to each test. The assigned name will be shown on the tab and next to it an indication showing whether the specific test is enabled or not.
Frequency	The BLE channel frequency used in the BLE TX power test.
Power range	Set the device TX output power range. Available options are: <ul style="list-style-type: none"> • Auto (No auto option for Litepoint IQxel-M. Sets the instrument to trigger at -25 dBm) • +22 dBm to +7 dBm • +9 dBm to -3 dBm • +5 dBm to -7 dBm • -4 dBm to -16 dBm • -12 dBm to -26 dBm • -24 dBm to -35 dBm Default value is <i>Auto</i> .
High limit	Set the average high power limit for the BLE TX output power pass/fail test criteria.
Low limit	Set the average low power limit for the BLE TX output power pass/fail test criteria.
Peak average	Set the peak-to-average power limit for the BLE TX output power pass/fail test criteria.

SmartBond Production Line Tool

BLE Tester - Frequency Offset

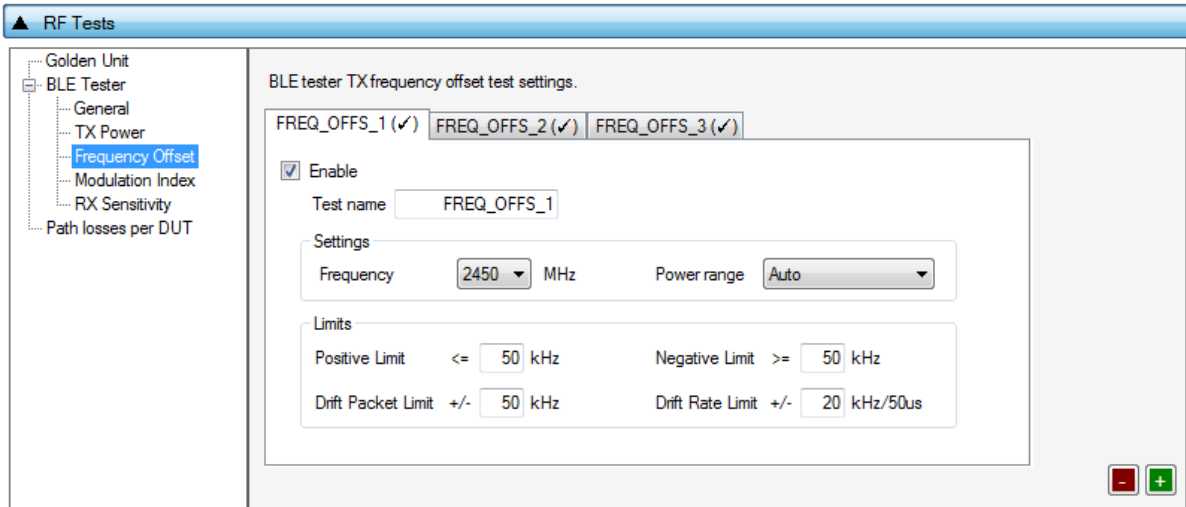

Figure 89: BLE Tester Frequency Offset - DA1469x

Table 77 describes the available options for the *Frequency Offset* test using a BLE Tester instrument.

Table 77: BLE Tester Frequency Offset - DA1469x

Option	Description
Enable	This option enables the specific TX frequency offset test using a BLE tester instrument.
Test name	The name assigned to each test. The assigned name will be shown on the tab and next to it an indication showing whether the specific test is enabled or not.
Frequency	The BLE channel frequency used in the BLE TX frequency offset test.
Power range	Set the device TX output power range. Available options are: <ul style="list-style-type: none"> • Auto • +22 dBm to +7 dBm • +9 dBm to -3 dBm • +5 dBm to -7 dBm • -4 dBm to -16 dBm • -12 dBm to -26 dBm • -24 dBm to -35 dBm Default value is <i>Auto</i> .
Positive limit	Set the maximum positive offset limit in kHz for the TX carrier frequency offset pass/fail test criteria.
Negative limit	Set the maximum negative offset limit in kHz for the TX carrier frequency offset pass/fail test criteria.
Drift packet limit	Set the overall packet drift in kHz for the TX drift pass/fail test criteria.
Drift rate limit	Set the drift rate limit in kHz/50 μs for the TX drift pass/fail test criteria.

SmartBond Production Line Tool

BLE Tester - Modulation Index

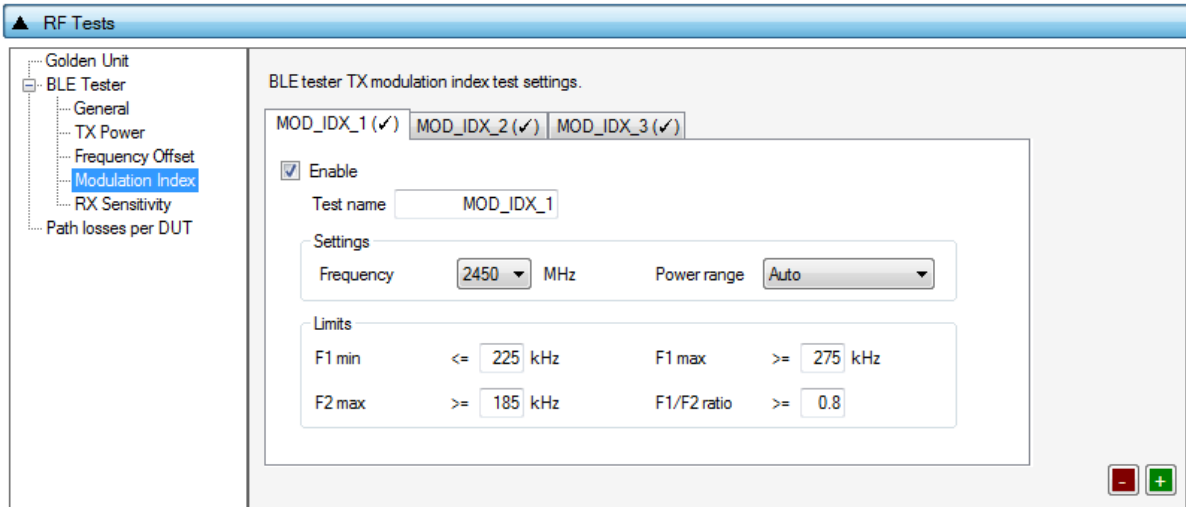

Figure 90: BLE Tester Modulation Index - DA1469x

Table 78 describes the available options for the *Modulation Index* test using a BLE Tester instrument.

Table 78: BLE Tester Modulation Index - DA1469x

Option	Description
Enable	This option enables the specific TX modulation index test using a BLE tester instrument.
Test name	The name assigned to each test. The assigned name will be shown on the tab and next to it an indication showing whether the specific test is enabled or not.
Frequency	The BLE channel frequency used in the BLE TX modulation index offset test.
Power range	Set the device TX output power range. Available options are: <ul style="list-style-type: none"> • Auto • +22 dBm to +7 dBm • +9 dBm to -3 dBm • +5 dBm to -7 dBm • -4 dBm to -16 dBm • -12 dBm to -26 dBm • -24 dBm to -35 dBm Default value is <i>Auto</i> .
F1 min	Set the F1 minimum average limit in kHz for the TX modulation index pass/fail test criteria.
F1 max	Set the F1 maximum average limit in kHz for the TX modulation index pass/fail test criteria.
F2 max	Set the F2 maximum limit in kHz for the TX modulation index pass/fail test criteria.
F1/F2 ratio	Set the F1/F2 maximum average ratio limit for the TX modulation index pass/fail test criteria.

SmartBond Production Line Tool

BLE Tester - RX Sensitivity

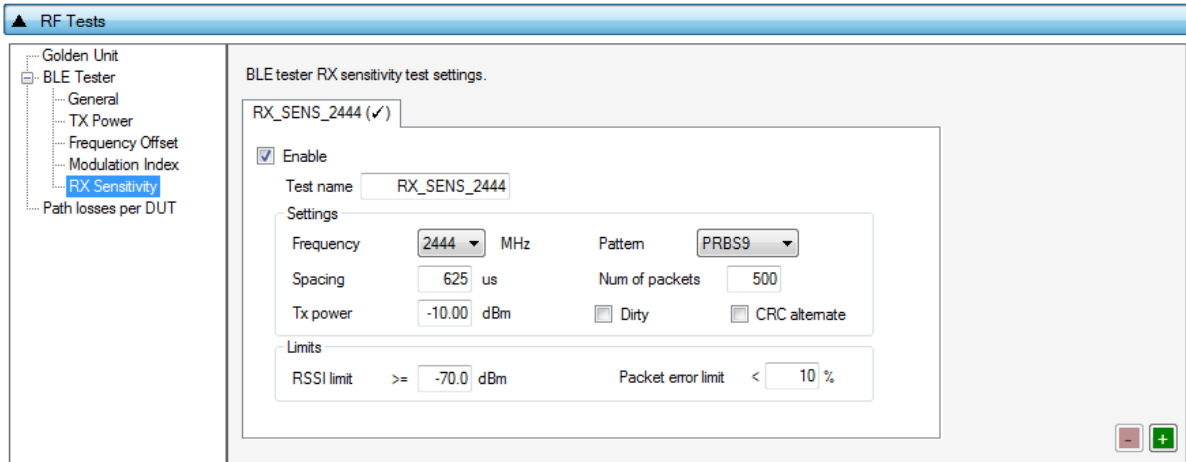

Figure 91: BLE Tester RX Sensitivity - DA1469x

Table 79 describes the available options for the *RX Sensitivity* test using a BLE Tester instrument.

Table 79: BLE Tester RX Sensitivity - DA1469x

Option	Description
Enable	This option enables the specific RX sensitivity test using a BLE tester instrument.
Test name	The name assigned to each test. The assigned name will be shown on the tab and next to it an indication showing whether the specific test is enabled or not.
Frequency	The BLE channel frequency used in the BLE RX sensitivity test.
Pattern	The bit pattern of the TX data. Available options are: <ul style="list-style-type: none"> • PRBS9 • 10101010 • 11110000
Spacing	The packet spacing in μ s.
Num of packets	The number of packets the BLE tester instrument to transmit.
Tx power	The TX output power of the BLE tester instrument. Suggested values are 0 to -10 dBm.
Dirty	When enabled, the BLE tester packet generator can use a dirty table to transmit.
CRC alternate	When enabled, the BLE tester will alternately send packets with CRC correct and CRC incorrect.
RSSI limit	The RSSI limit for pass/fail criteria in the RF RX sensitivity test. If the average RSSI of the device after it has received the transmitted packets is less than this value, the test will be considered as failed.
Packet error limit	This configures the PER limit for pass/fail criteria. If the percentage of the correct packets received is less than the value entered here, the test will fail.

SmartBond Production Line Tool

Path Losses per DUT

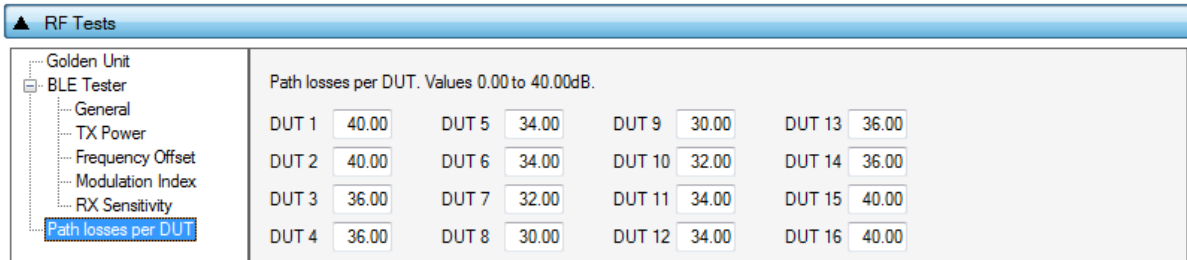

Figure 92: Path Losses per DUT - DA1469x

Table 80 describes the available options for the *Path losses per DUT*.

Based on the relative position of each DUT during RF tests and since the RF tests are performed over the air, values can be used to correct for any path losses. These values are added to the limits of the TX Power and RF RX RSSI tests. Additional information can be found in [Appendix D](#) and [Appendix F](#).

Table 80: Path Losses per DUT from RF Tests DA1469x Options

Option	Description
DUT1-16	Set the path loss value for each DUT. These will be added as corrections to the limits of the TX Power and RF RX RSSI tests

7.2.10.7 GPIO/LED Test

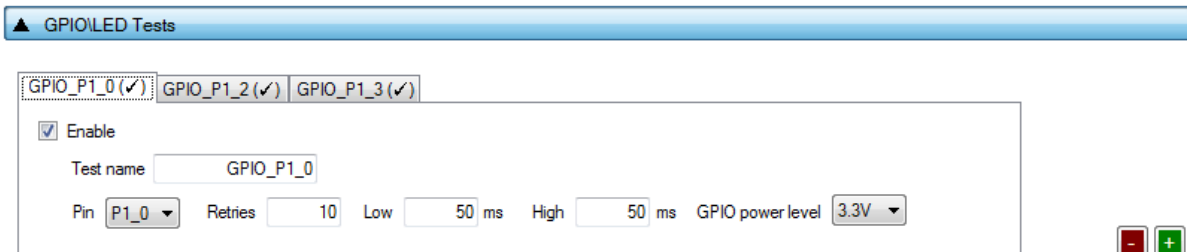

Figure 93: GPIO/LED Tests - DA1469x

GPIO/LED Tests can have multiple instances with different settings. Tests can be added or removed using the two buttons (e.g. and in Figure 93) at the bottom right side of each panel.

Note: When adding or removing a test, all settings are refreshed with the values written to the XML file, meaning that any unsaved settings will be lost.

Table 81 describes the available options for the *GPIO/LED Tests* DA1469x Options.

In these tests, a specific pulse can be given to a GPIO and any LED connected to it can be visually tested. The *Pin* option sets the GPIO to be used, *Low* and *High* define the duty cycle and the *Retries* the number of pulses.

Table 81: GPIO/LED Tests - DA1469x

Option	Description
Enable	This option enables the GPIO/LED toggling. Can be used for visual LED testing.
Test name	The name assigned to each test. The assigned name will be shown on the tab and next to it an indication showing whether the specific test is enabled or not.
Pin	The GPIO that will be used for the specific test.

SmartBond Production Line Tool

Option	Description
Retries	Number of pulses to be generated for the specific test.
Low	Sets the amount of the OFF time of the pulse in ms for the specific test.
High	Sets the amount of the ON time of the pulse in ms for the specific test.
GPIO power level	Sets the power level of the GPIOs.

7.2.10.8 GPIO Connection Test

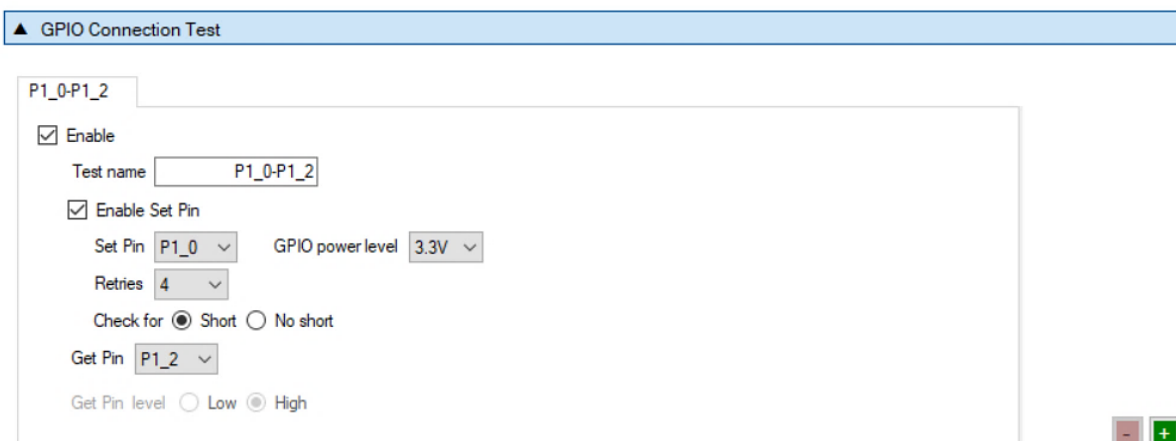

Figure 94: GPIO Connection Test - DA1469x

GPIO Connection Tests can have multiple instances with different settings. Tests can be added and removed using the two buttons (e.g. and in Figure 63) at the bottom right side of each panel.

Note: When adding or removing a test all settings are refreshed with the values written to the XML file, meaning that any unsaved settings will be lost.

Table 82 describes the available options for the DA1469x GPIO Connection Test.

When enabled, the PLT software will check the connection of the specified GPIO (Get Pin) by either checking its state or the connection with another pin (Set Pin). In the latter case, the user gives the Set Pin and the state to check. It will also check for shorts between given GPIOs.

Table 82: GPIO Connection Test - DA1469x

Option	Description
Enable	This option enables the specific custom test.
Test name	The name assigned to each test. The assigned name will be shown on the tab and next to it an indication showing whether the specific test is enabled or not.
Enable Set Pin	Enables the use of the secondary GPIO to drive the GPIO under test. When this option is set, the Get Pin level option will be disabled.
Set Pin	Select the GPIO to be tested
GPIO power level	The output GPIO power level, 3.3 V or 1.8 V.
Retries	How many times the software will check for GPIO connection or short. In every retry it will change the Set Pin level and check the Get Pin level.
Check for Short/No short	If Short is selected, PLT will check whether the Set Pin has the same level with the Get Pin for all Retries tested. If No short is selected, PLT will check whether Get Pin is always low no matter what the Set Pin level is.
Get Pin	Select the GPIO to be tested.

SmartBond Production Line Tool

Option	Description
Get Pin level	Sets the GPIO state the test awaits to see in the <code>Get Pin</code> . This option is disabled if the Set Pin mode is enabled.

7.2.10.9 Sensor Test

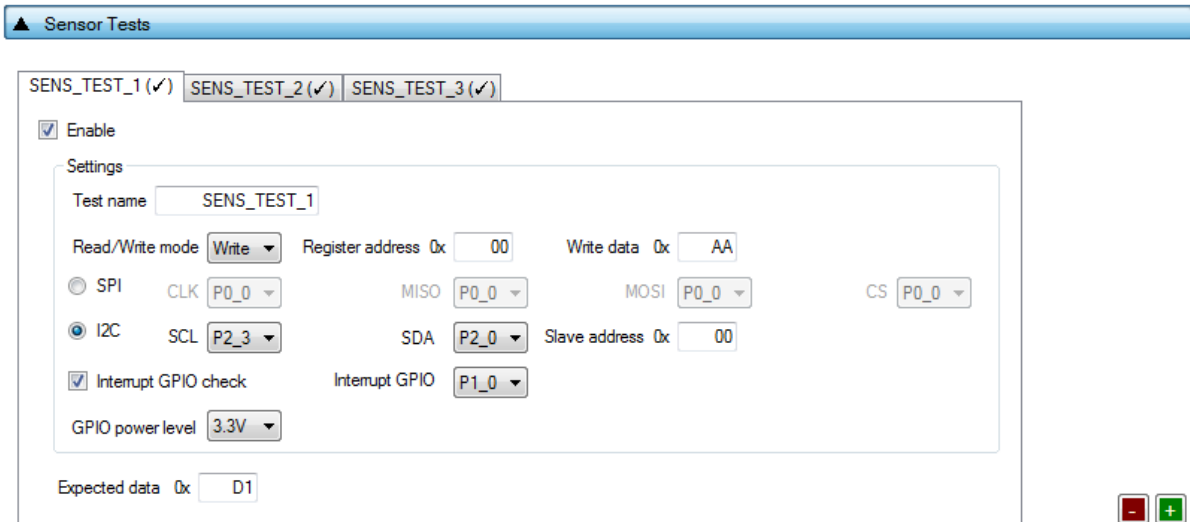

Figure 95: Sensor Test - DA1469x

Sensor Tests can have multiple instances with different settings. Tests can be added and removed using the two buttons (e.g. and in Figure 95) at the bottom right side of each panel.

Note: When adding or removing a test all settings are refreshed with the values written to the XML file, meaning that any unsaved settings will be lost.

Table 83 describes the available options for the Sensor Tests DA1469x Options.

Table 83: Sensor Tests - DA1469x

Option	Description
Enable	This option enables the specific sensor test.
Test name	The name assigned to each test. The assigned name will be shown on the tab and next to it an indication showing whether the specific test is enabled or not.
Read / Write mode	Select the sensor test procedure, to read or write.
Register address	The sensors register address to read or write data.
Write data	The byte to be written at the sensor register.
SPI / I2C	Select the interface that the sensor is connected to.
SPI - CLK	Select the GPIO for the sensor SPI CLK.
SPI - MISO	Select the GPIO for the sensor SPI MISO.
SPI - MOSI	Select the GPIO for the sensor SPI MOSI.
SPI - CS	Select the GPIO for the sensor SPI CS.
I2C - SCL	Select the GPIO for the sensor I2C SCL.
I2C - SDA	Select the GPIO for the sensor I2C SDA.
Slave address	The sensor I2C bus slave address.
Interrupt GPIO check	Enables the sensor interrupt signal test via GPIO.

SmartBond Production Line Tool

Option	Description
Interrupt GPIO	Select the GPIO to be used as a sensor interrupt.
GPIO power level	Sets the power level of the GPIOs.
Expected data	The received sensor byte that will be expected on a successful operation.

7.2.10.10 Custom Test

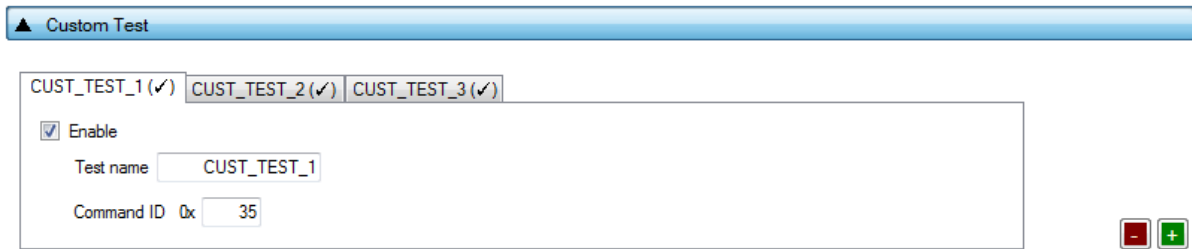

Figure 96: Custom Test - DA1469x

Custom tests can have multiple instances with different settings. Tests can be added and removed using the two buttons (e.g. and in Figure 96) at the bottom right side of each panel.

Note: When adding or removing a test all settings are refreshed with the values written to the XML file, meaning that any unsaved settings will be lost.

Table 84 describes the available options for the DA1469x Custom Tests.

When enabled, the PLT software will send an HCI command through UART to activate a customer-defined test that will run on the DUTs. The HCI custom test command will contain a single byte as data (the *Command ID* byte), to be used mainly as identification for a specific test in the firmware. Default functionality of the production test firmware is to respond with the same *Command ID*. Otherwise, the test will be considered as failed.

Table 84: Custom Tests DA1469x Options

Option	Description
Enable	This option enables the specific custom test.
Test name	The name assigned to each test. The assigned name will be shown on the tab and next to it an indication showing whether the specific test is enabled or not.
Command ID	The byte that will be sent to the device running the production test firmware.

7.2.10.11 External 32 kHz Test



Figure 97: External 32 kHz Test - DA1469x

Table 85 describes the available options for the DA1469x External 32 kHz Tests.

Table 85: External 32 kHz Tests DA1469x Options

Option	Description
Enable	This option enables the external 32 kHz low power clock test.

SmartBond Production Line Tool

7.2.10.12 Current Measurement Test

▲ Current Measurement Test

Current measurement general settings

Enable

Settings

Instrument ▼

Interface

Enable single DUT current measurement when failed

Peripheral Current Measurement

Periph Test 1

Enable

Test name

Single Device

Ammeter Setup

Settings

Shunt resistor Ohms Wait time mSecs

Range Amps Resolution Amps

Samples SCPI cmd

Limits per device

Upper limit <= Amps

Low limit >= Amps

Test Options

GPIO

GPIO Pin ▼ GPIO state ▼ GPIO power level ▼

PWM frequency KHz PWM duty %

Custom Test

Start Command ID 0x Stop Command ID 0x

- +

Sleep Current Measurement

Enable

Settings

Single device

Sleep mode Extended Deep

Shunt resistor Ohms Wait time mSecs Sleep time Secs

Range Amps Resolution Amps Up to 1200s of sleep time is supported.

Samples SCPI cmd

Limits per device

Upper limit <= Amps

Low limit >= Amps



Figure 98: Current Measurement Tests - DA1469x

In this test, an external ammeter can be used to measure the total current consumption of all active DUTs. The ammeter can be connected in the blue banana plugs as described in [Current Measurements](#) or to an external power supply (if present) depending the selected [VBAT/Reset Mode](#).

SmartBond Production Line Tool

During measurement, PLT will control the instrument using the `ammeter_driver` DLL [1]. Table 86 describes the instrument selection settings found by the `ammeter_driver` DLL, Table 87 describes the settings used for each of the peripheral current measurement tests and Table 88 describes the current measurement options for each sleep state.

Note: Modifications in the production test firmware are mandatory in order to achieve the correct current consumption of a specific hardware design (IC and peripherals) for each sleep state. Running the default firmware without any modifications specific for the hardware design, may cause increased current consumption.

Peripheral Current Measurement Tests can have multiple instances with different settings. Tests can be added and removed using the two buttons (e.g.  and  in Figure 98) at the bottom right side of each panel.

Note: When adding or removing a test, all settings are refreshed with the values written to the XML file, meaning that any unsaved settings will be lost.

Table 86: Current Measurement Tests - DA1469x

Option	Description
Enable	This option enables all Current Measurement tests, which include: <ul style="list-style-type: none"> Peripheral current measurements Extended sleep current measurement Deep sleep current measurement Only one of the Extended/Deep sleep current measurements can be selected.
Instrument	Select the Ammeter instrument DLL name. Names are shown only if an ammeter DLL exists in the project <code>ammeter_instr_plugins</code> folder.
Interface	The interface of the instrument to be used by the driver.
Enable single DUT current measurement when failed	If this option is enabled and if the measurement taken is outside of the limits, PTL will reset all devices and begin a firmware download and measure the current to each device separately, in order to identify which exact device failed.

Table 87: Current Measurement Test – Peripheral Current Measurement - DA1469x

Option	Description
Enable	This option enables the specific peripheral current measurement test.
Test name	The name assigned to each test. The assigned name will be shown on the tab and next to it an indication showing whether the specific test is enabled or not.
Single Device	If this option is enabled, PLT will measure the current consumption one device at the time. Initially, it will power off all DUTs. It will then power on one by one, download firmware and measure the current individually. This procedure takes a lot of time. It should only be used for production setup purposes, to identify the correct limits by measuring multiple DUTs and taking the average.
Shunt resistor	The value of the shunt resistor used for peripheral measurement. Applicable only if a voltmeter or a NI-DAQ is used to measure current instead of a DMM. Values from 0 to 9999 are supported.
Wait time	The time in ms the PLT will wait before taking a current measurement, after it has sent an instruction to the DUTs to go into a specific sleep state. Supported values are 1 to 500000 ms.
Range	The range value in Ampere units that the ammeter will operate. Supported values are 0 to 9999 and default value is 0.001 A. When the <code>ammeter_sspi.dll</code> is used, if this value is set to zero, the instrument will use the automatic range functionality.
Resolution	The ammeter resolution value in Ampere units.
Samples	The number of samples that the ammeter will read and average. 1 to 1000 is

SmartBond Production Line Tool

Option	Description	
	supported.	
SCPI cmd	An SCPI command to be passed to the ammeter just before the measurement is taken. Supports multiple commands separated with a column. Up to 256 characters are supported.	
Upper limit	<p>The upper limit value of the peripheral current measurement test procedure, for a single DUT.</p> <p>Next to this input field the total upper limit current consumption for all the enabled DUTs is shown, which is the value to be used during testing.</p> <p>Note: During testing, some DUTs may fail until the current measurement test takes place. In that case, the PLT will automatically re-calculate the total upper limit by using the value given for a single DUT multiplied with the number of the active DUTs at the time that the test will run.</p>	
Low limit	<p>The low limit value of the peripheral current measurement test, for a single DUT.</p> <p>Next to this input field the total upper limit current consumption for all the enabled DUTs is shown, which is the value to be used during testing.</p> <p>Note: During testing, some DUTs may fail until the current measurement test takes place. In that case, the PLT will automatically re-calculate the total low limit by using the value given for a single DUT multiplied with the number of the active DUTs at the time that the test will run.</p>	
Test Options	<p>Select between a PWM GPIO test and custom test.</p> <p>Note: For the custom tests to work, a modified production test firmware must be created with tests that set the DUTs to specific states before the current measurement test. Each test must be assigned to a specific opcode. The custom tests are the exact same as in Custom Test.</p>	
Test Options - GPIO	Pin	Sets the GPIO to toggle with the PWM pulse.
	GPIO state	Sets the active state of the GPIO.
	GPIO power level	Sets the power level of the GPIOs.
	PWM frequency	Sets the PWM frequency.
	PWM duty	Sets the PWM duty cycle.
Test Options – Custom Test	Start Command ID	The opcode of the custom test that sets the state of the DUT.
	Stop Command ID	The opcode of the custom test that restores the DUT to its original state.

Table 88: Current Measurement Test - Sleep Current Measurement - DA1469x

Option	Description
Enable	This option enables the sleep current measurement using the ammeter provided in the <i>Instrument</i> section.
Single Device	If this option is enabled, PLT will measure the current consumption, one device at the time. Initially, it will power off all DUTs. It will then power on one by one, download firmware and measure the current individually. This procedure takes a lot of time. It should only be used for production setup purposes, to identify the correct limits by measuring multiple DUTs and taking the average.
Sleep mode	User can select either the Extended or the Deep sleep mode.
Shunt resistor	The value of the shunt resistor used for sleep current measurement. Applicable only if a voltmeter or a NI-DAQ is used to measure current instead of a DMM. Values from 0 to 9999 are supported.
Wait time	The time in ms the PLT will wait before taking a current measurement, after it has sent an instruction to the DUTs to go into a specific sleep state. Supported values are 1 to 500000 ms.
Sleep time (only for	The time in seconds that the DUTs will remain in extended sleep mode. A timer in the production test firmware will wake up the devices and set them to idle mode. Supported

SmartBond Production Line Tool

Option	Description
extended sleep)	values are 1 to 9 sec for DA14580/1/2/3 and up to 1200 sec for the rest.
Range	The range value in Ampere units that the ammeter will operate. Supported values are 0 to 9999 and default value is 0.001 A. When the <code>ammeter_sspi.dll</code> is used, if this value is set to zero, the instrument will use the automatic range functionality.
Resolution	The ammeter resolution value in Ampere units.
Samples	The number of samples that the ammeter will read and average. 1 to 1000 is supported.
SCPI cmd	An SCPI command to be passed to the ammeter just before the measurement is taken. Supports multiple commands separated with a column. Up to 256 characters are supported.
Upper limit	The upper limit value for the sleep current measurement test procedure, for a single DUT. Next to this input field the total upper limit current consumption for all the enabled DUTs is shown, which is the value to be used during testing. Note: During testing, some DUTs may fail until the current measurement test takes place; in that case, the PLT will automatically re-calculate the total upper limit by using the value given for a single DUT multiplied with the number of the active DUTs at the time that the test will run.
Low limit	The low limit value for the sleep current measurement test procedure, for a single DUT. Next to this input field the total upper limit current consumption for all the enabled DUTs is shown, which is the value to be used during testing. Note: During testing, some DUTs may fail until the current measurement test takes place; in that case, the PLT will automatically re-calculate the total low limit by using the value given for a single DUT multiplied with the number of the active DUTs at the time that the test will run.

7.2.10.13 Temperature Measurement Test

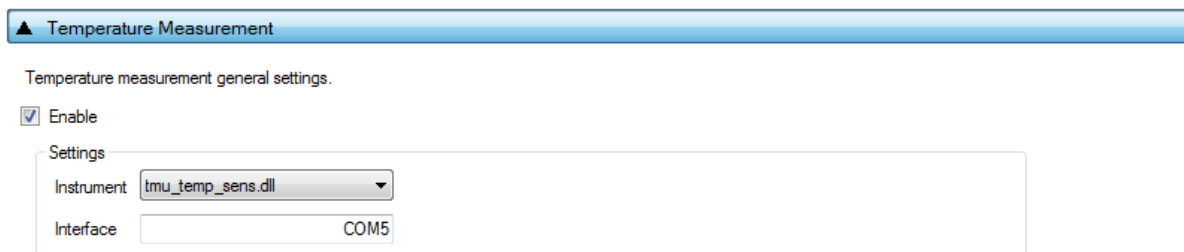

Figure 99: Temperature Measurement Test - DA1469x

Table 89 describes the available options for the DA1469x *Temperature Measurement Test*.

Table 89: Temperature Measurement Test - DA1469x

Option	Description
Enable	This option enables the Temperature measurement test.
Instrument	Select the Temperature measurement DLL. Names are shown only if a Temperature measurement instrument DLL exists in the project folder <code>temp_meas_instr_plugins</code> .
Interface	The interface of the instrument to be used by the driver.

SmartBond Production Line Tool

7.2.10.14 Scan Test

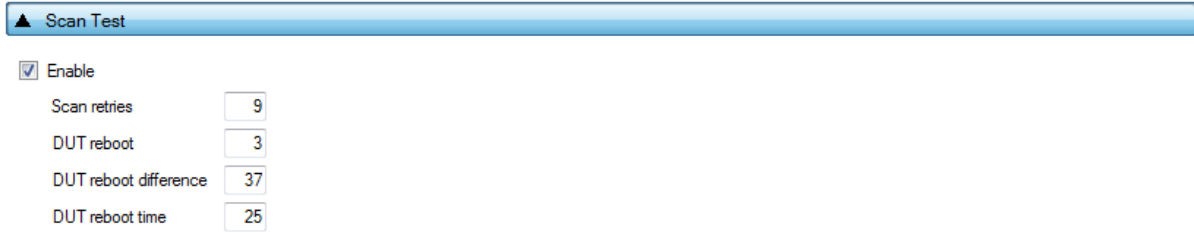

Figure 100: Scan Test - DA1469x

Table 90 describes the available options for the DA1469x Scan Test.

By enabling this test, the Golden Unit will scan for the DUT's BD addresses advertised after the customer firmware has been burned. For this test to work, a bootable firmware with the ability to advertise with the BD address given by the PLT must be burned into each DUT. Additionally, the BD addresses provided by the PLT should be burned into OTP memory or QSPI memory such that the devices advertise with the BD addresses the tool uses.

Table 90: Scan Test DA1469x Options

Option	Description
Enable	This option enables the Scan test.
Scan retries	The total number of BLE advertising scans the Golden Unit will perform.
DUT reboot	Define after how many retries the PLT will reboot the DUTs.
DUT reboot difference	Set the time difference between each DUT when the PLT reboots the devices, in order to avoid air collisions.
DUT reboot time	The time the VBAT will remain low during the device reboot. This value is time in ms*100 (e.g. 15 is 1500 ms).

SmartBond Production Line Tool

7.2.11 Memory Functions (DA1469x)

This section describes the Memory Functions settings available when using DA1469x devices. Memory functions include OTP and QSPI Flash memory programming.

7.2.11.1 OTP Memory

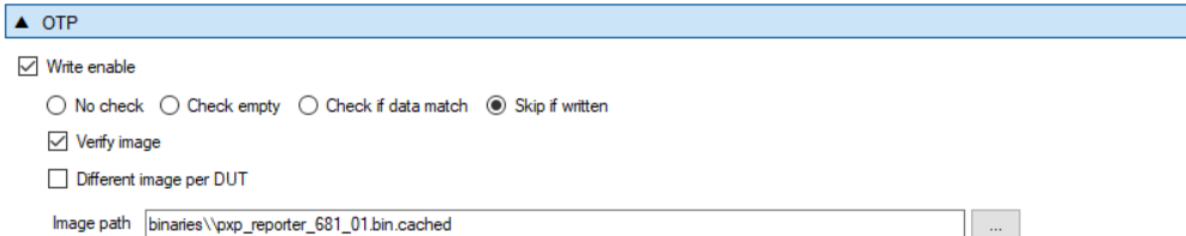

Figure 101: OTP Memory - DA1469x

This test enables the OTP memory programming. Table 91 describes the available options for the *OTP Memory* image write operation.

Note: If the binary is larger than the available OTP image area (OTP memory excluding the header area), the PLT software will split the binary into two parts. The first part will contain only the OTP image area. The second part will contain the OTP header fields, split in OTP words. PLT will burn the non-zero words one by one, as single OTP entries in the OTP header area. The check empty feature will handle the first part as an OTP image binary. The second part will be checked word by word.

Table 91: OTP Memory - DA1469x

Option	Description
Write enable	This option enables the OTP image write operation.
<ul style="list-style-type: none"> • No check • Check empty • Check if data match • Skip if written 	Memory protection options: No check: No protection is enabled. PLT will attempt to burn the OTP memory without running any check. Check empty: PLT will first check if the OTP memory to be burned is empty. If it is empty will burn it. Check if data match: PLT will first check if the memory to be burned is empty. If it is not, it will compare the contents with the data to be burned. If the data are not the same the test will fail without making any changes to the memory. If the data are the same, PLT will not burn the memory to prevent using the OTP repair memory. Skip if written: PLT will read the contents of OTP memory. If it contains any data, it will skip writing without producing any error.
Verify image	If this option is enabled, PLT will read back the contents of the OTP memory and compare them to the original image file. If these do not match it will fail.
Different image per DUT	If this option is selected, a different image per DUT can be burned into the OTP. The image name must be specific for each DUT, as described below.
Image path	Via this field, the user specifies the image file to be burned into the OTP. A .bin binary file of any name can be selected. Depending on the size of the selected binary, PLT will inform the user if the binary contains both the image and the header part or if it exceeds the maximum supported size. If option <i>Different image per DUT</i> is selected, the user only selects the directory of the images. In that case, the binary file names must have the following format: <i>img_0X.bin</i> , where 'X' denotes the DUT number. For example, if the user has activated DUTs 1, 5 and 10 then <i>img_01.img</i> , <i>img_05.img</i> and <i>img_10.img</i> binary files should exist in the selected OTP image path, as shown in Figure 71.

SmartBond Production Line Tool

7.2.11.2 QSPI Flash Memory

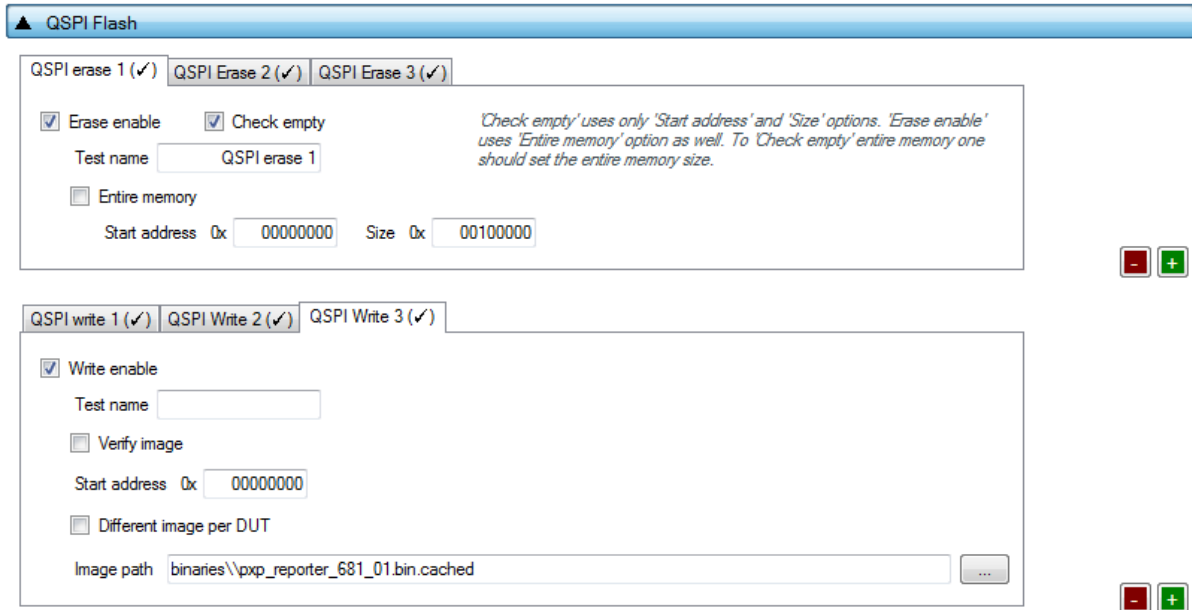

Figure 102: QSPI Flash - DA1469x

This section describes how the QSPI Flash memory can be erased and programmed.

Both erase and write operations can have multiple instances with different settings. Tests can be added and removed using the two buttons (e.g. and in Figure 102) at the bottom right side of each panel.

Note: When adding or removing a test all settings are refreshed with the values written to the XML file, meaning that any unsaved settings will be lost.

The QSPI flash memory should be erased before any image is written to it. Table 92 describes the available options for the *QSPI Flash Erase* operation.

Table 92: QSPI Flash Erase - DA1469x

Option	Description
Erase enable	This will enable the specific QSPI flash erase test.
Check empty	After QSPI flash erasure, the PLT software can verify the result by sending a specific command to the <code>uartboot_69x.bin</code> firmware running in the DUT. The firmware will read the QSPI flash and check if it is empty. The result will be returned to the PLT software.
Entire memory	This option is only available for the <i>Erase enable</i> option. When this checkbox is selected, the entire memory can be erased. Otherwise, the user can give a start address and a specific number of bytes to be erased.
Start address	The user can enter a specific start address for the QSPI erasure to start.
Size	The size in bytes to erase, starting from the <i>Start address</i> as explained above.

After every *QSPI Flash erase* test has finished, the *QSPI image write* tests will begin. Table 93 describes the available options for the *QSPI Flash Image Write* operation.

Table 93: QSPI Flash Image Write - DA1469x

Option	Description
Write enable	This will enable the specific QSPI flash image programming test.

SmartBond Production Line Tool

Option	Description
Verify image	By selecting this option, the PLT software will read back the contents of the QSPI flash memory and compare them to the original image file. If these do not match, the QSPI memory programming will fail.
Start address	The user can configure the QSPI flash start address where the image will be written.
Different image per DUT	If this option is selected, ten a different image per DUT can be burned into the QSPI flash. The image name must be specific for each DUT, as described below.
Image path	Via this field, the user specifies the image file to be burned into the QSPI flash memory. A .bin binary file of any name can be selected. If option <i>Different image per DUT</i> is selected, the user only specifies the directory of the images. In that case, the binary file names must have the following format: <i>img_0X.bin</i> , where 'X' denotes the DUT number. For example, if the user has activated DUTs 1, 5 and 10 then <i>img_01.img</i> , <i>img_05.img</i> and <i>img_10.img</i> binary files should exist in the selected QSPI image path, as shown in Figure 71 .

7.2.11.3 Memory read



Figure 103: Memory Read Test - DA1469x

Memory Read Tests can have multiple instances with different settings. Tests can be added or removed using the two buttons (e.g. and in [Figure 103](#)) at the bottom right side of each panel.

Note: When adding or removing a test, all settings are refreshed with the values written to the XML file, meaning that any unsaved settings will be lost.

[Table 94](#) describes the memory read test options. With this test, the user can read up to 64MBytes of data from any address from any available memory for the DA1469x devices, such as OTP and QSPI. An example of how the data appears on the log file is shown in [Figure 104](#).

```
Memory read operation initialized. Memory read test name=[QSPI CUSTOM].
Memory read operation started. Memory read test name=[QSPI CUSTOM].
Memory read operation ended OK. Test name [QSPI CUSTOM]. Memory=[QSPI]. Addr=[0xE1000]. Size=[5]. Data=[1122334455].
```

Figure 104: Memory Read Test Example Log File - DA1469x

Table 94: Memory Read Test - DA1469x

Option	Description
Read enable	This will enable the specific memory reading test.
Test name	The name assigned to each test. The assigned name will be shown on the tab and next to it an indication showing whether the specific test is enabled or not.
Start address	Configures the start address . Valid addresses for OTP are 0x10080000 – 0x1008FFFF.
Size	Number of bytes to read, up to 64MBytes. If data to be read are greater than 256 bytes, then a file will be created to store the data under folder <i>mem_read_test</i> in the PLT execution path.
Memory type	The type of memory to read the data from. Available options are OTP and QSPI FLASH.

7.2.12 Memory Header (DA1469x)

This section describes the Memory Header programming settings (OTP and QSPI), available in DA1469x devices.

7.2.12.1 QSPI Header - BD Address

Figure 105: QSPI Header BD Address - DA1469x

Table 95 describes the available options for the DA1469x *BD Address* programming operation into the QSPI Header.

Table 95: QSPI Header BD Address - DA1469x

Option	Description
Write	When selected the BD address will be written in the QSPI Header.
Verify	If selected, the BD address will be read back from the QSPI Header and compared to the original.
Read	This option will read the BD address written in the QSPI Header field. It does not depend on the previous tests to run, but it is necessary for the following <i>Compare</i> test.
Compare	When the <i>Read</i> option is enabled, a comparison will be performed between the read BD address and the BD address entered in the DUT by the PLT, as described in the BD address DUT assignment method.
Address	The QSPI Flash address where the BD address will be written. This field is the same for all of the above actions. Default value is 0x080000.

7.2.12.2 Custom Memory Data

Figure 106: Custom Memory Data - DA1469x

SmartBond Production Line Tool

Table 96 describes the *Custom Memory* data test options. With this test, the user can write any data to any address to any available memory for the DA1469x devices, such as OTP, register initialization at OTP-TCS section and QSPI. Data input modes can be a Barcode Scanner, a CSV file or data entered manually. For the DA1469x devices, the data entry can be used as input to the Homekit binary generator to create a binary and automatically write it to a memory.

Table 96: Custom Memory Data - DA1469x

Option	Description								
Write enable	This option enables the Custom data programming.								
Verify data	When selected, the data written will be read back from the memory and will be compared to the original.								
<ul style="list-style-type: none"> No check Check empty Check if data match Skip if empty (Only available when OTP memory, OTP TCS field or CSV file as input is selected)	Memory protection options: No check: No protection is enabled. PLT will attempt to burn the OTP memory without running any check. Check empty: PLT will first check if the OTP memory to be burned is empty. If it is empty will burn it. Check if data match: PLT will first check if the memory to be burned is empty. If it is not, it will compare the contents with the data to be burned. If the data are not the same the test will fail without making any changes to the memory. If the data are the same, PLT will not burn the memory to prevent using the OTP repair memory. Skip if written: PLT will read the contents of OTP memory. If it contains any data, it will skip writing without producing any error.								
<ul style="list-style-type: none"> Barcode scanner CSV file Manual data 	<p>Note: Barcode scanner mode is only available with GUI PLT Application. CLI PLT Application does NOT support this feature.</p> <p>Custom data input options:</p> <table border="1"> <tbody> <tr> <td>Scanner interface (Barcode scanner)</td> <td> Selection of the Barcode scanner input. Both HID and COM port interfaces are supported. This list provides an HID and all available COM ports as selectable options. Any HID device is supported that includes newline (CR-LF) characters at the end of the scanned data. For the COM port interface, a common USB to UART barcode scanner is supported. PLT has been tested with Honeywell Xenon 1900. Appendix M describes the setup procedure. This option is the exact same option as in Scan Mode and the DA1469x devices in Custom Memory Data. </td> </tr> <tr> <td>Scan mode (Barcode scanner)</td> <td> Scan DUT position: In this mode, the users must first scan the DUT position number and then the BD address. The string used for the position of each DUT is "TEST POSITION 0xx" where "xx" is the DUT position number. Automatic DUT position: Scanned BD address will be assigned to the selected DUT. The DUT selection is automatically been made, starting from the first active DUT and selecting the next one after a successful BD address scan. Users can change the selected DUT using the controls on the GUI PLT screen shown in Figure 112. This option is the exact same option as in Scan Mode and the DA1458x devices in Custom Memory Data. </td> </tr> <tr> <td>CSV file path (CSV file)</td> <td>Path to the CSV file containing data for each device discriminated using BD addresses. The CSV file format is described in Custom data CSV file format.</td> </tr> <tr> <td>Edit data (Manual data)</td> <td>Hexadecimal data input of up to 256 bytes to burn. These data will be burned to all active DUTs.</td> </tr> </tbody> </table>	Scanner interface (Barcode scanner)	Selection of the Barcode scanner input. Both HID and COM port interfaces are supported. This list provides an HID and all available COM ports as selectable options. Any HID device is supported that includes newline (CR-LF) characters at the end of the scanned data. For the COM port interface, a common USB to UART barcode scanner is supported. PLT has been tested with Honeywell Xenon 1900. Appendix M describes the setup procedure. This option is the exact same option as in Scan Mode and the DA1469x devices in Custom Memory Data .	Scan mode (Barcode scanner)	Scan DUT position: In this mode, the users must first scan the DUT position number and then the BD address. The string used for the position of each DUT is "TEST POSITION 0xx" where "xx" is the DUT position number. Automatic DUT position: Scanned BD address will be assigned to the selected DUT. The DUT selection is automatically been made, starting from the first active DUT and selecting the next one after a successful BD address scan. Users can change the selected DUT using the controls on the GUI PLT screen shown in Figure 112 . This option is the exact same option as in Scan Mode and the DA1458x devices in Custom Memory Data .	CSV file path (CSV file)	Path to the CSV file containing data for each device discriminated using BD addresses. The CSV file format is described in Custom data CSV file format .	Edit data (Manual data)	Hexadecimal data input of up to 256 bytes to burn. These data will be burned to all active DUTs.
Scanner interface (Barcode scanner)	Selection of the Barcode scanner input. Both HID and COM port interfaces are supported. This list provides an HID and all available COM ports as selectable options. Any HID device is supported that includes newline (CR-LF) characters at the end of the scanned data. For the COM port interface, a common USB to UART barcode scanner is supported. PLT has been tested with Honeywell Xenon 1900. Appendix M describes the setup procedure. This option is the exact same option as in Scan Mode and the DA1469x devices in Custom Memory Data .								
Scan mode (Barcode scanner)	Scan DUT position: In this mode, the users must first scan the DUT position number and then the BD address. The string used for the position of each DUT is "TEST POSITION 0xx" where "xx" is the DUT position number. Automatic DUT position: Scanned BD address will be assigned to the selected DUT. The DUT selection is automatically been made, starting from the first active DUT and selecting the next one after a successful BD address scan. Users can change the selected DUT using the controls on the GUI PLT screen shown in Figure 112 . This option is the exact same option as in Scan Mode and the DA1458x devices in Custom Memory Data .								
CSV file path (CSV file)	Path to the CSV file containing data for each device discriminated using BD addresses. The CSV file format is described in Custom data CSV file format .								
Edit data (Manual data)	Hexadecimal data input of up to 256 bytes to burn. These data will be burned to all active DUTs.								
Memory (available with	Memory type selection to burn the data. Available options are OTP, QSPI and								

SmartBond Production Line Tool

Option	Description
Barcode scanner and Manual data modes)	OTP TCS (only with Manual data). Note: When Manual Data input mode is selected, writing a register in OTP TCS section is also supported. In this mode, the address field changes to register address and the data to register value. PLT will automatically find the TCS slot to burn the value, and the mirrored equivalent.
Start address (available with Barcode scanner and Manual data modes)	Memory address offset to begin burning the data. OTP valid address is 0x10080000 – 0x1008FFFF.
Data size (available with Barcode scanner and Manual data modes)	The size of the memory data to burn. In barcode scanner, the size is the number of scanned characters. In manual data, the size is number of bytes. Note: If the Homekit binary generator is used, the data size entered here is the size of the setup code and serial number as explained in Table 17. In the example the data to be scanned are “5086747870SX03112233445566R”, meaning that the data size should be 27 since ASCII character will be scanned The data size to be actually burned into the devices will be 574 bytes, which is the binary size created by the SetupCode_Generator_680.exe application.
Use Homekit binary generator (available with Barcode scanner mode)	If enabled the input memory data from the barcode scanner will be applied as input to the Dialog Homekit setup code binary generator. PLT will automatically call the setup code binary generator and burn the files created.
Unique data (available with Barcode scanner mode)	If enabled the input memory data will be compared to each other and if same data are found an error will be issued. Comparison can only be performed per current PLT test run and not for previous tested devices.
Binary generator (available with Barcode scanner mode)	The path to the Homekit setup code binary generator executable. PLT will automatically call this application and burn the files created.

7.2.13 Debug Settings

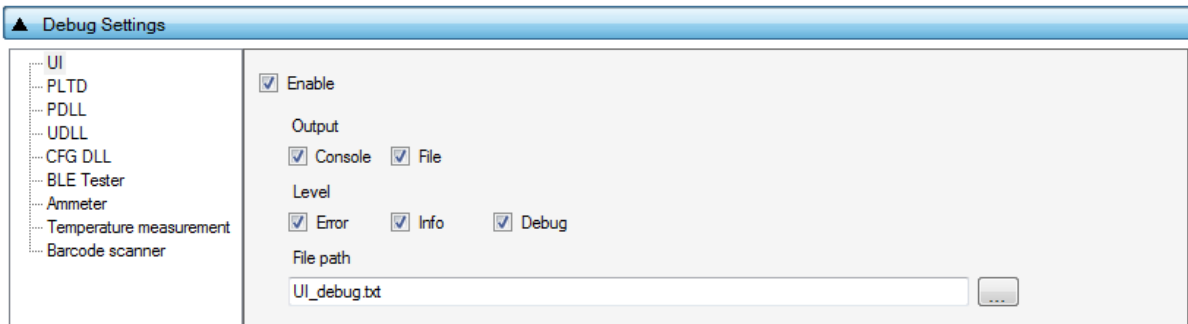

Figure 107: Debug Settings

Table 97 describes the available options for the *Debug Settings*. Debug messages are available in all PLT software blocks shown in Figure 21.

Note: Printing debug information may introduce system delay and thus some tests may fail due to time out expirations. We suggest having debug information disabled in all software blocks and only partially enable when there is a real need for it. From PLT v4.0 and onwards, this system delay has been almost eliminated as debug print messages are printed from a lower priority queue. It is safer, but it is still suggested to have the debug prints disabled.

Table 97: Debug Settings

Option	Description
Enable	Enable debug message prints for the selected library or UI.

SmartBond Production Line Tool

Option	Description
Output - Console	Sends the debug messages to the <code>stdio</code> output. The PLT CLI does not support this option. If enabled, debug messages will be redirected to the equivalent files.
Output - File	Save the debug messages to a file.
Level - Error	Enable error debug level messages. All debug print messages marked as error will be printed.
Level - Info	Enable info debug level messages. All debug print messages marked as info will be printed.
Level - Debug	Enable low level debug level messages. All low level debug print messages will be printed.
File path	Select the file that the debug messages will be saved. The file should exist; otherwise, it should be created manually. Used only when the option Output - File is selected.

7.2.14 Security

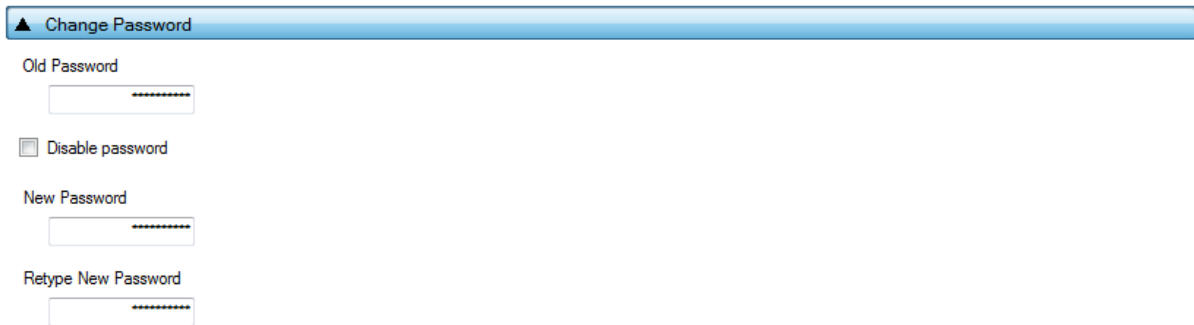

Figure 108: Security

In this field, a password can be set to protect specific tool actions, such as:

- Opening the CFG PLT or the GUI PLT application
- Closing the CFG PLT or the GUI PLT application
- Opening or refreshing configuration settings in the GUI PLT application
- Opening the settings menu in the GUI PLT application

Table 98 describes the available options for the *Security* Options.

Table 98: Security Options

Option	Description
Old Password	Type the current password to enable changing of the following fields.
Disable Password	This option will disable the password usage.
New Password	Type a new password.
Retype New Password	Verify the new password.

SmartBond Production Line Tool

7.3 GUI PLT Application

The GUI PLT (SmartBond_GUI_PLT.exe) is a Graphical User Interface application that performs the device validation and programming process. At the same time, it allows the users to monitor the entire procedure in detail. The GUI PLT uses the same XML file configured from CFG PLT as described in section 7.2.

Note: If a change is made to the XML file from the CFG PLT, then the GUI PLT settings should be refreshed as described in Table 99.

Figure 109 shows the initial screen of the GUI PLT, which is described in Table 99.

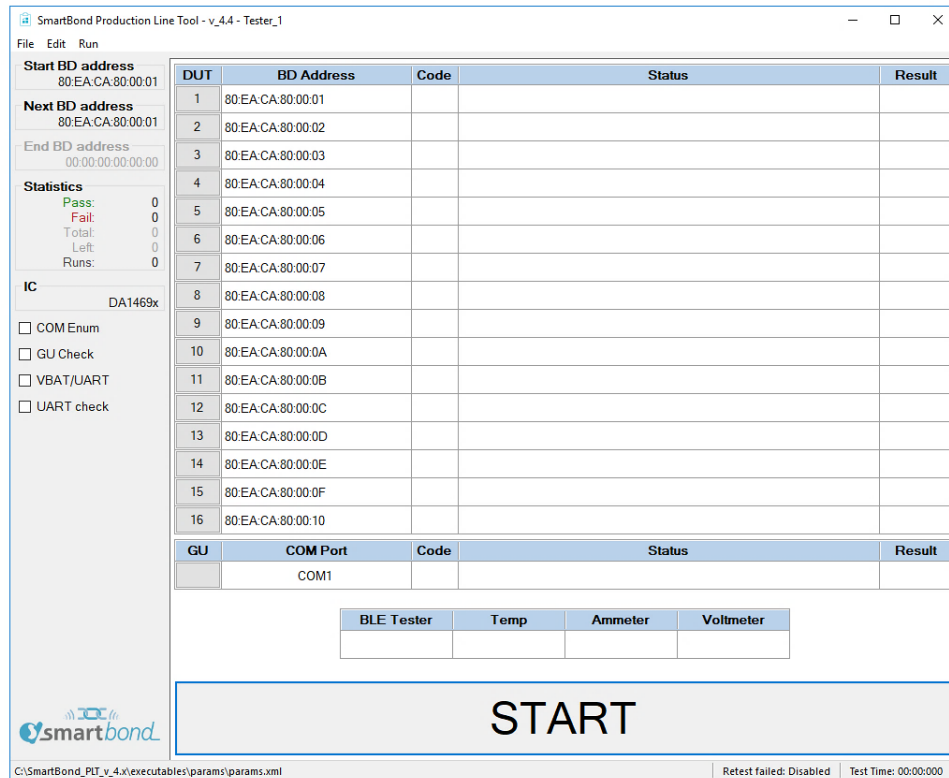

Figure 109: GUI PLT Main Screen

Table 99: GUI PLT Main Screen Description

Options	Description
File options	
File > Open XML file	Opens a new XML file and loads its settings. The full path of the new XML file is shown at the bottom end of the screen.
File > Refresh XML file	Reloads the settings from the XML file and initializes itself with the new settings.
File > Open CSV file	Contains a list with all the available CSV files to open.
File > Exit	Exits the GUI PLT application.
Edit options	
Edit > Settings	Opens the GUI PLT Settings window.
Run options	
Run > Run Configuration PLT	Opens the CFG PLT application.

SmartBond Production Line Tool

Options	Description
Left Column options	
Start BD Address	The BD address the PLT session started with, as described in section 7.2.4.
Next BD Address	The BD address that will be used on the BD address assignment for the next run as described in section 7.2.4.
End BD Address	The BD address the PLT session ends with as described in section 7.2.4. This option is available only when <i>Range mode</i> is enabled.
Statistics	This field holds statistics for each PLT session. Table 29 describes the <i>Statistics</i> field.
IC	The selected IC of the PLT.
COM Enum	If this checkbox is enabled then the START button initiates the automatic Window COM port enumeration for the DUT.
GU Check	If this checkbox is enabled then the START button initiates the automatic Window COM port enumeration for the Golden Unit.
VBAT/UART	If this checkbox is enabled then the START button will enable the VBAT and UART for the DUTs selected under <i>VBAT/UART</i> in Table 100.
UART check	If this checkbox is enabled then the START button initiates the UART check procedure for the DUTs with a specified Baud rate set from the user through the GUI PLT Settings . During this test, 1000 packets will be sent, received back and checked for errors. For the DA14531 and DA1469x DUTs the packets contain 252 bytes. Note: Before any UART transfer begins, PLT will download the production test firmware to the active DUTs.
Center screen options	
DUT panel	Shows the following fields for each DUT: <ul style="list-style-type: none"> • DUT: DUT connector number on the PLT hardware. This field is also a button that opens the Log file for the specific DUT. • BD Address: BD address assigned to the DUT. • Code: Real-time status as a PLTD DLL special code described in [1]. • Description: A brief description of the status code. • Result: Simplified color-coded status showing the progress per DUT.
GU panel	Shows the following fields for the Golden Unit: <ul style="list-style-type: none"> • GU: A button that opens the Golden Unit Log file. • COM Port: The COM port assigned to the Golden Unit. • Code: Real-time status as a PLTD DLL special code described in [1]. • Status: A brief description of the status code. • Result: Simplified color-coded status showing the progress of the GU.

SmartBond Production Line Tool

Options	Description
Instrument panel	This field shows a simplified color-coded status is shown for each of the instruments (BLE Tester , Temp , Ammeter and Voltmeter), if they are enabled.
START button	If one of the options <i>COM Enum</i> , <i>GU Check</i> , <i>VBAT/UART</i> or <i>UART check</i> is enabled, then selecting the <i>START</i> button will initiate the chosen test. If no option is selected, selecting the <i>START</i> button initiates the production procedure. Note: To select and press the <i>Start Button</i> press the <i>space-bar</i> key. The <i>Start Button</i> can only be pressed with the mouse (or use the <code>\`f'</code> key as a shortcut), after the selected procedure is finished, in order to return to main screen. This is to avoid pressing the <i>Start Button</i> and starting a new test procedure, by mistake.
Bottom of the main screen	
Left panel: C:\SmartBond_PLT_v_4.x\executables\params\params.xml	Shows the full path of the XML file that is currently used.
Center panel: Retest failed: Disabled	Shows if the Re-test option in GUI PLT Settings is enabled.
Right panel: Test Time: 00:00:000	This timer starts counting when the <i>START</i> button is pressed and runs until the <i>PLT</i> returns to its idle state, showing the approximate duration of the tests.

7.3.1 GUI PLT Settings

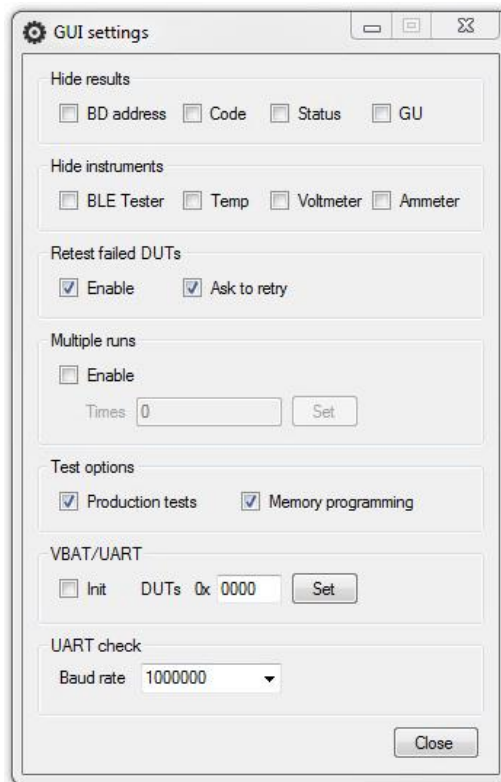

Figure 110: GUI PLT Settings

SmartBond Production Line Tool

Figure 110 shows the *GUI PLT settings* window. In this window, various graphic options and features can be set as described in Table 100.

Table 100: GUI PLT Settings

Field	Option	Description
Hide results	BD address	This option will hide the <i>BD address</i> column in the DUT panel of the GUI PLT.
	Code	This option will hide the <i>Code</i> column in the DUT panel of the GUI PLT.
	Status	This option will hide the <i>Status</i> column in the DUT panel of the GUI PLT.
	GU	This option will hide the <i>GU</i> column in the DUT panel of the GUI PLT.
Hide instruments	BLE Tester	This option will hide the <i>BLE Tester</i> column in the GU panel of the GUI PLT.
	Temp	This option will hide the <i>Temp</i> column in the GU panel of the GUI PLT.
	Voltmeter	This option will hide the <i>Voltmeter</i> column in the GU panel of the GUI PLT.
	Ammeter	This option will hide the <i>Ammeter</i> column in the GU panel of the GUI PLT.
Retest failed DUTs	Enable	If this option is enabled, any DUT that failed during the main procedure will immediately re-run the tests having the exact same options including the <i>BD address</i> assigned to it. This option is the exact same option as <i>Re-test failed DUTs</i> in section 7.2.3.2.
	Ask to retry	This option will show a message asking to do a re-test in case any DUT failed. If this option is disabled, the re-testing will be done automatically.
Multiple Runs	Enable	By enabling this option, the GUI PLT will perform multiple procedures without any delay between them. This is used for only for evaluation.
	Times	The number of times to run.
Test Options	Production tests	Enables /Disables the production test procedure. This is the same option as <i>Production tests</i> in section 7.2.3.2.
	Memory programming	Enables /Disables the production test procedure. This is the same option as <i>Memory programming</i> in section 7.2.3.2.
VBAT/UART	Init	If this option is enabled, the PLT hardware will be reset before enabling the DUTs. This option is enabled only when <i>VBAT/UART</i> in the main screen is enabled.
	DUTs	Bitwise DUT set/reset for each of the 16 DUTs using a 16-bit hexadecimal value. 089 Example: To enable only DUTs 1, 2, 15 and 16 use "C003" (1100 0000 0000 0011 = 0xC003).
UART check	Baud rate	Sets the Baud rate for the UART check test.

7.3.2 Barcode Scanner Mode

A barcode scanner can be used for two purposes. It can be used to scan DUT BD addresses and/or Custom Memory Data. If any these options have the Barcode scanner option enabled then the Barcode Scan option will appear in the GUI PLT as shown in Figure 111. If both options are enabled then the GUI PLT will first use the Barcode scanner for the BD address *Scan Mode* assignment and then for the *Custom Memory Data*.

In all cases described in section 7.2.4.1 except *Scan Mode*, the GUI PLT assigns BD addresses right before the PLT starts the production test run. Device BD addresses should be scanned before the start of a production test run. If the *START* button is pressed without any BD address being assigned to the device, the PLT will **not** run the tests.

SmartBond Production Line Tool

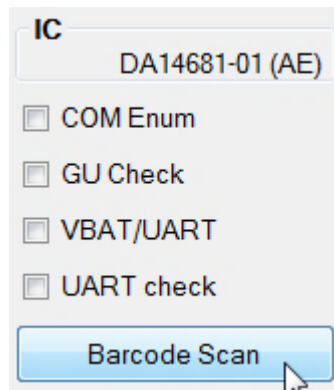

Figure 111: Barcode Scan Option in GUI PLT

Two different device BD address scanning procedures are supported. If the same BD address is used twice an error message appears in the DUT panel. It then waits for a unique BD address. An example is shown in Figure 113.

1. *Scan DUT position.* In this mode, the user must first scan the DUT position and then the BD address. The string used for the position of each DUT is "TEST POSITION 0xx" where "xx" is the DUT number 1 to 16.
2. *Automatic DUT position.* The scanned BD address will be assigned to the selected DUT. DUT selection is done automatically. The PLT starts from the first active DUT and goes to the next after a successful BD address scan. The user can change the selected DUT via the controls shown in Figure 112. If the scanned BD address was successfully assigned, the PLT will automatically select the next active DUT and wait for a new BD address to be scanned.



Figure 112: Barcode Scanner Controls

If the Custom Memory Data test requires data to be scanned then the user must scan the Custom data after the BD address for each DUT. Homekit Setup Code Scan Example provides detailed steps showing how to scan both BD addresses and data for the Custom Memory data test.

After all active DUTs have BD addresses assigned; the user should click the END button in the controls to return to the main screen. Pressing the START button will then start the test execution.

Note: If the Barcode Scan button is pressed again, all BD addresses will be reset and the BD address assignment procedure will begin again.

DUT	BD Address	Code	Status	Result
1	11:22:33:44:55:06		BARCODE SCANNER BD ADDRESS OK	PASS
2	00:00:00:00:00:00		BD ADDRESS 11:22:33:44:55:06 ALREADY USED. RETRY	CHECK
3	11:22:33:44:55:08		BARCODE SCANNER BD ADDRESS OK	PASS
4	11:22:33:44:55:09		BARCODE SCANNER BD ADDRESS OK	PASS
9	11:22:33:44:55:13		BARCODE SCANNER BD ADDRESS OK	PASS
10	00:00:00:00:00:00			
11	00:00:00:00:00:00			
12	00:00:00:00:00:00			

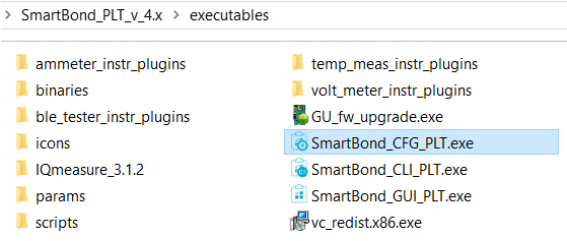

Figure 113: Barcode Scan - BD Address Assignment

SmartBond Production Line Tool

7.3.2.1 Homekit Setup Code Scan Example

An example of using the barcode scanner and Custom Memory Data will be given. A barcode scanner will be used to scan different Homekit setup codes. PLT will call the *SetupCode_Generator_680.exe* application to create the binaries that contains the DUTs serial numbers and the hashed version of the setup codes. Finally, it will program the binaries to the DUTs. The process will be described in Table 101. The example will use DA14681-01 DUTs and configure the PLT such that to perform XTAL trim test, RF test and homekit setup code scanning and programming.

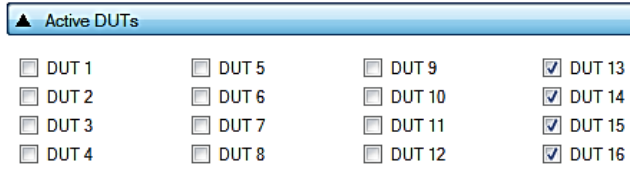
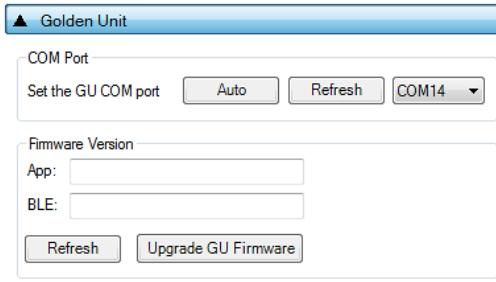
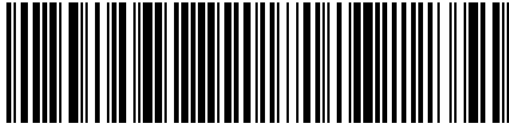
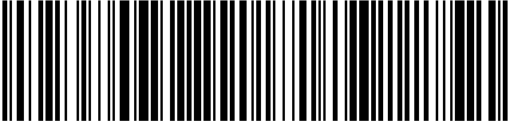

Table 101: Homekit Setup Code Scan Example

#	Action
1	Copy PLT software <i>SmartBond_PLT_v_4.x.x.x</i> under C:\ directory.
2	Open <i>SmartBond_CFG_PLT.exe</i> from executables folder. 
3	Go to <i>Hardware Setup-> Device IC</i> and select <i>DA14681-01 (AE)</i> . Press the <i>Save*</i> button. 
4	Go to <i>Hardware Setup-> Active DUTs</i> and select <i>DUT13, DUT14, DUT15</i> and <i>DUT16</i> . Press the <i>Save*</i> button. 
5	Go to <i>Hardware Setup-> Golden Unit COM Port</i> and auto-detect the COM port. Press the <i>Auto</i> button. Press the <i>Save*</i> button. 
6	Go to <i>Test Settings->XTAL Trim</i> and enable the settings as shown in the following screenshot. Press the <i>Save*</i> button. These settings will enable the XTAL trim calibration test. The result of the XTAL trim calibration will be saved into QSPI flash. Dialog SDK firmware is able to read the value from this specific QSPI address (0x8F000) and apply it to the appropriate chipset XTAL trim register.

SmartBond Production Line Tool

#	Action
7	<p>Go to <i>Test Settings->RF Tests</i> and enable the settings shown in the following screenshot. Three RF tests at channels 2424 MHz, 2450 MHz and 2476 MHz are already enabled in the PLT by default. Check that all settings are correct. Press the <i>Save*</i> button.</p>
8	<p>Deselect everything in <i>Memory Functions</i> tab. No need to burn any image for this example. Press the <i>Save*</i> button.</p>
9	<p>Connect to the PC a USB to Serial (COM) barcode scanner instrument. Keep the Windows COM port assigned to the instrument.</p>
10	<p>Go to <i>Memory Header->Custom Memory Data</i> and enable the settings shown in the following screenshot. Change the <i>Scanner Interface</i> COM port to the COM port assigned to the barcode scanner in step 9. Press the <i>Save*</i> button.</p>
11	<p>Close <i>SmartBond_PLT.exe</i> and open <i>SmartBond_GUI_PLT.exe</i>.</p>
12	<p>The initial <i>SmartBond_GUI_PLT.exe</i> screen will appear.</p>

SmartBond Production Line Tool

#	Action
13	<p>Press the <i>Barcode Scan</i> button on the bottom left corner. The following screen will appear.</p>
14	<p>Use the barcode scanner instrument to scan four different homekit setup codes with specific format as this was described in Table 17. Four different example codes are given next.</p> <div style="display: flex; flex-wrap: wrap; justify-content: space-around;"> <div style="text-align: center;">  45953404LU09G1A000096 </div> <div style="text-align: center;">  23793852LU09G1A000161 </div> <div style="text-align: center;">  44613980LU09G1A000011 </div> <div style="text-align: center;">  56795235LU09G1A000038 </div> </div>
15	<p>When the barcodes, given in step 14, are scanned using the barcode scanner instrument, the GUI PLT will be as shown next.</p>

SmartBond Production Line Tool

#	Action																																			
	<p>The screenshot shows the SmartBond tool interface. On the left, there are fields for Start BD address (00:00:00:00:00:01), Next BD address (00:00:00:00:00:01), and End BD address (00:00:00:00:00:00). Below these are statistics (Pass: 0, Fail: 0, Total: 0, Left: 0, Runs: 0) and IC information (DA14681-01 (AE)). There are checkboxes for COM Enum, GU Check, and VBAT/UART, and a Barcode Scan button. The main area contains two tables:</p> <table border="1"> <thead> <tr> <th>DUT</th> <th>BD Address</th> <th>Memory Data</th> <th>Result</th> </tr> </thead> <tbody> <tr> <td>13</td> <td>00:00:00:00:00:01</td> <td>45953404LU09G1A00009</td> <td>OK</td> </tr> <tr> <td>14</td> <td>00:00:00:00:00:02</td> <td>23793852LU09G1A00016</td> <td>OK</td> </tr> <tr> <td>15</td> <td>00:00:00:00:00:03</td> <td>44613980LU09G1A00001</td> <td>OK</td> </tr> <tr> <td>16</td> <td>00:00:00:00:00:04</td> <td>56795235LU09G1A00003</td> <td>OK</td> </tr> </tbody> </table> <table border="1"> <thead> <tr> <th>GU</th> <th>COM Port</th> <th>Status</th> <th>Result</th> </tr> </thead> <tbody> <tr> <td></td> <td>COM4</td> <td></td> <td></td> </tr> </tbody> </table> <p>Below the tables are buttons for BLE Tester, Temp, and Voltmeter. At the bottom, there are buttons for PREV, END, and NEXT. The status bar at the bottom indicates 'Retest failed: Disabled' and 'Test Time: 00:00:00'.</p>	DUT	BD Address	Memory Data	Result	13	00:00:00:00:00:01	45953404LU09G1A00009	OK	14	00:00:00:00:00:02	23793852LU09G1A00016	OK	15	00:00:00:00:00:03	44613980LU09G1A00001	OK	16	00:00:00:00:00:04	56795235LU09G1A00003	OK	GU	COM Port	Status	Result		COM4									
DUT	BD Address	Memory Data	Result																																	
13	00:00:00:00:00:01	45953404LU09G1A00009	OK																																	
14	00:00:00:00:00:02	23793852LU09G1A00016	OK																																	
15	00:00:00:00:00:03	44613980LU09G1A00001	OK																																	
16	00:00:00:00:00:04	56795235LU09G1A00003	OK																																	
GU	COM Port	Status	Result																																	
	COM4																																			
16	<p>If something goes wrong, either navigate to the different DUT Memory Data cells using the <i>PREV/NEXT</i> buttons or click the <i>END</i> button and then the <i>Barcode Scan</i> button again to restart the process. The previous scanned data will be erased.</p> <p>If everything went well click the <i>END</i> button. The tool will return to its initial screen as shown in step 12.</p>																																			
17	<p>Press the Space keyboard key to start the PLT tests. The PLT process will proceed.</p> <p>The screenshot shows the SmartBond tool interface after PLT tests. The statistics show Pass: 0, Fail: 0, Total: 0, Left: 0, and Runs: 1. The main area contains two tables:</p> <table border="1"> <thead> <tr> <th>DUT</th> <th>BD Address</th> <th>Code</th> <th>Status</th> <th>Result</th> </tr> </thead> <tbody> <tr> <td>13</td> <td>00:00:00:00:00:01</td> <td>0</td> <td>NOT ACTIVE</td> <td></td> </tr> <tr> <td>14</td> <td>00:00:00:00:00:02</td> <td>2</td> <td>COM PORT IDENTIFY STARTED</td> <td></td> </tr> <tr> <td>15</td> <td>00:00:00:00:00:03</td> <td>3</td> <td>COM PORT IDENTIFY OK</td> <td>PASS</td> </tr> <tr> <td>16</td> <td>00:00:00:00:00:04</td> <td>3</td> <td>COM PORT IDENTIFY OK</td> <td>PASS</td> </tr> </tbody> </table> <table border="1"> <thead> <tr> <th>GU</th> <th>COM Port</th> <th>Code</th> <th>Status</th> <th>Result</th> </tr> </thead> <tbody> <tr> <td></td> <td>COM4</td> <td>34</td> <td>RD TESTER COM LOOPBACK OK</td> <td>OK</td> </tr> </tbody> </table> <p>Below the tables are buttons for BLE Tester, Temp, and Voltmeter, all showing 'NOT USED'. The status bar at the bottom indicates 'Retest failed: Disabled' and 'Test Time: 00:05:048'.</p>	DUT	BD Address	Code	Status	Result	13	00:00:00:00:00:01	0	NOT ACTIVE		14	00:00:00:00:00:02	2	COM PORT IDENTIFY STARTED		15	00:00:00:00:00:03	3	COM PORT IDENTIFY OK	PASS	16	00:00:00:00:00:04	3	COM PORT IDENTIFY OK	PASS	GU	COM Port	Code	Status	Result		COM4	34	RD TESTER COM LOOPBACK OK	OK
DUT	BD Address	Code	Status	Result																																
13	00:00:00:00:00:01	0	NOT ACTIVE																																	
14	00:00:00:00:00:02	2	COM PORT IDENTIFY STARTED																																	
15	00:00:00:00:00:03	3	COM PORT IDENTIFY OK	PASS																																
16	00:00:00:00:00:04	3	COM PORT IDENTIFY OK	PASS																																
GU	COM Port	Code	Status	Result																																
	COM4	34	RD TESTER COM LOOPBACK OK	OK																																
18	<p>PLT will get the barcode scanned data for each DUT and call the <i>SetupCode_Generator_680.exe</i> to create four different binaries. The binaries will reside inside <i>SmartBond_PLT_v_4.x.x\executables\binaries</i>.</p> <table border="1"> <thead> <tr> <th>Name</th> <th>Date modified</th> <th>Type</th> <th>Size</th> </tr> </thead> <tbody> <tr> <td>GU</td> <td>08-Mar-17 4:49 PM</td> <td>File folder</td> <td></td> </tr> <tr> <td>23793852LU09G1A00016.bin</td> <td>08-Mar-17 5:18 PM</td> <td>BIN File</td> <td>1 KB</td> </tr> <tr> <td>44613980LU09G1A00001.bin</td> <td>08-Mar-17 5:18 PM</td> <td>BIN File</td> <td>1 KB</td> </tr> <tr> <td>45953404LU09G1A00009.bin</td> <td>08-Mar-17 5:18 PM</td> <td>BIN File</td> <td>1 KB</td> </tr> <tr> <td>56795235LU09G1A00003.bin</td> <td>08-Mar-17 5:18 PM</td> <td>BIN File</td> <td>1 KB</td> </tr> </tbody> </table>	Name	Date modified	Type	Size	GU	08-Mar-17 4:49 PM	File folder		23793852LU09G1A00016.bin	08-Mar-17 5:18 PM	BIN File	1 KB	44613980LU09G1A00001.bin	08-Mar-17 5:18 PM	BIN File	1 KB	45953404LU09G1A00009.bin	08-Mar-17 5:18 PM	BIN File	1 KB	56795235LU09G1A00003.bin	08-Mar-17 5:18 PM	BIN File	1 KB											
Name	Date modified	Type	Size																																	
GU	08-Mar-17 4:49 PM	File folder																																		
23793852LU09G1A00016.bin	08-Mar-17 5:18 PM	BIN File	1 KB																																	
44613980LU09G1A00001.bin	08-Mar-17 5:18 PM	BIN File	1 KB																																	
45953404LU09G1A00009.bin	08-Mar-17 5:18 PM	BIN File	1 KB																																	
56795235LU09G1A00003.bin	08-Mar-17 5:18 PM	BIN File	1 KB																																	
19	<p>If everything finished with no error the following screen will be shown.</p>																																			

SmartBond Production Line Tool

#	Action
	<p>The screenshot shows the SmartBond Production Line Tool interface. On the left, there are fields for 'Start BD address', 'Next BD address', and 'End BD address'. Below these are 'Statistics' (Pass: 4, Fail: 0, Total: 0, Left: 0, Runs: 1) and 'IC' (DA14681-01 (AE)). There are checkboxes for 'COM Enum', 'GU Check', and 'VBAT/JUART', and a 'Barcode Scan' button. The main area displays two tables. The first table lists DUTs 13-16 with their BD addresses, codes (215), and status (CUSTOM DATA WRITE OK), all with a 'PASS' result. The second table lists GU with COM Port COM4, code 26, and status RD TESTER INIT OK, with an 'OK' result. At the bottom, there are three buttons: 'BLE Tester' (NOT USED), 'Temp' (NOT USED), and 'Voltmeter' (NOT USED). A large green button labeled 'FINISHED' is prominently displayed. The status bar at the bottom shows 'Retest failed: Disabled' and 'Test Time: 00:30:012'.</p>
20	Press the FINISHED button to return to the main screen.

7.3.3 Running the GUI PLT and Executing Tests

The GUI PLT starts the test procedure when users click the *START* button. Before initiating the test procedure, the GUI PLT will assign BD addresses to the active DUTs and check for any wrong configuration parameters.

If *Run scripts before testing starts* is enabled, PLT will execute the selected script/executable, and wait until it finishes or times out, depending on the selections made in [Test Options](#). If the script/executable has returned on time, PLT will check the return code. Values from 0 to 100 indicate a successful completion. Negative values or values larger than 100 indicate an error. In the case of an error (either time out or error returned result), a pop-up message will appear indicating the return code and the test procedure will not start.

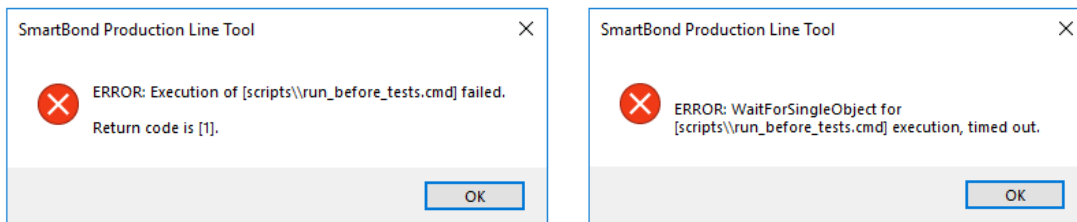

Figure 114: GUI PLT - Erroneous Messages in “run scripts before testing starts”

If any OTP burning test is scheduled, a pop-up message will inform the user and prompt to continue ([Figure 115](#)).

SmartBond Production Line Tool

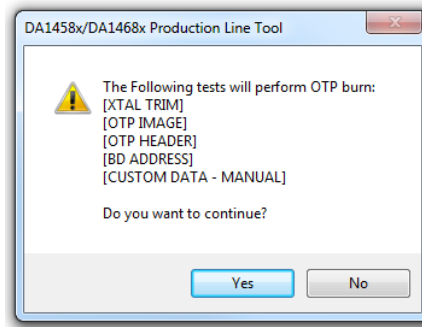

Figure 115: GUI PLT OTP Burn Warning Message

Click “Yes” to start the testing procedure. PLT updates the status of the procedure for each DUT and the Golden Unit (Figure 116). The *START* button is replaced by a progress bar indicating the progress of the tests.

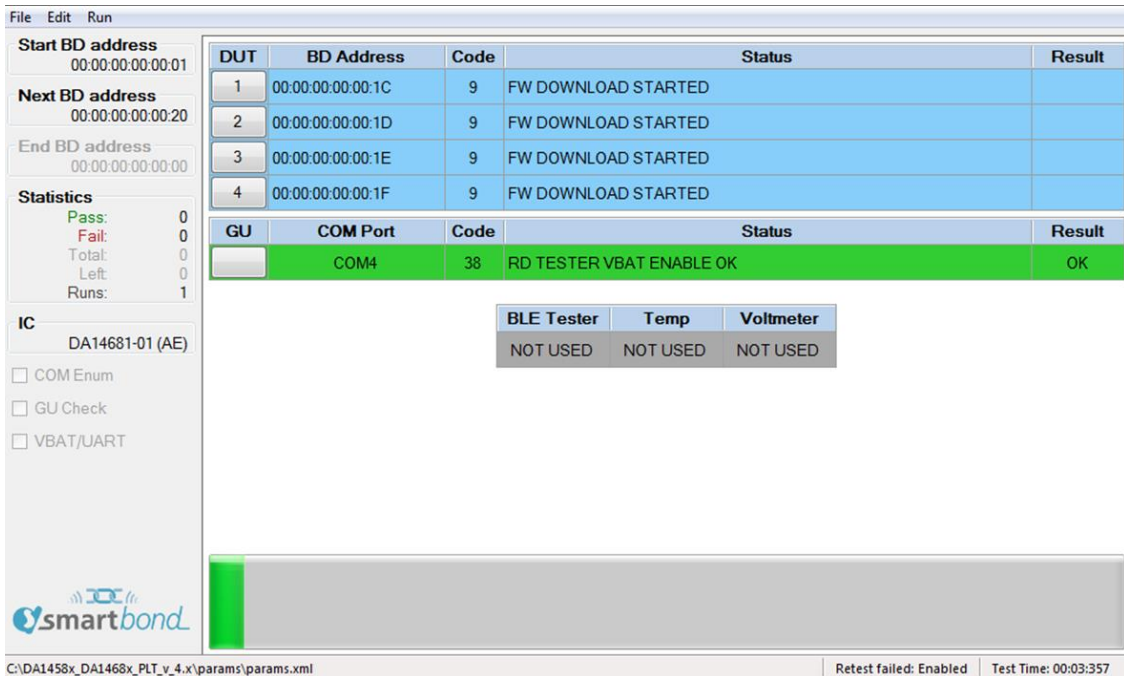

Figure 116: GUI PLT Testing (1 of 2)

If an error in a DUT is found (Figure 117), PLT will show the status code, a brief description of the error and the color of the DUT’s status line will turn red. The DUT number button can be pressed anytime to access the [DUT Log File](#) to get more details about the parameters used, calculated values and the reason for failure in the case of an error.

SmartBond Production Line Tool

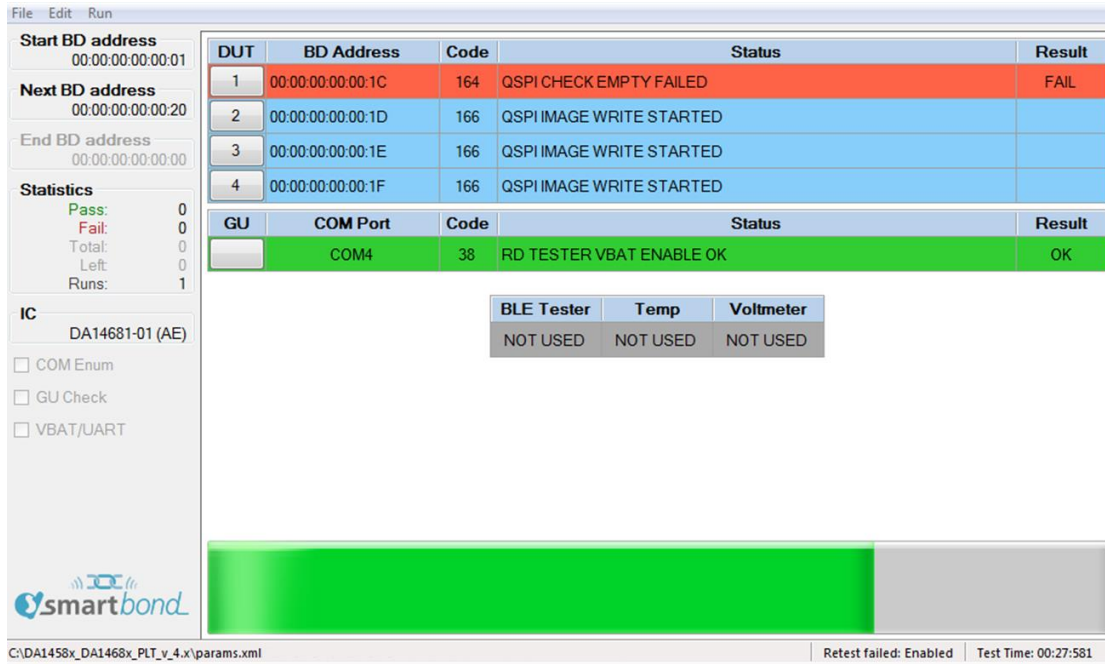

Figure 117: GUI PLT Testing (2 of 2)

After the testing procedure is completed (Figure 118), the progress bar shows *FINISHED* and the color turns red if any DUT has failed, otherwise it is green. If there is an error and the *Retest failed DUTs* and *Ask to retry* options are enabled, a message will appear asking if the user would like to retest the failed DUTs, as shown in Figure 119. When the GUI PLT performs a retest run, all options (including the BD addresses) remain the same and only tests that failed are retested. At this time, the *CSV File* and all the *DUT Log Files* are updated.

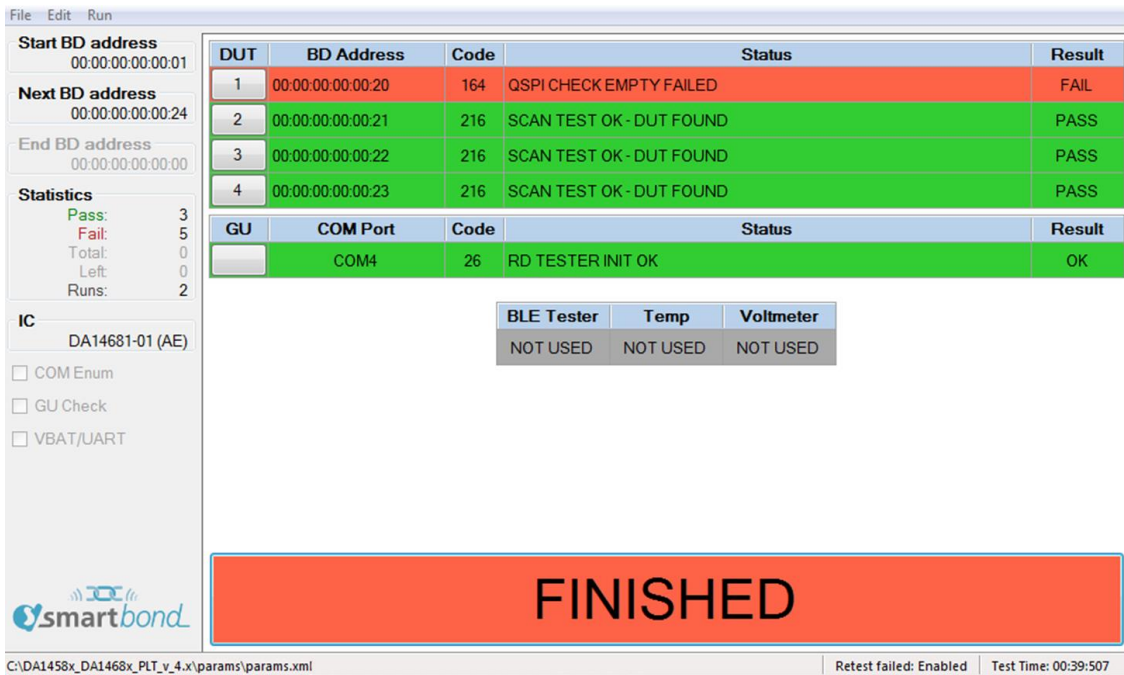

Figure 118: GUI PLT Tests Finished

SmartBond Production Line Tool

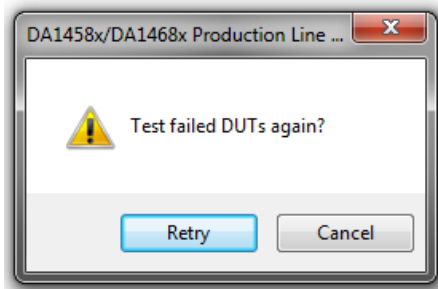

Figure 119: GUI PLT Retry Failed DUTs Message

If the DUT fails again, after the retest has finished the GUI PLT will remain in the *FINISHED* screen (Figure 118) with the *FINISHED* button shown in red.

If Run scripts when testing is finished is enabled, pressing the finished button will execute the selected script/executable. As with Run scripts before testing starts, PLT will wait until it finishes or times out, depending on the selections made in Test Options. If the script/executable has returned on time, PLT will check the return code. Zero value indicates a successful completion. Any other value is considered an error. In the case of an error (either time out or error result), a pop-up message will appear indicating the return code.

7.3.4 Debug Console

Section 7.2.12.2 shows the debug settings for all PLT applications including the GUI PLT. If at least one debug session is enabled with the output set to Console, the GUI PLT will open a new console window showing the desired debug information.

Figure 120 shows an example of the Debug Console. Depending on the type of the message, a different color is used: *DEBUG* messages are light blue, *INFO* messages are white and *ERROR* messages are red.

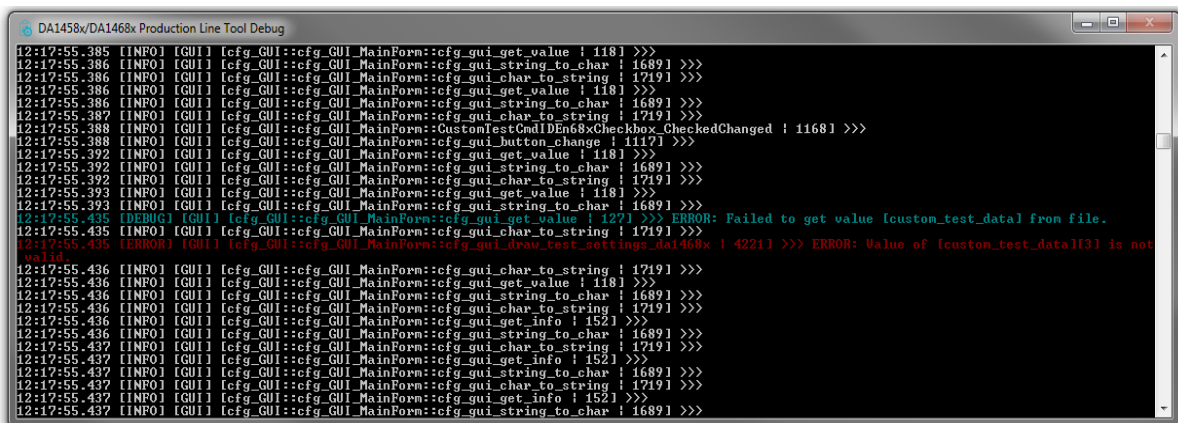

Figure 120: Debug Console

SmartBond Production Line Tool

7.3.5 DUT Log File

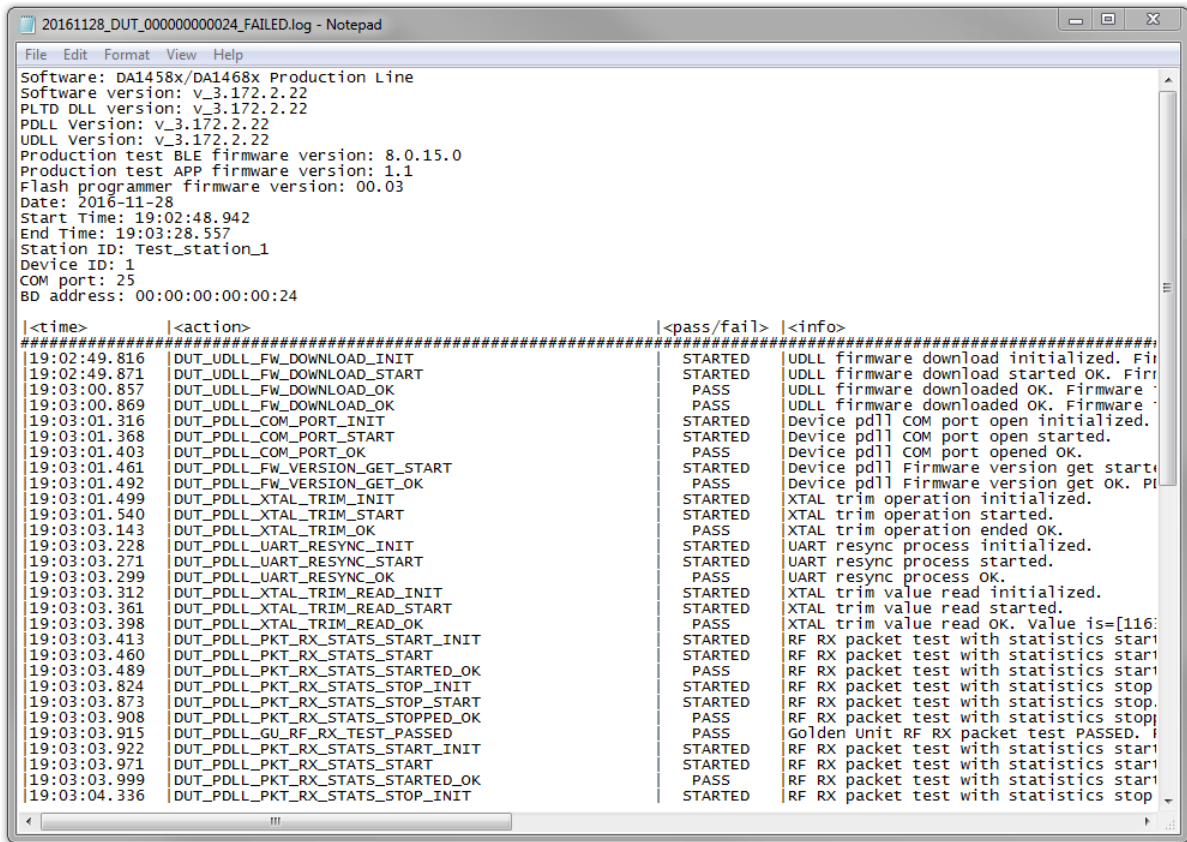

Figure 121: DUT Log File

Figure 121 shows a Log file generated for DUT1 during testing.

In the first few lines of the log, a header is created giving vital information about the PLT hardware and the software. It includes the firmware and software version, the station name and test dates and times. It also holds information about the DUT, such as the connector number in the PLT hardware, the BD address assigned to it and the Windows COM port. For the DUTs that have failed, the log file is renamed with the word "_FAILED" at the end for easier retrieval.

The Log file is created at the beginning of each test, containing only the header and all information available at the time of creation. As the device testing progresses, the status of each test is written at the end of the log file, including information about the DUT and a timestamp of the event. After the tests finish the header is updated with the end time of the test and the firmware versions, which were retrieved during testing.

SmartBond Production Line Tool

7.3.6 CSV File

Start time	End time	DUT	BD address	Overall st:	COM port	FW downl	FW path 2	FW versio	FW versio	QSPI erasi	QSPI chec	QSPI burn	QSPI imag	FW dd
17:08:53	17:10:43	1	00:00:00:0	FAIL	25	PASS	C:\Users\j	PASS	00.03	PASS	FAIL			
17:08:53	17:10:43	2	00:00:00:0	FAIL	26	PASS	C:\Users\j	PASS	00.03	PASS	FAIL			
17:10:48	17:13:24	1	00:00:00:0	FAIL	25	PASS	C:\Users\j	PASS	00.03	PASS	FAIL			
17:10:48	17:13:24	2	00:00:00:0	FAIL	26	PASS	C:\Users\j	PASS	00.03	PASS	PASS	FAIL	binaries\pxp_r	
17:13:30	17:16:39	1	00:00:00:0	FAIL	25	PASS	C:\Users\j	PASS	00.03	PASS	FAIL			
17:13:30	17:16:39	2	00:00:00:0	FAIL	26	PASS	C:\Users\j	PASS	00.03	PASS	PASS	FAIL	binaries\pxp_r	
17:17:00	17:17:10	1	00:00:00:0	FAIL	25	FAIL	C:\Users\pdimopou\Desktop\DA1458x_DA1468x_PLT_v_4.0\source\production							
17:17:00	17:17:10	2	00:00:00:0	FAIL	26	PASS	C:\Users\j	FAIL						
17:17:55	17:18:13	1	00:00:00:0	FAIL	25	FAIL	C:\Users\pdimopou\Desktop\DA1458x_DA1468x_PLT_v_4.0\source\production							
17:17:55	17:18:13	2	00:00:00:0	FAIL	26	PASS	C:\Users\j	FAIL						
17:19:56	17:20:22	1	00:00:00:0	FAIL	25	PASS	C:\Users\j	PASS	00.03	PASS	FAIL			
17:19:56	17:20:22	2	00:00:00:0	PASS	26	PASS	C:\Users\j	PASS	00.03	PASS	PASS	PASS	binaries\pxp_r	
17:21:39	17:22:16	1	00:00:00:0	FAIL	25	PASS	C:\Users\j	PASS	00.03	PASS	FAIL			
17:21:39	17:22:16	2	00:00:00:0	FAIL	26	PASS	C:\Users\j	PASS	00.03	PASS	FAIL			
17:22:18	17:25:41	1	00:00:00:0	FAIL	25	PASS	C:\Users\j	PASS	00.03	PASS	FAIL			
17:22:18	17:25:41	2	00:00:00:0	FAIL	26	PASS	C:\Users\j	PASS	00.03	PASS	FAIL			
17:25:47	17:26:08	1	00:00:00:0	FAIL	25	PASS	C:\Users\j	PASS	00.03	PASS	FAIL			
17:25:47	17:26:08	2	00:00:00:0	PASS	26	PASS	C:\Users\j	PASS	00.03	PASS	PASS	PASS	binaries\pxp_r	
18:57:45	18:58:48	1	00:00:00:0	FAIL	25	PASS	C:\Users\j	PASS	00.03	PASS	FAIL			PASS
18:57:45	18:58:48	2	00:00:00:0	PASS	26	PASS	C:\Users\j	PASS	00.03	PASS	PASS	PASS	binaries\	PASS
18:57:45	18:58:48	3	00:00:00:0	PASS	27	PASS	C:\Users\j	PASS	00.03	PASS	PASS	PASS	binaries\	PASS
18:57:45	18:58:48	4	00:00:00:0	PASS	28	PASS	C:\Users\j	PASS	00.03	PASS	PASS	PASS	binaries\	PASS
18:59:40	19:00:20	1	00:00:00:0	FAIL	25	PASS	C:\Users\j	PASS	00.03	PASS	FAIL			PASS
18:59:40	19:00:20	2	00:00:00:0	PASS	26	PASS	C:\Users\j	PASS	00.03	PASS	PASS	PASS	binaries\	PASS

Figure 122: CSV File

Figure 122 shows an example of a generated CSV file. As with the DUT Log File, the PLT software and hardware information are shown along with valuable DUT information. The CSV file keeps information about all the production tests of a single day. A new CSV file is created every day.

SmartBond Production Line Tool

7.4 CLI PLT Application

The CLI PLT (`SmartBond_CLI_PLT.exe`) is a Command Line Interface application with similar functionality and features as the GUI PLT. It performs the device testing and memory programming. At the same time, it allows users to monitor the test procedure in detail. It supports the same configuration file created from the CFG PLT and can run the same tests as the GUI PLT.

Note: Barcode scanner mode (described in [Scan Mode](#), [Custom Memory Data](#), and [Custom Memory Data](#)) is only available with [GUI PLT Application](#). [CLI PLT Application](#) does **NOT** support this feature.

[Figure 123](#) shows the initial screen of the CLI PLT software. The CLI PLT can be executed from a command line prompt, passing arguments externally and initiating the tests immediately. This is useful for scripting/batch files as shown in section [7.4.3](#).

Parameters are automatically loaded from the `params/params.xml` file when the CLI PLT starts. If there is a parameter error, a warning will be shown. It is recommended to run the 'x' command or start the CFG PLT before running the tests and check the configuration parameters. If a change is made to the `params.xml` configuration file while CLI is open, the file should be reloaded using the 'i' command. If any OTP burning test is scheduled, a message will inform the user and prompt for continuing.

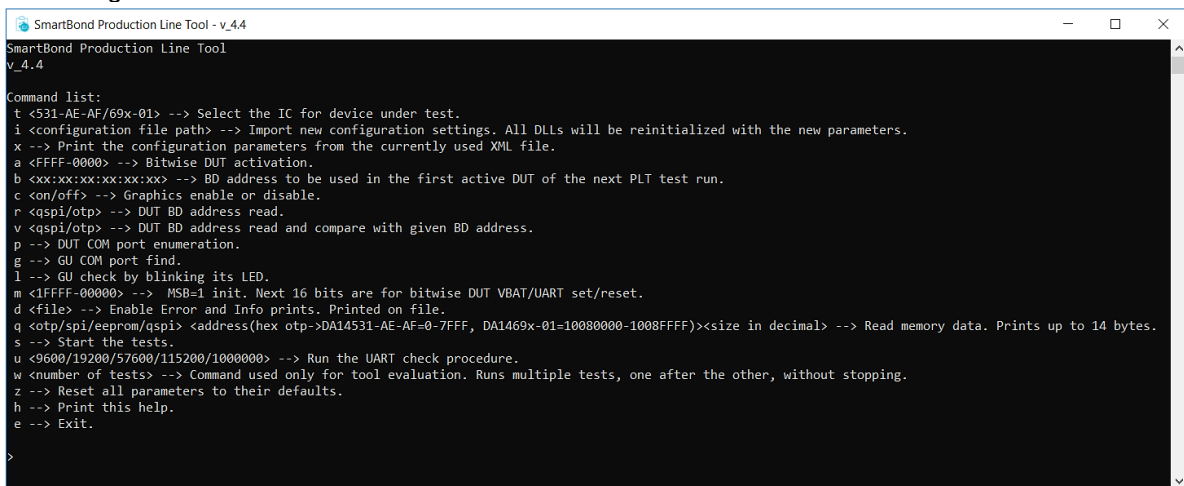

Figure 123: CLI Software Start Screen

7.4.1 CLI Commands

[Table 102](#) lists all available CLI commands. A list with brief description of these commands can be printed using the 'h' command.

Table 102: CLI Commands

Cmd	Arguments	Description
t	<ul style="list-style-type: none"> 531-AE-AF 69x-01 	Selects the type of IC that the DUT uses. This option will change the DUT IC setting in the configuration file and reload all the settings if there is a switch from any DA14531 IC to a DA1469x IC and vice versa. Example: "t 69x-01".
i	Path to XML configuration file.	Initializes the PLT with the parameters found in the <code>params.xml</code> file. Example: "i params\params.xml".
x	none	Print the configuration parameters from the currently used XML file.
a	Hex values from "FFFF" to "0000".	Bitwise DUT activation. Sets the active DUTs to be tested. Examples: <ul style="list-style-type: none"> "a 1": Only DUT 1 will be activated and tested.

SmartBond Production Line Tool

Cmd	Arguments	Description
		<ul style="list-style-type: none"> “a 9”: DUTs 1 and DUT 4 will be activated and tested.
b	xx:xx:xx:xx:xx:xx	Sets the start BD address of the first active DUT. Example: "b FE:00:11:22:33:44"
c	on/off	Enables or disables the graphics debug output of the CLI. Useful in the read BD address command <i>r</i> , in order to see only the DUT BD address returned and not the entire process. Example: "c on"
r	<ul style="list-style-type: none"> qspi otp 	Reads the BD addresses of the active DUTs. It is better to disable the graphics beforehand by running the command "c off". Example: "r qspi"
v	<ul style="list-style-type: none"> qspi otp 	Verify the BD addresses of the active DUTs. It is better to disable the graphics beforehand by running the command "c off". Example: "v qspi"
p	none	Execute the automatic DUT Window COM port enumeration.
g	none	Execute the automatic GU Window COM port enumeration.
l	none	Run the GU sanity check. The Golden Unit will start blinking its red LED.
m	First character: "1" or "0". Then hex value from "1FFFF" to "0000".	MSB character should be '1' the first time this command is executed. Consecutive 'm' commands should have the MSB character set to '0'. The next 16 bits are used for bitwise DUT VBAT/UART enable/disable. Example: "m 1FFFF"
d	<ul style="list-style-type: none"> console file 	Use this option to enable error and info prints. Choose file output or console output. Only the <i>file</i> option is currently supported. Example: "d file"
q	First argument <ul style="list-style-type: none"> otp spi eeeprom qspi Second argument <ul style="list-style-type: none"> The address in hex Third argument <ul style="list-style-type: none"> The size in bytes 	This option can read from any memory, for any address offset up to 256 bytes of data.
s	none	Starts the tests.
u	<ul style="list-style-type: none"> 9600 19200 57600 115200 1000000 	This command performs a UART check connection for all the active DUTs for a specific Baud rate.
w	Number of tests to run.	This command is used only for PLT evaluation. It starts multiple tests. These are executed one after the other without user intervention.
z	none	Resets all the XML parameters to their defaults.
h	none	Help print out. Prints the list of the CLI commands that are available.
e	none	Exits the application.

SmartBond Production Line Tool

7.4.2 Running the CLI and Executing Tests

There are a number of options to be called in order to make sure that the CLI PLT is set up correctly. Each of following commands is explained in [Table 102](#).

- Using the help command ('h') the entire CLI command list will be shown.

Example: >h

Set Console Options

- To redirect the debugging messages to the file use command 'd'. This option is going to replace the UI debug values in the configuration file.

Example: >d file

- To show or hide any prints in the Console window use command 'c' with on/off argument.

Example: >c on

Check, Reset, Reload and Change Settings

- Because the configuration file is automatically loaded, use the 'x' command ([Figure 124](#)) to see the loaded settings. Errors will be shown in red.

Example: >x

```

[i= 52, k= 2] rssi_test_enable[2]      false
[i= 53, k= 3] rssi_test_enable[3]      false
[i= 61, k= 1] rssi_test_name[1]        GU_RSSI_1
[i= 62, k= 2] rssi_test_name[2]        GU_RSSI_2
[i= 63, k= 3] rssi_test_name[3]        GU_RSSI_3
[i= 71, k= 1] rssi_limit[1]            -70.0
[i= 72, k= 2] rssi_limit[2]            -70.0
[i= 73, k= 3] rssi_limit[3]            -70.0
[i= 81, k= 1] rssi_freq[1]             2424
[i= 82, k= 2] rssi_freq[2]             2450
[i= 83, k= 3] rssi_freq[3]             2476
[i= 91, k= 1] ble_test_tx_pwr_enable[1] false
[i= 101, k= 1] ble_test_tx_pwr_name[1]  TX_POW_1
[i= 111, k= 1] ble_test_tx_pwr_freq[1]  2450
[i= 121, k= 1] ble_test_tx_pwr_range[1]  0
[i= 131, k= 1] ble_test_tx_pwr_avg_high_limit[1] 10.00
[i= 141, k= 1] ble_test_tx_pwr_avg_low_limit[1] -20.00
[i= 151, k= 1] ble_test_tx_pwr_pk_avg_limit[1] 3.00
[i= 161, k= 1] ble_test_freq_offs_enable[1] false
[i= 171, k= 1] ble_test_freq_offs_name[1]  FREQ_OFFS_1
[i= 181, k= 1] ble_test_freq_offs_freq[1]  2450
[i= 191, k= 1] ble_test_freq_offs_range[1]  0
[i= 201, k= 1] ble_test_freq_offs_pos_limit[1] 50
[i= 211, k= 1] ble_test_freq_offs_neg_limit[1] 50
[i= 221, k= 1] ble_test_freq_offs_drift_pkt_limit[1] 50
[i= 231, k= 1] ble_test_freq_offs_drift_rate_limit[1] 20
[i= 241, k= 1] ble_test_mod_idx_enable[1] false
[i= 251, k= 1] ble_test_mod_idx_name[1]  MOD_IDX_1
[i= 261, k= 1] ble_test_mod_idx_freq[1]  2450
[i= 271, k= 1] ble_test_mod_idx_range[1]  0
[i= 281, k= 1] ble_test_mod_idx_f1_min_limit[1] 225
[i= 291, k= 1] ble_test_mod_idx_f1_max_limit[1] 275
[i= 301, k= 1] ble_test_mod_idx_f2_max_limit[1] 185
[i= 311, k= 1] ble_test_mod_idx_f1f2_ratio_limit[1] 0.8
[i= 321, k= 1] ble_test_rx_sens_enable[1] false
[i= 331, k= 1] ble_test_rx_sens_name[1]  RSSI_1
[i= 341, k= 1] ble_test_rx_sens_freq[1]  2450
[i= 351, k= 1] ble_test_rx_sens_payload_pattern[1] 0
[i= 361, k= 1] ble_test_rx_sens_pkt_space[1] 625
[i= 371, k= 1] ble_test_rx_sens_num_of_pkts[1] 500
[i= 381, k= 1] ble_test_rx_sens_tx_pwr[1] 0.00
[i= 391, k= 1] ble_test_rx_sens_dirty[1] false
[i= 401, k= 1] ble_test_rx_sens_crc[1] false
[i= 411, k= 1] ble_test_rx_sens_rssi_lim[1] -70.0
    
```

Figure 124: CLI PLT Print Settings (x Command)

- To reset the configuration parameters to their defaults values the 'z' command should be used.
- To reload the configuration file or to load another one, 'i' command can be used.

Example: >i params/params.xml

- To change only the selected device IC, use the 't xxx' command, where 'xxx' is the desired IC selection. If a change from DA14531 to DA1469x (and vice versa) is made, all the settings will be reloaded.

Example: >t 69x-01

SmartBond Production Line Tool

- To change the active DUTs use the 'a' command. As an argument a 16-bit hexadecimal value is used, which is the bitwise representation of the active DUTs with DUT 1 being the LSB. This command will replace the `dut_num_x` values in the configuration file.

The following example will enable only DUT1, DUT2, DUT15 and DUT 16.

Example: `>a C003`

- To change the BD address that will be used in the next run use the 'b' command. This option is going to replace the *BD address* and *Statistics* values in the configuration file.

Example: `>b 00:00:00:00:00:01`

Hardware Specific Tests

- To automatically find the Windows COM Port assigned to the Golden Unit, use the 'g' command. This command will replace the `gu_com_port` value in the configuration file.

Example: `>g`

- To verify that the Golden Unit COM port is found correctly and to check if the Golden Unit is ready run the 'l' command.

Example: `>l`

- To automatically find the Windows COM Port assigned for each DUT, use the 'p' command. This command will replace the `com_port_dut_x` values in the configuration file.

Example: `>p`

DUT	BD ADDRESS	CODE	STATUS	RESULT
2	00:00:55:00:00:01	0	NOT ACTIVE	
3	00:00:55:00:00:02	2	COM PORT IDENTIFY STARTED	
4	00:00:55:00:00:03	3	COM PORT IDENTIFY OK	PASS
GU	COM4	34	RD TESTER COM LOOPBACK OK	OK

Figure 125: CLI PLT DUT COM Port Enumeration ('p' Command)

- To run a UART error check use the 'u' command followed with a specific Baud rate.

Example: `>u 1000000`

PLT Production Tests

- To check if there is a BD address written in the active DUTs use the 'r' command. To read the BD addresses and verify that they are the same as the ones currently assigned use the 'v' command. Both commands use 'qspi' or 'otp' as argument to define the memory header.

The following example will read the BD address from the QSPI memory header and compare it with the one currently assigned to the DUTs.

Example: `>v qspi`

DUT	BD ADDRESS	CODE	STATUS	RESULT
2	00:00:55:00:00:01	177	QSPI BD ADDRESS COMPARED OK	PASS
3	00:00:55:00:00:02	177	QSPI BD ADDRESS COMPARED OK	PASS
4	00:00:55:00:00:03	177	QSPI BD ADDRESS COMPARED OK	PASS
GU	COM4	26	RD TESTER INIT OK	OK

DUT	QSPI BD ADDRESS	GIVEN BD ADDRESS	STATUS
02	00:00:55:00:00:01	00:00:55:00:00:01	MATCH
03	00:00:55:00:00:02	00:00:55:00:00:02	MATCH
04	00:00:55:00:00:03	00:00:55:00:00:03	MATCH

return status = 0xFFF1

Figure 126: CLI PLT Read and Compare BD Address in QSPI ('v' Command)

- Use the 's' command to begin testing with the current configuration. [Figure 127](#) shows the CLI during the testing. After all the tests have finished, the result remains on the screen as shown in [Figure 128](#).

SmartBond Production Line Tool

DUT	BD ADDRESS	CODE	STATUS	RESULT
2	00:00:55:00:00:01	9	FW DOWNLOAD STARTED	
3	00:00:55:00:00:02	9	FW DOWNLOAD STARTED	
4	00:00:55:00:00:03	9	FW DOWNLOAD STARTED	
GU	COM4	38	RD TESTER VBAT ENABLE OK	OK

BLE TESTER	TEMP	UOLT
NOT USED	NOT USED	NOT USED

Figure 127: CLI PLT Testing

DUT	BD ADDRESS	CODE	STATUS	RESULT
2	00:00:55:00:00:01	216	SCAN TEST OK - DUT FOUND	PASS
3	00:00:55:00:00:02	216	SCAN TEST OK - DUT FOUND	PASS
4	00:00:55:00:00:03	216	SCAN TEST OK - DUT FOUND	PASS
GU	COM4	26	RD TESTER INIT OK	OK

BLE TESTER	TEMP	UOLT
NOT USED	NOT USED	NOT USED

DUT	QSPI BD ADDRESS	GIVEN BD ADDRESS	STATUS
02	00:00:55:00:00:01	00:00:55:00:00:01	MATCH
03	00:00:55:00:00:02	00:00:55:00:00:02	MATCH
04	00:00:55:00:00:03	00:00:55:00:00:03	MATCH

return status = 0xFF1

Figure 128: CLI PLT Testing Finished

- Use the 'q' command to read from any memory up to 156 bytes of data. The following example will read the BD address (6 bytes from offset 0xFF0) of a DA14531s DUT.
Example: >q otp ff0 6

Other Test Commands

- Use the 'm' command to power on and access the DUTs to perform further testing. This will open the VBAT and the COM ports from the PLT hardware to the DUTs. As an argument, a '0' or '1' character is used to reset the PLT hardware. This is followed by a 16-bit hexadecimal number, which is the bitwise representation of the DUTs to use, with DUT 1 being the LSB.
In the following example, the PLT hardware will be reset and DUTs 1, 2, 15 and 16 will be used.
Example: >m 1C003

SmartBond Production Line Tool

7.4.3 Using CLI Commands with Arguments

It is possible to start the CLI program with the commands described in section 7.4.2 as arguments. This is useful for scripting/batch files.

```
C:\executables>DA1458x_DA1468x_CLI_PLT.exe -a 0001 -b 00:00:55:00:00:01 -s -b 00:00:55:00:00:01 -v qspi
```

Figure 129: CLI with Commands as Arguments

The example shown in Figure 129 will perform the following commands:

1. '-a 0001': Set the DUT1 as the only active DUT.
2. '-b 00:00:55:00:00:01'. Assign as the first BD address to be assigned the 00:00:55:00:00:01. This BD address will be used in DUT1, as it is the only active DUT.
3. '-s': Perform the tests. BD address write in QSPI header should be enabled for the following test to pass.
4. '-b 00:00:55:00:00:01': After the tests finish the BD address will be incremented; this command will reset it to 00:00:55:00:00:01.
5. '-v qspi': Read only the BD address written in the QSPI header and compare it with the one assigned to the DUT1. These are the same.

SmartBond Production Line Tool

7.5 GU Upgrade Application

The GU Upgrade (`GU_fw_upgrade.exe`) is a Graphical User Interface application, which can be used to upgrade the firmware of the Golden Unit automatically, in contrast with [Golden Unit](#) that describes a manual way to upgrade the firmware of the Golden Unit. It guides the user to configure, detect the PLT hardware and finally reprogram the SPI Flash memory onboard the PLT hardware with the Golden Unit firmware.

Note: Quick access to GU upgrade tool is provided by pressing the `Upgrade GU firmware` button, under `Firmware Version - Golden Unit` section in `CFG PLT`. Current version of the GU firmware can be seen using the `Refresh` button on the same section.

Note: This tool cannot upgrade PLT hardware version A. To update PLT hardware version A follow the instructions in [Golden Unit](#).

Introduction Page

The first page of the tool is an introduction page with the purpose of the tool. User can exit the tool at any step by pressing the `cancel` button or close the application using the `x` button from the windows bar at the top.

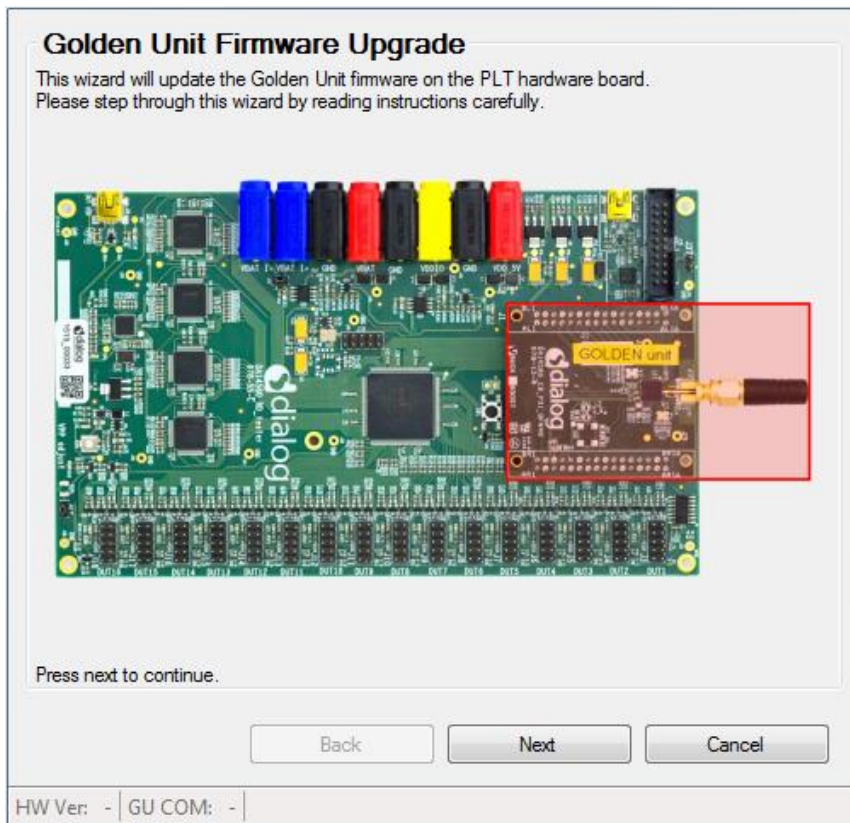

Figure 130: GU Upgrade - Introduction page

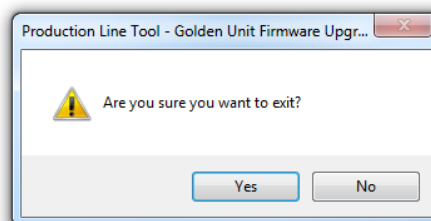

Figure 131: GU Upgrade - Exit Message

SmartBond Production Line Tool

Hardware Version

Select the PLT hardware version. Depending on the version, some options may be missing, or the tool may not support it. Selected hardware version will be shown on the left bottom corner of the tool at any of the following steps. As noted before PLT hardware version A is not supported by this tool.

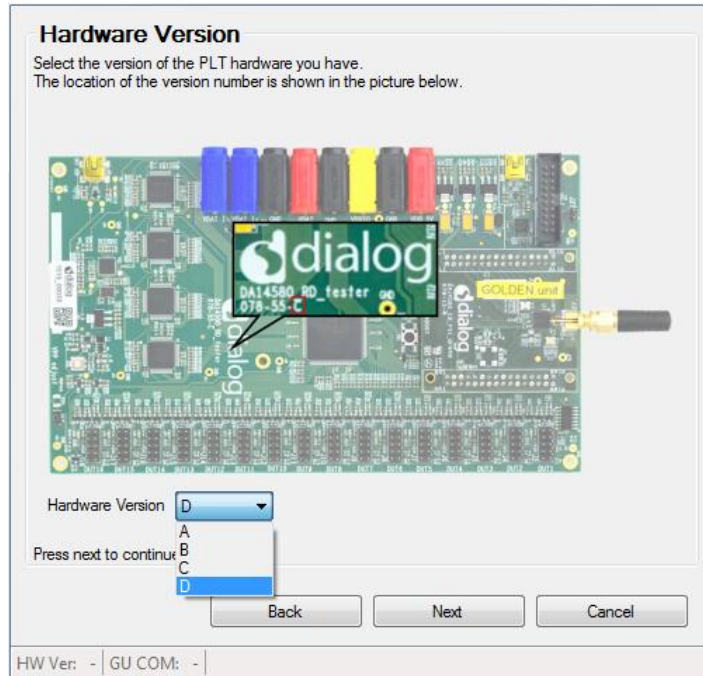

Figure 132: GU Upgrade - Hardware Version

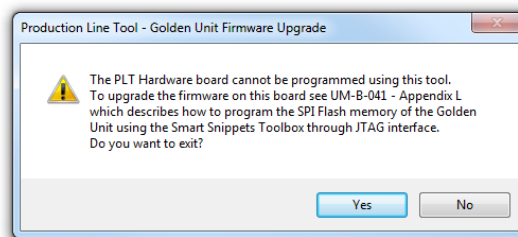

Figure 133: GU Upgrade - Hardware Version Compatibility

Power Supply

Connect the power supply of the PLT, as described in [PLT Power Supply](#) and connect the jumpers as shown in [Figure 135](#) where applicable. Adjust the jumpers as proposed by the tool.

SmartBond Production Line Tool

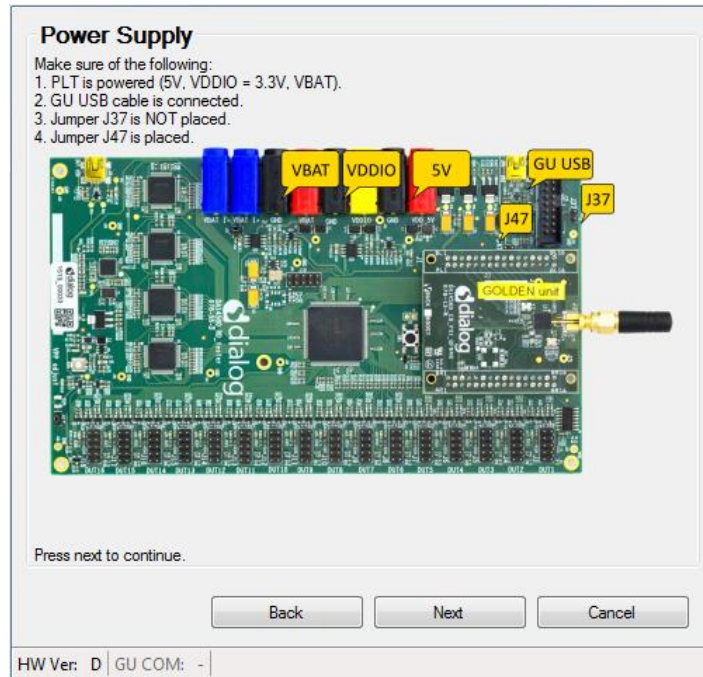

Figure 134: GU Upgrade - Power Supply

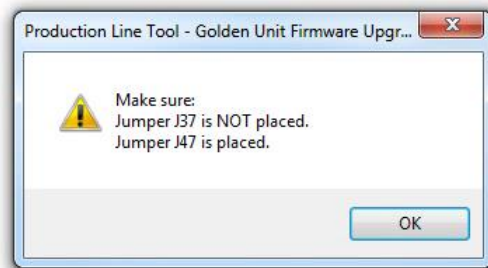

Figure 135: GU Upgrade - Power Supply Pop-Up

Golden Unit Reset

Select the way the GU will be reset. User can manually reset the GU, but PLT can do it automatically, which is the default selection. If the manual mode is selected, the user will be prompt any time the Golden Unit must be reset, to click the reset button located next to the Golden Unit on top of the PLT hardware.

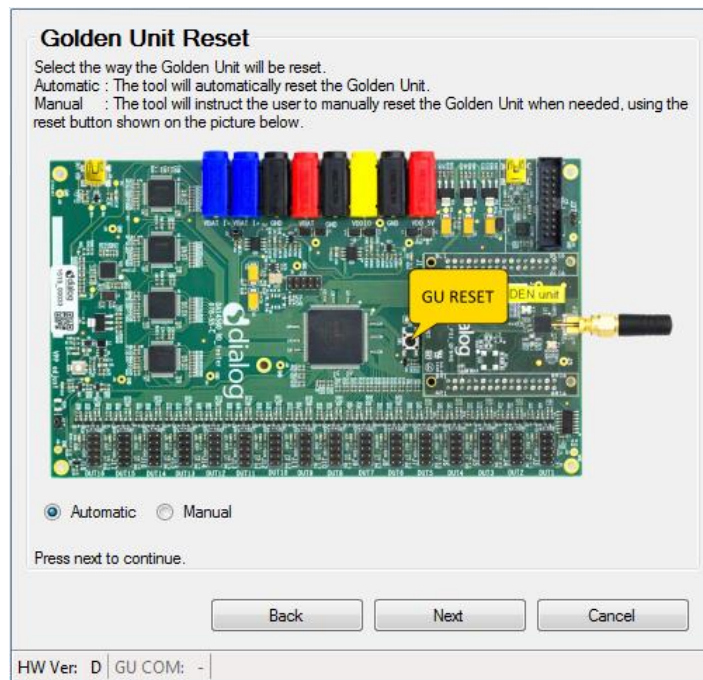

Figure 136: GU Upgrade - Golden Unit Reset

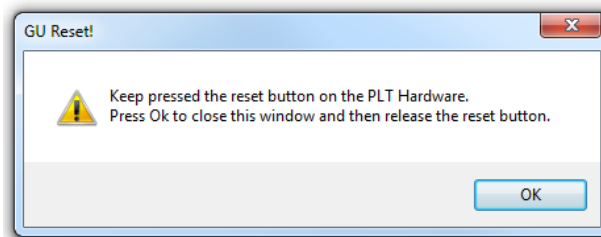

Figure 137: GU Upgrade - Golden Unit Reset Message for Manual Mode

GU COM Port

Find the windows assigned GU COM port. User can either select it from the dropdown list or use the *Auto* button to find it using the serial number as described in [Automatic GU COM Port Find](#). GU COM port can be also verified using the *Check* button. Selected GU COM port will be shown on the left bottom corner of the tool.

SmartBond Production Line Tool

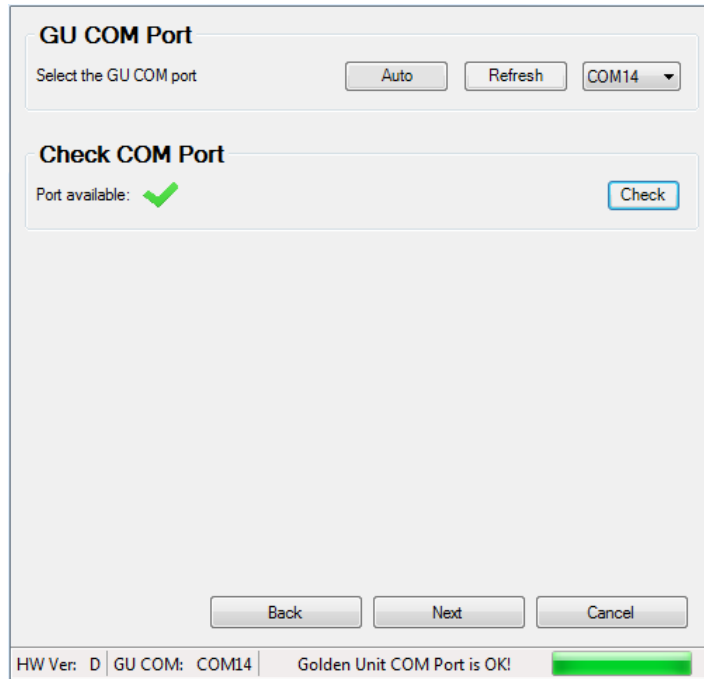

Figure 138: GU Upgrade - GU COM Port

Burn Firmware

This is the final step. Select the binary to burn.

Pressing the **Burn** button will erase the SPI Flash on the PLT hardware, program it with the new firmware selected before, and then read it back to verify that the contents written are the same as those in the binary.

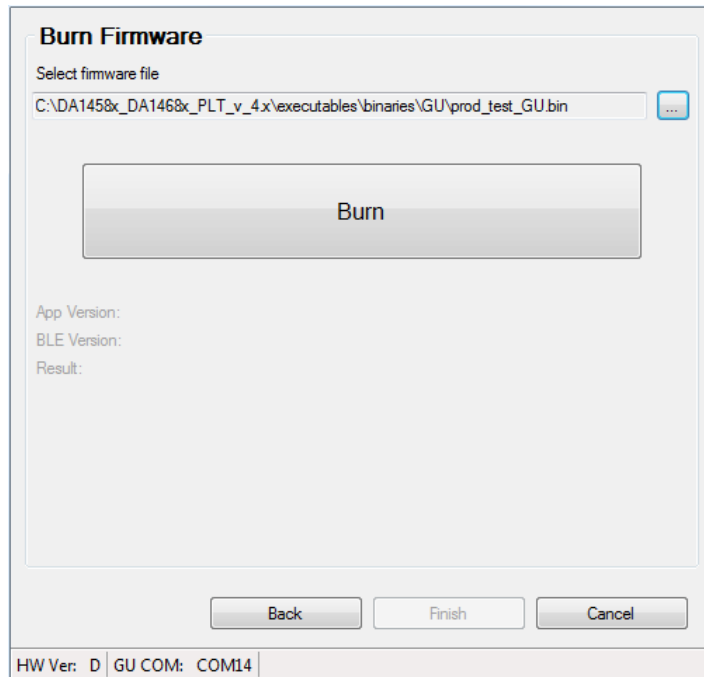

Figure 139: GU Upgrade - Burn Firmware

SmartBond Production Line Tool

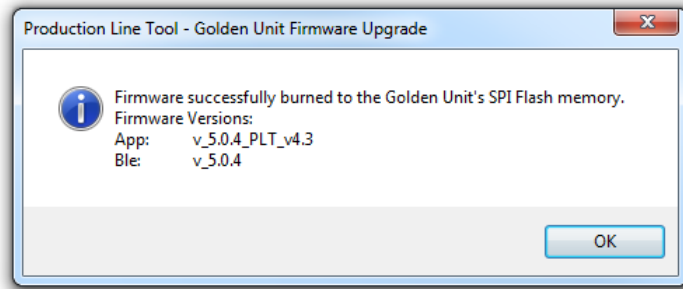

Figure 140: GU Upgrade - Burn Firmware Pop-Up Message

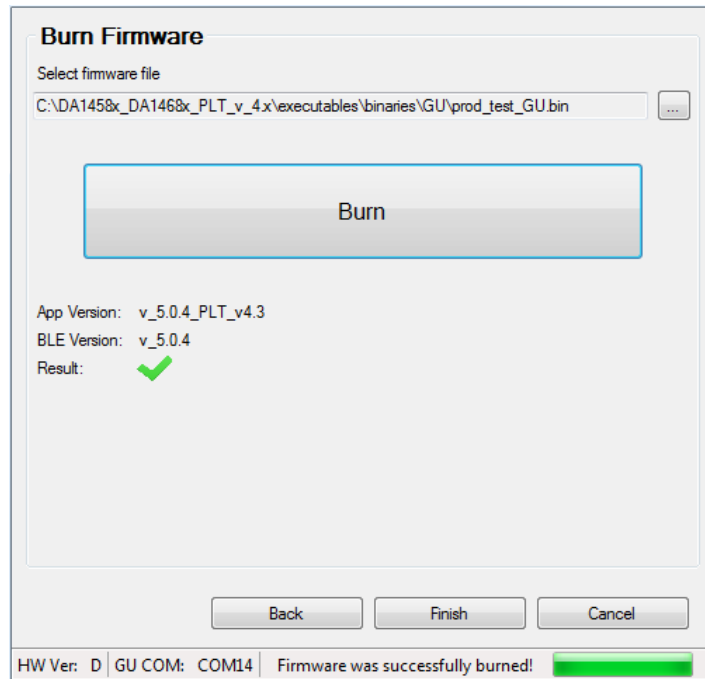

Figure 141: GU Upgrade - Burn Firmware Success

After the SPI flash program procedure is finished, a pop-up message appears with the result of the programming procedure. If the SPI flash was programmed successfully, the pop-up message will also show the version of the new Golden Unit firmware (Figure 140).

SmartBond Production Line Tool

8 Example Usage

In this section, a simple example of the PLT will be described using two DA14580 devices. The example test procedure is explained step-by-step in [Table 103](#).

The tests to run in this example are the XTAL trim, RF RSSI test, SPI erase, SPI check empty and SPI image write.

Two DUTs will be used at PLT DUT connector positions DUT1 and DUT2.

Table 103: DA14580 PLT Example Usage

Step	Description												
Hardware Connections													
1	Connect both DUTs to the PLT hardware as shown in DA1458x DK Pro Motherboard Connection . Four cables are needed. To use the SPI Flash memory, a custom triple-jumper must be used.												
CFG GUI Settings													
2	Open CFG PLT, make the following selections.												
3	<table border="1"> <thead> <tr> <th colspan="2">Hardware Setup</th> </tr> </thead> <tbody> <tr> <td> </td> <td>Device IC: Select DA14580, then Save.</td> </tr> <tr> <td> </td> <td>Golden Unit COM Port: Click on Auto, then Save.</td> </tr> <tr> <td> </td> <td>Active DUTs: Enable only DUT1 and DUT2 and Save.</td> </tr> <tr> <td> </td> <td>DUT COM Ports: Click on Enum, then Save.</td> </tr> <tr> <td> </td> <td></td> </tr> </tbody> </table>	Hardware Setup			Device IC: Select DA14580, then Save.		Golden Unit COM Port: Click on Auto, then Save.		Active DUTs: Enable only DUT1 and DUT2 and Save.		DUT COM Ports: Click on Enum, then Save.		
Hardware Setup													
	Device IC: Select DA14580, then Save.												
	Golden Unit COM Port: Click on Auto, then Save.												
	Active DUTs: Enable only DUT1 and DUT2 and Save.												
	DUT COM Ports: Click on Enum, then Save.												
4	<table border="1"> <thead> <tr> <th colspan="2">VBAT/Reset Mode</th> </tr> </thead> <tbody> <tr> <td> </td> <td>VBAT low duration: Set a time for the POR that is sufficient enough for the DUTs to discharge their capacitors during the POR.</td> </tr> <tr> <td> </td> <td>VBAT/Reset Mode: Since the DUTs will be powered from the PLT hardware and the Reset signal will not be used, use the VBAT only option.</td> </tr> </tbody> </table>	VBAT/Reset Mode			VBAT low duration: Set a time for the POR that is sufficient enough for the DUTs to discharge their capacitors during the POR.		VBAT/Reset Mode: Since the DUTs will be powered from the PLT hardware and the Reset signal will not be used, use the VBAT only option.						
VBAT/Reset Mode													
	VBAT low duration: Set a time for the POR that is sufficient enough for the DUTs to discharge their capacitors during the POR.												
	VBAT/Reset Mode: Since the DUTs will be powered from the PLT hardware and the Reset signal will not be used, use the VBAT only option.												

Step	Description					
5	General					
	<div style="border: 1px solid black; padding: 5px;"> <p>▲ Statistics</p> <p>Pass: 0 Fail: 0 Total: 0 Left: 0 Runs: 0</p> <p><input type="button" value="Reset"/></p> <p>▲ Test Options</p> <p><input checked="" type="checkbox"/> Production tests <input checked="" type="checkbox"/> Memory programming <input checked="" type="checkbox"/> Re-test failed DUTs</p> </div>	<table border="1"> <tr> <td>Statistics</td> <td>Click Reset, then Save.</td> </tr> <tr> <td>Test Options</td> <td> Enable all options then Save. Production tests should be enabled for the XTAL Trim and the RF tests to run. Memory programming is required for the QSPI erase and check empty functions. Disable the rest of the options. </td> </tr> </table>	Statistics	Click Reset, then Save.	Test Options	Enable all options then Save. Production tests should be enabled for the XTAL Trim and the RF tests to run. Memory programming is required for the QSPI erase and check empty functions. Disable the rest of the options.
Statistics	Click Reset, then Save.					
Test Options	Enable all options then Save. Production tests should be enabled for the XTAL Trim and the RF tests to run. Memory programming is required for the QSPI erase and check empty functions. Disable the rest of the options.					
6	UART					
	<div style="border: 1px solid black; padding: 5px;"> <p>▲ UART Boot Pins Setup</p> <p>TX-RX pins TX: P0_4, RX: P0_5</p> <p>▲ UART Baud Rate</p> <p>Baud Rate 1000000</p> <p>▲ UART Programming GPIOs Setup</p> <p><input type="checkbox"/> Enable</p> <p>Port TX 0 Pin TX P0_4 Port RX 0 Pin RX P0_5</p> </div>	<table border="1"> <tr> <td>UART Boot Pin Setup</td> <td>TX: P0_4, RX: P0_5</td> </tr> <tr> <td>UART Baud Rate</td> <td>1000000</td> </tr> </table>	UART Boot Pin Setup	TX: P0_4, RX: P0_5	UART Baud Rate	1000000
	UART Boot Pin Setup	TX: P0_4, RX: P0_5				
UART Baud Rate	1000000					
7	Test Settings					
	<div style="border: 1px solid black; padding: 5px;"> <p>▲ XTAL Trim</p> <p><input checked="" type="checkbox"/> Enable</p> <p>GPIO input pulse pin P0_5</p> <p><input type="checkbox"/> Burn to OTP</p> </div>	<table border="1"> <tr> <td>XTAL Trim</td> <td> Check <i>Enable</i> in XTAL Trim. Select the same pin as the <i>UART Rx</i>, <i>P0_5</i>. <i>Burn to OTP</i> is disabled </td> </tr> </table>	XTAL Trim	Check <i>Enable</i> in XTAL Trim. Select the same pin as the <i>UART Rx</i> , <i>P0_5</i> . <i>Burn to OTP</i> is disabled		
XTAL Trim	Check <i>Enable</i> in XTAL Trim. Select the same pin as the <i>UART Rx</i> , <i>P0_5</i> . <i>Burn to OTP</i> is disabled					
<div style="border: 1px solid black; padding: 5px;"> <p>RF RX test settings using the Golden Unit.</p> <p>GU_RSSI_1 (✓)</p> <p><input checked="" type="checkbox"/> Enable</p> <p>Test name GU_RSSI_1</p> <p>Settings</p> <p>Frequency 2424 MHz</p> <p>Limits</p> <p>RSSI limit >= -70.0 dBm Packet error limit < 10.0 %</p> </div>		<table border="1"> <tr> <td>RF Tests - Golden Unit</td> <td> Only one test is enabled for this example. In Golden Unit: <ul style="list-style-type: none"> • Check <i>Enable</i> • Select 2424 MHz as <i>frequency</i> • Set the <i>RSSI limit</i> to -70 dBm • Set <i>Packet error limit</i> to 10% </td> </tr> </table>	RF Tests - Golden Unit	Only one test is enabled for this example. In Golden Unit: <ul style="list-style-type: none"> • Check <i>Enable</i> • Select 2424 MHz as <i>frequency</i> • Set the <i>RSSI limit</i> to -70 dBm • Set <i>Packet error limit</i> to 10% 		
RF Tests - Golden Unit	Only one test is enabled for this example. In Golden Unit: <ul style="list-style-type: none"> • Check <i>Enable</i> • Select 2424 MHz as <i>frequency</i> • Set the <i>RSSI limit</i> to -70 dBm • Set <i>Packet error limit</i> to 10% 					

SmartBond Production Line Tool

Step	Description																									
8	<p>Memory Functions</p> <div style="display: flex; justify-content: space-between;"> <div style="width: 45%;"> <p>SPI write 1</p> <p><input checked="" type="checkbox"/> Write enable</p> <p>Test name <input type="text"/></p> <p>Write image in chunks of <input type="text" value="3960"/> bytes</p> <p><input checked="" type="checkbox"/> Verify image</p> <p><input checked="" type="checkbox"/> Bootable image</p> <p>Start address 0x <input type="text" value="00000000"/></p> <p><input type="checkbox"/> Different image per DUT</p> <p>Image path <input type="text" value="binaries\prox_reporter_580.bin"/></p> </div> <div style="width: 30%;"> <p>Write 1 test</p> </div> <div style="width: 20%;"> <p>Check Write enable</p> <p>Check Verify image</p> <p>Check Bootable image</p> <p>Make sure prox_reporter_580.bin is selected.</p> </div> </div>																									
9	OTP Header																									
	General	Disable all options																								
	BD address	Disable all options																								
GUI PLT																										
10	<p>Open GUI PLT.</p> <p>The screenshot shows the GUI PLT interface with the following elements:</p> <ul style="list-style-type: none"> File Edit Run menu bar. Start BD address: 00:00:00:00:00:01 Next BD address: 00:00:00:00:00:01 End BD address: 00:00:00:00:00:00 Statistics: Pass: 0, Fail: 0, Total: 0, Left: 0, Runs: 0 IC: DA14580 Options: <input type="checkbox"/> COM Enum, <input type="checkbox"/> GU Check, <input type="checkbox"/> VBAT/UART Tables: <table border="1" style="margin-bottom: 10px;"> <thead> <tr> <th>DUT</th> <th>BD Address</th> <th>Code</th> <th>Status</th> <th>Result</th> </tr> </thead> <tbody> <tr> <td>1</td> <td>00:00:00:00:00:01</td> <td></td> <td></td> <td></td> </tr> <tr> <td>2</td> <td>00:00:00:00:00:02</td> <td></td> <td></td> <td></td> </tr> </tbody> </table> <table border="1"> <thead> <tr> <th>GU</th> <th>COM Port</th> <th>Code</th> <th>Status</th> <th>Result</th> </tr> </thead> <tbody> <tr> <td></td> <td>COM4</td> <td></td> <td></td> <td></td> </tr> </tbody> </table> BLE Tester, Temp, Voltmeter section with empty input fields. START button. Footer: C:\Release\params\params.xml Retest failed: Enabled Test Time: 00:00:00 	DUT	BD Address	Code	Status	Result	1	00:00:00:00:00:01				2	00:00:00:00:00:02				GU	COM Port	Code	Status	Result		COM4			
DUT	BD Address	Code	Status	Result																						
1	00:00:00:00:00:01																									
2	00:00:00:00:00:02																									
GU	COM Port	Code	Status	Result																						
	COM4																									

SmartBond Production Line Tool

Step	Description				
11	<p>Press Space Bar to begin testing</p> <p>The following screenshot shows the UART channels (in red) for both DUTs for the entire PLT run. The green marks are the timings between each of the active tests.</p> <p>Log files for both the DUTs are created. The following screenshot shows the test steps from the log file of DUT1 with the timing marks from the logic analyzer capture. These marks are described below. From the log file, the total time of each test can be calculated.</p> <pre> <time> <action> <pass/fail> <info> ##### 17:51:11.321 DUT_UDLL_FW_DOWNLOAD_INIT T1 STARTED UDLL firmware download initialized. Firmware 17:51:11.355 DUT_UDLL_FW_DOWNLOAD_START STARTED UDLL firmware download started OK. Firmware 17:51:15.646 DUT_UDLL_FW_DOWNLOAD_OK PASS UDLL firmware downloaded OK. Firmware is=(17:51:15.652 DUT_UDLL_FW_DOWNLOAD_OK PASS UDLL firmware downloaded OK. Firmware is=(17:51:15.873 DUT_PDLL_COM_PORT_INIT T2 STARTED Device pdll COM port open initialized. 17:51:15.899 DUT_PDLL_COM_PORT_START STARTED Device pdll COM port open started. 17:51:15.928 DUT_PDLL_COM_PORT_OK PASS Device pdll COM port opened OK. 17:51:15.982 DUT_PDLL_FW_VERSION_GET_START STARTED Device pdll Firmware version get started. 17:51:16.003 DUT_PDLL_FW_VERSION_GET_OK PASS Device pdll Firmware version get OK. PDLL v 17:51:16.008 DUT_PDLL_XTAL_TRIM_INIT T3 STARTED XTAL trim operation initialized. 17:51:16.028 DUT_PDLL_XTAL_TRIM_START STARTED XTAL trim operation started. 17:51:18.141 DUT_PDLL_XTAL_TRIM_OK PASS XTAL trim operation ended OK. 17:51:18.207 DUT_PDLL_UART_RESYNC_INIT STARTED UART resync process initialized. 17:51:18.234 DUT_PDLL_UART_RESYNC_START STARTED UART resync process started. 17:51:18.249 DUT_PDLL_UART_RESYNC_OK PASS UART resync process OK. 17:51:18.259 DUT_PDLL_XTAL_TRIM_READ_INIT STARTED XTAL trim value read initialized. 17:51:18.283 DUT_PDLL_XTAL_TRIM_READ_START STARTED XTAL trim value read started. 17:51:18.309 DUT_PDLL_XTAL_TRIM_READ_OK PASS XTAL trim value read OK. Value is=[1428]. 17:51:18.316 DUT_PDLL_PKT_RX_STATS_START_INIT T4 STARTED RF RX packet test with statistics start ini 17:51:18.342 DUT_PDLL_PKT_RX_STATS_START STARTED RF RX packet test with statistics start. 17:51:18.367 DUT_PDLL_PKT_RX_STATS_STARTED_OK PASS RF RX packet test with statistics started (17:51:18.686 DUT_PDLL_PKT_RX_STATS_STOP_INIT STARTED RF RX packet test with statistics stop init 17:51:18.712 DUT_PDLL_PKT_RX_STATS_STOP_START STARTED RF RX packet test with statistics stop. 17:51:18.729 DUT_PDLL_PKT_RX_STATS_STOPPED_OK PASS RF RX packet test with statistics stopped (17:51:18.739 DUT_PDLL_GU_RF_RX_TEST_PASSED PASS (Golden Unit RF RX packet test PASSED. Freq 17:51:20.280 DUT_UDLL_FW_DOWNLOAD_INIT T5 STARTED UDLL firmware download initialized. Firmware 17:51:20.319 DUT_UDLL_FW_DOWNLOAD_START STARTED UDLL firmware download started OK. Firmware 17:51:22.056 DUT_UDLL_FW_DOWNLOAD_OK PASS UDLL firmware downloaded OK. Firmware is=(17:51:22.065 DUT_UDLL_FW_DOWNLOAD_OK PASS UDLL firmware downloaded OK. Firmware is=(17:51:22.072 DUT_UDLL_FW_VER_GET_INIT T6 STARTED UDLL 'firmware version get' operation initi 17:51:22.092 DUT_UDLL_FW_VER_GET_STARTED STARTED UDLL 'firmware version get' operation start 17:51:22.106 DUT_UDLL_FW_VER_GET_OK PASS UDLL 'firmware version get' operation endec 17:51:22.113 DUT_UDLL_SPI_ERASE_INIT T7 STARTED SPI erase operation initialized. 17:51:22.131 DUT_UDLL_SPI_ERASE_STARTED STARTED SPI erase operation started. Erase all SPI 17:51:22.318 DUT_UDLL_SPI_ERASE_OK PASS SPI erase operation ended OK. Erase all SPI 17:51:22.335 DUT_UDLL_SPI_CHECK_EMPTY_INIT T8 STARTED SPI check empty operation initialized. 17:51:22.360 DUT_UDLL_SPI_CHECK_EMPTY_STARTED STARTED SPI check empty operation started, all SPI 17:51:23.496 DUT_UDLL_SPI_CHECK_EMPTY_OK PASS SPI check empty operation ended OK. all SPI 17:51:23.500 DUT_UDLL_SPI_IMG_WR_INIT T9 STARTED SPI image write operation initialized. Image 17:51:23.524 DUT_UDLL_SPI_IMG_WR_STARTED STARTED SPI image write operation started. Image tr 17:51:24.663 DUT_UDLL_SPI_IMG_WR_OK PASS SPI image write operation ended OK. Image i T10 </pre> <table border="1"> <tr> <td>T1</td> <td>The firmware download (prod_test_580.bin) begins. From the log file, the test lasted for about 4.3 s, which can be verified from the logic analyzer capture.</td> </tr> <tr> <td>T2</td> <td>PLT begins the operation to get the version of the prod_test_580.bin firmware.</td> </tr> </table>	T1	The firmware download (prod_test_580.bin) begins. From the log file, the test lasted for about 4.3 s, which can be verified from the logic analyzer capture.	T2	PLT begins the operation to get the version of the prod_test_580.bin firmware.
T1	The firmware download (prod_test_580.bin) begins. From the log file, the test lasted for about 4.3 s, which can be verified from the logic analyzer capture.				
T2	PLT begins the operation to get the version of the prod_test_580.bin firmware.				

SmartBond Production Line Tool

Step	Description
11 cont.	
T3	<p>After the firmware version was acquired the XTAL Trim test begins. The 500 ms reference pulse in the DUT RX channel is shown with blue letters. This test lasted for 2.3 s including the UART resync.</p>
T4	<p>The RF RX RSSI test begins.</p>
T5	<p>The firmware download (<code>flash_programmer_58x.bin</code>) begins. Checking the log file, the test lasted about 1.8 s. This can also be verified by looking the timing difference between T5-T4 at the first oscilloscope capture.</p>
T6	<p>PLT begins the operation to get the version of the <code>flash_programmer.bin</code> firmware.</p>
T7	<p>The SPI erase action begins. As with any SPI operation, first, a command to set the SPI bus pins is used and then the erase command. The blocks of data after the SPI erase and before the SPI check empty are SPI traffic on P0_5, which is the UART RX and the SPI MISO pin at the same time.</p>
T8	<p>The SPI check empty action begins. As with any SPI operation, first, a command to set the SPI bus pins is used and then the check empty command. The blocks of data after the SPI check empty and before the SPI image write are SPI traffic on P0_5, which is the UART RX and the SPI MISO pin at the same time.</p>
11 cont.	<p>T9 The SPI image write operation begins. First, the image is written, as shown in the screenshot above, and then the contents are read back for verification. The blocks of data after the SPI image write and before the SPI image verification are SPI traffic on P0_5, which is the UART RX and the SPI MISO pin at the same time.</p>

SmartBond Production Line Tool

Step	Description																																																																																																																																																												
T10	<p>The PLT run has finished.</p> <p>After the tests have finished, the log and CSV files are fully updated. The GUI PLT test counter on the bottom right of the screen indicates that the test took approximately 15 s. This is verified from both the log files and the CSV file. Both files are shown below.</p> <pre> Software: DA1458x/DA1468x Production Line Software version: v_4.1.0.132 PLTD DLL version: v_4.1.0.132 PDLL Version: v_4.1.0.132 UDLL Version: v_4.1.0.132 Production test BLE firmware version: v_5.0.4 Production test APP firmware version: v_5.0.4_PLT_v4.1 Flash programmer firmware version: v_5.0.4_PLT_v4.1 Date: 2017-08-11 Start Time: 17:32:31.403 End Time: 17:32:49.038 Station ID: Test_station_1 Device ID: 1 COM port: 184 BD address: 00:00:55:00:00:01 </pre>																																																																																																																																																												
11 cont.	<table border="1"> <thead> <tr> <th></th> <th>A</th> <th>B</th> <th>C</th> <th>D</th> <th>E</th> <th>F</th> <th>T1</th> <th>G</th> </tr> </thead> <tbody> <tr> <td>1</td> <td>Start time</td> <td>End time</td> <td>DUT</td> <td>BD address</td> <td>Overall status</td> <td>COM port</td> <td>FW download</td> <td>1</td> </tr> <tr> <td>2</td> <td>18:54:14</td> <td>18:54:29</td> <td>1</td> <td>00:00:55:00:00:01</td> <td>PASS</td> <td>25</td> <td>PASS</td> <td></td> </tr> <tr> <td>3</td> <td>18:54:14</td> <td>18:54:29</td> <td>2</td> <td>00:00:55:00:00:02</td> <td>PASS</td> <td>26</td> <td>PASS</td> <td></td> </tr> <tr> <th></th> <th>H</th> <th>T2</th> <th>I</th> <th>J</th> <th>T3</th> <th>K</th> <th>L</th> <th>T4</th> <th>M</th> </tr> <tr> <td></td> <td>FW path 1</td> <td>FW version get 1</td> <td>FW version 1</td> <td>XTAL trim test</td> <td>XTAL trim</td> <td>GU RX test 1</td> <td></td> <td></td> <td></td> </tr> <tr> <td></td> <td>C:\Users\pd</td> <td>PASS</td> <td>v_5.0.4</td> <td>PASS</td> <td>1426</td> <td>PASS</td> <td></td> <td></td> <td></td> </tr> <tr> <td></td> <td>C:\Users\pd</td> <td>PASS</td> <td>v_5.0.4</td> <td>PASS</td> <td>1346</td> <td>PASS</td> <td></td> <td></td> <td></td> </tr> <tr> <th></th> <th>N</th> <th>T5</th> <th>O</th> <th>P</th> <th>T6</th> <th>Q</th> <td></td> <td></td> <td></td> </tr> <tr> <td></td> <td>GU RX RSSI 1</td> <td>FW download 2</td> <td>FW path 2</td> <td>FW version get 2</td> <td></td> <td></td> <td></td> <td></td> <td></td> </tr> <tr> <td></td> <td>-31.82</td> <td>PASS</td> <td>C:\Users\pd</td> <td>PASS</td> <td></td> <td></td> <td></td> <td></td> <td></td> </tr> <tr> <td></td> <td>-21.87</td> <td>PASS</td> <td>C:\Users\pd</td> <td>PASS</td> <td></td> <td></td> <td></td> <td></td> <td></td> </tr> <tr> <th></th> <th>R</th> <th>T7</th> <th>S</th> <th>T8</th> <th>T</th> <th>T9</th> <th>U</th> <th>V</th> <th>T10</th> </tr> <tr> <td></td> <td>FW version 2</td> <td>SPI erase 1</td> <td>SPI empty 1</td> <td>SPI burn 1</td> <td>SPI image 1</td> <td></td> <td></td> <td></td> <td></td> </tr> <tr> <td></td> <td>v_3.0.11.554</td> <td>PASS</td> <td>PASS</td> <td>PASS</td> <td>binaries\prox_reporte</td> <td></td> <td></td> <td></td> <td></td> </tr> <tr> <td></td> <td>v_3.0.11.554</td> <td>PASS</td> <td>PASS</td> <td>PASS</td> <td>binaries\prox_reporte</td> <td></td> <td></td> <td></td> <td></td> </tr> </tbody> </table>		A	B	C	D	E	F	T1	G	1	Start time	End time	DUT	BD address	Overall status	COM port	FW download	1	2	18:54:14	18:54:29	1	00:00:55:00:00:01	PASS	25	PASS		3	18:54:14	18:54:29	2	00:00:55:00:00:02	PASS	26	PASS			H	T2	I	J	T3	K	L	T4	M		FW path 1	FW version get 1	FW version 1	XTAL trim test	XTAL trim	GU RX test 1					C:\Users\pd	PASS	v_5.0.4	PASS	1426	PASS					C:\Users\pd	PASS	v_5.0.4	PASS	1346	PASS					N	T5	O	P	T6	Q					GU RX RSSI 1	FW download 2	FW path 2	FW version get 2							-31.82	PASS	C:\Users\pd	PASS							-21.87	PASS	C:\Users\pd	PASS							R	T7	S	T8	T	T9	U	V	T10		FW version 2	SPI erase 1	SPI empty 1	SPI burn 1	SPI image 1						v_3.0.11.554	PASS	PASS	PASS	binaries\prox_reporte						v_3.0.11.554	PASS	PASS	PASS	binaries\prox_reporte				
	A	B	C	D	E	F	T1	G																																																																																																																																																					
1	Start time	End time	DUT	BD address	Overall status	COM port	FW download	1																																																																																																																																																					
2	18:54:14	18:54:29	1	00:00:55:00:00:01	PASS	25	PASS																																																																																																																																																						
3	18:54:14	18:54:29	2	00:00:55:00:00:02	PASS	26	PASS																																																																																																																																																						
	H	T2	I	J	T3	K	L	T4	M																																																																																																																																																				
	FW path 1	FW version get 1	FW version 1	XTAL trim test	XTAL trim	GU RX test 1																																																																																																																																																							
	C:\Users\pd	PASS	v_5.0.4	PASS	1426	PASS																																																																																																																																																							
	C:\Users\pd	PASS	v_5.0.4	PASS	1346	PASS																																																																																																																																																							
	N	T5	O	P	T6	Q																																																																																																																																																							
	GU RX RSSI 1	FW download 2	FW path 2	FW version get 2																																																																																																																																																									
	-31.82	PASS	C:\Users\pd	PASS																																																																																																																																																									
	-21.87	PASS	C:\Users\pd	PASS																																																																																																																																																									
	R	T7	S	T8	T	T9	U	V	T10																																																																																																																																																				
	FW version 2	SPI erase 1	SPI empty 1	SPI burn 1	SPI image 1																																																																																																																																																								
	v_3.0.11.554	PASS	PASS	PASS	binaries\prox_reporte																																																																																																																																																								
	v_3.0.11.554	PASS	PASS	PASS	binaries\prox_reporte																																																																																																																																																								

Appendix A Top View of PLT PCB Version D

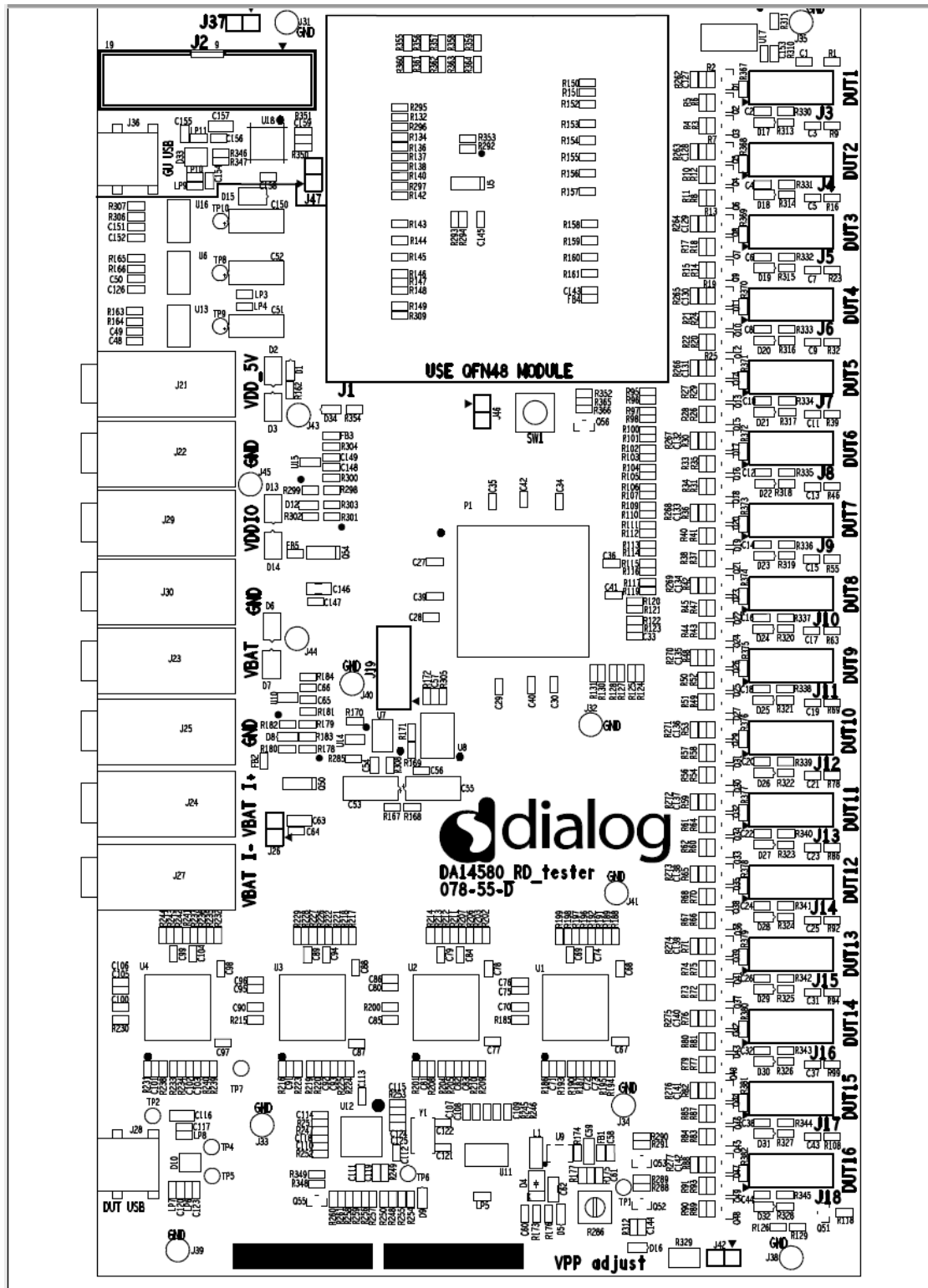

Figure 142: Top View of PLT PCB Version D

Appendix B Electrical Schematics

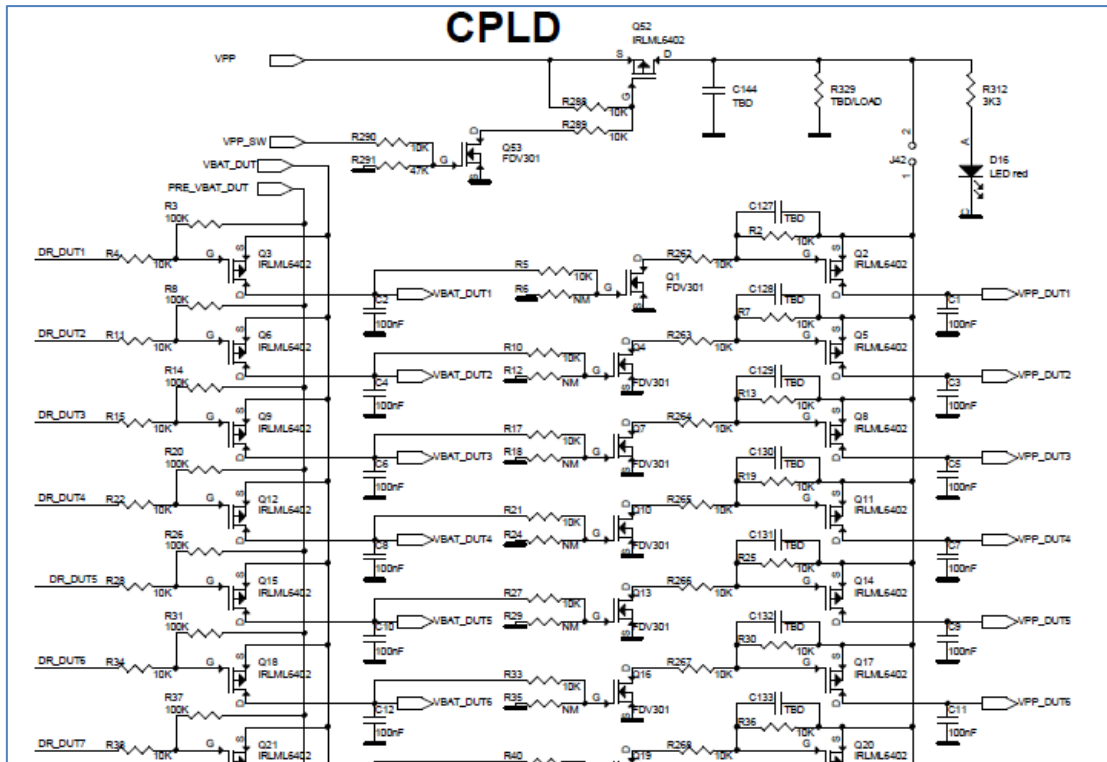

Figure 143: VBAT and VPP Control from CPLD

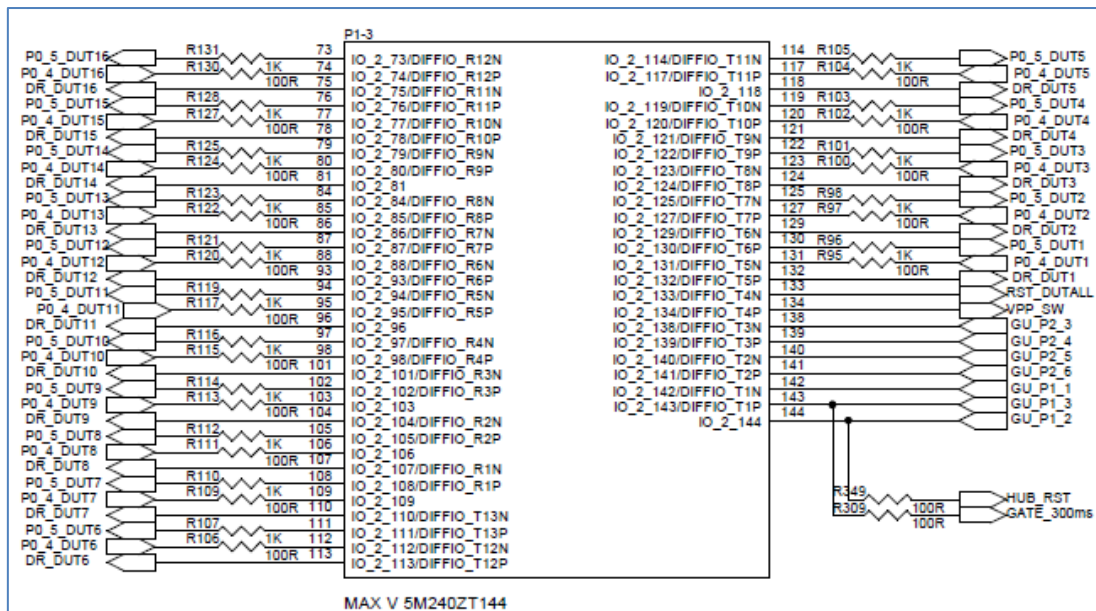

Figure 144: CPLD DUT UART Connections

SmartBond Production Line Tool

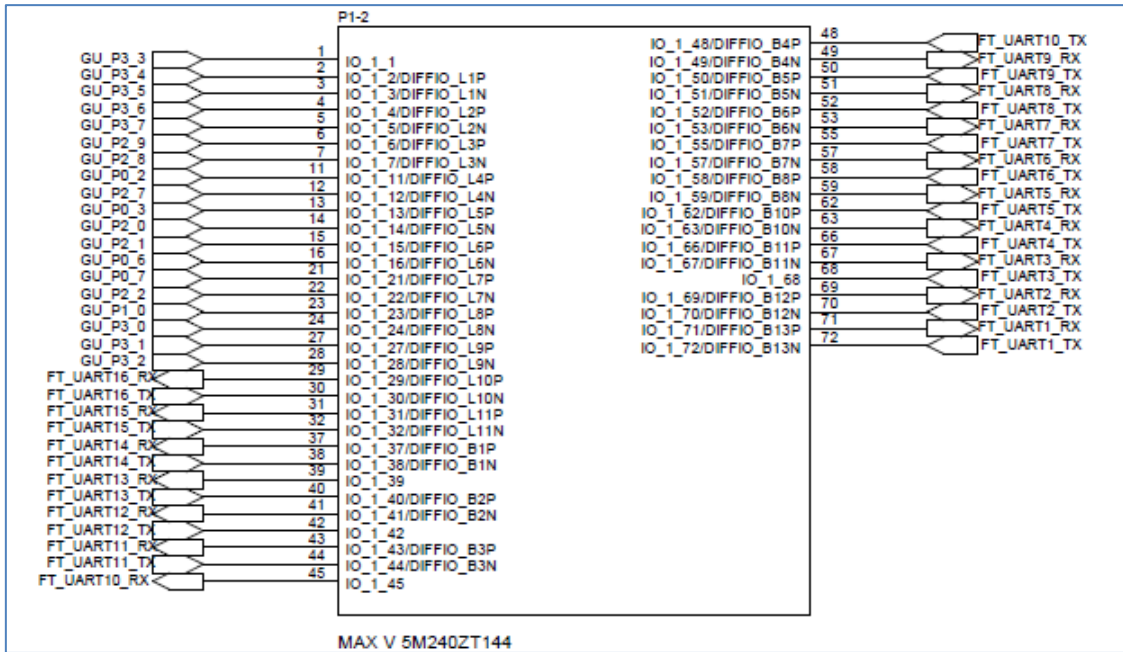

Figure 145: CPLD FTDI and GU Control Connections

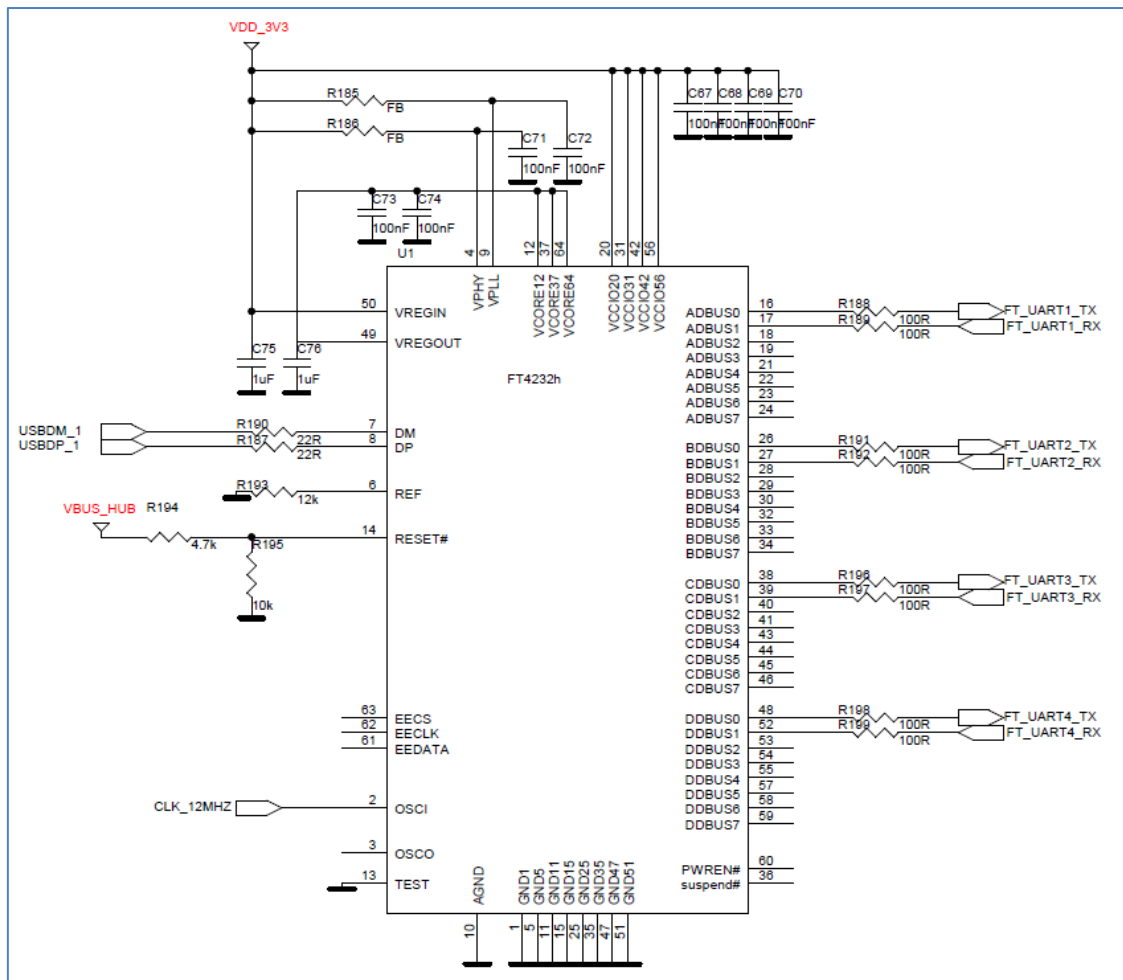

Figure 146: FTDI Chip for USB UART to DUTs 1, 2, 3 and 4

SmartBond Production Line Tool

USB HUB: provides 5 V input for the 3.3 V LDO and USB input-signals to the four Quad FTDI chips.

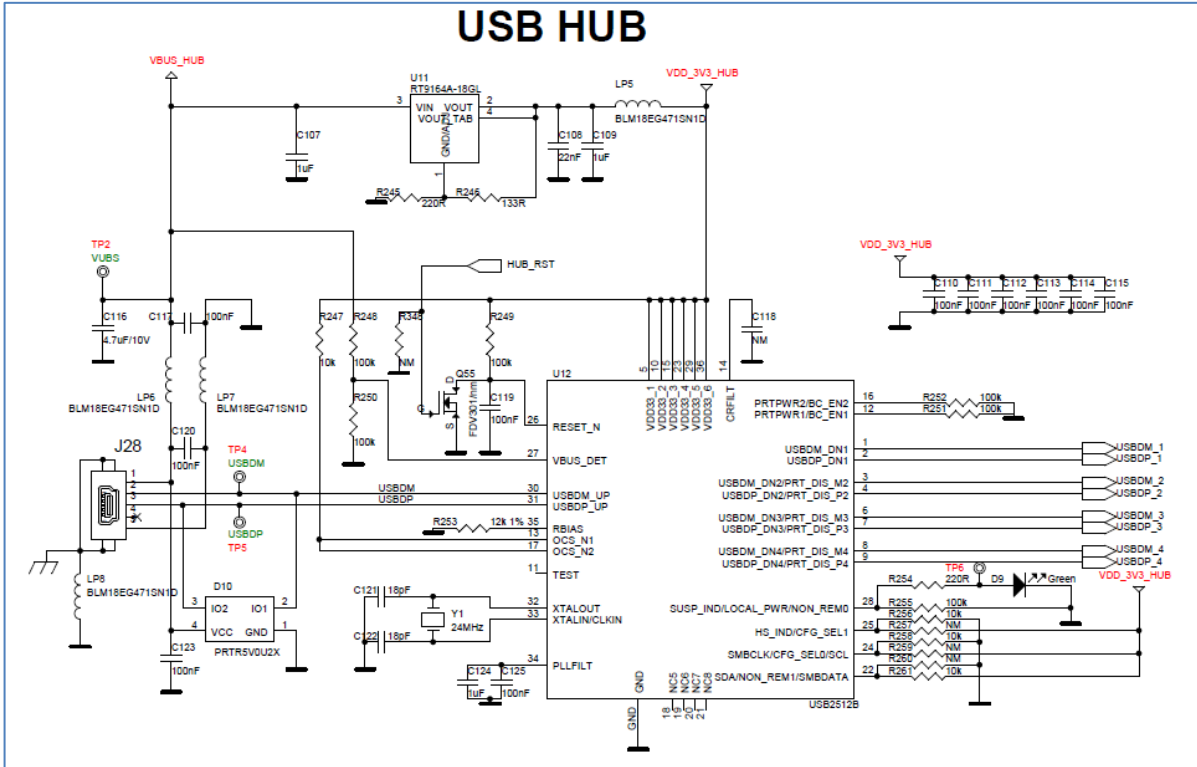

Figure 147: Quad USB HUB

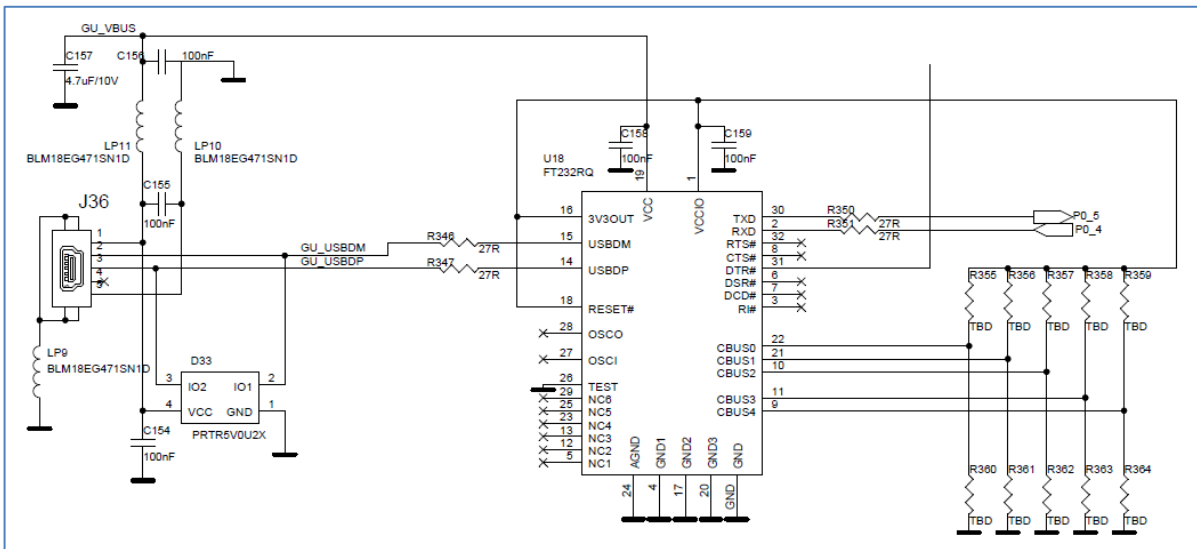

Figure 148: Golden Unit - Dedicated USB Port and FTDI Chip

SmartBond Production Line Tool

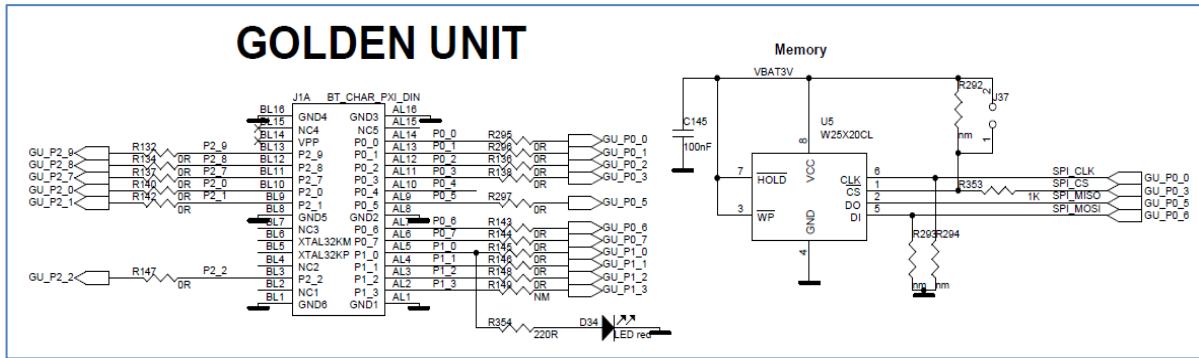

Figure 149: Golden Unit - GU LED and SPI Flash Memory

The Golden Unit SW (prod_test_GU.bin) is located in the SPI Flash memory mounted on the PLT hardware and is loaded into the GU's system RAM when powered on.

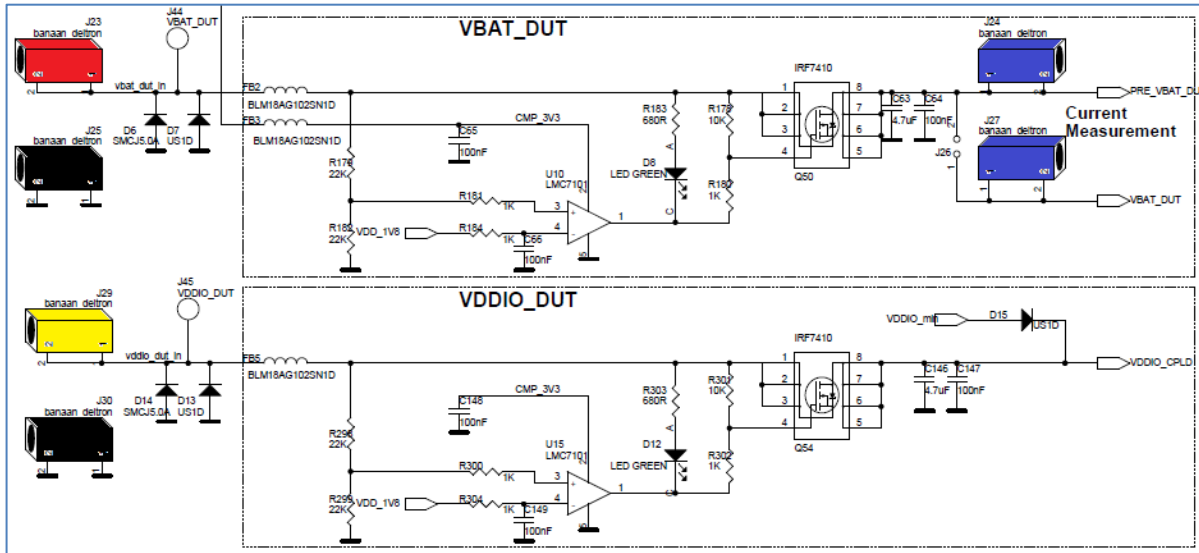

Figure 150: VBAT_DUT and VDDIO Supplies

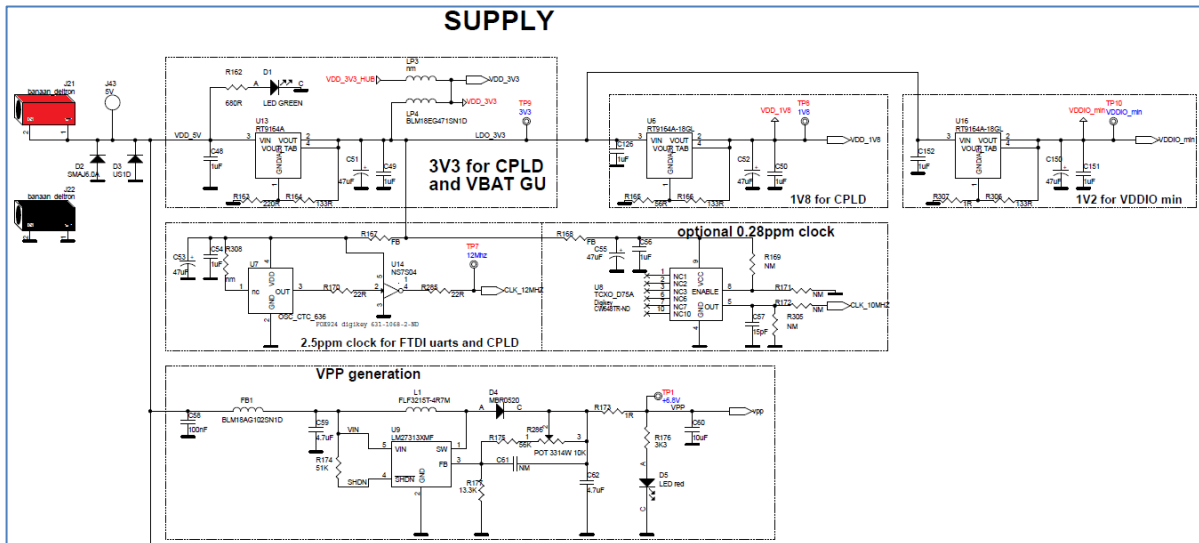

Figure 151: GU Supply and VPP Generation

Appendix C Hardware Modifications PLT Version D

In the PLT hardware version D, there is a small modification. Resistor R365 (10 kΩ) and jumper J47 are added in series to the GU reset circuit.



Figure 152: DA14580_RD_tester Version D

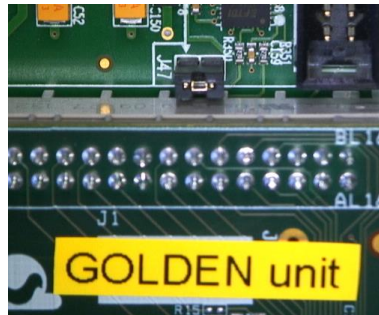

Figure 153: Jumper J47 Added Next to Golden Unit Socket

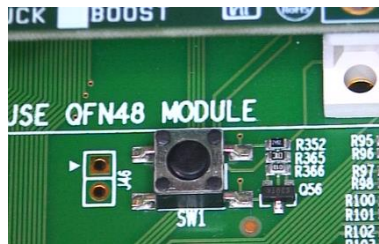

Figure 154: R365 (10 kΩ) Added Next to Reset Button

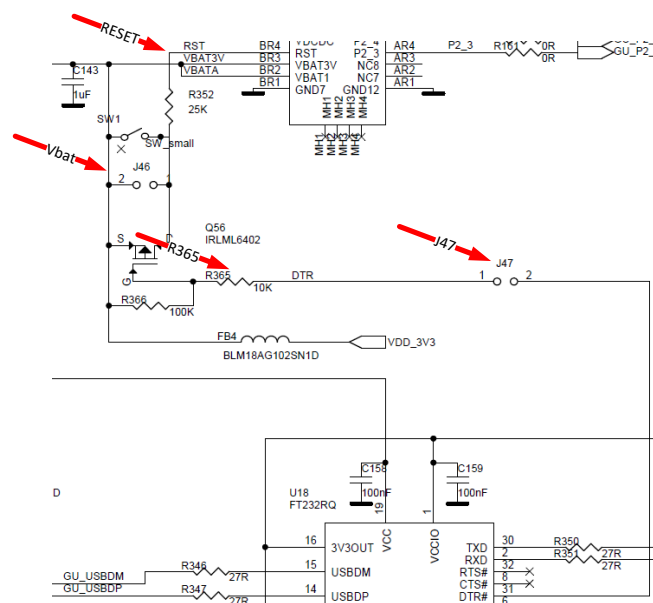

Figure 155: R365, J47 and RESET Shown in Electrical Schematic

SmartBond Production Line Tool

Appendix D Application Hardware Design Considerations

When the Production Line Tool (PLT) is used, one should be aware of the following items:

- Vpp PLT connection signal is used only for DA14580/1/2/3 devices
- 1-Wire UART needs only one UART pin connection to the device (see [Figure 6](#)). It is only used for DA1453x devices
- One could consider adding additional pads to the design for future debugging, not related to PLT, like pins for SWD
- Pads are, in most cases, placed on the rear side of the circuit board. They should be gold plated. Dimensions of these pads are crucial and have to do with the stability and accuracy of the pogo-pins that connect to the PLT HW. They should not be designed too critical. Long pogo pins might bend during production testing
- Optionally, holes can be added for guiding-pins that fit on the test jig used for the PCB or panel
- Orientation of the antenna used on the application board will impact the RSSI-value. When panels are used, this RSSI will vary, dependent on the distance to the GU antenna on the PLT. In the PLT software an RSSI-offset can be added for each DUT location to compensate for these differences

More reference documentation is available on the Dialog website:

- AN-B-054, DA1458x/DA1468x Application Hardware Design Guidelines, Application Note, Dialog Semiconductor.
https://www.dialog-semiconductor.com/sites/default/files/an-b-054_da14585_da14586_application_hardware_design_guidelines_v1.2.pdf
- AN-B-061, DA1468x Application Hardware Design Guidelines, Application Note, Dialog Semiconductor.
https://www.dialog-semiconductor.com/sites/default/files/an-b-061_da1468x_application_hardware_design_guidelines_v1.9.pdf
- AN-B-066, DA1469x Hardware Guidelines, Application Note, Dialog Semiconductor.
https://www.dialog-semiconductor.com/sites/default/files/an-b-066_da1469x_application_hardware_design_guidelines_rev1.4.pdf
- AN-B-075, DA14531 Hardware Guidelines, Application Note, Dialog Semiconductor.
https://www.dialog-semiconductor.com/sites/default/files/an-b-075_da14531_hardware_guidelines_1v3_0.pdf

SmartBond Production Line Tool

Appendix E Suggestions about Hardware and Cabling

When connecting the PLT to the DUTs, special care should be taken regarding cabling.

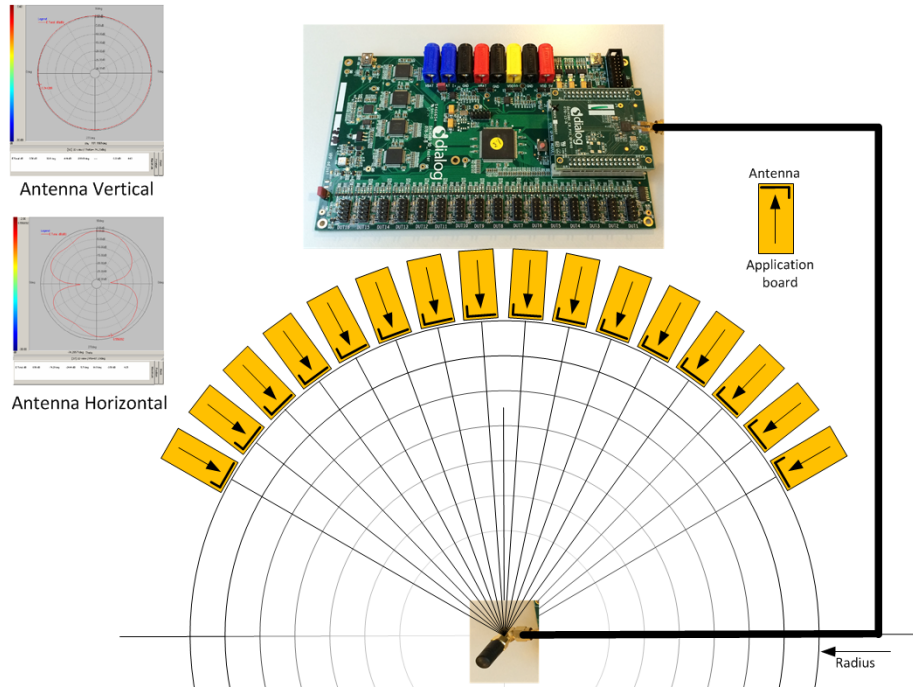

Figure 156: Possible Solution of Antenna on Cable and Fixed Radius of DUTs to Antenna

The user should realize that the PLT system is equipped with RF transmitters and receivers. These parts may induce noise on hardware and cables. Take note of the following:

- The direction of the GU antenna to the DUT antenna will influence the RSSI value
- The distance of the DUT antenna to the GU antenna (radius) will influence the RSSI value
- The control lines from the PLT to the DUTs must be kept as short as possible
- A vertical GU antenna has different characteristics from a horizontal one, see [Figure 156](#)

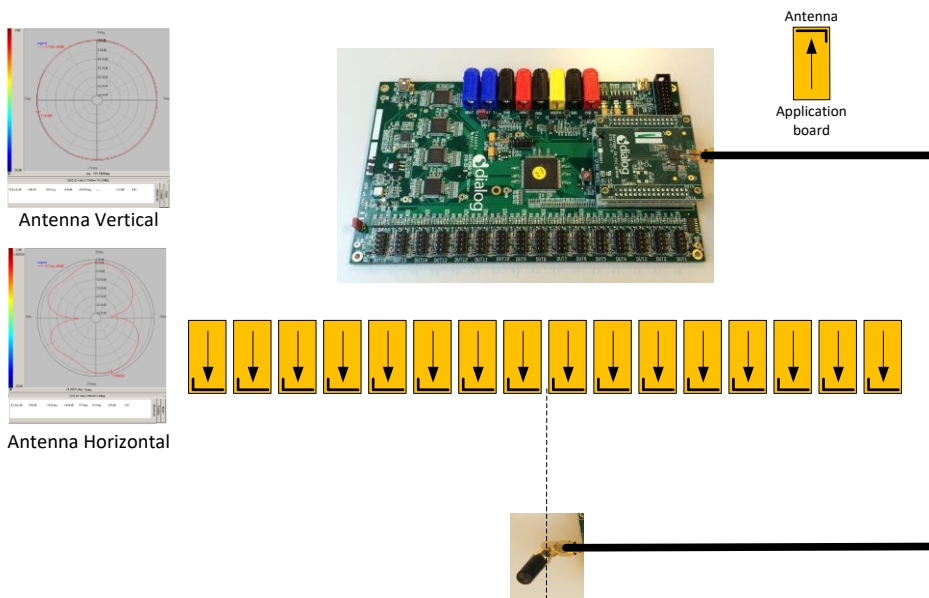

Figure 157: Possible Solution of Antenna on Cable and DUTs Put in Line

SmartBond Production Line Tool

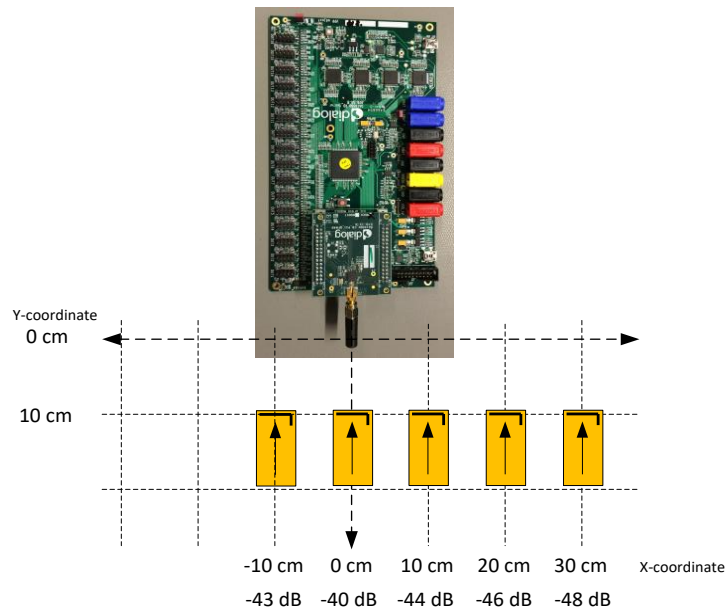

Figure 158: Example Locations and RSSI Readouts of Horizontal Antenna

Figure 158 shows the measured values from Table 104.

Table 104: RF Test RSSI Results

Test	Distance (cm)	Offset (cm)	RSSI (dBm)	Description
1	10	0	-40	DUT and GU boards are inline.
2	10	-10	-43	DUT moved 10 cm to the left relative to the GU.
3	10	10	-44	DUT moved 10 cm to the right relative to the GU.
4	10	20	-46	DUT moved 20 cm to the right relative to the GU.
5	10	30	-48	DUT moved 30 cm to the right relative to the GU.
6	10	normal	-40	DUT and GU boards are inline, functioning normally.
7	10	defect 1	-60 ~ -70	Coupling capacitor not soldered well, missing or damaged.
8	10	defect 2	~ -60	Short circuited shunt matching inductor (e.g. solder bridge)
9	10	defect 3	< -100	16 MHz crystal oscillator not working well. Received packets ~ 0.

Golden Unit output power = 0 dBm

For more details on the RF setup, refer to [12] and Appendix F.

Appendix F RF Path Losses Calibration

To accurately perform radiated tests for 16 DUTs using the Golden Unit or a BLE tester, one should calibrate the setup to know what RSSI value can be expected for non-problematic devices. Because the distance and the position of each of the 16 DUTs to the GU RF antenna are different, the calibration process calculates the different path losses to compensate for these differences. The calculated values are applied to the Production Line Tool configuration as RF path losses (DA14531 - Path Losses per DUT, DA1469x - Path Losses per DUT), which are actually added in the RSSI result.

This chapter describes the process to calculate the RF path losses for each different DUT position.

F.1 Prerequisites

Table 105 illustrates the prerequisites needed for performing the RF path loss calibration procedure.

Table 105: Prerequisites

#	Requirements	Description
1	1 PLT board	1 PLT board with Golden Unit. Power supply for the PLT. USB cables for the PLT to the PC.
2	<10 PCBA with 16 DUTs each	At least 10 PCBAs. The more PCBAs used the better. The PCBAs selected should all work as good as possible. If a fault device is identified on a PCBA that PCBA should be replaced.
3	1 shielded box	It must be big enough to fit the PCBA and the fixture. It should have one SMA female to female connector and a small hole to pass the DUT to PLT cable connections.
4	2 RF cables (1 optional)	One cable to be used from the PLT GU to the shielded box. One more cable to be used from the shielded box to the RF antenna. (This is optional since the RF antenna can be directly mounted into the shielded box RF SMA connector). The cables should have low attenuation at 2.5 Ghz range (<2 dB) and high shielding effectiveness (>60 dB). Proposed cables are from Radiall. Cables datasheet: https://www.radiall.com/media/files/RFCableAssemblies%20D1C004XEe.pdf <ul style="list-style-type: none"> ● Flexible cable 2.6/50 D (RD316) P/N: C291 185 067 ● Flexible cable 2/50 D (124416 type) P/N: C291 146 087 ● Flexible cable 2.6/50 D (ECO316D: alternative to RD316) P/N: C291 999 905 ● Flexible cable 5/50 D (ECO142: alternative to RG142) P/N: C291 325 290 ● Flexible cable 5/50 D (Power 142: alternative to RG142) P/N: C291 325 270 ● Flexible cable 6/50 D (ECO230) P/N: C291 326 490
5	DUT fixture	A fixture to be placed inside the shielded box to easily connect the PCBAs to the PLT.

F.2 Setup

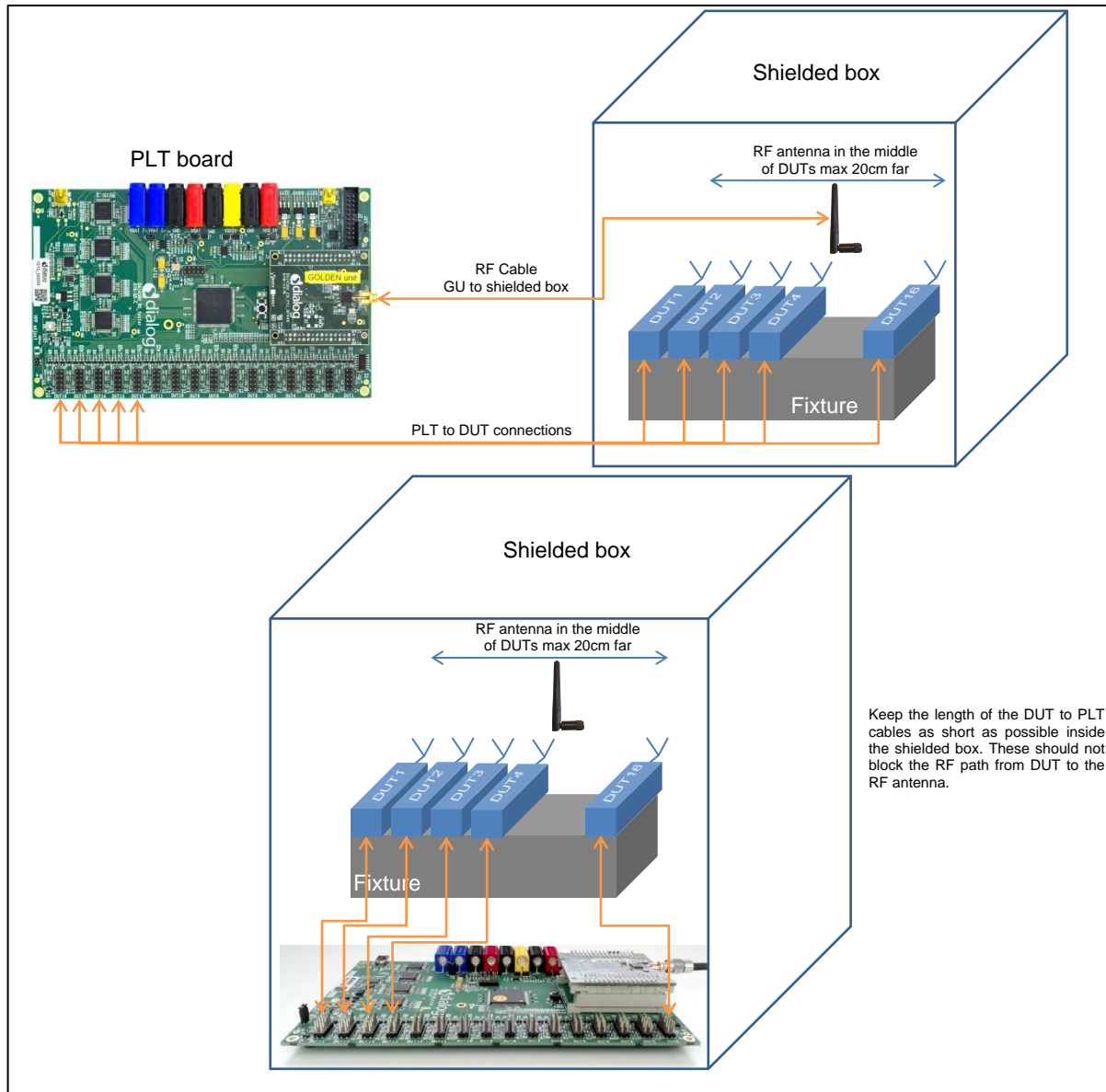

Figure 159: Setup Diagram

Table 106: Calibration Setup

Item	Description
PLT board	The PLT board could either be outside or inside the shielded box, as shown in Figure 159 , depending on the fixture setup.
DUTs	The DUT antennas should point the RF antenna.
PLT to DUT connections	The PLT to DUT cable connections should be as short as possible. Also, the cables should not block the RF path from DUT to the RF antenna.
Shielded box	The shielded box must be big enough to fit the PCBA and the fixture and the PLT if it is inside.

SmartBond Production Line Tool

Item	Description
RF cable - PLT to shielded box.	<p>This type of cable must have good shielding and low attenuation. Effective shielding must be >60 dB. Check Table 105 for the best proposals.</p> <p>If multiple production lines are used, RF cable shielding is important to avoid disturbance from other close by PLTs. However, if other PLTs are far away (>3 m) other cables can be used.</p> <ul style="list-style-type: none"> FLEXIBLE CABLE 2.6/50 S (RG316 - KX22A) P/N: C291 170 007
RF cable – Shielded box to RF antenna (optional).	<p>Due to the close distance between the DUT antennas and the RF antenna cable, cable shielding must be good, at least 60 dB. Check Table 105 for proposals.</p> <p>This cable can be optional. The RF antenna may be mounted directly onto the SMA RF connector inside the shielded box. In that case, the fixture and the DUTs should be placed appropriately (less than 20 cm).</p>
RF antenna	<p>The RF antenna can be any good Wi-Fi antenna that operates at 2.5 GHz. It should be placed in a vertical position as shown in Figure 159. The distance to the DUTs should not be larger than 20 cm. It should be placed in the middle of the DUTs (in front of DUT 8).</p> <p>Bear in mind that the Anritsu MT8852B BLE tester cannot perform TX measurements if the signal received at its antenna is less than -50 dBm. For a good measurement, the signal reaching its antenna should be greater than -40 dBm.</p> <p>Therefore, the distance and the placement between the DUTs and the RF antenna are very important. Trial-and-error test should be carried out until the optimal antenna position is found.</p> <p>The RF antenna placement should be very stable. After the optimal position is found, it should be fixed into position and not able to move again.</p>
DUT fixture	<p>The fixture position should be fixed compared to the RF antenna. The fixture should not move in any way to keep the distance between the DUTs and the RF antenna fixed.</p>

SmartBond Production Line Tool

F.3 Procedure

Table 107 describes the steps to follow to calculate the RF path losses for each different DUT position.

Table 107: Procedure Steps

#	Step	Description
1	Open the SmartBond_CFG_PLT.exe PLT configuration executable.	User should configure the PLT so only XTAL trim (without OTP burn) and one Golden Unit RF test is enabled.
2	Enable all 16 DUTs	<p>Select the GU COM port and Enumerate the DUT COM port numbers.</p>
3	Enable only the Production tests	<p>Under the General tab, enable only the Production tests and disable the Memory programming.</p>
4	Enable XTAL trim (no OTP burn) and one Golden Unit RF test at middle band at 2440 MHz.	<p>RSSI and PER limits do not matter. These should be set to a small value (less than -70 dBm) as shown below. Ideally, we want the limits to be set to a value that all RF tests PASS.</p>

SmartBond Production Line Tool

#	Step	Description																																																																																															
5	Set all DUT path losses to 0 dB.	<p>RF Tests</p> <p>Golden Unit BLE Tester Path losses per DUT</p> <p>Path losses per DUT. Values 0.00 to 40.00dB.</p> <table border="1"> <tr> <td>DUT 1</td><td>0.00</td> <td>DUT 5</td><td>0.00</td> <td>DUT 9</td><td>0.00</td> <td>DUT 13</td><td>0.00</td> </tr> <tr> <td>DUT 2</td><td>0.00</td> <td>DUT 6</td><td>0.00</td> <td>DUT 10</td><td>0.00</td> <td>DUT 14</td><td>0.00</td> </tr> <tr> <td>DUT 3</td><td>0.00</td> <td>DUT 7</td><td>0.00</td> <td>DUT 11</td><td>0.00</td> <td>DUT 15</td><td>0.00</td> </tr> <tr> <td>DUT 4</td><td>0.00</td> <td>DUT 8</td><td>0.00</td> <td>DUT 12</td><td>0.00</td> <td>DUT 16</td><td>0.00</td> </tr> </table>	DUT 1	0.00	DUT 5	0.00	DUT 9	0.00	DUT 13	0.00	DUT 2	0.00	DUT 6	0.00	DUT 10	0.00	DUT 14	0.00	DUT 3	0.00	DUT 7	0.00	DUT 11	0.00	DUT 15	0.00	DUT 4	0.00	DUT 8	0.00	DUT 12	0.00	DUT 16	0.00																																																															
DUT 1	0.00	DUT 5	0.00	DUT 9	0.00	DUT 13	0.00																																																																																										
DUT 2	0.00	DUT 6	0.00	DUT 10	0.00	DUT 14	0.00																																																																																										
DUT 3	0.00	DUT 7	0.00	DUT 11	0.00	DUT 15	0.00																																																																																										
DUT 4	0.00	DUT 8	0.00	DUT 12	0.00	DUT 16	0.00																																																																																										
6	Backup CSV log file.	<p>Go to SmartBond_PLT_v_4.\executables\logs and back up the today's CSV file. For example, if today's CSV file is Test_station_1_20180306_csv_results.csv rename it to: Test_station_1_20180306_csv_results_BackUp.csv. Doing so ensures a new CSV file is created at the next PLT test run.</p>																																																																																															
7	Place the 1 st PCBA	Place the 1 st PCBA into the fixture inside the shielded box.																																																																																															
8	Open SmartBond_GUI_PLT.exe	<p>File Edit Run</p> <p>Start BD address: 80:80:80:00:00:0A Next BD address: 80:80:80:00:00:0A End BD address: 00:00:00:00:00:00</p> <p>Statistics Pass: 1 Fail: 2 Total: 0 Left: 0 Runs: 1</p> <p>IC: DA14580</p> <p><input type="checkbox"/> COM Enum <input type="checkbox"/> GU Check <input type="checkbox"/> VBAT/UART <input type="checkbox"/> UART check</p> <table border="1"> <thead> <tr> <th>DUT</th> <th>BD Address</th> <th>Code</th> <th>Status</th> <th>Result</th> </tr> </thead> <tbody> <tr><td>1</td><td>80:80:80:00:00:0A</td><td></td><td></td><td></td></tr> <tr><td>2</td><td>80:80:80:00:00:0B</td><td></td><td></td><td></td></tr> <tr><td>3</td><td>80:80:80:00:00:0C</td><td></td><td></td><td></td></tr> <tr><td>4</td><td>80:80:80:00:00:0A</td><td></td><td></td><td></td></tr> <tr><td>5</td><td>00:00:00:00:00:07</td><td></td><td></td><td></td></tr> <tr><td>6</td><td>00:00:00:00:00:08</td><td></td><td></td><td></td></tr> <tr><td>7</td><td>00:00:00:00:00:09</td><td></td><td></td><td></td></tr> <tr><td>8</td><td>00:00:00:00:00:0A</td><td></td><td></td><td></td></tr> <tr><td>9</td><td>00:00:00:00:00:0B</td><td></td><td></td><td></td></tr> <tr><td>10</td><td>00:00:00:00:00:0C</td><td></td><td></td><td></td></tr> <tr><td>11</td><td>00:00:00:00:00:0D</td><td></td><td></td><td></td></tr> <tr><td>12</td><td>00:00:00:00:00:0E</td><td></td><td></td><td></td></tr> <tr><td>13</td><td>00:00:00:00:00:0F</td><td></td><td></td><td></td></tr> <tr><td>14</td><td>00:00:00:00:00:10</td><td></td><td></td><td></td></tr> <tr><td>15</td><td>00:00:00:00:00:11</td><td></td><td></td><td></td></tr> <tr><td>16</td><td>00:00:00:00:00:12</td><td></td><td></td><td></td></tr> </tbody> </table> <table border="1"> <thead> <tr> <th>GU</th> <th>COM Port</th> <th>Code</th> <th>Status</th> <th>Result</th> </tr> </thead> <tbody> <tr> <td></td> <td>COM14</td> <td></td> <td></td> <td></td> </tr> </tbody> </table> <p>BLE Tester Temp Ammeter Voltmeter</p> <p>START</p> <p>C:\DA1458x_DA1468x_PLT_v_4.\executables\params\params.xml Retest failed: Disabled Test Time: 00:00:000</p>	DUT	BD Address	Code	Status	Result	1	80:80:80:00:00:0A				2	80:80:80:00:00:0B				3	80:80:80:00:00:0C				4	80:80:80:00:00:0A				5	00:00:00:00:00:07				6	00:00:00:00:00:08				7	00:00:00:00:00:09				8	00:00:00:00:00:0A				9	00:00:00:00:00:0B				10	00:00:00:00:00:0C				11	00:00:00:00:00:0D				12	00:00:00:00:00:0E				13	00:00:00:00:00:0F				14	00:00:00:00:00:10				15	00:00:00:00:00:11				16	00:00:00:00:00:12				GU	COM Port	Code	Status	Result		COM14			
DUT	BD Address	Code	Status	Result																																																																																													
1	80:80:80:00:00:0A																																																																																																
2	80:80:80:00:00:0B																																																																																																
3	80:80:80:00:00:0C																																																																																																
4	80:80:80:00:00:0A																																																																																																
5	00:00:00:00:00:07																																																																																																
6	00:00:00:00:00:08																																																																																																
7	00:00:00:00:00:09																																																																																																
8	00:00:00:00:00:0A																																																																																																
9	00:00:00:00:00:0B																																																																																																
10	00:00:00:00:00:0C																																																																																																
11	00:00:00:00:00:0D																																																																																																
12	00:00:00:00:00:0E																																																																																																
13	00:00:00:00:00:0F																																																																																																
14	00:00:00:00:00:10																																																																																																
15	00:00:00:00:00:11																																																																																																
16	00:00:00:00:00:12																																																																																																
GU	COM Port	Code	Status	Result																																																																																													
	COM14																																																																																																

SmartBond Production Line Tool

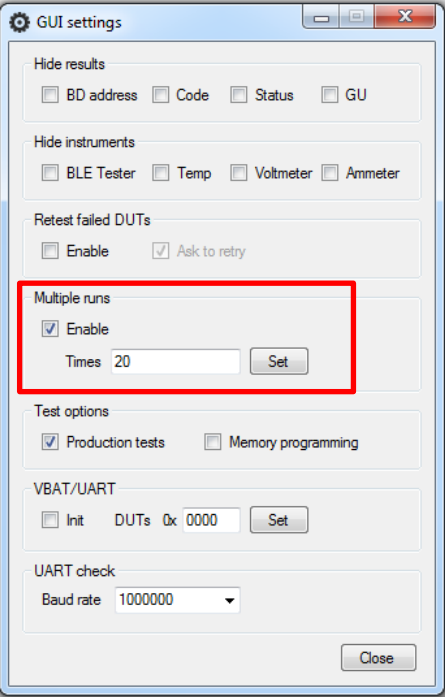
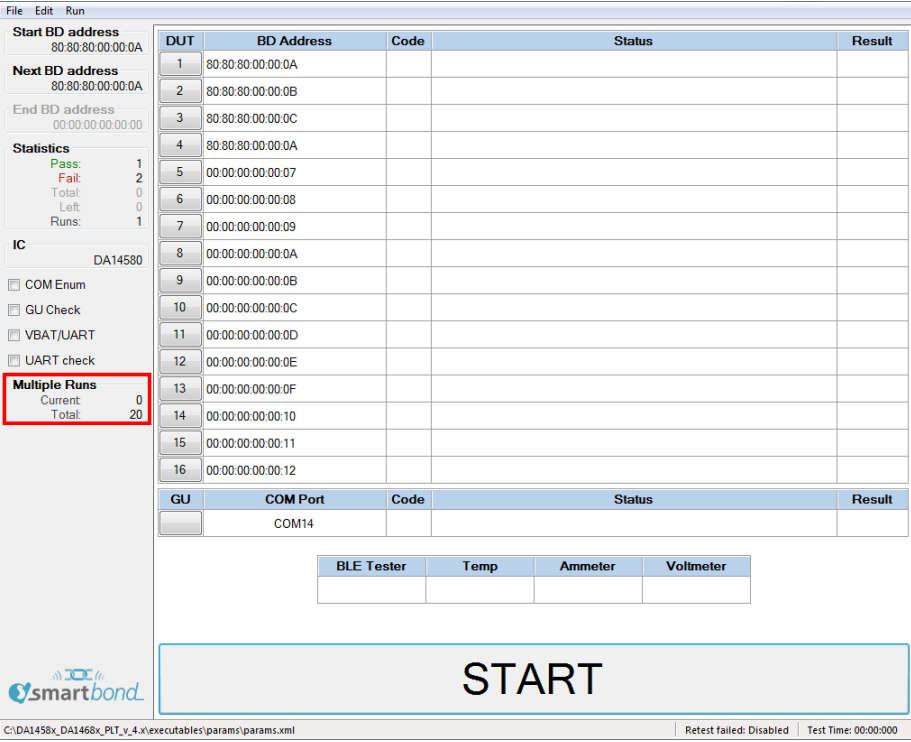
#	Step	Description
9	Go to Edit->Settings	<p>Select the Multiple runs. Set the Times to 20. Click Set and Close.</p> 
10	In the SmartBond_GUI_PLT.exe the Multiple Runs should be shown on the left panel	
11	Press START	Click START and wait for the 20 tests to be performed.
12	Backup CSV log file	Go to SmartBond_PLT_v_4.2.3.198\executables\logs and back up the CSV file for the 1 st PCBA. For example if today's CSV file is Test_station_1_20180306_csv_results.csv rename it to Test_station_1_20180306_csv_results_PCBA_1.csv.

SmartBond Production Line Tool

#	Step	Description																																																																																																																																																																																																																																																																																																																	
13	Place the 2 nd PCBA	Place the 2 nd PCBA into the fixture inside the shielded box.																																																																																																																																																																																																																																																																																																																	
14	Repeat steps	Repeat the procedure from step 9 to step 13 for all 10 PCBAs.																																																																																																																																																																																																																																																																																																																	
15	Check CSV results	<p>At the end, 10 CSV logs files should exist. For example, Test_station_1_20180306_csv_results_PCBA_1.csv. Test_station_1_20180306_csv_results_PCBA_2.csv. ... Test_station_1_20180306_csv_results_PCBA_10.csv.</p> <p>Each CSV file should have 16 DUTs * 20 Tests = 320 lines + 1 CSV header = 321 lines. Example:</p> <table border="1"> <thead> <tr> <th></th> <th>A</th> <th>B</th> <th>C</th> <th>D</th> <th>E</th> <th>F</th> <th>G</th> <th>H</th> <th>I</th> <th>J</th> <th>K</th> <th>L</th> <th>M</th> <th>N</th> <th>O</th> </tr> </thead> <tbody> <tr> <td>1</td> <td>Start time</td> <td>End time</td> <td>DUT BD</td> <td>address</td> <td>Overall</td> <td>COM</td> <td>FW do</td> <td>FW path</td> <td>1 FW ve</td> <td>FW versio</td> <td>XTAL tri</td> <td>XTAL t</td> <td>GU RX</td> <td>GU RX</td> <td>RSS GU RX</td> <td>f</td> </tr> <tr> <td>2</td> <td>11:20:33</td> <td>11:20:47</td> <td>1</td> <td>00:00:00:0</td> <td>PASS</td> <td>20</td> <td>PASS</td> <td>C:\Users\tr</td> <td>PASS</td> <td>v_5.0.4</td> <td>PI</td> <td>PASS</td> <td>1172</td> <td>PASS</td> <td>-28.5</td> <td>0</td> </tr> <tr> <td>3</td> <td>11:20:33</td> <td>11:20:47</td> <td>2</td> <td>00:00:00:0</td> <td>PASS</td> <td>12</td> <td>PASS</td> <td>C:\Users\tr</td> <td>PASS</td> <td>v_5.0.4</td> <td>PI</td> <td>PASS</td> <td>1207</td> <td>PASS</td> <td>-26.61</td> <td>0</td> </tr> <tr> <td>4</td> <td>11:20:33</td> <td>11:20:47</td> <td>3</td> <td>00:00:00:0</td> <td>PASS</td> <td>18</td> <td>PASS</td> <td>C:\Users\tr</td> <td>PASS</td> <td>v_5.0.4</td> <td>PI</td> <td>PASS</td> <td>1272</td> <td>PASS</td> <td>-26.61</td> <td>0</td> </tr> <tr> <td>5</td> <td>11:20:33</td> <td>11:20:47</td> <td>4</td> <td>00:00:00:0</td> <td>PASS</td> <td>13</td> <td>PASS</td> <td>C:\Users\tr</td> <td>PASS</td> <td>v_5.0.4</td> <td>PI</td> <td>PASS</td> <td>1222</td> <td>PASS</td> <td>-28.5</td> <td>0</td> </tr> <tr> <td>6</td> <td>11:20:33</td> <td>11:20:47</td> <td>5</td> <td>00:00:00:0</td> <td>PASS</td> <td>11</td> <td>PASS</td> <td>C:\Users\tr</td> <td>PASS</td> <td>v_5.0.4</td> <td>PI</td> <td>PASS</td> <td>1181</td> <td>PASS</td> <td>-26.13</td> <td>0</td> </tr> <tr> <td>7</td> <td>11:20:33</td> <td>11:20:47</td> <td>6</td> <td>00:00:00:0</td> <td>PASS</td> <td>10</td> <td>PASS</td> <td>C:\Users\tr</td> <td>PASS</td> <td>v_5.0.4</td> <td>PI</td> <td>PASS</td> <td>1218</td> <td>PASS</td> <td>-22.34</td> <td>0</td> </tr> <tr> <td>8</td> <td>11:20:33</td> <td>11:20:47</td> <td>7</td> <td>00:00:00:0</td> <td>PASS</td> <td>9</td> <td>PASS</td> <td>C:\Users\tr</td> <td>PASS</td> <td>v_5.0.4</td> <td>PI</td> <td>PASS</td> <td>1237</td> <td>PASS</td> <td>-28.98</td> <td>0</td> </tr> <tr> <td>9</td> <td>11:20:33</td> <td>11:20:47</td> <td>8</td> <td>00:00:00:0</td> <td>PASS</td> <td>19</td> <td>PASS</td> <td>C:\Users\tr</td> <td>PASS</td> <td>v_5.0.4</td> <td>PI</td> <td>PASS</td> <td>1180</td> <td>PASS</td> <td>-38.93</td> <td>0</td> </tr> <tr> <td>10</td> <td>11:20:33</td> <td>11:20:47</td> <td>9</td> <td>00:00:00:0</td> <td>PASS</td> <td>14</td> <td>PASS</td> <td>C:\Users\tr</td> <td>PASS</td> <td>v_5.0.4</td> <td>PI</td> <td>PASS</td> <td>1207</td> <td>PASS</td> <td>-27.08</td> <td>0</td> </tr> <tr> <td>11</td> <td>11:20:33</td> <td>11:20:47</td> <td>10</td> <td>00:00:00:0</td> <td>PASS</td> <td>15</td> <td>PASS</td> <td>C:\Users\tr</td> <td>PASS</td> <td>v_5.0.4</td> <td>PI</td> <td>PASS</td> <td>1244</td> <td>PASS</td> <td>-36.09</td> <td>0</td> </tr> <tr> <td>12</td> <td>11:20:33</td> <td>11:20:47</td> <td>11</td> <td>00:00:00:0</td> <td>PASS</td> <td>16</td> <td>PASS</td> <td>C:\Users\tr</td> <td>PASS</td> <td>v_5.0.4</td> <td>PI</td> <td>PASS</td> <td>1180</td> <td>PASS</td> <td>-34.19</td> <td>0</td> </tr> <tr> <td>13</td> <td>11:20:33</td> <td>11:20:47</td> <td>12</td> <td>00:00:00:0</td> <td>PASS</td> <td>17</td> <td>PASS</td> <td>C:\Users\tr</td> <td>PASS</td> <td>v_5.0.4</td> <td>PI</td> <td>PASS</td> <td>1168</td> <td>PASS</td> <td>-27.08</td> <td>0</td> </tr> <tr> <td>14</td> <td>11:20:33</td> <td>11:20:47</td> <td>13</td> <td>00:00:00:0</td> <td>PASS</td> <td>5</td> <td>PASS</td> <td>C:\Users\tr</td> <td>PASS</td> <td>v_5.0.4</td> <td>PI</td> <td>PASS</td> <td>1255</td> <td>PASS</td> <td>-32.29</td> <td>0</td> </tr> <tr> <td>15</td> <td>11:20:33</td> <td>11:20:47</td> <td>14</td> <td>00:00:00:0</td> <td>PASS</td> <td>6</td> <td>PASS</td> <td>C:\Users\tr</td> <td>PASS</td> <td>v_5.0.4</td> <td>PI</td> <td>PASS</td> <td>1247</td> <td>PASS</td> <td>-23.76</td> <td>0</td> </tr> <tr> <td>16</td> <td>11:20:33</td> <td>11:20:47</td> <td>15</td> <td>00:00:00:0</td> <td>PASS</td> <td>7</td> <td>PASS</td> <td>C:\Users\tr</td> <td>PASS</td> <td>v_5.0.4</td> <td>PI</td> <td>PASS</td> <td>1180</td> <td>PASS</td> <td>-24.71</td> <td>0</td> </tr> <tr> <td>17</td> <td>11:20:33</td> <td>11:20:47</td> <td>16</td> <td>00:00:00:0</td> <td>PASS</td> <td>8</td> <td>PASS</td> <td>C:\Users\tr</td> <td>PASS</td> <td>v_5.0.4</td> <td>PI</td> <td>PASS</td> <td>1247</td> <td>PASS</td> <td>-28.98</td> <td>0</td> </tr> </tbody> </table>		A	B	C	D	E	F	G	H	I	J	K	L	M	N	O	1	Start time	End time	DUT BD	address	Overall	COM	FW do	FW path	1 FW ve	FW versio	XTAL tri	XTAL t	GU RX	GU RX	RSS GU RX	f	2	11:20:33	11:20:47	1	00:00:00:0	PASS	20	PASS	C:\Users\tr	PASS	v_5.0.4	PI	PASS	1172	PASS	-28.5	0	3	11:20:33	11:20:47	2	00:00:00:0	PASS	12	PASS	C:\Users\tr	PASS	v_5.0.4	PI	PASS	1207	PASS	-26.61	0	4	11:20:33	11:20:47	3	00:00:00:0	PASS	18	PASS	C:\Users\tr	PASS	v_5.0.4	PI	PASS	1272	PASS	-26.61	0	5	11:20:33	11:20:47	4	00:00:00:0	PASS	13	PASS	C:\Users\tr	PASS	v_5.0.4	PI	PASS	1222	PASS	-28.5	0	6	11:20:33	11:20:47	5	00:00:00:0	PASS	11	PASS	C:\Users\tr	PASS	v_5.0.4	PI	PASS	1181	PASS	-26.13	0	7	11:20:33	11:20:47	6	00:00:00:0	PASS	10	PASS	C:\Users\tr	PASS	v_5.0.4	PI	PASS	1218	PASS	-22.34	0	8	11:20:33	11:20:47	7	00:00:00:0	PASS	9	PASS	C:\Users\tr	PASS	v_5.0.4	PI	PASS	1237	PASS	-28.98	0	9	11:20:33	11:20:47	8	00:00:00:0	PASS	19	PASS	C:\Users\tr	PASS	v_5.0.4	PI	PASS	1180	PASS	-38.93	0	10	11:20:33	11:20:47	9	00:00:00:0	PASS	14	PASS	C:\Users\tr	PASS	v_5.0.4	PI	PASS	1207	PASS	-27.08	0	11	11:20:33	11:20:47	10	00:00:00:0	PASS	15	PASS	C:\Users\tr	PASS	v_5.0.4	PI	PASS	1244	PASS	-36.09	0	12	11:20:33	11:20:47	11	00:00:00:0	PASS	16	PASS	C:\Users\tr	PASS	v_5.0.4	PI	PASS	1180	PASS	-34.19	0	13	11:20:33	11:20:47	12	00:00:00:0	PASS	17	PASS	C:\Users\tr	PASS	v_5.0.4	PI	PASS	1168	PASS	-27.08	0	14	11:20:33	11:20:47	13	00:00:00:0	PASS	5	PASS	C:\Users\tr	PASS	v_5.0.4	PI	PASS	1255	PASS	-32.29	0	15	11:20:33	11:20:47	14	00:00:00:0	PASS	6	PASS	C:\Users\tr	PASS	v_5.0.4	PI	PASS	1247	PASS	-23.76	0	16	11:20:33	11:20:47	15	00:00:00:0	PASS	7	PASS	C:\Users\tr	PASS	v_5.0.4	PI	PASS	1180	PASS	-24.71	0	17	11:20:33	11:20:47	16	00:00:00:0	PASS	8	PASS	C:\Users\tr	PASS	v_5.0.4	PI	PASS	1247	PASS	-28.98	0
	A	B	C	D	E	F	G	H	I	J	K	L	M	N	O																																																																																																																																																																																																																																																																																																				
1	Start time	End time	DUT BD	address	Overall	COM	FW do	FW path	1 FW ve	FW versio	XTAL tri	XTAL t	GU RX	GU RX	RSS GU RX	f																																																																																																																																																																																																																																																																																																			
2	11:20:33	11:20:47	1	00:00:00:0	PASS	20	PASS	C:\Users\tr	PASS	v_5.0.4	PI	PASS	1172	PASS	-28.5	0																																																																																																																																																																																																																																																																																																			
3	11:20:33	11:20:47	2	00:00:00:0	PASS	12	PASS	C:\Users\tr	PASS	v_5.0.4	PI	PASS	1207	PASS	-26.61	0																																																																																																																																																																																																																																																																																																			
4	11:20:33	11:20:47	3	00:00:00:0	PASS	18	PASS	C:\Users\tr	PASS	v_5.0.4	PI	PASS	1272	PASS	-26.61	0																																																																																																																																																																																																																																																																																																			
5	11:20:33	11:20:47	4	00:00:00:0	PASS	13	PASS	C:\Users\tr	PASS	v_5.0.4	PI	PASS	1222	PASS	-28.5	0																																																																																																																																																																																																																																																																																																			
6	11:20:33	11:20:47	5	00:00:00:0	PASS	11	PASS	C:\Users\tr	PASS	v_5.0.4	PI	PASS	1181	PASS	-26.13	0																																																																																																																																																																																																																																																																																																			
7	11:20:33	11:20:47	6	00:00:00:0	PASS	10	PASS	C:\Users\tr	PASS	v_5.0.4	PI	PASS	1218	PASS	-22.34	0																																																																																																																																																																																																																																																																																																			
8	11:20:33	11:20:47	7	00:00:00:0	PASS	9	PASS	C:\Users\tr	PASS	v_5.0.4	PI	PASS	1237	PASS	-28.98	0																																																																																																																																																																																																																																																																																																			
9	11:20:33	11:20:47	8	00:00:00:0	PASS	19	PASS	C:\Users\tr	PASS	v_5.0.4	PI	PASS	1180	PASS	-38.93	0																																																																																																																																																																																																																																																																																																			
10	11:20:33	11:20:47	9	00:00:00:0	PASS	14	PASS	C:\Users\tr	PASS	v_5.0.4	PI	PASS	1207	PASS	-27.08	0																																																																																																																																																																																																																																																																																																			
11	11:20:33	11:20:47	10	00:00:00:0	PASS	15	PASS	C:\Users\tr	PASS	v_5.0.4	PI	PASS	1244	PASS	-36.09	0																																																																																																																																																																																																																																																																																																			
12	11:20:33	11:20:47	11	00:00:00:0	PASS	16	PASS	C:\Users\tr	PASS	v_5.0.4	PI	PASS	1180	PASS	-34.19	0																																																																																																																																																																																																																																																																																																			
13	11:20:33	11:20:47	12	00:00:00:0	PASS	17	PASS	C:\Users\tr	PASS	v_5.0.4	PI	PASS	1168	PASS	-27.08	0																																																																																																																																																																																																																																																																																																			
14	11:20:33	11:20:47	13	00:00:00:0	PASS	5	PASS	C:\Users\tr	PASS	v_5.0.4	PI	PASS	1255	PASS	-32.29	0																																																																																																																																																																																																																																																																																																			
15	11:20:33	11:20:47	14	00:00:00:0	PASS	6	PASS	C:\Users\tr	PASS	v_5.0.4	PI	PASS	1247	PASS	-23.76	0																																																																																																																																																																																																																																																																																																			
16	11:20:33	11:20:47	15	00:00:00:0	PASS	7	PASS	C:\Users\tr	PASS	v_5.0.4	PI	PASS	1180	PASS	-24.71	0																																																																																																																																																																																																																																																																																																			
17	11:20:33	11:20:47	16	00:00:00:0	PASS	8	PASS	C:\Users\tr	PASS	v_5.0.4	PI	PASS	1247	PASS	-28.98	0																																																																																																																																																																																																																																																																																																			
16	Get the average for each DUT in each CSV file	<p>In each CSV file, get the average GU RX RSSI value for each DUT. Apply the following formulas to each of the 10 CSV files.</p> <table border="1"> <thead> <tr> <th>DUT #</th> <th>Formula</th> <th>Example Result</th> </tr> </thead> <tbody> <tr> <td>DUT 1</td> <td>=SUMIF(\$C\$2:\$C\$321,1,\$N\$2:\$N\$321)/20</td> <td>-28.5015</td> </tr> <tr> <td>DUT 2</td> <td>=SUMIF(\$C\$2:\$C\$321,2,\$N\$2:\$N\$321)/20</td> <td>-26.609</td> </tr> <tr> <td>DUT 3</td> <td>=SUMIF(\$C\$2:\$C\$321,3,\$N\$2:\$N\$321)/20</td> <td>-26.8685</td> </tr> <tr> <td>DUT 4</td> <td>=SUMIF(\$C\$2:\$C\$321,4,\$N\$2:\$N\$321)/20</td> <td>-28.406</td> </tr> <tr> <td>DUT 5</td> <td>=SUMIF(\$C\$2:\$C\$321,5,\$N\$2:\$N\$321)/20</td> <td>-26.346</td> </tr> <tr> <td>DUT 6</td> <td>=SUMIF(\$C\$2:\$C\$321,6,\$N\$2:\$N\$321)/20</td> <td>-22.5515</td> </tr> <tr> <td>DUT 7</td> <td>=SUMIF(\$C\$2:\$C\$321,7,\$N\$2:\$N\$321)/20</td> <td>-28.98</td> </tr> <tr> <td>DUT 8</td> <td>=SUMIF(\$C\$2:\$C\$321,8,\$N\$2:\$N\$321)/20</td> <td>-39.283</td> </tr> <tr> <td>DUT 9</td> <td>=SUMIF(\$C\$2:\$C\$321,9,\$N\$2:\$N\$321)/20</td> <td>-27.08</td> </tr> <tr> <td>DUT 10</td> <td>=SUMIF(\$C\$2:\$C\$321,10,\$N\$2:\$N\$321)/20</td> <td>-36.607</td> </tr> <tr> <td>DUT 11</td> <td>=SUMIF(\$C\$2:\$C\$321,11,\$N\$2:\$N\$321)/20</td> <td>-34.19</td> </tr> <tr> <td>DUT 12</td> <td>=SUMIF(\$C\$2:\$C\$321,12,\$N\$2:\$N\$321)/20</td> <td>-26.7745</td> </tr> <tr> <td>DUT 13</td> <td>=SUMIF(\$C\$2:\$C\$321,13,\$N\$2:\$N\$321)/20</td> <td>-32.0095</td> </tr> <tr> <td>DUT 14</td> <td>=SUMIF(\$C\$2:\$C\$321,14,\$N\$2:\$N\$321)/20</td> <td>-23.784</td> </tr> <tr> <td>DUT 15</td> <td>=SUMIF(\$C\$2:\$C\$321,15,\$N\$2:\$N\$321)/20</td> <td>-24.71</td> </tr> <tr> <td>DUT 16</td> <td>=SUMIF(\$C\$2:\$C\$321,16,\$N\$2:\$N\$321)/20</td> <td>-29.168</td> </tr> </tbody> </table>	DUT #	Formula	Example Result	DUT 1	=SUMIF(\$C\$2:\$C\$321,1,\$N\$2:\$N\$321)/20	-28.5015	DUT 2	=SUMIF(\$C\$2:\$C\$321,2,\$N\$2:\$N\$321)/20	-26.609	DUT 3	=SUMIF(\$C\$2:\$C\$321,3,\$N\$2:\$N\$321)/20	-26.8685	DUT 4	=SUMIF(\$C\$2:\$C\$321,4,\$N\$2:\$N\$321)/20	-28.406	DUT 5	=SUMIF(\$C\$2:\$C\$321,5,\$N\$2:\$N\$321)/20	-26.346	DUT 6	=SUMIF(\$C\$2:\$C\$321,6,\$N\$2:\$N\$321)/20	-22.5515	DUT 7	=SUMIF(\$C\$2:\$C\$321,7,\$N\$2:\$N\$321)/20	-28.98	DUT 8	=SUMIF(\$C\$2:\$C\$321,8,\$N\$2:\$N\$321)/20	-39.283	DUT 9	=SUMIF(\$C\$2:\$C\$321,9,\$N\$2:\$N\$321)/20	-27.08	DUT 10	=SUMIF(\$C\$2:\$C\$321,10,\$N\$2:\$N\$321)/20	-36.607	DUT 11	=SUMIF(\$C\$2:\$C\$321,11,\$N\$2:\$N\$321)/20	-34.19	DUT 12	=SUMIF(\$C\$2:\$C\$321,12,\$N\$2:\$N\$321)/20	-26.7745	DUT 13	=SUMIF(\$C\$2:\$C\$321,13,\$N\$2:\$N\$321)/20	-32.0095	DUT 14	=SUMIF(\$C\$2:\$C\$321,14,\$N\$2:\$N\$321)/20	-23.784	DUT 15	=SUMIF(\$C\$2:\$C\$321,15,\$N\$2:\$N\$321)/20	-24.71	DUT 16	=SUMIF(\$C\$2:\$C\$321,16,\$N\$2:\$N\$321)/20	-29.168																																																																																																																																																																																																																																																														
DUT #	Formula	Example Result																																																																																																																																																																																																																																																																																																																	
DUT 1	=SUMIF(\$C\$2:\$C\$321,1,\$N\$2:\$N\$321)/20	-28.5015																																																																																																																																																																																																																																																																																																																	
DUT 2	=SUMIF(\$C\$2:\$C\$321,2,\$N\$2:\$N\$321)/20	-26.609																																																																																																																																																																																																																																																																																																																	
DUT 3	=SUMIF(\$C\$2:\$C\$321,3,\$N\$2:\$N\$321)/20	-26.8685																																																																																																																																																																																																																																																																																																																	
DUT 4	=SUMIF(\$C\$2:\$C\$321,4,\$N\$2:\$N\$321)/20	-28.406																																																																																																																																																																																																																																																																																																																	
DUT 5	=SUMIF(\$C\$2:\$C\$321,5,\$N\$2:\$N\$321)/20	-26.346																																																																																																																																																																																																																																																																																																																	
DUT 6	=SUMIF(\$C\$2:\$C\$321,6,\$N\$2:\$N\$321)/20	-22.5515																																																																																																																																																																																																																																																																																																																	
DUT 7	=SUMIF(\$C\$2:\$C\$321,7,\$N\$2:\$N\$321)/20	-28.98																																																																																																																																																																																																																																																																																																																	
DUT 8	=SUMIF(\$C\$2:\$C\$321,8,\$N\$2:\$N\$321)/20	-39.283																																																																																																																																																																																																																																																																																																																	
DUT 9	=SUMIF(\$C\$2:\$C\$321,9,\$N\$2:\$N\$321)/20	-27.08																																																																																																																																																																																																																																																																																																																	
DUT 10	=SUMIF(\$C\$2:\$C\$321,10,\$N\$2:\$N\$321)/20	-36.607																																																																																																																																																																																																																																																																																																																	
DUT 11	=SUMIF(\$C\$2:\$C\$321,11,\$N\$2:\$N\$321)/20	-34.19																																																																																																																																																																																																																																																																																																																	
DUT 12	=SUMIF(\$C\$2:\$C\$321,12,\$N\$2:\$N\$321)/20	-26.7745																																																																																																																																																																																																																																																																																																																	
DUT 13	=SUMIF(\$C\$2:\$C\$321,13,\$N\$2:\$N\$321)/20	-32.0095																																																																																																																																																																																																																																																																																																																	
DUT 14	=SUMIF(\$C\$2:\$C\$321,14,\$N\$2:\$N\$321)/20	-23.784																																																																																																																																																																																																																																																																																																																	
DUT 15	=SUMIF(\$C\$2:\$C\$321,15,\$N\$2:\$N\$321)/20	-24.71																																																																																																																																																																																																																																																																																																																	
DUT 16	=SUMIF(\$C\$2:\$C\$321,16,\$N\$2:\$N\$321)/20	-29.168																																																																																																																																																																																																																																																																																																																	

SmartBond Production Line Tool

#	Step	Description																																																																																																																																																																																											
17	Get all values to a new excel sheet.	<p>Create a new excel sheet. Copy all values created at step 16 from the 10 CSV files to this new excel sheet. An example of all DUT average values from all 10 CSV files is given below. Only 2 decimal digits are shown.</p> <table border="1"> <thead> <tr> <th>DUT</th> <th>PCBA 1</th> <th>PCBA 2</th> <th>PCBA 3</th> <th>PCBA 4</th> <th>PCBA 5</th> <th>PCBA 6</th> <th>PCBA 7</th> <th>PCBA 8</th> <th>PCBA 9</th> <th>PCBA 10</th> </tr> </thead> <tbody> <tr><td>1</td><td>-28.50</td><td>-28.30</td><td>-28.51</td><td>-27.56</td><td>-29.48</td><td>-28.59</td><td>-30.09</td><td>-29.33</td><td>-30.50</td><td>-30.13</td></tr> <tr><td>2</td><td>-26.61</td><td>-26.07</td><td>-27.09</td><td>-26.56</td><td>-27.99</td><td>-27.38</td><td>-28.31</td><td>-27.64</td><td>-28.36</td><td>-28.11</td></tr> <tr><td>3</td><td>-26.87</td><td>-26.71</td><td>-27.65</td><td>-26.71</td><td>-28.64</td><td>-27.84</td><td>-29.14</td><td>-28.43</td><td>-29.54</td><td>-29.14</td></tr> <tr><td>4</td><td>-28.41</td><td>-27.98</td><td>-28.82</td><td>-27.87</td><td>-29.49</td><td>-29.24</td><td>-30.10</td><td>-29.61</td><td>-30.22</td><td>-29.36</td></tr> <tr><td>5</td><td>-26.35</td><td>-25.69</td><td>-26.72</td><td>-26.58</td><td>-26.74</td><td>-26.02</td><td>-27.37</td><td>-26.75</td><td>-27.42</td><td>-27.20</td></tr> <tr><td>6</td><td>-22.55</td><td>-21.60</td><td>-22.68</td><td>-21.81</td><td>-23.32</td><td>-22.33</td><td>-23.82</td><td>-23.77</td><td>-24.45</td><td>-24.19</td></tr> <tr><td>7</td><td>-28.98</td><td>-28.59</td><td>-29.31</td><td>-28.49</td><td>-29.42</td><td>-28.63</td><td>-29.84</td><td>-28.95</td><td>-29.98</td><td>-29.73</td></tr> <tr><td>8</td><td>-39.28</td><td>-39.06</td><td>-39.50</td><td>-38.95</td><td>-39.53</td><td>-39.38</td><td>-40.32</td><td>-40.11</td><td>-40.39</td><td>-39.90</td></tr> <tr><td>9</td><td>-27.08</td><td>-26.64</td><td>-27.68</td><td>-27.07</td><td>-27.76</td><td>-27.28</td><td>-28.40</td><td>-27.51</td><td>-28.89</td><td>-28.75</td></tr> <tr><td>10</td><td>-36.61</td><td>-35.74</td><td>-36.85</td><td>-36.05</td><td>-37.07</td><td>-37.04</td><td>-37.96</td><td>-37.59</td><td>-38.84</td><td>-38.03</td></tr> <tr><td>11</td><td>-34.19</td><td>-33.57</td><td>-35.15</td><td>-34.94</td><td>-36.09</td><td>-35.10</td><td>-36.11</td><td>-35.23</td><td>-36.21</td><td>-35.97</td></tr> <tr><td>12</td><td>-26.77</td><td>-26.51</td><td>-26.90</td><td>-26.65</td><td>-27.33</td><td>-27.11</td><td>-27.40</td><td>-26.67</td><td>-28.03</td><td>-27.26</td></tr> <tr><td>13</td><td>-32.01</td><td>-31.14</td><td>-32.47</td><td>-31.73</td><td>-33.29</td><td>-32.96</td><td>-34.01</td><td>-33.61</td><td>-34.85</td><td>-34.17</td></tr> <tr><td>14</td><td>-23.78</td><td>-23.31</td><td>-24.50</td><td>-23.56</td><td>-24.51</td><td>-24.46</td><td>-24.55</td><td>-23.60</td><td>-25.03</td><td>-24.67</td></tr> <tr><td>15</td><td>-24.71</td><td>-23.89</td><td>-25.39</td><td>-24.82</td><td>-25.46</td><td>-25.37</td><td>-26.24</td><td>-25.42</td><td>-27.09</td><td>-26.94</td></tr> <tr><td>16</td><td>-29.17</td><td>-28.37</td><td>-30.09</td><td>-30.07</td><td>-30.78</td><td>-29.83</td><td>-31.27</td><td>-30.51</td><td>-31.31</td><td>-30.56</td></tr> </tbody> </table>	DUT	PCBA 1	PCBA 2	PCBA 3	PCBA 4	PCBA 5	PCBA 6	PCBA 7	PCBA 8	PCBA 9	PCBA 10	1	-28.50	-28.30	-28.51	-27.56	-29.48	-28.59	-30.09	-29.33	-30.50	-30.13	2	-26.61	-26.07	-27.09	-26.56	-27.99	-27.38	-28.31	-27.64	-28.36	-28.11	3	-26.87	-26.71	-27.65	-26.71	-28.64	-27.84	-29.14	-28.43	-29.54	-29.14	4	-28.41	-27.98	-28.82	-27.87	-29.49	-29.24	-30.10	-29.61	-30.22	-29.36	5	-26.35	-25.69	-26.72	-26.58	-26.74	-26.02	-27.37	-26.75	-27.42	-27.20	6	-22.55	-21.60	-22.68	-21.81	-23.32	-22.33	-23.82	-23.77	-24.45	-24.19	7	-28.98	-28.59	-29.31	-28.49	-29.42	-28.63	-29.84	-28.95	-29.98	-29.73	8	-39.28	-39.06	-39.50	-38.95	-39.53	-39.38	-40.32	-40.11	-40.39	-39.90	9	-27.08	-26.64	-27.68	-27.07	-27.76	-27.28	-28.40	-27.51	-28.89	-28.75	10	-36.61	-35.74	-36.85	-36.05	-37.07	-37.04	-37.96	-37.59	-38.84	-38.03	11	-34.19	-33.57	-35.15	-34.94	-36.09	-35.10	-36.11	-35.23	-36.21	-35.97	12	-26.77	-26.51	-26.90	-26.65	-27.33	-27.11	-27.40	-26.67	-28.03	-27.26	13	-32.01	-31.14	-32.47	-31.73	-33.29	-32.96	-34.01	-33.61	-34.85	-34.17	14	-23.78	-23.31	-24.50	-23.56	-24.51	-24.46	-24.55	-23.60	-25.03	-24.67	15	-24.71	-23.89	-25.39	-24.82	-25.46	-25.37	-26.24	-25.42	-27.09	-26.94	16	-29.17	-28.37	-30.09	-30.07	-30.78	-29.83	-31.27	-30.51	-31.31	-30.56
DUT	PCBA 1	PCBA 2	PCBA 3	PCBA 4	PCBA 5	PCBA 6	PCBA 7	PCBA 8	PCBA 9	PCBA 10																																																																																																																																																																																			
1	-28.50	-28.30	-28.51	-27.56	-29.48	-28.59	-30.09	-29.33	-30.50	-30.13																																																																																																																																																																																			
2	-26.61	-26.07	-27.09	-26.56	-27.99	-27.38	-28.31	-27.64	-28.36	-28.11																																																																																																																																																																																			
3	-26.87	-26.71	-27.65	-26.71	-28.64	-27.84	-29.14	-28.43	-29.54	-29.14																																																																																																																																																																																			
4	-28.41	-27.98	-28.82	-27.87	-29.49	-29.24	-30.10	-29.61	-30.22	-29.36																																																																																																																																																																																			
5	-26.35	-25.69	-26.72	-26.58	-26.74	-26.02	-27.37	-26.75	-27.42	-27.20																																																																																																																																																																																			
6	-22.55	-21.60	-22.68	-21.81	-23.32	-22.33	-23.82	-23.77	-24.45	-24.19																																																																																																																																																																																			
7	-28.98	-28.59	-29.31	-28.49	-29.42	-28.63	-29.84	-28.95	-29.98	-29.73																																																																																																																																																																																			
8	-39.28	-39.06	-39.50	-38.95	-39.53	-39.38	-40.32	-40.11	-40.39	-39.90																																																																																																																																																																																			
9	-27.08	-26.64	-27.68	-27.07	-27.76	-27.28	-28.40	-27.51	-28.89	-28.75																																																																																																																																																																																			
10	-36.61	-35.74	-36.85	-36.05	-37.07	-37.04	-37.96	-37.59	-38.84	-38.03																																																																																																																																																																																			
11	-34.19	-33.57	-35.15	-34.94	-36.09	-35.10	-36.11	-35.23	-36.21	-35.97																																																																																																																																																																																			
12	-26.77	-26.51	-26.90	-26.65	-27.33	-27.11	-27.40	-26.67	-28.03	-27.26																																																																																																																																																																																			
13	-32.01	-31.14	-32.47	-31.73	-33.29	-32.96	-34.01	-33.61	-34.85	-34.17																																																																																																																																																																																			
14	-23.78	-23.31	-24.50	-23.56	-24.51	-24.46	-24.55	-23.60	-25.03	-24.67																																																																																																																																																																																			
15	-24.71	-23.89	-25.39	-24.82	-25.46	-25.37	-26.24	-25.42	-27.09	-26.94																																																																																																																																																																																			
16	-29.17	-28.37	-30.09	-30.07	-30.78	-29.83	-31.27	-30.51	-31.31	-30.56																																																																																																																																																																																			
18	Get the average of each DUT for all PCBAs	<p>Average each DUTs results.</p> <table border="1"> <thead> <tr> <th>DUT</th> <th>=AVERAGE(B1:K1)</th> </tr> </thead> <tbody> <tr><td>DUT 1</td><td>-29.10</td></tr> <tr><td>DUT 2</td><td>-27.41</td></tr> <tr><td>DUT 3</td><td>-28.07</td></tr> <tr><td>DUT 4</td><td>-29.11</td></tr> <tr><td>DUT 5</td><td>-26.68</td></tr> <tr><td>DUT 6</td><td>-23.05</td></tr> <tr><td>DUT 7</td><td>-29.19</td></tr> <tr><td>DUT 8</td><td>-39.64</td></tr> <tr><td>DUT 9</td><td>-27.71</td></tr> <tr><td>DUT 10</td><td>-37.18</td></tr> <tr><td>DUT 11</td><td>-35.26</td></tr> <tr><td>DUT 12</td><td>-27.06</td></tr> <tr><td>DUT 13</td><td>-33.02</td></tr> <tr><td>DUT 14</td><td>-24.20</td></tr> <tr><td>DUT 15</td><td>-25.53</td></tr> <tr><td>DUT 16</td><td>-30.20</td></tr> </tbody> </table>	DUT	=AVERAGE(B1:K1)	DUT 1	-29.10	DUT 2	-27.41	DUT 3	-28.07	DUT 4	-29.11	DUT 5	-26.68	DUT 6	-23.05	DUT 7	-29.19	DUT 8	-39.64	DUT 9	-27.71	DUT 10	-37.18	DUT 11	-35.26	DUT 12	-27.06	DUT 13	-33.02	DUT 14	-24.20	DUT 15	-25.53	DUT 16	-30.20																																																																																																																																																									
DUT	=AVERAGE(B1:K1)																																																																																																																																																																																												
DUT 1	-29.10																																																																																																																																																																																												
DUT 2	-27.41																																																																																																																																																																																												
DUT 3	-28.07																																																																																																																																																																																												
DUT 4	-29.11																																																																																																																																																																																												
DUT 5	-26.68																																																																																																																																																																																												
DUT 6	-23.05																																																																																																																																																																																												
DUT 7	-29.19																																																																																																																																																																																												
DUT 8	-39.64																																																																																																																																																																																												
DUT 9	-27.71																																																																																																																																																																																												
DUT 10	-37.18																																																																																																																																																																																												
DUT 11	-35.26																																																																																																																																																																																												
DUT 12	-27.06																																																																																																																																																																																												
DUT 13	-33.02																																																																																																																																																																																												
DUT 14	-24.20																																																																																																																																																																																												
DUT 15	-25.53																																																																																																																																																																																												
DUT 16	-30.20																																																																																																																																																																																												

SmartBond Production Line Tool

#	Step	Description																																																			
19	Calculate the RF path loss	<p>To calibrate the RF result to -10 dBm we should apply the formula shown in the third column below.</p> <table border="1"> <thead> <tr> <th>DUT</th> <th>=AVERAGE(B1:K1) Row L</th> <th>Path Loss =-10-L1</th> </tr> </thead> <tbody> <tr><td>DUT 1</td><td>-29.10</td><td>19.10</td></tr> <tr><td>DUT 2</td><td>-27.41</td><td>17.41</td></tr> <tr><td>DUT 3</td><td>-28.07</td><td>18.07</td></tr> <tr><td>DUT 4</td><td>-29.11</td><td>19.11</td></tr> <tr><td>DUT 5</td><td>-26.68</td><td>16.68</td></tr> <tr><td>DUT 6</td><td>-23.05</td><td>13.05</td></tr> <tr><td>DUT 7</td><td>-29.19</td><td>19.19</td></tr> <tr><td>DUT 8</td><td>-39.64</td><td>29.64</td></tr> <tr><td>DUT 9</td><td>-27.71</td><td>17.71</td></tr> <tr><td>DUT 10</td><td>-37.18</td><td>27.18</td></tr> <tr><td>DUT 11</td><td>-35.26</td><td>25.26</td></tr> <tr><td>DUT 12</td><td>-27.06</td><td>17.06</td></tr> <tr><td>DUT 13</td><td>-33.02</td><td>23.02</td></tr> <tr><td>DUT 14</td><td>-24.20</td><td>14.20</td></tr> <tr><td>DUT 15</td><td>-25.53</td><td>15.53</td></tr> <tr><td>DUT 16</td><td>-30.20</td><td>20.20</td></tr> </tbody> </table>	DUT	=AVERAGE(B1:K1) Row L	Path Loss =-10-L1	DUT 1	-29.10	19.10	DUT 2	-27.41	17.41	DUT 3	-28.07	18.07	DUT 4	-29.11	19.11	DUT 5	-26.68	16.68	DUT 6	-23.05	13.05	DUT 7	-29.19	19.19	DUT 8	-39.64	29.64	DUT 9	-27.71	17.71	DUT 10	-37.18	27.18	DUT 11	-35.26	25.26	DUT 12	-27.06	17.06	DUT 13	-33.02	23.02	DUT 14	-24.20	14.20	DUT 15	-25.53	15.53	DUT 16	-30.20	20.20
DUT	=AVERAGE(B1:K1) Row L	Path Loss =-10-L1																																																			
DUT 1	-29.10	19.10																																																			
DUT 2	-27.41	17.41																																																			
DUT 3	-28.07	18.07																																																			
DUT 4	-29.11	19.11																																																			
DUT 5	-26.68	16.68																																																			
DUT 6	-23.05	13.05																																																			
DUT 7	-29.19	19.19																																																			
DUT 8	-39.64	29.64																																																			
DUT 9	-27.71	17.71																																																			
DUT 10	-37.18	27.18																																																			
DUT 11	-35.26	25.26																																																			
DUT 12	-27.06	17.06																																																			
DUT 13	-33.02	23.02																																																			
DUT 14	-24.20	14.20																																																			
DUT 15	-25.53	15.53																																																			
DUT 16	-30.20	20.20																																																			
20	Apply the calculated path losses to the SmartBond_CFG_PLT.exe PLT configuration executable.	<p>The screenshot shows a configuration window titled "RF Tests" with a tree view on the left containing "Golden Unit", "BLE Tester", and "Path losses per DUT". The main area displays a table of path losses per DUT with values ranging from 0.00 to 40.00dB.</p> <table border="1"> <thead> <tr> <th colspan="4">Path losses per DUT. Values 0.00 to 40.00dB.</th> </tr> </thead> <tbody> <tr> <td>DUT 1</td><td>19.1</td> <td>DUT 5</td><td>16.68</td> </tr> <tr> <td>DUT 2</td><td>17.41</td> <td>DUT 6</td><td>13.05</td> </tr> <tr> <td>DUT 3</td><td>18.07</td> <td>DUT 7</td><td>19.19</td> </tr> <tr> <td>DUT 4</td><td>19.11</td> <td>DUT 8</td><td>29.64</td> </tr> <tr> <td>DUT 9</td><td>17.71</td> <td>DUT 11</td><td>25.26</td> </tr> <tr> <td>DUT 10</td><td>27.18</td> <td>DUT 12</td><td>17.06</td> </tr> <tr> <td>DUT 13</td><td>32.02</td> <td>DUT 14</td><td>14.2</td> </tr> <tr> <td>DUT 15</td><td>15.53</td> <td>DUT 16</td><td>20.20</td> </tr> </tbody> </table>	Path losses per DUT. Values 0.00 to 40.00dB.				DUT 1	19.1	DUT 5	16.68	DUT 2	17.41	DUT 6	13.05	DUT 3	18.07	DUT 7	19.19	DUT 4	19.11	DUT 8	29.64	DUT 9	17.71	DUT 11	25.26	DUT 10	27.18	DUT 12	17.06	DUT 13	32.02	DUT 14	14.2	DUT 15	15.53	DUT 16	20.20															
Path losses per DUT. Values 0.00 to 40.00dB.																																																					
DUT 1	19.1	DUT 5	16.68																																																		
DUT 2	17.41	DUT 6	13.05																																																		
DUT 3	18.07	DUT 7	19.19																																																		
DUT 4	19.11	DUT 8	29.64																																																		
DUT 9	17.71	DUT 11	25.26																																																		
DUT 10	27.18	DUT 12	17.06																																																		
DUT 13	32.02	DUT 14	14.2																																																		
DUT 15	15.53	DUT 16	20.20																																																		
21	Verify	Repeat steps 10 to 13 with the 10 PCBAs. Check the GU RX RSSI results in the 10 CSV files. The results should be very close to -10 dBm.																																																			

SmartBond Production Line Tool

Appendix G Hex2Bin

This section gives a step-by-step example of using the `hex2bin.exe` utility, which converts Intel HEX files into binary format. See [Figure 161](#).

1. Put the `hex2bin.exe` file in the same directory as the HEX files to be converted.
2. Open a Command Line Interface (CLI) in the same directory, for example, by using <Shift>+<Right Click> and selecting 'Open command window here'.
3. Enter "`hex2bin -c blinky_1.hex`".
4. The binary file (`blinky_1.bin`) will be produced in the same directory.

[Figure 160](#) shows the directory and the files used in this example.

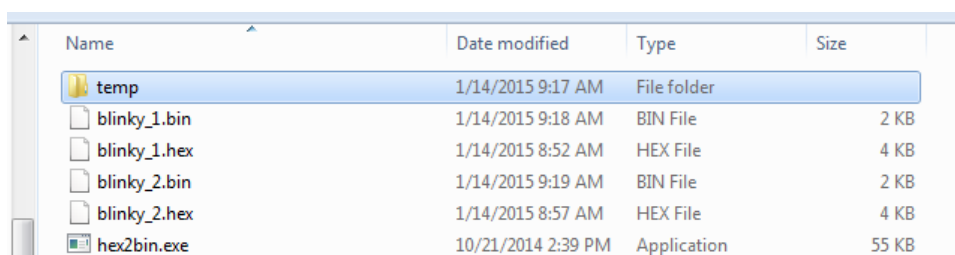

Name	Date modified	Type	Size
temp	1/14/2015 9:17 AM	File folder	
blinky_1.bin	1/14/2015 9:18 AM	BIN File	2 KB
blinky_1.hex	1/14/2015 8:52 AM	HEX File	4 KB
blinky_2.bin	1/14/2015 9:19 AM	BIN File	2 KB
blinky_2.hex	1/14/2015 8:57 AM	HEX File	4 KB
hex2bin.exe	10/21/2014 2:39 PM	Application	55 KB

Figure 160: Hex2Bin Example Directory with Files

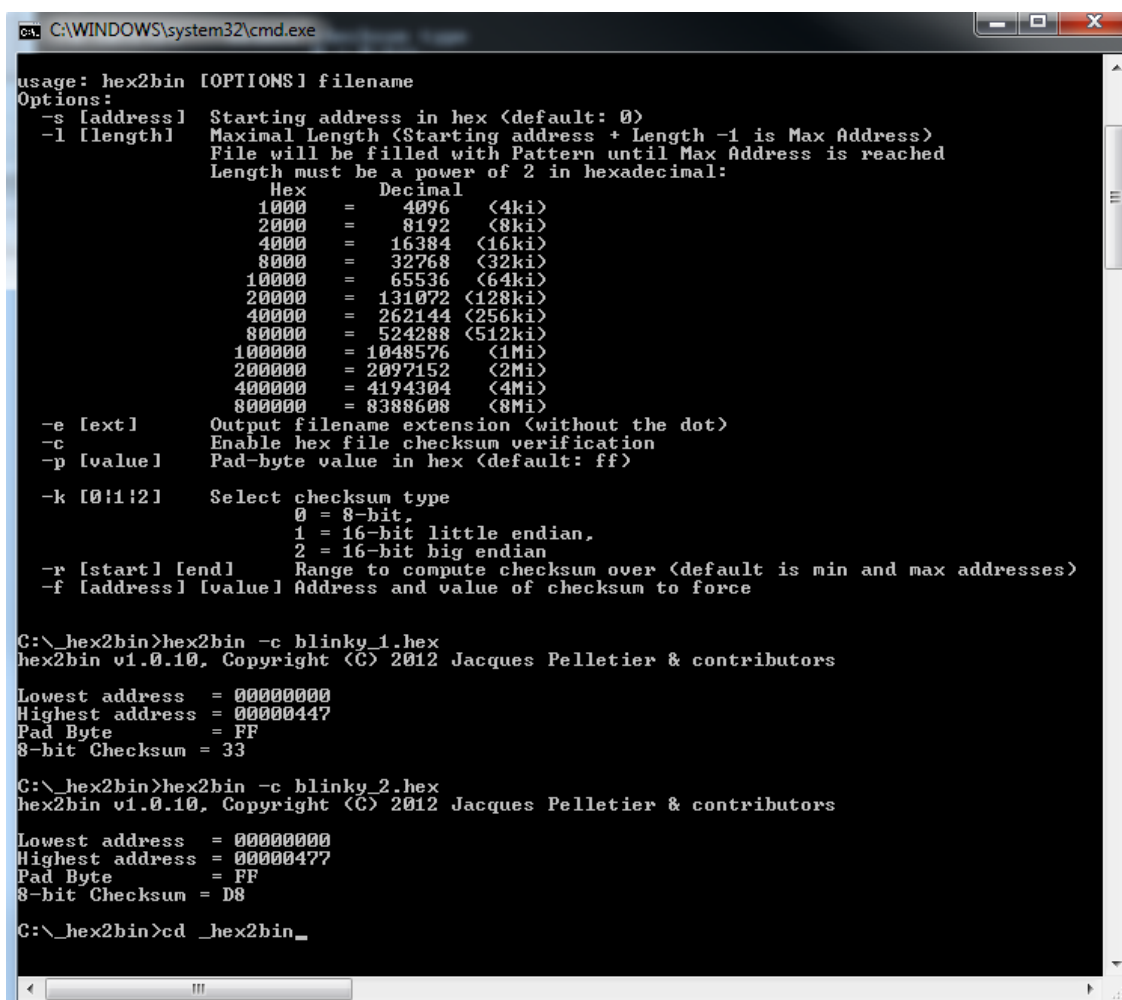

```

C:\WINDOWS\system32\cmd.exe

usage: hex2bin [OPTIONS] filename
Options:
  -s [address] Starting address in hex (default: 0)
  -l [length]  Maximal Length (Starting address + Length -1 is Max Address)
               File will be filled with Pattern until Max Address is reached
               Length must be a power of 2 in hexadecimal:
               Hex      Decimal
               1000    =    4096  (<4ki)
               2000    =    8192  (<8ki)
               4000    =   16384  (<16ki)
               8000    =   32768  (<32ki)
               10000   =   65536  (<64ki)
               20000   =  131072  (<128ki)
               40000   =  262144  (<256ki)
               80000   =  524288  (<512ki)
               100000  = 1048576  (<1Mi)
               200000  = 2097152  (<2Mi)
               400000  = 4194304  (<4Mi)
               800000  = 8388608  (<8Mi)
  -e [ext]    Output filename extension (without the dot)
  -c          Enable hex file checksum verification
  -p [value]  Pad-byte value in hex (default: ff)

  -k [0!1!2] Select checksum type
               0 = 8-bit,
               1 = 16-bit little endian,
               2 = 16-bit big endian
  -r [start] [end] Range to compute checksum over (default is min and max addresses)
  -f [address] [value] Address and value of checksum to force

C:\_hex2bin>hex2bin -c blinky_1.hex
hex2bin v1.0.10, Copyright (C) 2012 Jacques Pelletier & contributors
Lowest address = 00000000
Highest address = 00000447
Pad Byte = FF
8-bit Checksum = 33

C:\_hex2bin>hex2bin -c blinky_2.hex
hex2bin v1.0.10, Copyright (C) 2012 Jacques Pelletier & contributors
Lowest address = 00000000
Highest address = 00000477
Pad Byte = FF
8-bit Checksum = D8

C:\_hex2bin>cd _hex2bin_

```

Figure 161: Hex2Bin.exe Example

SmartBond Production Line Tool

Appendix H Bin2Image

Figure 163 shows an example of using the `bin2image.exe` utility, which creates a bootable-cached image for DA1468x devices.

The file `bin2image.exe` must be put in the same directory as the file to be converted. Figure 162 shows the directory and the files used in this example.

Name	Date modified	Type	Size
temp	7/27/2016 8:54 PM	File folder	
bin2image.exe	5/17/2016 9:53 PM	Application	44 KB
pxp_reporter.bin	10/16/2015 5:19 PM	BIN File	57 KB
pxp_reporter.bin.cached	7/27/2016 8:54 PM	CACHED File	57 KB

Figure 162: Bin2Image Example Directory with Files

```

C:\WINDOWS\system32\cmd.exe
C:\_Test>bin2image ?
Version: 1.8

bin2image type binary_file image_file [ AD [enable_uart] [ram_shuffling] ]

Convert the executable binary file 'binary_file' to a
bootable image file 'image_file'.
The 'type' argument defines what kind of image to be
generated:
  qspi_cached      QSPI flash image for cached mode <production & development paths>
  qspi_mirrored    QSPI flash image for mirrored mode <production path only>
  qspi_single_mirrored QSPI flash image for mirrored mode <development path only, qspi operating in single mode>
  otp_cached       OTP image for cached mode
  otp_mirrored     OTP image for mirrored mode

If argument 'AD' is passed, it commands the generation of
an image for version AD of the chip, whose header is 16
bytes long, instead of 8.
If 'AD' is passed:
- 'enable_uart' can be used to enable UART during boot
  <the default is not to enable it>
- 'ram_shuffling' can take value 0, 1, 2, or 3 to
  configure the DataRAM cell shuffling:
  0: 8 - 24 - 32 (default)
  1: 24 - 8 - 32
  2: 32 - 8 - 24
  3: 32 - 24 - 8

Note: For cached mode images, the MSBit of the length is set to 1

C:\_Test>bin2image qspi_cached xpx_reporter.bin xpx_reporter.bin.cached AD enable_uart
C:\_Test>
  
```

Figure 163: Bin2Image Example

Appendix I Automatic GU COM Port Find

For the GU COM port automatic recognition to operate, a special serial number should exist in the GU FTDI IC. Usually this serial number is programmed during PLT PCB manufacturing, but it may not exist in some older versions.

If the 'GU COM port find' operation does not work, then the steps described in should be followed.

Table 108: FTDI "DialogSemi" Serial Number

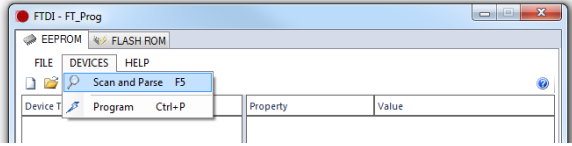
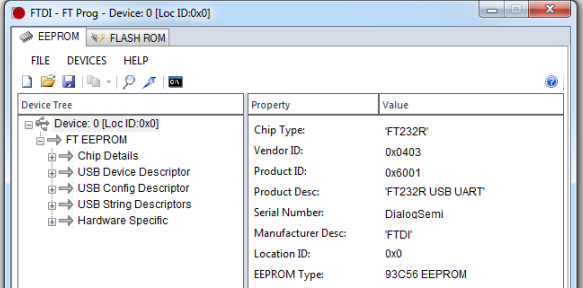
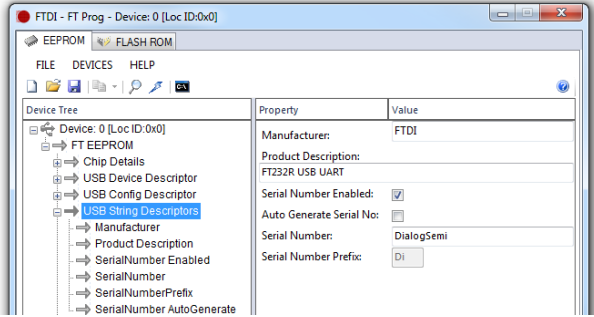
Step	Description
1	Download the FTDI FT_Prog tool from http://www.ftdichip.com/Support/Utilities.htm#FT_PROG .
2	Put power on the PLT board.
3	Remove any other USB FTDI connection to the PC.
4	Connect the USB cable of the GU to the PC.
5	Check the Device Manager that the GU COM port has been found.
6	Run the FT_Prog.exe. 
7	Select 'Devices > Scan and Parse'. 
8	A single 'FT232' device should be found. 
9	Select 'USB String Descriptors'.
10	Uncheck the 'Auto Generate Serial No:'.
11	Edit 'Serial Number' to "DialogSemi" as shown below. 

SmartBond Production Line Tool

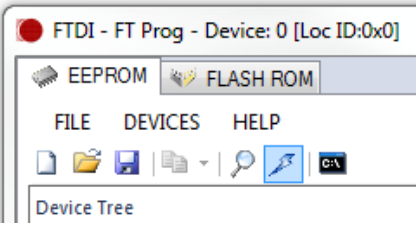
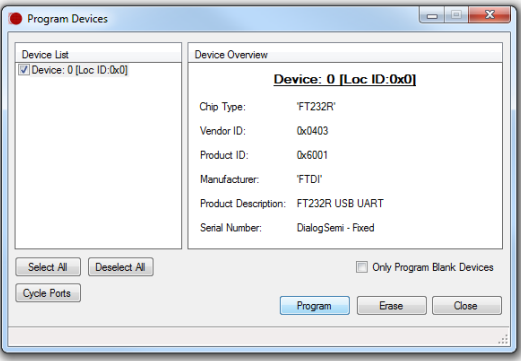
Step	Description
12	Click the 'Flash' button to program the change to the FTDI IC. 
13	Click 'Program' in the new window. 
14	Click 'Close'.
15	Unplug and reconnect the GU USB cable to the PC.
16	Verify the Serial Number change by running FT_Prog.exe again and reading the Serial Number value.

Appendix J Improving Cabling between PLT and DUTs

The following recommendations can be used to improve the connections between PLT and DUTs:

- Keep the lengths of the cables as short as possible
- When possible use twisted pair cables instead of separate cables for:
 - GND/VBAT
 - GND/TxD
 - GND/RxD
 - GND/VPP
- Use ferrite beads for noise reduction in cables



Figure 164: Example of Twisted Pair Cable with 4 Pairs and Ferrite

- Connect pull-down resistors at the end of the PLT TX signal lines. Use a 4.7 kΩ resistor at PLT DUT Connector Pin 7 (DUT TX) with the other end connected to ground. In total 16 resistors must be mounted, one for each PLT DUT connector
- Connect a pull-down resistor as close as possible to the UART RX signal connector on the DUT. The value should be approximately 4.7 kΩ. Connect the other end of the resistor to ground
- Use gold plated contacts in the connections between the PLT and the DUTs
- Use extra drivers in the UART lines
- Use series resistors of approximately 100 Ω in the UART lines, one mounted at the beginning and one at the end of the signal lines

Note: Start with the simple solutions first by testing them one-by-one for stability.

Figure 165 and Figure 166 show examples of some of the above proposals.

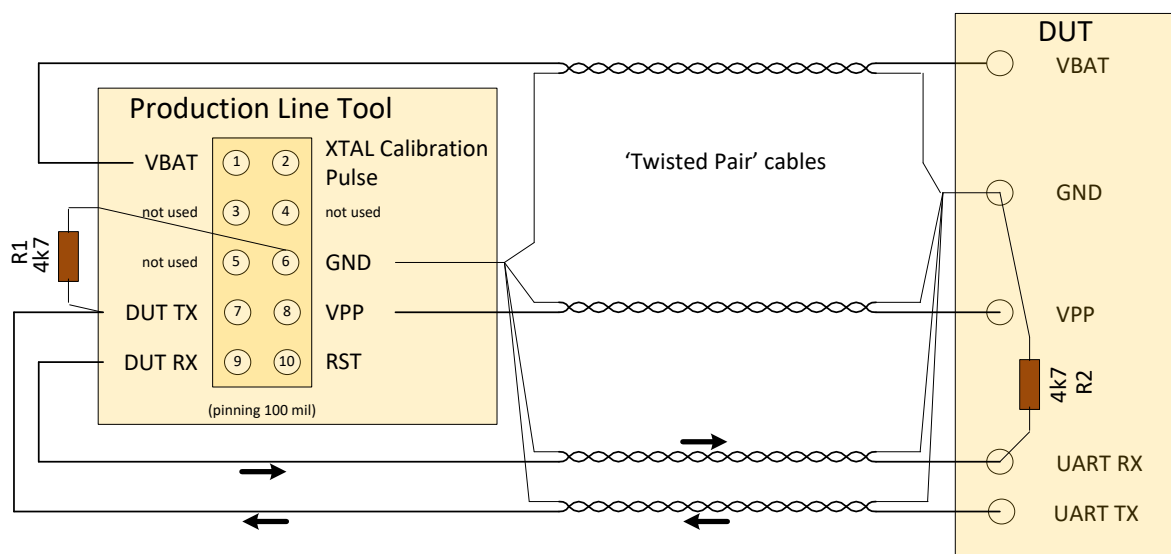

Figure 165: Location of Pull-Down Resistors

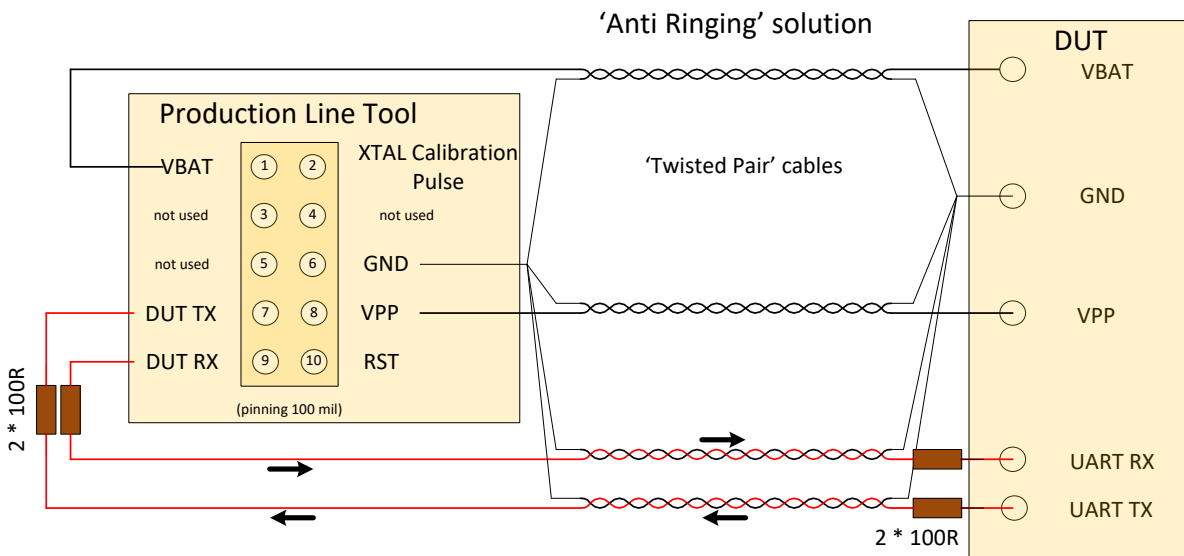

Figure 166: Anti-Ringing Solution

Appendix K DA14583 Internal SPI Flash Memory

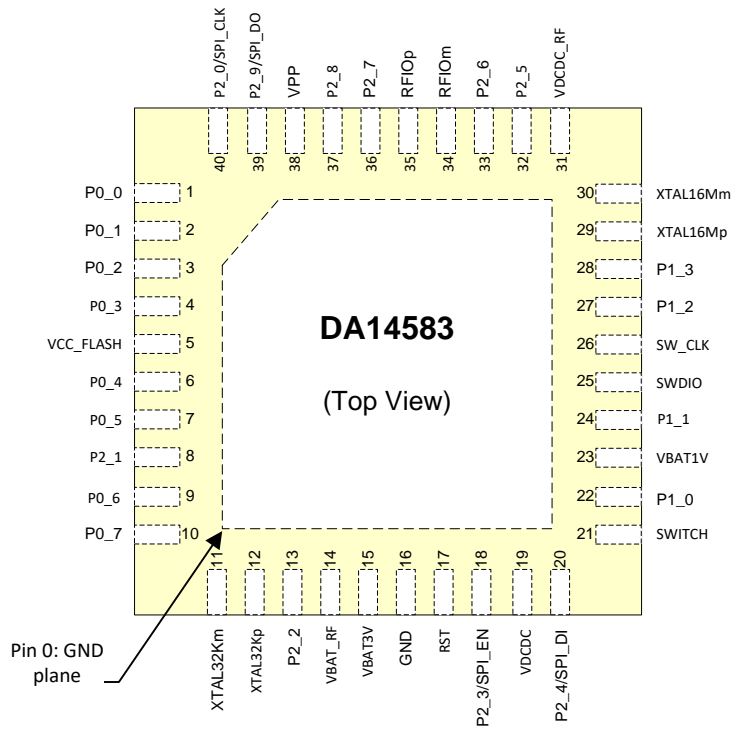

Figure 167: Pin Assignment of DA14583 – QFN40

DA14583 is the SPI master in regard to the internal SPI flash memory.

Table 109: DA14583 Internal SPI Flash Connections

DA14583 Pin	SPI Function	Description
P2_0	SPI_CLK	SPI Clock
P2_4	SPI_DI (in)	MISO
P2_9	SPI_DO (out)	MOSI
P2_3	SPI_EN	SPI Chip Select

Appendix L DA14586 Internal SPI Flash Memory

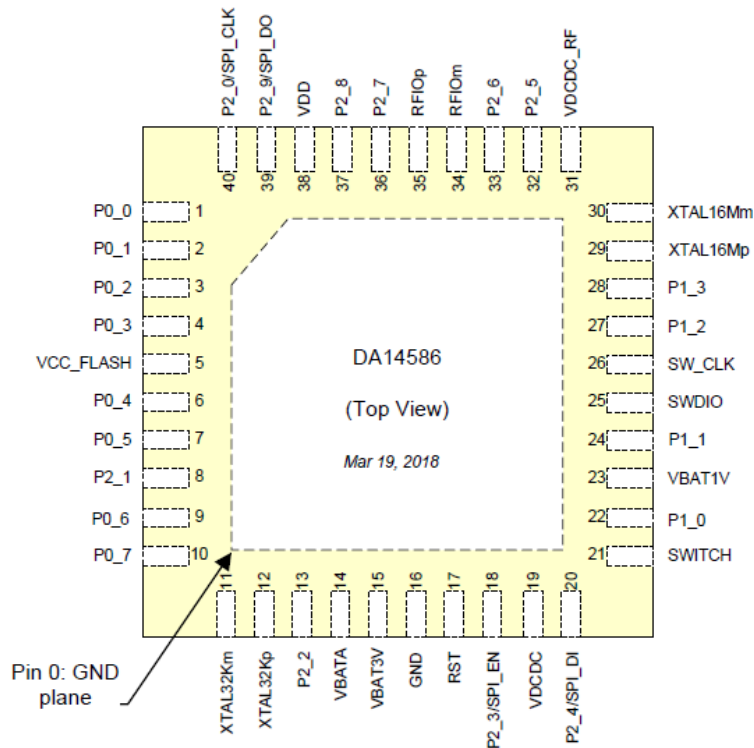

Figure 168: Pin Assignment of DA14586 - QFN40

DA14586 is the SPI master in regard to the internal SPI flash memory.

Table 110: DA14586 Internal SPI Flash Connections

DA14586 Pin	SPI Function	Description
P2_0	SPI_CLK	SPI Clock
P2_4	SPI_DI (in)	MISO
P2_9	SPI_DO (out)	MOSI
P2_3	SPI_EN	SPI Chip Select

SmartBond Production Line Tool**Appendix M Honeywell Xenon 1900 Barcode Scanner Setup**

To use the Honeywell Xenon 1900 then please follow the steps below to appropriate set it up for PLT usage.

1. Download Xenon-UG.pdf User Guide.
2. Scan Restore factory defaults at page 198 (Resetting the Factory Defaults)
3. Program the USB to Serial Interface. Scan code at Page 32 (TRMUSB130)
4. Download Xenon USB to Serial drivers HSM USB Serial Driver version 3.5.5.zip

SmartBond Production Line Tool

Appendix N Golden Unit Upgrade Using Smart Snippets Toolbox

The SPI Flash memory of the Golden Unit can be programmed as any DA14580 device, using the JTAG connector next to the Golden Unit and the Smart Snippets Toolbox application.

1. Connect the power supply to the PLT hardware as described in [PLT Power Supply](#).
2. Connect the USB cable of the Golden Unit.
3. Connect the JTAG (J2) of the Golden Unit.
4. Open the Smart Snippets Toolbox and select the JTAG method and the DA14580 chip.
5. Under the “Layout” category, on the “Booter & Board Setup page”, the GPIOs for the Flash memory should be the following: CLK: P0_0, CS: P0_3, MISO: P0_5, MOSI: P0_6.
6. Under the “Tools” category, on the “SPI Flash Programmer” tab, using the “Browse” button, select the “prod_test_GU.bin” binary which is under the SmartBond SmartBond_PLT_v4.x/binaries/GU/prod_test_GU.bin folder on the PLT software package.
7. After the binary is loaded on the Smart Snippets Toolbox, click “Connect” at the bottom. This will download a firmware on the Golden Unit and set the SPI Flash GPIOs to program the memory.
8. Select “Erase” to completely erase the Flash memory before burning the new firmware.
9. Select “Burn and Verify”. On the pop-up message, select to make the firmware bootable.
10. Remove the JTAG from the PLT hardware and then manually reset the Golden Unit using the reset button next to it. The Golden Unit has now booted with the new firmware.

Appendix O Connecting a Speaker to the Golden Unit for Audio Test

PLT is able to perform audio test for DA14582, DA14585 and DA14586 devices. A speaker can be connected to the Golden Unit using GPIOs P1_0 (AL4) and P1_1 (AL5) as shown in [Figure 169](#) to generate the 4 kHz tone.



Figure 169: Speaker Connection for Audio Test.

SmartBond Production Line Tool

Appendix P FTDI Driver Removal and Installation

To re-install the latest FTDI drivers, the previous should be uninstalled.

FTDI driver removal:

1. Download CDM uninstaller from <http://www.ftdichip.com/Support/Utilities.htm#CDMUninstaller>.
2. Run `CDMuninstallerGUI.exe`
3. The VID/PID of the PLT FTDIs are VID=0403/PID=6011 for the DUTs and VID=0403/PID=6001 for the GU.
Enter these VIDs and PIDs in the CDM Uninstaller and click Add for each one.
4. Then click on `Remove Devices` to uninstall the FTDI drivers.
5. Un-plug both USB cables.

More information can be found in the following link:

http://www.ftdichip.com/Support/Utilities/CDM_Uninst_GUI_Readme.html

FTDI driver installation:

1. Download the latest drivers from <http://www.ftdichip.com/Drivers/VCP.htm> and install them using the executable.
2. After uninstalling the drivers, plug in both USB cables. Windows will automatically assign the new drivers. Do not remove the cables during driver installation. A driver installation error may occur and the removal-installation will have to be repeated.
3. Check in the Windows Device manager that the driver versions of the 17 PLT COM Ports->USB Serial Ports are the latest.

FTDI driver versions v2.12.24, v2.12.26 and 2.12.28 have been tested.

Appendix Q DA1458x DK Pro Motherboard Connection

Figure 170 shows the wiring to a DA14580/1/2/3/5/6 Pro DK motherboard.

As described in [DUT Connector](#) the following connections are needed to connect a DUT to the PLT.

1. Ground. DUT connector pin6 <-> Pro DK J5 pin2.
2. VBAT. DUT connector pin1 <-> Pro DK J5 pin1.
3. UART Tx. DUT connector pin7 <-> Pro DK J5 pin11.
4. UART Rx. DUT connector pin9 <-> Pro DK J5 pin13.
5. Reset. DUT connector pin10 <-> Pro DK J5 pin3 (Optional).

If no power supply is provided through the USB cable (J12), the reset circuit will drive the reset pin of the DUT host board (connector J4) high, keeping the DUT at a reset state. To overcome this either the R84 resistor should be removed or the USB cable should be connected.

Additionally, J11 jumper should be removed. Power supply to the board will be provided from the PLT HW (VBAT line).

To use the onboard SPI flash memory J5 jumper configuration should be as shown on the silkscreen PCB print (left of J5). A special jumper must be used to connect the P0_5 (J5 – pin13) with the SPI MISO (J6 – pin2) and the PLT UART-Rx pin (on DUT connector – pin9).

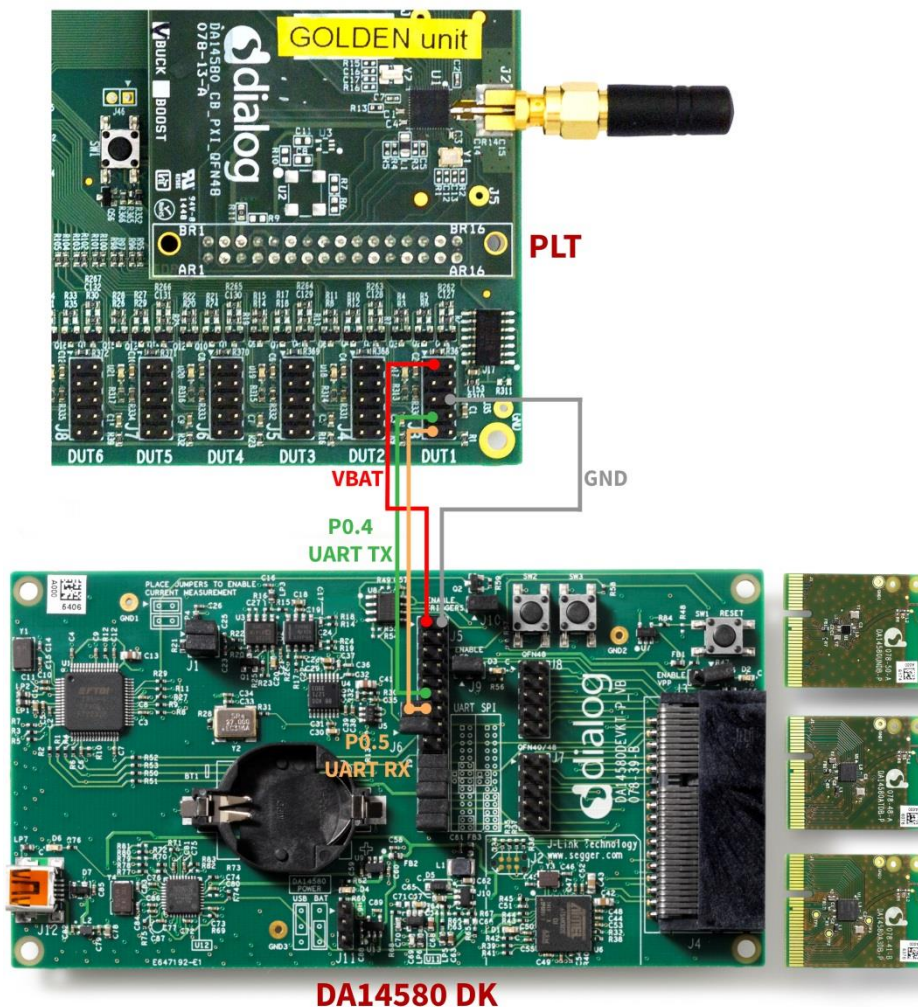

Figure 170: DA14580/5 Pro Motherboard DK Wiring.

Appendix R DA1468x DK Pro Motherboard Connection

Figure 171 shows the wiring to a Pro DK motherboard for the DA14680/1/2/3 DUTs.

As described in [DUT Connector](#) the following connections are needed to connect a DUT to the PLT:

1. Ground. DUT connector pin6 <-> Pro DK J3 pin22.
2. VBAT. DUT connector pin1 <-> Pro DK J3 pin24.
3. UART Tx. DUT connector pin7 <-> Pro DK J4 pin8.
4. UART Rx. DUT connector pin9 <-> Pro DK J3 pin19.
5. Reset. DUT connector pin10 <-> Solder to Reset button (K2) (Optional).

All board jumpers must be removed. Power supply will be provided from the PLT HW (VBAT line).

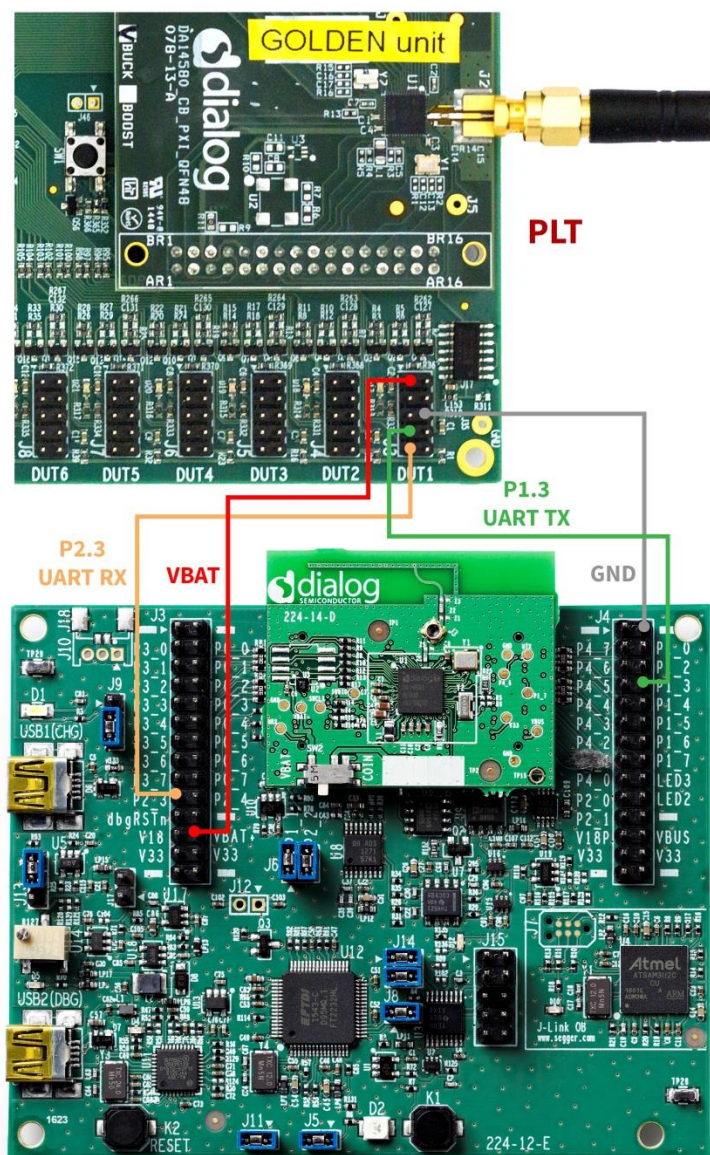

Figure 171: DA14680/1/2/3 Pro Motherboard DK Wiring

Appendix S Connecting DA1468x DK Pro Motherboard for Current Measurements

DA1468x DK Pro motherboards are equipped with current measurement modules. Therefore, they can operate as external ammeters with the PLT.

The DA1468x DK Pro motherboard should be connected to J26 as shown in [Figure 172](#). A three-wire connection must be made between the PLT board and the motherboard. Jumpers J9 should be removed from the DA1468x DK Pro motherboard. It is mandatory to have a common ground between the two boards. One possible ground connection is shown with the purple line.

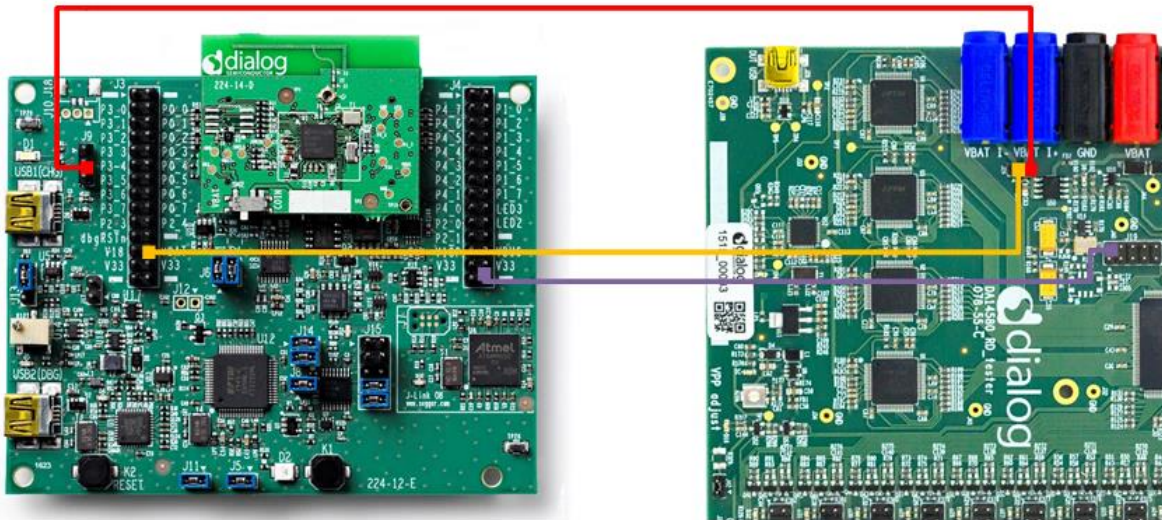

Figure 172: DA1468x PRO DK Ammeter Connection with PLT

To use the DA1468x Pro motherboard as current measurement instrument in PLT, the `ammeter_da1468x_dk.dll` should be selected in [Current Measurement Test](#) (DA1458x) or

[Current Measurement Test](#) (DA1469x) test settings panel. The interface should be set to the second FTDI COM port enumerated in Windows, as shown in [Figure 173](#).



Figure 173: DA1468x DK PRO Current Measurement Settings

Appendix T Connecting DUT with Battery Supply

Wiring connections to a battery powered DUT is described in [DUT Connector](#). Example connections can be found in chapters [DA1458x DK Pro Motherboard Connection](#) and [DA1468x DK Pro Motherboard Connection](#).

1. Four wires are mandatory for the connection:
 - Common Ground
 - UART Tx
 - UART Rx
 - Reset line
2. 'VBAT as Reset' mode is the only mode supporting battery powered DUTs since POR cannot be performed. For the PLT to perform a reset on the DUTs, the VBAT line of each DUT connector must be connected to the reset line of the DUT.
3. Current measurement is not supported, since there is no way to measure the current of the DUTs.
4. To program the OTP for the DA14580/1/2/3 DUTs, an external VPP voltage must be supplied. VPP lines on the DUT connectors will not provide any voltage in 'VBAT as Reset' mode so they cannot be used.

To have the least possible wiring connections, UART Rx line can also be used as input GPIO for the pulse used during the XTAL Trim procedure.

Appendix U User Interfaces Shortcut Keys

Table 111: User Interface Shortcut Keys

Application	Shortcut	Description
CFG PLT Application	Ctrl + S	This shortcut is equivalent to clicking the save button at the bottom of the screen.
GUI PLT Application	Space-Bar	It is used to select the 'Start' button to start testing.
	F	It is equivalent to clicking the 'Finished' button with the left mouse-click.

SmartBond Production Line Tool

Appendix V DA1458x Supported SPI Flash\EEPROM Memories

Table 112 describes the supported SPI Flash and EEPROM memories for DA1458x devices. To use a memory not shown in the list, use [SPI Flash Configuration](#) or [I2C EEPROM Configuration](#).

Table 112: DA1458x Supported SPI Flash Memories

Memory type	Memory vendor	Product number
SPI Flash memory	Windbond	W25X10
		W25X20
		W25X40
	Adesto	AT25Dx011
		AT25XE021
		AT25XE041
	Macronix	MX25V1006E
		MX25R1035F
		MX25R2035F
		MX25R4035F
		MX25R8035F
		MX25R1635F
		MX25V1035F
		MX25V2035F
		MX25V4035F
MX25V8035F		
MX25V1635F		
I2C EEPROM	ST	M24M02

SmartBond Production Line Tool

Appendix W DA14531 Supported SPI Flash Memories

Table 113 describes the supported SPI Flash memories for DA14531 devices. To use a memory not shown in the list, use [SPI Flash Configuration](#).

Table 113: DA14531 Supported SPI Flash Memories

Memory type	Memory vendor	Product number
SPI Flash memory	Windbond	W25X10
		W25X20
	Adesto	AT25Dx011
	Macronix	MX25V1006E
		MX25R1035F
		MX25R2035F
		MX25R4035F
		MX25R8035F
		MX25R1635F
		MX25V1035F
		MX25V2035F
		MX25V4035F
		MX25V8035F
		MX25V1635F
	Puya	P25Q10U
		P25Q40U
	GigaDevice	GD25WD10
		GD25WD20

SmartBond Production Line Tool

Appendix X DA1468x Supported QSPI Flash Memories

Table 114 describes the supported QSPI flash memories for DA1468x devices. To support a QSPI flash memory that is not in the list, follow the DA1468x QSPI Flash Support {#flash_support} instructions in `readme.md` file located under `DA1468x_DA15xxx_SDK_1.0.12.1078\DA1468x_DA15xxx_SDK_1.0.12.1078\sdk\bsp\memory\` folder to manually add it inside the `uartboot.bin` firmware.

Table 114: DA1468x Supported QSPI Flash Memories

Memory vendor	Product number
Windbond	W25Q80EW
Gigadevice	GD25LQ80B
Macronix	MX25U51245
ISSI	IS25LP128

Appendix Y DA1469x Supported QSPI Flash Memories

Table 115 describes the supported QSPI flash memories for DA1469x devices. To support a QSPI flash memory that is not in the list, follow the DA1469x QSPI Flash Support {#flash_support} instructions in `readme.md` file located under `SDK_10.0.8.105\sdk\bsp\memory\` folder to manually add it inside the `uartboot.bin` firmware.

Table 115: DA1469x Supported QSPI Flash Memories

Memory vendor	Product number
Windbond	W25Q32FW
Gigadevice	GD25LE32
Macronix	MX25U3235

Appendix Z BLE Tester Measurement Results

When using an MT8852B as an external BLE tester instrument for the DA14531 [RF Tests](#) and DA1469x [RF Tests](#), PLT will instruct the MT8852B to perform specific tests and then wait for its reply. MT8852B replies with a string, containing the command code of the test performed, followed by the results of the test or an [Error Response](#) string.

[Table 116](#) shows the result command codes.

The PDF document (located by clicking) the following link, describes the format of the result string for each command code, under chapter 15 – 7.

<https://dl.cdn-anritsu.com/en-au/test-measurement/files/Manuals/Programming-Manual/MT8852B/MT8852B-Bluetooth%20tester-Programming%20Manual%20Rev%20X.pdf>

Table 116: MT8852B Supported Command Codes

Code	Test
LEOP0	TX power
LEICD0	Carrier frequency and Drift
LEMI	Modulation index
ERRLST	Error response

As an example, the test results of DUT1 in the example of [CSV Log File Contents](#) will be used.

Tx Power

The result of DUT1 for the TX-Power test is:

TRUE;-14.25;-14.25;-14.25;0.10;0;2;PASS

Table 117: MT8852B – BLE TX Output Power Test Results

Description	Format	Example
Results valid	TRUE FALSE	TRUE
Packet average power in dBm	floating point	-14.25
Test avg max in dBm	floating point	-14.25
Test avg min in dBm	floating point	-14.25
Test peak to average power in dBm	floating point	0.10
Number of failed packets	integer	0
Number of tested packets	integer	2
Pass/fail result	PASS FAIL	PASS

SmartBond Production Line Tool
Frequency Offset

The result of DUT1 for the Frequency Offset test is:

TRUE;-2.500e+003;2.800e+003;-7.800e+003;-7646;-9.0e+003;-9.0e+003;0;2;PASS;-7646

Table 118: MT8852B – BLE Carrier Frequency Offset and Drift Test Results

Description	Format	Example
Drift rate valid	TRUE FALSE	TRUE
Average Fn	Integer	-2.500e+003
Maximum Positive Fn	Integer	2.800e+003
Minimum Negative Fn	integer	-7.800e+003
Drift rate	integer	-7646
Average drift	integer	-9.0e+003
Maximum drift	integer	-9.0e+003
Packets Failed	integer	0
Packets Tested	integer	2
Pass/fail result	PASS FAIL	PASS
Initial drift rate	integer	-7646

Modulation Index

The result of DUT1 for the Modulation Index test is:

TRUE;282100.00;249100.00;200700.00;248700.00;1.00;0;576;1;1;FAIL;100.00%

The tester responded with FAIL because two tests with different patterns were needed. The overall result of the Modulation Index test will be concluded in a second step, after the second payload is tested.

Table 119: MT8852B – BLE Modulation Characteristics Test Results

Description	Format	Example
Results valid	TRUE FALSE	TRUE
Delta f1 max in Hz	floating point	282100.00
Delta f1 average in Hz	floating point	249100.00
Delta f2 max in Hz (Delta f1 max lowest for BLR8)	floating point	200700.00
Delta f2 average in Hz (omitted for BLR8)	floating point	248700.00
Delta f2 avg / delta f1 avg (Omitted for BLR8)	floating point	1.00
Delta f2 max Failed limit (Delta f1 max Failed limit for BLR8)	integer	0
Delta f2 max count (Delta f1 max count for BLR8)	integer	576
Packets failed	integer	1
Packets tested	integer	1
Pass/fail result	PASS FAIL	FAIL

SmartBond Production Line Tool

Description	Format	Example
Delta f2 max % pass rate (Delta f1max % pass rate for BLR8)	floating point	100.00%

Error Response

If the BLE Tester fails to perform the tests it will respond with an error. [Table 120](#) describes the parts of the error message. Click the following link to find more details in chapter 4.3 of the relative PDF document:

<https://dl.cdn-anritsu.com/en-au/test-measurement/files/Manuals/Programming-Manual/MT8852B/MT8852B-Bluetooth%20tester-Programming%20Manual%20Rev%20X.pdf>

The format of the response message is

ABCCDDEFGHIIJKK!LLLLLLL!MMMMMM!NNNNNN!OOOOOO!

A common error response, which is not an actual error, is the message below:

00000000000000!NO ERRORS!NO ERRORS!!!

This is due to the output received signal may be less than -50 dB.

Table 120: MT8852B – Error List

Alias	Error	Status	Description
A	CONNECTION ALREADY EXISTS	0	No previous connection
		1	Connection already exists
B	EUT TEST MODE STATE	0	EUT Test Mode enabled
		1	EUT Test Mode not enabled
CC	EUT HCI ERROR	00	OK
		XX	2-digit hex error code (EUT controlled via RS232)
DD	INTERNAL HCI ERROR	00	OK
		XX	2-digit hexadecimal error code
E	INTERNAL SYNC ERROR	0	OK
		1	Internal HCI synchronization error
F	EUT SYNC ERROR	0	OK
		1	EUT HCI synchronization error (control via RS232)
G	EUT HARDWARE ERROR	0	OK
		1	EUT Reported HCI Hardware error message
H	REQUEST FAILED	0	OK
		1	Request failed (system busy)
II	DSP STATUS Note: Setting of the DSP status code will not set the DDE bit of the event register	00	OK
		01	Searching channel
		02	Searching sync word
		03	Incorrect packet length
		04	No payload
		05	Auto ranging
		06	Incorrect packet
		07	Incorrect packet type

SmartBond Production Line Tool

Alias	Error	Status	Description
		08	Over range
		09	Under range
		10	Invalid payload
		11	Error finding start of packet using power profile
		12	Error locating P0/GFSK sync word
		13	Location of P0/GFSK sync word exceeds allowed limits
		14	Error locating EDR sync word
		15	Location of EDR sync word exceeds allowed limits
		16	Error decoding the packet type field
		17	Modulation mode of PI/4-DQPSK or 8DPSK not specified
		18	pi/4-DQPSK modulation does not match with detected packet type
		19	8DPSK modulation does not match with packet type
		20	Invalid packet type decoded
		21	Unknown packet type decoded
		22	Expected and measured packet lengths do not match
		23	Insufficient blocks in packet for measurement
J	EUT BT ADDRESS	0	OK
		1	EUT Bluetooth Address set (in Manual mode)
KK	HCI COMM STATUS	00	OK
		01	Unknown HCI command
		02	No connection
		03	Hardware failure
		04	Paging timeout
		05	Connection timeout
		06	Unsupported feature parameter
		07	Connection ended by user
		08	Low resource connection ended
		09	Power Off connection ended
		10	Local host connection ended
		11	Unsupported remote feature
		12	Role change not allowed
		13	LMP response timeout
		14	IQ modem DAC saturation
LLLLLLL			Internal core error text (variable length)
MMMMMMM			EUT core error text (variable length)
NNNNNNN			Last GPIB command that caused a Command error (variable length)
OOOOOOO			Last GPIB command that caused an Execution error (variable length)

Appendix AA Memory programming

This appendix lists all possible memory programming operations. The memory operations are grouped per chipset and memory type.

AA.1 DA14580/1/2/3/5/6 Memory Programming Tests

OTP

Table 121: DA1458x Memory Programming – OTP Memory

Test Name	Operation	No.	Description	
XTAL Trim	Write\ Verify	1	This operation writes the user selected binary into the OTP memory. The start address will always be address 0. If Verify is selected, PLT will read the OTP contents for the size of the binary burned and compare it with the actual binary. If the binary size is larger than the OTP image area, PLT considers that the binary contains the header as well. PLT can also program the following during OTP image burn. DMA length	
OTP Header	Write\ Verify	1	The OTP header write operation will write any non-zero header field one by one. If the Verify option is selected it will read the OTP header fields and compare them to the ones written before.	
BD Address	Write\ Verify	1	The BD address write procedure will write the BD address field in the OTP header area. If the Verify option is selected, PLT will read the OTP BD address and compare it to the one written before.	
	Read\ Compare	1	This will read the BD address field from the OTP header and save it to the DUT logs. If the Compare option is selected it will compare the address read with the one PLT uses for the particular device.	
Memory read	Read	101	The memory read procedure can read any OTP memory area and save the results in the DUT logs.	
Custom Memory Data	Barcode scanner CSV file Manual	Write\ Verify	1	This procedure will write data with a given size at a given address offset. A barcode scanner is used as data input. If the Verify option is selected, PLT will read the contents and compare it to the one written before.
			51	This procedure will read the memory programming parameters from a CSV file. Up to 5 memory writes can be set. If the Verify option is selected, PLT will read the memory contents and compare them to the ones written before.
			1	The manual procedure will write data with a given size at a given address offset. If the Verify option is selected, PLT will read the memory contents and compare them to the ones written before.

Note 2 Applies to all available memories simultaneously.

Note 3 Check `Empty` is performed by reading the memory contents and checking whether these are all zeros.

Note 4 Check `if data match` is performed by reading the memory contents and checking whether these are all zeros or the data to be written are the same.

Note 5 If the OTP part to be written contains all-zero values, then the write operation will not be performed.
This also applies for writing default values in the OTP header.

SPI Flash

Table 122: DA1458x Memory Programming - SPI Flash

Test Name	Operation	No.	Description
SPI Flash Configuration	Initialize	1	The memory programming firmware can auto-detect the memories listed in Table 112 . However, PLT can also use a user-defined SPI flash configuration. PLT

SmartBond Production Line Tool

Test Name	Operation	No.	Description	
			will send a command containing the SPI configuration set by the user. For the DA14583 and DA1586 devices, this option is disabled because PLT initializes the firmware with the internal SPI flash characteristics.	
SPI Flash Memory	Erase	10	The erase operation can perform up to 10 erase tests, which can erase either the entire memory or specific sections.	
	Check Empty	10	This can perform up to 10 different check empty operations, which will verify that specific sections or the entire memory is empty.	
	Write\ Verify	10	This operation will write a user defined binary at a given offset or at offset 0 if it is a bootable image. If the <i>Verify</i> option is selected, PLT will read the contents and compare it to the one written before.	
Memory read	Read	10 ¹	The memory read procedure can read any field of the SPI memory and save the data into the DUT logs.	
Custom Memory Data	Barcode scanner	Write\ Verify	1	This procedure will write data with a given size at a given address offset. A barcode scanner is used as data input. If the <i>Verify</i> option is selected, PLT will read the contents and compare it to the one written before.
	CSV file		5 ¹	This procedure will read the memory programming parameters from a CSV file. Up to 5 memory writes can be set. If the <i>Verify</i> option is selected, PLT will read the memory contents and compare them to the ones written before.
	Manual		1	The manual procedure will write data with a given size at a given address offset. If the <i>Verify</i> option is selected, PLT will read the memory contents and compare them to the ones written before.

Note 6 Applies for all available memories simultaneously.

SmartBond Production Line Tool

EEPROM

Table 123: DA1458x Memory Programming – EEPROM Memory

Test Name		Operation	No.	Description
I2C EEPROM Configuration		Initialize	1	The memory programming firmware can auto-detect the memories listed in Table 112 . However, PLT can also use a user-defined EEPROM configuration. PLT will send a command containing the EEPROM configuration set by the user.
I2C EEPROM Memory		Write\ Verify	10	This operation will write a user defined binary at a given offset or at offset 0 if it is a bootable image. If the <i>Verify</i> option is selected, PLT will read the contents and compare it to the one written before.
Memory read		Read	10 ¹	The memory read procedure can read any field of the SPI memory and save the data into the DUT logs.
Custom Memory Data	Barcode scanner	Write\ Verify	1	This procedure will write data with a given size at a given address offset. A barcode scanner is used as data input. If the <i>Verify</i> option is selected, PLT will read the contents and compare it to the one written before.
	CSV file		5 ¹	This procedure will read the memory programming parameters from a CSV file. Up to 5 memory writes can be set. If the <i>Verify</i> option is selected, PLT will read the memory contents and compare them to the ones written before.
	Manual		1	The manual procedure will write data with a given size at a given address offset. If the <i>Verify</i> option is selected, PLT will read the memory contents and compare them to the ones written before.

Note 7 Applies for all available memories simultaneously.

SmartBond Production Line Tool

AA.2 DA1468x Memory Programming Operation

OTP

Table 124: DA1468x Memory Programming – OTP Memory

Test Name	Operation	No.	Description	
XTAL Trim	Write\ Verify	1	The XTAL trim procedure will first find an available OTP TCS field to write the value even if another XTAL trim value is programmed at a previous TCS field. If the <i>Verify</i> option is selected it will read the OTP TCS section field and compare them to the one written before.	
OTP Memory	Write\ Verify	1	This operation writes the user selected binary into the OTP memory. The start address will always be address 0. If <i>Verify</i> is selected, PLT will read the OTP contents for the size of the binary burned and compare it with the actual binary. If the binary size is larger than the OTP image area, PLT considers that the binary contains the header as well. PLT can also program the following during OTP image burn. <ul style="list-style-type: none"> • DMA length • Image CRC 	
Memory Header (DA14531)	Write\ Verify	1	The OTP header write operation will write any non-zero header field one by one. If the <i>Verify</i> option is selected it will read the OTP header fields and compare them to the ones written before.	
BD Address	Write\ Verify	1	The BD address write procedure will write the BD address field in the OTP header area. If the <i>Verify</i> option is selected, PLT will read the OTP BD address and compare it to the one written before.	
	Read\ Compare	1	This will read the BD address field from the OTP header and save it to the DUT logs. If the <i>Compare</i> option is selected it will compare the address read with the one PLT uses for the particular device.	
Memory read	Read	10 ¹	The memory read procedure can read any OTP memory area and save the results in the DUT logs.	
Custom Memory Data	Barcode scanner	Write\ Verify	1	This procedure will write data with a given size at a given address offset. A barcode scanner is used as data input. If the <i>Verify</i> option is selected, PLT will read the contents and compare it to the one written before.
	CSV file		5 ¹	This procedure will read the memory programming parameters from a CSV file. Up to 5 memory writes can be set. If the <i>Verify</i> option is selected, PLT will read the memory contents and compare them to the ones written before.
	Manual		1	The manual procedure will write data with a given size at a given address offset. If the <i>Verify</i> option is selected, PLT will read the memory contents and compare them to the ones written before.

Note 8 Applies for all available memories simultaneously.

Note 9 Check *Empty* is performed by reading the memory contents and checking whether these are all zeros.

Note 10 Check *if data match* is performed by reading the memory contents and checking whether these are all zeros or the data to be written are the same.

Note 11 If the OTP part to be written contains all-zero values, then the write operation will be omitted. This also applies for writing default values in the OTP header.

SmartBond Production Line Tool

QSPI

Table 125: Memory Programming – QSPI Memory

Test Name		Operation	No.	Description
XTAL Trim		Write\ Verify	1	The XTAL trim QSPI write procedure will write the XTAL trim value found during the calibration process to the user defined QSPI address. If the <i>Verify</i> option is selected, PLT will read the QSPI user defined address contents and compare them to the ones written before.
QSPI Flash Memory		Erase	10	The erase operation can perform up to 10 erase tests, which can erase either the entire memory or specific sections.
		Check Empty	10	This can perform up to 10 different check empty operations, which will verify that specific sections or the entire memory is empty.
		Write\ Verify	10	This operation will write a user defined binary at a given offset or at offset 0 if it is a bootable image. If the <i>Verify</i> option is selected, PLT will read the contents and compare it to the one written before.
QSPI Header - BD Address		Write\ Verify	1	The BD address write procedure will write the BD address field in the QSPI user defined address. If the <i>Verify</i> option is selected, PLT will read the data from QSPI user defined address and compare them with the ones written before.
		Read\ Compare	1	This will read the BD address field from the QSPI user defined address and save it to the DUT logs. If the <i>Compare</i> option is selected it will compare the address read with the one PLT uses for the particular device.
Memory read		Read	10 ¹	The memory read procedure can read any field of the SPI memory and save the data into the DUT logs.
Custom Memory Data	Barcode scanner	Write\ Verify	1	This procedure will write data with a given size at a given address offset. A barcode scanner is used as data input. If the <i>Verify</i> option is selected, PLT will read the contents and compare it to the one written before.
	CSV file		5 ¹	This procedure will read the memory programming parameters from a CSV file. Up to 5 memory writes can be set. If the <i>Verify</i> option is selected, PLT will read the memory contents and compare them to the ones written before.
	Manual		1	The manual procedure will write data with a given size at a given address offset. If the <i>Verify</i> option is selected, PLT will read the memory contents and compare them to the ones written before.

Note 12 Applies for all available memories simultaneously.

Appendix BB CSV Log File Contents

Table 126 describes the CSV File columns generated during PLT testing. In general, not all CSV file columns shown in Table 126 will be printed, but only those that relate to the enabled tests and memory operations user has selected. An example is given in [CSV Log File Example](#).

Table 126: CSV File Contents

Header	Value	Description
Start time	hh:mm:ss	Shows the actual time the test procedure has started
End time	hh:mm:ss	Shows the actual time the test procedure has ended
Tester ID	ID	The tester ID name.
DUT	1-16	The PLT connector for this device. Values 1-16.
BD address	XX:XX:XX:XX:XX:XX	The BD address assigned for this device.
Overall status	PASS\FAIL	The overall status of the test procedure for this device.
COM Port	XX	Windows assigned COM Port
Temperature test	PASS\FAIL	Shows the temperature measured during temperature test.
Temperature	xx.xx	The first column shows the result of the test. The second column shows the temperature measured.
FW download 1	PASS\FAIL	Production test FW download.
FW path 1	C:\folder\to\bin	The first column shows the result of the production test firmware download procedure. The second column shows the path to the firmware.
RAM FW download	PASS\FAIL	Production test FW download through memory programming FW.
RAM FW path	C:\path\to\bin	The first column shows the result of the production test firmware download procedure. The second column shows the path to the firmware.
FW version get 1	PASS\FAIL	Production test FW version.
FW version 1	e.g. "v_5.0.4_PLT_v4.3"	The first column shows the result of the test. The second column shows the production test FW version read back from each device.
GPIO Watchdog ['Test Name']	PASS\FAIL	GPIO watchdog toggling test for production testing FW
GPIO Watchdog mem ['Test Name']	PASS\FAIL	GPIO watchdog toggling test for memory programming FW
ADC VBAT	PASS\FAIL	Whether VBAT was successfully measured.
VBAT level	VBAT level	The level of the VBAT as measured by the internal DUT ADC
DC-DC level test	PASS\FAIL	Whether the DA14531 DC-DC level is inside the user defined limits
DC-DC level	DC-DC level	The DC-DC level as measured from the internal DUT ADC.

SmartBond Production Line Tool

Header	Value	Description
OTP timestamp	PASS\FAIL	Whether the OTP timestamp read succeeded.
OTP timestamp value	Timestamp	The actual timestamp of the DUT IC.
Scan HCI Adv [CH37-9\All]	PASS\FAIL	Scan test using Advertising through HCI.
Scan HCI Adv RSSI [CH37-9\All]	The RSSI value measured for this device.	The first column shows the result of the test. The second column shows the calculated value in decimal.
Extended\Deep sleep current test	PASS\FAIL	Current measurement test – sleep tests.
Extended\Deep sleep current	RES=[xxxxA]. LL=xxxxA. HL=[xxxxA].	The first column shows the result of the test. The second column shows the calculated value, and the high and low limits used for this test.
Sleep clock select	PASS\FAIL	Sleep clock selection
XTAL trim test	PASS\FAIL	Automated XTAL Trim value calculation.
XTAL trim	e.g. "1155"	The first column shows the result of the test. The second column shows the calculated value in decimal.
ADC calibration	PASS\FAIL	ADC calibration test.
ADC calibration value	xx	The first column shows the result of the test. The second column shows the calculated value.
BLE TX power test 'X' [Test Name]	PASS\FAIL	Tx Power tests using external BLE Tester
BLE TX power 'X' [Test Name]	TRUE;-13.16;-13.16;-13.16;0.08;0;2;PASS	
BLE TX offset test 'X' [Test Name]	PASS\FAIL	Tx Frequency offset tests using external BLE Tester
BLE TX offset 'X' [Test Name]	TRUE;-1.100e+003;1.400e+003;-4.000e+003;2902;-3.0e+003;-3.0e+003;0;2;PASS;2503	
BLE TX modulation test 'X' [Test Name]	PASS\FAIL	Tx Modulation Index tests using external BLE Tester.
BLE TX modulation 'X' [Test Name]	TRUE;260600.00;253300.00;216800.00;24800.00;0.98;0;576;1;1;FAIL;100.00%	The first column shows the result of the test. The second column shows the calculated value.
BLE RX RSSI test 'X' [Test Name]	PASS\FAIL	Rx sensitivity tests using external BLE Tester.
BLE RX RSSI [Test Name]	The RSSI value measured for this device.	The first column shows the result of the test. The second column shows the RSSI value measured for this device.
BLE RX PER [Test Name]	The Packet Error Rate measured for this device.	The third column shows the Packet Error Rate measured for this device.
GU RX RSSI test 'X' [Test Name]	PASS\FAIL	Rx sensitivity tests using Golden Unit as Tester.
GU RX RSSI [Test Name]	The RSSI value measured for this device.	The first column shows the result of the test. The second column shows the RSSI value measured for this device.
GU RX PER [Test Name]	The Packet Error Rate measured for this device.	The third column shows the Packet Error Rate measured for this device.

SmartBond Production Line Tool

Header	Value	Description
GPIO/LED test 'X' ['Test Name']	PASS\FAIL	GPIO/LED tests
GPIO connection test 'X' ['Test Name']	PASS\FAIL	GPIO connection tests
Audio test	PASS\FAIL	Audio test.
Audio level	xx.xx	The first column shows the result of the test. The second column shows the power level measured of each device.
Sensor test 'X' ['Test Name']	PASS\FAIL	Sensor tests.
Custom test 'X' ['Test Name']	PASS\FAIL	Custom tests
32KHz Test	PASS\FAIL	External 32kHz crystal test
Range extender	PASS\FAIL	Range extender test
Peripheral test 'X' ['Test Name']	PASS\FAIL	Current measurement tests for peripherals.
Peripheral test current	RES=[xxxxA]. LL=xxxxA]. HL=[xxxxA].	The first column shows the result of the test. The second column shows the calculated value, and the high and low limits used for this test.
FW download 2	PASS\FAIL	Memory programming FW download.
FW path 2	C:\path\to\bin	The first column shows the result of the production test firmware download procedure. The second columns shows the path to the firmware.
FW version get 2	PASS\FAIL	Memory programming FW version.
FW version 2	e.g. "v_5.0.4_PLT_v4.3"	The first column shows the result of the test. The second column shows the memory programming FW version read back from each device.
QSPI init	PASS\FAIL	Initialize QSPI Flash memory.
QSPI jedec	xxxxxx	The first column shows the result of the test. The second columns shows the Jedec ID read back from the device.
QSPI erase 'X' ['Test Name']	PASS\FAIL	Erase the QSPI Flash memory test.
QSPI check empty 'X' ['Test Name']	PASS\FAIL	Verify that the QSPI Flash memory has been erased.
QSPI burn 'X' ['Test Name']	PASS\FAIL	QSPI image write test.
QSPI image	C:\path\to\bin	The first column shows the result of the test. The second columns shows the path to the firmware burnt.
QSPI BDA burn	PASS\FAIL	Write BD address value to QSPI Header.
QSPI BDA rd/cmp	PASS\FAIL	Read BD address written in QSPI Header and compare it with the one the device is currently using.
QSPI BDA read	XX:XX:XX:XX:XX:XX	The first column shows the result of the test. The second columns shows the BD address written in the QSPI header.
QSPI XTAL trim burn	PASS\FAIL	Write XTAL Trim value to QSPI Header.
QSPI write ADC calibration	PASS\FAIL	Write ADC calibration value to QSPI memory.
Custom memory burn	PASS\FAIL	Write on any available memory test.
Custom memory data	"Data from CSV file" or	The first column shows the result of the test.

SmartBond Production Line Tool

Header	Value	Description
	"xx..."	The second columns shows whether the data are given from a CSV file or the contents written.
'SPI\OTP\EEPROM\QSPI' Memory read 'X' ['Test Name']	PASS\FAIL	Read any part of any available memory. The first column shows the result of the test.
Memory read data	xx...	The second columns shows the contents read back.
SPI init	PASS\FAIL	Initialize SPI Flash memory.
SPI erase 'X' ['Test Name']	PASS\FAIL	Erase the SPI Flash memory test.
SPI empty 'X' ['Test Name']	PASS\FAIL	Verify that the SPI Flash memory has been erased.
SPI burn 'X' ['Test Name']	PASS\FAIL	SPI image write tests.
SPI image	C:\path\to\bin	The first column shows the result of the test. The second columns shows the path to the firmware burnt.
EEPROM init	PASS\FAIL	Initialize EEPROM memory.
EEPROM burn 'X' ['Test Name']	PASS\FAIL	EEPROM image write tests.
EEPROM image	C:\path\to\bin	The first column shows the result of the test. The second columns shows the path to the firmware burnt.
OTP burn	PASS\FAIL	OTP image write test.
OTP image	C:\path\to\bin	The first column shows the result of the test. The second columns shows the path to the firmware burnt.
OTP BDA burn	PASS\FAIL	Write BD address value to OTP Header.
OTP BDA rd/cmp	PASS\FAIL	Read BD address written in OTP Header and compare it with the one the device is currently using.
OTP BDA read	XX:XX:XX:XX:XX:XX	The first column shows the result of the test. The second columns shows the BD address written in the OTP header.
OTP XTAL trim burn	PASS\FAIL	Write XTAL Trim value to OTP Header.
OTP header burn	PASS\FAIL	OTP Header area burn.
OTP write ADC calibration	PASS\FAIL	Write ADC calibration value to OTP.
Scan	PASS\FAIL	Scan test with the DUTs booting and advertising.

SmartBond Production Line Tool**CSV Log File Example**

This example uses three DA14583 devices. The following tests and memory operations are enabled:

- XTAL Trim
- GPIO Watchdog Operation
- Scan DUT Advertise Test
- Golden Unit - RF Test 1
- Golden Unit - RF Test 2
- BLE Tester - Tx Power 1
- BLE Tester - Frequency Offset 1
- BLE Tester - Modulation Index 1
- BLE Tester - Rx Sensitivity 1
- GPIO\LED Test 1
- Custom Test 1
- External 32kHz Test
- Current Measurement Test - Peripheral Test 1
- Current Measurement Test - Extended Sleep Test
- SPI Erase 1
- SPI Check Empty 1
- SPI Write 1
- Custom Memory Data - Manual
- OTP BD Address Read
- Memory Read Test 1
- Scan Test

The first device successfully completed all tests, the second failed to be found by the Golden Unit during the scan test and the third failed the external 32 kHz test.

The CSV results of the tests are split into four main categories explained in detailed in the following chapters.

UM-B-041

SmartBond Production Line Tool

CSV Log File Entries 1/4

The first part of the CSV file contains general device and test information, as shown in [Figure 174](#) and explained in [Table 127](#).

Start time	End time	DUT	BD address	Overall status	COM port
15:05:55	15:06:54	1	80:80:80:00:00:0A	PASS	44
15:05:55	15:06:54	2	80:80:80:00:00:0B	FAIL	45
15:05:55	15:06:54	3	80:80:80:00:00:0C	FAIL	46

Figure 174: CSV File Entries (1/4)

Table 127: CSV File Entries (1/4).

Header	Value	Description
Start time	15:05:55	The time the tests started.
End time	15:06:54	The time the tests finished.
DUT	1 2 3	The PLT position each device is connected.
BD address	80:80:80:00:00:0A 80:80:80:00:00:0B 80:80:80:00:00:0C	The BD address assigned to each device.
Overall status	PASS FAIL FAIL	The overall final result for each device.
COM port	44 45 46	The Windows assigned COM port to each device.

UM-B-041

SmartBond Production Line Tool

CSV Log File Entries 2/4

The second part of the CSV Log file contains the production tests entries, as shown in [Figure 175](#) and explained in [Table 128](#).

FW download 1	FW path 1	FW version get 1	FW version 1	GPIO Watchdog [WD-P1_0]	XTAL trim test	XTAL trim	Scan HCI Adv [CH37]	Scan HCI Adv RSSI [CH37]
PASS	C:\DA1458x_DA1468x_PLT_v_4.x\executables\binaries\prod_test_580.bin	PASS	v_5.0.4_PLT_v4.3	PASS	PASS	1266	PASS	-11.39
PASS	C:\DA1458x_DA1468x_PLT_v_4.x\executables\binaries\prod_test_580.bin	PASS	v_5.0.4_PLT_v4.3	PASS	PASS	1237	PASS	-14.71
PASS	C:\DA1458x_DA1468x_PLT_v_4.x\executables\binaries\prod_test_580.bin	PASS	v_5.0.4_PLT_v4.3	PASS	PASS	1155	PASS	-16.61

BLE TX power test 1 [Tx Pwr 1]	BLE TX power 1 [Tx Pwr 1]	BLE TX offset test 1 [Freq Offs 1]	BLE TX offset 1 [Freq Offs 1]
PASS	TRUE;-17.91;-17.91;-17.91;0.10;0;2;PASS	PASS	TRUE;-2.500e+003;2.800e+003;-7.800e+003;-7646;-9.0e+003;-9.0e+003;0;2;PASS;-7646
PASS	TRUE;-9.63;-9.63;-9.63;0.09;0;2;PASS	PASS	TRUE;-1.500e+003;3.200e+003;-6.800e+003;5945;-6.0e+003;-6.0e+003;0;2;PASS;-1054
PASS	TRUE;-12.27;-12.27;-12.27;0.09;0;2;PASS	PASS	TRUE;4.000e+002;5.900e+003;-3.700e+003;-6009;-8.0e+003;-8.0e+003;0;2;PASS;1756

BLE TX modulation test 1 [Mod Idx 1]	BLE TX modulation 1 [Mod Idx 1]	BLE RX RSSI test 1 [Rx sens 1]	BLE RX RSSI 1 [Rx sens 1]	BLE RX PER 1 [Rx sens 1]
PASS	TRUE;282100.00;249100.00;200700.00;248700.00;1.00;0;576;1;1;FAIL;100.00%	PASS	-18.03	4
PASS	TRUE;276800.00;248800.00;190600.00;238200.00;0.96;0;576;1;1;FAIL;100.00%	PASS	-11.87	5.6
PASS	TRUE;261800.00;246400.00;199400.00;238700.00;0.97;0;576;1;1;FAIL;100.00%	PASS	-13.29	0.4

GU RX RSSI test 1 [GU_RSSI_1]	GU RX RSSI 1 [GU_RSSI_1]	GU RX PER 1 [GU_RSSI_1]	GU RX RSSI test 2 [GU_RSSI_2]	GU RX RSSI 2 [GU_RSSI_2]	GU RX PER 2 [GU_RSSI_2]	GPIO/LED test 1 [GPIO_P1_0]
PASS	-11.87	3.2	PASS	-11.87	7.6	PASS
PASS	-15.18	0	PASS	-15.66	1.2	PASS
PASS	-15.66	0.4	PASS	-15.66	0.8	PASS

Custom test 1	32KHz Test	Peripheral test 1	Peripheral test current 1	Extended sleep current test	Extended sleep current
PASS	PASS	PASS	RES=[0.007038353A]. LL=[0.0000020000A]. HL=[0.2000000000A].	PASS	RES=[0.001338430A]. LL=[0.0000340000A]. HL=[0.0400000000A].
PASS	PASS	PASS	RES=[0.007038353A]. LL=[0.0000020000A]. HL=[0.2000000000A].	PASS	RES=[0.001338430A]. LL=[0.0000340000A]. HL=[0.0400000000A].
PASS	FAIL				

Figure 175: CSV File Entries (2/4)

Table 128: CSV File Entries (2/4).

Header	Value	Description
FW download 1	PASS	Production test firmware downloaded successfully to all devices. Selected firmware is C:\DA1458x_DA1468x_PLT_v_4.x\executables\binaries\prod_test_580.bin.
FW path 1	C:\SmartBond_PLT_v_4.x\executables\binaries\prod_test_580.bin	
FW version get 1	PASS	All devices responded to firmware version request. All of them have version

SmartBond Production Line Tool

Header	Value	Description
FW version 1	v_5.0.4_PLT_v4.3	v_5.0.4_PLT_v4.3.
GPIO watchdog [WD-P1_0]	PASS	GPIO toggling for watchdog has started. In addition, header has the name assigned to the test.
XTAL Trim test	PASS	XTAL Trim test finished successfully. The calculated value (in decimal) is shown for each device.
XTAL Trim	1266 1237 1155	
Scan HCI Adv [CH37]	PASS	
Scan HCI Adv RSSI [CH37]	-11.39 -14.71 -16.61	Scan test using advertising through HCI commands test finished successfully. Channel 37 is selected, which is also shown on the header. RSSI values, for each device are also shown.
BLE TX power test 1 [Tx Pwr 1]	PASS	Transmission power test using external BLE Tester finished successfully. In addition, header has the name assigned to the test and the BLE tester values are shown exactly as they were retrieved.
BLE TX power 1 [Tx Pwr 1]	TRUE;-14.25;-14.25;-14.25;0.10;0;2;PASS TRUE;-19.89;-19.89;-19.89;0.13;0;2;PASS TRUE;-9.76;-9.76;-9.76;0.08;0;2;PASS	
BLE TX offset test 1 [Freq Offs 1]	PASS	
BLE TX offset 1 [Freq Offs 1]	TRUE;-2.500e+003;2.800e+003;-7.800e+003;-7646;-9.0e+003;-9.0e+003;0;2;PASS;-7646 TRUE;-1.500e+003;3.200e+003;-6.800e+003;5945;-6.0e+003;-6.0e+003;0;2;PASS;-1054 TRUE;4.000e+002;5.900e+003;-3.700e+003;-6009;-8.0e+003;-8.0e+003;0;2;PASS;1756	Transmission offset test using external BLE Tester finished successfully. In addition, header has the name assigned to the test and the BLE tester values are shown exactly as they were retrieved.
BLE TX modulation test 1 [Mod Idx 1]	PASS	Transmission modulation index test using external BLE Tester finished successfully. In addition, header has the name assigned to the test and the BLE tester values are shown exactly as they were retrieved.
BLE TX modulation 1 [Mod Idx 1]	TRUE;282100.00;249100.00;200700.00;248700.00;1.00;0;576;1;1;FAIL;100.00%	

SmartBond Production Line Tool

Header	Value	Description
	TRUE;276800.00;248800.00;190600.00;238200.00;0.96;0;576;1;1;FAIL;100.00% TRUE;261800.00;246400.00;199400.00;238700.00;0.97;0;576;1;1;FAIL;100.00%	
BLE RX RSSI test 1 [Rx sens 1]	PASS	Reception test using external BLE Tester finished successfully. In addition, header has the name assigned to the test and the RSSI and packet error rate for each device are shown.
BLE RX RSSI 1 [Rx sens 1]	-18.03 -11.87 -13.29	
BLE RX PER 1 [Rx sens 1]	4 5.6 0.4	
GU RX RSSI test 1 [GU_RSSI_1]	PASS	Reception test 1 using the Golden Unit finished successfully. In addition, header has the name assigned to the test and the RSSI and packet error rate for each device are shown.
GU RX RSSI 1 [GU_RSSI_1]	-11.87 -15.18 -15.66	
GU RX PER 1 [GU_RSSI_1]	3.2 0 0.4	
GU RX RSSI test 2 [GU_RSSI_2]	PASS	Reception test 2 using the Golden Unit finished successfully. In addition, header has the name assigned to the test and the RSSI and packet error rate for each device are shown.
GU RX RSSI 2 [GU_RSSI_2]	-11.87 -15.66 -15.66	
GU RX PER 2 [GU_RSSI_2]	7.6 1.2 0.8	
GPIO/LED test 1 [GPIO_P1_0]	PASS	GPIOLED toggling test finished successfully.

SmartBond Production Line Tool

Header	Value	Description
Custom test 1	PASS	Custom test finished successfully.
External 32kHz test	Devices 1-2: PASS Device 3: FAIL	External 32kHz test finished successfully for devices 1 and 2. In this test, device #3 failed . Since device 3 failed on this test, it will not continue with the remaining tests, meaning that the entries for device 3 will be blank.
Peripheral test 1	PASS	Current measurement for peripherals test finished successfully. Only one test was active. The limits used and the value measured are shown. These values are for all active devices, in this case for two devices, devices 1 and 2.
Peripheral test current 1	RES=[0.007038353A]. LL=[0.0000020000A]. HL=[0.2000000000A]. RES=[0.007038353A]. LL=[0.0000020000A]. HL=[0.2000000000A].	
Extended sleep current test	PASS	Current measurement during extended sleep test finished successfully. The limits used and the value measured are shown. These values are for all active devices, in this case for two devices, devices 1 and 2.
Extended sleep current	RES=[0.001338430A]. LL=[0.0000340000A]. HL=[0.0400000000A]. RES=[0.001338430A]. LL=[0.0000340000A]. HL=[0.0400000000A].	

UM-B-041

SmartBond Production Line Tool

CSV Log File Entries 3/4

The third part of the CSV Log file contains the memory programming entries, as shown in [Figure 176](#) and explained in [Table 129](#).

FW download 2	FW path 2	FW version get 2	FW version 2	GPIO Watchdog mem [WD-P1_0]	SPI init	SPI erase 1 [SPI ER 1]	SPI empty 1 [SPI ER 1]
PASS	C:\DA1458x_DA1468x_PLT_v_4.x\executables\binaries\flash_programmer_580.bin	PASS	v_5.0.4_PLT_v4.3	PASS	PASS	PASS	PASS
PASS	C:\DA1458x_DA1468x_PLT_v_4.x\executables\binaries\flash_programmer_580.bin	PASS	v_5.0.4_PLT_v4.3	PASS	PASS	PASS	PASS
SPI burn 1 [SPI WR 1]	SPI image 1 [SPI WR 1]	Custom memory burn	Custom memory data	OTP BDA rd/cmp	OTP BDA read	SPI Memory read 1 [SPI @8000]	SPI Memory read data 1 [SPI @8000]
PASS	binaries\prox_reporter_580.bin	PASS	1122334455	PASS	80:80:80:00:00:0A	PASS	1122334455
PASS	binaries\prox_reporter_580.bin	PASS	1122334455	FAIL	00:00:00:00:00:00		

Figure 176: CSV File Entries (3/4)

Table 129: CSV File Entries (3/4).

Header	Value	Description
FW download 2	PASS	Production test firmware downloaded successfully to all devices. Selected firmware is C:\DA1458x_DA1468x_PLT_v_4.x\executables\binaries\prod_test_580.bin.
FW path 2	C:\DA1458x_DA1468x_PLT_v_4.x\executables\binaries\prod_test_580.bin	
FW version get 2	PASS	All devices responded to firmware version request. All of them have version v_5.0.4_PLT_v4.3.
FW version 2	v_5.0.4_PLT_v4.3	
GPIO watchdog [WD-P1_0]	PASS	GPIO toggling for watchdog has started. In addition, header has the name assigned to the test.
SPI init	PASS	SPI flash initialization procedure completed successfully.
SPI erase 1 [SPI ER 1]	PASS	SPI flash erase procedure completed successfully. Only one test is active. In addition, header has the name assigned to the test.
SPI empty 1 [SPI ER 1]	PASS	SPI flash check for empty contents procedure completed successfully. Only one test is active. In addition, header has the name assigned to the test.
SPI burn 1 [SPI WR 1]	PASS	Production test firmware downloaded successfully to all devices. Selected firmware is C:\DA1458x_DA1468x_PLT_v_4.x\executables\binaries\prod_test_580.bin.
SPI image 1 [SPI WR 1]	binaries\prox_reporter_580.bin binaries\prox_reporter_580.bin	

SmartBond Production Line Tool

Header	Value	Description
Custom memory burn	PASS	Custom memory data write procedure completed successfully. Data written were 1122334455.
Custom memory data	1122334455 1122334455	
OTP BDA rd/cmp	Device 1: PASS Device 2: FAIL	OTP read and compared test completed successfully for both devices, but the contents of device 2 did not match the assigned BD address, resulting to failure for device 2. Assigned BD address for device 2 was 80:80:80:00:00:0B and the contents of the OTP header were 00:00:00:00:00:00. Device1 BD address assigned and OTP header contents were both 80:80:80:00:00:0A. Since device 2 failed on this test, it will not continue with the remaining tests, meaning that the entries for device 2 will be blank.
OTP BDA read	80:80:80:00:00:0A 00:00:00:00:00:00	
SPI Memory read 1 [SPI @8000]	PASS	Read data from SPI Flash memory completed successfully. Only one test was active. Data read back were 1122334455. The memory and address are the as those in Custom memory write, resulting to same contents. In addition, header has the name assigned to the test.
SPI Memory read data 1 [SPI @8000]	1122334455	

UM-B-041

SmartBond Production Line Tool

CSV Log File Entries 4/4

The last part of the CSV Log file contains the scan test entry, as shown in [Figure 177](#) and explained in [Table 130](#).

Scan
PASS

Figure 177: CSV File Entries (4/4)

Table 130: CSV File Entries (4/4).

Header	Value	Description
Scan	PASS	Scan test for device 1 has finished successfully.

SmartBond Production Line Tool

Appendix CC DUT Status Codes

Table 131 contains all the possible status codes a DUT can have, followed by a brief description. The table categorizes the status based on the various states of the DUT during testing and programming.

Table 131: DUT Status Codes

Status	Description
Generic	
DUT_NOT_ACTIVE	Device is not active.
DUT_INTERNAL_SYSTEM_ERROR	Internal system error.
DUT_COM_PORT_IDENTIFY_STARTED	COM port identification started.
DUT_COM_PORT_IDENTIFY_OK	COM port identified successfully.
DUT_COM_PORT_IDENTIFY_FAILED	COM port identification failed.
DUT_GU_ERROR	Error occurred due to a Golden Unit failure. Check the Golden unit status for more information.
COM port enumeration	
DUT_PDLL_UART_LOOP_INIT	UART loop test initialized.
DUT_PDLL_UART_LOOP_START	UART loop test start.
DUT_PDLL_UART_LOOP_OK	UART loop test ended successfully.
DUT_PDLL_UART_LOOP_FAILED	UART loop test failed.
Temperature measurement	
DUT_TEMPERATURE_MEASUREMENT_INIT	Temperature measurement initialized.
DUT_TEMPERATURE_MEASUREMENT_OK	Temperature measurement finished successfully.
DUT_TEMPERATURE_MEASUREMENT_ERROR	Temperature measurement error.
Production test - Generic errors	
DUT_PDLL_NO_ERROR	PDLL returned success.
DUT_PDLL_PARAMS_ERROR	PDLL Device parameters contain errors.
DUT_PDLL_RX_TIMEOUT	Device did not reply on a PDLL message request.
DUT_PDLL_TX_TIMEOUT	Sending a message to the device failed due to Tx timeout.
DUT_PDLL_UNEXPECTED_EVENT	Received an unexpected message from the device.
DUT_PDLL_CANNOT_ALLOCATE_MEMORY	PDLL cannot allocate memory.
DUT_PDLL_INTERNAL_ERROR	PDLL internal system error.
DUT_PDLL_THREAD_CREATION_ERROR	PDLL thread creation error.
DUT_PDLL_INVALID_DBG_PARAMS	PDLL debug library (dbg_dll.dll) access error.
DUT_PDLL_DBG_DLL_ERROR	PDLL invalid debug library (dbg_dll.dll) parameters.
DUT_PDLL_HCI_STANDARD_ERROR	HCI error.
Production test - COM port	
DUT_PDLL_COM_PORT_INIT	PDLL Device COM port open initialized.
DUT_PDLL_COM_PORT_START	PDLL Device COM port open started.
DUT_PDLL_COM_PORT_OK	PDLL Device COM port opened successfully.
DUT_PDLL_COM_PORT_FAILED	PDLL Device COM port failed.

SmartBond Production Line Tool

Status	Description
Production test - UART resync	
DUT_PDLL_UART_RESYNC_INIT	UART resync process initialized.
DUT_PDLL_UART_RESYNC_START	UART resync process started.
DUT_PDLL_UART_RESYNC_OK	UART resync process completed successfully.
DUT_PDLL_UART_RESYNC_FAILED	UART resync process failed.
Production test - Firmware version	
DUT_PDLL_FW_VERSION_GET_START	PDLL Device Firmware version acquisition started.
DUT_PDLL_FW_VERSION_GET_OK	PDLL Device Firmware version acquisition completed successfully.
DUT_PDLL_FW_VERSION_GET_FAILED	PDLL Device Firmware version acquisition failed.
Production test – GPIO watchdog	
DUT_PDLL_GPIO_WD_INIT	GPIO watchdog operation initialized.
DUT_PDLL_GPIO_WD_START	GPIO watchdog operation started.
DUT_PDLL_GPIO_WD_OK	GPIO watchdog operation ended successfully.
DUT_PDLL_GPIO_WD_FAILED	GPIO watchdog operation failed.
Production test – OTP timestamp read	
DUT_PDLL_OTP_TIMESTAMP_RD_INIT	Initialize timestamp read from the OTP.
DUT_PDLL_OTP_TIMESTAMP_RD_START	OTP timestamp read operation started.
DUT_PDLL_OTP_TIMESTAMP_RD_OK	OTP timestamp read operation ended successfully.
DUT_PDLL_OTP_TIMESTAMP_RD_FAILED	OTP timestamp read operation failed.
Production test – VBAT level read	
DUT_PDLL_ADC_VBAT_INIT	Initialize VBAT level read using internal ADC.
DUT_PDLL_ADC_VBAT_START	VBAT level read operation started.
DUT_PDLL_ADC_VBAT_OK	VBAT level read operation ended successfully.
DUT_PDLL_ADC_VBAT_FAILED	VBAT level read operation failed.
Production test – DC-DC level test	
DUT_PDLL_DC_LEVEL_INIT	Initialize DC-DC level test, by reading voltage using internal ADC.
DUT_PDLL_DC_LEVEL_START	DC-DC level test operation started.
DUT_PDLL_DC_LEVEL_OK	DC-DC level test operation ended successfully.
DUT_PDLL_DC_LEVEL_FAILED	DC-DC level test operation failed. Cannot read voltage
DUT_PDLL_DC_LEVEL_LIMITS_PASSED	DC-DC level is outside user defined limits. Test failed.
DUT_PDLL_DC_LEVEL_LIMITS_FAILED	DC-DC level is inside user defined limits. Test passed.
Production test – TX power level set	
DUT_PDLL_SET_TX_PWR_INIT	Initialize TX power set operation.
DUT_PDLL_SET_TX_PWR_START	TX power set operation started.
DUT_PDLL_SET_TX_PWR_OK	TX power set operation ended successfully.
DUT_PDLL_SET_TX_PWR_FAILED	TX power set operation failed.
Production test – Reset mode selection (DA14531)	
DUT_PDLL_RESET_MODE_INIT	Reset mode set operation initialized.

SmartBond Production Line Tool

Status	Description
DUT_PDLL_RESET_MODE_START	Reset mode set operation started.
DUT_PDLL_RESET_MODE_OK	Reset mode set operation ended successfully.
DUT_PDLL_RESET_MODE_FAILED	Reset mode set operation failed.
Production test - Current measurement test	
DUT_SLEEP_CURRENT_MEASURE_INIT	Sleep current measurement test initialized.
DUT_SLEEP_CURRENT_MEASURE_START	Sleep current measurement test start.
DUT_SLEEP_DEVICE_SLEPT_OK	Sleep current measurement device mode set successfully.
DUT_SLEEP_CURRENT_MEASURE_ERROR	Sleep current measurement test error.
DUT_SLEEP_CURRENT_MEASURE_PASSED	Sleep current measurement test passed.
DUT_SLEEP_CURRENT_MEASURE_FAILED	Sleep current measurement test failed.
DUT_PDLL_PERIPH_AMMETER_TEST_INIT	Peripheral current measurement test initialized.
DUT_PDLL_PERIPH_AMMETER_TEST_START	Peripheral current measurement test start.
DUT_PDLL_PERIPH_AMMETER_TEST_ERROR	Peripheral current measurement test error.
DUT_PDLL_PERIPH_AMMETER_TEST_PASSED	Peripheral current measurement test passed.
DUT_PDLL_PERIPH_AMMETER_TEST_FAILED	Peripheral current measurement test failed.
Production test – Sleep Clock Source	
DUT_PDLL_SLEEP_CLK_SRC_INIT	Sleep Clock source test operation initialized.
DUT_PDLL_SLEEP_CLK_SRC_START	Sleep Clock source test operation started.
DUT_PDLL_SLEEP_CLK_SRC_OK	Sleep Clock source test operation ended successfully.
DUT_PDLL_SLEEP_CLK_SRC_FAILED	Sleep Clock source test operation failed.
Production test – External 32 kHz	
DUT_PDLL_EXT32KHz_TEST_INIT	External 32kHz test operation initialized.
DUT_PDLL_EXT32KHz_TEST_START	External 32kHz test operation started.
DUT_PDLL_EXT32KHz_TEST_OK	External 32kHz test operation ended successfully.
DUT_PDLL_EXT32KHz_TEST_FAILED	External 32kHz test operation failed.
Production test - XTAL trim	
DUT_PDLL_XTAL_TRIM_INIT	XTAL trim operation initialized.
DUT_PDLL_XTAL_TRIM_START	XTAL trim operation started.
DUT_PDLL_XTAL_TRIM_OK	XTAL trim operation ended successfully.
DUT_PDLL_XTAL_TRIM_OUT_OF_RANGE	XTAL trim failed. Input frequency is out of range.
DUT_PDLL_XTAL_TRIM_FREQ_CAL_NOT_CONNECTED	XTAL trim could not be performed. Could not detect external input frequency.
DUT_PDLL_XTAL_TRIM_OTP_WRITE_FAILED	XTAL trim failed. Could not write the calculated value to the OTP header.
DUT_PDLL_XTAL_TRIM_FAILED	XTAL trim failed.
Read value written in OTP	
DUT_PDLL_OTP_XTAL_TRIM_READ_INIT	OTP XTAL trim read operation initialized.
DUT_PDLL_OTP_XTAL_TRIM_READ_START	OTP XTAL trim read operation started.
DUT_PDLL_OTP_XTAL_TRIM_READ_OK	OTP XTAL trim read operation ended successfully.
DUT_PDLL_OTP_XTAL_TRIM_READ_FAILED	OTP XTAL trim read operation failed.

SmartBond Production Line Tool

Status	Description
Read register value	
DUT_PDLL_XTAL_TRIM_READ_INIT	XTAL trim value read initialized.
DUT_PDLL_XTAL_TRIM_READ_START	XTAL trim value read started.
DUT_PDLL_XTAL_TRIM_READ_OK	XTAL trim value read success.
DUT_PDLL_XTAL_TRIM_READ_FAILED	XTAL trim value read failed.
Production test - Golden Unit RSSI	
DUT_PDLL_GU_RF_RX_TEST_PASSED	Golden Unit RF RX packet test passed.
DUT_PDLL_GU_RF_RX_TEST_FAILED	Golden Unit RF RX packet test failed.
DUT start packet RX	
DUT_PDLL_PKT_RX_STATS_START_INIT	RF RX packet test with statistics start initialized.
DUT_PDLL_PKT_RX_STATS_START	RF RX packet test with statistics start.
DUT_PDLL_PKT_RX_STATS_STARTED_OK	RF RX packet test with statistics started successfully.
DUT_PDLL_PKT_RX_STATS_START_FAILED	RF RX packet test with statistics started failed.
DUT stop packet RX	
DUT_PDLL_PKT_RX_STATS_STOP_INIT	RF RX packet test with statistics stop initialized.
DUT_PDLL_PKT_RX_STATS_STOP_START	RF RX packet test with statistics stop.
DUT_PDLL_PKT_RX_STATS_STOPPED_OK	RF RX packet test with statistics stopped successfully.
DUT_PDLL_PKT_RX_STATS_STOP_FAILED	RF RX packet test with statistics stop failed.
TX power measurement	
DUT_BLE_TESTER_TX_PWR_PASSED	BLE tester TX power test passed.
DUT_BLE_TESTER_TX_PWR_FAILED	BLE tester TX power test failed.
TX carrier offset measure	
DUT_BLE_TESTER_TX_OFFS_PASSED	BLE tester TX frequency offset test passed.
DUT_BLE_TESTER_TX_OFFS_FAILED	BLE tester TX frequency offset test failed.
TX modulation index measure	
DUT_BLE_TESTER_TX_MOD_IDX_PASSED	BLE tester TX modulation index test passed.
DUT_BLE_TESTER_TX_MOD_IDX_FAILED	BLE tester TX modulation index test failed.
RX sensitivity test	
DUT_BLE_TESTER_RX_TEST_PASSED	BLE tester RX sensitivity test passed.
DUT_BLE_TESTER_RX_TEST_FAILED	BLE tester RX sensitivity test failed.
DUT packet transaction	
DUT_PDLL_PKT_TX_START_INIT	RF packet TX initialized.
DUT_PDLL_PKT_TX_START	RF packet TX start.
DUT_PDLL_PKT_TX_STARTED_OK	RF packet TX started successfully.
DUT_PDLL_PKT_TX_STARTED_FAILED	RF packet TX failed to start.
DUT_PDLL_PKT_TX_ENDED_START	RF packet TX ended successfully.
DUT_PDLL_PKT_TX_ENDED_OK	RF packet TX end initiated.
DUT_PDLL_PKT_TX_ENDED_FAILED	RF packet TX failed to end.

SmartBond Production Line Tool

Status	Description
Production test - Scan with HCI BLE advertisements test	
DUT_PDLL_BLE_HCI_ADV_START_INIT	BLE HCI advertise start initialized.
DUT_PDLL_BLE_HCI_ADV_START	BLE HCI advertise start started.
DUT_PDLL_BLE_HCI_ADV_START_OK	BLE HCI advertise start success.
DUT_PDLL_BLE_HCI_ADV_START_FAILED	BLE HCI advertise start failed.
DUT_PDLL_BLE_HCI_ADV_STOP_INIT	BLE HCI advertise stop initialized.
DUT_PDLL_BLE_HCI_ADV_STOP_START	BLE HCI advertise stop started.
DUT_PDLL_BLE_HCI_ADV_STOPPED_OK	BLE HCI advertise stop success.
DUT_PDLL_BLE_HCI_ADV_STOP_FAILED	BLE HCI advertise stop failed.
DUT_PDLL_BLE_HCI_ADV_SCAN_START	BLE HCI advertise scan started.
DUT_PDLL_BLE_HCI_ADV_NOT_YET_FOUND	BLE HCI advertise not yet found.
DUT_PDLL_BLE_HCI_ADV_FOUND	BLE HCI advertise found.
DUT_PDLL_BLE_HCI_ADV_RSSI_FAILED	BLE HCI advertise RSSI failed.
DUT_PDLL_BLE_HCI_ADV_FAILED	BLE HCI advertise failed.
Production test – Range extender test	
DUT_PDLL_RANGE_EXT_EN_INIT	Range extender test enable initialization.
DUT_PDLL_RANGE_EXT_EN_START	Range extender test enable start.
DUT_PDLL_RANGE_EXT_EN_ERROR	Range extender test enable error.
DUT_PDLL_RANGE_EXT_EN_OK	Range extender test enable ended successfully.
DUT_PDLL_RANGE_EXT_EN_FAILED	Range extender test enable failed.
Production test - GPIO/LED test	
DUT_PDLL_GPIO_TOGGLE_INIT	GPIO-LED test operation initialized.
DUT_PDLL_GPIO_TOGGLE_START	GPIO-LED test operation start.
DUT_PDLL_GPIO_TOGGLE_FINISHED_OK	GPIO-LED test operation completed successfully.
DUT_PDLL_GPIO_TOGGLE_ERROR	GPIO-LED test operation error.
DUT_PDLL_GPIO_TOGGLE_FAILED	GPIO-LED test operation failed.
DUT_PDLL_GPIO_TOGGLE_PASSED	GPIO-LED test operation passed.
Production test – GPIO connection test	
DUT_PDLL_GPIO_CONNECTION_INIT	GPIO Connection test operation initialized.
DUT_PDLL_GPIO_SET_START	GPIO Connection test set operation start.
DUT_PDLL_GPIO_SET_ERROR	GPIO Connection test set operation error.
DUT_PDLL_GPIO_SET_FINISHED_OK	GPIO Connection test set operation success.
DUT_PDLL_GPIO_GET_START	GPIO Connection test get operation start.
DUT_PDLL_GPIO_GET_ERROR	GPIO Connection test get operation passed.
DUT_PDLL_GPIO_GET_FINISHED_OK	GPIO Connection test get operation success.
DUT_PDLL_GPIO_CONNECTION_ERROR	GPIO Connection test operation error.
DUT_PDLL_GPIO_CONNECTION_FAILED	GPIO Connection test operation failed.
DUT_PDLL_GPIO_CONNECTION_PASSED	GPIO Connection test operation completed successfully.

SmartBond Production Line Tool

Status	Description
Production test - Audio test	
DUT_PDLL_AUDIO_TEST_START_INIT	Audio test start action initialized.
DUT_PDLL_AUDIO_TEST_START	Audio test action start.
DUT_PDLL_AUDIO_TEST_ALREADY_ACTIVE	Audio test is already active.
DUT_PDLL_AUDIO_TEST_STARTED_OK	Audio test action started successfully.
DUT_PDLL_AUDIO_TEST_START_FAILED	Audio test start action failed.
DUT_PDLL_AUDIO_TEST_STOP_INIT	Audio test stop action initialized.
DUT_PDLL_AUDIO_TEST_STOP	Audio test stop action started.
DUT_PDLL_AUDIO_TEST_STOPPED_OK	Audio test stop action completed successfully.
DUT_PDLL_AUDIO_TEST_STOP_FAILED	Audio test stop action failed.
DUT_PDLL_AUDIO_TEST_PASSED	Audio test passed.
DUT_PDLL_AUDIO_TEST_FAILED	Audio test failed.
DUT_PDLL_AUDIO_TEST_INVALID_COMMAND	Audio test invalid command.
Production test - Sensor test	
DUT_PDLL_SENSOR_TEST_INIT	Sensor test action initialized.
DUT_PDLL_SENSOR_TEST_START	Sensor test action start.
DUT_PDLL_SENSOR_TEST_OK	Sensor test action ended successfully.
DUT_PDLL_SENSOR_TEST_FAILED	Sensor test action failed.
DUT_PDLL_SENSOR_TEST_DATA_MATCH_OK	Sensor test action data matched.
DUT_PDLL_SENSOR_TEST_DATA_MATCH_FAILED	Sensor test action data match failure.
Production test - Custom action test	
DUT_PDLL_CUSTOM_ACTION_INIT	Custom test action initialized.
DUT_PDLL_CUSTOM_ACTION_START	Custom test action start.
DUT_PDLL_CUSTOM_ACTION_OK	Custom test action ended successfully.
DUT_PDLL_CUSTOM_ACTION_FAILED	Custom test action failed.
DUT_PDLL_CUSTOM_ACTION_DATA_MATCH_OK	Custom test action data matched.
DUT_PDLL_CUSTOM_ACTION_DATA_MATCH_FAILED	Custom test action data match failure.
Production test - ADC calibration test	
DUT_PDLL_ADC_CALIB_INIT	ADC calibration process. Initializing process.
DUT_PDLL_ADC_CALIB_VBAT_RD_START	ADC calibration process. Start reading VBAT voltage using the external voltage meter instrument.
DUT_PDLL_ADC_CALIB_VBAT_RD_OK	ADC calibration process. VBAT voltage read ended successfully.
DUT_PDLL_ADC_CALIB_VBAT_RD_FAILED	ADC calibration process. VBAT voltage read failed.
DUT_PDLL_ADC_CALIB_DUT_RD_INIT	ADC calibration process. Initialize reading device ADC samples.
DUT_PDLL_ADC_CALIB_DUT_RD_START	ADC calibration process. Start reading device ADC samples.
DUT_PDLL_ADC_CALIB_DUT_RD_OK	ADC calibration process. Device ADC samples read success.
DUT_PDLL_ADC_CALIB_DUT_RD_FAILED	ADC calibration process. Device ADC samples read failed.
DUT_PDLL_ADC_CALIB_OK	ADC calibration process ended successfully.
DUT_PDLL_ADC_CALIB_FAILED	ADC calibration process failed.

SmartBond Production Line Tool

Status	Description
Production test - Scan test	
DUT_PDLL_BLE_SCAN_INIT	Scan operation initialized.
DUT_PDLL_BLE_SCAN_START	Scan operation start.
DUT_PDLL_BLE_SCAN_NOT_YET_FOUND	Scan operation. DUT has not been found yet.
DUT_PDLL_BLE_SCAN_FOUND	Scan operation completed successfully. DUT was found.
DUT_PDLL_BLE_SCAN_FAILED	Scan operation failed. DUT was not found.
DUT_PDLL_BLE_SCAN_RSSI_FAILED	Scan operation failed. RSSI level is outside user defined limits.
Memory programming - Generic errors	
DUT_UDLL_SUCCESS	UDLL returned success.
DUT_UDLL_ACTION_RESPONSE_ERROR	UDLL device responded with error.
DUT_UDLL_UART_RX_TIMEOUT_ERROR	UDLL UART RX timeout. Cannot communicate with the DUT or DUT is not present.
DUT_UDLL_NO_CRC_MATCH_ERROR	UDLL CRC match error.
DUT_UDLL_PROG_PARAMS_ERROR	UDLL programming parameter error.
DUT_UDLL_DEVICE_PARAMS_ERROR	UDLL device parameter error.
DUT_UDLL_UART_WRITE_ERROR	UDLL UART write returned error.
DUT_UDLL_UART_READ_ERROR	UDLL UART read returned error.
DUT_UDLL_INTERNAL_ERROR	UDLL internal error.
DUT_UDLL_COM_PORT_INIT_ERROR	UDLL COM port initialization error.
DUT_UDLL_COM_PORT_ERROR	UDLL COM port error.
DUT_UDLL_CANNOT_ALLOCATE_MEMORY	UDLL cannot allocate memory.
DUT_UDLL_READ_FILE_SIZE_ERROR	UDLL read file size error.
DUT_UDLL_CANNOT_OPEN_FW_FILE	UDLL cannot open firmware file.
DUT_UDLL_CANNOT_OPEN_IMAGE_FILE	UDLL cannot open image file.
DUT_UDLL_UART_PINS_PATCH_ERROR	UDLL cannot patch the UART pins into the firmware file.
DUT_UDLL_INVALID_DBG_PARAMS	UDLL invalid debug library (dbg_dll.dll) parameters.
DUT_UDLL_DBG_DLL_ERROR	UDLL debug library (dbg_dll.dll) access error.
Firmware download	
DUT_UDLL_FW_DOWNLOAD_INIT	UDLL firmware download initialized.
DUT_UDLL_FW_DOWNLOAD_STARTED	UDLL firmware download started successfully.
DUT_UDLL_FW_DOWNLOAD_RETRY	UDLL firmware download retry.
DUT_UDLL_FW_DOWNLOAD_OK	UDLL firmware downloaded successfully.
DUT_UDLL_FW_DOWNLOAD_FAILED	UDLL firmware download failed.
Memory programming - Firmware version	
DUT_UDLL_FW_VER_GET_INIT	UDLL device firmware version acquisition initialized
DUT_UDLL_FW_VER_GET_STARTED	UDLL device firmware version acquisition started.
DUT_UDLL_FW_VER_GET_OK	UDLL device firmware version acquisition completed successfully.
DUT_UDLL_FW_VER_GET_FAILED	UDLL device Firmware version acquisition failed.

SmartBond Production Line Tool

Status	Description
Memory programming – GPIO watchdog	
DUT_UDLL_GPIO_WD_INIT	UDLL GPIO watchdog operation initialized.
DUT_UDLL_GPIO_WD_STARTEDs	UDLL GPIO watchdog operation started.
DUT_UDLL_GPIO_WD_OK	UDLL GPIO watchdog operation ended successfully.
DUT_UDLL_GPIO_WD_FAILED	UDLL GPIO watchdog operation failed.
Memory programming – RAM firmware download	
DUT_UDLL_RAM_FW_DOWNLOAD_INIT	UDLL firmware download to RAM initialized
DUT_UDLL_RAM_FW_DOWNLOAD_STARTED	UDLL firmware download to RAM started.
DUT_UDLL_RAM_FW_DOWNLOAD_OK	UDLL firmware download to RAM completed successfully.
DUT_UDLL_RAM_FW_DOWNLOAD_FAILED	UDLL firmware download to RAM failed.
Memory programming - OTP image write	
DUT_UDLL_OTP_IMG_WR_INIT	OTP image write operation initialized.
DUT_UDLL_OTP_IMG_WR_STARTED	OTP image write operation started.
DUT_UDLL_OTP_IMG_WR_OK	OTP image write operation ended successfully.
DUT_UDLL_OTP_IMG_WR_FAILED	OTP image write operation failed.
Memory programming - BD address write to OTP memory	
DUT_UDLL_OTP_BDA_WR_INIT	OTP BD address write operation initialized.
DUT_UDLL_OTP_BDA_WR_STARTED	OTP BD address write operation started.
DUT_UDLL_OTP_BDA_WR_OK	OTP BD address write operation ended successfully.
DUT_UDLL_OTP_BDA_WR_FAILED	OTP BD address write operation failed.
Memory programming - BD address read/compare to OTP memory	
DUT_UDLL_OTP_BDA_RD_INIT	OTP BD address read operation initialized.
DUT_UDLL_OTP_BDA_RD_STARTED	OTP BD address read operation started.
DUT_UDLL_OTP_BDA_RD_OK	OTP BD address read operation ended successfully.
DUT_UDLL_OTP_BDA_RD_FAILED	OTP BD address read operation failed.
DUT_UDLL_OTP_BDA_CMP_OK	OTP BD address comparison success.
DUT_UDLL_OTP_BDA_CMP_FAILED	OTP BD address comparison failed. No match.
Memory programming - XTAL trim value write to OTP memory	
DUT_UDLL_OTP_XTAL_TRIM_WR_INIT	OTP XTAL trim value write operation initialized.
DUT_UDLL_OTP_XTAL_TRIM_WR_STARTED	OTP XTAL trim value write operation started.
DUT_UDLL_OTP_XTAL_TRIM_WR_OK	OTP XTAL trim value write operation ended successfully.
DUT_UDLL_OTP_XTAL_TRIM_WR_FAILED	OTP XTAL trim value write operation failed.
Memory programming - ADC calibration value write to OTP memory	
DUT_UDLL_OTP_ADC_CALIB_WR_INIT	OTP ADC calibration value write operation initialized.
DUT_UDLL_OTP_ADC_CALIB_WR_STARTED	OTP ADC calibration value write operation started.
DUT_UDLL_OTP_ADC_CALIB_WR_OK	OTP ADC calibration value write operation ended successfully.
DUT_UDLL_OTP_ADC_CALIB_WR_FAILED	OTP ADC calibration value write operation failed.
Memory programming - OTP header write	
DUT_UDLL_OTP_HDR_WR_INIT	OTP header write operation initialized.

SmartBond Production Line Tool

Status	Description
DUT_UDLL_OTP_HDR_WR_STARTED	OTP header write operation started.
DUT_UDLL_OTP_HDR_WR_OK	OTP header write operation ended successfully.
DUT_UDLL_OTP_HDR_WR_FAILED	OTP header write operation failed.
Memory programming - OTP customer field write	
DUT_UDLL_OTP_CUSTOMER_FIELD_WR_INIT	OTP customer field write operation initialized.
DUT_UDLL_OTP_CUSTOMER_FIELD_WR_STARTED	OTP customer field write operation started.
DUT_UDLL_OTP_CUSTOMER_FIELD_WR_OK	OTP customer field write operation ended successfully.
DUT_UDLL_OTP_CUSTOMER_FIELD_WR_FAILED	OTP customer field write operation failed.
Memory programming - OTP configuration script write	
DUT_UDLL_OTP_CFG_SCRIPT_INIT	OTP configuration script field write operation initialized.
DUT_UDLL_OTP_CFG_SCRIPT_STARTED	OTP configuration script field write operation started.
DUT_UDLL_OTP_CFG_SCRIPT_STATUS	OTP configuration script field write status update of progress.
DUT_UDLL_OTP_CFG_SCRIPT_OK	OTP configuration script field write operation ended successfully.
DUT_UDLL_OTP_CFG_SCRIPT_FAILED	OTP configuration script field write operation failed.
Memory programming - OTP memory check-empty operation	
DUT_UDLL_OTP_CHECK_EMPTY_INIT	Operation to check whether the OTP field to burn is empty initialized.
DUT_UDLL_OTP_CHECK_EMPTY_STARTED	Operation to check whether the OTP field to burn is empty started.
DUT_UDLL_OTP_CHECK_EMPTY_OK	The OTP field to burn is empty.
DUT_UDLL_OTP_CHECK_SAME_DATA_OK	The OTP field contains the same data as the ones to burn.
DUT_UDLL_OTP_CHECK_SKIP_WRITE	The OTP field is already written with data. No new data will be written. It will continue without errors.
DUT_UDLL_OTP_CHECK_EMPTY_FAILED	The OTP field is already burned with data.
Memory programming - SPI initialization	
DUT_UDLL_SPI_INIT_INIT	SPI initialization operation initialized.
DUT_UDLL_SPI_INIT_STARTED	SPI initialization operation started.
DUT_UDLL_SPI_INIT_OK	SPI initialization operation ended successfully.
DUT_UDLL_SPI_INIT_FAILED	SPI initialization operation failed.
Memory programming - SPI memory erase	
DUT_UDLL_SPI_ERASE_INIT	SPI erase operation initialized.
DUT_UDLL_SPI_ERASE_STARTED	SPI erase operation started.
DUT_UDLL_SPI_ERASE_OK	SPI erase operation ended successfully.
DUT_UDLL_SPI_ERASE_FAILED	SPI erase operation failed.
Memory programming - SPI memory check empty	
DUT_UDLL_SPI_CHECK_EMPTY_INIT	SPI check if empty operation initialized.
DUT_UDLL_SPI_CHECK_EMPTY_STARTED	SPI check if empty operation started,
DUT_UDLL_SPI_CHECK_EMPTY_OK	SPI check if empty operation ended successfully,
DUT_UDLL_SPI_CHECK_EMPTY_FAILED	SPI check if empty operation failed,
Memory programming - SPI image write	
DUT_UDLL_SPI_IMG_WR_INIT	SPI image write operation initialized.

SmartBond Production Line Tool

Status	Description
DUT_UDLL_SPI_IMG_WR_STARTED	SPI image write operation started.
DUT_UDLL_SPI_IMG_WR_OK	SPI image write operation ended successfully.
DUT_UDLL_SPI_IMG_WR_FAILED	SPI image write operation failed.
Memory programming - EEPROM initialization	
DUT_UDLL_EEPROM_INIT_INIT	EEPROM initialization operation initialized.
DUT_UDLL_EEPROM_INIT_STARTED	EEPROM initialization operation started.
DUT_UDLL_EEPROM_INIT_OK	EEPROM initialization operation ended successfully.
DUT_UDLL_EEPROM_INIT_FAILED	EEPROM initialization operation failed.
Memory programming - EEPROM image write	
DUT_UDLL_EEPROM_IMG_WR_INIT	EEPROM image write operation initialized.
DUT_UDLL_EEPROM_IMG_WR_STARTED	EEPROM image write operation started.
DUT_UDLL_EEPROM_IMG_WR_OK	EEPROM image write operation ended successfully.
DUT_UDLL_EEPROM_IMG_WR_FAILED	EEPROM image write operation failed.
Memory programming - QSPI memory initialization	
DUT_UDLL_QSPI_INIT_INIT	QSPI initialization operation initialized.
DUT_UDLL_QSPI_INIT_STARTED	QSPI initialization operation started.
DUT_UDLL_QSPI_INIT_OK	QSPI initialization operation ended successfully.
DUT_UDLL_QSPI_INIT_FAILED	QSPI initialization operation failed.
Memory programming - QSPI memory erase	
DUT_UDLL_QSPI_ERASE_INIT	QSPI erase operation initialized.
DUT_UDLL_QSPI_ERASE_STARTED	QSPI erase operation started.
DUT_UDLL_QSPI_ERASE_OK	QSPI erase operation ended successfully.
DUT_UDLL_QSPI_ERASE_FAILED	QSPI erase operation failed.
Memory programming - QSPI memory check empty	
DUT_UDLL_QSPI_CHECK_EMPTY_INIT	QSPI check if empty operation initialized.
DUT_UDLL_QSPI_CHECK_EMPTY_STARTED	QSPI check if empty operation started.
DUT_UDLL_QSPI_CHECK_EMPTY_OK	QSPI check if empty operation ended successfully.
DUT_UDLL_QSPI_CHECK_EMPTY_FAILED	QSPI check if empty operation failed.
Memory programming - QSPI image write	
DUT_UDLL_QSPI_IMG_WR_INIT	QSPI image write operation initialized.
DUT_UDLL_QSPI_IMG_WR_STARTED	QSPI image write operation started.
DUT_UDLL_QSPI_IMG_WR_OK	QSPI image write operation ended successfully.
DUT_UDLL_QSPI_IMG_WR_FAILED	QSPI image write operation failed.
Memory programming - BD address write to QSPI memory	
DUT_UDLL_QSPI_BDA_WR_INIT	QSPI BD address write operation initialized.
DUT_UDLL_QSPI_BDA_WR_STARTED	QSPI BD address write operation started.
DUT_UDLL_QSPI_BDA_WR_OK	QSPI BD address write operation ended successfully.
DUT_UDLL_QSPI_BDA_WR_FAILED	QSPI BD address write operation failed.

Status	Description
Memory programming - BD address read/compare to QSPI memory	
DUT_UDLL_QSPI_BDA_RD_INIT	QSPI BD address read operation initialized.
DUT_UDLL_QSPI_BDA_RD_STARTED	QSPI BD address read operation started.
DUT_UDLL_QSPI_BDA_RD_OK	QSPI BD address read operation ended successfully.
DUT_UDLL_QSPI_BDA_RD_FAILED	QSPI BD address read operation failed.
DUT_UDLL_QSPI_BDA_CMP_OK	QSPI BD address comparison success.
DUT_UDLL_QSPI_BDA_CMP_FAILED	QSPI BD address comparison failed. No match.
Memory programming - XTAL trim value write to QSPI memory	
DUT_UDLL_QSPI_XTAL_TRIM_WR_INIT	QSPI XTAL trim value write operation initialized.
DUT_UDLL_QSPI_XTAL_TRIM_WR_STARTED	QSPI XTAL trim value write operation started.
DUT_UDLL_QSPI_XTAL_TRIM_WR_OK	QSPI XTAL trim value write operation ended successfully.
DUT_UDLL_QSPI_XTAL_TRIM_WR_FAILED	QSPI XTAL trim value write operation failed.
Memory programming - ADC calibration value write to QSPI memory	
DUT_UDLL_QSPI_ADC_CALIB_WR_INIT	QSPI ADC calibration value write operation initialized.
DUT_UDLL_QSPI_ADC_CALIB_WR_STARTED	QSPI ADC calibration value write operation started.
DUT_UDLL_QSPI_ADC_CALIB_WR_OK	QSPI ADC calibration value write operation ended successfully.
DUT_UDLL_QSPI_ADC_CALIB_WR_FAILED	QSPI ADC calibration value write operation failed.
Memory programming - Custom data memory write	
DUT_UDLL_MEM_DATA_WR_INIT	Custom memory data burn operation initialized.
DUT_UDLL_MEM_DATA_WR_STARTED	Custom memory data burn operation started.
DUT_UDLL_MEM_DATA_WR_STATUS	Custom memory data burn update interim status.
DUT_UDLL_MEM_DATA_WR_OK	Custom memory data burn operation ended successfully.
DUT_UDLL_MEM_DATA_WR_FAILED	Custom memory data burn operation failed.
Memory programming - memory read operation	
DUT_UDLL_MEM_RD_INIT	Memory read operation initialized.
DUT_UDLL_MEM_RD_STARTED	Memory read operation started.
DUT_UDLL_MEM_RD_OK	Memory read operation ended successfully.
DUT_UDLL_MEM_RD_FAILED	Memory read operation failed.

Appendix DD Golden Unit Status Codes

Table 132 contains all the possible status codes the Golden Unit can have, followed by a brief description. The table categorizes the status based on the various states the Golden Unit may be during testing and programming the DUTs.

Table 132: Golden Unit Status Codes

Status	Description
Generic	
GU_NOT_ACTIVE	Golden Unit is not active.
GU_INTERNAL_SYSTEM_ERROR	Internal system error.

SmartBond Production Line Tool

Status	Description
GU_COM_OPEN_OK	COM port opened successfully.
GU_COM_OPEN_FAILED	COM port failed to open
GU_PDLL_NO_ERROR	PDLL returned success.
GU_PDLL_PARAMS_ERROR	Golden Unit PDLL parameters have errors.
GU_PDLL_RX_TIMEOUT	Golden Unit did not reply on a PDLL message request. GU COM port may not be correct or it may need manual RESET.
GU_PDLL_TX_TIMEOUT	Golden Unit Tx timeout when sending a message to the device.
GU_PDLL_UNEXPECTED_EVENT	Received an unexpected message from the Golden Unit.
GU_PDLL_CANNOT_ALLOCATE_MEMORY	PDLL cannot allocate memory.
GU_PDLL_INTERNAL_ERROR	PDLL internal system error.
GU_PDLL_THREAD_CREATION_ERROR	PDLL thread creation error.
GU_PDLL_DBG_DLL_ERROR	PDLL debug library (dbg_dll.dll) access error.
GU_PDLL_INVALID_DBG_PARAMS	PDLL invalid debug library (dbg_dll.dll) parameters.
GU_PDLL_HCI_STANDARD_ERROR	Golden Unit HCI error.
Golden Unit reset operation	
GU_RESET_START	Golden Unit HW reset started.
GU_RESET_OK	Golden Unit HW reset OK.
GU_RESET_FAILED	Golden Unit HW reset FAILED.
Golden Unit COM port handling	
GU_PDLL_COM_PORT_INIT	Golden Unit COM port open initialized.
GU_PDLL_COM_PORT_START	Golden Unit COM port open started.
GU_PDLL_COM_PORT_OK	Golden Unit COM port opened OK.
GU_PDLL_COM_PORT_FAILED	Golden Unit COM port FAILED.
Golden Unit firmware version	
GU_PDLL_FW_VERSION_GET_START	Golden Unit PDLL firmware version acquisition started.
GU_PDLL_FW_VERSION_GET_OK	Golden Unit PDLL firmware version acquisition OK.
GU_PDLL_FW_VERSION_GET_FAILED	Golden Unit PDLL firmware version acquisition FAILED.
GU_PDLL_FW_VERSION_VALID	The Golden Unit firmware version is valid.
GU_PDLL_FW_VERSION_NOT_VALID	The Golden Unit firmware version is not valid. An upgrade may be needed.
Golden Unit CPLD control	
GU_PDLL_RDTESTER_INIT	PLT HW tester initializing.
GU_PDLL_RDTESTER_INIT_START	PLT HW tester initialize started.
GU_PDLL_RDTESTER_INIT_OK	PLT HW tester initialized successful.
GU_PDLL_RDTESTER_INIT_FAILED	PLT HW tester initialization failed.
GU_PDLL_RDTESTER_UART_CONNECT_INIT	PLT HW tester UART connection initialized.
GU_PDLL_RDTESTER_UART_CONNECT_START	PLT HW tester UART connection started.
GU_PDLL_RDTESTER_UART_CONNECT_OK	PLT HW tester UART connected successfully.
GU_PDLL_RDTESTER_UART_CONNECT_FAILED	PLT HW tester UART connection failed.

SmartBond Production Line Tool

Status	Description
GU_PDLL_RDTESTER_UART_LOOPBACK_INIT	PLT HW tester UART loopback process initialized.
GU_PDLL_RDTESTER_UART_LOOPBACK_START	PLT HW tester UART loopback process started.
GU_PDLL_RDTESTER_UART_LOOPBACK_OK	PLT HW tester UART loopback process success.
GU_PDLL_RDTESTER_UART_LOOPBACK_FAILED	PLT HW tester UART loopback process failed.
GU_PDLL_RDTESTER_VBAT_UART_CNTRL_INIT	PLT HW tester VBAT/UART control initialized.
GU_PDLL_RDTESTER_VBAT_UART_CNTRL_START	PLT HW tester VBAT/UART control started.
GU_PDLL_RDTESTER_VBAT_UART_CNTRL_OK	PLT HW tester VBAT/UART control success.
GU_PDLL_RDTESTER_VBAT_UART_CNTRL_FAILED	PLT HW tester VBAT/UART control failed.
GU_PDLL_RDTESTER_VBAT_UART_RST_CNTRL_INIT	PLT HW tester VBAT/UART/Reset control initialized.
GU_PDLL_RDTESTER_VBAT_UART_RST_CNTRL_START	PLT HW tester VBAT/UART/Reset control started.
GU_PDLL_RDTESTER_VBAT_UART_RST_CNTRL_OK	PLT HW tester VBAT/UART/Reset control success.
GU_PDLL_RDTESTER_VBAT_UART_RST_CNTRL_FAILED	PLT HW tester VBAT/UART/Reset control failed.
GU_PDLL_RDTESTER_VPP_CNTRL_INIT	PLT HW tester VPP control initialized.
GU_PDLL_RDTESTER_VPP_CNTRL_START	PLT HW tester VPP control started.
GU_PDLL_RDTESTER_VPP_CNTRL_OK	PLT HW tester VPP control success.
GU_PDLL_RDTESTER_VPP_CNTRL_FAILED	PLT HW tester VPP control failed.
GU_PDLL_RDTESTER_RST_PULSE_INIT	PLT HW tester Reset pulse control initialized.
GU_PDLL_RDTESTER_RST_PULSE_START	PLT HW tester Reset pulse control started.
GU_PDLL_RDTESTER_RST_PULSE_OK	PLT HW tester Reset pulse control success.
GU_PDLL_RDTESTER_RST_PULSE_FAILED	PLT HW tester Reset pulse control failed.
GU_PDLL_RDTESTER_UART_PULSE_INIT	PLT HW tester XTAL trim pulse in UART TX pin initialized.
GU_PDLL_RDTESTER_UART_PULSE_START	PLT HW tester XTAL trim pulse in UART TX pin started.
GU_PDLL_RDTESTER_UART_PULSE_OK	PLT HW tester XTAL trim pulse in UART TX pin success.
GU_PDLL_RDTESTER_UART_PULSE_FAILED	PLT HW tester XTAL trim pulse in UART TX pin failed.
GU_PDLL_RDTESTER_XTAL_PULSE_INIT	PLT HW tester XTAL trim pulse in GATE pin initialized.
GU_PDLL_RDTESTER_XTAL_PULSE_START	PLT HW tester XTAL trim pulse in GATE pin started.
GU_PDLL_RDTESTER_XTAL_PULSE_OK	PLT HW tester XTAL trim pulse in GATE pin success.
GU_PDLL_RDTESTER_XTAL_PULSE_FAILED	PLT HW tester XTAL trim pulse in GATE pin failed.
GU_PDLL_RDTESTER_PULSE_WIDTH_INIT	PLT HW tester pulse width initialized.
GU_PDLL_RDTESTER_PULSE_WIDTH_START	PLT HW tester pulse width started.
GU_PDLL_RDTESTER_PULSE_WIDTH_OK	PLT HW tester pulse width success.
GU_PDLL_RDTESTER_PULSE_WIDTH_FAILED	PLT HW tester pulse width failed.
GU_PDLL_RDTESTER_VBAT_CNTRL_INIT	PLT HW tester VBAT control initialized.
GU_PDLL_RDTESTER_VBAT_CNTRL_START	PLT HW tester VBAT control started.
GU_PDLL_RDTESTER_VBAT_CNTRL_OK	PLT HW tester VBAT control success.
GU_PDLL_RDTESTER_VBAT_CNTRL_FAILED	PLT HW tester VBAT control failed.
GU_PDLL_RDTESTER_INVALID_COMMAND	PLT HW tester unknown command.
Golden Unit RF packet transmission for DUT RSSI RF test	
GU_PDLL_PKT_TX_START_INIT	Golden Unit RF packet TX initialized.

SmartBond Production Line Tool

Status	Description
GU_PDLL_PKT_TX_START	Golden Unit RF packet TX started.
GU_PDLL_PKT_TX_STARTED_OK	Golden Unit RF packet TX success.
GU_PDLL_PKT_TX_STARTED_FAILED	Golden Unit RF packet TX failed.
GU_PDLL_PKT_TX_ENDED_OK	Golden Unit RF packet TX ended successfully.
GU_PDLL_PKT_TX_STARTED_FAILED	Golden Unit RF packet TX ended failed.
Golden Unit audio tone generation for audio testing	
GU_PDLL_AUDIO_TONE_START_INIT	Golden Unit audio tone start initialized.
GU_PDLL_AUDIO_TONE_START	Golden Unit audio tone start.
GU_PDLL_AUDIO_TONE_STARTED_OK	Golden Unit audio tone started successfully.
GU_PDLL_AUDIO_TONE_START_FAILED	Golden Unit audio tone start failed.
GU_PDLL_AUDIO_TONE_STOP_INIT	Golden Unit audio tone stop initialized.
GU_PDLL_AUDIO_TONE_STOP	Golden Unit audio tone stop.
GU_PDLL_AUDIO_TONE_STOPPED_OK	Golden Unit audio tone stopped successfully.
GU_PDLL_AUDIO_TONE_STOP_FAILED	Golden Unit audio tone stop failed.
Golden Unit GPIO toggling for sanity test	
GU_PDLL_GPIO_TOGGLE_INIT	Golden Unit GPIO toggle operation initialized.
GU_PDLL_GPIO_TOGGLE_START	Golden Unit GPIO toggle operation start.
GU_PDLL_GPIO_TOGGLE_FINISHED_OK	Golden Unit GPIO toggle operation completed successfully.
GU_PDLL_GPIO_TOGGLE_FAILED	Golden Unit GPIO toggle operation failed.
Golden Unit BLE advertising scan test	
GU_PDLL_BLE_SCAN_INIT	Golden Unit scan operation initialized.
GU_PDLL_BLE_SCAN_START	Golden Unit scan operation started.
GU_PDLL_BLE_SCAN_OK	Golden Unit scan operation completed successfully.
GU_PDLL_BLE_SCAN_FAILED	Golden Unit scan operation failed.

Revision History

Revision	Date	Description
4.6	24-Jan-2022	Updated logo, disclaimer, copyringt.
4.5	01-Oct-2020	Editorial, document debugging
4.4	08-May-2020	Updated for SmartBond_PLT_v4.4 software release
4.3	17-Jul-2018	Updated for DA1458x_DA1468x_PLT_v4.3 software release
4.2	10-Oct-2017	Updated for DA1458x_DA1468x_PLT_v4.2 software release
4.1	06-Oct-2017	Updated for DA1458x_DA1468x_PLT_v4.1 software release
4.0	22-Dec-2016	Updated for DA1458x_DA1468x_PLT_v4.0 software release
3.0	22-May-2016	Adding changes for the DA1468x
2.0	04-May-2016	Adding text and drawings
1.1	18-Jan-2016	CLI part is added and Rev D. PLT Hardware
1.0	08-Jul-2015	Initial version.

SmartBond Production Line Tool**Status Definitions**

Status	Definition
DRAFT	The content of this document is under review and subject to formal approval, which may result in modifications or additions.
APPROVED or unmarked	The content of this document has been approved for publication.

RoHS Compliance

Dialog Semiconductor's suppliers certify that its products are in compliance with the requirements of Directive 2011/65/EU of the European Parliament on the restriction of the use of certain hazardous substances in electrical and electronic equipment. RoHS certificates from our suppliers are available on request.