

RZ/A2M Group

DRP Library User's Manual

All information contained in these materials, including products and product specifications, represents information on the product at the time of publication and is subject to change by Renesas Electronics Corp. without notice. Please review the latest information published by Renesas Electronics Corp. through various means, including the Renesas Electronics Corp. website (<http://www.renesas.com>).

Notice

1. Descriptions of circuits, software and other related information in this document are provided only to illustrate the operation of semiconductor products and application examples. You are fully responsible for the incorporation or any other use of the circuits, software, and information in the design of your product or system. Renesas Electronics disclaims any and all liability for any losses and damages incurred by you or third parties arising from the use of these circuits, software, or information.
2. Renesas Electronics hereby expressly disclaims any warranties against and liability for infringement or any other claims involving patents, copyrights, or other intellectual property rights of third parties, by or arising from the use of Renesas Electronics products or technical information described in this document, including but not limited to, the product data, drawings, charts, programs, algorithms, and application examples.
3. No license, express, implied or otherwise, is granted hereby under any patents, copyrights or other intellectual property rights of Renesas Electronics or others.
4. You shall not alter, modify, copy, or reverse engineer any Renesas Electronics product, whether in whole or in part. Renesas Electronics disclaims any and all liability for any losses or damages incurred by you or third parties arising from such alteration, modification, copying or reverse engineering.
5. Renesas Electronics products are classified according to the following two quality grades: “Standard” and “High Quality”. The intended applications for each Renesas Electronics product depends on the product’s quality grade, as indicated below.
“Standard”: Computers; office equipment; communications equipment; test and measurement equipment; audio and visual equipment; home electronic appliances; machine tools; personal electronic equipment; industrial robots; etc.
“High Quality”: Transportation equipment (automobiles, trains, ships, etc.); traffic control (traffic lights); large-scale communication equipment; key financial terminal systems; safety control equipment; etc.
Unless expressly designated as a high reliability product or a product for harsh environments in a Renesas Electronics data sheet or other Renesas Electronics document, Renesas Electronics products are not intended or authorized for use in products or systems that may pose a direct threat to human life or bodily injury (artificial life support devices or systems; surgical implantations; etc.), or may cause serious property damage (space system; undersea repeaters; nuclear power control systems; aircraft control systems; key plant systems; military equipment; etc.). Renesas Electronics disclaims any and all liability for any damages or losses incurred by you or any third parties arising from the use of any Renesas Electronics product that is inconsistent with any Renesas Electronics data sheet, user’s manual or other Renesas Electronics document.
6. When using Renesas Electronics products, refer to the latest product information (data sheets, user’s manuals, application notes, “General Notes for Handling and Using Semiconductor Devices” in the reliability handbook, etc.), and ensure that usage conditions are within the ranges specified by Renesas Electronics with respect to maximum ratings, operating power supply voltage range, heat dissipation characteristics, installation, etc. Renesas Electronics disclaims any and all liability for any malfunctions, failure or accident arising out of the use of Renesas Electronics products outside of such specified ranges.
7. Although Renesas Electronics endeavors to improve the quality and reliability of Renesas Electronics products, semiconductor products have specific characteristics, such as the occurrence of failure at a certain rate and malfunctions under certain use conditions. Unless designated as a high reliability product or a product for harsh environments in a Renesas Electronics data sheet or other Renesas Electronics document, Renesas Electronics products are not subject to radiation resistance design. You are responsible for implementing safety measures to guard against the possibility of bodily injury, injury or damage caused by fire, and/or danger to the public in the event of a failure or malfunction of Renesas Electronics products, such as safety design for hardware and software, including but not limited to redundancy, fire control and malfunction prevention, appropriate treatment for aging degradation or any other appropriate measures. Because the evaluation of microcomputer software alone is very difficult and impractical, you are responsible for evaluating the safety of the final products or systems manufactured by you.
8. Please contact a Renesas Electronics sales office for details as to environmental matters such as the environmental compatibility of each Renesas Electronics product. You are responsible for carefully and sufficiently investigating applicable laws and regulations that regulate the inclusion or use of controlled substances, including without limitation, the EU RoHS Directive, and using Renesas Electronics products in compliance with all these applicable laws and regulations. Renesas Electronics disclaims any and all liability for damages or losses occurring as a result of your noncompliance with applicable laws and regulations.
9. Renesas Electronics products and technologies shall not be used for or incorporated into any products or systems whose manufacture, use, or sale is prohibited under any applicable domestic or foreign laws or regulations. You shall comply with any applicable export control laws and regulations promulgated and administered by the governments of any countries asserting jurisdiction over the parties or transactions.
10. It is the responsibility of the buyer or distributor of Renesas Electronics products, or any other party who distributes, disposes of, or otherwise sells or transfers the product to a third party, to notify such third party in advance of the contents and conditions set forth in this document.
11. This document shall not be reprinted, reproduced or duplicated in any form, in whole or in part, without prior written consent of Renesas Electronics.
12. Please contact a Renesas Electronics sales office if you have any questions regarding the information contained in this document or Renesas Electronics products.

(Note 1) “Renesas Electronics” as used in this document means Renesas Electronics Corporation and also includes its directly or indirectly controlled subsidiaries.

(Note 2) “Renesas Electronics product(s)” means any product developed or manufactured by or for Renesas Electronics.

General Precautions in the Handling of Microprocessing Unit and Microcontroller Unit Products

The following usage notes are applicable to all Microprocessing unit and Microcontroller unit products from Renesas. For detailed usage notes on the products covered by this document, refer to the relevant sections of the document as well as any technical updates that have been issued for the products.

1. Handling of Unused Pins

Handle unused pins in accordance with the directions given under Handling of Unused Pins in the manual.

- The input pins of CMOS products are generally in the high-impedance state. In operation with an unused pin in the open-circuit state, extra electromagnetic noise is induced in the vicinity of LSI, an associated shoot-through current flows internally, and malfunctions occur due to the false recognition of the pin state as an input signal become possible. Unused pins should be handled as described under Handling of Unused Pins in the manual.

2. Processing at Power-on

The state of the product is undefined at the moment when power is supplied.

- The states of internal circuits in the LSI are indeterminate and the states of register settings and pins are undefined at the moment when power is supplied.
In a finished product where the reset signal is applied to the external reset pin, the states of pins are not guaranteed from the moment when power is supplied until the reset process is completed. In a similar way, the states of pins in a product that is reset by an on-chip power-on reset function are not guaranteed from the moment when power is supplied until the power reaches the level at which resetting has been specified.

3. Prohibition of Access to Reserved Addresses

Access to reserved addresses is prohibited.

- The reserved addresses are provided for the possible future expansion of functions. Do not access these addresses; the correct operation of LSI is not guaranteed if they are accessed.

4. Clock Signals

After applying a reset, only release the reset line after the operating clock signal has become stable. When switching the clock signal during program execution, wait until the target clock signal has stabilized.

- When the clock signal is generated with an external resonator (or from an external oscillator) during a reset, ensure that the reset line is only released after full stabilization of the clock signal. Moreover, when switching to a clock signal produced with an external resonator (or by an external oscillator) while program execution is in progress, wait until the target clock signal is stable.

5. Differences between Products

Before changing from one product to another, i.e. to a product with a different part number, confirm that the change will not lead to problems.

- The characteristics of Microprocessing unit or Microcontroller unit products in the same group but having a different part number may differ in terms of the internal memory capacity, layout pattern, and other factors, which can affect the ranges of electrical characteristics, such as characteristic values, operating margins, immunity to noise, and amount of radiated noise. When changing to a product with a different part number, implement a system-evaluation test for the given product.

How to Use This Manual

1. Purpose and Target Readers

This manual is intended to provide the user with an understanding of the functions of the DRP library and how to utilize them. It is aimed at users designing application systems making use of the DRP library. In order to use this manual, you will need a basic knowledge of programming languages and microprocessors.

Particular attention should be paid to the precautionary notes when using the manual. These notes occur within the body of the text, at the end of each section.

The revision history summarizes the locations of revisions and additions. It does not list all revisions. Refer to the text of the manual for details.

Contents

1. Introduction.....	6
1.1 Summary.....	6
1.2 Functions.....	7
2. Operation Conditions.....	9
3. File Structure.....	10
4. DRP Library Reference.....	12
4.1 How to Read the DRP Library Reference.....	12
4.2 Simple ISP.....	13
4.2.1 Simple ISP overview.....	13
4.2.2 Simple ISP Library structure.....	14
4.2.3 Simple ISP API.....	15
4.3 Simple ISP with object detection by color (HSV).....	21
4.3.1 Outline.....	21
4.3.2 API.....	22
4.4 Simple ISP with background subtraction.....	27
4.4.1 Outline.....	27
4.4.2 API.....	28
4.5 Simple ISP with object detection using sobel.....	36
4.5.1 Outline.....	36
4.5.2 API.....	37
4.6 Simple ISP with distortion correction.....	41
4.6.1 Outline.....	41
4.6.2 API.....	42
4.7 Simple ISP with scaling and normalization (32bit).....	47
4.7.1 Outline.....	47
4.7.2 API.....	48
4.8 Simple ISP with color calibration and 3DNR.....	52
4.8.1 Outline.....	52
4.8.2 API.....	53
4.9 Image transformation.....	62
4.9.1 Bayer2Grayscale.....	62
4.9.2 Bayer2Rgb.....	65
4.9.3 Bayer2RgbColorCorrection.....	71
4.9.4 Argb2Grayscale.....	74
4.9.5 BinarizationFixed.....	75
4.9.6 BinarizationAdaptive.....	76
4.9.7 BinarizationAdaptiveBit.....	80
4.9.8 GammaCorrection.....	82
4.9.9 Cropping.....	84
4.9.10 CroppingRgb.....	86
4.9.11 ResizeBilinearFixed.....	87
4.9.12 ResizeBilinearFixedRgb.....	89
4.9.13 ResizeBilinear.....	90
4.9.14 ResizeNearest.....	92
4.9.15 ImageRotate.....	94
4.9.16 Affine.....	98
4.9.17 Remap.....	101
4.10 Image filter.....	106

4.10.1	MedianBlur	106
4.10.2	GaussianBlur	108
4.10.3	UnsharpMasking	110
4.10.4	Sobel.....	112
4.10.5	Prewitt	114
4.10.6	Laplacian	116
4.10.7	Dilate	118
4.10.8	Erode	120
4.10.9	Opening.....	122
4.10.10	Closing	125
4.11	Feature Detection	128
4.11.1	CannyCalculate	128
4.11.2	CannyHysteresis	130
4.11.3	CornerHarris.....	132
4.11.4	MinutiaeExtract.....	134
4.11.5	MinutiaeDelete	141
4.11.6	CircleFitting	151
4.11.7	FindContours.....	155
4.12	Histograms	159
4.12.1	Histogram.....	159
4.12.2	HistogramNormalization	165
4.12.3	HistogramNormalizationRgb	168
4.13	Other	172
4.13.1	ReedSolomon	172
4.13.2	ReedSolomonGf8.....	174
4.13.3	Thinning	177
4.13.4	ImageMerging	181
5.	Using the DRP Library	188
6.	Reference Documents	189

1. Introduction

1.1 Summary

This manual describes the functions and usage of the DRP library, which run on the dynamically reconfigurable processor (DRP) of RZ/A2M Group Microprocessors.

The DRP can perform various functions according to user's setting. In this document, the function performed by DRP is called "circuit", and the data representing circuit information is called "configuration data". Writing of the circuit to DRP can be performed by loading the configuration data using DRP Driver^{*1}. DRP Library is a collection of configuration data with various functions, mainly image processing.

Note 1. For details of DRP Driver, refer to "RZ/A2M Group DRP Driver User's Manual (R01US0355)".

1.2 Functions

The functions of the configuration data contained in the DRP library are listed below.

Table 1.1 DRP Library Functions

Category	Function Name	Outline	Page
Image processing	Simple ISP	Implements simple image signal processor (ISP) functionality using pipeline processing	13
	Simple ISP with object detection by color (HSV)	Simple ISP that implements object detection using color components of the target object	21
	Simple ISP with background subtraction	Simple ISP that extracts a moving object by using the background subtraction	27
	Simple ISP with object detection using sobel	Simple ISP that extracts an object having complex contours from multiple objects	36
	Simple ISP with distortion correction	Simple ISP that performs barrel distortion correction	41
	Simple ISP with scaling and normalization(32bit)	Simple ISP that implements pre-processing (floating-point conversion, normalization, and resizing) for AI inference	47
	Simple ISP with color calibration and 3DNR	Simple ISP that specializes in the output of images having high color-reproducibility through color-matrix correction and 3D noise reduction	52
Image transformation	Bayer2Grayscale	Converts from RAW data acquired from CMOS to grayscale	62
	Bayer2Rgb	Converts from RAW data acquired from CMOS to RGB	65
	Bayer2RgbColorCorrection	Converts from RAW data acquired from CMOS camera to RGB (With color correction)	71
	Argb2Grayscale	Converts from ARGB to grayscale	74
	BinarizationFixed	Converts the image to a binary image with a fixed threshold (fixed threshold)	75
	BinarizationAdaptive	Converts the image to a binary image with a dynamic threshold matching the surrounding image (adaptive threshold)	76
	BinarizationAdaptiveBit	Converts the image to a binary image with a dynamic threshold matching the surrounding image (adaptive threshold) (bit output)	80
	GammaCorrection	Corrects the image with gamma value	82
	Cropping	Crops a part of the image	84
	CroppingRgb	Crops a part of the image (RGB)	86
	ResizeBilinearFixed	Resizes the image (bilinear interpolation, scale factor: 2 ⁿ)	87
	ResizeBilinearFixedRgb	Resizes the image (bilinear interpolation, scale factor: 2 ⁿ) (RGB)	89
	ResizeBilinear	Resizes the image (bilinear interpolation, scale factor: any)	90
	ResizeNearest	Resizes the image (nearest neighbor interpolation, scale factor: any)	92
	ImageRotate	Rotates the image	94
	Affine	Performs parallel translation and linear transformation on the image	98
	Remap	Performs the image conversion using the X- and Y-coordinate map data	101

Category	Function Name	Outline	Page
Image filter	MedianBlur	Reduces the noise contained in the image	106
	GaussianBlur	The image smoothing	108
	UnsharpMasking	The image sharpening	110
	Sobel	Creates the edge of the image using Sobel filter	112
	Prewitt	Creates the edge of the image using Prewitt filter	114
	Laplacian	Creates the edge of the image using Laplacian filter	116
	Dilate	Dilation of white part in the image	118
	Erode	Erosion of white part in the image	120
	Opening* ¹	Removes noise from black portions by shrinkage (erosion) followed by expansion (dilation)	122
	Closing* ¹	Removes noise from white portions by expansion (dilation) followed by shrinkage (erosion)	125
Feature detection	CannyCalculate	Detects the edge of the image using the Canny method (performed by continuous processing of 2 functions)	128
	CannyHysteresis		130
	CornerHarris	Detects the corner contained in the image using the method devised by Chris Harris	132
	MinutiaeExtract	Extracts minutiae points of fingerprint ridge lines used in fingerprint recognition	134
	MinutiaeDelete	Deletes minutiae points of fingerprint ridge lines used in fingerprint recognition	141
	CircleFitting	Detects circle from the input image	151
	FindContours	Detects contours in the image and calculates its bounding rectangle	155
Histograms	Histogram	Generates a histogram from the input image	159
	HistogramNormalization	Normalizes the histogram of the image	165
	HistogramNormalizationRgb	Normalizes the histogram of the image (RGB)	168
Other	ReedSolomon	Performs error correction using Reed-Solomon codes (fixed primitive polynomial)	172
	ReedSolomonGf8	Performs error correction using GF(2 ⁸) Reed-Solomon codes	174
	Thinning	Outputs an image on which thinning has been performed	177
	ImageMerging	Merges two grayscale-images separately captured over different ranges	181

Note 1. This function can be executed by a combination of Dilate and Erode.

2. Operation Conditions

The DRP library operates under the conditions listed below.

Table 2.1 Operation Conditions

Item	Description
Microprocessor	RZ/A2M Group Microprocessors* ¹ <ul style="list-style-type: none">• R7S921051VCBG• R7S921052VCBG• R7S921053VCBG

Note 1. The DRP library operates on RZ/A2M Group Microprocessors equipped with a DRP function module. It will not operate on RZ/A2M Group Microprocessors without a DRP function module.

This library was confirmed to operate in the following development environment:

Renesas e² studio 7.8.0

The following toolchain is compatible:

GCC ARM Embedded Toolchain 6-2017-q2-update

3. File Structure

Figure 3.1 and Figure 3.2 shows the file structure of configuration data and header files in the DRP library.

drp_lib	
r_drp_affine.dat	Affine
r_drp_affine.h	
r_drp_argb2grayscale.dat	ARGB2Grayscale
r_drp_argb2grayscale.h	
r_drp_bayer2grayscale.dat	Bayer2Grayscale
r_drp_bayer2grayscale.h	
r_drp_bayer2rgb.dat	Bayer2Rgb
r_drp_bayer2rgb.h	
r_drp_bayer2rgb_color_correction.dat	Bayer2RgbColorCorrection
r_drp_bayer2rgb_color_correction.h	
r_drp_binarization_adaptive.dat	BinarizationAdaptive
r_drp_binarization_adaptive.h	
r_drp_binarization_adaptive_bit.dat	BinarizationAdaptiveBit
r_drp_binarization_adaptive_bit.h	
r_drp_binarization_fixed.dat	BinarizationFixed
r_drp_binarization_fixed.h	
r_drp_canny_calculate.dat	CannyCalculate
r_drp_canny_calculate.h	
r_drp_canny_hysteresis.dat	CannyHysteresis
r_drp_canny_hysteresis.h	
r_drp_circle_fitting.dat	CircleFitting
r_drp_circle_fitting.h	
r_drp_corner_harris.dat	CornerHarris
r_drp_corner_harris.h	
r_drp_cropping.dat	Cropping
r_drp_cropping.h	
r_drp_cropping_rgb.dat	CroppingRgb
r_drp_cropping_rgb.h	
r_drp_dilate.dat	Dilate
r_drp_dilate.h	
r_drp_erode.dat	Erode
r_drp_erode.h	
r_drp_find_contours.dat	FindContours
r_drp_find_contours.h	
r_drp_gamma_correction.dat	GammaCorrection
r_drp_gamma_correction.h	
r_drp_gaussian_blur.dat	GaussianBlur
r_drp_gaussian_blur.h	
r_drp_histogram.dat	Histogram
r_drp_histogram.h	
r_drp_histogram_normalization.dat	HistogramNormalization
r_drp_histogram_normalization.h	
r_drp_histogram_normalization_rgb.dat	HistogramNormalizationRgb
r_drp_histogram_normalization_rgb.h	
r_drp_image_merging.dat	ImageMerging
r_drp_image_merging.h	
r_drp_image_rotate.dat	ImageRotate
r_drp_image_rotate.h	

Figure 3.1 File Structure (1/2)

r_drp_laplacian.dat	LaplacianFilter
r_drp_laplacian.h	
r_drp_median_blur.dat	MedianBlur
r_drp_median_blur.h	
r_drp_minutiae_delete.dat	MinutiaeDelete
r_drp_minutiae_delete.h	
r_drp_minutiae_extract.dat	MinutiaeExtract
r_drp_minutiae_extract.h	
r_drp_prewitt.dat	Prewitt
r_drp_prewitt.h	
r_drp_reed_solomon.dat	ReedSolomon
r_drp_reed_solomon.h	
r_drp_reed_solomon_gf8.dat	ReedSolomonGf8
r_drp_reed_solomon_gf8.h	
r_drp_remap.dat	Remap
r_drp_remap.h	
r_drp_resize_bilinear.dat	ResizeBilinear
r_drp_resize_bilinear.h	
r_drp_resize_bilinear_fixed.dat	ResizeBilinearFixed
r_drp_resize_bilinear_fixed.h	
r_drp_resize_bilinear_fixed_rgb.dat	ResizeBilinearFixedRgb
r_drp_resize_bilinear_fixed_rgb.h	
r_drp_resize_nearest.dat	ResizeNearest
r_drp_resize_nearest.h	
r_drp_simple_isp_bayer2grayscale_3.dat	Simple ISP
r_drp_simple_isp_bayer2grayscale_6.dat	
r_drp_simple_isp_bayer2rgb_6.dat	
r_drp_simple_isp_bayer2yuv_3.dat	
r_drp_simple_isp_bayer2yuv_6.dat	
r_drp_simple_isp_bayer2yuv_planar_3.dat	
r_drp_simple_isp_bayer2yuv_planar_6.dat	
r_drp_simple_isp_grayscale_3.dat	
r_drp_simple_isp_grayscale_6.dat	
r_drp_simple_isp.h	
r_drp_simple_isp_bg_subtraction_6.dat	Simple ISP with background subtraction
r_drp_simple_isp_bg_subtraction.h	
r_drp_simple_isp_colcal_3dnr_6.dat	Simple ISP with color calibration and 3DNR
r_drp_simple_isp_colcal_3dnr.h	
r_drp_simple_isp_distortion_correction_6.dat	Simple ISP with distortion correction
r_drp_simple_isp_distortion_correction.h	
r_drp_simple_isp_obj_det_color_6.dat	Simple ISP with object detection by color (HSV)
r_drp_simple_isp_obj_det_color.h	
r_drp_simple_isp_obj_det_sobel_4.dat	Simple ISP with object detection using sobel
r_drp_simple_isp_obj_det_sobel_6.dat	
r_drp_simple_isp_obj_det_sobel.h	
r_drp_simple_isp_scal_normaliz_b32_6.dat	Simple ISP with scaling and normalization (32bit)
r_drp_simple_isp_scal_normaliz_b32.h	
r_drp_sobel.dat	Sobel
r_drp_sobel.h	
r_drp_thinning.dat	Thinning
r_drp_thinning.h	
r_drp_unsharp_masking.dat	UnsharpMasking
r_drp_unsharp_masking.h	

Figure 3.2 File Structure (2/2)

4. DRP Library Reference

4.1 How to Read the DRP Library Reference

In this section the specifications of the configuration data contained in the DRP library are presented in the format shown below.

Function name*¹

Function outline

Configuration data file	The name of the configuration data file. Use the DRP Driver's R_DK2_Load() function to load the data in the DRP.
Supported version	Lists the version of the configuration data that operates under present specification. Use the DRP Driver's R_DK2_GetInfo() function to get the version.
Configuration data size (byte)	Lists the size of the configuration data. Lists all versions, if there are different versions.
Header file	The name of the header file for using the configuration data. Use #include "header file" to include the file.
Parameter	Lists the parameters required by the circuit. Parameters are passed from the CPU to the DRP by means of the DRP driver's R_DK2_Start() function. Parameters are defined as a structure within the header file. Before running the circuit, set the parameters on the CPU side. The data type defined in stdint.h is used. Also, the area where parameters are stored and the Addresses such as 'src' and 'dst' set in parameters must exist in physical memory, and it is necessary to set a physical address. * ²
I/O details	Lists the details of the data specified by the parameters. Unless otherwise indicated, the same address may be specified for the input buffer address and output buffer address.
Number of tiles	The number of tiles used by the circuit. The DRP has 6 tiles. The DRP Driver's R_DK2_Load() function is used to assign circuits to tiles.
Segmented processing	Indicates that the function can be processed in parallel by multiple circuits. In parallel processing, the input image is divided up in the vertical direction and processed accordingly. The segmented processing can be executed by utilizing the 6 tiles of DRP and loading multiple configuration data of 3 tiles or less. For details on loading multiple configuration data of 3 tiles or less into DRP, see the explanation of R_DK2_Load () function in "RZ/A2M Group DRP Driver User's Manual".

Example: A case where the input image is divided into three portions in the vertical direction



Description	Describes the specifications of the configuration data.
Note	Additional notes appear here.
Note 1.	The function name of configuration data is a character string that can be obtained from the configuration data by using the DRP Driver's R_DK2_GetInfo() function.
Note 2.	If the values of physical memory in the area of parameters and input/output data of the circuit are incorrect because the values are in the Cortex-A9 cache, etc., the circuit does not work properly. It must be necessary to clean the cache before calling the DRP driver's R_DK2_Start() function or to allocate the parameters and input/output data of circuit to a non-cached area.

For information on using the API functions of the DRP Driver, refer to "RZ/A2M Group DRP Driver User's Manual (R01US0355)".

4.2 Simple ISP

4.2.1 Simple ISP overview

Simple ISP is an ISP (Image Signal Processor) most suitable for image recognition, and it performs color correction, color component accumulation, demosaicing, noise reduction, sharpening, gamma correction, and color conversion on captured data (Bayer array or Grayscale). These functions are performed with pipeline processing and then output. This DRP library has been prepared for each output format. Refer to Table 4.1 with regard to a table of the input and output format and the file names of the DRP library. AE (automatic exposure control) can be realized by adjusting the gain of the CMOS sensor and the shutter speed on the CPU side by using the color component integrated value obtained from Simple ISP.

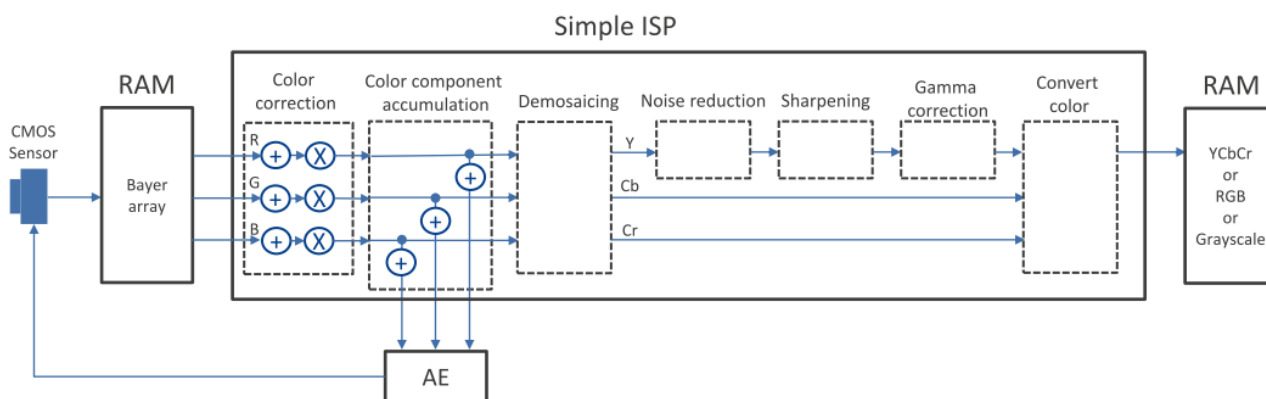

Figure 4.1 Simple ISP block diagram when input is Bayer array

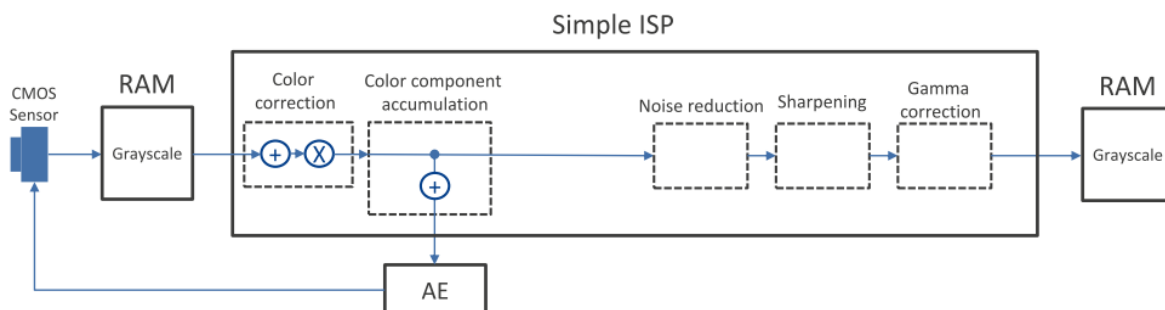

Figure 4.2 Simple ISP block diagram when input is Grayscale

- Color correction : Correction by addition and multiplication for each RGB component or Grayscale in the Bayer array
- Color component accumulation : Accumulated value for each RGB component or Grayscale in the Bayer array
- Demosaicing : Interpolation (ACPI / LI) from Bayer array to YCbCr or Y component
- Noise reduction : Noise reduction for Y component or Grayscale (Median filter)
- Sharpening : Sharpening for Y component or Grayscale (Unsharp masking)
- Gamma correction : Gamma correction for Y component or grayscale
- Color conversion : Color conversion processing for YCbCr component

4.2.2 Simple ISP Library structure

The Simple ISP library has configuration data for two types of input and four types of output format as shown in the table below. The configuration data file has a 6-tile version optimized for performance and a 3-tile version to suppress the number of tiles, which can be used according to the application.

Table 4.1 Simple ISP Library List

Input format	Output format	Tile numbers	Configuration data file name
Bayer	YCbCr	6 tiles	r_drp_simple_isp_bayer2yuv_6.dat
	Packed format	3 tiles	r_drp_simple_isp_bayer2yuv_3.dat
	YCbCr Planar format	6 tiles	r_drp_simple_isp_bayer2yuv_planar_6.dat
		3 tiles	r_drp_simple_isp_bayer2yuv_planar_3.dat
	RGB	6 tiles	r_drp_simple_isp_bayer2rgb_6.dat
	Grayscale	6 tiles	r_drp_simple_isp_bayer2grayscale_6.dat
3 tiles		r_drp_simple_isp_bayer2grayscale_3.dat	
Grayscale	Grayscale	6 tiles	r_drp_simple_isp_grayscale_6.dat
		3 tiles	r_drp_simple_isp_grayscale_3.dat

4.2.3 Simple ISP API

Simple ISP

Implements simple image signal processor (ISP) functionality using pipeline processing

Configuration data file	1) r_drp_simple_isp_bayer2yuv_6.dat 2) r_drp_simple_isp_bayer2yuv_3.dat 3) r_drp_simple_isp_bayer2yuv_planar_6.dat 4) r_drp_simple_isp_bayer2yuv_planar_3.dat 5) r_drp_simple_isp_bayer2rgb_6.dat 6) r_drp_simple_isp_bayer2grayscale_6.dat 7) r_drp_simple_isp_bayer2grayscale_3.dat 8) r_drp_simple_isp_grayscale_6.dat 9) r_drp_simple_isp_grayscale_3.dat		
Supported version	1.02		
Configuration data size (byte)	1) 424960, 2) 234656, 3) 547936, 4) 266304, 5) 412128, 6) 369344, 7) 200512, 8) 353568, 9) 205152		
Header file	r_drp_simple_isp.h		
Parameter	Structure name		
	r_drp_simple_isp_t		
	Member name	Type	Description
	src	uint32_t	Input image address
	dst	uint32_t	Output image address Y component is output for the configuration data of 3) and 4).
	dst2	uint32_t	Output image address (Cb component)
	dst3	uint32_t	Output image address (Cr component)
	width	uint16_t	Image width (min.: 16, max.: specified in Table 4.2 (an integer multiple of 2))
	height	uint16_t	Image height (4 to 1080, integer multiple of 2)
	component	uint8_t	1: Acquire color component accumulation 0: Do not acquire luminance accumulation
	accumulate	uint32_t	The address of area storing the color component accumulation
	area1_offset_x	uint16_t	x coordinate of the start position of the area 1 for color component accumulation
	area1_offset_y	uint16_t	y coordinate of the start position of the area 1 for color component accumulation
	area1_width	uint16_t	The area 1 for color component accumulation width
	area1_height	uint16_t	The area 1 for color component accumulation height
	area2_offset_x	uint16_t	x coordinate of the start position of the area 2 for color component accumulation
	area2_offset_y	uint16_t	y coordinate of the start position of the area 2 for color component accumulation
	area2_width	uint16_t	The area 2 for color component accumulation width
	area2_height	uint16_t	The area 2 for color component accumulation height
	area3_offset_x	uint16_t	x coordinate of the start position of the area 3 for color component accumulation
	area3_offset_y	uint16_t	y coordinate of the start position of the area 3 for color component accumulation
	area3_width	uint16_t	The area 3 for color component accumulation width
	area3_height	uint16_t	The area 3 for color component accumulation height

bias_r	int8_t	Bias correction value of image (R component) (-128 to 127).
bias_g	int8_t	Bias correction value of image (G component) (-128 to 127).
bias_b	int8_t	Bias correction value of image (B component) (-128 to 127).
bias_gray	int8_t	Bias correction value of image (Grayscale) (-128 to 127).
gain_r	uint16_t	Gain correction value of image (R component). The upper 4 bits are an integer part, the lower 12 bits are a decimal part.
gain_g	uint16_t	Gain correction value of image (G component). The upper 4 bits are an integer part, the lower 12 bits are a decimal part.
gain_b	uint16_t	Gain correction value of image (B component). The upper 4 bits are an integer part, the lower 12 bits are a decimal part.
gain_gray	uint16_t	Gain correction value of image (Grayscale). The upper 4 bits are an integer part, the lower 12 bits are a decimal part.
blend	uint16_t	Strength of noise reduction (0x000 to 0x100) 0x000: OFF, 0x100: ON (Maximum)
strength	uint8_t	Sharpening filter emphasis value (0 to 255)
coring	uint8_t	Sharpening filter coring value (0 to 255)
gamma	uint8_t	1: Perform gamma correction 0: Do not perform gamma correction
table	uint32_t	LUT for gamma correction address
Number of tiles	Described in Table 4.2	
Segmented processing	Not supported	

Table 4.2 Correspondence table between Simple ISP parameters and tiles

Parameter	Configuration data file								
	1)	2)	3)	4)	5)	6)	7)	8)	9)
dst2	x	x	○	○	x	x	x	x	x
dst3	x	x	○	○	x	x	x	x	x
Maximum value of width	1920	1022	1920	1022	1920	1920	1920	1920	1920
bias_r	○	○	○	○	○	○	○	x	x
bias_g	○	○	○	○	○	○	○	x	x
bias_b	○	○	○	○	○	○	○	x	x
bias_gray	x	x	x	x	x	x	x	○	○
gain_r	○	○	○	○	○	○	○	x	x
gain_g	○	○	○	○	○	○	○	x	x
gain_b	○	○	○	○	○	○	○	x	x
gain_gray	x	x	x	x	x	x	x	○	○
Number of tiles	6	3	6	3	6	6	3	6	3

○: used, x: unused

The parameters other than above are used by all of the configuration data files.

Description **Input image**

Bayer array of the input image is shown below. The data length of 1 pixel should be 8 bits.

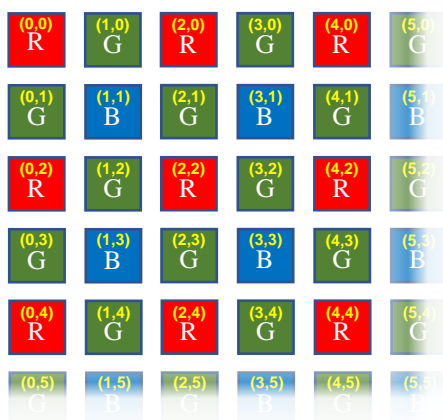
**Output image**

If the output is in the packed YCbCr422 format, YCbCr422 (16 BPP) data are output for the image size specified by parameters "width" and "height".

Output format of YCbCr422 Packed format:

CB0, Y0, CR0, Y1, CB2, Y2, CR2, Y3 ····

(Y_n, CB_n, CR_n: The brightness and color difference values of the n-th pixel.)

If the output is in the planar YCbCr422 format, the image size for the YCbCr422 (16 BPP) data is specified by the parameters "width" and "height", Y components are output to dst, Cb components are output to dst2, and Cr components are output to dst3.

Output format of dst of YCbCr422 Planar format:

Y0, Y1, Y2, Y3.....

Output format of dst2 of YCbCr422 Planar format:

CB0, CB2, CB4, CB6.....

Output format of dst3 of YCbCr422 Planar format:

CR0, CR2, CR4, CR6.....

(Y_n, CB_n, CR_n: The brightness and color difference values of the n-th pixel)

If the output is RGB, RGB (24 BPP) data are output for the image size specified by parameters "width" and "height".

Output format of RGB:

R0, G0, B0, R1, G1, B1.....

(R_n, G_n, B_n: The brightness of each color of the n-th pixel)

If the output is grayscale, grayscale (8 BPP) data are output for the image size specified by parameters "width" and "height".

Details of each pipeline processing

Color Component Accumulation

It outputs the integrated result for each RGB component of Bayer array. For each of the three areas specified by the parameters area 1 to area 3, it accumulates each of the three components R, G, and B. In the case of grayscale, the same integrated value is output to all the results. A total of nine accumulated values are output to the address specified by the "accumulate" parameter. 1 accumulated value = 32 bit length, please secure a total area of 36 bytes.

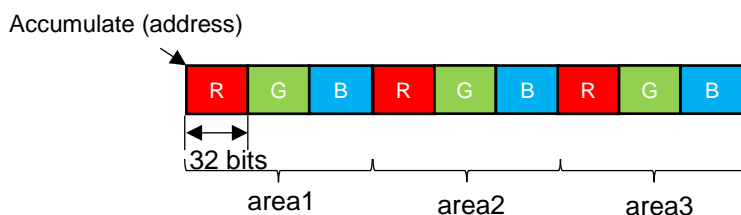
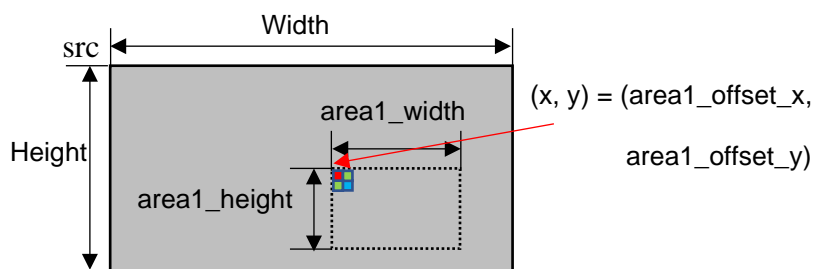

From the color component accumulated value, the average luminance when the input is Bayer array can be calculated by the following formula.

Average luminance

$$= \frac{(0.299 \times \text{accumulation of R} \times 4) + (0.587 \times \text{accumulation of G} \times 2) + (0.114 \times \text{accumulation of B} \times 4)}{\text{area width} \times \text{area height}}$$

In addition, the average of color components can be calculated by the following formula.

$$\text{Average of color component (R or B)} = \frac{\text{accumulation of R or B}}{\text{area width} \times \text{area height} \div 4}$$

$$\text{Average of color component (G)} = \frac{\text{accumulation of G}}{\text{area width} \times \text{area height} \div 2}$$

Color Correction

When the input is Bayer array, the values set by parameters "bias_r", "bias_g", "bias_b" are added to each RGB component, and the result is then multiplied by the value set by "gain_r", "gain_g", "gain_b".

When the input is Grayscale, the value set by parameter "bias_gray" is added, and the result is then multiplied by the value set by "gain_gray".

Demosaicing

For YCbCr output and RGB output, converts from Bayer array to YCbCr422 by Adaptive Color Plane Interpolation method (ACPI). For Grayscale output, it converts from Bayer array to Grayscale by Linear Interpolation method (LI).

Noise Reduction

Noise reduction is performed by the Median filter algorithm.

You can adjust the amount of noise reduction by combining the input image and the Median filter noise reduction image at the blend ratio designated by the parameter "blend". When 0 is specified for "blend", noise reduction is turned off.

$$\text{Output} = \frac{\text{Input image} \times (256 - \text{blend}) + \text{median image} \times \text{blend}}{256}$$

Sharpening

Sharpens the image using the Unsharp masking algorithm. For input, sharpening is performed by subtracting the edge created by the following 8-direction Laplacian filter. Strength of sharpening is specified as "strength", and threshold of amplitude difference without sharpening is designated by "coring".

8-direction Laplacian filter

1	1	1
1	-8	1
1	1	1

Sharpening processing calculation is as follows.

$$\text{Output} = \text{Input} - \left(\frac{\text{strength}}{256} \times A \right)$$

A: result of applying 8-direction Laplacian filter

We compare by "coring" so as not to execute sharpening processing on a weak edge with a low amplitude difference. It does not filter on the pixel of interest that satisfies the following formula.

$$\text{coring} \geq |A|$$

Gamma Correction

Please store the gamma table at the address specified by parameter "table".

It converts the pixel value by referring to the LUT, which is "table" with values from 0 to 255.

Color Conversion

Color conversion is performed according to the output.

Example

Exposure Control Example

You can calculate the average luminance from the result of color component integration, and perform exposure control using this average luminance. If the average luminance is low, you can adjust this value by decreasing the shutter speed, increasing the gain, increasing the average luminance, increasing the shutter speed, or lowering the gain.

White Balance Example

Using the result of color component accumulation, you can adjust the white balance by performing gain correction as follows. Based on the G component as a main component, compare the accumulation results of R and B color components and calculate the set value of gain from that ratio.

Example:

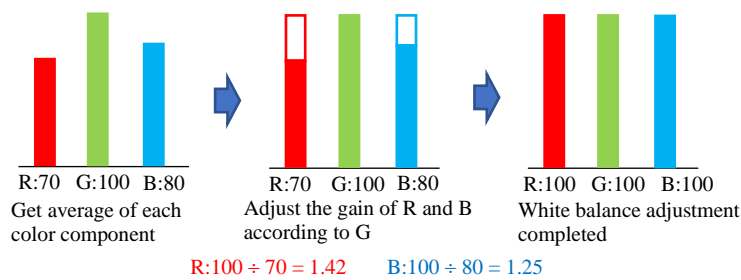

In the case of the above example, G is 1.42 times larger than R and G is 1.25 larger than times from B, so set R gain to 1.42 times and B gain to 1.25 times.

Note None

4.3 Simple ISP with object detection by color (HSV)

4.3.1 Outline

This function performs color correction, color component accumulation, demosaicing, binarization, Opening and Closing on captured data (Bayer array) stored in the memory as the pre-processing for object detection. These functions are performed with pipeline processing. The target of this function is the object detection using color components of a target object. This function outputs a binarized image extracting the target color components and a grayscale image of the captured data. AE (automatic exposure control) can be realized by adjusting the gain of the CMOS sensor and the shutter speed on the CPU side by using the color component accumulation value obtained from this function.

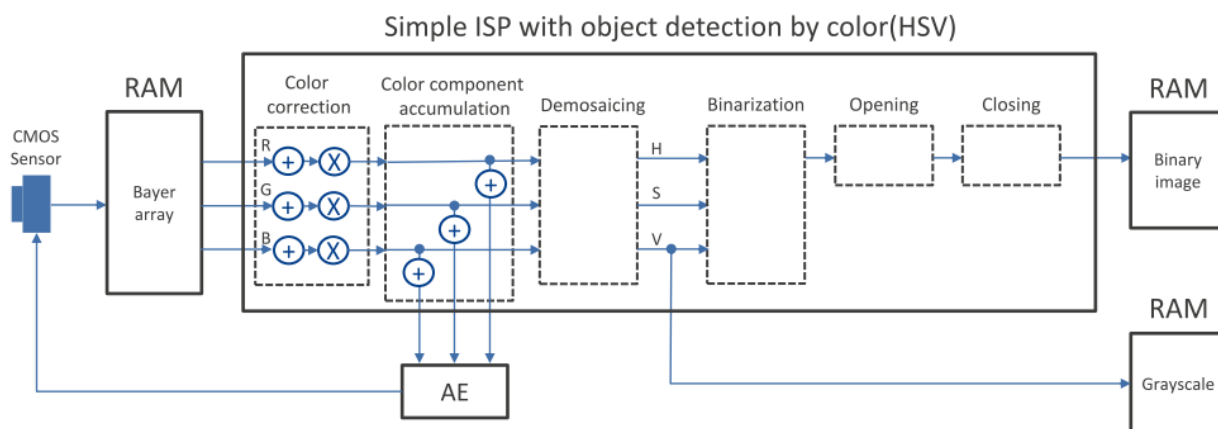

Figure 4.3 Block diagram of Simple ISP with object detection by color (HSV)

- Color correction : Correction by addition and multiplication for each RGB component in the Bayer array
- Color component accumulation : Accumulated value for each RGB component in the Bayer array
- Demosaicing : Interpolation (LI) from Bayer array to HSV component
- Binarization : Binarization for HSV component
- Opening : Noise reduction for binary image
- Closing : Noise reduction for binary image

4.3.2 API

Simple ISP with object detection by color (HSV)

Simple ISP that implements object detection using color components of the target object

Configuration data file	r_drp_simple_isp_obj_det_color_6.dat		
Supported version	1.00		
Configuration data size (byte)	322624		
Header file	r_drp_simple_isp_obj_det_color.h		
Parameter	Structure name		
	r_drp_simple_isp_obj_det_color_t		
	Member name	Type	Description
	src	uint32_t	Input image address
	dst	uint32_t	Output image (binary image) address
	v_dst	uint32_t	Output image (grayscale image) address (When set to 0, no grayscale image is output.)
	width	uint16_t	Image width (16 to 1920, integer multiple of 2)
	height	uint16_t	Image height (4 to 1080, integer multiple of 2)
	component	uint8_t	1: Acquire color component accumulation 0: Do not acquire color component accumulation
	accumulate	uint32_t	The address of area storing the color component accumulation
	area1_offset_x	uint16_t	x coordinate of the start position of the area 1 for color component accumulation
	area1_offset_y	uint16_t	y coordinate of the start position of the area 1 for color component accumulation
	area1_width	uint16_t	Width of the area 1 for color component accumulation
	area1_height	uint16_t	Height of the area 1 for color component accumulation
	area2_offset_x	uint16_t	x coordinate of the start position of the area 2 for color component accumulation
	area2_offset_y	uint16_t	y coordinate of the start position of the area 2 for color component accumulation
	area2_width	uint16_t	Width of the area 2 for color component accumulation
	area2_height	uint16_t	Height of the area 2 for color component accumulation
	area3_offset_x	uint16_t	x coordinate of the start position of the area 3 for color component accumulation
	area3_offset_y	uint16_t	y coordinate of the start position of the area 3 for color component accumulation
	area3_width	uint16_t	Width of the area 3 for color component accumulation
	area3_height	uint16_t	Height of the area 3 for color component accumulation
	bias_r	int8_t	Bias correction value of image (R component) (-128 to 127)
	bias_g	int8_t	Bias correction value of image (G component) (-128 to 127)
	bias_b	int8_t	Bias correction value of image (B component) (-128 to 127)
	gain_r	uint16_t	Gain correction value of image (R component) The upper 4 bits are an integer part, the lower 12 bits are a decimal part.
	gain_g	uint16_t	Gain correction value of image (G component) The upper 4 bits are an integer part, the lower 12 bits are a decimal part.
	gain_b	uint16_t	Gain correction value of image (B component) The upper 4 bits are an integer part, the lower 12 bits are a decimal part.
	h_cmp_mode	uint8_t	0: Range of H component used for determination of binarization does not stride 0. 1: Range of H component used for determination of binarization strides 0.
	h_min	uint8_t	Lower limit determination value for binarization (H component) (in case of h_cmp_mode=0, 0 to h_max, in case of h_cmp_mode=1, h_max to 255)

h_max	uint8_t	Upper limit determination value for binarization (H component) (in case of h_cmp_mode=0, h_min to 255, in case of h_cmp_mode=1, 0 to h_min)
s_min	uint8_t	Lower limit determination value for binarization (S component) (0 to s_max)
s_max	uint8_t	Upper limit determination value for binarization (S component) (s_min to 255)
v_min	uint8_t	Lower limit determination value for binarization (V component) (0 to v_max)
v_max	uint8_t	Upper limit determination value for binarization (V component) (v_min to 255)
opening	uint8_t	Number of iterations of Erode and Dilate in Opening processing (0 to 30, integer multiple of 2)
closing	uint8_t	Number of iterations of Dilate and Erode in Closing processing (0 to 30, integer multiple of 2)
Number of tiles	6	
Segmented processing	Not supported	

Description

Input image

Same as the input image of 4.2.3 Simple ISP API.

Output image

Binary image (8 BPP) data are output to the dst area for the image size specified by parameters "width" and "height".

Grayscale image (8 BPP) data are output to the v_dst area for the image size specified by parameters "width" and "height".

Details of each pipeline processing**Color Correction**

Same as the color correction of 4.2.3 Simple ISP API.

Color Component Accumulation

Same as the color component accumulation of 4.2.3 Simple ISP API.

Demosaicing

Bayer array is converted to HSV by Linear Interpolation method (LI). Linear Interpolation method may cause false color. When performing binarization on the basis of the threshold of H component, such generated false color may cause fine grained noise. The fine grained noise of binary image output to the parameter dst can be eliminated by Opening and Closing processing. On the other hand, because the grayscale image output to the parameter v_dst does not contain color components, the influence of noise is small. Therefore, the Linear Interpolation method whose load to the system is small is used for the noise reduction.

Binarization

Binarization is performed as follows;

If each of HSV data components satisfies all of the following conditions 1 to 3, the pixel value is 255. Otherwise, 0.

1. The H component satisfies the following conditions.
 - A) in case of $h_cmp_mode=0$, $h_min \leq H \text{ component} \leq h_max$)

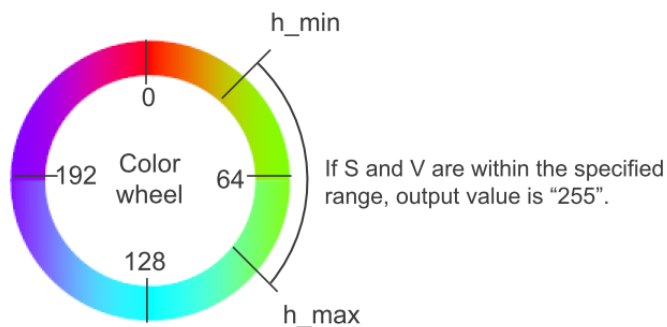

- B) in case of $h_cmp_mode=1$, $h_min \leq H \text{ component}$, or $H \text{ component} \leq h_max$)

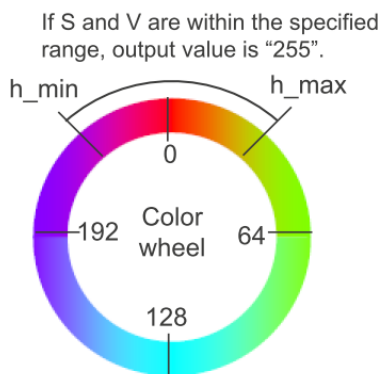

2. $s_min \leq S \text{ component} \leq s_max$
3. $v_min \leq V \text{ component} \leq v_max$

Opening

Perform Opening processing for the number of iterations specified by the opening parameter. For details of the Opening processing, refer to 4.10.9 Opening.

Closing

Perform Closing processing for the number of iterations specified by the closing parameter. For details of the Closing processing, refer to 4.10.10 Closing.

Example**Example of Color Detection**

The aim of this function is extraction of color components. Therefore, the image data are transformed into the HSV color space that is suitable for extracting color components.

Extraction of specific color component is enabled by performing binarization through specifying the respective threshold values for each component of HSV.

For example, if a hand of human is detected, each of parameters is set to extract the color of hand. Depending on the environment, adjust the setting values of the parameters `h_cmp_mode`, `*_min`, and `*_max` (*=h,s,v).

Example of parameter settings:

`h_cmp_mode=0`

`h_min=0, h_max=14`

`s_min=30, s_max=150`

`v_min=60, v_max=255`

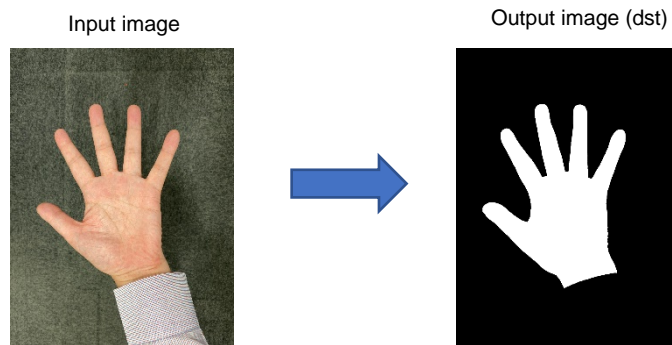
**Exposure Control Example**

Same as the Exposure Control Example of 4.2.3 Simple ISP API.

Example of White Balance

Same as the Example of White Balance of 4.2.3 Simple ISP API.

NoteNone

4.4 Simple ISP with background subtraction

4.4.1 Outline

The simple ISP function is specialized for the output of binary images of moving objects extracted as differences from comparison of the input image and background model image by using background subtraction. With the use of this function alone, users can realize functions from the CMOS sensor input to obtaining binary images in which a moving object is extracted. This function performs color correction, color component accumulation, demosaicing, noise reduction, sharpening, Gamma correction, and background subtraction on captured data (Bayer array) stored in the memory. These functions are performed with pipeline processing. AE (automatic exposure control) can be realized by adjusting the gain of the CMOS sensor and the shutter speed on the CPU side by using the color component accumulation value obtained from this function.

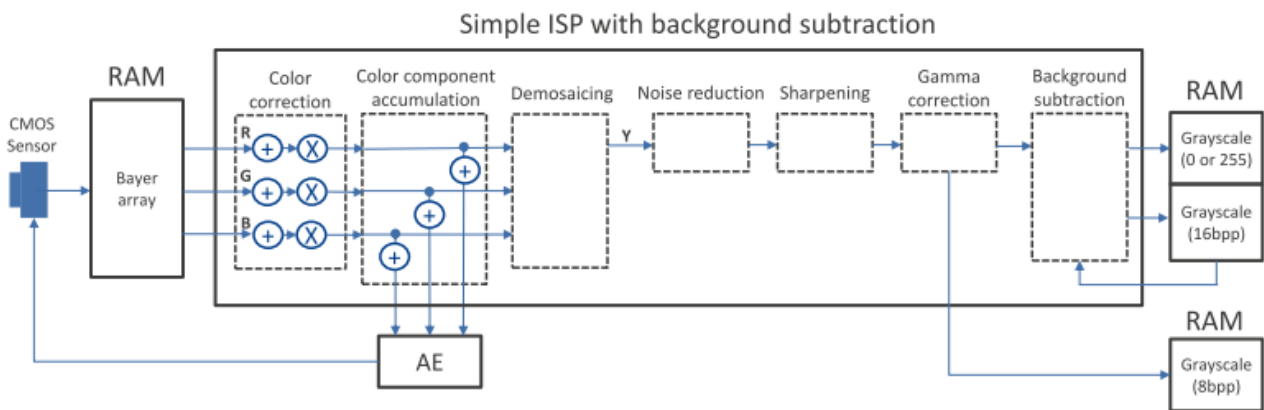

Figure 4.4 Block diagram of Simple ISP with background subtraction

- Color correction : Correction by addition and multiplication for each RGB component in the Bayer array
- Color component accumulation : Accumulated value for each RGB component in the Bayer array
- Demosaicing : Interpolation (LI) from Bayer array to Y component
- Noise reduction : Noise reduction for Y component (Median filter)
- Sharpening : Sharpening for Y component (Unsharp masking)
- Gamma correction : Gamma correction for Y component
- Background subtraction : Extraction of moving object by using the background subtraction

4.4.2 API

Simple ISP with background subtraction

Simple ISP that extracts a moving object by using the background subtraction

Configuration data file	r_drp_simple_isp_bg_subtraction_6.dat		
Supported version	1.00		
Configuration data size (byte)	450880		
Header file	r_drp_simple_isp_bg_subtraction.h		
Parameter	Structure name		
	r_drp_simple_isp_bg_subtraction_t		
	Member name	Type	Description
	src	uint32_t	Input image address
	dst1	uint32_t	Moving object extraction image output address
	dst2	uint32_t	Input and output address of background model image
	dst3	uint32_t	Output image (grayscale image) address (When set to 0, no grayscale image is output.)
	width	uint16_t	Image width (16 to 1920, integer multiple of 4)
	height	uint16_t	Image height (4 to 1080, integer multiple of 2)
	component	uint8_t	1: Acquire color component accumulation 0: Do not acquire color component accumulation
	accumulate	uint32_t	The address of area storing the color component accumulation
	area1_offset_x	uint16_t	x coordinate of the start position of the area 1 for color component accumulation
	area1_offset_y	uint16_t	y coordinate of the start position of the area 1 for color component accumulation
	area1_width	uint16_t	Width of the area 1 for color component accumulation
	area1_height	uint16_t	Height of the area 1 for color component accumulation
	area2_offset_x	uint16_t	x coordinate of the start position of the area 2 for color component accumulation
	area2_offset_y	uint16_t	y coordinate of the start position of the area 2 for color component accumulation
	area2_width	uint16_t	Width of the area 2 for color component accumulation
	area2_height	uint16_t	Height of the area 2 for color component accumulation
	area3_offset_x	uint16_t	x coordinate of the start position of the area 3 for color component accumulation
	area3_offset_y	uint16_t	y coordinate of the start position of the area 3 for color component accumulation
	area3_width	uint16_t	Width of the area 3 for color component accumulation
	area3_height	uint16_t	Height of the area 3 for color component accumulation
	bias_r	int8_t	Bias correction value of image (R component) (-128 to 127)
	bias_g	int8_t	Bias correction value of image (G component) (-128 to 127)
	bias_b	int8_t	Bias correction value of image (B component) (-128 to 127)
	gain_r	uint16_t	Gain correction value of image (R component) The upper 4 bits are an integer part, the lower 12 bits are a decimal part.
	gain_g	uint16_t	Gain correction value of image (G component) The upper 4 bits are an integer part, the lower 12 bits are a decimal part.
	gain_b	uint16_t	Gain correction value of image (B component) The upper 4 bits are an integer part, the lower 12 bits are a decimal part.
	blend	uint16_t	Strength of noise reduction (0x000 to 0x100) 0x000: OFF, 0x100: ON (Maximum)
	strength	uint8_t	Sharpening filter emphasis value (0 to 255)
	coring	uint8_t	Sharpening filter coring value (0 to 255)
	gamma	uint8_t	1: Perform gamma correction 0: Do not perform gamma correction

table	uint32_t	LUT address for gamma correction
mean_img_init	uint8_t	1: The background model is initialized. 0: The background model is not initialized.
alpha	uint8_t	The weight of input image at the time of updating the background model (0 to 255) Adjusts the detection accuracy. Setting "alpha" to a high value lowers the accuracy of detection but decreases the possibility of erroneous detection. Setting "alpha" to a low value improves the accuracy of detection but increases the possibility of erroneous detection. For details, refer to the examples.
threshold_latest	uint8_t	Binarization threshold for input image (0 to 255)
threshold_diff	uint8_t	Binarization threshold of the difference image between the input image and background model (0 to 255)
Number of tiles	6	
Segmented processing	Not supported	

Description	Input image
	Same as the input image of 4.2.3 Simple ISP API.
	Output image
	The extracted moving object is output to the dst1 area. The value of the pixels in the area where the moving object is present is set to 255 and those in other areas are set to 0. The image is then output with the image size specified by the parameters "width" and "height". The same address can be specified for "dst1" and "src".
	Background model image (16 BPP grayscale) data are output to the "dst2" area for the image size specified by parameters "width" and "height".
	Grayscale image (8 BPP) data after gamma correction is output to the "dst3" area in the image size specified by parameters "width" and "height".
	Details of each pipeline processing
	Color Component Accumulation
	Same as the color component accumulation of 4.2.3 Simple ISP API.
	Color Correction
	Same as the color correction of 4.2.3 Simple ISP API.
	Demosaicing
	Bayer array is converted to Grayscale by Linear Interpolation method (LI).
	Noise Reduction
	Same as the Noise Reduction of 4.2.3 Simple ISP API.
	Sharpening
	Same as the sharpening of 4.2.3 Simple ISP API.
	Gamma Correction
	Same as the gamma correction of 4.2.3 Simple ISP API.

Background Subtraction

The moving object extraction image is output by comparing the input image after gamma correction and the background model image (the weighted moving average of the past images). The processing details of background subtraction are shown below.

(1) The background model image of past images is read from "dst2", and is updated from the background model image of past images and the input images, then is output to "dst2".

- In case of mean_img_init=1

Updated background model image = Input image

- In case of mean_img_init=0

Updated background model image

$$= ((256 - \alpha) \times (\text{Background model image of past image}) + \alpha \times (\text{Input image})) \div 256$$

(2) The difference image between the input image and background model image is obtained by the following calculation.

$$(\text{difference image}) = |(\text{input image}) - (\text{updated background model image})|$$

(3) The input image is binarized by the threshold (threshold_latest). The difference image is binarized by the threshold (threshold_diff). This function outputs 255 when the input data exceed the threshold, and outputs 0 when the input data are equal to or less than the threshold.

(4) A logical product of the binarized input image and difference image is output to "dst1" as the moving object extraction image.

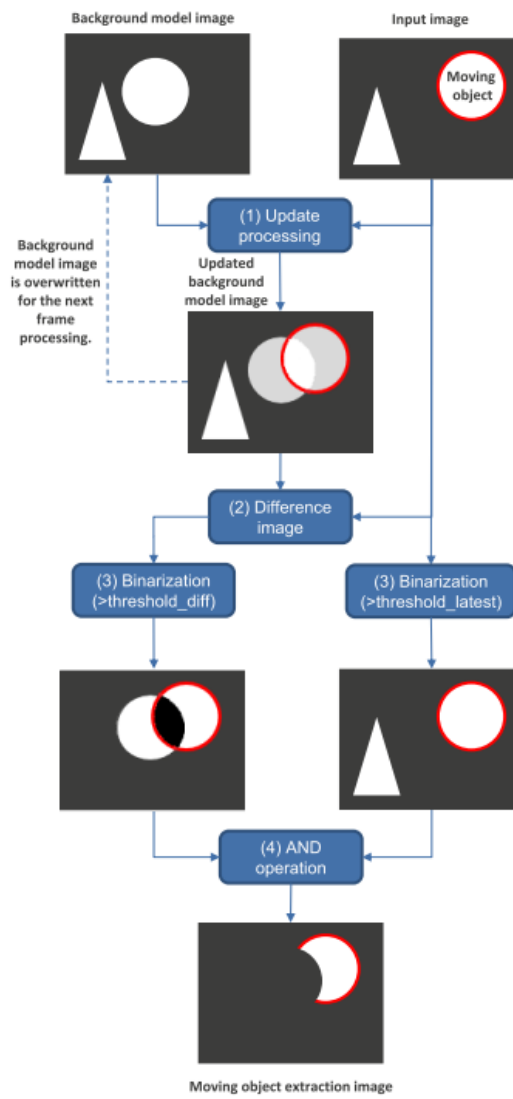

Example

Operation Flow

This function can detect a moving object in a fixed background through setting the background model image arbitrarily, obtaining the difference image between the input image and background model image, and acquiring a logical product of the binarized input image and difference image. A subtle change of background is also available by adjusting the value of "alpha". The flows of the case when the background is fixed and the case when the background is not fixed are shown below.

[The case when the background is fixed]

A moving object can be extracted by setting a fixed image as a background and not updating the background model. Set a value of alpha to 0.

Example of parameter settings:

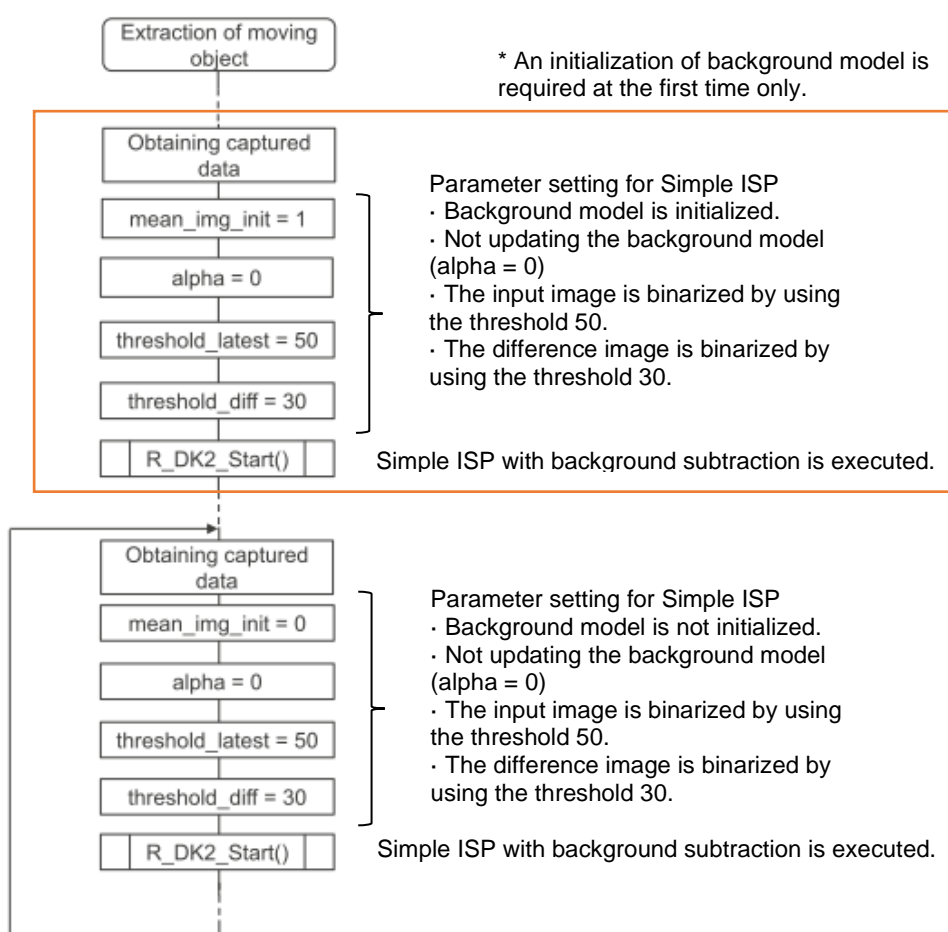

[The case when the background is not fixed]

A moving object can be extracted by updating the background model image for each frame of input image.

Set a value of alpha to a value other than 0. For example, when detecting moving object using a camera, the value of alpha shall be determined by the moving speed of the moving object and the camera.

If the value of alpha is set low, a small motion of the moving object can easily be detected. The detection duration after the moving object stops also becomes long. However, even if the camera moves a little, the possibility of erroneously detecting the motion of background as a moving object becomes high.

If the value of "alpha" is set high, a small motion of the moving object becomes difficult to detect. The detection duration after the moving object stops also becomes short. However, when the camera moves, the possibility of erroneously detecting the motion of background as a moving object becomes low.

Example of parameter settings:

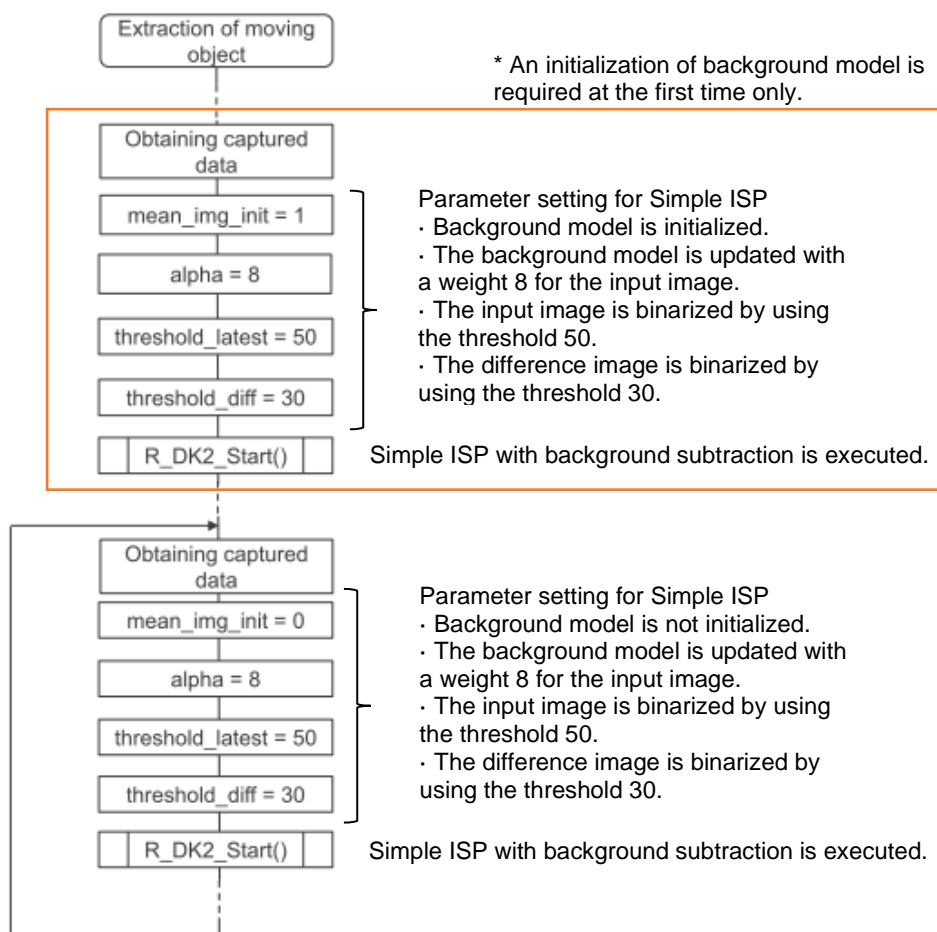

Exposure Control Example

Same as the Exposure Control Example of 4.2.3 Simple ISP API.

Example of White Balance

Same as the Example of White Balance of 4.2.3 Simple ISP API.

Note	None
------	------

4.5 Simple ISP with object detection using sobel

4.5.1 Outline

This function is the Simple ISP that extracts an object having complex contours such as 2D barcodes from multiple objects. A binary image of an object having a complex contour is output by performing a contour extraction by the Sobel filter, emphasis of contour by the Dilate, and deletion of unnecessary contour by the Erode. In this section, an example of pre-processing for 2D barcodes decoding is described. This function performs color correction, color component accumulation, demosaicing, noise reduction, Sobel, binarization, Dilate, and Erode on captured data (Bayer array) stored in the memory. These functions are performed with pipeline processing. The outputs of this function are a binary image obtained by extracting the edge components and a grayscale image of the captured data. AE (automatic exposure control) can be realized by adjusting the gain of the CMOS sensor and the shutter speed on the CPU side by using the color component accumulation value obtained from this function.

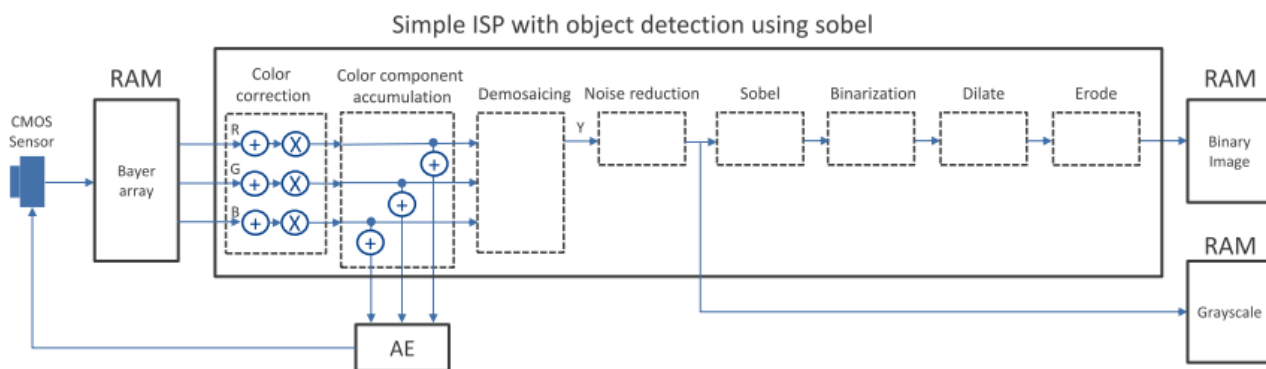

Figure 4.5 Block diagram of Simple ISP with object detection using sobel

- Color correction : Correction by addition and multiplication for each RGB component in the Bayer array
- Color component accumulation : Accumulated value for each RGB component in the Bayer array
- Demosaicing : Interpolation (LI) from Bayer array to Y component
- Noise reduction : Noise reduction for Y component (Median filter)
- Sobel : Contour extraction
- Binarization : Binarization processing
- Dilate : Expansion of the white parts of the binary image
- Erode : Shrinkage of the white parts of the binary image

4.5.2 API

Simple ISP with object detection using sobel

Simple ISP that extracts an object having complex contours from multiple objects

Configuration data file	1) r_drp_simple_isp_obj_det_sobel_6.dat 2) r_drp_simple_isp_obj_det_sobel_4.dat		
Supported version	1.00		
Configuration data size (byte)	1) 350016, 2) 282944		
Header file	r_drp_simple_isp_obj_det_sobel.h		
Parameter	Structure name		
	r_drp_simple_isp_obj_det_sobel_t		
	Member name	Type	Description
	src	uint32_t	Input image address
	dst1	uint32_t	Output image (binary image) address
	dst2	uint32_t	Output image (grayscale image) address (When set to 0, no grayscale image is output.)
	width	uint16_t	Image width (16 to 1920, integer multiple of 2)
	height	uint16_t	Image height (4 to 1080, integer multiple of 2)
	component	uint8_t	1: Acquire color component accumulation 0: Do not acquire color component accumulation
	accumulate	uint32_t	The address of area storing the color component accumulation
	area1_offset_x	uint16_t	x coordinate of the start position of the area 1 for color component accumulation
	area1_offset_y	uint16_t	y coordinate of the start position of the area 1 for color component accumulation
	area1_width	uint16_t	Width of the area 1 for color component accumulation
	area1_height	uint16_t	Height of the area 1 for color component accumulation
	area2_offset_x	uint16_t	x coordinate of the start position of the area 2 for color component accumulation
	area2_offset_y	uint16_t	y coordinate of the start position of the area 2 for color component accumulation
	area2_width	uint16_t	Width of the area 2 for color component accumulation
	area2_height	uint16_t	Height of the area 2 for color component accumulation
	area3_offset_x	uint16_t	x coordinate of the start position of the area 3 for color component accumulation
	area3_offset_y	uint16_t	y coordinate of the start position of the area 3 for color component accumulation
	area3_width	uint16_t	Width of the area 3 for color component accumulation
	area3_height	uint16_t	Height of the area 3 for color component accumulation
	bias_r	int8_t	Bias correction value of image (R component) (-128 to 127)
	bias_g	int8_t	Bias correction value of image (G component) (-128 to 127)
	bias_b	int8_t	Bias correction value of image (B component) (-128 to 127)
	gain_r	uint16_t	Gain correction value of image (R component) The upper 4 bits are an integer part, the lower 12 bits are a decimal part.
	gain_g	uint16_t	Gain correction value of image (G component) The upper 4 bits are an integer part, the lower 12 bits are a decimal part.
	gain_b	uint16_t	Gain correction value of image (B component) The upper 4 bits are an integer part, the lower 12 bits are a decimal part.
	blend	uint16_t	Strength of noise reduction (0x000 to 0x100) 0x000: OFF, 0x100: ON (Maximum)
	threshold	uint8_t	Binarization threshold (0 to 255)
	dilate	uint8_t	Number of iterations of Dilate (0 to 60, integer multiple of 2)
	erode	uint8_t	Number of iterations of Erode (0 to 60, integer multiple of 2)
Number of tiles	1) 6, 2) 4		

Segmented processing Not supported

Description

Input image

Same as the input image of 4.2.3 Simple ISP API.

Output image

Binary image (8 BPP) data are output to the dst1 area for the image size specified by parameters "width" and "height".

Grayscale image (8 BPP) data on which noise reduction processing is performed is output to the dst2 area in the image size specified by parameters "width" and "height".

Details of each pipeline processing**Color Correction**

Same as the color correction of 4.2.3 Simple ISP API.

Color Component Accumulation

Same as the color component accumulation of 4.2.3 Simple ISP API.

Demosaicing

Bayer array is converted to Grayscale by Linear Interpolation method (LI). Linear Interpolation method may cause false color. When performing binarization, such generated false color may cause fine grained noise. The fine grained noise of binary image output to the parameter "dst1" can be eliminated by Dilate and Erode processing. On the other hand, because the grayscale image output to the parameter "dst2" does not contain color components, the influence of noise is small. Therefore, the Linear Interpolation method whose load to the system is small is used for the noise reduction.

Noise Reduction

Same as the Noise Reduction of 4.2.3 Simple ISP API.

Sobel

Emphasis of the edge is performed using Sobel filter.
For details of the Sobel filter, refer to 4.10.4 Sobel.

Binarization

An image is binarized by the threshold (threshold). This function outputs 255 when the input data exceed the threshold, and outputs 0 when the input data are equal to or less than the threshold.

Dilate

This function applies dilation processing the number of times specified in the parameter "dilate".
For details of the Dilate processing, refer to 4.10.7 Dilate.

Erode

This function performs the Erode processing for the number of times specified in the parameter erode.
For details of the Erode processing, refer to 4.10.8 Erode.

Example

Example of Object Detection

This function generates an image suitable for object detection by emphasizing the contour of object having complex contours. An example using this function for pre-processing of 2D barcodes decoding is shown below. Using this function enables to detect the position of 2D barcodes in a short time by decoding only the area where the 2D barcodes exists without searching the whole of image. The parameters "threshold", "dilate", and "erode" shall be adjusted depending on the size of image and the ambient light. Set the parameters "dst_rect_size", "threshold_width", and "threshold_height" of FindContours in consideration of the size of 2D barcodes that is the search target.

[Examples of setting parameters]

- Simple ISP with object detection using sobel (this function)

```
width    = 480
height   = 480
threshold = 64
dilate   = 4
erode    = 10
```

- FindContours

```
dst_rect_size  = 15
threshold_width = 36
threshold_height = 36
```

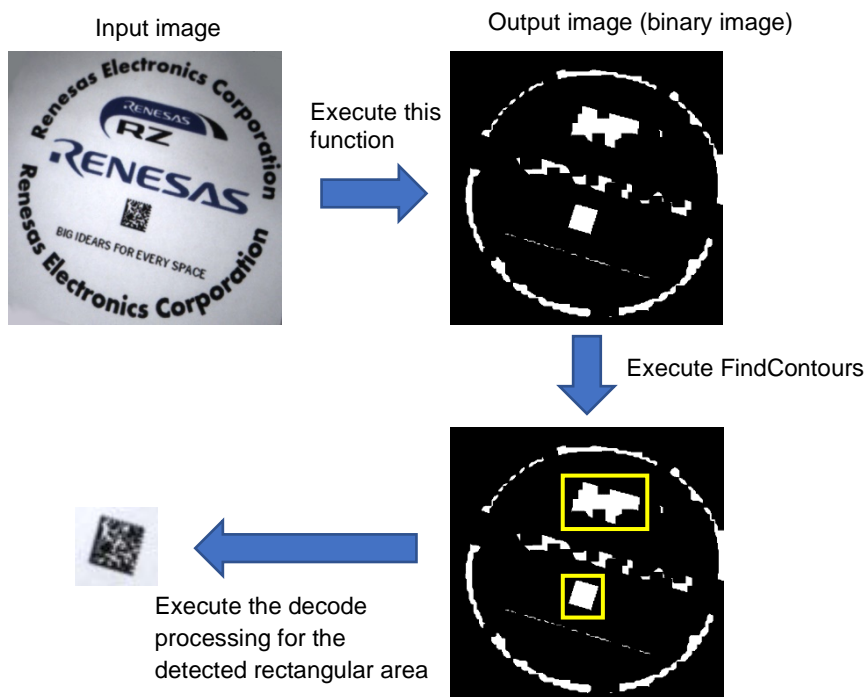

Exposure Control Example

Same as the Exposure Control Example of 4.2.3 Simple ISP API.

Example of White Balance

Same as the Example of White Balance of 4.2.3 Simple ISP API.

Note None

4.6 Simple ISP with distortion correction

4.6.1 Outline

This function is the Simple ISP that performs barrel distortion correction for a wide-angle lens used for short distance capturing by surveillance cameras and video-intercoms. This function performs color correction, color component accumulation, demosaicing, noise reduction, sharpening, Gamma correction, and distortion correction on captured data (Bayer array) stored in the memory. These functions are performed with pipeline processing and output a grayscale image. AE (automatic exposure control) can be realized by adjusting the gain of the CMOS sensor and the shutter speed on the CPU side by using the color component accumulation value obtained from this function.

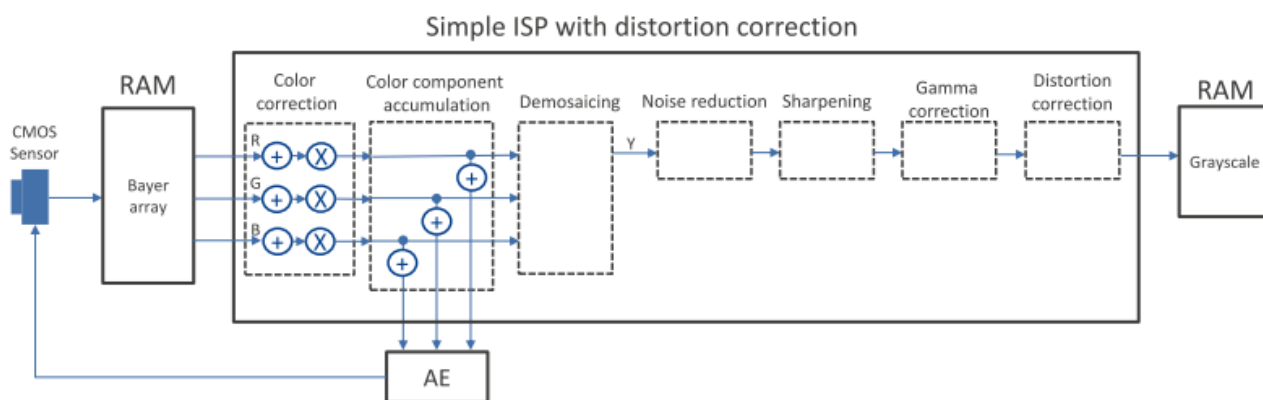

Figure 4.6 Block diagram of Simple ISP with distortion correction

- Color correction : Correction by addition and multiplication for each RGB component in the Bayer array
- Color component accumulation : Accumulated value for each RGB component in the Bayer array
- Demosaicing : Interpolation (LI) from Bayer array to Y component
- Noise reduction : Noise reduction for Y component (Median filter)
- Sharpening : Sharpening for Y component (Unsharp masking)
- Gamma correction : Gamma correction for Y component
- Distortion correction : Barrel distortion correction

4.6.2 API

Simple ISP with distortion correction

Simple ISP that performs barrel distortion correction

Configuration data file	r_drp_simple_isp_distortion_correction_6.dat		
Supported version	1.00		
Configuration data size (byte)	699776		
Header file	r_drp_simple_isp_distortion_correction.h		
Parameter	Structure name		
	r_drp_simple_isp_distortion_correction_t		
	Member name	Type	Description
	src	uint32_t	Input image address
	dst	uint32_t	Output image address
	width	uint16_t	Image width (16 to 1280, integer multiple of 2)
	height	uint16_t	Image height (4 to 960, integer multiple of 8)
	component	uint8_t	1: Acquire color component accumulation 0: Do not acquire color component accumulation
	accumulate	uint32_t	The address of area storing the color component accumulation
	area1_offset_x	uint16_t	x coordinate of the start position of the area 1 for color component accumulation
	area1_offset_y	uint16_t	y coordinate of the start position of the area 1 for color component accumulation
	area1_width	uint16_t	Width of the area 1 for color component accumulation
	area1_height	uint16_t	Height of the area 1 for color component accumulation
	area2_offset_x	uint16_t	x coordinate of the start position of the area 2 for color component accumulation
	area2_offset_y	uint16_t	y coordinate of the start position of the area 2 for color component accumulation
	area2_width	uint16_t	Width of the area 2 for color component accumulation
	area2_height	uint16_t	Height of the area 2 for color component accumulation
	area3_offset_x	uint16_t	x coordinate of the start position of the area 3 for color component accumulation
	area3_offset_y	uint16_t	y coordinate of the start position of the area 3 for color component accumulation
	area3_width	uint16_t	Width of the area 3 for color component accumulation
	area3_height	uint16_t	Height of the area 3 for color component accumulation
	bias_r	int8_t	Bias correction value of image (R component) (-128 to 127)
	bias_g	int8_t	Bias correction value of image (G component) (-128 to 127)
	bias_b	int8_t	Bias correction value of image (B component) (-128 to 127)
	gain_r	uint16_t	Gain correction value of image (R component) The upper 4 bits are an integer part, the lower 12 bits are a decimal part.
	gain_g	uint16_t	Gain correction value of image (G component) The upper 4 bits are an integer part, the lower 12 bits are a decimal part.
	gain_b	uint16_t	Gain correction value of image (B component) The upper 4 bits are an integer part, the lower 12 bits are a decimal part.
	blend	uint16_t	Strength of noise reduction (0x000 to 0x100) 0x000: OFF, 0x100: ON (Maximum)
	strength	uint8_t	Sharpening filter emphasis value (0 to 255)
	coring	uint8_t	Sharpening filter coring value (0 to 255)
	gamma	uint8_t	1: Perform gamma correction 0: Do not perform gamma correction
	table	uint32_t	LUT address for gamma correction

work	uint32_t	Work area address Area used for distortion correction Data size: (width) × (distortion_wl) + 2 bytes (maximum value)
distortion	uint16_t	Barrel distortion correction coefficient (0 to 65535) 3000 or less is recommended.
distortion_wl	uint16_t	Height of the work area ((height)/2+(distortion_oy)), integer multiple of 4)
distortion_ox	int16_t	X-coordinate value of the center point for the barrel distortion correction - The x-coordinate value of the center point of the input image (a value in the range of "width" ±20% is recommended.) Refer to the description for details.
distortion_oy	int16_t	Y-coordinate value of the center point for the barrel distortion correction - The y-coordinate value of the center point of the input image (a value in the range of "height" ±20% is recommended.) Refer to the description for details.
Number of tiles	6	
Segmented processing	Not supported	

Description	Input image
	Same as the input image of 4.2.3 Simple ISP API.
	Output image
	Grayscale image (8 BPP) data are output to the “dst” area for the image size specified by parameters “width” and “height”.
	Details of each pipeline processing
	Color Component Accumulation
	Same as the color component accumulation of 4.2.3 Simple ISP API.
	Color Correction
	Same as the color correction of 4.2.3 Simple ISP API.
	Demosaicing
Bayer array is converted to Grayscale by Linear Interpolation method (LI).	
Noise Reduction	
Same as the Noise Reduction of 4.2.3 Simple ISP API.	
Sharpening	
Same as the sharpening of 4.2.3 Simple ISP API.	
Gamma Correction	
Same as the gamma correction of 4.2.3 Simple ISP API.	

Distortion Correction

The distortion correction function corrects images with a barrel-shape like form of distortion in which the image appears to expand from the middle portion. The level of distortion in the middle part is relatively low, but the further from the center a point is, the greater the distortion becomes. Accordingly, the further from the center a point is, the more the point has to be moved away from the edges to correct the image. This function is based on the assumption of a level of distortion as is shown in the example of distortion correction. This function is not suitable for correcting images having large levels of spatial distortion, such as those from fisheye-lens.

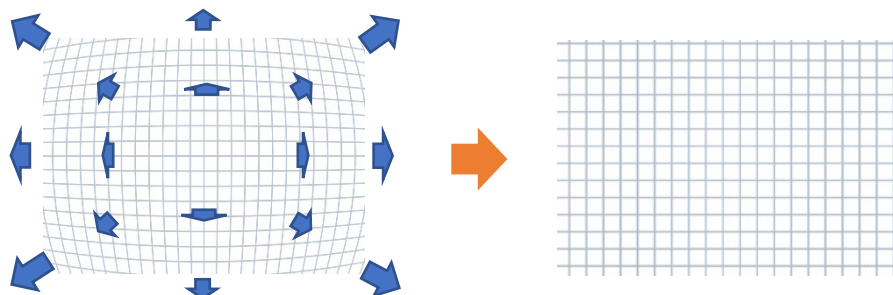
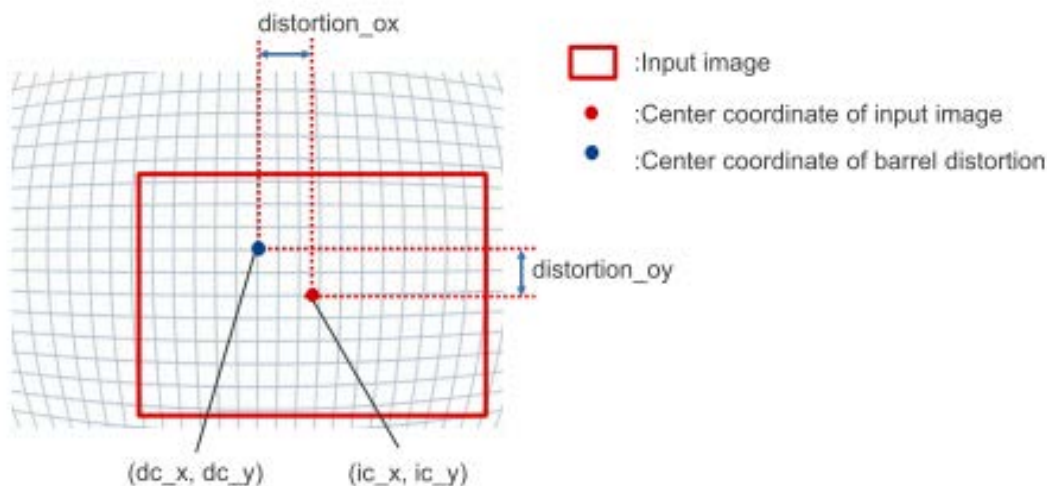

Figure 4.7 Simplified representation of distortion correction

The difference of the center coordinates between the input image and barrel distortion shall be specified to the parameters “distortion_ox” and “distortion_oy” for distortion correction. When the center coordinate of input image is (ic_x, ic_y) and the center coordinate of barrel distortion is (dc_x,dc_y), the values of “distortion_ox” and “distortion_oy” are shown below.

$$\text{distortion_ox} = \text{dc_x} - \text{ic_x}$$

$$\text{distortion_oy} = \text{dc_y} - \text{ic_y}$$



Example

Examples of Distortion Correction

The distortion correction of this function corrects distortion of image by adjusting the values of parameters “distortion”, “distortion_ox”, and “distortion_oy”. Capture an image in which distortion is visible such as a chess board, and adjust the values of parameters until the distortion of the output image is eliminated.

The examples of distortion correction performed by this function are shown below for reference.

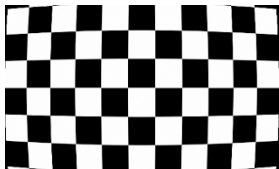
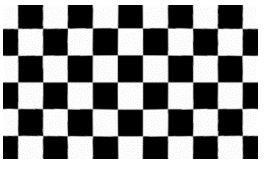
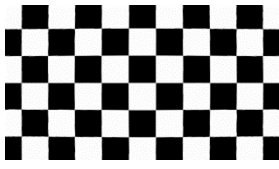
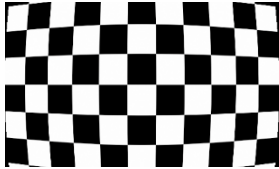
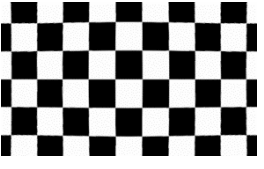
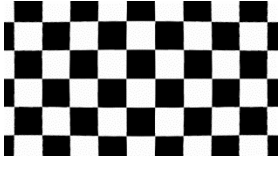
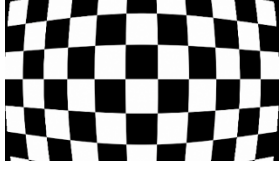
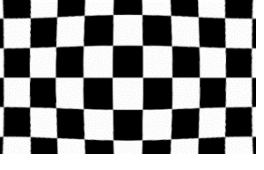
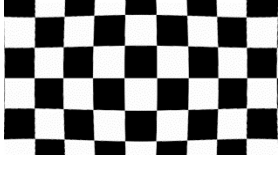
Distortion	Input image	Output image after distortion correction	
		Image size (800*480)	Image size (1280*720)
Low  High		 distortion=1600	 distortion=600
		 distortion=2300	 distortion=950
		 distortion=3000	 distortion=1350

The examples shown above are the cases that the parameters “distortion_ox” and “distortion_oy” are 0. If the distortion cannot be corrected even if the value of “distortion” is set referencing the values shown in the examples, the center coordinate of barrel distortion might be different from the center of image. Change the values of “distortion_ox” and “distortion_oy” for performing the correction.

Exposure Control Example

Same as the Exposure Control Example of 4.2.3 Simple ISP API.

Example of White Balance

Same as the Example of White Balance of 4.2.3 Simple ISP API.

Note	None
------	------

4.7 Simple ISP with scaling and normalization (32bit)

4.7.1 Outline

This function is the Simple ISP that implements pre-processing for AI inference. The pre-processing mentioned above includes floating-point conversion, normalization, and resizing. By using this function only, users can realize the functions from the CMOS sensor input to obtaining the image in which the pre-processing for AI inference is performed. This function performs color correction, color component accumulation, demosaicing, noise reduction, sharpening, Gamma correction, color conversion, resizing, normalization, floating-point conversion, etc. on captured data (Bayer array) stored in the memory and outputs ARGB image for display and RGB image for AI processing. These functions are performed with pipeline processing. AE (automatic exposure control) can be realized by adjusting the gain of the CMOS sensor and the shutter speed on the CPU side by using the color component accumulation value obtained from this function.

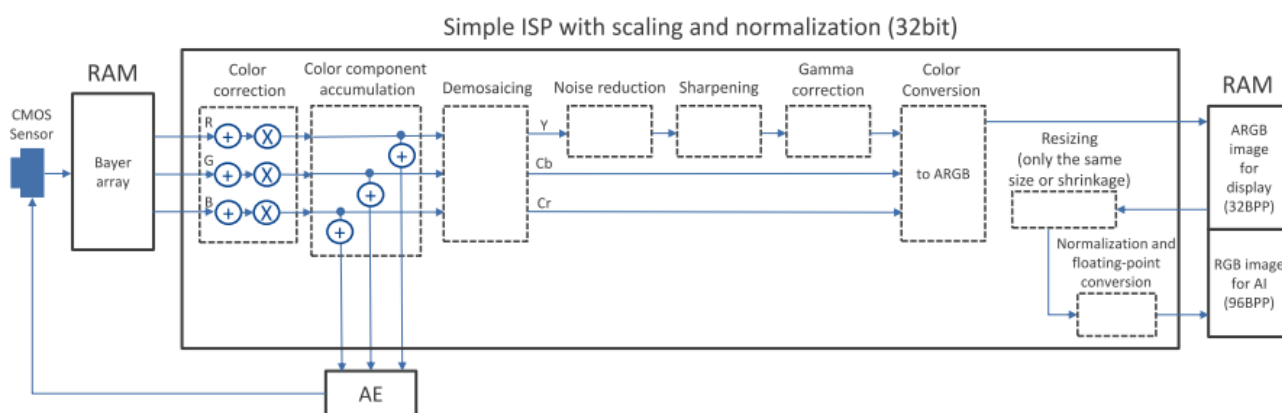

Figure 4.8 Block diagram of Simple ISP with scaling and normalization (32bit)

- Color correction : Correction by addition and multiplication for each RGB component in the Bayer array
- Color component accumulation : Accumulated value for each RGB component in the Bayer array
- Demosaicing : Interpolation (ACPI) from Bayer array to YCbCr component
- Noise reduction : Noise reduction for Y component (Median filter)
- Sharpening : Sharpening for Y component (Unsharp masking)
- Gamma correction : Gamma correction for Y component
- Color conversion : ARGB conversion processing for YCbCr component (The A part is fixed to 255.)
- Resizing : Resizing processing for the RGB component (only the same size or shrinkage) (Bilinear interpolation)
- Normalization, floating-point conversion : Normalization and floating-point conversion processing for the resized result.

4.7.2 API

Simple ISP with scaling and normalization (32bit)

Simple ISP that implements pre-processing (floating-point conversion, normalization, and resizing) for AI inference

Configuration data file	r_drp_simple_isp_scal_normaliz_b32_6.dat		
Supported version	1.00		
Configuration data size (byte)	691840		
Header file	r_drp_simple_isp_scal_normaliz_b32.h		
Parameter	Structure name		
	r_drp_simple_isp_scal_normaliz_b32_t		
	Member name	Type	Description
	src	uint32_t	Input image address
	dst_mode	uint8_t	0: Outputs the output image (RGB image for AI) in the Packed format. 1: Outputs the output image (RGB image for AI) in the Planar format.
	dst1	uint32_t	Output image (ARGB image for display) address
	dst2	uint32_t	Output image (RGB image for AI) address In case of dst_mode=0, the RGB component is output in the Packed format. In case of dst_mode=1, the R component is output in the Planar format.
	dst3	uint32_t	Output image (RGB image for AI) address In case of dst_mode=0, no output is generated. In case of dst_mode=1, the G component of the Planar format is output.
	dst4	uint32_t	Output image (RGB image for AI) address In case of dst_mode=0, no output is generated. In case of dst_mode=1, the B component of the Planar format is output.
	src_width	uint16_t	Input image width (16 to 1920, integer multiple of 2)
	src_height	uint16_t	Image height (4 to 1080, integer multiple of 2)
	dst_width	uint16_t	Image width after resizing (16 to src_width, integer multiple of 2)
	dst_height	uint16_t	Image height after resizing (4 to src_height, integer multiple of 2)
	component	uint8_t	1: Acquire color component accumulation 0: Do not acquire color component accumulation
	accumulate	uint32_t	The address of area storing the color component accumulation
	area1_offset_x	uint16_t	x coordinate of the start position of the area 1 for color component accumulation
	area1_offset_y	uint16_t	y coordinate of the start position of the area 1 for color component accumulation
	area1_width	uint16_t	Width of the area 1 for color component accumulation
	area1_height	uint16_t	Height of the area 1 for color component accumulation
	area2_offset_x	uint16_t	x coordinate of the start position of the area 2 for color component accumulation
	area2_offset_y	uint16_t	y coordinate of the start position of the area 2 for color component accumulation
	area2_width	uint16_t	Width of the area 2 for color component accumulation
	area2_height	uint16_t	Height of the area 2 for color component accumulation
	area3_offset_x	uint16_t	x coordinate of the start position of the area 3 for color component accumulation
	area3_offset_y	uint16_t	y coordinate of the start position of the area 3 for color component accumulation
	area3_width	uint16_t	Width of the area 3 for color component accumulation
	area3_height	uint16_t	Height of the area 3 for color component accumulation

bias_r	int8_t	Bias correction value of image (R component) (-128 to 127)
bias_g	int8_t	Bias correction value of image (G component) (-128 to 127)
bias_b	int8_t	Bias correction value of image (B component) (-128 to 127)
gain_r	uint16_t	Gain correction value of image (R component) The upper 4 bits are an integer part, the lower 12 bits are a decimal part.
gain_g	uint16_t	Gain correction value of image (G component) The upper 4 bits are an integer part, the lower 12 bits are a decimal part.
gain_b	uint16_t	Gain correction value of image (B component) The upper 4 bits are an integer part, the lower 12 bits are a decimal part.
blend	uint16_t	Strength of noise reduction (0x000 to 0x100) 0x000: OFF, 0x100: ON (Maximum)
strength	uint8_t	Sharpening filter emphasis value (0 to 255)
coring	uint8_t	Sharpening filter coring value (0 to 255)
gamma	uint8_t	1: Perform gamma correction 0: Do not perform gamma correction
table	uint32_t	LUT address for gamma correction
r_table	uint32_t	LUT address used for normalization and floating-point conversion of R component
g_table	uint32_t	LUT address used for normalization and floating-point conversion of G component
b_table	uint32_t	LUT address used for normalization and floating-point conversion of B component
Number of tiles	6	
Segmented processing	Not supported	

Description

Input image

Same as the input image of 4.2.3 Simple ISP API.

Output image

ARGB (32 BPP) data are output to the dst1 area for the image size specified by parameters "src_width" and "src_height".

Output format of ARGB:

A0, R0, G0, B0, A1, R1, G1, B1.....

(An, Rn, Gn, Bn: Brightness of each color of the n-th pixel, An is fixed to 255.)

When dst_mode=0, RGB (96 BPP) data that are normalized and floating-point-converted according to the color components of an LUT space is output to the dst2 area with the image size specified by parameters "dst_width" and "dst_height".

RGB output format of dst2 in case of dst_mode=0:

R0, G0, B0, R1, G1, B1.....

(Rn, Gn, Bn: The brightness of each color of the n-th pixel)

In case of dst_mode=1, RGB (96 BPP) data that is normalized and floating-point-converted by each color component of LUT is output in the image size specified by parameters "dst_width" and "dst_height". R component is output to the dst2 area, G component is output to the dst3 area, and B component is output to the dst4 area.

dst2 output format in case of dst_mode=1:

R0, R1, R2, R3.....

dst3 output format in case of dst_mode=1:

G0, G1, G2, G3.....

dst4 output format in case of dst_mode=1:

B0, B1, B2, B3.....

(Rn, Gn, Bn: The brightness of each color of the n-th pixel)

Details of each pipeline processing**Color Component Accumulation**

Same as the color component accumulation of 4.2.3 Simple ISP API.

Color Correction

Same as the color correction of 4.2.3 Simple ISP API.

Demosaicing

Bayer array is converted to YCbCr422 by Adaptive Color Plane Interpolation method (ACPI).

Noise Reduction

Same as the of Noise Reduction of 4.2.3 Simple ISP API.

Sharpening

Same as the sharpening of 4.2.3 Simple ISP API.

Gamma Correction

Same as the gamma correction of 4.2.3 Simple ISP API.

Color Conversion

YCbCr is converted to ARGB.

Resizing

Resizing to the size specified the parameters "dst_width" and "dst_height" is performed for the RGB component of the image output to the dst1 area using the bilinear interpolation algorithm. For details, refer to 4.9.13 ResizeBilinear.

Normalization and Floating-point Conversion

Normalization and floating-point conversion are performed for the RGB values (0 to 255) of each pixel after resizing by referencing the data of conversion table.

Store the R component conversion table to the address specified with the parameter r_table. Store the G component conversion table to the address specified with the parameter g_table. Store the B component conversion table to the address specified with the parameter b_table. The pixel value is converted by referring the LUT, which is specified by "table" with values from 0 to 255.

Example**Example of Creating Conversion Table for Normalization and Floating-point Conversion**

Example of creating conversion table for normalization and floating-point conversion is shown below. Following is an example in which a pixel data with the range of 0 to 255 is converted into the range of 0.0 to 1.0. A data with an average 0.485 and a standard deviation 0.229 is converted into the data with an average 0 and a variance 1.

```
int luminance;
float mean = 0.485;
float stddev = 0.229;
float normalize;

for (luminance = 0;luminance < 256;luminance++)
{
    normalize = ((float)luminance / 255 - mean) / stddev; // min-max and z-score normalization
}
```

Exposure Control Example

Same as the Exposure Control Example of 4.2.3 Simple ISP API.

Example of White Balance

Same as the Example of White Balance of 4.2.3 Simple ISP API.

Note

None

4.8 Simple ISP with color calibration and 3DNR

4.8.1 Outline

This function is the Simple ISP that specializes in outputting an image having high color-reproducibility through the color-matrix correction and 3D noise reduction. This can be used to obtain image having high color-reproducibility which is suitable for AI processing, and images having a more natural color representation to the naked eye. This function performs bias correction, color component accumulation, demosaicing, gain correction, color-matrix correction, noise reduction, sharpening, Gamma correction, and 3D noise reduction on captured data (Bayer array) stored in the memory and outputs an image with YCbCr422 format. These functions are performed with pipeline processing. AE (automatic exposure control) can be realized by adjusting the gain of the CMOS sensor and the shutter speed on the CPU side by using the color component accumulation value obtained from this function.

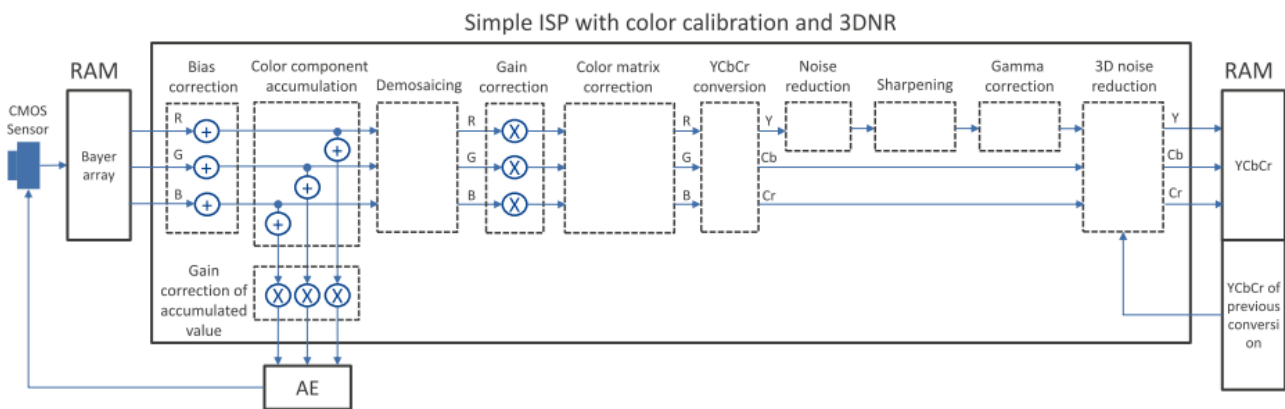

Figure 4 1 Block diagram of Simple ISP with color calibration and 3DNR

- Bias correction : Correction by addition for each RGB component in the Bayer array
- Color component accumulation : Accumulated value for each RGB component in the Bayer array
- Gain correction for accumulated value : Correction by multiplication for the accumulated values of each RGB component in the Bayer array
- Demosaicing : Interpolation from Bayer array to RGB component
- Gain correction : Correction by multiplication for each RGB component after demosaicing
- Color matrix correction : Color correction for RGB component by 3×3 transformation matrix
- YCbCr conversion : Conversion processing of RGB component into YCbCr component
- Noise reduction : Noise reduction for Y component (Median filter)
- Sharpening : Sharpening for Y component (Unsharp masking)
- Gamma correction : Gamma correction for Y component
- 3D noise reduction : Noise reduction processing for YCbCr component using the previous YCbCr image

4.8.2 API

Simple ISP with color calibration and 3DNR

Simple ISP that specializes in the output of images having high color-reproducibility through color-matrix correction and 3D noise reduction

Configuration data file	r_drp_simple_isp_colcal_3dnr_6.dat		
Supported version	1.00		
Configuration data size (byte)	560192		
Header file	r_drp_simple_isp_colcal_3dnr.h		
Parameter	Structure name		
	r_drp_simple_isp_colcal_3dnr_t		
	Member name	Type	Description
	src	uint32_t	Input image address
	prev	uint32_t	Address of the output image of previous frame (When set to 0, no 3D noise reduction processing is performed.)
	dst	uint32_t	Output image address
	width	uint16_t	Image width (16 to 1920, integer multiple of 2)
	height	uint16_t	Image height (4 to 1080, integer multiple of 2)
	component	uint8_t	1: Acquire color component accumulation 0: Do not acquire color component accumulation
	accumulate	uint32_t	The address of area storing the color component accumulation
	area1_offset_x	uint16_t	x coordinate of the start position of the area 1 for color component accumulation
	area1_offset_y	uint16_t	y coordinate of the start position of the area 1 for color component accumulation
	area1_width	uint16_t	Width of the area 1 for color component accumulation
	area1_height	uint16_t	Height of the area 1 for color component accumulation
	area2_offset_x	uint16_t	x coordinate of the start position of the area 2 for color component accumulation
	area2_offset_y	uint16_t	y coordinate of the start position of the area 2 for color component accumulation
	area2_width	uint16_t	Width of the area 2 for color component accumulation
	area2_height	uint16_t	Height of the area 2 for color component accumulation
	area3_offset_x	uint16_t	x coordinate of the start position of the area 3 for color component accumulation
	area3_offset_y	uint16_t	y coordinate of the start position of the area 3 for color component accumulation
	area3_width	uint16_t	Width of the area 3 for color component accumulation
	area3_height	uint16_t	Height of the area 3 for color component accumulation
	bias_r	int8_t	Bias correction value of image (R component) (-128 to 127) -16 is the recommended value.
	bias_g	int8_t	Bias correction value of image (G component) (-128 to 127) -16 is the recommended value.
	bias_b	int8_t	Bias correction value of image (B component) (-128 to 127) -16 is the recommended value.

gain_r	uint16_t	A value of the gain correction value of image (R component) converted to fixed-point format The specification of fixed-point format is shown in the figure below.
gain_g	uint16_t	0x2315 is the recommended value. A value of the gain correction value of image (G component) converted to fixed-point format The fixed-point format is the same as that of gain_r. 0x1800 is the recommended value.
gain_b	uint16_t	A value of the gain correction value of image (B component) converted to fixed-point format The fixed-point format is the same as that of gain_r. 0x2a64 is the recommended value.
blend	uint16_t	Strength of noise reduction (0x000 to 0x100) 0x000: OFF, 0x100: ON (Maximum)
strength	uint8_t	Sharpening filter emphasis value (0 to 255)
coring	uint8_t	Sharpening filter coring value (0 to 255)
gamma	uint8_t	1: Perform gamma correction 0: Do not perform gamma correction
table	uint32_t	LUT address for gamma correction
matrix_c11	int16_t	Value of the element at row 1 column 1 of the color matrix correction transformation matrix converted to fixed-point format The specification of fixed-point format is shown in the figure below.
matrix_c12	int16_t	0x3b8b is the recommended value. Value of element at row 1 column 2 of the color matrix correction transformation matrix converted to fixed-point format The fixed-point format is the same as that of matrix_c11. 0xeaf1 is the recommended value.
matrix_c13	int16_t	Value of element at row 1 column 3 of the color matrix correction transformation matrix converted to fixed-point format The fixed-point format is the same as that of matrix_c11. 0xf405 is the recommended value.
matrix_c21	int16_t	Value of element at row 2 column 1 of the color matrix correction transformation matrix converted to fixed-point format The fixed-point format is the same as that of matrix_c11. 0xf726 is the recommended value.

matrix_c22	int16_t	Value of element at row 2 column 2 of the color matrix correction transformation matrix converted to fixed-point format The fixed-point format is the same as that of matrix_c11. 0x2fdf is the recommended value.
matrix_c23	int16_t	Value of element at row 2 column 3 of the color matrix correction transformation matrix converted to fixed-point format The fixed-point format is the same as that of matrix_c11. 0xf84d is the recommended value.
matrix_c31	int16_t	Value of element at row 3 column 1 of the color matrix correction transformation matrix converted to fixed-point format The fixed-point format is the same as that of matrix_c11. 0x0182 is the recommended value.
matrix_c32	int16_t	Value of element at row 3 column 2 of the color matrix correction transformation matrix converted to fixed-point format The fixed-point format is the same as that of matrix_c11. 0xc9c5 is the recommended value.
matrix_c33	int16_t	Value of element at row 3 column 3 of the color matrix correction transformation matrix converted to fixed-point format The fixed-point format is the same as that of matrix_c11. 0x5c3a is the recommended value.
y_coef	uint8_t	Coefficient (0 to 64) that indicates the ratio of Y signal differences when calculating Y-motion information in 3D noise reduction 64 is the recommended value. Refer to the description for details.
c_coef	uint8_t	Coefficient (0 to 64) that indicates the ratio of Y signal difference when calculating C-motion information in 3D noise reduction 32 is the recommended value. Refer to the description for details.
y_alpha_max	uint8_t	Maximum value of Y-correlation coefficient for 3D noise reduction (0 to 255) 128 is the recommended value. Refer to the description for details.
y_thresh_a	uint16_t	Threshold value (0 to 511) of Y-motion information in which Y-correlation coefficient becomes maximum value in 3D noise reduction 8 is the recommended value. Refer to the description for details.
y_thresh_b	uint16_t	Threshold value (0 to 511) of Y-motion information in which Y-correlation coefficient becomes 0 in 3D noise reduction 16 is the recommended value. Refer to the description for details.
y_tilt	uint16_t	Constant of proportionality (0 to 4095) used for calculating Y-correlation coefficient in 3D noise reduction 512 is the recommended value. Refer to the description for details.
c_alpha_max	uint8_t	Maximum value of C-correlation coefficient in 3D noise reduction (0 to 255) 128 is the recommended value. Refer to the description for details.
c_thresh_a	uint16_t	Threshold value (0 to 511) of C-motion information in which C-correlation coefficient becomes maximum value in 3D noise reduction 8 is the recommended value. Refer to the description for details.

	c_thresh_b	uint16_t	Threshold value (0 to 511) of C-motion information in which C-correlation coefficient becomes 0 in 3D noise reduction 16 is the recommended value. Refer to the description for details.
	c_tilt	uint16_t	Constant of proportionality (0 to 4095) used for calculating C-correlation coefficient in 3D noise reduction 512 is the recommended value. Refer to the description for details.
Number of tiles	6		
Segmented processing	Not supported		

Description **Input image**

With regard to the src area, the input image is the same as the input image of 4.2.3 Simple ISP API.

Output image

YCbCr422 (16 BPP) data are output to the dst area for the image size specified by parameters "width" and "height".

Output format of YCbCr422

CB0, Y0, CR0, Y1, CB2, Y2, CR2, Y3

(Yn, CBn, CRn: The brightness and color difference values of the n-th pixel)

Output image of previous frame

When the 3D noise reduction is used, an address having the same image size as the dst area shall be specified to the prev area.

The same address can be specified to the prev and dst areas. When the same address is specified to the prev and dst areas, memory consumption can be reduced. However, the data of dst area cannot be rewritten. When different addresses are specified to the prev and dst areas, the data of dst area can be rewritten, however, the data of prev area cannot be rewritten.

3D noise reduction processing reduces high-sensitivity noise by using the input image (src) and the previous frame output image (prev), and by performing calculation and mixing processing of the motion information and correlation coefficient.

Details of each pipeline processing**Bias Correction**

The values set by the parameters bias_r, bias_g, and bias_b are added to each RGB component of Bayer array.

Color Component Accumulation

Same as the color component accumulation of 4.2.3 Simple ISP API.

Demosaicing

Bayer array is converted to RGB by Adaptive Color Plane Interpolation method (ACPI).

Gain Correction

The values set by the parameters gain_r, gain_g, and gain_b are multiplied by each RGB component that is the result of conversion by demosaicing or the cumulative result of each RGB component in a Bayer array.

Color Matrix Correction

Color matrix correction involves the conversion of each RGB component R_{in} , G_{in} , and B_{in} into R_{out} , G_{out} , and B_{out} by using a 3×3 transformation matrix as shown in the following figure.

$$\begin{pmatrix} R_{out} \\ G_{out} \\ B_{out} \end{pmatrix} = \begin{pmatrix} matrix_c11 & matrix_c12 & matrix_c13 \\ matrix_c21 & matrix_c22 & matrix_c23 \\ matrix_c31 & matrix_c32 & matrix_c33 \end{pmatrix} \begin{pmatrix} R_{in} \\ G_{in} \\ B_{in} \end{pmatrix}$$

YCbCr Conversion

YCbCr conversion converts RGB into YCbCr.

Noise Reduction

Same as the Noise Reduction of 4.2.3 Simple ISP API.

Sharpening

Same as the sharpening of 4.2.3 Simple ISP API.

Gamma Correction

Same as the gamma correction of 4.2.3 Simple ISP API.

3D Noise Reduction

This function reduces high-sensitivity noise of a video data. This function performs calculation of motion information and correlation coefficient and mixing processing for the current frame input image and previous frame output image. The block diagram and details of the processing are described below.

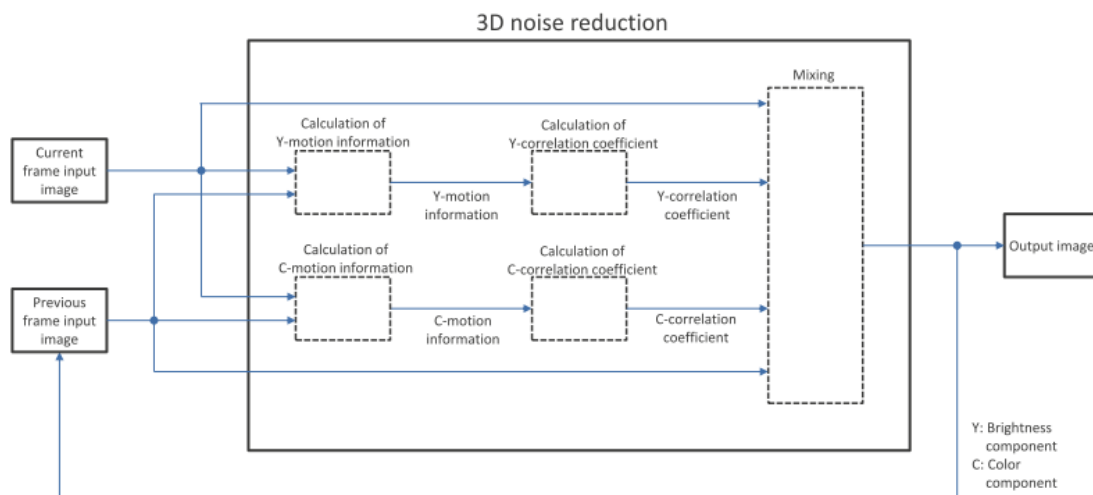

(1) Calculation of Y-motion information

Y-motion information at n-th pixel with the brightness Y_n is calculated by the following calculation formula.

$$Y\text{-motion information} = (Y\text{-signal difference} \times y_coef + C\text{-signal difference} \times (64 - y_coef)) / 64$$

- $Y\text{-signal difference} = |Current\ frame\ input\ Y_n - Previous\ frame\ output\ Y_n|$

- $C\text{-signal difference} = |Current\ frame\ input\ CB((n>>1)<<1) - Previous\ frame\ output\ CB((n>>1)<<1)| + |Current\ frame\ input\ CR((n>>1)<<1) - Previous\ frame\ output\ CR((n>>1)<<1)|$

(2) Calculation of C-motion information

C-motion information of color differences CB_n and CR_n at the n-th pixel is calculated using the following calculation formula.

$$C\text{-motion information} = (Y\text{-signal difference} \times c_coef + C\text{-signal difference} \times (64 - c_coef)) / 64$$

- $Y\text{-signal difference} = (|Current\ frame\ input\ Y_n - Previous\ frame\ output\ Y_n| + |Current\ frame\ input\ Y(n+1) - Previous\ frame\ output\ Y(n+1)|) / 2$

- $C\text{-signal difference} = |Current\ frame\ input\ CB_n - Previous\ frame\ output\ CB_n| + |Current\ frame\ input\ CR_n - Previous\ frame\ output\ CR_n|$

(3) Calculation of Y-correlation coefficient

Using Y-motion information calculated in (1), Y-correlation coefficient to indicate the ratio of mixing Y_n of the current frame input image and the previous frame output image is calculated on the basis of the following graph.

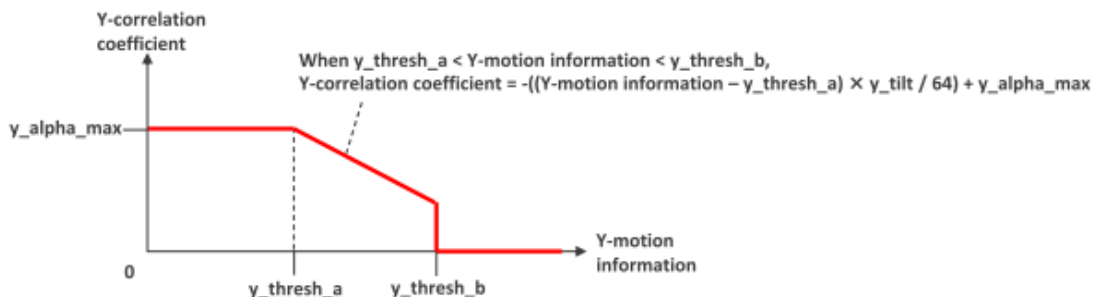

(4) Calculation of C-correlation coefficient

Using C-motion information calculated in (2), C-correlation coefficient to indicate the ratio of mixing CB_n and CR_n of the current frame input image and the previous frame output image is calculated on the basis of the following graph.

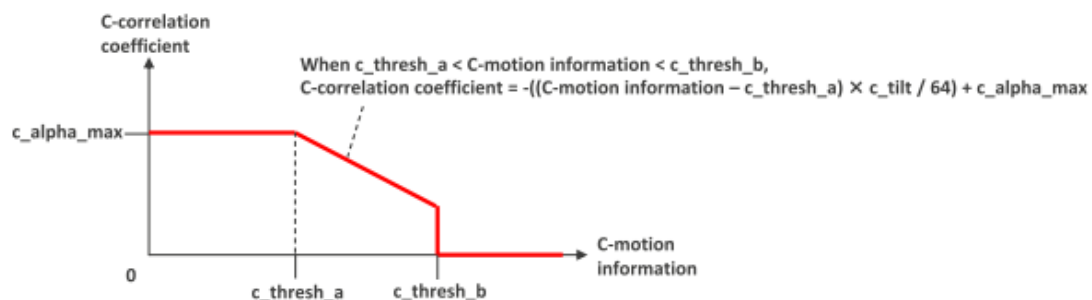

(5) Mixing

On the basis of the correlation coefficient, the current frame input data and the previous frame output data are mixed using the following calculation formula.

$$\begin{aligned}
 Y \text{ output data} &= (\text{Previous frame output } Y_n \times Y \text{ correlation coefficient} + \\
 &\quad \text{Current frame input } Y_n \times (256 - Y \text{ correlation coefficient})) / 256 \\
 CB \text{ output data} &= (\text{Previous frame output } CB_n \times C \text{ correlation coefficient} + \\
 &\quad \text{Current frame input } CB_n \times (256 - C \text{ correlation coefficient})) / 256 \\
 CR \text{ output data} &= (\text{Previous frame output } CR_n \times C \text{ correlation coefficient} + \\
 &\quad \text{Current frame input } CR_n \times (256 - C \text{ correlation coefficient})) / 256
 \end{aligned}$$

Example

Example of Color Matrix Correction

This function performs the color matrix correction using the 3×3 transformation matrix. An example that Raspberry Pi Camera V2 is used and the recommended values are set to the parameters `matrix_cmn` (mn: 11, 12, 13, 21, 22, 23, 31, 32, 33) is shown below. The parameters shall be adjusted in accordance with the camera to use.

[Parameter Settings]

```
matrix_c11 = 0x3b8b
matrix_c12 = 0xeaf1
matrix_c13 = 0xf405
matrix_c21 = 0xf726
matrix_c22 = 0x2fdf
matrix_c23 = 0xf84d
matrix_c31 = 0x0182
matrix_c32 = 0xc9c5
matrix_c33 = 0x5c3a
```

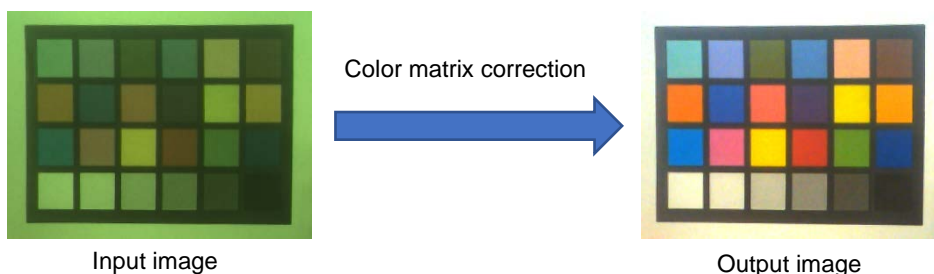

Example of 3D Noise Reduction

The 3D noise reduction of this function performs the noise reduction using the output image of previous time. An example of performing the 3D noise reduction is shown below. Because the recommended values of parameters for the 3D noise reduction of this function are suited for reducing the high-sensitivity noise of video data, the correction width for still image becomes small.

[Parameter Settings] (setting the recommended values)

```
y_coef = 64
c_coef = 32
y_alpha_max = 128
y_thresh_a = 8
y_thresh_b = 16
y_tilt = 512
c_alpha_max = 128
c_thresh_a = 8
c_thresh_b = 16
c_tilt = 512
```

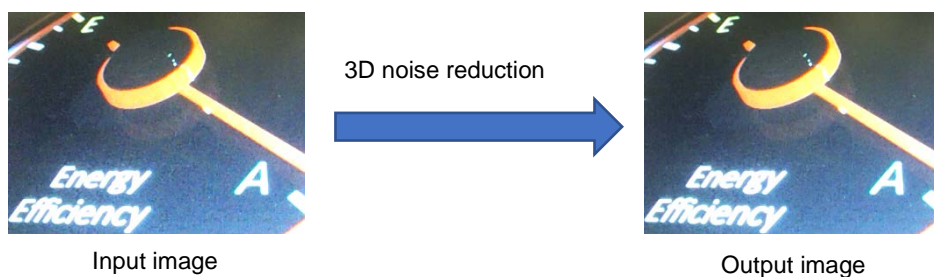

Exposure Control Example

Same as the Exposure Control Example of 4.2.3 Simple ISP API.

Example of White Balance

Same as the Example of White Balance of 4.2.3 Simple ISP API.

Note	The recommended values of the following parameters are those for use with the Raspberry Pi Camera V2. bias_r bias_g bias_b gain_r gain_g gain_b matrix_c11 matrix_c12 matrix_c13 matrix_c21 matrix_c22 matrix_c23 matrix_c31 matrix_c32 matrix_c33
------	---

4.9 Image transformation

4.9.1 Bayer2Grayscale

Bayer2Grayscale

Converts from RAW data acquired from CMOS to grayscale

Configuration data file	r_drp_bayer2grayscale.dat		
Supported version	1.00		
Configuration data size (byte)	59808		
Header file	r_drp_bayer2grayscale.h		
Parameter	Structure name		
	r_drp_bayer2grayscale_t		
	Member name	Type	Description
	src	uint32_t	Input image address
	dst	uint32_t	Output image address
	width	uint16_t	Image width (pixels)
	height	uint16_t	Image height (pixels)
	top	uint8_t	1: Top edge border processing 0: No top edge border processing Specify 1 if the input image is not segmented. For segmenting the input image for processing, specify 1 if the input image reaches the top edge of the source image, otherwise, specify 0.
	bottom	uint8_t	1: Bottom edge border processing 0: No bottom edge border processing Specify 1 if the input image is not segmented. For segmenting the input image for processing, specify 1 if the input image reaches the bottom edge of the source image, otherwise, specify 0.

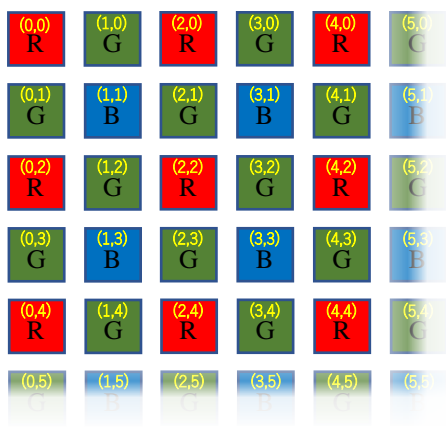
I/O details	Input image	Address: Specified by src. Width (pixels): Specified by width. (16 to 1280) Height (pixels): Specified by height. (4 to 960) Data size: (width) x (height) x 1 byte
		Format The input image format is as follows. When the coordinates of the upper left corner in input image are (0,0), both X and Y coordinates being even numbers represents "red," both being odd numbers represents "blue," and any other combination represents "green." This produces the Bayer array shown below.
		 <p>(X coordinate, Y coordinate) = (even, even): red (even, odd): green (odd, even): green (odd, odd): blue</p>
		Bayer arrays other than the above can be supported either by changing the camera settings or using the VIN function of the RZ/A2M. Refer to the description below for details.
	Output image	Address: Specified by dst. Width (pixels): Same as input image Height (pixels): Same as input image Format: 8-bit grayscale (1 byte per pixel) Data size: (width) x (height) x 1 byte
Number of tiles	1	
Segmented processing	Supported	

Description This function converts the image at the address specified by src from Bayer format to 8-bit grayscale format and outputs the result to the address specified by dst.

First, the function converts the input image to RGB by linear interpolation using a 3 × 3 filter. Then it converts from RGB to Y and calculates brightness values.

In linear interpolation using a 3 × 3 filter, the 3 × 3 grid consists of the pixel to be converted and the pixels adjacent to it. The pixel values are multiplied by the following multipliers and the results for each color component are added up.

Value of center pixel: 4/16x

Values of pixels immediately above, below, left, and right: 2/16x

Values of diagonally adjacent pixels: 1/16x

These are then multiplied by the reciprocals of the Bayer color density values (4 for red and blue, 2 for green), to obtain the RGB values for the pixel being converted.



- **Center: 4/16x**
- **Above, below, left, and right: 2/16x**
- **Diagonally adjacent: 1/16x**

Each is multiplied by the respective multiplier indicated above and the results for each color component added up. These are then multiplied by the reciprocals of the color density values (4 for red and blue, 2 for green).

The following equation is used to convert from RGB to Y.

$$Y = (\text{Red} * 76 + \text{Green} * 152 + \text{Blue} * 28) / 256$$

For the pixels at the left and right edges of the screen, a portion of the 3 × 3 filter grid is outside the input image area and therefore cannot be referenced. Instead, border reflection (OpenCV BORDER_REFLECT_101), in which the values of pixels 1 line further inward are referenced, is performed.

Reference URL: <https://opencv.org/>

When top and bottom are both set to 1, equivalent border reflection is also performed at the top and bottom edges of the image. Set top and bottom to 1 if the input image is not segmented.

When using a camera with a Bayer array that differs from that shown in the figure for "Input image" under "I/O details," crop and capture the image in a position such that the upper left corner is red. To crop the image, either clip the output image range of the camera or, when using an MIPI camera, clip the input image range on the RZ/A2M. For information on settings for the latter method, refer to section 48, Video Input Module, in RZ/A2M Group User's Manual: Hardware, or the description of range clipping (pre-stage) in the user's manual of the MIPI driver.

This function allows specification of the same address for both src and dst as long as the processing is not segmented.

Note None

4.9.2 Bayer2Rgb

Bayer2Rgb

Converts from RAW data acquired from CMOS to RGB

Configuration data file	r_drp_bayer2rgb.dat		
Supported version	1.00		
Configuration data size (byte)	91744		
Header file	r_drp_bayer2rgb.h		
Parameter	Structure name		
	r_drp_bayer2rgb_t		
	Member name	Type	Description
	src	uint32_t	Input image address
	dst	uint32_t	Output image address
	width	uint16_t	Image width (pixels)
	height	uint16_t	Image height (pixels)
	top	uint8_t	1: Top edge border processing 0: No top edge border processing Specify 1 if the input image is not segmented. For segmenting the input image for processing, specify 1 if the input image reaches the top edge of the source image, otherwise, specify 0.
	bottom	uint8_t	1: Bottom edge border processing 0: No bottom edge border processing Specify 1 if the input image is not segmented. For segmenting the input image for processing, specify 1 if the input image reaches the bottom edge of the source image, otherwise, specify 0.

I/O details	Input image	Address:	Specified by src. (Specify an address that differs from dst.)
		Width (pixels):	Specified by width. (16 to 1280, integer multiple of 2)
		Height (pixels):	Specified by height. (4 to 960, integer multiple of 2)
		Data size:	(width) × (height) × 1 byte

Format

The input image format is as follows. When the coordinates of the upper left corner in input image are (0,0), both X and Y coordinates being even numbers represents "red," both being odd numbers represents "blue," and any other combination represents "green." This produces the Bayer array shown below.

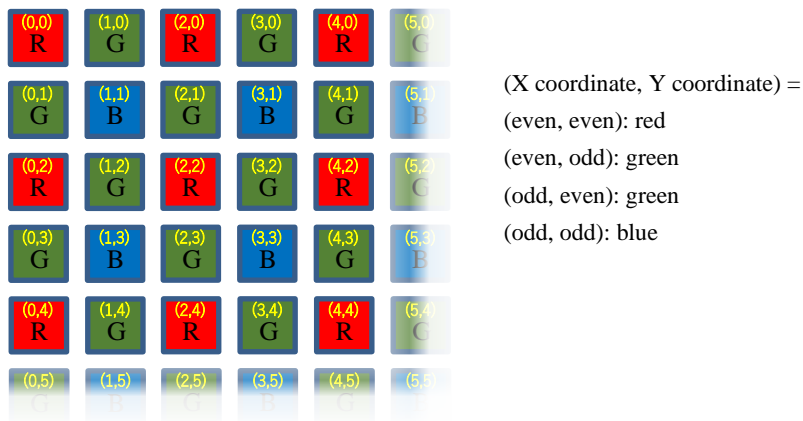

Bayer arrays other than the above can be supported either by changing the camera settings or using the VIN function of the RZ/A2M. Refer to the description below for details.

	Output image	Address:	Specified by dst. (Specify an address that differs from src.)
		Width (pixels):	Same as input image
		Height (pixels):	Same as input image
		Format:	RGB (3 bytes per pixel)
		Data size:	(width) × (height) × 3 bytes

Number of tiles	2
-----------------	---

Segmented processing	Supported
----------------------	-----------

Description This function converts the image at the address specified by src from Bayer format to RGB format and outputs the result to the address specified by dst.

This function uses adaptive color plane interpolation (ACPI) to convert the image to RGB format. This conversion method is registered under patent publication number US5629734A.

This function performs RGB conversion by ACPI as follows. The conversion of each color at each coordinate is described separately.

In the description below, the value at coordinates (x,y) in the input image is expressed as I(x,y), and the RGB values at coordinates (x,y) in the output image are expressed as R(x,y), G(x,y), and B(x,y).

1. Calculation of G Component

- If x = even number and y = odd number
- If x = odd number and y = even number

The G component in the Bayer array of the input image applies, so the input I(x,y) value is used without modification.

$$G(x,y) = I(x,y)$$

- If x = even number and y = even number
- If x = odd number and y = odd number

The R or B component in the Bayer array of the input image applies, so G(x,y) is calculated as follows.

First, M, which represents the degree of change in the horizontal direction, and N, which represents the degree of change in the vertical direction, are calculated.

$$M = |I(x-2,y) + I(x+2,y) - 2 \times I(x,y)| + |I(x+1,y) - I(x-1,y)|$$

$$N = |I(x,y-2) + I(x,y+2) - 2 \times I(x,y)| + |I(x,y+1) - I(x,y-1)|$$

Next, the two degrees of change are compared, and the interpolation value t is calculated in the direction with the smaller degree of change. (If the degrees of change are the same, the average of the interpolation values in both directions is used as interpolation value t.)

(1) If $M < N$

$$t = (2 \times (I(x-1,y) + I(x+1,y) + I(x,y)) - I(x-2,y) - I(x+2,y)) \div 4$$

(2) If $M > N$

$$t = (2 \times (I(x,y-1) + I(x,y+1) + I(x,y)) - I(x,y-2) - I(x,y+2)) \div 4$$

(3) If $M = N$

$$t = (2 \times (I(x-1,y) + I(x+1,y) + 2 \times I(x,y) + I(x,y-1) + I(x,y+1)) - I(x-2,y) - I(x+2,y) - I(x,y-2) - I(x,y+2)) \div 8$$

The digits after the decimal point of interpolation value t are discarded, resulting in t', and the value of G(x,y) is as follows.

$$G(x,y) = \begin{cases} 0, & t' < 0 \\ 255, & t' > 255 \\ t', & 0 \leq t' \leq 255 \end{cases}$$

2. Calculation of R Component

- If x = even number and y = even number

The R component in the Bayer array of the input image applies, so the input I(x,y) value is used without modification.

$$R(x, y) = I(x, y)$$

- If x = odd number and y = odd number

The B component in the Bayer array of the input image applies, so R(x,y) is calculated as follows.

First, M, which represents the degree of change in the diagonal (upper right to lower left) direction, and N, which represents the degree of change in the diagonal (upper left to lower right) direction, are calculated.

$$M = |G(x + 1, y - 1) + G(x - 1, y + 1) - 2 \times G(x, y)| + |I(x - 1, y + 1) - I(x + 1, y - 1)|$$

$$N = |G(x - 1, y - 1) + G(x + 1, y + 1) - 2 \times G(x, y)| + |I(x + 1, y + 1) - I(x - 1, y - 1)|$$

Next, the two degrees of change are compared, and the interpolation value t is calculated in the direction with the smaller degree of change. (If the degrees of change are the same, the average of the interpolation values in both directions is used as interpolation value t.)

- (1) If $M < N$

$$t = (2 \times (I(x + 1, y - 1) + I(x - 1, y + 1) + G(x, y)) - G(x + 1, y - 1) - G(x - 1, y + 1)) \div 4$$

- (2) If $M > N$

$$t = (2 \times (I(x - 1, y - 1) + I(x + 1, y + 1) + G(x, y)) - G(x - 1, y - 1) - G(x + 1, y + 1)) \div 4$$

- (3) If $M = N$

$$t = (2 \times (I(x + 1, y - 1) + I(x - 1, y + 1) + 2 \times G(x, y) + I(x - 1, y - 1) + I(x + 1, y + 1)) - G(x + 1, y - 1) - G(x - 1, y + 1) - G(x - 1, y - 1) - G(x + 1, y + 1)) \div 8$$

The digits after the decimal point of interpolation value t are discarded, resulting in t', and the value of R(x,y) is as follows.

$$R(x, y) = \begin{cases} 0, & t' < 0 \\ 255, & t' > 255 \\ t', & 0 \leq t' \leq 255 \end{cases}$$

- If x = odd number and y = even number

The G component in the Bayer array of the input image applies, so R(x,y) is calculated as follows, taking into account the R components to the left and right in the input image and the left and right G components calculated as described in "1. Calculation of G Component."

$$R(x, y) = \begin{cases} 0, & M < N \\ 255, & ((M - N) \gg 2) > 255 \\ (M - N) \gg 2, & \text{Other than above} \end{cases}$$

$$M = 2 \times (I(x - 1, y) + I(x + 1, y) + I(x, y))$$

$$N = G(x - 1, y) + G(x + 1, y)$$

- If x = even number and y = odd number

The G component in the Bayer array of the input image applies, so R(x,y) is calculated as follows, taking into account the R components above and below in the input image and the above and below G components calculated as described in "1. Calculation of G Component."

$$R(x, y) = \begin{cases} 0, & M < N \\ 255, & ((M - N) \gg 2) > 255 \\ (M - N) \gg 2, & \text{Other than above} \end{cases}$$

$$M = 2 \times (I(x, y - 1) + I(x, y + 1) + I(x, y))$$

$$N = G(x, y - 1) + G(x, y + 1)$$

3. Calculation of B Component

- If $x = \text{odd number}$ and $y = \text{odd number}$

The B component in the Bayer array of the input image applies, so the input $I(x,y)$ value is used without modification.

$$B(x,y) = I(x,y)$$

- If $x = \text{even number}$ and $y = \text{even number}$

The R component in the Bayer array of the input image applies, so $B(x,y)$ is calculated as follows.

First, M , which represents the degree of change in the diagonal (upper right to lower left) direction, and N , which represents the degree of change in the diagonal (upper left to lower right) direction, are calculated.

$$M = |G(x+1, y-1) + G(x-1, y+1) - 2 \times G(x, y)| + |I(x-1, y+1) - I(x+1, y-1)|$$

$$N = |G(x-1, y-1) + G(x+1, y+1) - 2 \times G(x, y)| + |I(x+1, y+1) - I(x-1, y-1)|$$

Next, the two degrees of change are compared, and the interpolation value t is calculated in the direction with the smaller degree of change. (If the degrees of change are the same, the average of the interpolation values in both directions is used as interpolation value t .)

- (1) If $M < N$

$$t = (2 \times (I(x+1, y-1) + I(x-1, y+1) + G(x, y)) - G(x+1, y-1) - G(x-1, y+1)) \div 4$$

- (2) If $M > N$

$$t = (2 \times (I(x-1, y-1) + I(x+1, y+1) + G(x, y)) - G(x-1, y-1) - G(x+1, y+1)) \div 4$$

- (3) If $M = N$

$$t = (2 \times (I(x+1, y-1) + I(x-1, y+1) + 2 \times G(x, y) + I(x-1, y-1) + I(x+1, y+1)) - G(x+1, y-1) - G(x-1, y+1) - G(x-1, y-1) - G(x+1, y+1)) \div 8$$

The digits after the decimal point of interpolation value t are discarded, resulting in t' , and the value of $B(x,y)$ is as follows.

$$B(x,y) = \begin{cases} 0, & t' < 0 \\ 255, & t' > 255 \\ t', & 0 \leq t' \leq 255 \end{cases}$$

- If $x = \text{even number}$ and $y = \text{odd number}$

The G component in the Bayer array of the input image applies, so $B(x,y)$ is calculated as follows, taking into account the B components to the left and right in the input image and the left and right G components calculated as described in "1. Calculation of G Component."

$$B(x,y) = \begin{cases} 0, & M < N \\ 255, & ((M - N) \gg 2) > 255 \\ (M - N) \gg 2, & \text{Other than above} \end{cases}$$

$$M = 2 \times (I(x-1, y) + I(x+1, y) + I(x, y))$$

$$N = G(x-1, y) + G(x+1, y)$$

- If $x = \text{odd number}$ and $y = \text{even number}$

The G component in the Bayer array of the input image applies, so $B(x,y)$ is calculated as follows, taking into account the B components above and below in the input image and the above and below G components calculated as described in "1. Calculation of G Component."

$$B(x,y) = \begin{cases} 0, & M < N \\ 255, & ((M - N) \gg 2) > 255 \\ (M - N) \gg 2, & \text{Other than above} \end{cases}$$

$$M = 2 \times (I(x, y-1) + I(x, y+1) + I(x, y))$$

$$N = G(x, y-1) + G(x, y+1)$$

When converting the pixels near the left and right edges of the screen, a portion of the data to be referred to is outside the input image area and therefore cannot be referenced. Instead, the values of the two rows of pixels at the edge are referenced, and border reflection is performed.

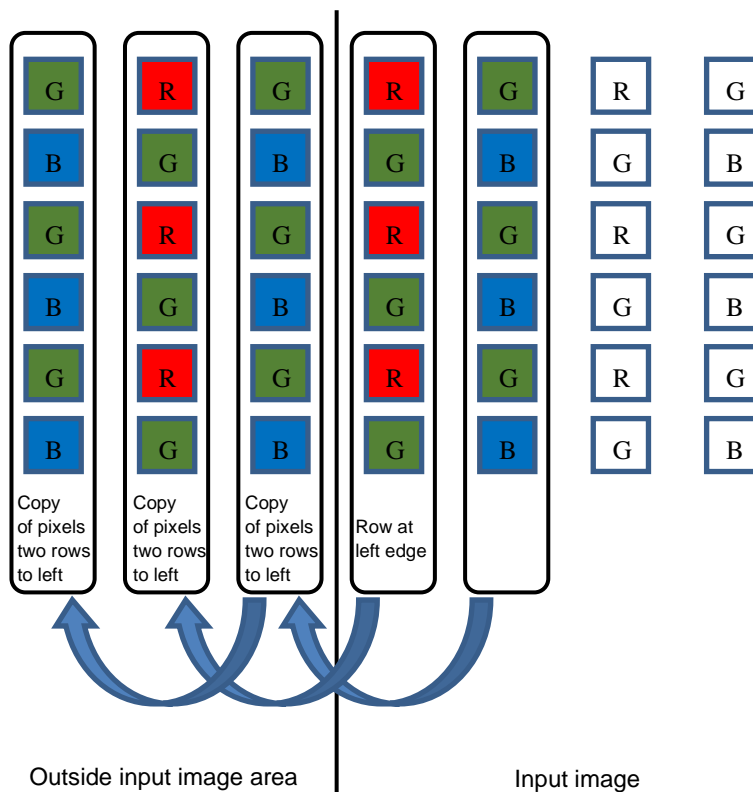

When top and bottom are both set to 1, equivalent border reflection is also performed at the top and bottom edges of the image. Set top and bottom to 1 if the input image is not segmented.

When using a camera with a Bayer array that differs from that shown in the figure for "Input image" under "I/O details," crop and capture the image in a position such that the upper left corner is red. To crop the image, either clip the output image range of the camera or, when using an MIPI camera, clip the input image range on the RZ/A2M. For information on settings for the latter method, refer to section 48, Video Input Module (VIN), in RZ/A2M Group User's Manual: Hardware, or the description of range clipping (pre-stage) in the user's manual of the MIPI driver.

Note	None
------	------

4.9.3 Bayer2RgbColorCorrection

Bayer2 RgbColorCorrection

Converts from RAW data acquired from CMOS camera to RGB (With color correction)

Configuration data file	r_drp_bayer2rgb_color_correction.dat		
Supported version	1.01		
Configuration data size (byte)	203808		
Header file	r_drp_bayer2rgb_color_correction.h		
Parameter	Structure name		
	r_drp_bayer2rgb_color_correction_t		
	Member name	Type	Description
	src	uint32_t	Input image address
	dst	uint32_t	Output image address
	width	uint16_t	Image width (pixels)
	height	uint16_t	Image height (pixels)
	gain_r	uint16_t	Gain correction value of image (R component). The upper 4 bits are an integer part, the lower 12 bits are a decimal part.
	gain_g	uint16_t	Gain correction value of image (G component). The upper 4 bits are an integer part, the lower 12 bits are a decimal part.
	gain_b	uint16_t	Gain correction value of image (B component). The upper 4 bits are an integer part, the lower 12 bits are a decimal part.
	pattern	uint8_t	Specify the bayer pattern of input image 0: RGGB 1: GRBG 2: GBRG 3: BGGR

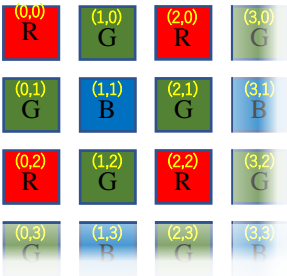
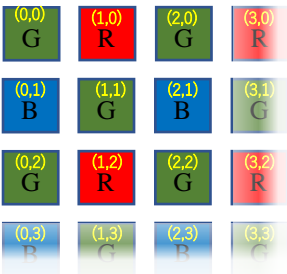
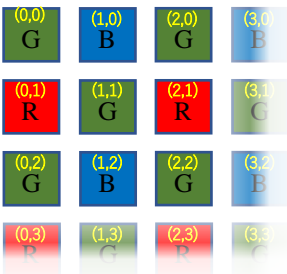
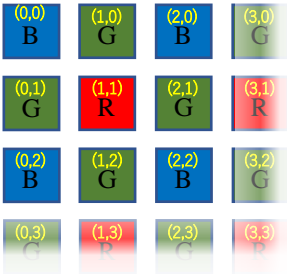
I/O details	Input image	Address: Specified by src. Width (pixels): Specified by width. (16 to 1280) Height (pixels): Specified by height. (4 to 960) Data size: (width) × (height) × 1 byte
		Format The input image formats are 4 patterns shown below.
		RGGG:  <p>(X coordinate, Y coordinate) = (even, even): red (even, odd): green (odd, even): green (odd, odd): blue</p>
		GRBG:  <p>(X coordinate, Y coordinate) = (even, even): green (even, odd): blue (odd, even): red (odd, odd): green</p>
		GBRG:  <p>(X coordinate, Y coordinate) = (even, even): green (even, odd): red (odd, even): blue (odd, odd): green</p>
		BGGR:  <p>(X coordinate, Y coordinate) = (even, even): blue (even, odd): green (odd, even): green (odd, odd): red</p>
		Output image Address: Specified by dst. Width (pixels): Same as input image Height (pixels): Same as input image Format: RGB (3 bytes per pixel) Data size: (width) × (height) × 3 bytes
Number of tiles	6	
Segmented processing	Not supported	

Description This function converts the image at the address specified by src from Bayer format to RGB format using Advanced Color Plane Interpolation (ACPI) and outputs the result to the address specified by dst.

The ACPI is a method to obtain sharp color images by adding high frequency components to the linear interpolation value of surrounding pixels to be interpolated.

This method calculates interpolation values from two directions, vertical and horizontal, then it adopts interpolation values in the direction is more continuous at the original pixel to be processed. Also, it calculates the missing component pixel using the information of other component.

This function outputs black pixels at the top, bottom, left, and right 3 pixels of the output image as shown below because it does not execute border processing at the image edge.

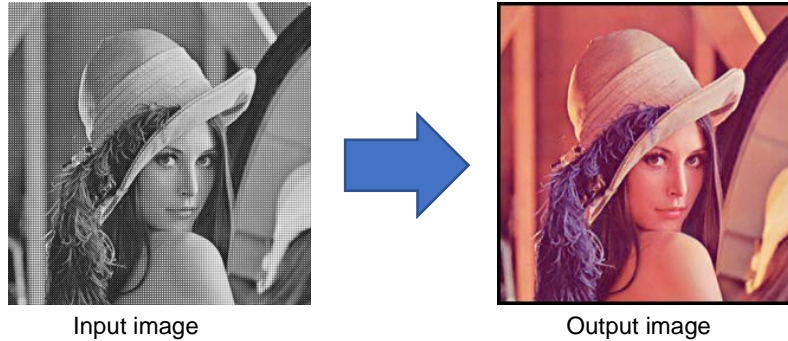

This function corrects respective component pixel values of RGB converted from Bayer by setting correction value to the parameter "gain_*". But, Set the value of "Actual value multiplied by 4096" to "gain_*" because it is fixed-point (the upper 4 bits are an integer part, the lower 12 bits are a decimal part).

This function allows the same address to be specified for both src and dst.

Note None

4.9.4 Argb2Grayscale

Argb2Grayscale

Converts from ARGB to grayscale

Configuration data file	r_drp_argb2grayscale.dat		
Supported version	1.00		
Configuration data size (byte)	14528		
Header file	r_drp_argb2grayscale.h		
Parameter	Structure name		
	r_drp_argb2grayscale_t		
	Member name	Type	Description
	src	uint32_t	Input image address
	dst	uint32_t	Output image address
	width	uint16_t	Image width (pixels)
	height	uint16_t	Image height (pixels)
I/O details	Input image	Address:	Specified by src. (Specify an address that differs from dst.)
		Width (pixels):	Specified by width. (16 to 1280, integer multiple of 2)
		Height (pixels):	Specified by height. (1 to 960)
		Format:	ARGB (4 bytes per pixel)
		Data size:	(width) × (height) × 4 bytes
	Output image	Address:	Specified by dst. (Specify an address that differs from src.)
		Width (pixels):	Same as input image
		Height (pixels):	Same as input image
		Format:	8-bit grayscale (1 byte per pixel)
		Data size:	(width) × (height) × 1 byte
Number of tiles	1		
Segmented processing	Supported		
Description	This function converts the image at the address specified by src from ARGB format to grayscale and outputs the result to the address specified by dst.		

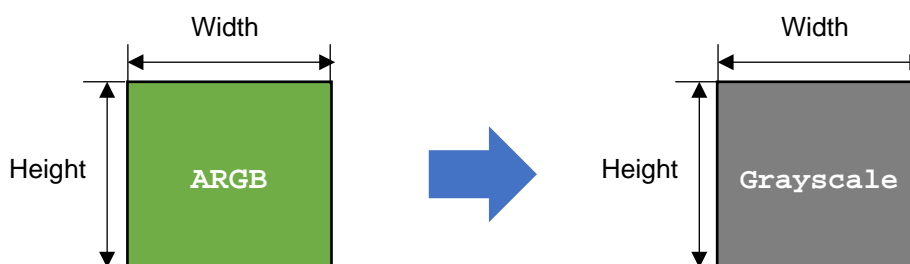

The function uses the following equation to convert between image formats.

$$\text{Grayscale} = (A \times 0 + R \times 16384 + G \times 40960 + B \times 8192) \div 65536$$

Note	None
------	------

4.9.5 BinarizationFixed

BinarizationFixed

Converts the image to a binary image with a fixed threshold (fixed threshold)

Configuration data file	r_drp_binarization_fixed.dat		
Supported version	1.00		
Configuration data size (byte)	16160		
Header file	r_drp_binarization_fixed.h		
Parameter	Structure name		
	r_drp_binarization_fixed_t		
	Member name	Type	Description
	src	uint32_t	Input image address
	dst	uint32_t	Output image address
	width	uint16_t	Image width (pixels)
	height	uint16_t	Image height (pixels)
	threshold	uint8_t	Binarization threshold (0 to 255)
I/O details	Input image	Address:	Specified by src.
		Width (pixels):	Specified by width. (32 to 1280, integer multiple of 8)
		Height (pixels):	Specified by height. (1 to 960)
		Format:	8-bit grayscale (1 byte per pixel)
		Data size:	(width) × (height) × 1 byte
	Output image	Address:	Specified by dst.
		Width (pixels):	Same as input image
		Height (pixels):	Same as input image
		Format:	8-bit grayscale (0 or 255) (1 byte per pixel)
		Data size:	(width) × (height) × 1 byte
Number of tiles	1		
Segmented processing	Supported		
Description	<p>This function binarizes the image at the address specified by src and outputs the result to the address specified by dst.</p> <p>This function outputs 255 when the input data exceeds the threshold (threshold member) and 0 when the input data is equal to or less than the threshold.</p> <p>The processing performed by this function is equivalent to that of the OpenCV cv::threshold function with Type set to THRESH_BINARY. Reference URL: https://opencv.org/</p> <p>This function allows the same address to be specified for both src and dst.</p>		
Note	None		

4.9.6 BinarizationAdaptive

BinarizationAdaptive

Converts the image to a binary image with a dynamic threshold matching the surrounding image (adaptive threshold)

Configuration data file	r_drp_binarization_adaptive.dat		
Supported version	1.00		
Configuration data size (byte)	234560		
Header file	r_drp_binarization_adaptive.h		
Parameter	Structure name		
	r_drp_binarization_adaptive_t		
	Member name	Type	Description
	src	uint32_t	Input image address
	dst	uint32_t	Output image address
	width	uint16_t	Image width (pixels)
	height	uint16_t	Image height (pixels)
	work	uint32_t	Work area address
	range	uint8_t	Effective range during average brightness calculation (0 to 255)
I/O details	Input image	Address:	Specified by src.
		Width (pixels):	Specified by width. (64 to 1280, integer multiple of 32)
		Height (pixels):	Specified by height. (40 to 960, integer multiple of 8)
Format:		8-bit grayscale (1 byte per pixel)	
Data size:		(width) × (height) × 1 byte	
Output image	Address:	Specified by dst.	
	Width (pixels):	Same as input image	
	Height (pixels):	Same as input image	
	Format:	8-bit grayscale (0 or 255) (1 byte per pixel)	
	Data size:	(width) × (height) × 1 byte	
Work area	Address:	Specified by work.	
	Data size:	$((\text{width} \times \text{height}) \div 64) + 2$ bytes	
	Description	The area used to store average brightness values. Refer to the explanation below for more on average brightness values.	
Number of tiles	3		
Segmented processing	Not supported		

Description This function binarizes the image at the address specified by src and outputs the result to the address specified by dst.

In the first part of binarization processing, the function divides the input image into blocks of 8×8 pixels and calculates the average brightness of each. Then it calculates thresholds from the average brightness values and binarizes the input image.

The method of calculating the average brightness value is as follows. First, blocks of 8×8 pixels are delimited, starting from the upper left corner of the input image. Then the maximum and minimum brightness values are sought for each block and the brightness differential is obtained. For blocks where the brightness differential exceeds the range value, the average of the brightness values within the block is used as the average brightness value. For blocks where the brightness differential is equal to or less than the range value, the average brightness value is obtained from the average brightness values of 3 adjacent blocks (above left, above, and left). The method of obtaining the average brightness value is shown in detail below.

- (1) Block where the brightness differential exceeds the value of range

$$\text{Average brightness value} = \text{total brightness values of } 8 \times 8 \text{ pixels} \div 64$$

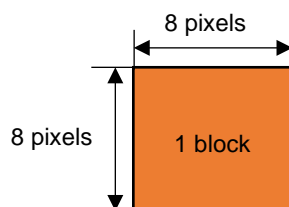

- (2) Block where the brightness differential is equal to or less than the value of range

Average brightness value

$$\begin{aligned} &= (\text{average brightness value of A} \\ &+ \text{average brightness value of B} \\ &+ (\text{average brightness value of C} \times 2)) \div 4 \end{aligned}$$

However, if the block (D) whose average brightness value we wish to calculate is on the top or left edge of the input image, a value equal to 1/2 the minimum brightness value of D is used because it is not possible to secure average brightness values for the 3 adjacent blocks.

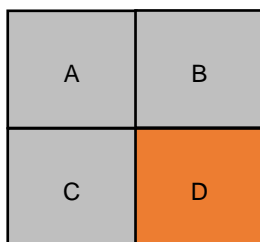

To calculate the thresholds from the average brightness values, groups of 5×5 blocks are delimited, each with the block containing the pixels to be binarized (the "target pixels") at the center. The threshold is then calculated from the average brightness values of the group of 5×5 blocks. The following equation is used to obtain the threshold.

$$\text{Threshold} = \{(0,0) \text{ average brightness value} + (1,0) \text{ average brightness value} + \dots + (4,4) \text{ average brightness value}\} \div 25$$

(0,0)	(1,0)	(2,0)	(3,0)	(4,0)
(0,1)	(1,1)	(2,1)	(3,1)	(4,1)
(0,2)	(1,2)	(2,2)	(3,2)	(4,2)
(0,3)	(1,3)	(2,3)	(3,3)	(4,3)
(0,4)	(1,4)	(2,4)	(3,4)	(4,4)

Block of 8 × 8 pixels

However, if the block containing the target pixels is at the edge of the input image, making it impossible to secure a group of 5 × 5 blocks, the threshold is calculated as described below.

- If the block is within 2 blocks from the top edge or left edge
The block is moved to the center to secure a group of 5 × 5 blocks, and the threshold is calculated.

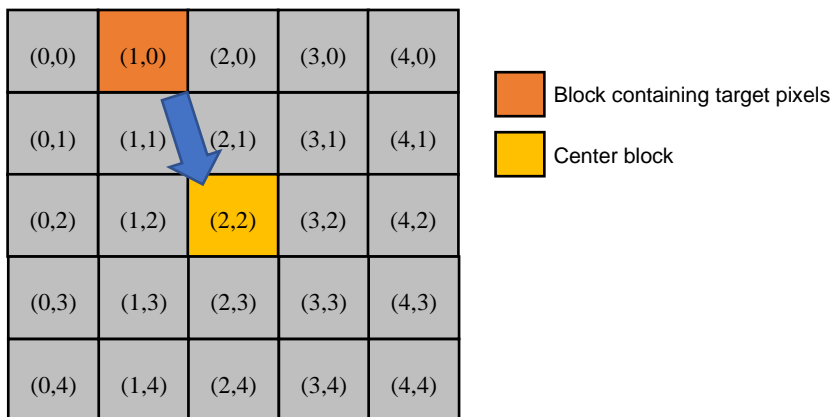

- If the block is within 2 blocks of the right edge
The threshold of the block immediately to the left is used.
- If the block is within 2 blocks of the bottom edge
The threshold of the block immediately above is used.

Note that the results of binarization change as shown below, according to the value specified for range.



Using a smaller value for range makes it possible to minimize white blowout and blocked up shadows in the binarized image, but the effects of noise will be more noticeable. Using a larger value for range will reduce the effects of noise but result in more white blowout and blocked up shadows. It is important to set range to a value appropriate for the characteristics of the input image (which are influenced by factors such as the performance of the connected camera and ambient light conditions).

This function allows the same address to be specified for both src and dst.

Note	None
------	------

4.9.7 BinarizationAdaptiveBit

BinarizationAdaptiveBit

Converts the image to a binary image with a dynamic threshold matching the surrounding image (adaptive threshold) (bit output)

Configuration data file	r_drp_binarization_adaptive_bit.dat		
Supported version	1.00		
Configuration data size (byte)	235712		
Header file	r_drp_binarization_adaptive_bit.h		
Parameter	Structure name		
	r_drp_binarization_adaptive_bit_t		
	Member name	Type	Description
	src	uint32_t	Input image address
	dst	uint32_t	Output image address
	width	uint16_t	Image width (pixels)
	height	uint16_t	Image height (pixels)
	work	uint32_t	Work area address
	range	uint8_t	Effective range during average brightness calculation (0 to 255)
I/O details	Input image	Address:	Specified by src.
		Width (pixels):	Specified by width. (64 to 1280, integer multiple of 32)
		Height (pixels):	Specified by height. (40 to 960, integer multiple of 8)
		Format:	8-bit grayscale (1 byte per pixel)
		Data size:	(width) × (height) × 1 byte
	Output image	Address:	Specified by dst.
		Width (pixels):	Same as input image
		Height (pixels):	Same as input image
		Format:	1 bit per pixel (Refer to the description for details.)
		Data size:	(width) × (height) ÷ 8 bytes
	Work area	Address:	Specified by work.
		Data size:	$((\text{width} \times \text{height}) \div 64) + 2$ bytes
		Description	The area used to store average brightness values. Refer to the explanation below for more on average brightness values.
Number of tiles	3		
Segmented processing	Not supported		

Description This function performs the same processing as that described in 4.9.6, BinarizationAdaptive. It differs from the function described in 4.9.6, BinarizationAdaptive, only in the output format for processing results.

The output format of this function uses 1 bit to represent 1 pixel. The arrangement of the bits in the image starts with bit 0 at x coordinate 0, followed by bit 1 at x coordinate 1, and so on. In addition, white is 0 and black is 1.

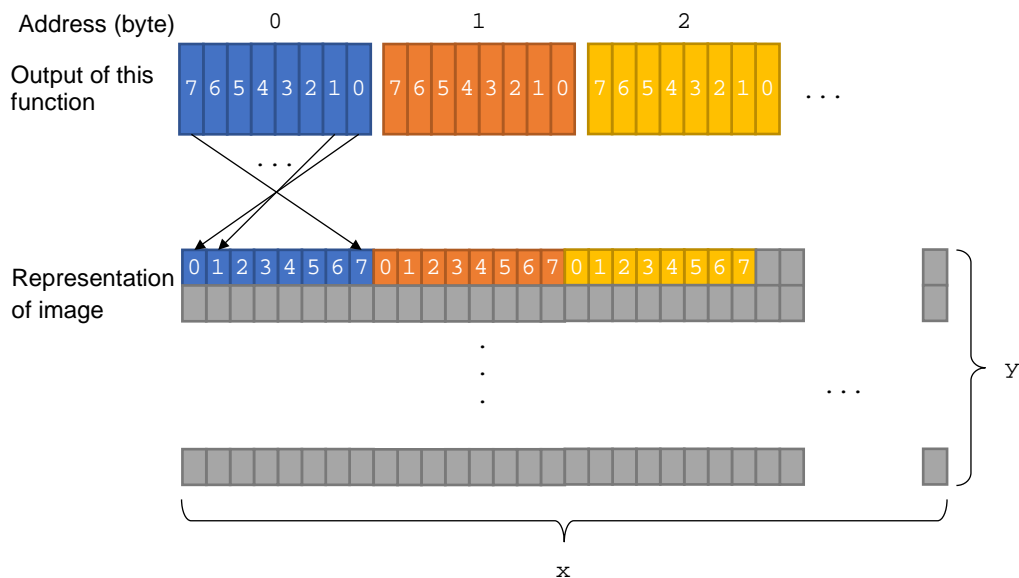

Setting the range value for this function to 0x18 produces results equivalent to the binarization performed in ZXing (“Zebra Crossing”) barcode scanning (implemented by the calculateBlackPoints function and calculateThresholdForBlock function).

Reference URL: <https://github.com/zxing/zxing>

This function allows the same address to be specified for both src and dst.

Note This function differs from the function described in 4.9.6, BinarizationAdaptive, only in the output format for processing results. But when BinarizationAdaptive is a pixel outputting 0, BinarizationAdaptiveBit outputs 1, and when BinarizationAdaptive is a pixel outputting 255, BinarizationAdaptiveBit is 0 Is output. Note this reverse relationship.

4.9.8 GammaCorrection

GammaCorrection

Corrects the image with gamma value

Configuration data file	r_drp_gamma_correction.dat		
Supported version	1.01		
Configuration data size (byte)	18272		
Header file	r_drp_gamma_correction.h		
Parameter	Structure name		
	r_drp_gamma_correction_t		
	Member name	Type	Description
	src	uint32_t	Input image address
	dst	uint32_t	Output image address
	width	uint16_t	Image width (pixels)
	height	uint16_t	Image height (pixels)
	table	uint32_t	LUT for gamma correction address
I/O details	Input image	Address:	Specified by src.
		Width (pixels):	Specified by width. (16 to 1280, integer multiple of 4)
		Height (pixels):	Specified by height. (1 to 960)
		Format:	8-bit grayscale (1 byte per pixel)
		Data size:	(width) × (height) × 1 byte
	Output image	Address:	Specified by dst.
		Width (pixels):	Same as input image
		Height (pixels):	Same as input image
		Format:	8-bit grayscale (1 byte per pixel)
		Data size:	(width) × (height) × 1 byte
Number of tiles	1		
Segmented processing	Supported		

Description This function applies Gamma correction to the image at the address specified by src and outputs the result to the address specified by dst.

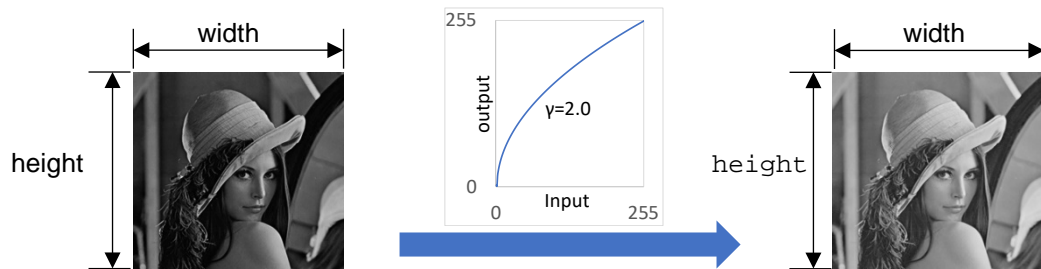

The function performs Gamma correction by obtaining post-correction brightness values from a LUT specified by table. Post-correction brightness values are calculated using the equation below, where the LUT is represented as table, the pre-correction brightness value as src, and the post-correction brightness value as dst.

$$\text{dst} = \text{table}[\text{src}]$$

The LUT size is 256 bytes, and each value is from 0 to 255. The following is an example of calculation formula of LUT when gamma value is γ .

$$\text{table}[n] = \left(\frac{n}{255}\right)^{\frac{1}{\gamma}} \times 255 \quad n = 0 \sim 255$$

This function allows the same address to be specified for both src and dst.

Note None

4.9.9 Cropping

Cropping

Crops a part of the image

Configuration data file	r_drp_cropping.dat		
Supported version	1.00		
Configuration data size (byte)	15840		
Header file	r_drp_cropping.h		
Parameter	Structure name		
	r_drp_cropping_t		
	Member name	Type	Description
	src	uint32_t	Input image address
	dst	uint32_t	Output image address
	src_width	uint16_t	Input image width (pixels)
	src_height	uint16_t	Input image height (pixels)
	offset_x	uint16_t	x coordinate input image
	offset_y	uint16_t	y coordinate input image
	dst_width	uint16_t	Output image width (pixels)
	dst_height	uint16_t	Output image height (pixels)
I/O details	Input image	Address:	Specified by src.
		Width (pixels):	Specified by src_width. (8 to 1280)
		Height (pixels):	Specified by src_height. (8 to 960)
		Format:	8-bit grayscale (1 byte per pixel)
		Data size:	(src_width) × (src_height) × 1 byte
	Output image	Address:	Specified by dst.
		Width (pixels):	Specified by dst_width. (8 to 1280, integer multiple of 8)
		Height (pixels):	Specified by dst_height. (8 to 960, integer multiple of 8)
		Format:	8-bit grayscale (1 byte per pixel)
		Data size:	(dst_width) × (dst_height) × 1 byte
Number of tiles	1		
Segmented processing	Not supported		

Description This function crops a rectangular portion of the size specified by the offsets from the image at the address specified by src and outputs it to the address specified by dst.

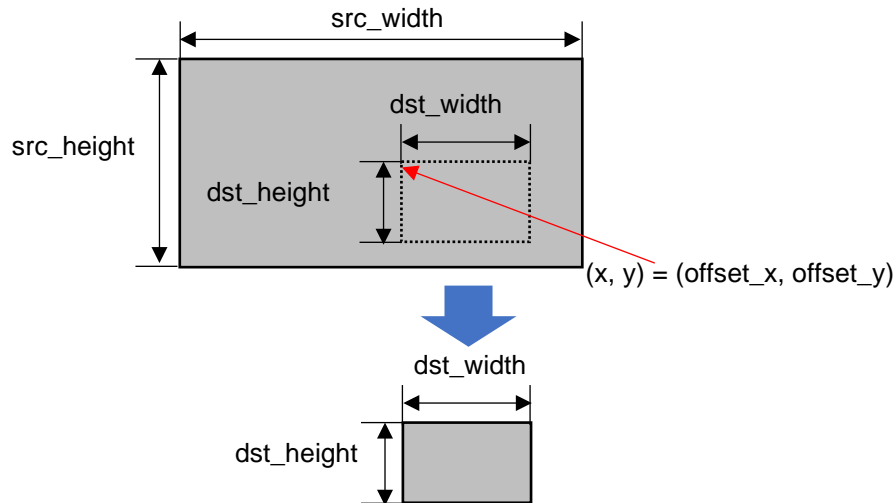

This function allows the same address to be specified for both src and dst.

Note The arguments should be set such that the cropped rectangular area does not extend outside of the input image area. If `offset_x + dst_width` exceeds `src_width`, or if `offset_y + dst_height` exceeds `src_height`, processing terminates with no cropping performed.

4.9.10 CroppingRgb

CroppingRgb

Crops a part of the image (RGB)

Configuration data file	r_drp_cropping_rgb.dat
Supported version	1.01
Configuration data size (byte)	17440
Header file	r_drp_cropping_rgb.h

Parameter	Structure name	Member name	Type	Description
	r_drp_cropping_rgb_t			
		src	uint32_t	Input image address
		dst	uint32_t	Output image address
		src_width	uint16_t	Horizontal width of input image (pixels)
		src_height	uint16_t	Vertical width of input image (pixels)
		offset_x	uint16_t	x coordinate input image
		offset_y	uint16_t	y coordinate input image
		dst_width	uint16_t	Output image width (pixels)
		dst_height	uint16_t	Output image height (pixels)

I/O details	Input image	Address:	Specified by src.
		Width (pixels):	Specified by src_width. (8 to 1280)
		Height (pixels):	Specified by src_height. (8 to 960)
		Format:	RGB (3 bytes per pixel)
		Data size:	(src_width) x (src_height) x 3 bytes
	Output image	Address:	Specified by dst.
		Width (pixels):	Specified by dst_width. (8 to 1280, integer multiple of 8)
		Height (pixels):	Specified by dst_height. (8 to 960, integer multiple of 8)
		Format:	RGB (3 bytes per pixel)
		Data size:	(dst_width) x (dst_height) x 3 bytes

Number of tiles 1

Segmented processing Not supported

Description This function crops a rectangular portion of the size specified by the offsets from the image at the address specified by src and outputs it to the address specified by dst.

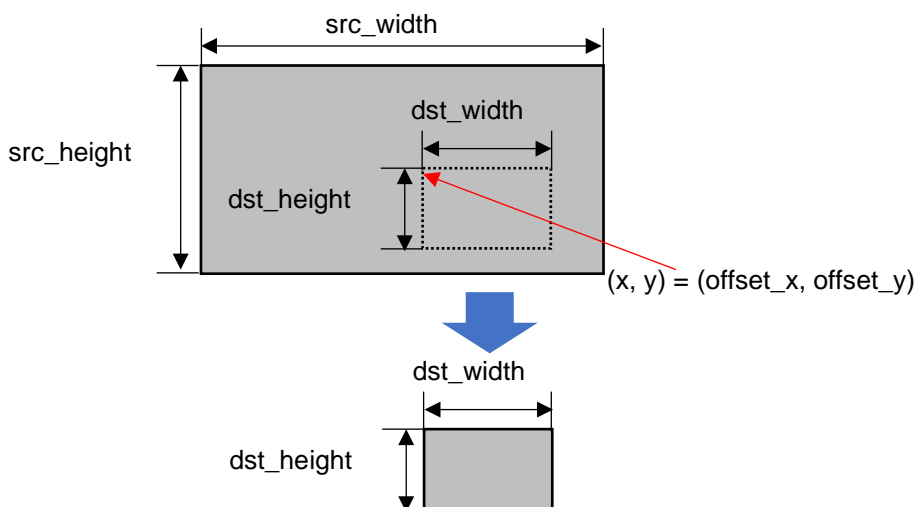

This function allows the same address to be specified for both src and dst.

Note The arguments should be set such that the cropped rectangular area does not extend outside of the input image area. If offset_x + dst_width exceeds src_width, or if offset_y + dst_height exceeds src_height, processing terminates with no cropping performed.

4.9.11 ResizeBilinearFixed

ResizeBilinearFixedResizes the image (bilinear interpolation, scale factor: 2ⁿ)

Configuration data file	r_drp_resize_bilinear_fixed.dat
Supported version	1.00
Configuration data size (byte)	115744
Header file	r_drp_resize_bilinear_fixed.h

Parameter	Structure name	
	r_drp_resize_bilinear_fixed_t	
Member name	Type	Description
src	uint32_t	Input image address
dst	uint32_t	Output image address
src_width	uint16_t	Horizontal width of input image (pixels)
src_height	uint16_t	Vertical width of input image (pixels)
fx	uint8_t	Horizontal scale factor

The enlargement and reduction ratios are as follows. The width of the output image is 8 pixels or more.

Setting value	Enlargement/reduction ratio
0x80	0.125 (1/8)
0x40	0.25 (1/4)
0x20	0.5 (1/2)
0x10	1× (same size)
0x08	2×
0x04	4×
0x02	8×
0x01	16×

	fy	uint8_t	The vertical scale factor setting values are the same as those of fx.
I/O details	Input image	Address:	Specified by src. (Specify an address that differs from dst.)
		Width (pixels):	Specified by src_width. (128 to 1280)
		Height (pixels):	Specified by src_height. (8 to 960)
		Format:	8-bit grayscale (1 byte per pixel)
		Data size:	(src_width) × (src_height) × 1 byte
I/O details	Output image	Address:	Specified by dst. (Specify an address that differs from src.)
		Width (pixels):	Specified by src_width × (horizontal enlargement/reduction ratio)
		Height (pixels):	Specified by src_height × (vertical enlargement/reduction ratio)
		Format:	8-bit grayscale (1 byte per pixel)
		Data size:	(output image width) × (output image height) × 1 byte
Number of tiles	4		
Segmented processing	Not supported		

Description	This function enlarges or reduces the image at the address specified by src by the specified scaling factors and outputs the result to the address specified by dst. It is necessary to add or remove pixels when the image is enlarged or reduced, and this function uses bilinear method for this purpose. In the bilinear method, a grid of 2 × 2 pixels peripheral to the input image in the position corresponding to the target pixel of the output image is used and linear interpolation is applied. The processing performed by this function is equivalent to that of the OpenCV cv::resize function with specifying 0 to dsize, an enlargement/reduction ratio of 0.125 to 16 to fx and fy, and INTER_LINEAR to interpolation. Reference URL: https://opencv.org/
Note	None

4.9.12 ResizeBilinearFixedRgb

ResizeBilinearFixedRgb

Resizes the image (bilinear interpolation, Scale factor: 2ⁿ) (RGB)

Configuration data file	r_drp_resize_bilinear_fixed_rgb.dat
Supported version	1.01
Configuration data size (byte)	189600
Header file	r_drp_resize_bilinear_fixed_rgb.h

Parameter	Structure name	Member name	Type	Description
	r_drp_resize_bilinear_fixed_rgb_t			
		src	uint32_t	Input image address
		dst	uint32_t	Output image address
		src_width	uint16_t	Horizontal width of input image (pixels)
		src_height	uint16_t	Vertical width of input image (pixels)
		fx	uint8_t	Horizontal scale factor

The enlargement and reduction ratios are as follows. The width of the output image is 8 pixels or more.

Setting value	Enlargement/reduction ratio
0x80	0.125 (1/8)
0x40	0.25 (1/4)
0x20	0.5 (1/2)
0x10	1× (same size)
0x08	2×
0x04	4×
0x02	8×
0x01	16×

I/O details	Parameter	Type	Description
I/O details	Input image	Address: Width (pixels): Height (pixels): Format: Data size:	Specified by src. (Specify an address that differs from dst.) Specified by src_width. (128 to 1280) Specified by src_height. (8 to 960) RGB (3 bytes per pixel) (src_width) × (src_height) × 3 bytes
	Output image	Address: Width (pixels): Height (pixels): Format: Data size:	Specified by dst. (Specify an address that differs from src.) Specified by src_width × (horizontal enlargement/reduction ratio) Specified by src_height × (vertical enlargement/reduction ratio) RGB (3 bytes per pixel) (output image width) × (output image height) × 3 bytes

Number of tiles	6
-----------------	---

Segmented processing	Not supported
----------------------	---------------

Description	This function enlarges or reduces the image at the address specified by src by the specified scaling factors and outputs the result to the address specified by dst.
-------------	--

It is necessary to add or remove pixels when the image is enlarged or reduced, and this function uses bilinear method for this purpose.

In the bilinear method, a grid of 2 × 2 pixels peripheral to the input image in the position corresponding to the target pixel of the output image is used and linear interpolation is applied.

The processing performed by this function is equivalent to that of the OpenCV cv::resize function with specifying 0 to dsize, an enlargement/reduction ratio of 0.125 to 16 to fx and fy, and INTER_LINEAR to interpolation.

Reference URL: <https://opencv.org/>

Note	None
------	------

4.9.13 ResizeBilinear

ResizeBilinear

Resizes the image (bilinear interpolation, scale factor: any)

Configuration data file	r_drp_resize_bilinear.dat		
Supported version	1.00		
Configuration data size (byte)	390880		
Header file	r_drp_resize_bilinear.h		
Parameter	Structure name		
	r_drp_resize_bilinear_t		
	Member name	Type	Description
	src	uint32_t	Input image address
	dst	uint32_t	Output image address
	src_width	uint16_t	Horizontal width of input image (pixels)
	src_height	uint16_t	Vertical width of input image (pixels)
	dst_width	uint16_t	Horizontal width of output image (pixels)
	dst_height	uint16_t	Vertical width of output image (pixels)
I/O details	Input image	Address:	Specified by src. (Specify an address that differs from dst.)
		Width (pixels):	Specified by src_width. (32 to 1280)
		Height (pixels):	Specified by src_height. (8 to 960)
		Format:	8-bit grayscale (1 byte per pixel)
		Data size:	(src_width) × (src_height) × 1 byte
	Output image	Address:	Specified by dst. (Specify an address that differs from src.)
		Width (pixels):	Specified by dst_width. (32 to 1280)
		Height (pixels):	Specified by dst_height. (8 to 960)
		Format:	8-bit grayscale (1 byte per pixel)
		Data size:	(dst_width) × (dst_height) × 1 byte
Number of tiles	6		
Segmented processing	Not supported		

Description This function enlarges or reduces the image at the address specified by `src` and outputs the result to the address specified by `dst`.

It is necessary to add or remove pixels when the image is enlarged or reduced, and this function uses bilinear method for this purpose.

In the bilinear method, a grid of 2×2 pixels peripheral to the input image in the position corresponding to the target pixel of the output image is used and linear interpolation is applied. This function uses the following calculations for the bilinear method.

Assuming that the coordinate (sx, sy) in the input image corresponds to the coordinate (dx, dy) of the output image, sx and sy are expressed by the following equations.

$$sx = (dx + 0.5) \times src_width \div dst_width - 0.5$$

$$sy = (dy + 0.5) \times src_height \div dst_height - 0.5$$

Assuming that $fsx = \text{Floor}(sx)$ and $fsy = \text{Floor}(sy)$, the coordinates of the grid of 2×2 pixels peripheral to (sx, sy) are (fsx, fsy) , $(fsx+1, fsy)$, $(fsx, fsy+1)$ and $(fsx+1, fsy+1)$.

Assuming that the brightness value at the coordinate (x, y) of the input image is $src(x, y)$ and the brightness value at the coordinate (x, y) of the output image is $dst(x, y)$, $dst(dx, dy)$ is expressed by the following equation.

$$dst(dx, dy) = (1 - b) \times (1 - a) \times src(fsx, fsy) + (1 - b) \times a \times src(fsx + 1, fsy) \\ + b \times (1 - a) \times src(fsx, fsy + 1) + b \times a \times src(fsx + 1, fsy + 1)$$

However, $a = sx - fsx$, $b = sy - fsy$

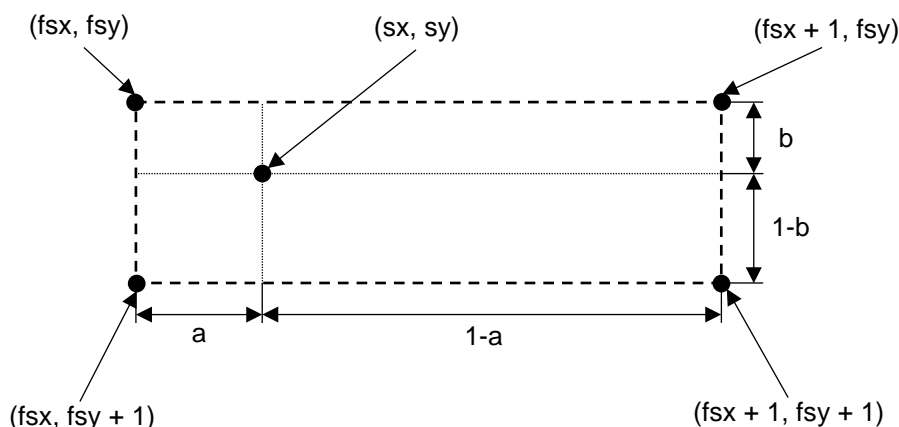

The processing performed by this function is equivalent to that of the OpenCV `cv::resize` function with specifying `dst_width` to the argument `dsize.width`, `dst_height` to `dsize.height`, and `INTER_LINEAR` to interpolation.

Reference URL: <https://opencv.org/>

Note None

4.9.14 ResizeNearest

ResizeNearest

Resizes the image (nearest neighbor interpolation, scale factor: any)

Configuration data file	r_drp_resize_nearest.dat		
Supported version	1.00		
Configuration data size (byte)	294912		
Header file	r_drp_resize_nearest.h		
Parameter	Structure name		
	r_drp_resize_nearest_t		
	Member name	Type	Description
	src	uint32_t	Input image address
	dst	uint32_t	Output image address
	src_width	uint16_t	Horizontal width of input image (pixels)
	src_height	uint16_t	Vertical width of input image (pixels)
	dst_width	uint16_t	Horizontal width of output image (pixels)
	dst_height	uint16_t	Vertical width of output image (pixels)
I/O details	Input image	Address:	Specified by src. (Specify an address that differs from dst.)
		Width (pixels):	Specified by src_width. (32 to 1280)
		Height (pixels):	Specified by src_height. (8 to 960)
		Format:	8-bit grayscale (1 byte per pixel)
		Data size:	(src_width) × (src_height) × 1 byte
	Output image	Address:	Specified by dst. (Specify an address that differs from src.)
		Width (pixels):	Specified by dst_width. (32 to 1280)
		Height (pixels):	Specified by dst_height. (8 to 960)
		Format:	8-bit grayscale (1 byte per pixel)
		Data size:	(dst_width) × (dst_height) × 1 byte
Number of tiles	6		
Segmented processing	Not supported		

Description This function enlarges or reduces the image at the address specified by src and outputs the result to the address specified by dst.

Assuming that the brightness value at the coordinate (x,y) of the input image is src(x,y), the brightness value dst(dx,dy) at the coordinate (dx,dy) of the output image is expressed by the following equation.

$$dst(dx, dy) = src(dx \times src_width \div dst_width, dy \times src_height \div dst_height)$$

The coordinate values are truncated after the decimal point.

The following figure shows an example of the output image when the size of the input image is 250 x 100 and that of the output image is 100 x 200.

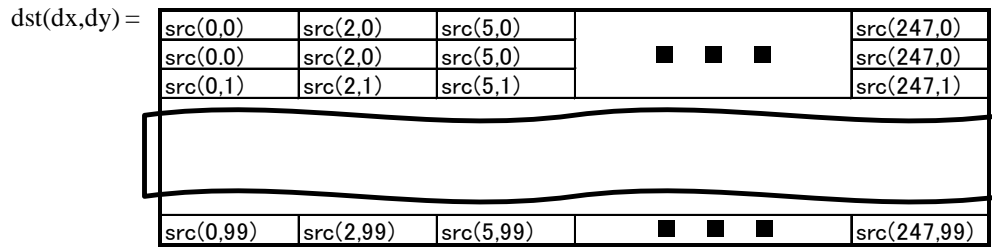

The processing performed by this function is equivalent to that of the OpenCV cv::resize function with specifying dst_width to the argument dsize.width, dst_height to dsize.height, and INTER_NEAREST to interpolation.

Reference URL: <https://opencv.org/>

Note None

4.9.15 ImageRotate

ImageRotate

Rotates the image

Configuration data file	r_drp_image_rotate.dat		
Supported version	1.00		
Configuration data size (byte)	56224		
Header file	r_drp_image_rotate.h		
Parameter	Structure name		
	r_drp_image_rotate_t		
	Member name	Type	Description
	src	uint32_t	Input image address
	dst	uint32_t	Output image address
	src_width	uint16_t	Input image width (pixels)
	src_height	uint16_t	Input image height (pixels)
	dst_stride	uint16_t	Output image stride value (0 to 1920) When set to 0, the lines of the output image are output to consecutive addresses. Specifying a value other than 0 causes the lines of the output image to be output with a spacing or "stride" between them equal to the value of this parameter. Specify either 0 or a value greater than the width of the output image. The maximum value is 1,920. Refer to the description for details.
	mode	uint8_t	1: Rotate 90° clockwise 2: Rotate 180° clockwise 3: Rotate 270° clockwise 4: Horizontal flip 5: Horizontal flip, then rotate 90° clockwise 6: Horizontal flip, then rotate 180° clockwise 7: Horizontal flip, then rotate 270° clockwise Refer to the description for details.

I/O details	Input image	Address:	Specified by src. (Specify an address that differs from dst.)
		Width (pixels):	Specified by src_width. (16 to 1280)
		Height (pixels):	Specified by src_height. (8 to 960, integer multiple of 2)
		Format:	8-bit grayscale (1 byte per pixel)
		Data size:	(src_width) × (src_height) × 1 byte
	Output image	Address:	Specified by dst. (Specify an address that differs from src.)
		Width (pixels):	If dst_stride is 0, <ul style="list-style-type: none"> • Same as src_width in case of mode = 2, 4, or 6 • Same as src_height in case of mode = 1, 3, 5, or 7 If dst_stride is not 0, <ul style="list-style-type: none"> • Same as dst_stride
		Height (pixels):	Same as src_height in case of mode = 2, 4, or 6 Same as src_width in case of mode = 1, 3, 5, or 7
		Format:	8-bit grayscale (1 byte per pixel)
		Data size:	If dst_stride is 0, <ul style="list-style-type: none"> (src_width) × (src_height) × 1 byte If dst_stride is not 0, <ul style="list-style-type: none"> • In case of mode = 2, 4, or 6 <ul style="list-style-type: none"> (dst_stride) × (src_height) × 1 byte • In case of mode = 1, 3, 5, or 7 <ul style="list-style-type: none"> (src_width) × (dst_stride) × 1 byte
Number of tiles	1		
Segmented processing	Supported		
	Refer to the description for details.		

Description This function rotates and flips as specified by mode the image at the address specified by src and outputs the result to the address specified by dst.

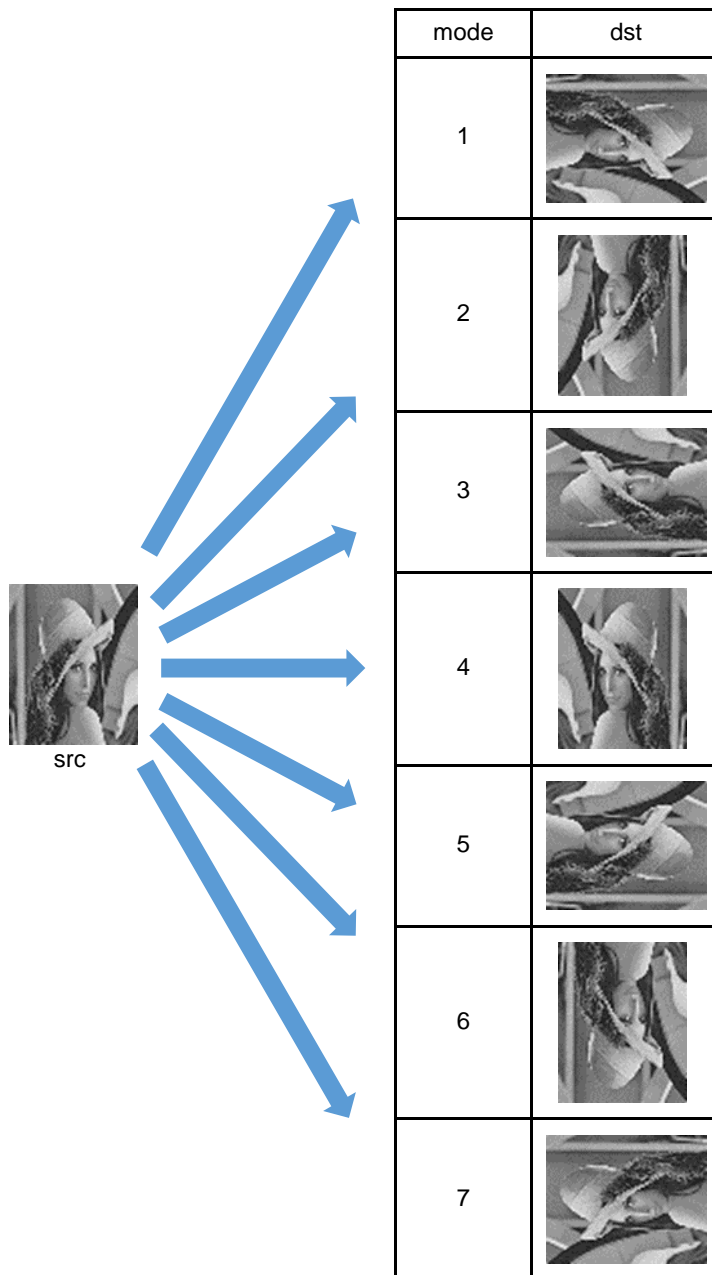

Ordinarily, dst_stride should be set to 0.

This function can be used to output an image to a partial rectangular area of a large image. To accomplish this, specify in dst_stride the number of pixels to insert between each line and the next when outputting the image.

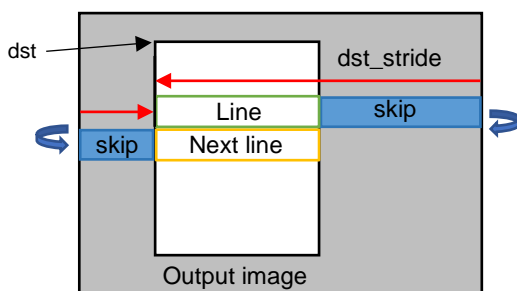

This function can be used to perform segmented processing of an image. In the following example, three segments are processed in parallel.

Divide the input data into three areas, ImageRotate0, ImageRotate1, and ImageRotate2, and specify specific src, dst, and src_height values for each. Use the same src_width, dst_stride, and mode values for each segment.

When mode is set to 1, 3, 5, or 7, the output image width of the three segments combined is equal to the sum of the three src_height values, so dst_stride should be set to a value equal to the sum of the three src_height values. When mode is set to a value other than the above, the output image width is equal to src_width, so dst_stride should be set to 0.

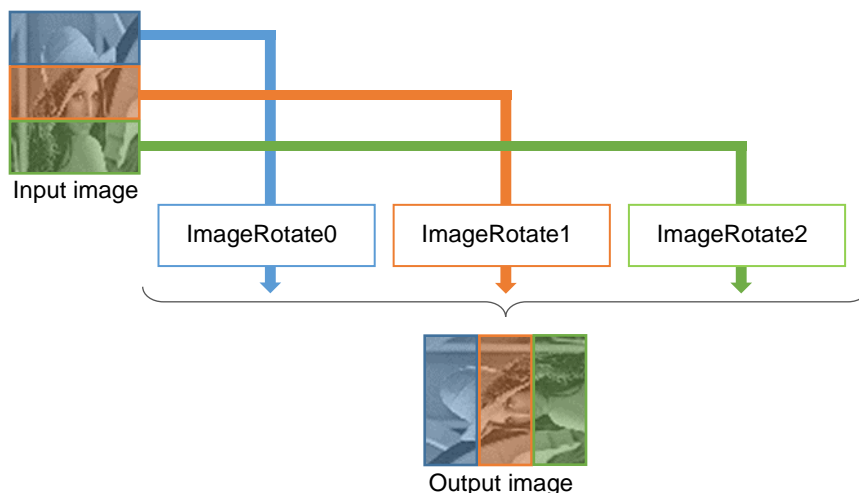

When mode = 1, this function produces results equivalent to cv::flip(src, tmp, 0); cv::transpose(tmp, dst); in OpenCV.

When mode = 2, this function produces results equivalent to cv::flip(src, dst, -1); in OpenCV.

When mode = 3, this function produces results equivalent to cv::flip(src, tmp, 1); cv::transpose(tmp, dst); in OpenCV.

When mode = 4, this function produces results equivalent to cv::flip(src, dst, 1); in OpenCV.

When mode = 5, this function produces results equivalent to cv::flip(src, tmp, -1); cv::transpose(tmp, dst); in OpenCV.

When mode = 6, this function produces results equivalent to cv::flip(src, dst, 0); in OpenCV.

When mode = 7, this function produces results equivalent to cv::transpose(src, dst); in OpenCV.

Reference URL: <https://opencv.org/>

Note	None
------	------

4.9.16 Affine

Affine

Performs parallel translation and linear transformation on the image

Configuration data file	r_drp_affine.dat
Supported version	1.00
Configuration data size (byte)	728448
Header file	r_drp_affine.h

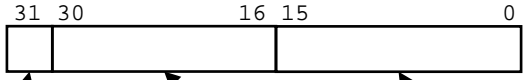
Parameter	Structure name		
	r_drp_affine_t		
	Member name	Type	Description
	src	uint32_t	Input image address
	dst	uint32_t	Output image address
	src_width	uint16_t	Input image width (pixels)
	src_height	uint16_t	Input image height (pixels)
	dst_width	uint16_t	Output image width (pixels)
	dst_height	uint16_t	Output image height (pixels)
	m_11	int32_t	Value of element at column 1, row 1 of the transform matrix converted to fixed-point format The fixed-point format is shown below.
			 <p>Sign bit Integer portion (15 bits) Fractional portion (16 bits)</p> <p>Expressible range (-32768 to +32767.9999847412109375)</p> <p>(Refer to the description for details.)</p>
	m_12	int32_t	Value of element at column 1, row 2 of the transform matrix converted to fixed-point format The fixed-point format is the same as that of m_11. (Refer to the description for details.)
	m_13	int32_t	Value of element at column 1, row 3 of the transform matrix converted to fixed-point format The fixed-point format is the same as that of m_11. (Refer to the description for details.)
	m_21	int32_t	Value of element at column 2, row 1 of the transform matrix converted to fixed-point format The fixed-point format is the same as that of m_11. (Refer to the description for details.)
	m_22	int32_t	Value of element at column 2, row 2 of the transform matrix converted to fixed-point format The fixed-point format is the same as that of m_11. (Refer to the description for details.)
	m_23	int32_t	Value of element at column 2, row 3 of the transform matrix converted to fixed-point format The fixed-point format is the same as that of m_11. (Refer to the description for details.)
	border_value	uint8_t	Output value when outside range of referenced input image

I/O details	Input image	Address:	Specified by src. (Specify an address that differs from dst.)
		Width (pixels):	Specified by src_width. (32 to 1280)
		Height (pixels):	Specified by src_height. (8 to 960)
		Format:	8-bit grayscale (1 byte per pixel)
		Data size:	(src_width) × (src_height) × 1 byte
	Output image	Address:	Specified by dst. (Specify an address that differs from src.)
		Width (pixels):	Specified by dst_width. (32 to 1280)
		Height (pixels):	Specified by dst_height. (8 to 960)
		Format:	8-bit grayscale (1 byte per pixel)
		Data size:	(dst_width) × (dst_height) × 1 byte
Number of tiles	6		
Segmented processing	Not supported		

Description This function performs affine transformation on the image at the address specified by src and outputs the result to the address specified by dst.

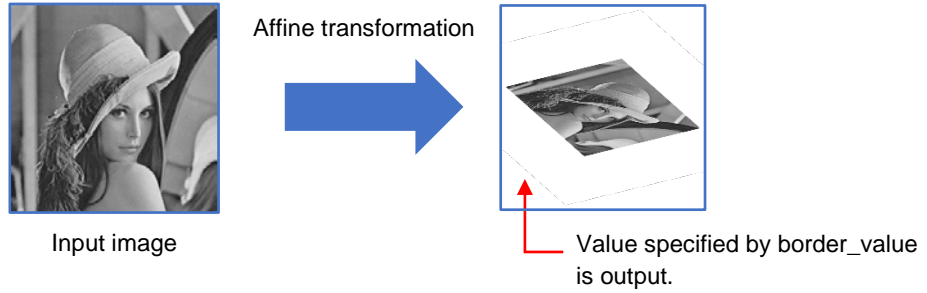

When transform matrix M is defined as follows,

$$M = \begin{pmatrix} m_{11} & m_{12} & m_{13} \\ m_{21} & m_{22} & m_{23} \\ 0 & 0 & 1 \end{pmatrix}$$

coordinates (sx,sy) of the input image are mapped to coordinates (dx,dy) expressed in the formula below by the affine transformation.

$$\begin{pmatrix} dx \\ dy \\ 1 \end{pmatrix} = M \begin{pmatrix} sx \\ sy \\ 1 \end{pmatrix}$$

For example, when enlarging or reducing the image after rotating it, and if the central coordinates of the input image during rotation are (cx,cy), the rotation angle is θ (counterclockwise rotation is the forward direction), and the image magnification is s, transform matrix M is as follows.

$$M = \begin{pmatrix} s \times \cos \theta & s \times \sin \theta & (1 - s \times \cos \theta) \times cx - s \times \sin \theta \times cy \\ -s \times \sin \theta & s \times \cos \theta & s \times \sin \theta \times cx + (1 - s \times \cos \theta) \times cy \\ 0 & 0 & 1 \end{pmatrix}$$

In addition, it is possible to create the 2 x 3 transform matrix in the box below by using OpenCV functions such as cv::getRotationMatrix2D and cv::getAffineTransform.

$$M = \begin{pmatrix} m_{11} & m_{12} & m_{13} \\ m_{21} & m_{22} & m_{23} \\ 0 & 0 & 1 \end{pmatrix}$$

Function cv::getRotationMatrix2D creates a transform matrix that rotates the image. Function cv::getAffineTransform creates a transform matrix that maps three specified points in the input and output images.

Reference URL: <https://opencv.org/>

This function calculates the input image coordinates through reverse transformation of the coordinates of the output image, then performs affine transformation. If M^{-1} is the reverse matrix of matrix M, the reverse transformation can be calculated as follows.

$$\begin{pmatrix} sx \\ sy \\ 1 \end{pmatrix} = M^{-1} \begin{pmatrix} dx \\ dy \\ 1 \end{pmatrix}$$

When calculating the output image, the function performs bilinear interpolation referencing the surrounding four pixels. For details of bilinear interpolation, refer to the description of ResizeBilinear.

The results produced by this function are equivalent to those of the OpenCV cv::warpAffine function with parameter M set to a transform matrix corresponding to affine transformation, dsize.width equal to dst_width, dsize.height equal to dst_height, flags set to INTER_LINEAR, borderMode set to BORDER_CONSTANT, and borderValue equal to border_value.

Reference URL: <https://opencv.org/>

Note It is not possible to calculate reverse matrix M^{-1} if the transform matrix M parameters are set such that $m_{11} \times m_{22} = m_{12} \times m_{21}$, so in this case border_value is output to the entire output image area.

y-coordinate map (Input)	Address:	Specified by mapy
	Width (pixels):	Specified by dst_width. (8 to 1920, integer multiple of 2)
	Height (pixels):	Specified by dst_height. (8 to 1080)
	Format :	The y-coordinate value on the input image is expressed in 16-bit unsigned fixed-point format If the value is outside of the expressible range, the data on the output image becomes border_value.

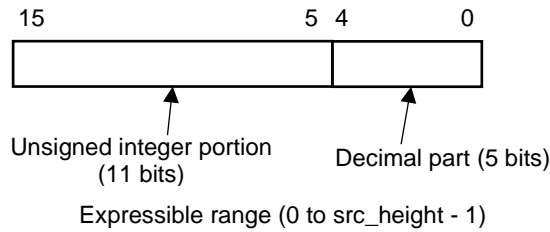

Output image	Data size:	$(dst_width) \times (dst_height) \times 2$ byte
	Address:	Specified by dst.
	Width (pixels):	Specified by dst_width. (8 to 1920, integer multiple of 2)
	Height (pixels):	Specified by dst_height. (8 to 1080)
	Format:	8-bit grayscale (1 byte per pixel)
	Data size:	$(dst_width) \times (dst_height) \times 1$ byte

Number of tiles	6
Segmented processing	Not supported

Description This function performs image conversion of the image at the address specified by src by using the x-coordinate value data of the input data at the address specified by mapx and the y-coordinate value data of the input data at the address specified by mapy, and outputs the result to the address specified by dst.

The image conversion of this function can convert the image freely such as shrinkage or flipping of up and down or left and right, so it can be used for the lens distortion correction for cameras.

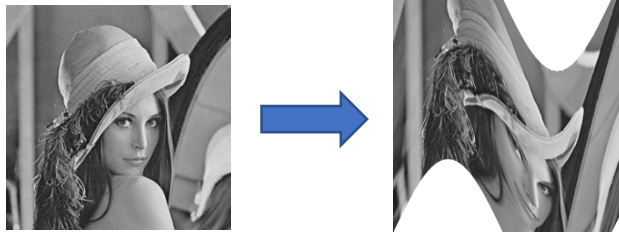

Example of image conversion using this function

Image conversion is performed through interpolating the corresponding image data from the input image based on the map information using the bi-linear method, and writing the interpolation data to the coordinates of the output image corresponding to the coordinate of the map information. When calculating the output image, the function performs bilinear interpolation referencing the surrounding four pixels of the coordinate of input image obtained from the x-coordinate map and y-coordinate map. For details of the bi-linear method, refer to 4.9.13 ResizeBilinear. If the obtained coordinate is outside the range of input image, the value of border_value is used.

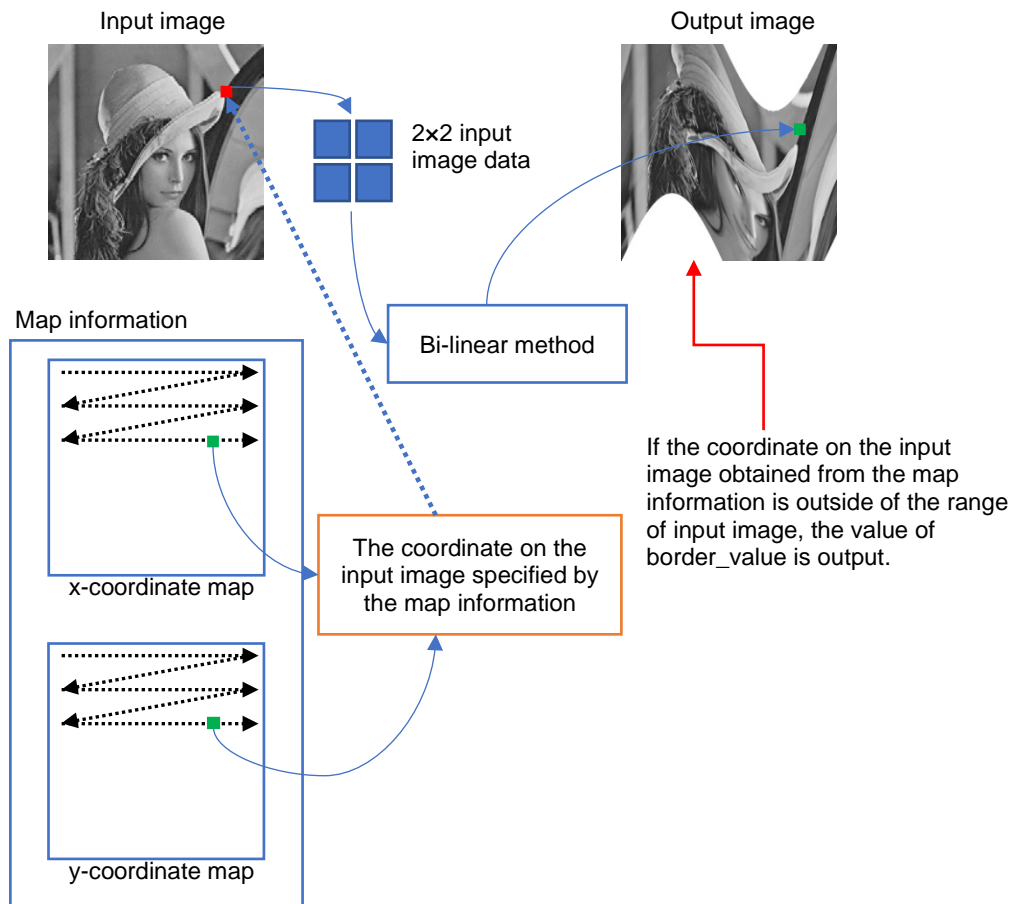

This section describes how to create map information.

“x-coordinate map” and “y-coordinate map” required for performing the image conversion such as distortion correction of an image captured by a camera, for example, can be generated by using OpenCV function `cv::initUndistortRectifyMap`. Because `initUndistortRectifyMap` function generates 32-bit floating-point type of x-coordinate map and y-coordinate map, each 32-bit floating-point-type codata needs to be transformed into an unsigned-fixed-point format that consists of the 11-bit integer part and 5-bit decimal part.

With regard to examples for creating 32-bit floating-point type of x-coordinate map and y-coordinate map other than using `initUndistortRectifyMap` function, refer to the Remapping tutorials on the OpenCV Official Website.

URL for OpenCV Official Website: <https://opencv.org/>
(Click on Tutorials, then search for “Remapping”.)

- The case of creating map information by using `initUndistortRectifyMap`

Be sure to set “CV_32FC1” for the argument “m1type” of `initUndistortRectifyMap`, and obtain the 32-bit floating-point type x-coordinate map from the argument `map1`, and the 32-bit floating-point type y-coordinate map from the argument `map2`.

- Example of transformation from 32-bit floating-point type x-coordinate map and y-coordinate map into the format that can be used in this function

```
int dst_width = 640;
int dst_height = 480;
float map_fdata;
Mat src; // Input image
Mat mapx_32f, mapy_32f; // 32-bit floating-point type x-coordinate map and y-coordinate map
Mat mapx = Mat::zeros(Size(dst_width, dst_height), CV_16U); // x-coordinate map that can be used in this function
Mat mapy = Mat::zeros(mapx.size(), CV_16U); // y-coordinate map that can be used in this function

for (int y = 0; y < mapx.rows; y++)
{
    for (int x = 0; x < mapx.cols; x++)
    {
        map_fdata = mapx_32f.at<float>(y, x);
        if ((map_fdata >= 0) && (map_fdata <= (src.cols - 1)))
        {
            mapx.at<unsigned short>(y, x) = (unsigned short)round((map_fdata * 32));
        }
        else
        {
            mapx.at<unsigned short>(y, x) = 0xffff;
        }

        map_fdata = mapy_32f.at<float>(y, x);
        if ((map_fdata >= 0) && (map_fdata <= (src.rows - 1)))
        {
            mapy.at<unsigned short>(y, x) = (unsigned short)round((map_fdata * 32));
        }
        else
        {
            mapy.at<unsigned short>(y, x) = 0xffff;
        }
    }
}
```

The processing performed by this function is equivalent to that of specifying the following for the arguments of the OpenCV `cv::remap` function.

- Apply the map in which each data of `mapx` is divided by 32 and transformed into a floating-point type to `map1`.
- Apply the map in which each data of `mapy` is divided by 32 and transformed into a floating-point type to `map2`.
- Specify `INTER_LINEAR` for the interpolation.
- Specify `BORDER_CONSTANT` for the `borderMode`.
- Specify `border_value` for the `borderValue`.

Reference URL: <https://opencv.org/>

Note	None
------	------

4.10 Image filter

4.10.1 MedianBlur

MedianBlur

Reduces the noise contained in the image

Configuration data file	r_drp_median_blur.dat		
Supported version	1.00		
Configuration data size (byte)	57312		
Header file	r_drp_median_blur.h		
Parameter	Structure name		
	r_drp_gaussian_blur_t		
	Member name	Type	Description
	src	uint32_t	Input image address
	dst	uint32_t	Output image address
	width	uint16_t	Image width (pixels)
	height	uint16_t	Image height (pixels)
	top	uint8_t	1: Top edge border processing 0: No top edge border processing Specify 1 if the input image is not segmented. For segmenting the input image for processing, specify 1 if the input image reaches the top edge of the source image, otherwise, specify 0.
	bottom	uint8_t	1: Bottom edge border processing 0: No bottom edge border processing Specify 1 if the input image is not segmented. For segmenting the input image for processing, specify 1 if the input image reaches the bottom edge of the source image, otherwise, specify 0.
I/O details	Input image	Address:	Specified by src.
		Width (pixels):	Specified by width. (24 to 1280)
		Height (pixels):	Specified by height. (8 to 960)
		Format:	8-bit grayscale (1 byte per pixel)
		Data size:	(width) × (height) × 1 byte
	Output image	Address:	Specified by dst.
		Width (pixels):	Same as input image
		Height (pixels):	Same as input image
		Format:	8-bit grayscale (1 byte per pixel)
		Data size:	(width) × (height) × 1 byte
Number of tiles	1		
Segmented processing	Supported		

Description	<p>This function uses a median filter to smooth the image at the address specified by src and outputs the result to the address specified by dst. A median filter is a type of nonlinear digital filter that is widely used to eliminate noise from images or signals.</p> <p>The function replaces the value of the target pixel with the median value of a 9-pixel block with the target pixel at its center. The 9-pixel block consists of a grid of 3 × 3 pixels with the target pixel at its center.</p> <p>The processing performed by this function is equivalent to that of the OpenCV cv::medianBlur function with 3 specified for the argument ksize.</p> <p>Reference URL: https://opencv.org/</p> <p>This function allows specification of the same address for both src and dst as long as the processing is not segmented.</p>
Note	None

4.10.2 GaussianBlur

GaussianBlur

The image smoothing

Configuration data file	r_drp_gaussian_blur.dat		
Supported version	1.00		
Configuration data size (byte)	58432		
Header file	r_drp_gaussian_blur.h		
Parameter	Structure name		
	r_drp_gaussian_blur_t		
	Member name	Type	Description
	src	uint32_t	Input image address
	dst	uint32_t	Output image address
	width	uint16_t	Image width (pixels)
	height	uint16_t	Image height (pixels)
	top	uint8_t	1: Top edge border processing 0: No top edge border processing Specify 1 if the input image is not segmented. For segmenting the input image for processing, specify 1 if the input image reaches the top edge of the source image, otherwise, specify 0.
	bottom	uint8_t	1: Bottom edge border processing 0: No bottom edge border processing Specify 1 if the input image is not segmented. For segmenting the input image for processing, specify 1 if the input image reaches the bottom edge of the source image, otherwise, specify 0.
I/O details	Input image	Address:	Specified by src.
		Width (pixels):	Specified by width. (16 to 1280)
		Height (pixels):	Specified by height. (8 to 960)
		Format:	8-bit grayscale (1 byte per pixel)
		Data size:	(width) × (height) × 1 byte
	Output image	Address:	Specified by dst.
		Width (pixels):	Same as input image
		Height (pixels):	Same as input image
		Format:	8-bit grayscale (1 byte per pixel)
		Data size:	(width) × (height) × 1 byte

Number of tiles	1									
Segmented processing	Supported									
Description	<p>This function uses a Gaussian filter to smooth the image at the address specified by src and outputs the result to the address specified by dst.</p> <p>A Gaussian filter is a type of filter used for image smoothing. It uses a Gaussian distribution in which the pixels closest to the target pixel are given the most weight. This function uses the following kernel.</p> <table border="1" style="margin-left: auto; margin-right: auto;"> <tr> <td>1/16</td> <td>2/16</td> <td>1/16</td> </tr> <tr> <td>2/16</td> <td>4/16</td> <td>2/16</td> </tr> <tr> <td>1/16</td> <td>2/16</td> <td>1/16</td> </tr> </table> <p>To calculate the value of the target pixel, weighted addition is performed based on a 3 × 3 pixels kernel with the target pixel at the center.</p> <p>The processing performed by this function is equivalent to that of the OpenCV cv::GaussianBlur function with the specification of 3 for ksize.width, 3 for ksize.height, 1.3 for sigmaX, 1.3 for sigmaY, and BORDER_REFLECT_101 for borderType.</p> <p>Reference URL: https://opencv.org/</p> <p>This function allows specification of the same address for both src and dst as long as the processing is not segmented.</p>	1/16	2/16	1/16	2/16	4/16	2/16	1/16	2/16	1/16
1/16	2/16	1/16								
2/16	4/16	2/16								
1/16	2/16	1/16								
Note	None									

4.10.3 UnsharpMasking

UnsharpMasking

The image sharpening

Configuration data file	r_drp_unsharp_masking.dat		
Supported version	1.00		
Configuration data size (byte)	156096		
Header file	r_drp_unsharp_masking.h		
Parameter	Structure name		
	r_drp_unsharp_masking_t		
	Member name	Type	Description
	src	uint32_t	Input image address
	dst	uint32_t	Output image address
	width	uint16_t	Image width (pixels)
	height	uint16_t	Image height (pixels)
	strength	uint8_t	Filter emphasis value (0 to 255) Refer to the description for details.
	top	uint8_t	1: Top edge border processing 0: No top edge border processing Specify 1 if the input image is not segmented. For segmenting the input image for processing, specify 1 if the input image reaches the top edge of the source image, otherwise, specify 0.
	bottom	uint8_t	1: Bottom edge border processing 0: No bottom edge border processing Specify 1 if the input image is not segmented. For segmenting the input image for processing, specify 1 if the input image reaches the bottom edge of the source image, otherwise, specify 0.
I/O details	Input image	Address:	Specified by src.
		Width (pixels):	Specified by width. (16 to 1280)
		Height (pixels):	Specified by height. (8 to 960)
		Format:	8-bit grayscale (1 byte per pixel)
		Data size:	(width) × (height) × 1 byte
	Output image	Address:	Specified by dst.
		Width (pixels):	Same as input image
		Height (pixels):	Same as input image
		Format:	8-bit grayscale (1 byte per pixel)
		Data size:	(width) × (height) × 1 byte
Number of tiles	2		
Segmented processing	Supported		

Description This function sharpens (enhances the edges in) the image at the address specified by src and outputs the result to the address specified by dst.

The amount of emphasis can be adjusted using the strength parameter. A larger strength value corresponds to more emphasis of the edges in the image.

For UnsharpMasking, the coefficients below used by the OpenCV `cv::filter2D()` function are typical. (k is the coefficient representing sharpening strength. A value of 0 means no sharpening.)

$-k/9$	$-k/9$	$-k/9$
$-k/9$	$1 + (8 * k/9)$	$-k/9$
$-k/9$	$-k/9$	$-k/9$

Reference URL: <https://opencv.org/>

This function uses the coefficients below, which approximate the above coefficients using a fixed decimal. k' is specified as strength.

$-k'/256$	$-k'/256$	$-k'/256$
$-k'/256$	$(9 * 28 + (8 * k'))/256$	$-k'/256$
$-k'/256$	$-k'/256$	$-k'/256$

By specifying a value 28 times the k value as strength, UnsharpMasking can be performed. For example, if a value of 28 is specified for strength, the result would be equivalent to performing UnsharpMasking when k = 1.0.

This function allows specification of the same address for both src and dst as long as the processing is not segmented.

Note None

4.10.4 Sobel

Sobel

Creates the edge of the image using Sobel filter

Configuration data file	r_drp_sobel.dat		
Supported version	1.00		
Configuration data size (byte)	40160		
Header file	r_drp_sobel.h		
Parameter	Structure name		
	r_drp_sobel_t		
	Member name	Type	Description
	src	uint32_t	Input image address
	dst	uint32_t	Output image address
	width	uint16_t	Image width (pixels)
	height	uint16_t	Image height (pixels)
	top	uint8_t	1: Top edge border processing 0: No top edge border processing Specify 1 if the input image is not segmented. For segmenting the input image for processing, specify 1 if the input image reaches the top edge of the source image, otherwise, specify 0.
	bottom	uint8_t	1: Bottom edge border processing 0: No bottom edge border processing Specify 1 if the input image is not segmented. For segmenting the input image for processing, specify 1 if the input image reaches the bottom edge of the source image, otherwise, specify 0.
I/O details	Input image	Address:	Specified by src.
		Width (pixels):	Specified by width. (16 to 1280)
		Height (pixels):	Specified by height. (8 to 960)
		Format:	8-bit grayscale (1 byte per pixel)
		Data size:	(width) × (height) × 1 byte
	Output image	Address:	Specified by dst.
		Width (pixels):	Same as input image
		Height (pixels):	Same as input image
		Format:	8-bit grayscale (1 byte per pixel)
		Data size:	(width) × (height) × 1 byte
Number of tiles	1		
Segmented processing	Supported		

Description This function uses a Sobel filter to emphasize the edges in the image at the address specified by src and outputs the result to the address specified by dst.

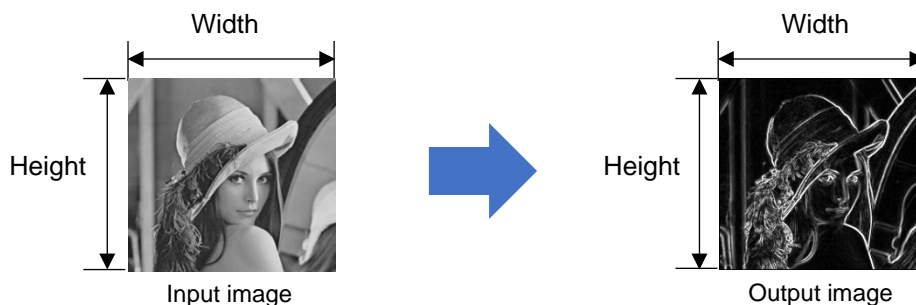

The function performs the calculations shown below on a 1 pixel band around the target pixel (an area of 3 x 3 pixels) in order to emphasize edges in the horizontal and vertical directions.

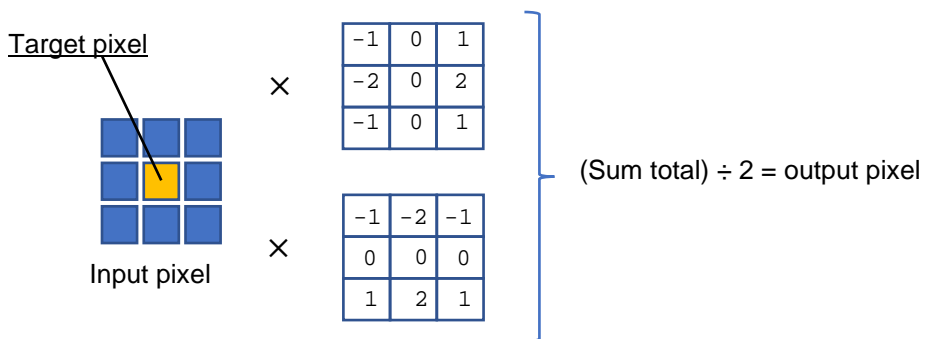

This function allows specification of the same address for both src and dst as long as the processing is not segmented.

Note None

4.10.5 Prewitt

Prewitt

Creates the edge of the image using Prewitt filter

Configuration data file	r_drp_prewitt.dat		
Supported version	1.00		
Configuration data size (byte)	40160		
Header file	r_drp_prewitt.h		
Parameter	Structure name		
	r_drp_prewitt_t		
	Member name	Type	Description
	src	uint32_t	Input image address
	dst	uint32_t	Output image address
	width	uint16_t	Image width (pixels)
	height	uint16_t	Image height (pixels)
	top	uint8_t	1: Top edge border processing 0: No top edge border processing Specify 1 if the input image is not segmented. For segmenting the input image for processing, specify 1 if the input image reaches the top edge of the source image, otherwise, specify 0.
	bottom	uint8_t	1: Bottom edge border processing 0: No bottom edge border processing Specify 1 if the input image is not segmented. For segmenting the input image for processing, specify 1 if the input image reaches the bottom edge of the source image, otherwise, specify 0.
I/O details	Input image	Address:	Specified by src.
		Width (pixels):	Specified by width. (16 to 1280)
		Height (pixels):	Specified by height. (8 to 960)
		Format:	8-bit grayscale (1 byte per pixel)
		Data size:	(width) × (height) × 1 byte
	Output image	Address:	Specified by dst.
		Width (pixels):	Same as input image
		Height (pixels):	Same as input image
		Format:	8-bit grayscale (1 byte per pixel)
		Data size:	(width) × (height) × 1 byte
Number of tiles	1		
Segmented processing	Supported		

Description This function uses a Prewitt filter to emphasize the edges in the image at the address specified by src and outputs the result to the address specified by dst.

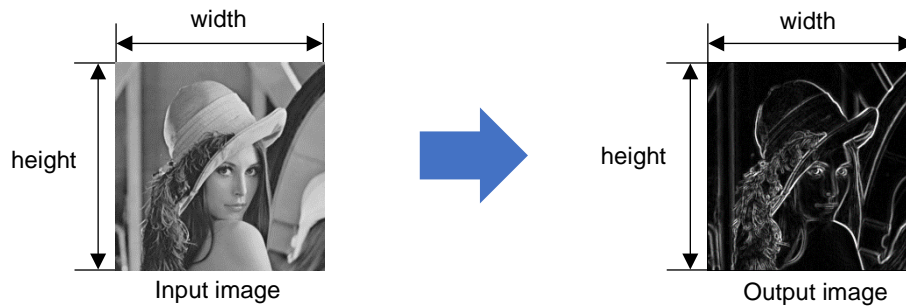

The function performs the calculations shown below on a 1 pixel band around the target pixel (an area of 3 × 3 pixels) in order to emphasize edges in the horizontal and vertical directions.

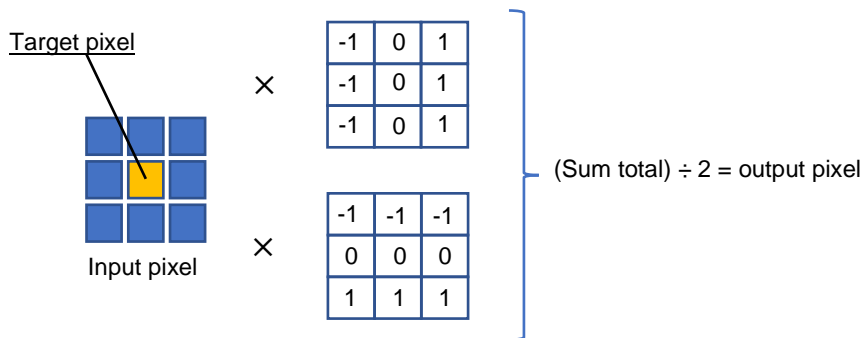

This function allows specification of the same address for both src and dst as long as the processing is not segmented.

Note None

4.10.6 Laplacian

Laplacian

Creates the edge of the image using Laplacian filter

Configuration data file	r_drp_laplacian.dat		
Supported version	1.00		
Configuration data size (byte)	36704		
Header file	r_drp_laplacian.h		
Parameter	Structure name		
	r_drp_laplacian_t		
	Member name	Type	Description
	src	uint32_t	Input image address
	dst	uint32_t	Output image address
	width	uint16_t	Image width (pixels)
	height	uint16_t	Image height (pixels)
	top	uint8_t	1: Top edge border processing 0: No top edge border processing Specify 1 if the input image is not segmented. For segmenting the input image for processing, specify 1 if the input image reaches the top edge of the source image, otherwise, specify 0.
	bottom	uint8_t	1: Bottom edge border processing 0: No bottom edge border processing Specify 1 if the input image is not segmented. For segmenting the input image for processing, specify 1 if the input image reaches the bottom edge of the source image, otherwise, specify 0.
	kernel	uint8_t	0: Use $\begin{pmatrix} 0 & 1 & 0 \\ 1 & -4 & 1 \\ 0 & 1 & 0 \end{pmatrix}$ as filter coefficients 1: Use $\begin{pmatrix} 2 & 0 & 2 \\ 0 & -8 & 0 \\ 2 & 0 & 2 \end{pmatrix}$ as filter coefficients Specify either 0 or 1.
I/O details	Input image	Address:	Specified by src.
		Width (pixels):	Specified by width. (16 to 1280)
		Height (pixels):	Specified by height. (8 to 960)
		Format:	8-bit grayscale (1 byte per pixel)
		Data size:	(width) × (height) × 1 byte
	Output image	Address:	Specified by dst.
		Width (pixels):	Same as input image
		Height (pixels):	Same as input image
		Format:	8-bit grayscale (1 byte per pixel)
		Data size:	(width) × (height) × 1 byte
Number of tiles	1		
Segmented processing	Supported		

Description This function uses a Laplacian filter to emphasize the edges in the image at the address specified by src and outputs the result to the address specified by dst.

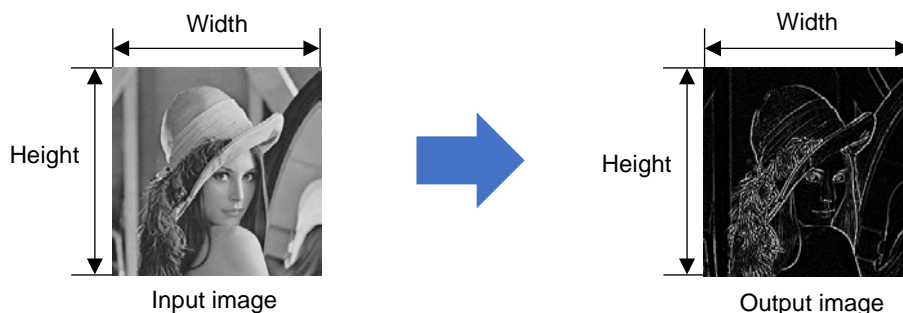

This function performs the calculations shown below on a 1 pixel band around the target pixel (an area of 3 × 3 pixels) in order to emphasize edges.

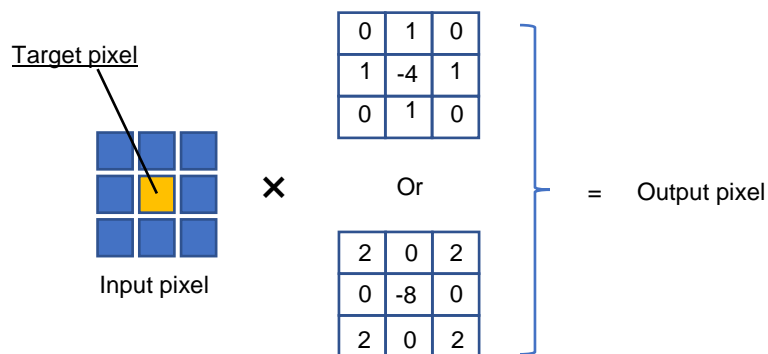

The results produced by this function are equivalent to those of the OpenCV cv::Laplacian function with ddepth set to CV_8U, ksize set to 1 or 3, scale set to 1.0, delta set to 0, and borderType set to BORDER_REFLECT_101. The setting ksize = 1 is equivalent to kernel = 0 in this function, and ksize = 3 is equivalent to kernel = 1.

Reference URL: <https://opencv.org/>

This function allows specification of the same address for both src and dst as long as the processing is not segmented.

Note None

4.10.7 Dilate

Dilate

Dilation of white part in the image

Configuration data file	r_drp_dilate.dat		
Supported version	1.00		
Configuration data size (byte)	56320		
Header file	r_drp_dilate.h		
Parameter	Structure name		
	r_drp_dilate_t		
	Member name	Type	Description
	src	uint32_t	Input image address
	dst	uint32_t	Output image address
	width	uint16_t	Image width (pixels)
	height	uint16_t	Image height (pixels)
	top	uint8_t	1: Top edge border processing 0: No top edge border processing Specify 1 if the input image is not segmented. For segmenting the input image for processing, specify 1 if the input image reaches the top edge of the source image, otherwise, specify 0.
	bottom	uint8_t	1: Bottom edge border processing 0: No bottom edge border processing Specify 1 if the input image is not segmented. For segmenting the input image for processing, specify 1 if the input image reaches the bottom edge of the source image, otherwise, specify 0.
I/O details	Input image	Address:	Specified by src.
		Width (pixels):	Specified by width. (16 to 1280)
		Height (pixels):	Specified by height. (8 to 960)
		Format:	8-bit grayscale (1 byte per pixel)
		Data size:	(width) × (height) × 1 byte
	Output image	Address:	Specified by dst.
		Width (pixels):	Same as input image
		Height (pixels):	Same as input image
		Format:	8-bit grayscale (1 byte per pixel)
		Data size:	(width) × (height) × 1 byte
Number of tiles	1		
Segmented processing	Supported		

Description This function expands the bright portions of the image at the address specified by src and outputs the result to the address specified by dst.

The maximum value of the 3 × 3 block with the target pixel at the center is set as the new value of the target pixel. When a black and white binary image is input, the white portions appear to expand outward around the pixel. The processing performed is similar to that of the OpenCV cv::dilate() function when border processing is set to BORDER_REPLICATE.

Reference URL: <https://opencv.org/>

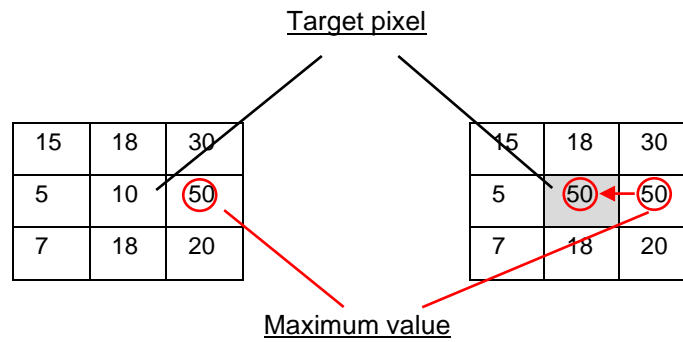

A processing example using a binarized image as the input image is shown below.

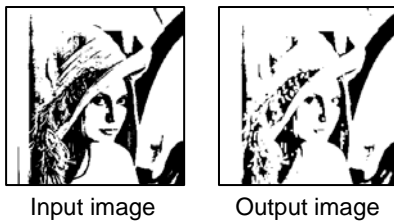

This function allows specification of the same address for both src and dst as long as the processing is not segmented.

Note None

4.10.8 Erode

Erode

Erosion of white part in the image

Configuration data file	r_drp_erode.dat		
Supported version	1.00		
Configuration data size (byte)	60352		
Header file	r_drp_erode.h		
Parameter	Structure name		
	r_drp_erode_t		
	Member name	Type	Description
	src	uint32_t	Input image address
	dst	uint32_t	Output image address
	width	uint16_t	Image width (pixels)
	height	uint16_t	Image height (pixels)
	top	uint8_t	1: Top edge border processing 0: No top edge border processing Specify 1 if the input image is not segmented. For segmenting the input image for processing, specify 1 if the input image reaches the top edge of the source image, otherwise, specify 0.
	bottom	uint8_t	1: Bottom edge border processing 0: No bottom edge border processing Specify 1 if the input image is not segmented. For segmenting the input image for processing, specify 1 if the input image reaches the bottom edge of the source image, otherwise, specify 0.
I/O details	Input image	Address:	Specified by src.
		Width (pixels):	Specified by width. (16 to 1280)
		Height (pixels):	Specified by height. (8 to 960)
		Format:	8-bit grayscale (1 byte per pixel)
		Data size:	(width) × (height) × 1 byte
	Output image	Address:	Specified by dst.
		Width (pixels):	Same as input image
		Height (pixels):	Same as input image
		Format:	8-bit grayscale (1 byte per pixel)
		Data size:	(width) × (height) × 1 byte
Number of tiles	1		
Segmented processing	Supported		

Description This function contracts the bright portions of the image at the address specified by src and outputs the result to the address specified by dst.

The maximum value of the 3 × 3 block with the target pixel at the center is set as the new value of the target pixel. When a black and white binary image is input, the white portions appear to contract outward around the pixel. The processing performed is similar to that of the OpenCV cv::erode() function when border processing is set to BORDER_REPLICATE.

Reference URL: <https://opencv.org/>

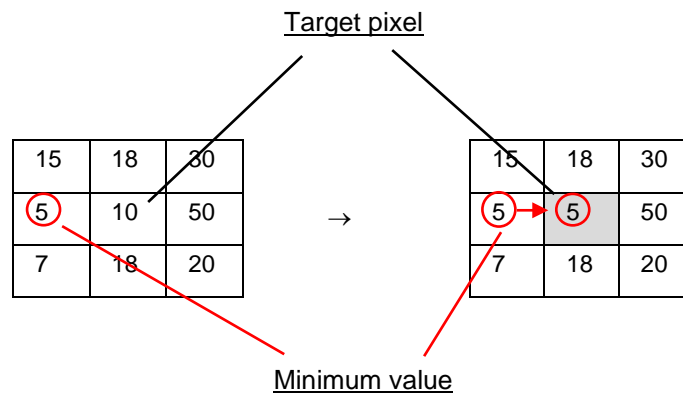

A processing example using a binarized image as the input image is shown below.



This function allows specification of the same address for both src and dst as long as the processing is not segmented.

Note None

4.10.9 Opening

Opening

Removes noise from black portions by shrinkage (erosion) followed by expansion (dilation)

Description Opening involves the repeated application of shrinkage (erosion) within the white parts, followed by the repeated application of expansion (dilation). The erosion and dilation are repeated the same number of times. This is useful for eliminating noise in monochrome images.

In other words, this processing involves the application of a combination of the Erode and Dilate functions of the DRP Library. Refer to the respective sections for the specifications of the Erode function and the Dilate function.

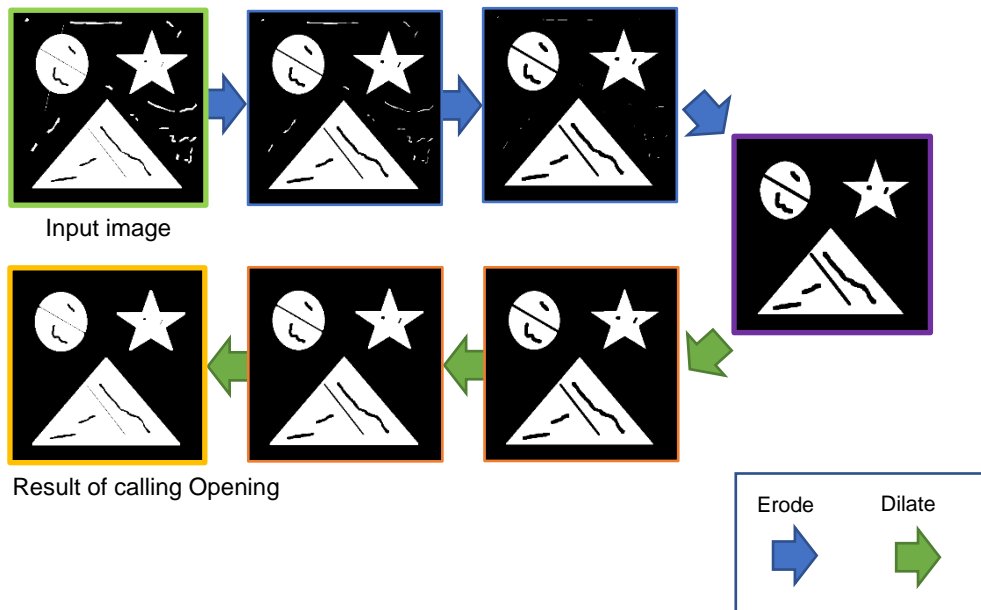

The explanation of the Opening processing is for when the number of iterations of both the Erode and Dilate functions is three.

Erosion

An overview of repeating Erode processing three times is shown below.

In the first iteration of Erode processing, the image which is input is set as the input image for processing by the Erode function.

In the second iteration of Erode processing, the output image of the first iteration is set as the input image for processing by the Erode function.

In the third iteration of Erode processing, the output image of the second iteration is set as the input image for processing by the the Erode function.

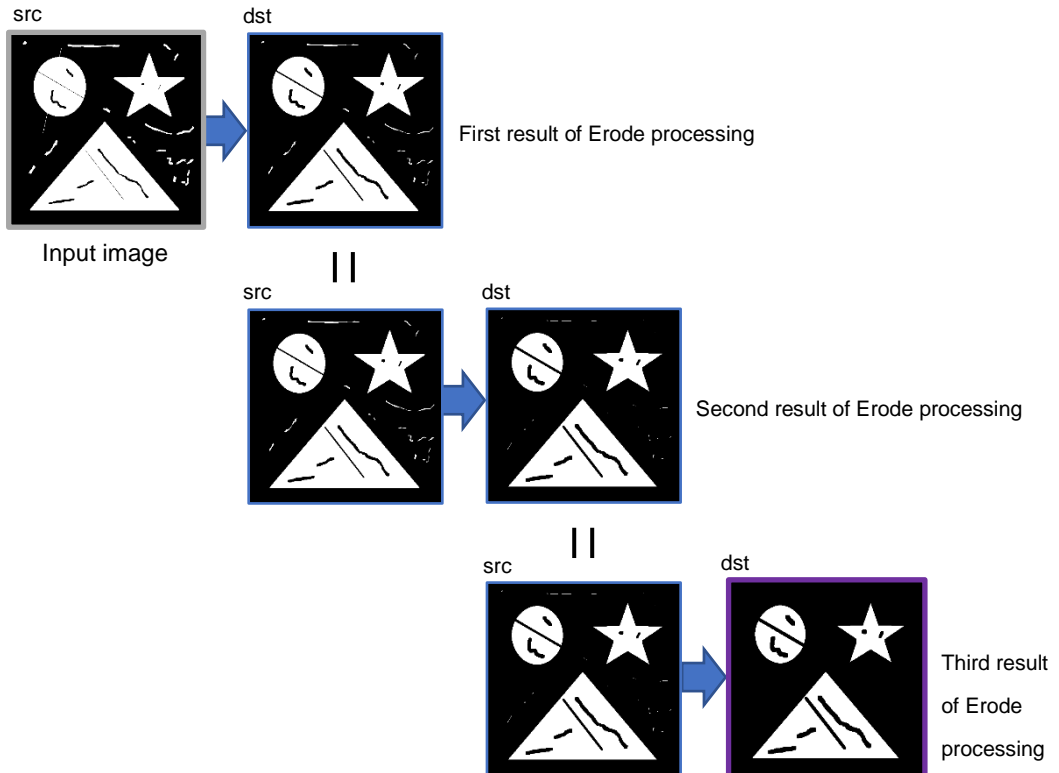

Dilation

An overview of repeating Dilate processing three times is shown below.

In the first iteration of Dilate processing, the output image of the third Erode processing is set as the input image for processing by the Dilate function.

In the second iteration of Dilate processing, the output image of the first iteration is set as the input image for processing by the Dilate function.

In the third iteration of Dilate processing, the output image of the second iteration is set as the input image for processing by the Dilate function.

The output image of the third Dilate processing becomes the result image of performing Opening.

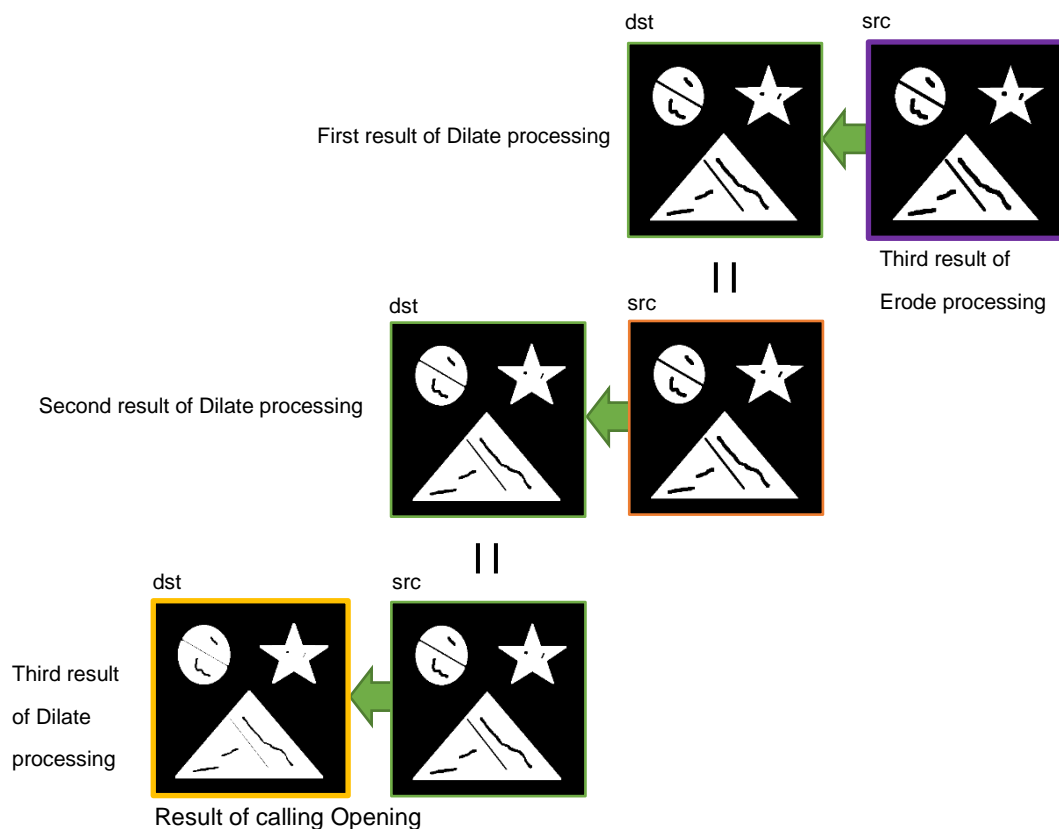

The processing performed by this function is equivalent to that of the OpenCV `cv::morphologyEx` function with specifying `MORPH_OPEN` to the argument `op`, `cv::Mat()` to kernel, `Point(-1,-1)` to anchor, the iteration number to `iterations`, and `BORDER_REPLICATE` to `borderType`.

Reference URL: <https://opencv.org/>

Note If the processing of Erode and Dilate is to be segmented, only proceed with a next stage of processing after all segments of the resulting images in the current stage have been obtained.

4.10.10 Closing

Closing

Removes noise from white portions by expansion (dilation) followed by shrinkage (erosion)

Description Closing involves the repeated application of expansion (dilation) within the white parts, followed by the repeated application of shrinkage (erosion). The dilation and erosion are repeated the same number of times. This is useful for eliminating noise in monochrome images.

In other words, this processing involves the application of a combination of the Dilate and Erode functions of the DRP Library. Refer to the respective sections for the specifications of the Dilate function and the Erode function.

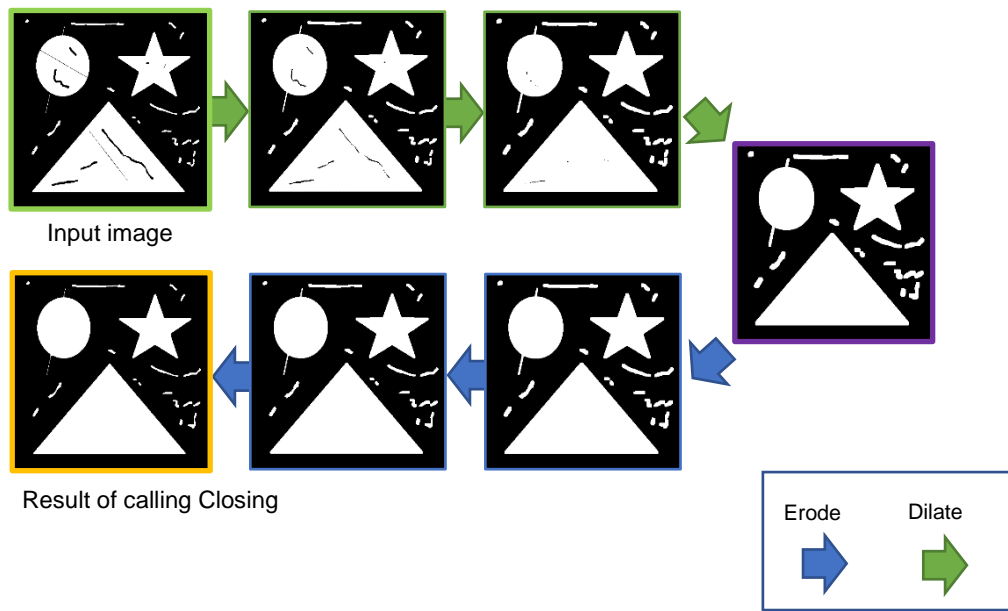

The explanation of the Closing processing is for when the number of iterations of both the Dilate and Erode functions is three.

Dilation

An overview of repeating Dilate processing three times is shown below.

In the first iteration of Dilate processing, the image which is input is set as the input image for processing by the Dilate function.

In the second iteration of Dilate processing, the output image of the first iteration is set as the input image for processing by the Dilate function.

In the third iteration of Dilate processing, the output image of the second iteration is set as the input image for processing by the Dilate function.

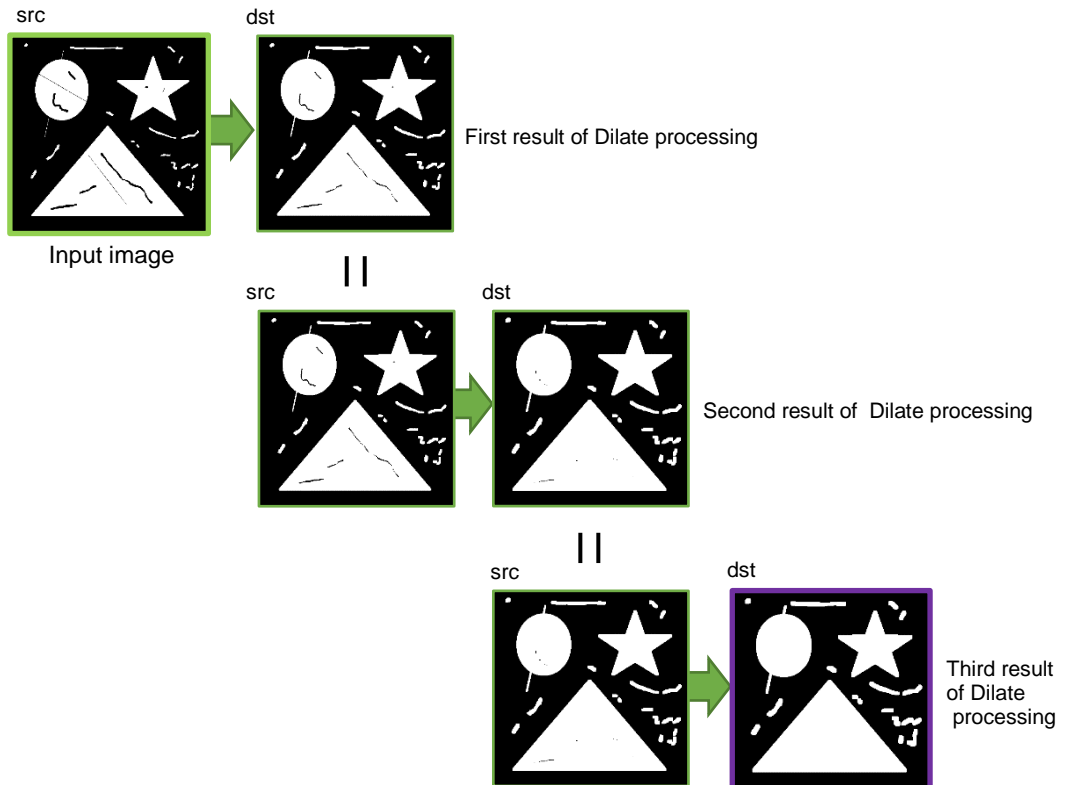

Erosion

An overview of repeating Erode processing three times is shown below.

In the first iteration of Erode processing, the output image of the third Dilate processing is set as the input image for processing by the Erode function.

In the second iteration of Erode processing, the output image of the first iteration is set as the input image for processing by the Erode function.

In the third iteration of Erode processing, the output image of the second iteration is set as the input image for processing by the Erode function.

The output image of the third Erode processing becomes the result image of performing Closing.

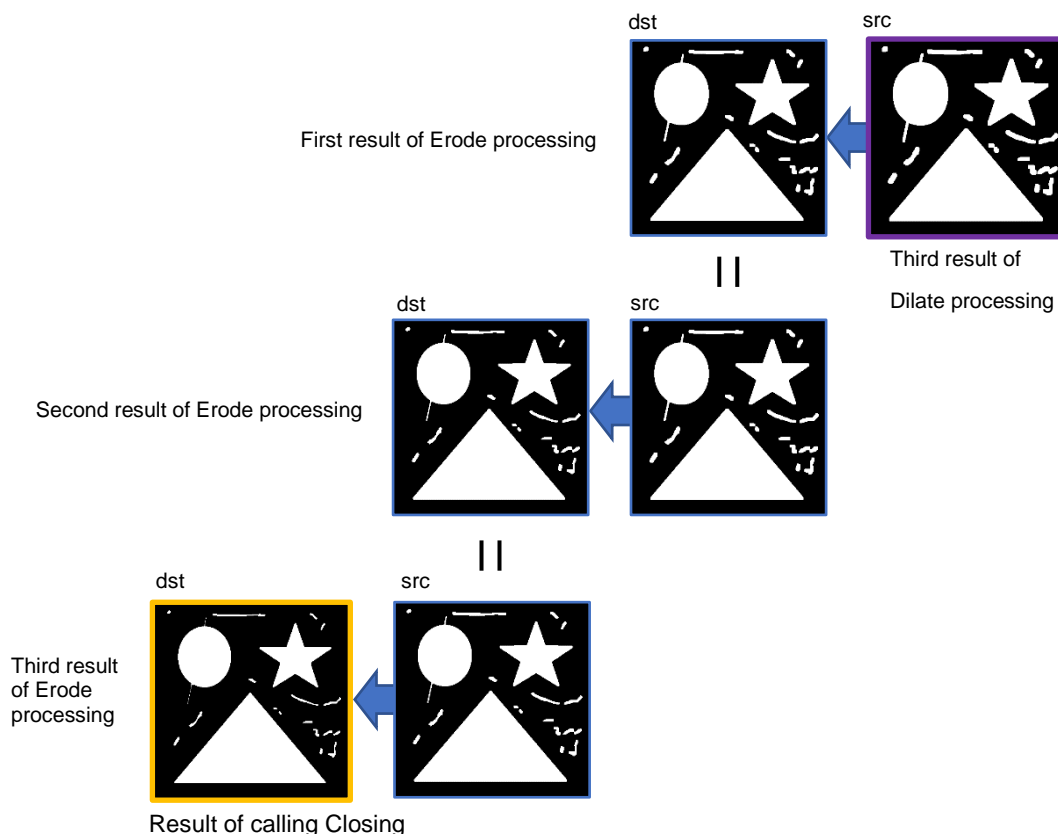

The processing performed by this function is equivalent to that of the OpenCV `cv::morphologyEx` function with specifying `MORPH_CLOSE` to the argument `op`, `cv::Mat()` to kernel, `Point(-1,-1)` to anchor, the iteration number to `iterations`, and `BORDER_REPLICATE` to `borderType`.

Reference URL: <https://opencv.org/>

Note If the processing of Dilate and Erode is to be segmented, only proceed with a next stage of processing after all segments of the resulting images in the current stage have been obtained.

4.11 Feature Detection

4.11.1 CannyCalculate

CannyCalculate

Canny edge detection

Configuration data file	r_drp_canny_calculate.dat		
Supported version	1.00		
Configuration data size (byte)	124736		
Header file	r_drp_canny_calculate.h		
Parameter	Structure name		
	r_drp_canny_calculate_t		
	Member name	Type	Description
	src	uint32_t	Input image address
	dst	uint32_t	Output image address
	width	uint16_t	Image width (pixels)
	height	uint16_t	Image height (pixels)
	work	uint32_t	Work area address
	threshold_high	uint8_t	Edge upper limit determination value ((threshold_low + 1) to 255)
	threshold_low	uint8_t	Edge lower limit determination value (0 to (threshold_high - 1))
	top	uint8_t	1: Top edge border processing 0: No top edge border processing Specify 1 if the input image is not segmented. For segmenting the input image for processing, specify 1 if the input image reaches the top edge of the source image, otherwise, specify 0.
	bottom	uint8_t	1: Bottom edge border processing 0: No bottom edge border processing Specify 1 if the input image is not segmented. For segmenting the input image for processing, specify 1 if the input image reaches the bottom edge of the source image, otherwise, specify 0.
I/O details	Input image	Address:	Specified by src.
		Width (pixels):	Specified by width. (16 to 1280, integer multiple of 16)
		Height (pixels):	Specified by height. (16 to 960, integer multiple of 4)
		Format:	8-bit grayscale (1 byte per pixel)
		Data size:	(width) × (height) × 1 byte
	Output image	Address:	Specified by dst.
		Width (pixels):	Same as input image
		Height (pixels):	Same as input image
		Format:	8-bit edge candidates (3 categories: 0, 1, and 2) 0: Non-edge 1: Weak edge 2: Strong edge (1 byte per pixel)
		Data size:	(width) × (height) × 1 byte
	Work area	Address:	Specified by work.
		Data size:	((width) × (height + 2)) × 2 bytes
		Description	The area used to store edge strength and edge direction data. Refer to the explanation below for more on edge strength and edge direction.

Number of tiles	2
Segmented processing	Supported
Description	This function uses the Canny method to find edge candidates in the image at the address specified by src and outputs the result to the address specified by dst.

Canny edge detection produces few edge detection errors. It is also capable of outputting edges as thin lines. Canny edge detection consists of the following processing steps, performed in the order shown:

1. Noise is eliminated (Gaussian filter).
2. The edge strength and degree of accuracy is calculated, non-maximum values are suppressed, and the edges are classified.
3. Edges are determined by hysteresis threshold processing.

The OpenCV `cv::Canny()` function performs the processing of 2. and 3. above. This library produces similar edge output by using the `GaussianBlur` function for step 1, the `CannyCalculate` function for step 2, and the `CannyHysteresis` function for step 3.

Reference URL: <https://opencv.org/>

The edge candidates output by the function fall into 3 categories based on edge strength: non-edge, weak edge, and strong edge. The thresholds for determining weak edges and strong edges are set by the `threshold_low` and `threshold_high` parameters. The lower the thresholds, the larger the number of edge candidates.

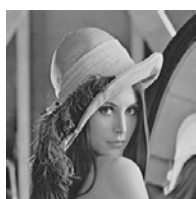

Input image



Output image
threshold_low=0x18
threshold_high=0x30

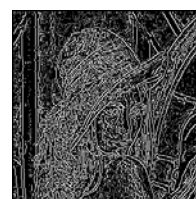

Output image
threshold_low=0x05
threshold_high=0x28

Display characteristics used:

Gray: Weak edge

White: Strong edge

The function calculates the edge strength and direction as described below.

$$G_x = \begin{bmatrix} G_{00} & G_{01} & G_{02} \\ G_{10} & G_{11} & G_{12} \\ G_{20} & G_{21} & G_{22} \end{bmatrix} \times \begin{bmatrix} -1 & 0 & 1 \\ -2 & 0 & 2 \\ -1 & 0 & 1 \end{bmatrix}$$

$$G_y = \begin{bmatrix} G_{00} & G_{01} & G_{02} \\ G_{10} & G_{11} & G_{12} \\ G_{20} & G_{21} & G_{22} \end{bmatrix} \times \begin{bmatrix} -1 & -2 & -1 \\ 0 & 0 & 0 \\ 1 & 2 & 1 \end{bmatrix}$$

$$\text{Edge strength} = ((G_x)^2 + (G_y)^2) \gg 7$$

if (3 * abs(Gx) <= 8 * abs(Gy)) // 21 degrees or less

Edge direction = DIR0

else if (20 * abs(Gx) > 8 * abs(Gy)) // More than 67 degrees

Edge direction = DIR90

else

Edge direction = (sign(Gx)==sign(Gy)) ? DIR45 : DIR135

Note	None
------	------

4.11.2 CannyHysteresis

CannyHysteresis

Threshold processing using hysteresis

Configuration data file	r_drp_canny_hysteresis.dat		
Supported version	1.00		
Configuration data size (byte)	375776		
Header file	r_drp_canny_hysteresis.h		
Parameter	Structure name		
	r_drp_canny_hysteresis_t		
	Member name	Type	Description
	src	uint32_t	Input image address
	dst	uint32_t	Output image address
	width	uint16_t	Image width (pixels)
	height	uint16_t	Image height (pixels)
	work	uint32_t	Work area address
	iterations	uint8_t	Maximum number of iterations (1 to 254) Infinite number of iterations (255)
I/O details	Input image	Address:	Specified by src.
		Width (pixels):	Specified by width. (16 to 1280, integer multiple of 8)
		Height (pixels):	Specified by height. (16 to 960, integer multiple of 4)
		Format:	Edge candidate (3 values: 0, 1, or 2) 0: Non-edge 1: Weak edge 2: Strong edge (1 byte per pixel)
		Data size:	(width) × (height) × 1 byte
	Output image	Address:	Specified by dst.
		Width (pixels):	Same as input image
		Height (pixels):	Same as input image
		Format:	Detected edge (2 values: 0 or 255) 0: Non-edge 255: Edge (1 byte per pixel)
		Data size:	(width) × (height) × 1 byte
	Work area	Address:	Specified by work.
		Data size:	(width) × (height) × 1 byte
		Description	The area used to store data during hysteresis processing.

Number of tiles	6
Segmented processing	Not supported
Description	This function performs hysteresis threshold processing on the image (edge candidates) at the address specified by src and outputs the resulting edge image to the address specified by dst. (Edge detection using the Canny method is the second part of the processing. For details, refer to the description of the CannyCalculate function.)

In hysteresis threshold processing the input edge candidates are checked, each weak edge that is connected to a strong edge is output as an edge, and each weak edge that is not connected to a strong edge is output as a non-edge.

Checking is performed to confirm connections both above and below. When a weak edge is determined to be an edge, any weak edge connected to that edge must also be checked, so the processing is repeated up to the maximum number of iterations. If search continue twice that do not change to strong edge continue, the process ends. (The processing time and accuracy should be considered when choosing the setting value.)

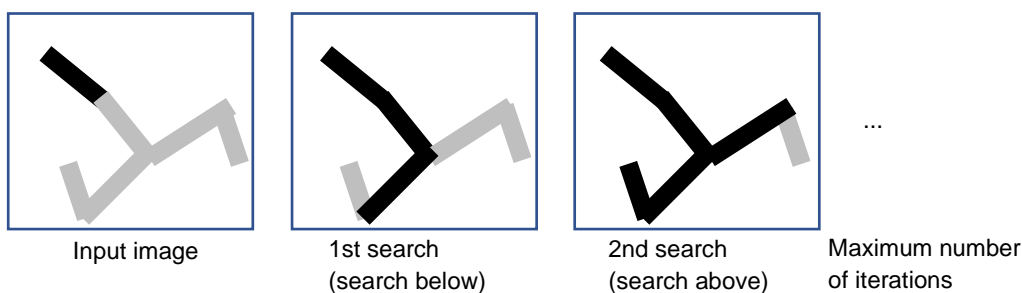

Display characteristics used: Weak edge changed to strong edge, so continue. Weak edge changed to strong edge, so continue.

Gray: Weak edge

Black: Strong edge

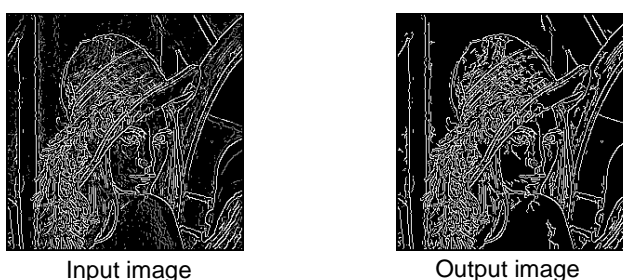

Display characteristics used:
 Gray: Weak edge
 White: Strong edge

Note	None
------	------

4.11.3 CornerHarris

CornerHarris

Detects the corner contained in the image using the method devised by Chris Harris

Configuration data file	r_drp_corner_harris.dat		
Supported version	1.00		
Configuration data size (byte)	408064		
Header file	r_drp_corner_harris.h		
Parameter	Structure name		
	r_drp_corner_harris_t		
	Member name	Type	Description
	src	uint32_t	Input image address
	dst	uint32_t	Output image address
			Stores the response of the Harris detector.
	width	uint16_t	Image width (pixels)
	height	uint16_t	Image height (pixels)
	shift	uint8_t	Harris detector response right-shift amount
			This function right-shifts the 32-bit Harris detector response by the amount specified by this argument, and outputs the result as the saturation calculation with a value from 0 to 255. Since Harris detector response values are often in the range from 256 to 65,535, a setting value is 8 is recommended.
I/O details	Input image	Address:	Specified by src.
		Width (pixels):	Specified by width. (16 to 1280)
		Height (pixels):	Specified by height. (8 to 960)
		Format:	8-bit grayscale (1 byte per pixel)
		Data size:	(width) × (height) × 1 byte
	Output image (Harris detector response)	Address:	Specified by dst.
		Width (pixels):	Same as input image
		Height (pixels):	Same as input image
		Format:	Vertex detection result (0 to 255)
			The larger the value, the greater the likelihood of a vertex.
			(1 byte per pixel)
		Data size:	(width) × (height) × 1 byte

Number of tiles	6
Segmented processing	Not supported

Description This function applies a Harris detector to the image at the address specified by src, detects vertexes within the image, and outputs the result to the address specified by dst.

The Harris detector recognizes vertexes by identifying cases where the characteristics of the immediate vicinity of the target pixel differ from the characteristics of the periphery.

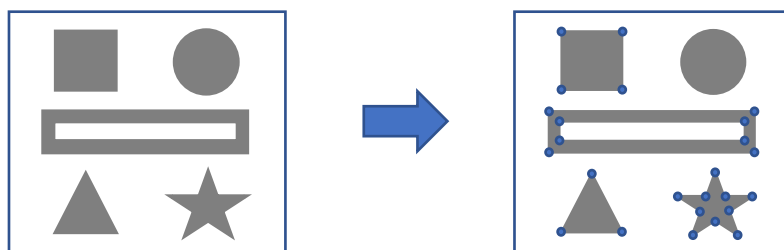

A simplified representation of detection of vertexes in the input image

The calculations performed by the Harris detector are as follows. The sum of the slopes in the entirety of the 3 × 3 pixel adjacent area is calculated to obtain a 2 × 2 slope distribution matrix ($M^{(x,y)}$) for the target pixel. Then the following feature value is calculated.

$$dst(x, y) = \det M^{(x,y)} - k(\text{tr} M^{(x,y)})^2$$

The intrinsic coefficient of corner detection quantity is represented as k , and experience shows that a value of 0.04 is 0.15 is good. This function uses a value of 0.0625.

The processing performed by this function is equivalent to that of the OpenCV `cv::cornerHarris` function with the specification of 3 for `blockSize` argument, 3 for `apertureSize`, 0.0625 for k , and `BORDER_REFLECT_101` for `borderType`.

Reference URL: <https://opencv.org/>

This function allows the same address to be specified for both src and dst.

Note	None
------	------

4.11.4 MinutiaeExtract

MinutiaeExtract

Extracts minutiae points of fingerprint ridge lines used in fingerprint recognition

Configuration data file	r_drp_minutiae_extract.dat		
Supported version	1.00		
Configuration data size (byte)	132768		
Header file	r_drp_minutiae_extract.h		
Parameter	Structure name		
	r_drp_minutiae_extract_t		
	Member name	Type	Description
	src	uint32_t	Input image address
	width	uint16_t	Image width (pixels)
	height	uint16_t	Image height (pixels)
	threshold	uint8_t	Binarization threshold (0 to 255)
	minutiae_data	uint32_t	Address of minutiae point data
	minutiae_num	uint32_t	Address of minutiae point count
	minutiae_max	uint32_t	Max. number of minutiae points (1 to 2048)
	e_area_startx	uint16_t	X coordinate of extraction area start position
	e_area_starty	uint16_t	Y coordinate of extraction area start position
	e_area_width	uint16_t	Width of extraction area
	e_area_height	uint16_t	Height of extraction area
I/O details	Input image	Address:	Specified by src.
		Width (pixels):	Specified by width. (40 to 1280, integer multiple of 4)
		Height (pixels):	Specified by height. (18 to 960)
		Format:	8-bit grayscale (1 byte per pixel) Values equal to or less than threshold are treated as black, and other values as white.
		Data size:	(width) × (height) × 1 byte
	Extraction area (input)	Start position X coordinate:	Specified by e_area_startx. (4 to width – 36, multiple of 4)
		Start position Y coordinate:	Specified by e_area_starty. (1 to height – 17)
		Width (pixels):	Specified by e_area_width. (32 to width – e_area_startx – 4, multiple of 4)
		Height (pixels):	Specified by e_area_height. (16 to height – e_area_starty – 1)
		Description	This is the area of the input image from which minutiae points are extracted. The 4 pixels on the left and right of the input image cannot be specified as part of the extraction area. The 1 pixel at the top and bottom of the input image cannot be specified as part of the extraction area. Refer to the description for details.

Minutiae point data (output)	Address:	Specified by minutiae_data.
	Data size:	minutiae_max × 8 bytes (32 to e_area_width × e_area_height × 8)
	Format:	Starting from the address, X coordinate of extracted minutiae point (2 bytes), Y coordinate of extracted minutiae point (2 bytes), type of extracted minutiae point (1 byte), direction of extracted minutiae point (1 byte), 0 padding (2 bytes)

Description

Starting from the address, the X and Y coordinates, type, and direction of each minutiae point are output as an 8-byte unit.
 Note that when the number of extracted minutiae points exceeds minutiae_max, only the number of minutiae points specified by minutiae_max is output.
 The minutiae point type is either ridge ending (0) or ridge bifurcation (1).
 The minutiae point direction consists of 8 bits of data, starting with bit 0 to the upper left of the target pixel and proceeding clockwise through the adjacent pixels, indicating the positions that are white.
 Refer to the description for details.

Minutiae point count (output)	Address:	Specified by minutiae_num.
	Data size:	4 bytes
	Format:	Number of extracted minutiae points (4 bytes)

Description

The number of extracted minutiae points is output.
 The actual number of minutiae points extracted is output, even if it exceeds minutiae_max.
 Refer to the description for details.

Number of tiles	3
Segmented processing	Not supported. However, segmented processing can be achieved in combination with processing on the CPU. Refer to the description for details.

Description This function binarizes the image at the address specified by src and extracts minutiae points to identify ridge ending and bifurcation points in the image. It is necessary that the input image undergo thinning in order to achieve accurate minutiae detection. The extraction results are output as minutiae_data, and the number of minutiae points extracted is output as minutiae_num.

This function performs processing up to the extraction of minutiae points. The extracted minutiae point data typically requires further processing, such as the deletion of unnecessary minutiae points. The MinutiaeDelete function contained in the library is one example of such processing. For details, refer to the description of the MinutiaeDelete function.

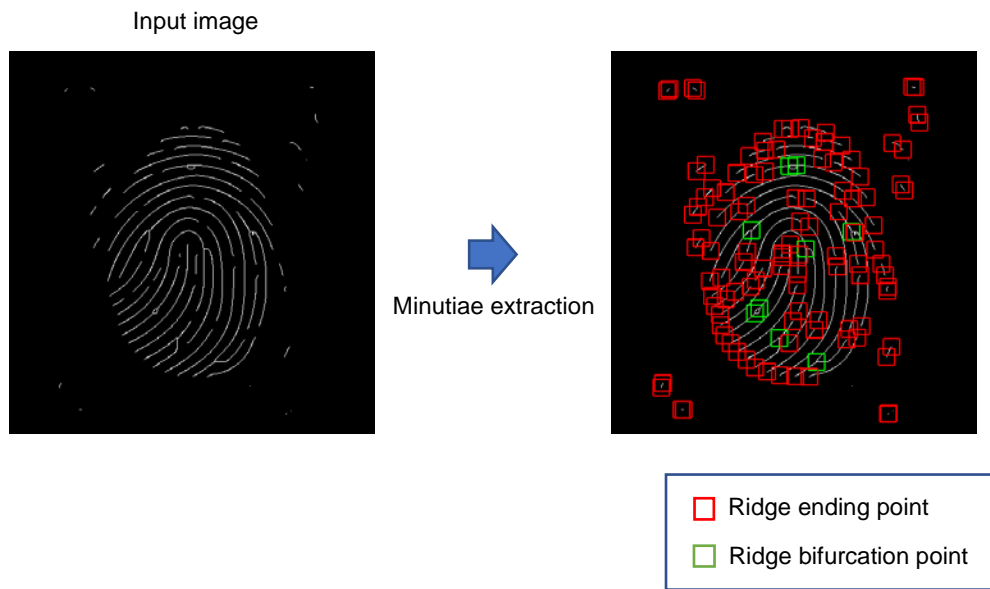

In minutiae extraction, fingerprint minutiae points are identified according to information on target pixels and their adjacent pixels in an image that has been subjected to thinning. The data on each minutiae point includes the X and Y coordinates within the fingerprint, whether the point is a ridge ending or bifurcation point, and the direction of the ending or bifurcation.

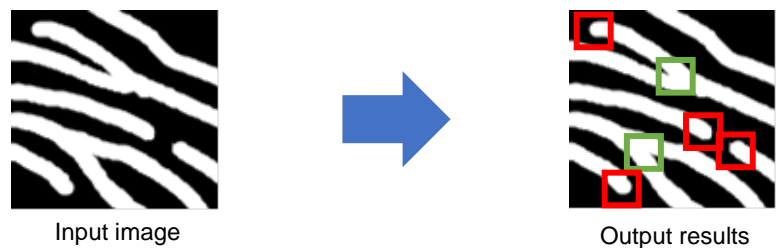

In minutiae extraction, a range encompassing the single pixels adjacent to the target pixel (range of 3×3 pixels) is examined, and the number of times the color changes between one pixel and the one next to it (white to black, or black to white) are counted. If the number of changes is two, the point is classified as a ridge ending point, and if it is five or more, the point is classified as a ridge bifurcation point.

The value of threshold is used to determine whether a pixel is white or black. If the brightness of the pixel in the input image is greater than threshold, it is considered to be white.

Target pixel

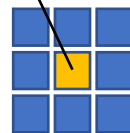

Input pixel

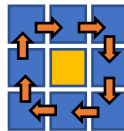

- Examples with two changes

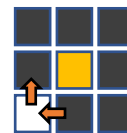
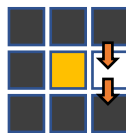
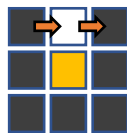

Ridge ending point

- Examples with five or more changes

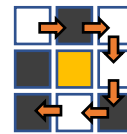
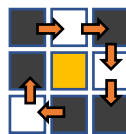
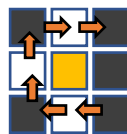

Ridge bifurcation point

In minutiae extraction, direction information is extracted in addition to bifurcation and ending point information. The minutiae point direction information indicates the positions adjacent to the target pixel that are white, converted into 8 bits of data.

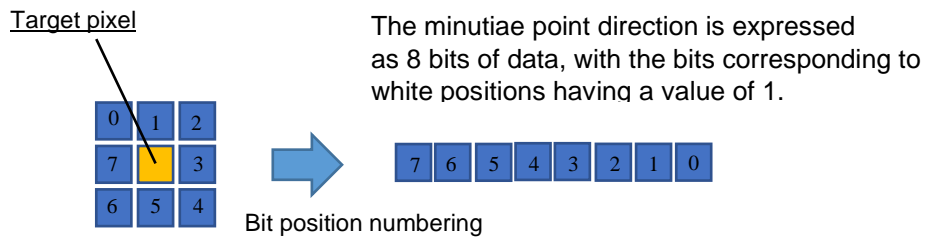

- Example of ending point and direction



- Example of bifurcation point and direction



In minutiae extraction, it is possible to specify the area of the image at the address specified by src that is actually subject to processing. This area can be specified by setting the extraction area width in e_area_width, height in e_area_height, and start position coordinates (e_area_startx and e_area_starty).

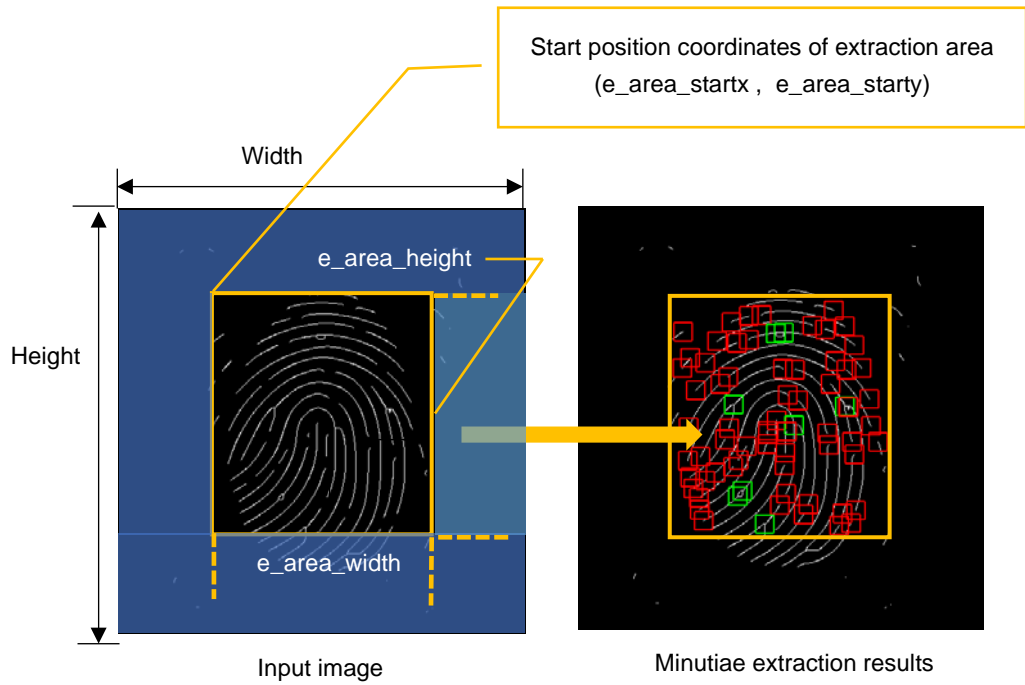

With this function, segmented processing can be achieved by using the CPU.
 In the following example, two areas are processed in parallel.

Divide the search area into two areas, MinutiaeExtract0 and MinutiaeExtract1, and specify specific minutiae_data, minutiae_num, minutiae_max, e_area_startx, e_area_starty, e_area_width, and e_area_height values for each, as when performing minutiae extraction without segmentation. For each segment, set the same values for src, width, height, and threshold.

When minutiae extraction completes on the DRP, merge the output minutiae point data in the minutiae_data areas of MinutiaeExtract0 and MinutiaeExtract1, and add the minutiae point counts (minutiae_num) together to implement segmented processing.

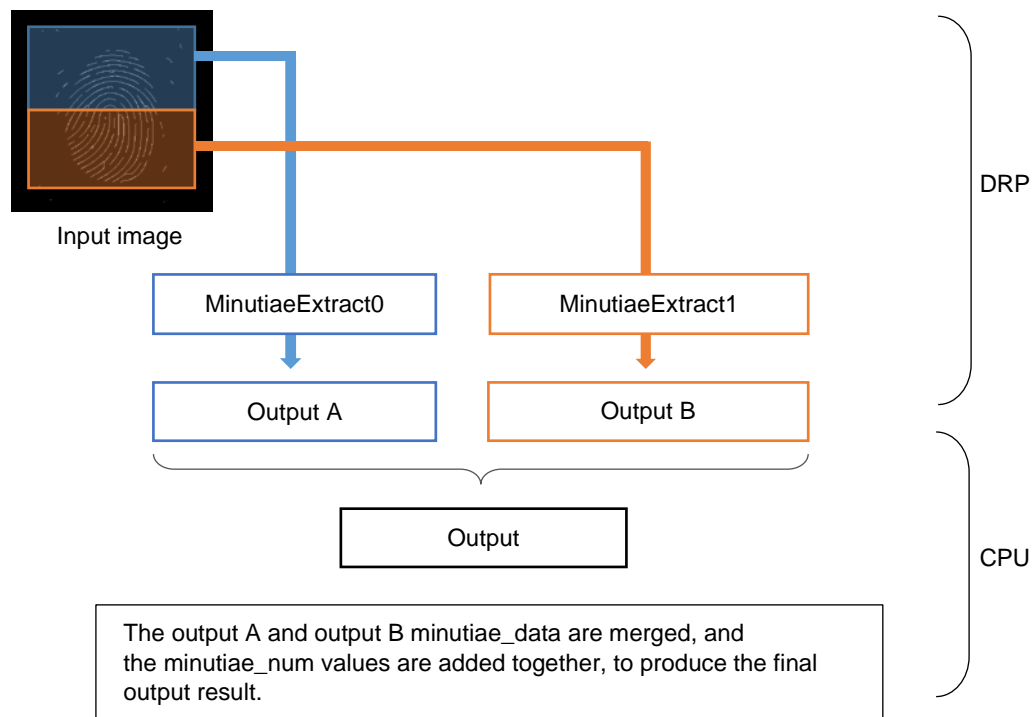

Note None

4.11.5 MinutiaeDelete

MinutiaeDelete

Deletes minutiae points of fingerprint ridge lines used in fingerprint recognition

Configuration data file	r_drp_minutiae_delete.dat
Supported version	1.00
Configuration data size (byte)	112480
Header file	r_drp_minutiae_delete.h

Parameter	Structure name		
	r_drp_minutiae_delete_t		
		Member name	Type
			Description
		trust_map	uint32_t Address of trustworthiness information
		width	uint16_t Width of trustworthiness information (pixels)
		height	uint16_t Height of trustworthiness information (pixels)
		i_minutiae_data	uint32_t Address of input minutiae point data
		i_minutiae_num	uint32_t Address of input minutiae point count
		i_minutiae_max	uint32_t Max. input minutiae point count (1 to 2048)
		o_minutiae_data	uint32_t Address of output minutiae point data
		o_minutiae_num	uint32_t Address of output minutiae point count
		work	uint32_t Address work area
		First deletion	
		del1_distance	uint16_t First deletion distance specification (0 to 65535)
		del1_probability	uint8_t First deletion trustworthiness information specification (0 to 255)
		del1_bifurcation	uint8_t First deletion bifurcation point deletion suppression specification (0 to 255)
		Second deletion	
		del2_distance	uint16_t Second deletion distance specification (0 to 65535)
		del2_count	uint8_t Second deletion minutiae point count specification (0 to 255)
		del2_bifurcation	uint8_t Second deletion bifurcation point deletion suppression specification (0 to 255)
		Third deletion	
		del3_distance_s	uint16_t Third deletion distance specification (same type) (0 to 65535)
		del3_distance_d	uint16_t Third deletion distance specification (different type) (0 to 65535)
		del3_probability	uint8_t Third deletion trustworthiness information specification (0 to 255)
		del3_bifurcation	uint8_t Third deletion bifurcation point deletion suppression specification (0 to 255)

I/O details	Input minutiae point count	Address: Specified by <code>i_minutiae_num</code> . Data size: 4 bytes Format: Number of minutiae points to be deleted (4 bytes)
	Description Inputs the number of minutiae points to be deleted. However, if the value specified for <code>i_minutiae_num</code> exceeds <code>i_minutiae_max</code> , only the number of minutiae points specified by <code>i_minutiae_max</code> is deleted.	

Input minutiae point data	Address: Specified by <code>i_minutiae_data</code> . Data size: Input minutiae point count × 8 bytes Format: Starting from the address, X coordinate of extracted minutiae point (2 bytes), Y coordinate of extracted minutiae point (2 bytes), type of extracted minutiae point (1 byte), direction of extracted minutiae point (1 byte), 0 padding (2 bytes)
	Description Starting from the address, the X and Y coordinates, type, and direction of each minutiae point are input as an 8-byte unit, up to the specified input minutiae point count. When inputting MinutiaeExtract results, specify the address of <code>minutiae_data</code> in <code>i_minutiae_data</code> and the address of <code>minutiae_num</code> in <code>i_minutiae_num</code> , and set the value of <code>miutiae_max</code> to <code>i_minutiae_max</code> .

[Segmented processing not used]

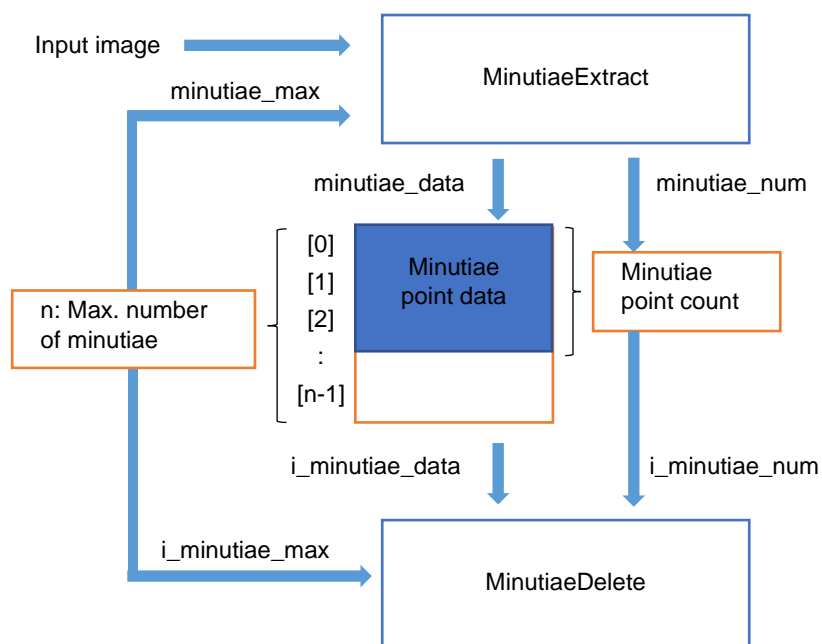

[Segmented processing used]

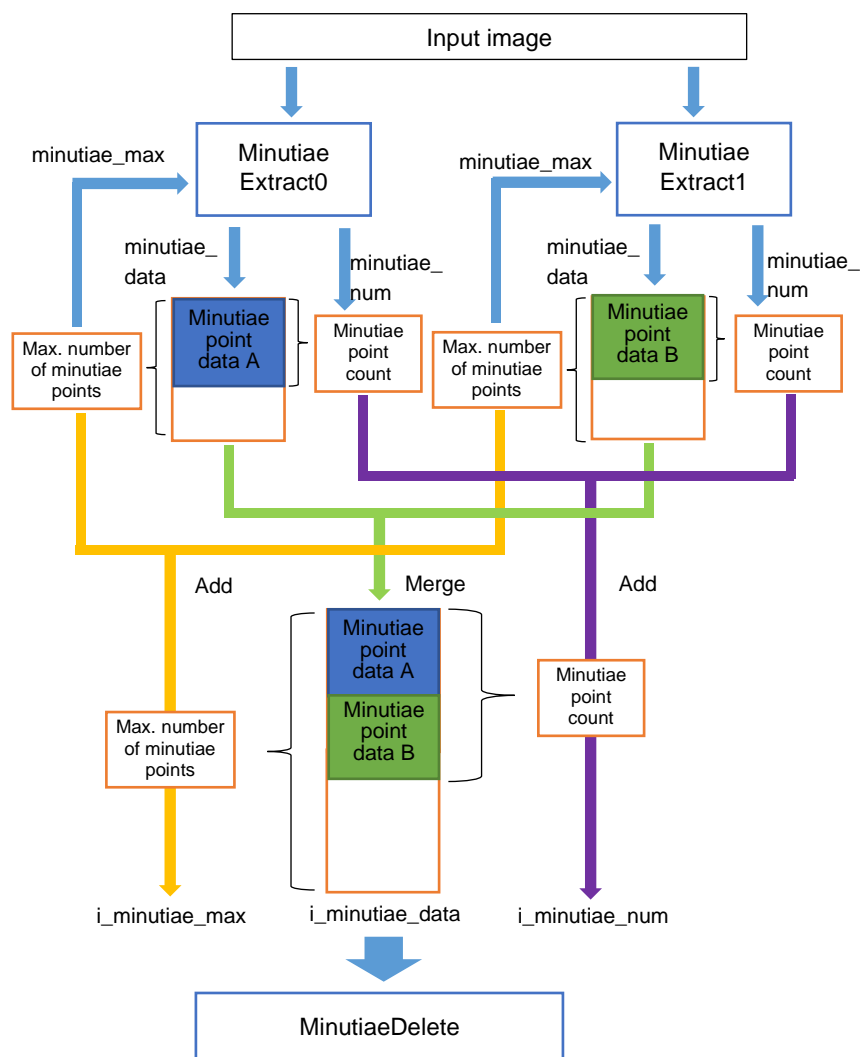

If MinutiaeExtract was processed in segments, store the merged minutiae point data at the addresses specified by `i_minutiae_data` and `i_minutiae_num`.

The minutiae point type is either ridge ending (0) or ridge bifurcation (1).

The minutiae point direction consists of 8 bits of data, starting with bit 0 to the upper left of the target pixel and proceeding clockwise through the adjacent pixels, indicating the positions that are white.

Refer to the description of MinutiaeExtract for details.

Trustworthiness information (input)	Address:	Specified by <code>trust_map</code> .
	Width (pixels):	Specified by <code>width</code> . (40 to 1280, integer multiple of 4)
	Height (pixels):	Specified by <code>height</code> . (18 to 960)
	Format:	8 bits (1 byte per pixel)
	Data size:	$(width) \times (height) \times 1$ byte

Description

This information is used to determine whether or not minutiae points are trustworthy. A higher numeric value corresponds to a higher level of trustworthiness.

Refer to the description for details.

Output minutiae point count	Address: Specified by o_minutiae_num. Data size: 4 bytes Format: Number of minutiae points after deletion (4 bytes)
	Description This specifies the number of minutiae points to be output after deletion.
Output minutiae point data	Address: Specified by o_minutiae_data. Data size: i_minutiae_max × 8 bytes Format: Starting from the address, X coordinate of extracted minutiae point (2 bytes), Y coordinate of extracted minutiae point (2 bytes), type of extracted minutiae point (1 byte), direction of extracted minutiae point (1 byte), 0 padding (2 bytes)
	Description Starting from the address, the X and Y coordinates, type, and direction of each minutiae point are output after deletion as an 8-byte unit, up to the specified output minutiae point count. The maximum value of the output minutiae point count is i_minutiae_max, so the data size only needs to accommodate i_minutiae_max. The minutiae point type is either ridge ending (0) or ridge bifurcation (1). The minutiae point direction consists of 8 bits of data, starting with bit 0 to the upper left of the target pixel and proceeding clockwise through the adjacent pixels, indicating the positions that are white. Refer to the description of MinutiaeExtract for details.
Work area	Address: Specified by work. Data size: i_minutiae_max × 16 bytes
	Description This is where data is stored while processing of minutiae deletion is in progress.
Number of tiles	2
Segmented processing	Not supported

Description This function performs first deletion, second deletion, and third deletion, based on the minutiae point information (specified by `i_minutiae_data` and `i_minutiae_num`) extracted by `MinutiaeExtract` and the trustworthiness information, then outputs minutiae point information to `o_minutiae_data` and `o_minutiae_num`.
 Deletion is not performed if the minutiae point count is eight or less. The first deletion, second deletion, and third deletion portions of the process are each described separately below.

Minutiae extraction results

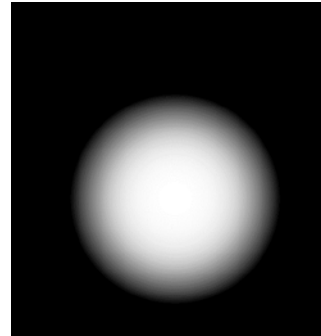
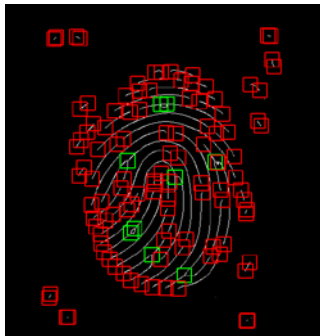

↓ First deletion

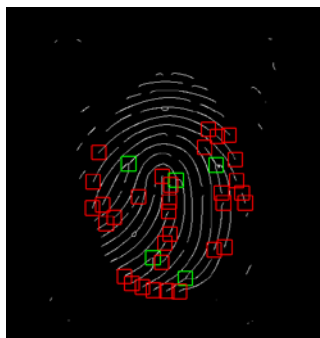

[Trustworthiness information]
 Locations where the brightness is low are judged to be lower in trustworthiness and not considered to be valid minutiae points.

- Ridge ending point
- Ridge bifurcation point

↓ Second deletion



↓ Third deletion

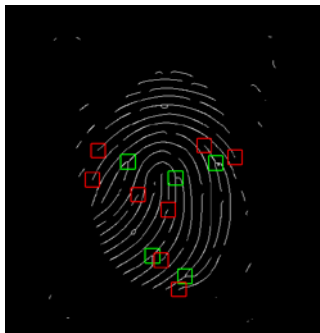

[First deletion]

In the first deletion, minutiae points that meet either of the following two conditions are deleted:

- Minutiae points of the same type that are at the specified distance, as viewed from the target minutiae point
- Minutiae points with low trustworthiness

These conditions are used because minutiae points of the same type may not be true minutiae points if they result from a hole in a line or a short line.



In the first deletion, the target minutiae point (coordinates XA, YA) is compared to all other minutiae points (coordinates XB, YB), and a determination to delete the minutiae point is made when the type is the same and the relationship with del1_distance meets the following condition:

$$(XA - XB)^2 + (YA - YB)^2 < del1_distance$$

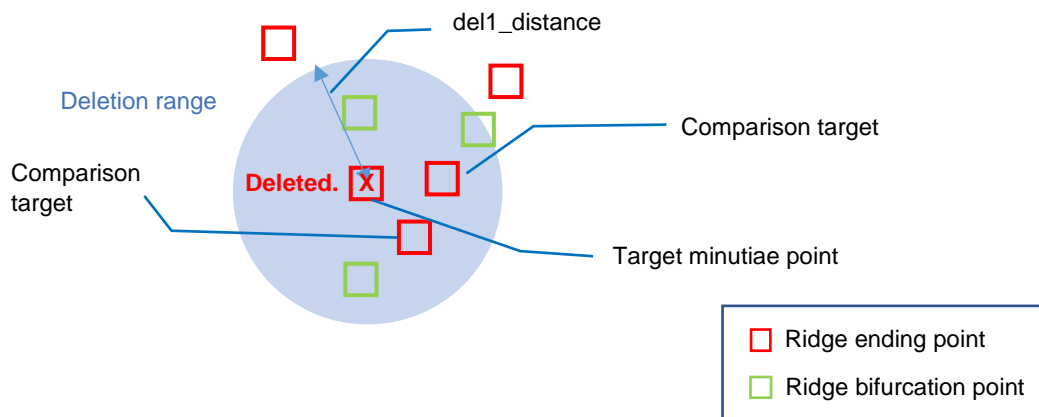

The deletion processing is able to avoid deleting bifurcation points in the first deletion. When deleting based on distance, a determination to delete is made when the bifurcation point distance is twice del1_bifurcation.

This means that bifurcation points are deleted when they meet the following condition:

$$\{ (XA - XB)^2 + (YA - YB)^2 \} \times del1_bifurcation < del1_distance$$

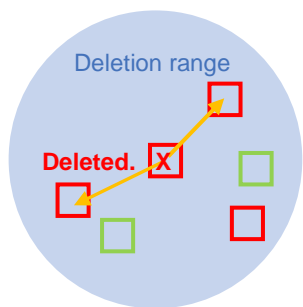

If center pixel is ending point

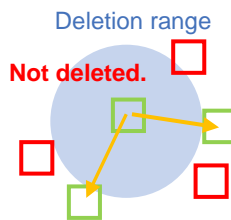

If center pixel is bifurcation point
 Bifurcation points for which the radius is $1 / [\text{del1_bifurcation}]$ are not deleted.

When deleting based on low trustworthiness, the target minutiae point is judged to have low trustworthiness and is deleted when the trustworthiness information value is less than del1_probability. Note that the processing avoids deleting bifurcation points when making deletions based on low trustworthiness. Bifurcation points are deleted when (trustworthiness information value \times del1_bifurcation) is less than del1_probability.

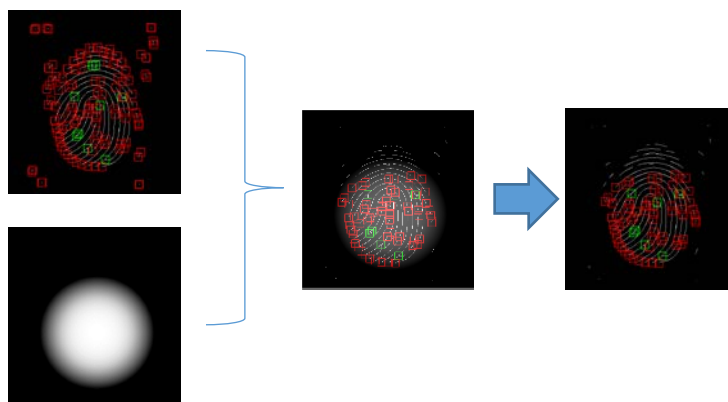

Trustworthiness

If del1_probability = 30 and del1_bifurcation = 1

Judgement is made to delete minutiae points with value of less than 30.

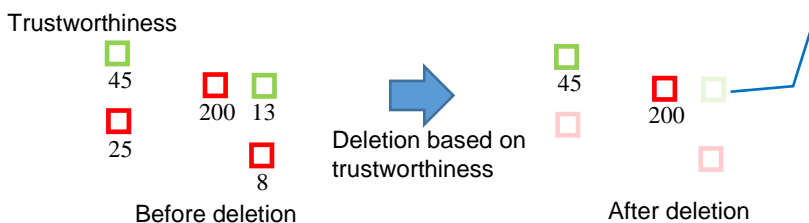

If del1_probability = 30 and del1_bifurcation = 3

$13 \times 3 = 39$, so exempted from deletion judgement.

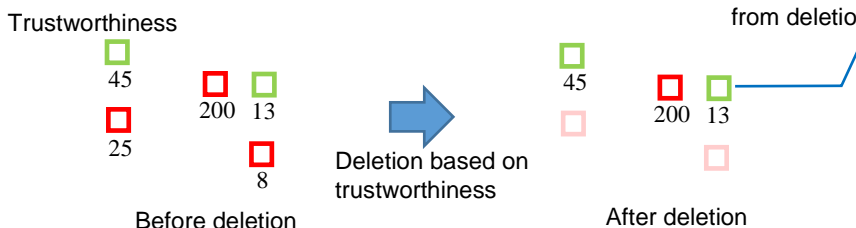

To not make deletions based on distance, set del1_distance to 0. To not make deletions based on trustworthiness, set del1_probability to 0.

When both del1_distance and del1_probability are set to 0, first deletion processing does not take place.

[Second deletion]

In the second deletion, minutiae points that meet the following condition are deleted:

- Minutiae points that are at the specified distance, as viewed from the target minutiae point, and exceed the specified number.

This condition is used because when minutiae points are clustered together, they may be the result of noise.

In the second deletion, the target minutiae point (coordinates XA, YA) is compared to all other minutiae points (coordinates XB, YB), and a determination to delete the minutiae point is made when it is a ridge ending point and the result of the formula below is del2_count or greater.

$$(XA - XB)^2 + (YA - YB)^2 < del2_distance$$

When the target minutiae point is a bifurcation point, and the number of minutiae points that satisfy the formula below is del2_count or greater, the target minutiae point is deleted.

$$\{ (XA - XB)^2 + (YA - YB)^2 \} \times del2_bifurcation < del2_distance$$

If del2_count = 3

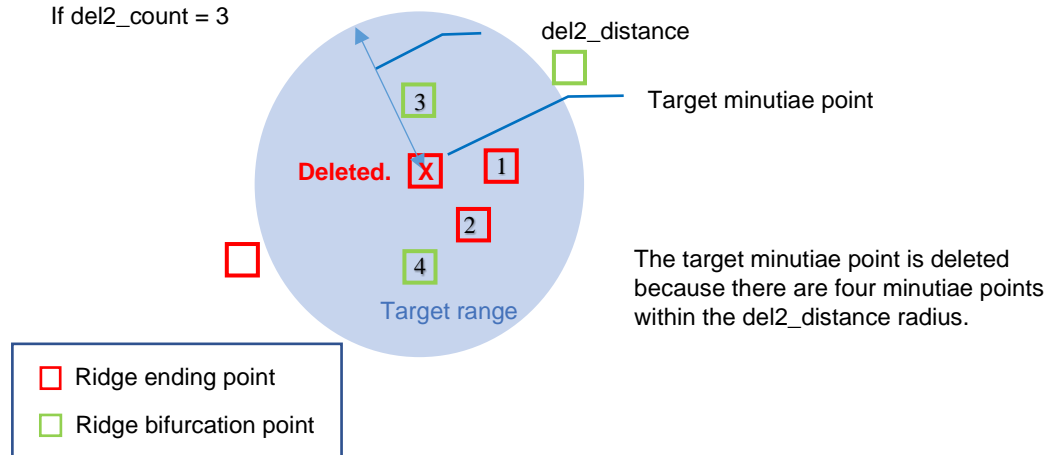

The deletion processing is able to avoid deleting bifurcation points in the second deletion.

If del2_count = 3

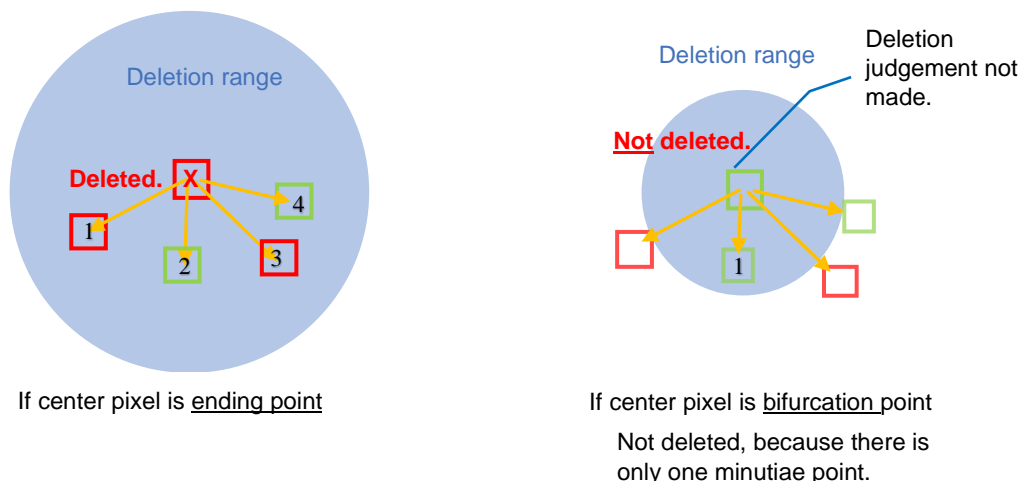

To not make deletions based on distance, set del2_distance to 0. When del2_distance is set to 0, second deletion processing does not take place.

[Third deletion]

Third deletion processing takes place after first deletion and second deletion processing. The deletion conditions are the same as those of the first deletion, but deletion is performed on minutiae points (including points of different types) that are near each other. When the target minutiae point (coordinates XA,YA) is a bifurcation point, deletion suppression based on del3_bifurcation applies. The comparison target minutiae points have (coordinates XB,YB).

When the minutiae points are of the same type, deletion occurs when del3_distance_s satisfies the formula below. (When the target pixel is an ending point, del3_bifurcation = 1.)

$$\{(XA - XB)^2 + (YA - YB)^2\} \times del3_bifurcation < del3_distance_s$$

When the minutiae points are of different types, deletion occurs when del3_distance_d satisfies the formula below. (When the target pixel is an ending point, del3_bifurcation = 1.)

$$\{(XA - XB)^2 + (YA - YB)^2\} \times del3_bifurcation < del3_distance_d$$

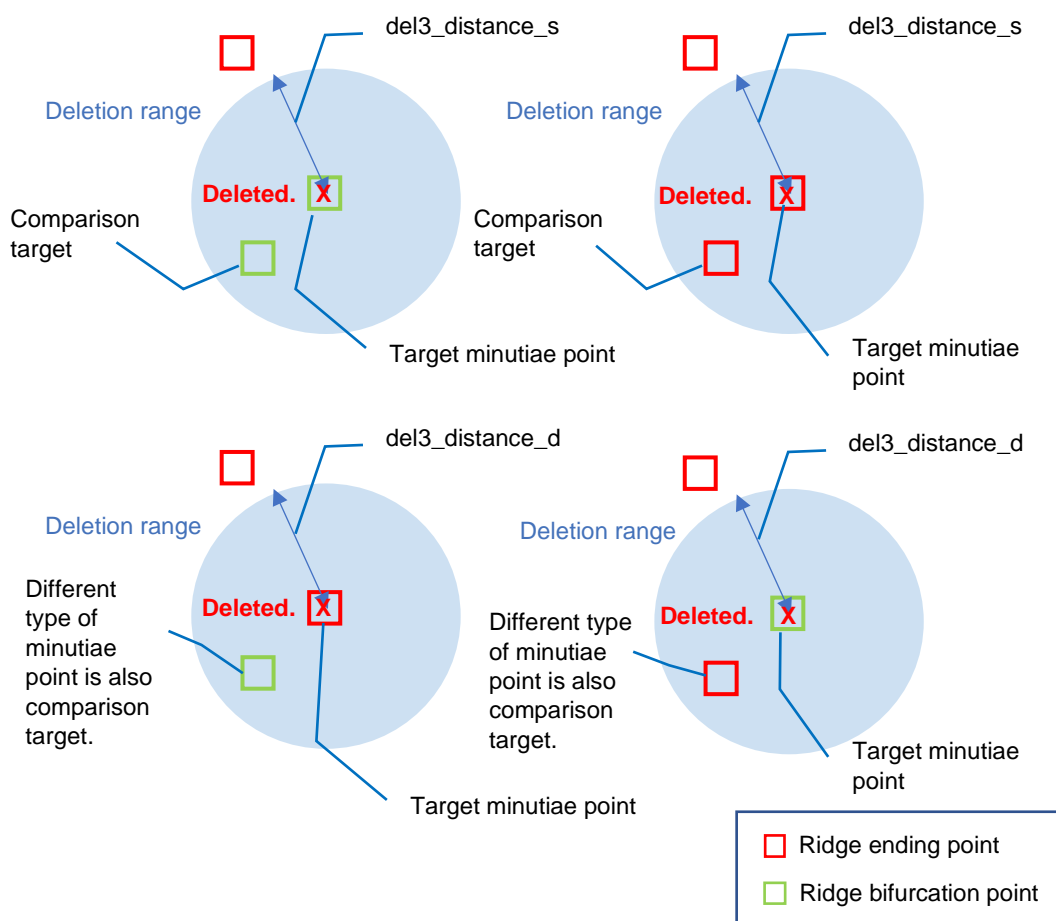

As with the first deletion, the third deletion also performs deletions when trustworthiness is low. This processing uses del3_probability and del3_bifurcation, and the conditions are the same as those of the first deletion.

To not make deletions based on distance, set del3_distance_s and del3_distance_d to 0. To not make deletions based on trustworthiness, set del3_probability to 0.

When del3_distance_s, del3_distance_d, and del3_probability are all set to 0, third deletion processing does not take place.

Setting not to perform all deletions of first deletion, second deletion and third deletion is prohibited.

Note None

4.11.6 CircleFitting

CircleFitting

Detects circle from the input image

Configuration data file	r_drp_circle_fitting.dat		
Supported version	1.00		
Configuration data size (byte)	177312		
Header file	r_drp_circle_fitting.h		
Parameter	Structure name		
	r_drp_circle_fitting_t		
	Member name	Type	Description
	src	uint32_t	Input image address
	dst	uint32_t	Output data address
	src_width	uint16_t	Input image width (pixels)
	src_height	uint16_t	Input image height (pixels)
	work	uint32_t	Work area address
	c_area_startx	uint16_t	x-coordinate of the position from which to start searching for the center of a circle in the search area
	c_area_starty	uint16_t	y-coordinate of the position from which to start searching for the center of a circle in the search area
	c_area_width	uint16_t	Width (pixel) of the area in which to search for the center of a circle
	c_area_height	uint16_t	Height (pixel) of the area in which to search for the center of a circle
	min_radius	uint16_t	Minimum value of the radius of the circle (2 to 478) Set a value greater than the value of step.
	max_radius	uint16_t	Maximum value of the radius of the circle (2 to 478) Set a value no less than the value of min_radius.
	step	uint8_t	Search execution unit (pixels) in the x direction, y direction, and radial direction (1 to 51)
I/O details	Input image	Address:	Specified by src. (Specify an address that differs from dst or work.)
		Width (pixels):	Specified by src_width. (16 to 1280)
		Height (pixels):	Specified by src_height. (16 to 960)
		Format:	8-bit grayscale (1 byte per pixel)
		Data size:	(src_width) × (src_height) × 1 byte

Search area	<p>x-coordinate of the start position for searching: Specified by <code>c_area_startx</code> $(\text{min_radius} + \text{step to } \text{src_width} - 1 - \text{min_radius} - \text{step})$</p> <p>y-coordinate of the start position for searching: Specified by <code>c_area_starty</code> $(\text{min_radius} + \text{step to } \text{src_height} - 1 - \text{min_radius} - \text{step})$</p> <p>Width (pixels): Specified by <code>c_area_width</code>. $(1 \text{ to } \text{src_width} - \text{c_area_startx} - \text{min_radius} - \text{step})$</p> <p>Height (pixels): Specified by <code>c_area_height</code>. $(1 \text{ to } \text{src_height} - \text{c_area_starty} - \text{min_radius} - \text{step})$</p> <p>Description The search area of the input image in which to search for the center of the circle Make settings such that the value of <code>c_area_startx</code> + <code>c_area_width</code> is from <code>min_radius</code> + <code>step</code> + 1 to <code>src_width</code> - <code>min_radius</code> - <code>step</code>. Make settings such that the value of <code>c_area_starty</code> + <code>c_area_height</code> is from <code>min_radius</code> + <code>step</code> + 1 to <code>src_height</code> - <code>min_radius</code> - <code>step</code>. Refer to the description for details.</p>
Output data	<p>Address: Specified by <code>dst</code>. (Specify an address that differs from <code>src</code> or <code>work</code>.)</p> <p>Format: From the top address, specifications are made in the following order. x-coordinate (2 bytes) of the center of the circle that was found. y-coordinate (2 bytes) of the center of the circle that was found. Radius (2 bytes) of the circle that was found. score (2 bytes) for the circle that was found.</p> <p>Refer to the description for details. Data size: 8 bytes</p>
Work area	<p>Address: Specified by <code>work</code>. (Specify an address that differs from <code>src</code> or <code>dst</code>.)</p> <p>Data size: $(\text{c_area_width}) \times ((\text{c_area_height} \div \text{step})[\text{rounded up after the decimal point}]) \times 6 \text{ bytes}$</p> <p>Description The area used to store data during the circle fitting processing.</p>
Number of tiles	2
Segmented processing	<p>Not supported</p> <p>However, segmented processing can be set up in combination with processing by the CPU. Refer to the description for details.</p>

Description

This function performs circle fitting processing of the image at the address specified by src, and outputs the coordinates of the center, the radius, and the score for the circle that was found to the range from the address specified by dst.

In the case of the image in which a single edge can be recognized, the image has different brightnesses at point A in the image and at another point B which is across the edge from point A.

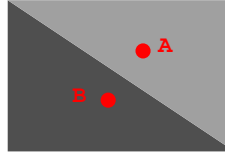

An image having an edge of oblique line

Circle fitting processing starts with the assumptions that a circle is to be found by the search, of a circle P, a concentric circle Q having a larger radius, and a concentric circle R having a smaller radius. The absolute value of the difference in brightness between the regions of the outlines of circles Q and R is calculated by using the above concept.

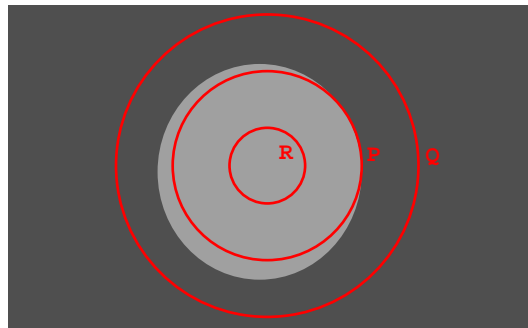

Targets of calculation in circle fitting

The points at which the brightness values are sampled for the circle having the center coordinate (x,y) and radius r are the 48 points starting from the point (x+r,y) and distributed around the circumference of the circle at an angular interval of 7.5 degrees. If the values of the coordinates of a sampling point are not integers, the decimal fraction in the value is rounded up or down.

The score in circle fitting for a circle having center coordinate (x,y) and radius r is calculated in the way described below.

$$score = |(Total\ of\ brightness\ values\ of\ 48\ points\ on\ the\ circumference\ with\ the\ center\ coordinate\ (x,y)\ and\ radius\ (r + step)) - Total\ of\ brightness\ values\ of\ 48\ points\ on\ the\ circumference\ with\ the\ center\ coordinate\ (x,y)\ and\ radius\ (r - step)|$$

The center coordinate and radius are varied to search for the values that deliver the highest score, and the x and y coordinates of the center, radius r, and score of the final result are output.

If scores for multiple coordinates and radii are equal highest, the order of priority listed below is applied to obtain the final result.

1. The smallest radius
2. The smallest y-coordinate value
3. The smallest x-coordinate value

The parameters c_area_startx, c_area_starty, c_area_width, and c_area_height determine the area to be searched for the center of a circle as shown in the figure below. Set the area to be searched for the center of a circle to be wholly within the area of the input image.

The circle fitting processing is performed from the center coordinates (c_area_startx + step * n, c_area_starty + step * n) [n is an integer not less than 0]. However, if part of a circle is outside the area of the input image, it is deemed not to be a circle.

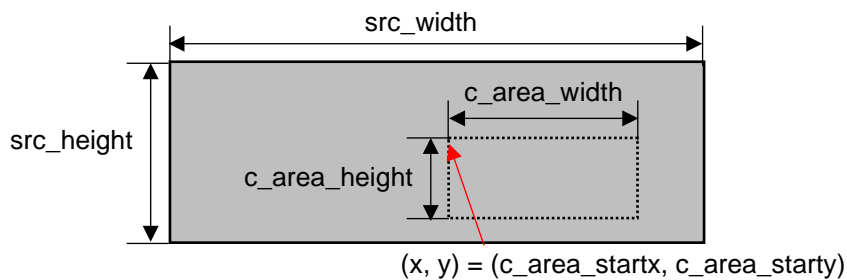

This function allows processing to be segmented with the aid of the CPU.

An example of segmentation for three parallel flows of processing is shown below.

The search area is segmented into the three areas CircleFitting0, CircleFitting1, and CircleFitting2, and the prescribed dst , $work$, c_area_startx , c_area_starty , c_area_width , and c_area_height are specified for the three respective areas to perform the circle fitting processing from the same center coordinates as those before the segmentation. Use the same settings of src , src_width , src_height , min_radius , max_radius , and $step$.

After the DRP completes the circle fitting processing, the scores (of the circles that were found) are output to the dst area from CircleFitting0, CircleFitting1, and CircleFitting2, and the highest score is selected as the final result. Segmented processing can thus be realized.

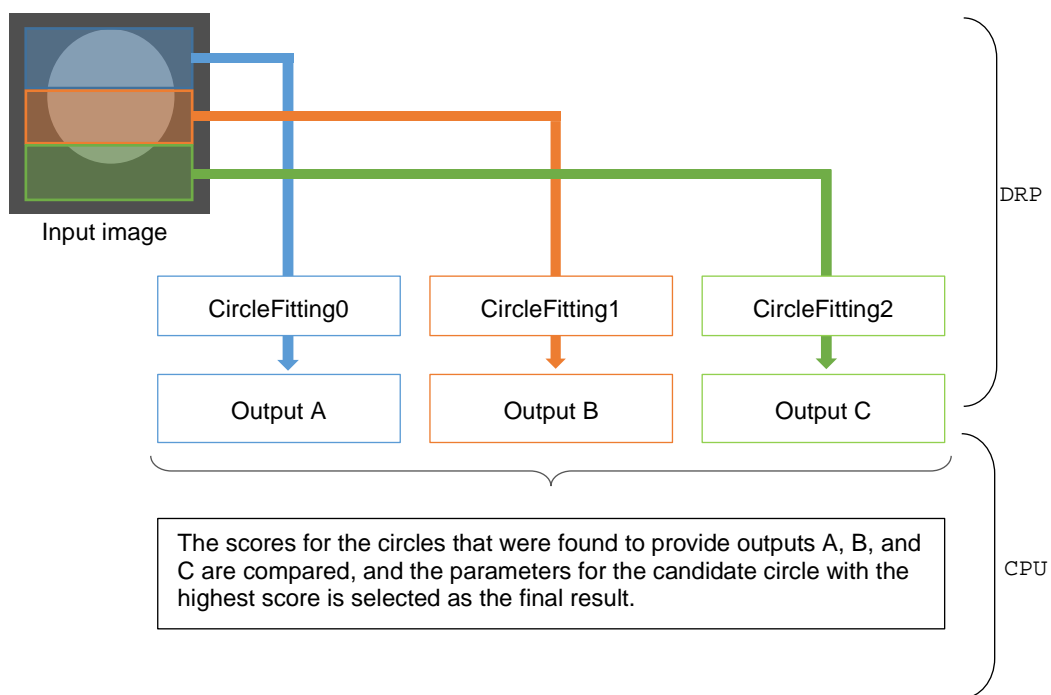

Note If the parameter settings are such that part or the whole of any candidate circle is out of the area of input image, regardless of the point in the search area that is set as the center, the values of all output variables will always be 0.

4.11.7 FindContours

FindContours

Detects contours in the image and calculate its bounding rectangle

Configuration data file	r_drp_find_contours.dat		
Supported version	1.01		
Configuration data size (byte)	204640		
Header file	r_drp_find_contours.h		
Parameter	Structure name		
	r_drp_find_contours_t		
	Member name	Type	Description
	src	uint32_t	Input image address
	dst_rect	uint32_t	Output data (rectangle information) address
	dst_region	uint32_t	Output data (region information) address
	width	uint16_t	Input image width (pixels)
	height	uint16_t	Input image height (pixels)
	work	uint32_t	Work area address
	dst_rect_size	uint32_t	Maximum output number of Rectangle Information (1 to 20,000)
	dst_region_size	uint32_t	Maximum output number of Region Information (0 to 500,000) Specify the upper limit of the total of region information to be output, not the number per contour (When set to 0, no output)
	threshold_width	uint16_t	Width threshold of rectangle to be detected (1 to width)
	threshold_height	uint16_t	Height threshold of rectangle to be detected (1 to height)
I/O details	Input image	Address: Width (pixels): Height (pixels): Format: Data size:	Specified by src. Specified by width. (64 to 1280, integer multiple of 8) Specified by height. (32 to 960) Binary image (1 byte per pixel), or 8-bits grayscale (1 byte per pixel) Refer to the description for details. (width) × (height) × 1 byte
	Output data (Rectangle Information)	Address: Format: End Data: Data size:	Specified by dst_rect (Specify an address that differs from src.) From the top address, specifications are made in the following order. Upper-left corner x coordinate of Bounding rectangle (2 bytes) Upper-left corner y coordinate of Bounding rectangle (2 bytes) Bounding rectangle width (2 bytes) Bounding rectangle height (2 bytes) Count of region information (4 bytes) Start address of region information (4 bytes) Refer to the description for details. End of rectangle information. All fields are 0 (16 bytes) Refer to the description for details. (Count of rectangles detected + 1) × 16 bytes "+ 1" means the size of End Data The maximum size is (dst_rect_size) × 16 bytes
	Output data (Region Information)	Address: Format: Data size:	Specified by dst_region (Specify an address that differs from src.) From the top address, specifications are made in the following order. x coordinate of one pixel constituting the contour (2 bytes) y coordinate of one pixel constituting the contour (2 bytes) Refer to the description for details. (The total of pixels constituting every contour) × 4 bytes The maximum size is (dst_region_size) × 4 bytes

Work area	Address:	Specified by work.
	Data size:	(width) × (height) × 1 byte
	Description	
	The area used to store data during findcontours processing.	

Number of tiles	2
-----------------	---

Segmented processing	Not supported.
----------------------	----------------

Description This function performs findcontours processing of the image at the address specified by src and outputs the bounding rectangle information of detected contours to the address specified by dst_rect, and the pixel coordinate constituting detected contours to the address specified by dst_region.

When input the left image below, this function detects three contours as middle image. Then, this function outputs the coordinates of the pixels constituting the contour as "Region Information", and the bounding rectangle is calculated for each detected contour like right image as "Rectangle Information".

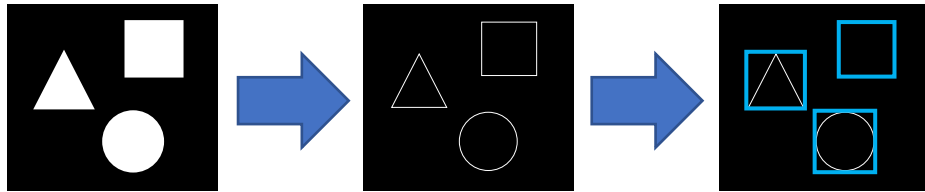

A simplified representation of detection of rectangle in the input image

"Rectangle Information"

This function outputs the bounding rectangle information of detected contours in input image and the corresponding Region Information address and count as shown below. After outputs this data set for the number of detected contours, this function outputs the End Data means end of data. Keep reading the Rectangle Information until you find the End Data to obtain all the Rectangle Information. Also, you can obtain the corresponding Region Information using the Region Information count and address.

Rectangle Information of contour-1							
2 bytes	2 bytes	2 bytes	2 bytes	4 bytes	4 bytes		
x coordinate	y coordinate	width	height	Region Information count	Region Information address		
x coordinate	y coordinate	width	height	Region Information count	Region Information address		
⋮	⋮	⋮	⋮	End Data	⋮	⋮	⋮
0x0000	0x0000	0x0000	0x0000	0x00000000	0x00000000		

Rectangle Information

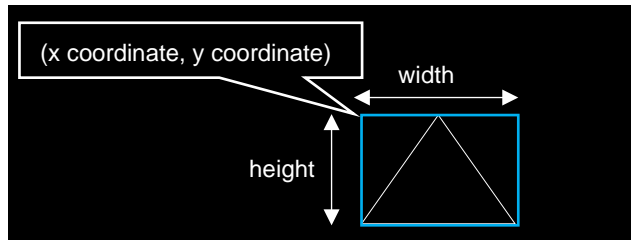

Description of Rectangle Information

"Region Information"

This function outputs (x, y) coordinate of all pixels constituting contours every contour as shown below. This coordinate is expressed in the coordinate system has upper-left corner pixel is (0, 0) in input image.

2 bytes	2 bytes	2 bytes	2 bytes	2 bytes	2 bytes	2 bytes	2 bytes
x coordinate	y coordinate	x coordinate	y coordinate	x coordinate	y coordinate	x coordinate	y coordinate
⋮	⋮	⋮	⋮	⋮	⋮	⋮	⋮
1	⋮	2	⋮	3	⋮	⋮	⋮
						Region Information of Contour-1	
x coordinate	y coordinate	x coordinate	y coordinate	x coordinate	y coordinate	x coordinate	y coordinate
⋮	⋮	⋮	⋮	⋮	⋮	⋮	⋮
a	⋮	b	⋮	c	⋮	⋮	⋮
						Region Information of Contour-2	

Region Information

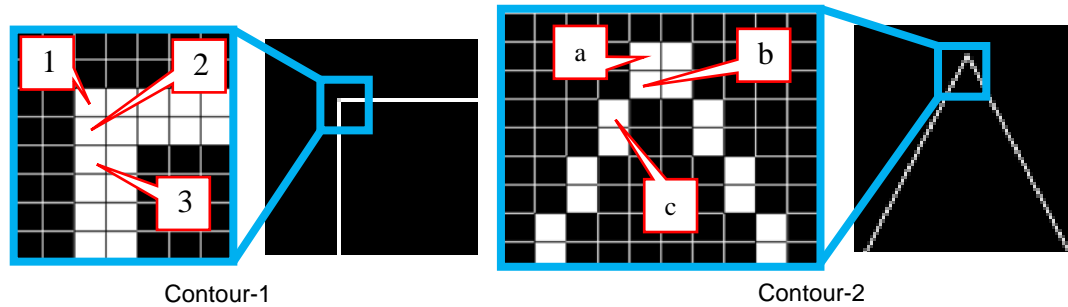

If output data count reaches the value set in `dst_rect_size` or `dst_region_size`, the data output of the one that reached the upper limit stops, but the other data output doesn't stop. Moreover, if Both data count reaches upper limit, both data output stop, then DRP terminates.

If the Rectangle Information output count reaches upper limit before output the End Data, The End Data is not output.

This function supposes binary image as input image format.

When input 8-bit grayscale, this function treats pixels with a pixel value of 1 or more as pixels with a pixel value of 1.

When a rectangle width or height is shorter than the parameter `threshold_high` or `threshold_low`, this function exclude its Rectangle Information and Region Information from output.

The processing performs by the function is equivalent to that of the OpenCV `cv::findContours` function with the specifying of `CV_RETR_LIST` for mode and `CV_CHAIN_APPROX_NONE` for method. However, this function output is unique format.

Reference URL: <https://opencv.org/>

This function allows the same address to be specified for both `src` and `work`. However, input image is broken because this function writes out data at the area specified by `work` during processing.

Note

This function output size is dependent on input image. Allocates the sufficient memory area to `dst_rect` and `dst_region` to avoid the memory broken by referring Rectangle Information and Region Information of I/O details and setting appropriate values to `dst_rect_size` and `dst_region_size`.

4.12 Histograms

4.12.1 Histogram

Histogram

Generates a histogram from the input image

Configuration data file	r_drp_histogram.dat		
Supported version	1.00		
Configuration data size (byte)	83424		
Header file	r_drp_histogram.h		
Parameter	Structure name		
	r_drp_histogram_t		
	Member name	Type	Description
	src	uint32_t	Input data address
	dst	uint32_t	Output data address
	data_size	uint32_t	Amount of input data (bytes)
	mask	uint32_t	Masked data address
	ranges	uint32_t	Address of the area holding the bin-width specification for the histogram
	hist_size	uint16_t	Number of bins for the histogram
	accumulate	uint8_t	Accumulation flag (0: initialization, 1: accumulation)
I/O details	Input data	Address:	Specified by src. (Specify an address that differs from dst, mask, or ranges)
		Amount of data:	Specified by data_size. (256 to 1,228,800)
		Format:	8 bits (1 byte per datum)
		Data size:	data_size x 1 byte
	Output data	Address:	Specified by dst. (Specify an address that differs from src, mask, or ranges)
		Number of bins:	Specified by hist_size. (1 to 256)
		Format:	Frequency (represented by 4 bytes per bin) When the setting of the accumulation flag "accumulate" is for accumulation, the existing values for frequency are read out and set as the initial values of each of the bins in the region specified by dst. If a value exceeds the maximum value that can be represented by uint32_t, the value is limited to this maximum value. Refer to the description for details.
		Data size:	hist_size x 4 bytes

Bin specification	<p>Address: Specified by ranges. (Specify an address that differs from src, dst, or mask.)</p> <p>Number of the bin area: hist_size + 1</p> <p>Format: 16 bits (0 to 256)</p> <p>Set the lower limit for the 0th bin to the address specified by ranges +0 (bytes).</p> <p>Set the upper limit for the 0th bin to the address specified by ranges +2 (bytes).</p> <p>This function sets the lower limit for the 1st bin to the value of the address specified by ranges +2 (bytes).</p> <p>Data size: (hist_size + 1) x 2 bytes</p> <p>Description</p> <p>Set the upper and lower limits for all bins. For the i-th bin, the value becomes the address specified by ranges + i x 2 (bytes) or more, and less than the address specified by ranges + i x 2 + 2 (bytes).</p> <p>Specify the number of values specified by ranges to hist_size + 1.</p> <p>Refer to the description for details.</p>
Masked data	<p>Address: Specified by mask. (Specify an address that differs from src, dst, or ranges)</p> <p>If 0 is specified to mask, the mask function is disabled.</p> <p>Amount of data: Same as input data.</p> <p>Format: 8 bits (1 byte per datum)</p> <p>Only when a value other than 0 is specified, the histogram is counted.</p> <p>Data size: Same as input data.</p> <p>Description</p> <p>The input data to which other than 0 is specified are counted for the histogram.</p> <p>Refer to the description for details.</p>
Number of tiles	2
Segmented processing	<p>Not supported</p> <p>However, segmented processing can be set up in combination with processing by the CPU.</p> <p>Refer to the description for details.</p>

Description This function calculates a histogram from the image data at the address specified by src and outputs the result to the address specified by dst. Specifying the data size (= width x height) of the image as data_size enables the input of an image as follows.
 The bin areas for this function are specified by using hist_size and ranges.

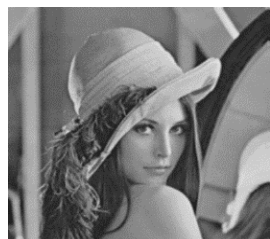

Input data

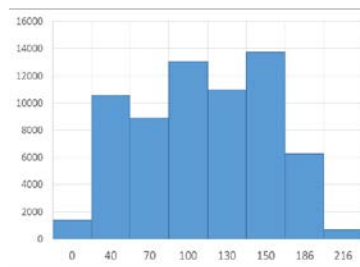

Output data

To set the upper and lower limits for the hist_size bins, specify the bin areas for the (hist_size + 1) bins.

The lower limit for the i-th bin becomes $range + i \times 2$.

The upper limit for the i-th bin becomes $range + (i + 1) \times 2$.

An example of specifying (i + 1) bins is shown below. In the example, for the i-th bin, i is set as the lower limit, and 255 is specified as the upper limit.

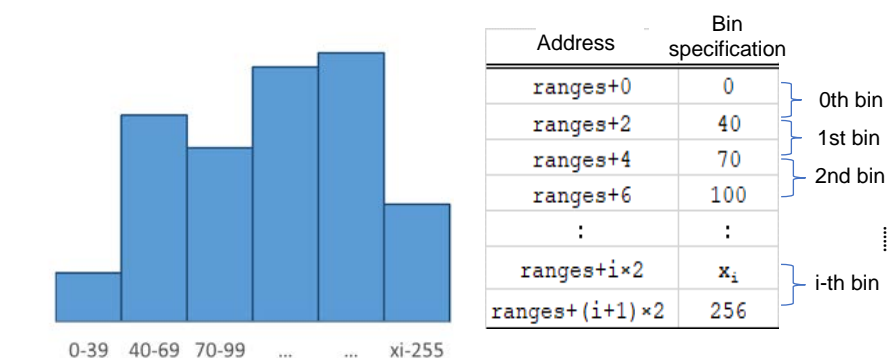

This function enables masking of the values for counting to obtain the histogram by using mask.

Pixels in areas for which 0 is specified the value are not counted in the histogram, and only values from areas having values other than 0 are counted in the histogram.

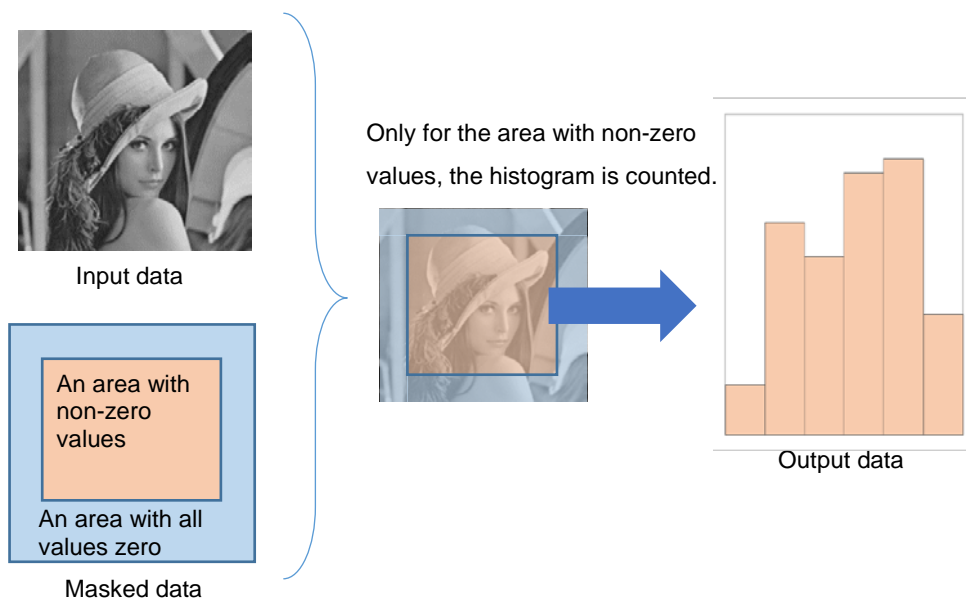

This function enables selection of the initial value or accumulated values of the histogram by using the variable accumulate.

Specifying accumulate as 1 causes reading of the existing results for a histogram at the address specified by dst, and the values thus obtained are set as the initial values. Specifying accumulate as 0 causes all of the initial values of the histogram to be set to 0.

Therefore, if accumulation is to be performed, the bin specifications (hist_size and ranges) cannot be changed from histogram to histogram. If the frequency exceeds 4,294,967,295 (= $2^{32} - 1$), the value is limited to 4,294,967,295.

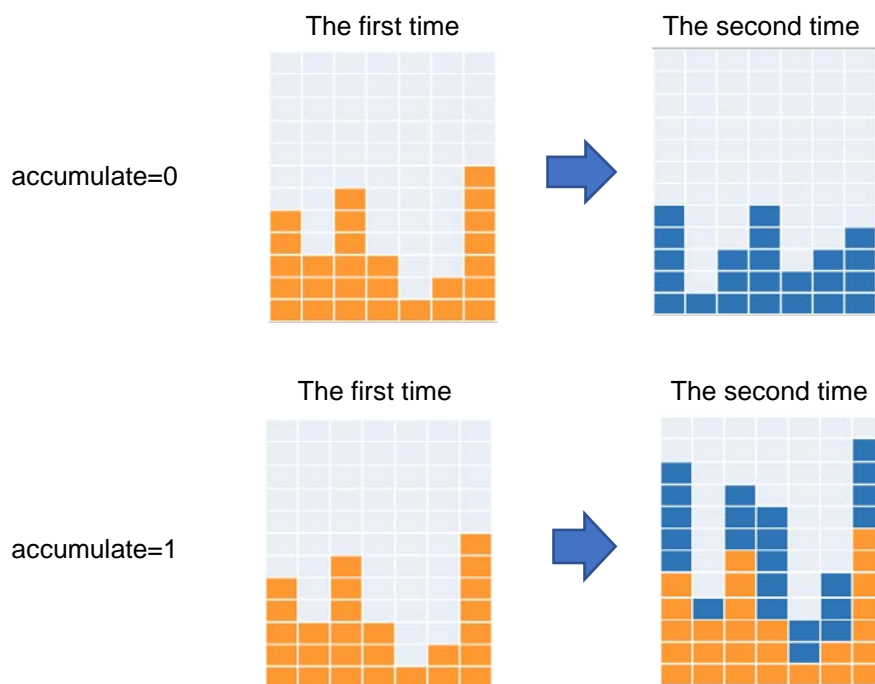

This function allows segmented processing with the aid of the CPU.

An example of three parallel flows of processing with the setting accumulate=0 is shown below.

The input data are segmented into three areas: Histogram0, Histogram1, and Histogram2. The prescribed dsrc, dst, and mask, (and data_size as required) are specified for the respective areas. The parameters ranges and hist_size are to be the same.

The segmented processing is enabled by the CPU obtaining the total of the frequencies in corresponding bins in the dst areas for Histogram0, Histogram1, and Histogram2 after the DRP has calculated the histograms.

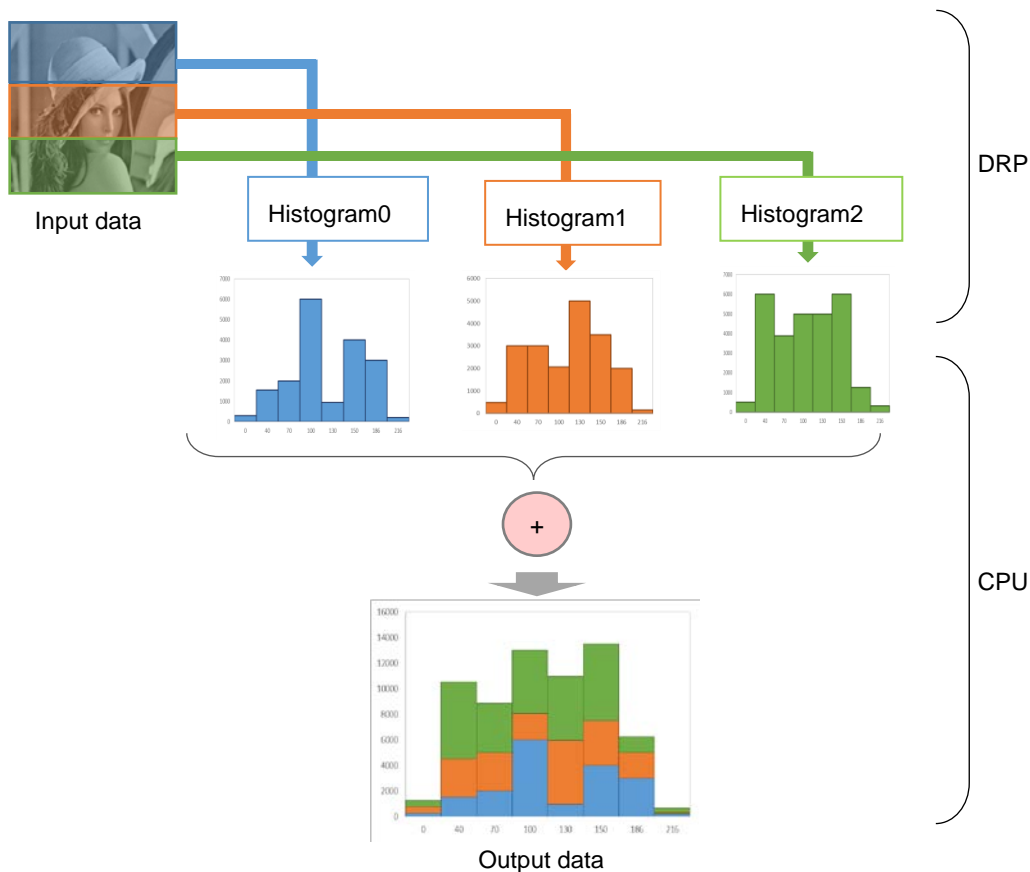

An example of three parallel flows of processing with the setting accumulate=1 is shown below.

If 1 is set for accumulate, segmented processing is enabled by adding up the frequencies of each bin in the dst area by CPU after the completion of accumulation in response to this setting of accumulate.

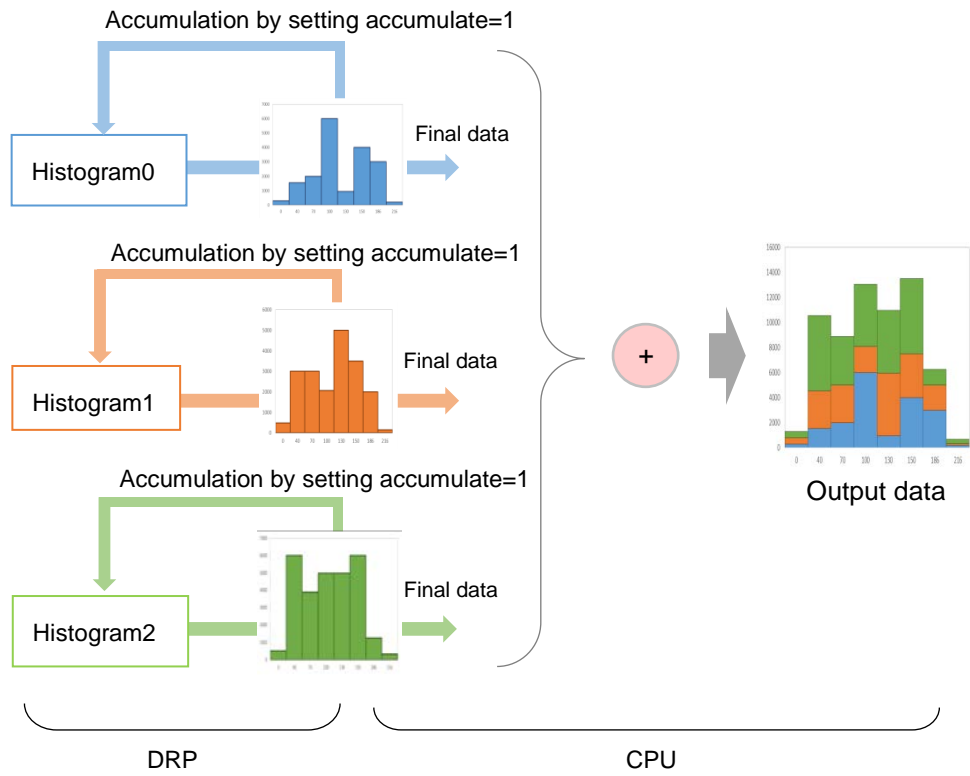

The processing performed by this function is equivalent to that of the OpenCV `cv::calcHist` function with specifying 1 to `nimages` argument, {0} to `channels`, 1 to `dims`, and `false` to `uniform`.

Reference URL: <https://opencv.org/>

Note	None
------	------

4.12.2 HistogramNormalization

HistogramNormalization

Normalizes the histogram of the image

Configuration data file	r_drp_histogram_normalization.dat		
Supported version	1.01		
Configuration data size (byte)	45376		
Header file	r_drp_histogram_normalization.h		
Parameter	Structure name		
	r_drp_histogram_normalization_t		
	Member name	Type	Description
	src	uint32_t	Input image address
	dst	uint32_t	Output data address / image address
	width	uint16_t	Image width (pixels)
	height	uint16_t	Image height (pixels)
	mode	uint8_t	1: MODE1 (Survey the overall brightness of the image) 2: MODE2 (Normalize the image) Refer to the description for details
	The followings are the parameters for MODE2 (Please set 0 in MODE1)		
	src_pixel_mean	uint32_t	Mean of the pixel values in input image The upper 20 bits are an integer part, the lower 12 bits are a decimal part. Refer to the description for details
	src_pixel_rstd	uint32_t	Reciprocal of standard deviation of the pixel values in input image The upper 20 bits are an integer part, the lower 12 bits are a decimal part. Refer to the description for details
	dst_pixel_mean	uint8_t	Mean of the pixel values in output image
	dst_pixel_std	uint8_t	Standard deviation of the pixel values in output image
I/O details	Input image	Address: Width (pixels): Height (pixels): Format: Data size:	Specified by src. Specified by width. (8 to 1280, integer multiple of 8) Specified by height. (8 to 960) 8-bit grayscale (1 byte per pixel) (width) × (height) × 1 byte
	Output data (MODE1)	Address: Format: Data size:	Specified by dst. From the top address, specifications are made in the following order. Sum of pixel values (8 bytes) Square-sum of pixel values (8 bytes) 16 bytes
	Output image (MODE2)	Address: Width (pixels): Height (pixels): Format: Data size:	Specified by dst. Same as input image Same as input image 8-bit grayscale (1 byte per pixel) (width) × (height) × 1 byte
Number of tiles	1		
Segmented processing	Supported	Segmented processing can be set up in combination with processing by the CPU. Refer to the description for details.	

Description This function has following two operation modes, and when used in combination, it is possible to outputs image normalized the histogram of the input image.

MODE1: Calculates sum and square-sum of the image at the address specified by src and outputs the result to the address specified by dst.

MODE2: Normalizes the image at the address specified by src by following calculation and outputs the result to the address specified by dst.

$$\text{output pixel value} = \{(\text{input pixel value} - \text{src_pixel_mean}) \times \text{src_pixel_rstd}\} \times \text{dst_pixel_std} + \text{dst_pixel_mean}$$

Please set the target values of the mean and the standard deviation of the normalized image to dst_pixel_mean and dst_pixel_std. When you set dst_pixel_mean = 112 and dst_pixel_std = 48 and normalize the lower left image, this function outputs lower right image.

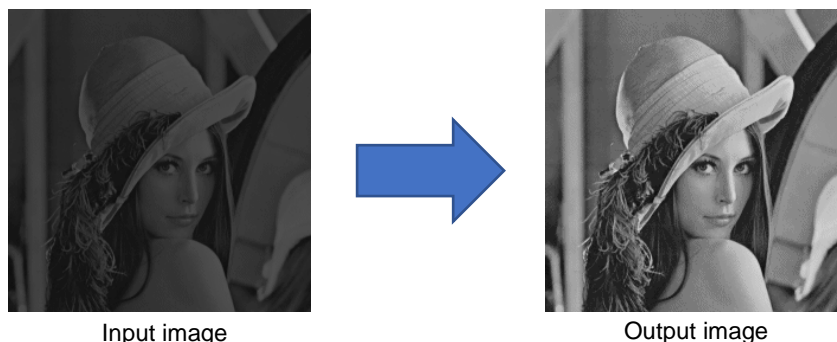

Also following figure is the histogram of the input image (before normalized) and the output image (after normalized)

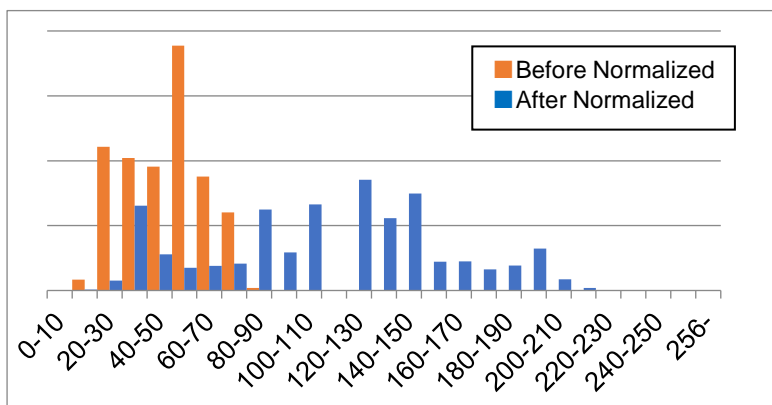

The histogram of the input image and the output image

- Follow the steps below to obtain the output image normalized the histogram of the input image.
1. Calculates sum and square-sum of pixel values by executing MODE 1.
 2. Calculates src_pixel_mean and src_pixel_rstd using the output result of 1. and the following equations in the CPU.
 3. Outputs normalized image by executing MODE2 using the calculation results of 2. as parameters.

$$\begin{aligned} \text{src_pixel_mean} &= \text{sum of pixel value} \div (\text{width} \times \text{height}) \times 4096 \\ \text{src_pixel_rstd} &= 1 \div \left(\sqrt{\text{square-sum of pixel value} \div (\text{width} \times \text{height}) - (\text{sum of pixel value} \div (\text{width} \times \text{height}))^2} \right) \times 4096 \end{aligned}$$

Because src_pixel_mean and src_pxiei_rstd are fixed point (The upper 20 bits are integer part and lower 12 bits are a decimal part), please be sure to multiply 4096 like the above equations.

This function can execute as segmented processing in combination with CPU processing. An example of three parallel processing flow is shown below.

1. The input data are segmented into three areas. Specify prescribed src, dst, width and height for HistogramNormalization of respective areas. And specify mode 1
2. After DRP processing is complete, calculate src_pixel_mean and src_pixel_rstd using the sum and the square-sum of the pixel values in the dst area of each HistogramNormalization in the CPU.
3. The input data are segmented into three areas. Specify prescribed src, dst, width and height for HistogramNormalization of respective areas. Also, as common parameters, specify the calculation results of 2. for src_pixel_mean and src_pixel_rstd, and arbitrary values for dst_pixel_mean and dst_pixel_std, and 2 for mode.
4. After DRP processing is complete, outputs the normalized image.

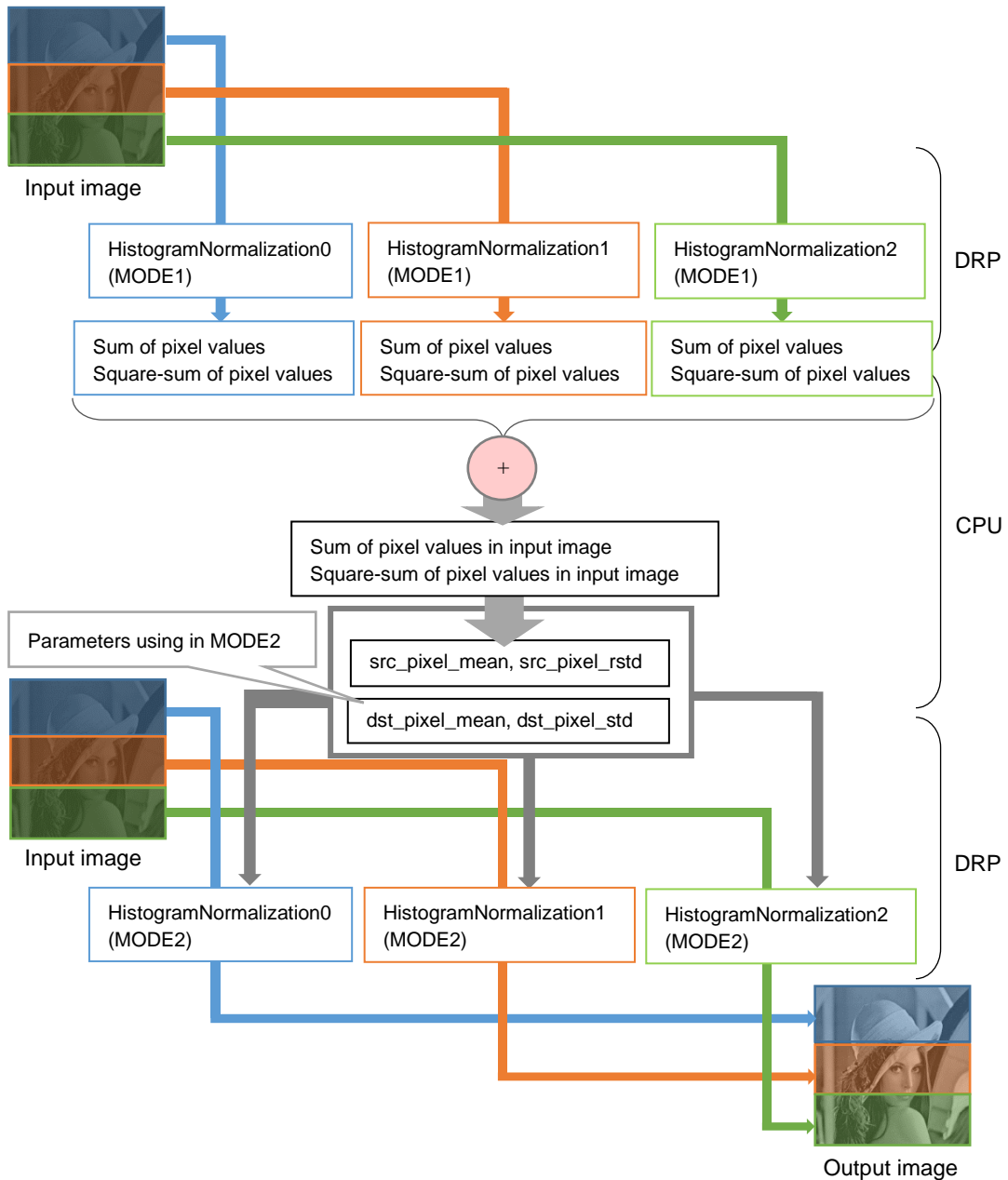

This function allows the same address to be specified for both src and dst in MODE2.

Note Do not set values other than those calculated by the equations described in the Description to src_pixel_mean and src_pixel_rstd because it may cause malfunction.

4.12.3 HistogramNormalizationRgb

HistogramNormalizationRgb

Normalizes the histogram of the image (RGB)

Configuration data file	r_drp_histogram_normalization_rgb.dat		
Supported version	1.01		
Configuration data size (byte)	60960		
Header file	r_drp_histogram_normalization_rgb.h		
Parameter	Structure name		
	r_drp_histogram_normalization_rgb_t		
	Member name	Type	Description
	src	uint32_t	Input image address
	dst	uint32_t	Output data address / image address
	width	uint16_t	Image width (pixels)
	height	uint16_t	Image height (pixels)
	mode	uint8_t	1: MODE1 (Survey the overall brightness of the image) 2: MODE2 (Normalize the image) Refer to the description for details
	The followings are the parameters for MODE2 (Please set 0 in MODE1)		
	src_pixel_red_mean	uint32_t	Mean of the R component pixel values in input image The upper 20 bits are an integer part, the lower 12 bits are a decimal part. Refer to the description for details
	src_pixel_red_rstd	uint32_t	Reciprocal of standard deviation of the R component pixel values in input image The upper 20 bits are an integer part, the lower 12 bits are a decimal part. Refer to the description for details
	src_pixel_green_mean	uint32_t	Mean of the G component pixel values in input image The upper 20 bits are an integer part, the lower 12 bits are a decimal part. Refer to the description for details
	src_pixel_green_rstd	uint32_t	Reciprocal of standard deviation of the G component pixel values in input image The upper 20 bits are an integer part, the lower 12 bits are a decimal part. Refer to the description for details
	src_pixel_blue_mean	uint32_t	Mean of the B component pixel values in input image The upper 20 bits are an integer part, the lower 12 bits are a decimal part. Refer to the description for details
	src_pixel_blue_rstd	uint32_t	Reciprocal of standard deviation of the B component pixel values in input image The upper 20 bits are an integer part, the lower 12 bits are a decimal part. Refer to the description for details
	dst_output_mean	uint8_t	Mean of the pixel values in output image
	dst_output_std	uint8_t	Standard deviation of the pixel values in output image
I/O details	Input image	Address:	Specified by src.
		Width (pixels):	Specified by width. (8 to 1280, integer multiple of 8)
		Height (pixels):	Specified by height. (8 to 960)
		Format:	RGB (3 bytes per pixel)
		Data size:	(width) × (height) × 3 bytes

Output data (MODE1)	Address: Format:	Specified by dst. From the top address, specifications are made in the following order. Sum of R component pixel values (8 bytes) Square-sum of R component pixel values (8 bytes) Sum of G component pixel values (8 bytes) Square-sum of G component pixel values (8 bytes) Sum of B component pixel values (8 bytes) Square-sum of B component pixel values (8 bytes)
	Data size:	48 bytes
Output image (MODE2)	Address: Width (pixels): Height (pixels): Format: Data size:	Specified by dst. Same as input image Same as input image RGB (3 bytes per pixel) (width) × (height) × 3 bytes
Number of tiles	1	
Segmented processing	Supported	Segmented processing can be set up in combination with processing by the CPU. Refer to the description for details.

Description This function has following two operation modes, and when used in combination, it is possible to outputs image normalized the histogram of the input image.

MODE1: Calculates sum and square-sum of the image at the address specified by src and outputs the result to the address specified by dst.

MODE2: Normalizes the image at the address specified by src by following calculation and outputs the result to the address specified by dst.

$$\text{output pixel value} = \{(\text{input pixel value} - \text{src_pixel_*_mean}) \times \text{src_pixel_*_rstd}\} \times \text{dst_pixel_std} + \text{dst_pixel_mean}$$

“*” is either red, green or blue.

Please set the target values of the mean and the standard deviation of the normalized image to dst_pixel_mean and dst_pixel_std. When you set dst_pixel_mean = 144 and dst_pixe_std = 48 and normalize the lower left image, this function outputs lower right image.



Also following figure is the R component histogram of the input image (before normalized) and the output image (after normalized)

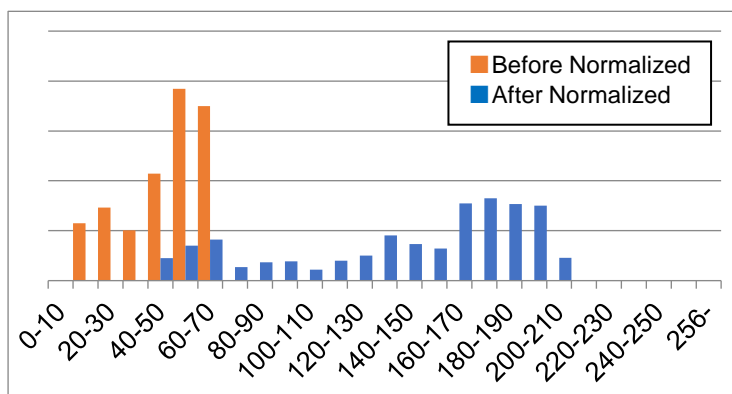

The R component histogram of the input image and the output image

- Follow the steps below to obtain the output image normalized the histogram of the input image.
1. Calculates sum and square-sum of pixel values by executing MODE 1.
 2. Calculates src_pixel_*_mean and src_pixel_*_rstd using the output result of 1. and the following equations in the CPU.
 3. Outputs normalized image by executing MODE2 using the calculation results of 2. as parameters.

$$\begin{aligned} \text{src_pixel_*_mean} &= \text{sum of pixel value} \div (\text{width} \times \text{height}) \times 4096 \\ \text{src_pixel_*_rstd} &= 1 \div \left(\sqrt{\text{square-sum of pixel value} \div (\text{width} \times \text{height}) - (\text{sum of pixel value} \div (\text{width} \times \text{height}))^2} \right) \times 4096 \end{aligned}$$

Because src_pixel_*_mean and src_pixel_*_rstd are fixed point (The upper 20 bits are integer part and lower 12 bits are a decimal part), please be sure to multiply 4096 like the above equations.

This function can execute as segmented processing in combination with CPU processing. An example of three parallel processing flow is shown below.

1. The input data are segmented into three areas. Specify prescribed src, dst, width and height for HistogramNormalizationRgb of respective areas. And specify mode 1.
2. After DRP processing is complete, calculate src_pixel_*_mean and src_pixel_*_rstd using the sum and the square-sum of the pixel values in the dst area of each HistogramNormalizationRgb in the CPU.
3. The input data are segmented into three areas. Specify prescribed src, dst, width and height for HistogramNormalizationRgb of respective areas. Also, as common parameters, specify the calculation results of 2. for src_pixel_*_mean and src_pixel_*_rstd, and arbitrary values for dst_pixel_mean and dst_pixel_std, and 2 for mode.
4. After DRP processing is complete, outputs the normalized image.

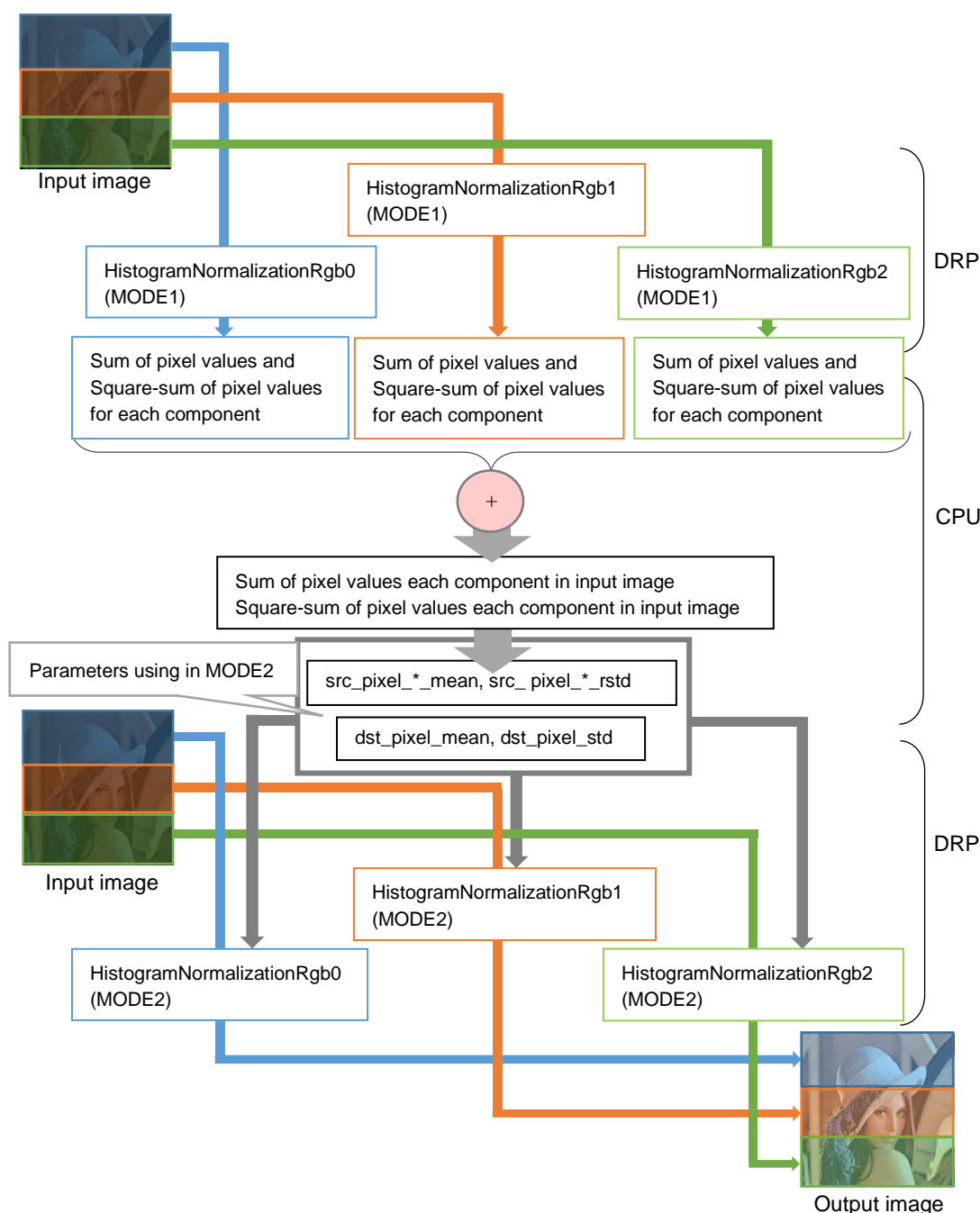

This function allows the same address to be specified for both src and dst in MODE2.

Note Do not set values other than those calculated by the equations described in the Description to src_pixel_*_mean and src_pixel_*_rstd because it may cause malfunction.

4.13 Other

4.13.1 ReedSolomon

ReedSolomon

Performs error correction using Reed-Solomon codes (fixed primitive polynomial)

Configuration data file	r_drp_reed_solomon.dat
Supported version	1.00
Configuration data size (byte)	118912
Header file	r_drp_reed_solomon.h

Parameter	Structure name	
	r_drp_reed_solomon_t	
Member name	Type	Description
src	uint32_t	Input data address
dst	uint32_t	Output data address
src_size	uint16_t	Input data size (bytes)
check_size	uint16_t	Check data size (bytes)

I/O details	Input data	Address: Specified by src. Data size: Specified by src_size. (2 to 254) Information data: Data for error correction. (1 to 253) Check data: Check data added during encoding for use in error correction Check data size: Specified by check_size. (1 to 127)
-------------	------------	---

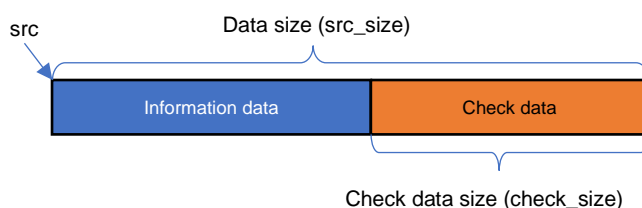

The information data and check data are input as Reed-Solomon encoded results. The encoded results are assumed to have the zero-dimensional coefficient of the primitive polynomial as the LSB.

Output data	Address: Specified by dst. Data size: src_size + 1 byte. (Error correction) Information data (error-corrected): Error corrected information data. (Data size is same the information data in input data) Check data (error-corrected): Error corrected check data. (Data size is same the check data in input data) Error correction: Data indicating error correction data. (1 byte)
-------------	---

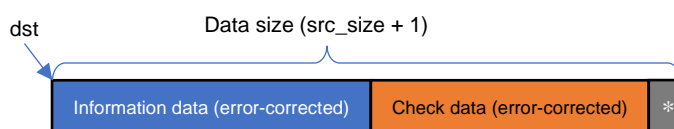

*: Error correction

Number of tiles	1
Segmented processing	Not supported

Description	<p>This function performs Reed-Solomon decoding using the specification listed below on the input data at the address specified by <code>src</code>, and outputs error-corrected data and the error correction result to the address specified by <code>dst</code>. To specify a user-defined primitive polynomial, use the <code>ReedSolomonGf8</code> function.</p> <p>Reed-Solomon decoding specification:</p> <ul style="list-style-type: none">• Galois field: $GF(2^8)$• Primitive polynomial over Galois field: $X^8+X^4+X^3+X^2+1$• Number of bits per symbol: 8 <p>The result of error correction is stored in "Error correction" appended at the end of output data. "Error correction" is stored "0" if the error correction succeeded, and "1" if failed.</p> <p>The number of symbols that can be used for error correction is equal to $\text{floor}(\text{check_size} \div 2)$. Therefore, no error correction takes place and the output data remains unchanged if <code>check_size</code> is set to 1. In this case 0 is output as the error correction result.</p> <p>This function performs decoding consisting of syndrome calculation, Euclidean algorithm, chain searching, and error value calculation, in that order. If no errors are detected, the processing ends with syndrome calculation. If errors are detected, the processing proceeds through error value calculation. Note that the larger the number of errors, the more processing time is required for the Euclidean algorithm and error value calculation.</p>
Note	<p>If the number of errors in the input data exceeds the number of symbols available for correction, false corrections may result. In some cases, even though false corrections lead to inaccurate decoding and error correction fails, the value of "Error correction" may not indicate failure (1), and symbols that are not in error may be changed.</p>

4.13.2 ReedSolomonGf8

ReedSolomonGf8

Performs error correction using GF(2⁸) Reed-Solomon codes

Configuration data file	r_drp_reed_solomon_gf8.dat
Supported version	1.00
Configuration data size (byte)	119872
Header file	r_drp_reed_solomon_gf8.h

Parameter	Structure name	
	r_drp_reed_solomon_gf8_t	
Member name	Type	Description
src	uint32_t	Input data address
dst	uint32_t	Output data address
correct_addr	uint32_t	Address to which error correction count is output
src_size	uint16_t	Input data size (bytes)
check_size	uint16_t	Check data size (bytes)
primitive	uint16_t	Primitive polynomial over Galois field (zero-dimensional coefficient as LSB) 0x11D in case of $\chi^8 + \chi^4 + \chi^3 + \chi^2 + 1$

I/O details	Input data	Address:	Specified by src.
		Data size:	Specified by src_size. (2 to 255 bytes)
		Information data:	Data for use in error correction (1 to 254 bytes)
		Check data:	Check data added during encoding for use in error correction
		Check data size:	Specified by check_size. (1 to 127 bytes)

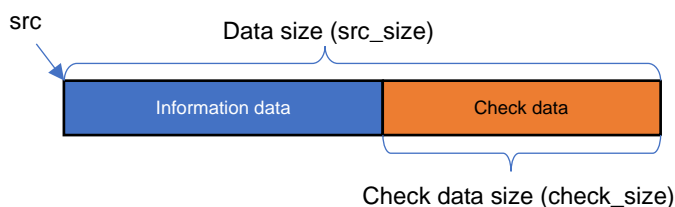

The information data and check data are input as Reed-Solomon encoded results. The encoded results are assumed to have the zero-dimensional coefficient of the primitive polynomial as the LSB.

For reference, the correspondence between the exponential expression and vector expression of the Galois field is $\alpha^0, \alpha^1, \alpha^2$ to 0x01, 0x02, 0x04.

Output data	Address:	Specified by dst.
	Data size:	src_size
	Information data (error-corrected):	Error corrected data. (Size is same as that of information data.)
	Check data (error-corrected):	Check data for error correction. (Size is same as that of check data.)

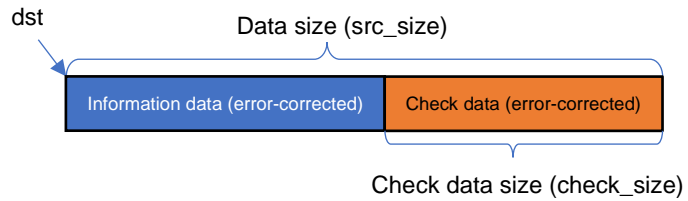

Error correction count	Address:	Specified by correct_addr.
	Data size:	1 byte
	Description	The result of Reed-Solomon decoding is output. The decoding result is the number of errors that were corrected. If there were no errors in the input data, 0 is output. If error correction fails, 0xff is output.

Number of tiles	1
Segmented processing	Not supported

Description	<p>This function performs Reed-Solomon decoding using the specification listed below on the input data at the address specified by <code>src</code>, and outputs error-corrected data to the address specified by <code>dst</code> and the error correction count to the address specified by <code>correct_addr</code>.</p> <p>Reed-Solomon decoding specification:</p> <ul style="list-style-type: none">• Galois field: GF(2⁸)• Primitive polynomial over Galois field: Specified by <code>primitive</code>• Number of bits per symbol: 8 <p>The zero-dimensional coefficient of the primitive polynomial over Galois field is set as the LSB. For example, <code>primitive</code> is set to 0x11D to specify $\chi^8 + \chi^4 + \chi^3 + \chi^2 + 1$.</p> <p>The number of errors corrected by Reed-Solomon decoding is stored at the address specified by <code>correct_addr</code>. When error correction is successful, a value equal to the correction count is stored at the address specified by <code>correct_addr</code>, and 0xff is stored when error correction fails. When error correction fails, no corrections are applied and the output data remains unchanged.</p> <p>The number of symbols that can be used for error correction is equal to $\text{floor}(\text{check_size} \div 2)$. Therefore, no error correction takes place and the output data remains unchanged if <code>check_size</code> is set to 1. A value of 0xff is output rather than 0 as the error correction count.</p> <p>This function performs decoding consisting of syndrome calculation, Euclidean algorithm, chain searching, and error value calculation, in that order. If no errors are detected, the processing ends with syndrome calculation. If errors are detected, the processing proceeds through error value calculation. Note that the larger the number of errors, the more processing time is required for the Euclidean algorithm and error value calculation.</p>
Note	<p>If the number of errors in the input data exceeds the number of symbols available for correction, false corrections may result. In some cases, even though false corrections lead to inaccurate decoding and error correction fails, the value of "Error correction" may not indicate failure (0xff), and symbols that are not in error may be changed.</p>

4.13.3 Thinning

Thinning

Outputs an image on which thinning has been performed

Configuration data file	r_drp_thinning.dat		
Supported version	1.00		
Configuration data size (byte)	119456		
Header file	r_drp_thinning.h		
Parameter	Structure name		
	r_drp_thinning_t		
	Member name	Type	Description
	src	uint32_t	Input data address
	dst	uint32_t	Output data address
	width	uint16_t	Image width (pixels)
	height	uint16_t	Image height (pixels)
	result	uint32_t	Address of processing results
	top	uint8_t	1: Top edge border processing 0: No top edge border processing Specify 1 if the input image is not segmented. For segmenting the input image for processing, specify 1 if the input image reaches the top edge of the source image.
	bottom	uint8_t	1: Bottom edge border processing 0: No bottom edge border processing Specify 1 if the input image is not segmented. For segmenting the input image for processing, specify 1 if the input image reaches the bottom edge of the source image.
	step	uint8_t	Type of repeat processing 0: step1 1: step2 Specify step1 for odd-numbered processing repetitions. Specify step2 for even-numbered processing repetitions. Refer to the description for details.
	reverse	uint8_t	0: Thinning is performed on white portions. 1: Thinning is performed on black portions.
	threshold	uint8_t	Binarization threshold (0 to 255)
I/O details	Input image	Address:	Specified by src.
		Width (pixels):	Specified by width. (128 to 1280, integer multiple of 8)
		Height (pixels):	Specified by height. (16 to 960)
		Format:	8-bit grayscale (1 byte per pixel) A value of 0 is treated as black, and values of 1 or greater are treated as white.
		Data size:	(width) × (height) × 1 byte
	Output image	Address:	Specified by dst.
		Width (pixels):	Same as input image
		Height (pixels):	Same as input image
		Format:	8-bit grayscale (0 or 255) (1 byte per pixel) Black is output as 0 and white as 255.
		Data size:	(width) × (height) × 1 byte

Processing results	Address:	Specified by result. (Specify an address that differs from src or dst.)
	Data size:	4 bytes
	Format:	Number of pixels in white portions changed to black (4 bytes) (0 to width × height)
	Description	This is the area where the number of pixels in white portions changed to black (or in black portions changed to white) as a result of thinning is stored. When the number of pixels in white portions changed to black (or in black portions changed to white) is 0, it means that thinning has completed. Refer to the description for details.
Number of tiles	3	
Segmented processing	Supported	

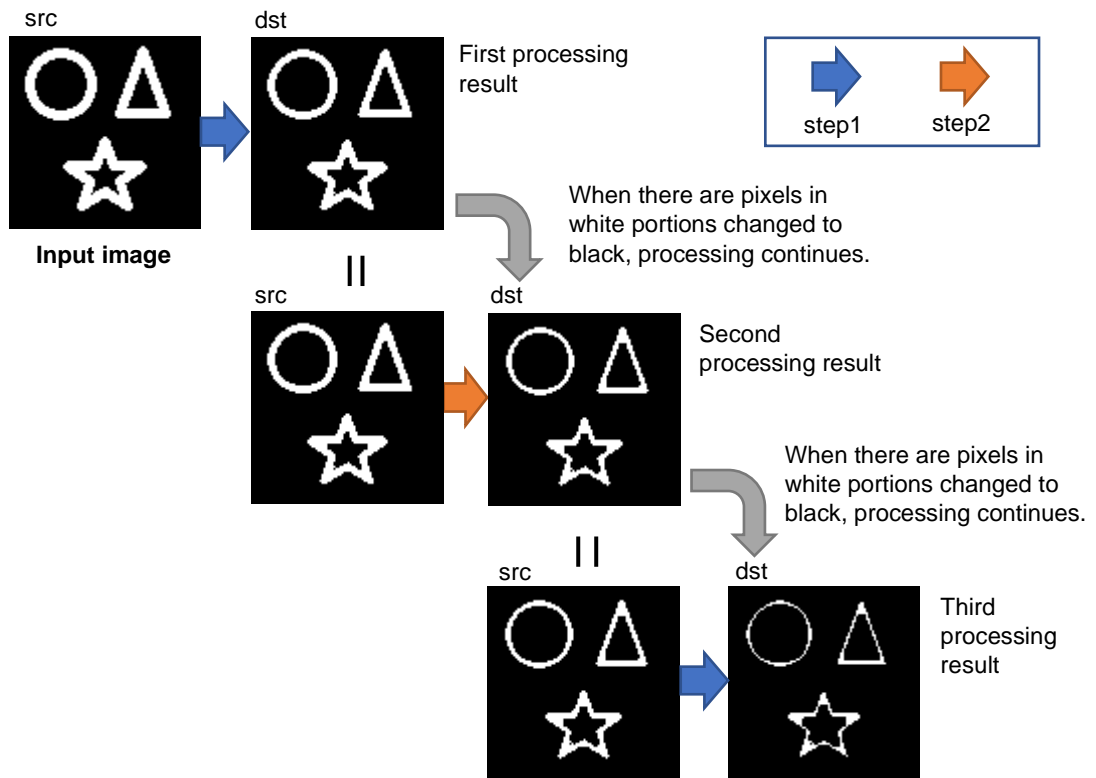

If segmented processing of this function is not used, the same address may be specified for both src and dst.

Note	None
------	------

4.13.4 ImageMerging

ImageMerging

Merges two grayscale-images separately captured over different ranges

Configuration data file	r_drp_image_merging.dat		
Supported version	1.00		
Configuration data size (byte)	851360		
Header file	r_drp_image_merging.h		
Parameter	Structure name		
	r_drp_image_merging_t		
	Member name	Type	Description
	src_adr1	uint32_t	Address of input image 1
	src_adr2	uint32_t	Address of input image 2
	dst_adr	uint32_t	Output image address
	width	uint16_t	Image width
	height1	uint16_t	Height of input image 1
	height2	uint16_t	Height of input image 2
	search_window_w	uint8_t	Template selection area width (34 to 128, integer multiple of 2) For details of template selection area, refer to the description.
	search_window_h	uint8_t	Template selection area height (34 to 128, integer multiple of 2) For details of template selection area, refer to the description.
	search_window1_x	uint16_t	X-coordinate at the upper left of the template selection area 1 For details of setting range, refer to the description.
	search_window1_y	uint16_t	Y-coordinate at the upper left of the template selection area 1 For details of setting range, refer to the description.
	search_window2_x	uint16_t	X-coordinate at the upper left of the template selection area 2 For details of setting range, refer to the description.
	search_window2_y	uint16_t	Y-coordinate at the upper left of the template selection area 2 For details of setting range, refer to the description.
	search_window3_x	uint16_t	X-coordinate at the upper left of the template selection area 3 For details of setting range, refer to the description.
	search_window3_y	uint16_t	Y-coordinate at the upper left of the template selection area 3 For details of setting range, refer to the description.
	search_window4_x	uint16_t	X-coordinate at the upper left of the template selection area 4 For details of setting range, refer to the description.
	search_window4_y	uint16_t	Y-coordinate at the upper left of the template selection area 4 For details of setting range, refer to the description.
	src_diff	uint16_t	Value for determining the height of overlap area of input image 1 and input image 2 (0 to search_window*_y ¹ - max_ga_y - 2) Note 1: Minimum value among the upper left Y coordinates of template selection areas 1 to 4 For details of the definition of overlap area, refer to the description.
	max_gap_x	uint8_t	Maximum value of the difference in positions in the X direction between the template and the image for matching (0 to 126) From the viewpoint of processing speed and for preventing misjudgments in matching, values no greater than 16 are recommended.
	max_gap_y	uint8_t	Maximum value of the position difference in the Y direction between the template and the image for matching (0 to 126) From the viewpoint of processing speed and for preventing misjudgments in matching, values no greater than 16 are recommended.
	angledata_adr	uint32_t	Address of the angle data for rotation correction
	angle_times	uint8_t	Number of times of rotation correction (0 to 255) If 0 is specified, the rotation correction is not performed.
	result_adr	uint32_t	Merge-information address
	padding_value	uint8_t	Output value when outside range of referenced input image

I/O details	Input image 1	Address:	Specified by src_adr1.
		Width (pixels):	Specified by width. (Maximum value is 1920, integer multiple of 2)
		Height (pixels):	Specified by height1. (Maximum value is 1080, integer multiple of 2)
		Format:	8-bit grayscale (1 byte per pixel)
		Data size:	(width) × (height1) × 1 byte
	Input image 2	Address:	Specified by src_adr2.
		Width (pixels):	Same as input image 1
		Height (pixels):	Specified by height2. (Maximum value is 1080, integer multiple of 2)
		Format:	8-bit grayscale (1 byte per pixel)
		Data size:	(width) × (height2) × 1 byte
	Output image	Address:	Specified by dst_adr.
		Width (pixels):	Same as input image 1
		Height (pixels):	height2 + src_diff + max_gap_y (maximum value)
		Format:	8-bit grayscale (1 byte per pixel)
		Data size:	(width) × (height2 + src_diff + max_gap_y) × 1 byte
	Angle data (Input)	Address:	Specified by angledata_adr.
		Data size:	angle_times × 4 bytes
		Format:	Starting from the address, sine value for the rotation angle (2-byte) cosine value for the rotation angle (2-byte)

Description

The sine and cosine values for the angle of rotation are input in the 4-byte units the number of times correction for rotation proceeds. This function assumes the input image is not rotated. A subtle rotation can be corrected by setting the angle data. If 0 is set to angledata_adr, the rotation correction is not performed. If a value other than 0 is set to angledata_adr, the rotation correction is performed for the specified angle data. If matching processing without angle correction is required in addition to matching with rotation correction, set the angle data to 0 degrees to obtain the former processing. If the setting for the angle of rotation is excessively large, the template and the image area for judgment of matching may not overlap. This may make perfect merging of the images impossible. In addition, from the viewpoint of the quality of the output images, constraining the angles of rotation to within the range ± 5 degrees is recommended.

The format for the sine and cosine values is as shown in the figure below.

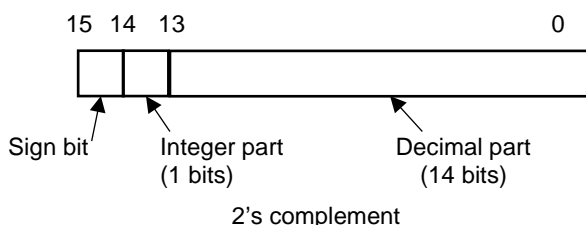

Refer to the description for details.

Merge information	Address: Data size: Format:	Specified by result_adr. 36 bytes Starting from the address, Output image width (2 bytes) Output image height (2 bytes) Position difference of matching result in the X direction (2 bytes) Position difference of matching result in the Y direction (2 bytes) sine value for the rotation angle of matching result (2 bytes) cosine value for the rotation angle of matching result (2 bytes) X-coordinate value at the upper left of the selected template 1 (2 bytes) Y-coordinate value at the upper left of the selected template 1 (2 bytes) X-coordinate value at the upper left of the selected template 2 (2 bytes) Y-coordinate value at the upper left of the selected template 2 (2 bytes) X-coordinate value at the upper left of the selected template 3 (2 bytes) Y-coordinate value at the upper left of the selected template 3 (2 bytes) X-coordinate value at the upper left of the selected template 4 (2 bytes) Y-coordinate value at the upper left of the selected template 4 (2 bytes) Position difference of matching result of the template 1 in the X direction (1 byte) Position difference of matching result of the template 1 in the Y direction (1 byte) Position difference of matching result of the template 2 in the X direction (1 byte) Position difference of matching result of the template 2 in the Y direction (1 byte) Position difference of matching result of the template 3 in the X direction (1 byte) Position difference of matching result of the template 3 in the Y direction (1 byte) Position difference of matching result of the template 4 in the X direction (1 byte) Position difference of matching result of the template 4 in the Y direction (1 byte)
	Description	The merging result information is output. The format for sine and cosine values is the same as that for the angle data. If the rotation correction is not performed, sine value = 0x0000 and cosine value = 0x4000 are output.
Number of tiles	6	
Segmented processing	Not supported	

Description This function merges two grayscale images stored at the addresses specified with `src_adr1` and `src_adr2` and outputs the result to the address specified by `dst_adr`. The two images must have the same scale. The merging proceeds in the vertical direction.

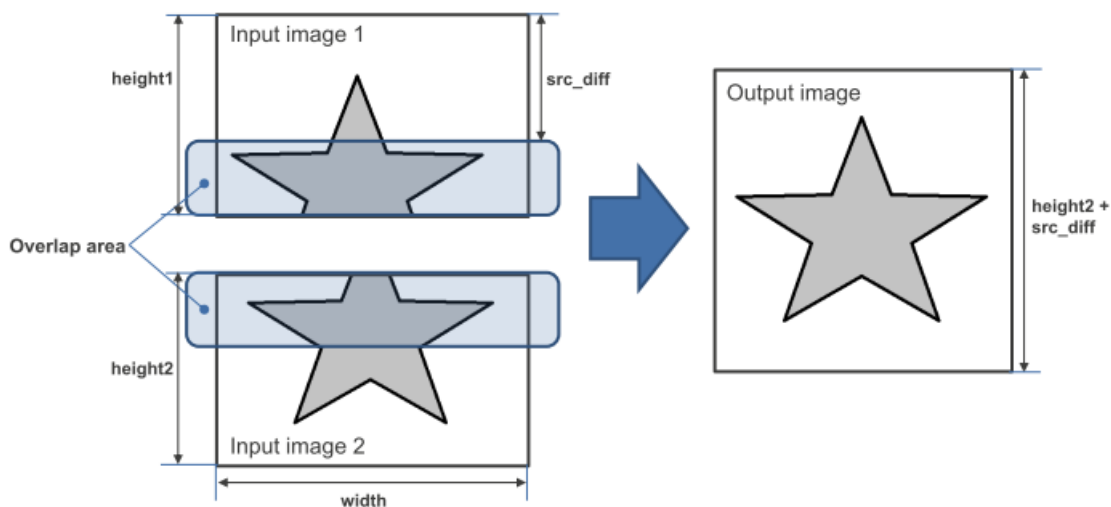

For using this function, the user is required to grasp the approximate value of the overlap (the overlap area) of the input images 1 and 2 in advance. Even if there is a position difference between the input images 1 and 2 in the overlap area, as long as the difference is small, the difference can be corrected and the images can be merged. The maximum values of the differences in position are specified with `max_gap_x` and `max_gap_y`. Even if the images have been rotated, as long as the difference is small, the difference can be corrected and the images can be merged. The amount of rotation is specified with `angledata_adr` and `angle_times`.

This function performs the processing as shown below.

1. Selecting templates
2. Matching of templates 1 to 4
3. Matching of the whole of the images
4. Merging of images

The details of each processing are described in the following pages.

1. Selecting templates

This function performs matching of two input images using the minutiae points (templates) and merges the images. This function selects 4 templates from the input image 1. To perform this selection, 4 template selection areas are specified at the overlap area of the input image 1. Within the specified template selection area, the 32 × 32 pixels area in which the entropy (the sum of 3 × 3 sobel filter values) becomes maximum is selected as the template.

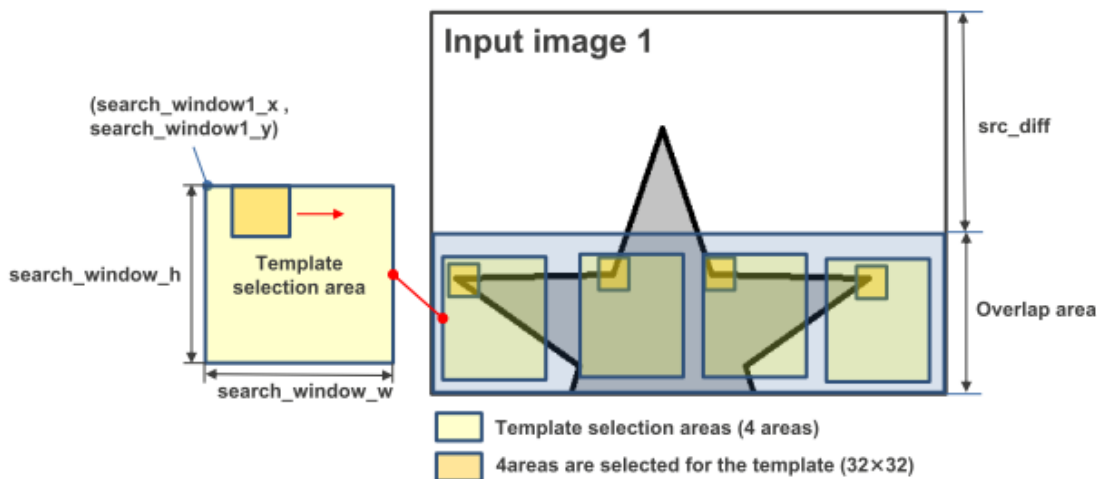

The template selection area shall be set to satisfy the following two conditions.

- (1) The template selection area shall have a margin at least one pixel within the overlap area.
- (2) The template selection area shall have a margin at least max_gap_x and max_gap_y within the overlap area.

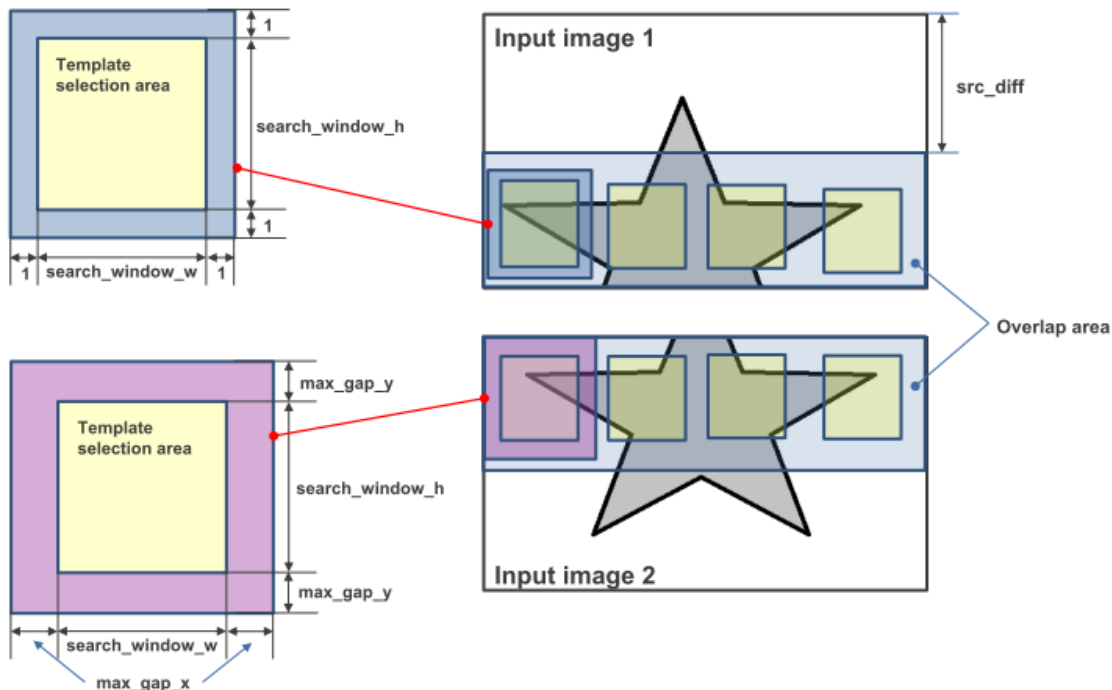

For details of the Sobel filter, refer to 4.10.4 Sobel.

2. Matching of templates 1 to 4

This step checks what position on the input image 2 matches the selected template on the input image 1.

Assuming the upper left coordinate on the template on the input image 1 as (x1, y1), the corresponding coordinate (x2, y2) on the input image 2 becomes as follows.

$$(x2, y2) = (x1, y1 - \text{src_diff})$$

A matching processing using SAD method is performed for the 32 × 32 area starting from (x2, y2) and the template of the input image 1. Assuming the brightness value of input image 2 as I(x, y) and that of the template as T(x, y), the value of SAD is obtained using the following calculation.

$$SAD = \sum_y^{y+32} \sum_x^{x+32} |I(x, y) - T(x, y)|$$

Calculate all of SAD values at the areas from (x2 - max_gap_x, y2 - max_gap_y) to (x2 + max_gap_x, y2 + max_gap_y). Then obtain (x3, y3) where the value of SAD becomes minimum for each template, and calculate the position differences in the X direction and Y direction for each template.

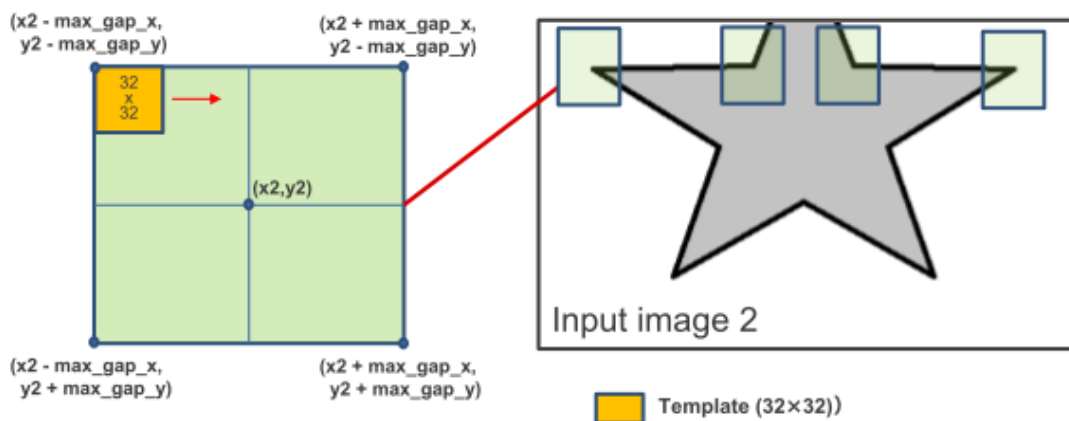

3. Matching of the whole of the images

Using the position differences of X and Y directions and the angle data of rotation correction obtained in the matching processing of the templates 1 to 4, the matching processing of whole of the images is performed.

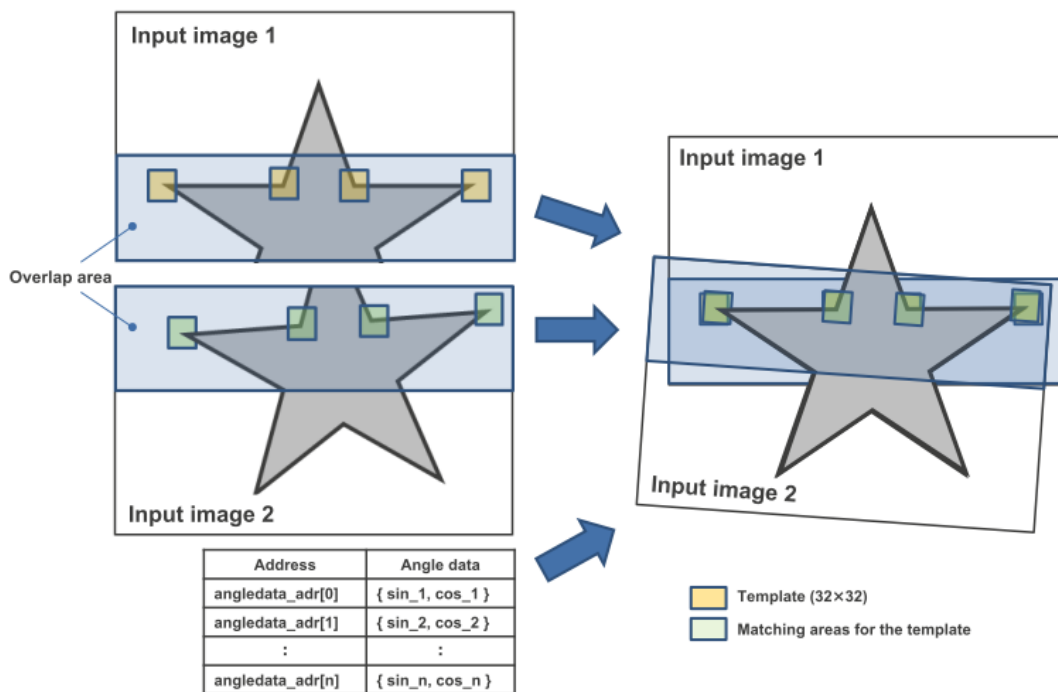

4. Merging of images

The input images 1 and 2 are merged, and the result of merging is output to the output image area.

- (1) The input image 1 is copied to the output image area from the first line to the src_diff-th line of the output image area.
- (2) The merging result using the input images 1 and 2 is output to the src_diff+1-th line to the height1-th line of the output image area.
- (3) With regard to the output image area from the height1+1-th line to the end, the result using the input image 2 is output.

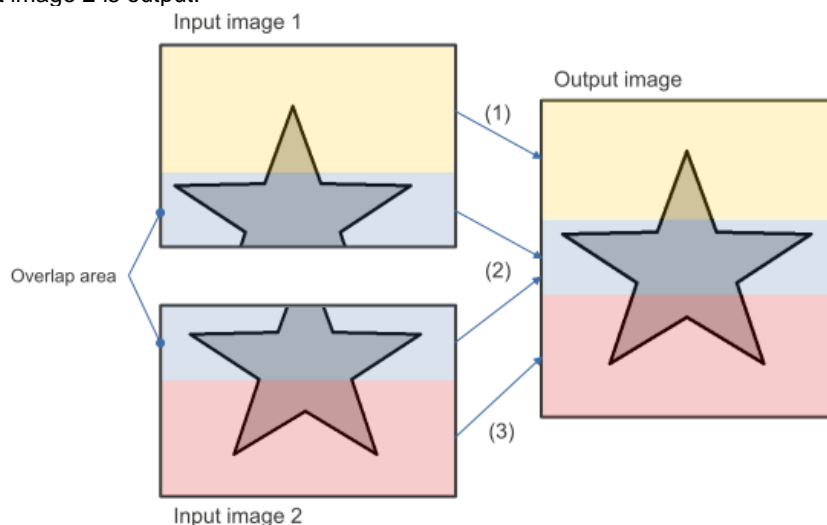

This function allows the same address to be specified for both src_adr1 and dst_adr.

Note	None
------	------

5. Using the DRP Library

To use this library, it is necessary to initialize the DRP, load configuration data, etc. Also, since the parameters are different for each configuration data, set the parameters based on the specification of the configuration data to be used. For application example of DRP library, refer to "RZ/A2M Group 2D Barcode Application Note (R01AN4503)".

6. Reference Documents

User's Manual: Hardware

RZ/A2M Group User's Manual: Hardware (R01UH0746)

(Download the latest version of the update or news from the Renesas Electronics website.)

User's Manual: Software

RZ/A2M Group DRP Driver User's Manual (R01US0355)

(Download the latest version of the update or news from the Renesas Electronics website.)

RZ/A2M Group 2D Barcode Sample Program Application Note (R01AN4503)

(Download the latest version of the update or news from the Renesas Electronics website.)

User's Manual: Development environment

For the Renesas Electronics integrated development environment (e² studio), visit the Renesas Electronics website to download the latest version.

Technical Update/Technical News

(Download the latest version of the update or news from the Renesas Electronics website.)

Revision History	RZ/A2M Group DRP Library User's Manual
------------------	--

Rev.	Date	Description	
		Page	Summary
1.00	Sep. 28, 2018	—	First Edition issued
1.01	Dec. 28, 2018	7	Following functions were added to Table 1.1 DRP Library Functions. (1) Prewitt (2) Opening (3) Closing (4) ResizeBilinearFixed (5) ResizeNearest (6) CircleFitting (7) Histogram
		9	2 Operation Conditions, The version of RENESAS e ² studio was changed to 7.3.0.
		10, 11	3 File Structure, The configuration data and header files were added.
		12	4.1 How to Read the DRP Library Reference, An explanation for segmented processing was added.
		13	4.2 Simple ISP, section was added.
		20	4.3.1BinarizationFixed, The reference URL in the description column was changed.
		27	4.3.4Dilate The explanations for the top and bottom in parameter column were changed. The reference URL in the description section was changed, and an explanation was added.
		29	4.3.5 Erode The explanations for the top and bottom in parameter column were changed. The reference URL in the description section was changed, and an explanation was added.
		33	4.3.7 GaussianBlur The explanations for the top and bottom in parameter column were changed. The reference URL in the description section was changed, and the explanation was changed.
		35	4.3.8 MedianBlur The explanations for the top and bottom in parameter column were changed. The reference URL in the description section was changed, and the explanation was changed.
		37	4.3.9 Sobel The explanations for the top and bottom in parameter column were changed. The explanations in the description column were changed.
		39	4.3.10 Prewitt, section was added.
		43	4.3.11 UnsharpMasking The explanations for the top and bottom in parameter column were changed. The reference URL in the description section was changed, and the explanation was changed.
		45	4.3.13 Opening section was added.
48	4.3.14 Closing section was added.		

Rev.	Date	Description	
		Page	Summary
1.01	Dec. 28, 2018	52	4.4.2 Bayer2Grayscale The explanations for the top and bottom in parameter column were changed. The reference URL in the description section was changed, and the explanation was changed.
		66	4.4.6 ResizeBilinearFixed The title was changed from ResizeBilinear to ResizeBilinearFixed. The descriptions of I/O details, Input image width, and Data size were corrected. The reference URL in the description section was changed.
		68	4.4.7 ResizeBilinear section was added.
		70	4.4.8 ResizeNearest section was added.
		75	4.5.1 CannyCalculate The explanations for the top and bottom in parameter column were changed. The reference URL in the description section was changed.
		79	4.5.3 CornerHarris The figure, reference URL, and explanation in the description column were changed.
		81	4.5.4 CircleFitting section was added.
		108	4.6.2 Histogram section was added.
1.02	Apr. 15, 2019	7	The following functions were added to Table 1.1 DRP Library Functions. · Laplacian · Bayer2Rgb · ImageRotate · Affine · MinutiaeExtract · MinutiaeDelete · Thinning · ReedSolomonGf8
		10	Configuration data and header files were added to 3. File Structure.
		41	4.3.11 Laplacian added.
		55	4.4.3 Bayer2Rgb added.
		63	4.4.5 ImageRotate added.
		72	4.4.9 Affine added.
		85	4.5.5 MinutiaeExtract added.
		92	4.5.6 MinutiaeDelete added.
		102	4.5.8 Thinning added.
		106	4.6.1 ReedSolomon · The maximum value of input data size src_size was changed. · Changes were made to I/O details, Description, and Note.
1.03	May 31, 2019	46	4.3.13 HistogramNormalization added.
		49	4.3.14 HistogramNormalizationRgb added.
		69	4.4.4 Bayer2RgbColorCorrection added.
		74	4.4.6 CroppingRgb added.
		80	4.4.9 ResizeBilinearFixedRgb
		98	4.5.5 FindContours added
1.04	Sep 30, 2019	13	4.1 How to Read the DRP Library Reference

			<ul style="list-style-type: none"> · The description of the parameter column was changed.
		18	4.2.3 Simple ISP API <ul style="list-style-type: none"> · Added YCbCr422 output format.
		46	4.3.13 HistogramNormalization <ul style="list-style-type: none"> · The Supported version was updated to 1.00. · The Configuration data size was changed.
		49	4.3.14 HistogramNormalizationRgb <ul style="list-style-type: none"> · The Supported version was updated to 1.00. · The Configuration data size was changed.
		69	4.4.4 Bayer2RgbColorCorrection <ul style="list-style-type: none"> · The Supported version was updated to 1.00. · The Configuration data size was changed.
		74	4.4.6 CroppingRgb <ul style="list-style-type: none"> · The Supported version was updated to 1.00.
		80	4.4.9 ResizeBilinearFixedRgb <ul style="list-style-type: none"> · The Supported version was updated to 1.00. · The Configuration data size was changed.
		88	4.5.1 CannyCalculate <ul style="list-style-type: none"> · Changed range of height of input image. · Corrected a typo in the description.
		98	4.5.5 FindContours <ul style="list-style-type: none"> · The Supported version was updated to 1.00. · The Configuration data size was changed. · Changed the minimum width and height of the input image. · Changed the minimum value of the maximum output number of rectangle information.
1.05	Dec 17, 2019	10, 11	3. File Structure <ul style="list-style-type: none"> · Changed file structure.
		14	4.2.1 Simple ISP overview <ul style="list-style-type: none"> · Added Figure 4.2.
		16, 18	4.2.3 Simple ISP API <ul style="list-style-type: none"> · Changed the parameter description
		32	4.3.6 GammaCorrection <ul style="list-style-type: none"> · The Supported version was updated to 1.00. · The Configuration data size was changed. · Added the table to the parameter column. · The description column was changed.
		47	4.3.13 HistogramNormalization <ul style="list-style-type: none"> · Corrected the src_pixel_rstd calculation formula of description.
		51	4.3.14 HistogramNormalizationRgb <ul style="list-style-type: none"> · Corrected the src_pixel_*_rstd calculation formula of description.
1.06	Mar 31, 2020	15	4.2.3 Simple ISP API <ul style="list-style-type: none"> · The Supported version was updated to 1.01. · The Configuration data size was changed.

1.07	Jun 30, 2020	7,8	<p>Following functions were added to Table 1.1 DRP Library Functions.</p> <ul style="list-style-type: none"> • Simple ISP with object detection by color (HSV) • Simple ISP with background subtraction • Simple ISP with object detection using sobel • Simple ISP with distortion correction • Simple ISP with scaling and normalization (32bit) • Simple ISP with color calibration and 3DNR • Remap • ImageMerging <p>Changed DRP Library categorization</p>
		9	2 Operation Conditions, the version of RENESAS e ² studio was changed to 7.8.0.
		10,11	Configuration data and header files were added to 3. File Structure.
		13	4.2.1 Simple ISP overview <ul style="list-style-type: none"> • The description was changed.
		14	4.2.2 Simple ISP Library Structure <ul style="list-style-type: none"> • YCbCr Planar format and RGB output format were added.
		15, 16, 17, 19	4.2.3 Simple Isp API <ul style="list-style-type: none"> • YCbCr Planar format and RGB output format were added. • Added Table 4.2.
		21	4.3 Simple ISP with object detection by color (HSV) was added.
		27	4.4 Simple ISP with background subtraction was added.
		36	4.5 Simple ISP with object detection using sobel was added.
		41	4.6 Simple ISP with distortion correction was added.
		47	4.7 Simple ISP with scaling and normalization (32bit) was added.
		52	4.8 Simple ISP with color calibration and 3DNR was added.
		-	4.9, 4.10, 4.11, 4.12, 4.13 Changed DRP Library categorization
		62	4.9.1 Bayer2Grayscale <ul style="list-style-type: none"> • The Supported version was updated to 1.00. • The Configuration data size was changed.
		65	4.9.2 Bayer2Rgb <ul style="list-style-type: none"> • The Supported version was updated to 1.00. • The Configuration data size was changed.
		71	4.9.3 Bayer2RgbColorCorrection <ul style="list-style-type: none"> • The Supported version was updated to 1.01. • The Configuration data size was changed.
		74	4.9.4 Argb2Grayscale <ul style="list-style-type: none"> • The Supported version was updated to 1.00. • The Configuration data size was changed.
		75	4.9.5 BinarizationFixed <ul style="list-style-type: none"> • The Supported version was updated to 1.00. • The Configuration data size was changed.
		76,78	4.9.6 BinarizationAdaptive <ul style="list-style-type: none"> • The Supported version was updated to 1.00. • The Configuration data size was changed. <p>Description of the case that the target block is within 2 blocks from the top edge or left edge in the description column was changed.</p>
		80	4.9.7 BinarizationAdaptiveBit <ul style="list-style-type: none"> • The Supported version was updated to 1.00. • The Configuration data size was changed.

		82	4.9.8 GammaCorrection <ul style="list-style-type: none"> • The Supported version was updated to 1.01. • The Configuration data size was changed.
		84	4.9.9 Cropping <ul style="list-style-type: none"> • The Supported version was updated to 1.00. • The Configuration data size was changed.
		86	4.9.10 CroppingRgb <ul style="list-style-type: none"> • The Supported version was updated to 1.01. • The Configuration data size was changed.
		87	4.9.11 ResizeBilinearFixed <ul style="list-style-type: none"> • The Supported version was updated to 1.00. • The Configuration data size was changed.
		89	4.9.12 ResizeBilinearFixedRgb <ul style="list-style-type: none"> • The Supported version was updated to 1.01. • The Configuration data size was changed.
		90	4.9.13 ResizeBilinear <ul style="list-style-type: none"> • The Supported version was updated to 1.00. • The Configuration data size was changed.
		92	4.9.14 ResizeNearest <ul style="list-style-type: none"> • The Supported version was updated to 1.00. • The Configuration data size was changed.
		94	4.9.15 ImageRotate <ul style="list-style-type: none"> • The Supported version was updated to 1.00. • The Configuration data size was changed. • The descriptions of the Output image width and Data size were corrected.
		98	4.9.16 Affine <ul style="list-style-type: none"> • The Supported version was updated to 1.00. • The Configuration data size was changed.
		101	4.9.17 Remap was added.
		106	4.10.1 MedianBlur <ul style="list-style-type: none"> • The Supported version was updated to 1.00. • The Configuration data size was changed.
		108	4.10.2 GaussianBlur <ul style="list-style-type: none"> • The Supported version was updated to 1.00. • The Configuration data size was changed.
		110	4.10.3 UnsharpMasking <ul style="list-style-type: none"> • The Supported version was updated to 1.00. • The Configuration data size was changed.
		112	4.10.4 Sobel <ul style="list-style-type: none"> • The Supported version was updated to 1.00. • The Configuration data size was changed.
		114	4.10.5 Prewitt <ul style="list-style-type: none"> • The Supported version was updated to 1.00. • The Configuration data size was changed.
		116	4.10.6 Laplacian <ul style="list-style-type: none"> • The Supported version was updated to 1.00. • The Configuration data size was changed.

		118	4.10.7 Dilate <ul style="list-style-type: none"> • The Supported version was updated to 1.00. • The Configuration data size was changed.
		120	4.10.8 Erode <ul style="list-style-type: none"> • The Supported version was updated to 1.00. • The Configuration data size was changed.
		128	4.11.1 CannyCalculate <ul style="list-style-type: none"> • The Supported version was updated to 1.00. • The Configuration data size was changed.
		130	4.11.2 CannyHysteresis <ul style="list-style-type: none"> • The Supported version was updated to 1.00. • The Configuration data size was changed.
		132	4.11.3 CornerHarris <ul style="list-style-type: none"> • The Supported version was updated to 1.00. • The Configuration data size was changed.
		134	4.11.4 MinutiaeExtract <ul style="list-style-type: none"> • The Supported version was updated to 1.00. • The Configuration data size was changed.
		141	4.11.5 MinutiaeDelete <ul style="list-style-type: none"> • The Supported version was updated to 1.00. • The Configuration data size was changed.
		151	4.11.6 CircleFitting <ul style="list-style-type: none"> • The Supported version was updated to 1.00. • The Configuration data size was changed.
		155	4.11.7 FindContours <ul style="list-style-type: none"> • The Supported version was updated to 1.01. • The Configuration data size was changed.
		159	4.12.1 Histogram <ul style="list-style-type: none"> • The Supported version was updated to 1.00. • The Configuration data size was changed.
		165	4.12.2 HistogramNormalization <ul style="list-style-type: none"> • The Supported version was updated to 1.01. • The Configuration data size was changed.
		168	4.12.3 HistogramNormalizationRgb <ul style="list-style-type: none"> • The Supported version was updated to 1.01. • The Configuration data size was changed.
		172	4.13.1 ReedSolomon <ul style="list-style-type: none"> • The Supported version was updated to 1.00. • The Configuration data size was changed.
		174	4.13.2 ReedSolomonGf8 <ul style="list-style-type: none"> • The Supported version was updated to 1.00. • The Configuration data size was changed.
		177	4.13.3 Thinning <ul style="list-style-type: none"> • The Supported version was updated to 1.00. • The Configuration data size was changed.
		181	4.13.4 ImageMerging was added.
1.08	Sep 30, 2020	7	1.2 Functions <ul style="list-style-type: none"> • Changed the category name of Simple ISP to image processing.

		13	4.2.1 Simple ISP overview <ul style="list-style-type: none"> • Modified Figure 4.1.
		18	4.2.3 Simple ISP API <ul style="list-style-type: none"> • Changed the formula of average luminance.
		71	4.9.3 Bayer2RgbColorCorrection <ul style="list-style-type: none"> • Modified supported version mistake.
		86	4.9.10 CroppingRgb <ul style="list-style-type: none"> • Modified supported version mistake.
		88	4.9.12 ResizeBilinearFixedRgb <ul style="list-style-type: none"> • Modified supported version mistake.
		165	4.12.2 HistogramNormalization <ul style="list-style-type: none"> • Modified supported version mistake.
		168	4.12.3 HistogramNormalizationRgb <ul style="list-style-type: none"> • Modified supported version mistake.
1.09	Dec 25, 2020	181	4.13.4 ImageMerging <ul style="list-style-type: none"> • Changed the description of src_diff.

RZ/A2M Group DRP Library User's Manual

Publication Date: Rev.1.00 Sep. 28, 2018
Rev.1.09 Dec. 25, 2020

Published by: Renesas Electronics Corporation

RZ/A2M Group



Renesas Electronics Corporation

R01US0367EJ0109

**SALES OFFICES****Renesas Electronics Corporation**<http://www.renesas.com>Refer to "<http://www.renesas.com/>" for the latest and detailed information.**Renesas Electronics Corporation**

TOYOSU FORESIA, 3-2-24 Toyosu, Koto-ku, Tokyo 135-0061, Japan

Renesas Electronics America Inc.1001 Murphy Ranch Road, Milpitas, CA 95035, U.S.A.
Tel: +1-408-432-8888, Fax: +1-408-434-5351**Renesas Electronics Canada Limited**9251 Yonge Street, Suite 8309 Richmond Hill, Ontario Canada L4C 9T3
Tel: +1-905-237-2004**Renesas Electronics Europe GmbH**Arcadiastrasse 10, 40472 Düsseldorf, Germany
Tel: +49-211-6503-0, Fax: +49-211-6503-1327**Renesas Electronics (China) Co., Ltd.**Room 101-T01, Floor 1, Building 7, Yard No. 7, 8th Street, Shangdi, Haidian District, Beijing 100085, China
Tel: +86-10-8235-1155, Fax: +86-10-8235-7679**Renesas Electronics (Shanghai) Co., Ltd.**Unit 301, Tower A, Central Towers, 555 Langao Road, Putuo District, Shanghai 200333, China
Tel: +86-21-2226-0888, Fax: +86-21-2226-0999**Renesas Electronics Hong Kong Limited**Unit 1601-1611, 16/F., Tower 2, Grand Century Place, 193 Prince Edward Road West, Mongkok, Kowloon, Hong Kong
Tel: +852-2265-6688, Fax: +852 2886-9022**Renesas Electronics Taiwan Co., Ltd.**13F, No. 363, Fu Shing North Road, Taipei 10543, Taiwan
Tel: +886-2-8175-9600, Fax: +886 2-8175-9670**Renesas Electronics Singapore Pte. Ltd.**80 Bendemeer Road, Unit #06-02 Hyflux Innovation Centre, Singapore 339949
Tel: +65-6213-0200, Fax: +65-6213-0300**Renesas Electronics Malaysia Sdn.Bhd.**Unit No 3A-1 Level 3A Tower 8 UOA Business Park, No 1 Jalan Pengaturcara U1/51A, Seksyen U1, 40150 Shah Alam, Selangor, Malaysia
Tel: +60-3-5022-1288, Fax: +60-3-5022-1290**Renesas Electronics India Pvt. Ltd.**No.777C, 100 Feet Road, HAL 2nd Stage, Indiranagar, Bangalore 560 038, India
Tel: +91-80-67208700**Renesas Electronics Korea Co., Ltd.**17F, KAMCO Yangjae Tower, 262, Gangnam-daero, Gangnam-gu, Seoul, 06265 Korea
Tel: +82-2-558-3737, Fax: +82-2-558-5338