

# RZ/A2M Group

## Iris Detection sample program

---

### Introduction

This document describes the contents of the Iris Detection sample program.

### Target Device

RZ/A2M

### Contents

1. Overview .....	2
2. Operation Confirmation Conditions .....	3
3. Folder Structure .....	5
4. Sample Program .....	6
4.1 Specification of Input / Output .....	7
4.1.1 Specification of Input .....	7
4.1.2 Specification of Output .....	7
4.2 Simple ISP .....	9
4.2.1 Auto Exposure Correction (AE) .....	9
4.2.2 Convert Format to Grayscale .....	11
4.2.3 Suppress Noise .....	12
4.3 Circle Detection .....	13
4.3.1 Rough Detection .....	13
4.3.2 Fine Detection .....	14
4.4 Cropping Image .....	15
4.5 Memory footprint .....	16
5. DRP Library .....	17
6. Reference Documents .....	18
Revision History .....	19

## 1. Overview

This application note explains the sample program which detects an iris using the DRP (Dynamically Reconfigurable Processor) and the CPU.

This sample program crops and outputs any detected iris image, taken from an image captured by a camera, according to the ISO/IEC 19794-6:2011<sup>\*1</sup> standard format.

This sample program has the following features.

1. Robust iris detection using the ISP<sup>\*2</sup> which avoids influence from surrounding brightness conditions.
2. No need to capture at a close distance; an iris can be detected from an image of the entire face.
3. Realtime iris detection using the DRP (Dynamically Reconfigurable Processor) mounted on the RZ/A2M.
4. Output iris image conforms to the requirements of the ISO/IEC 19794-6:2011 standard.

Note: 1. ISO/IEC 19794-6:2011 specifies iris image interchange formats for biometric enrolment, verification and identification systems.

2. This is the SimpleIsp function of DRP Library. For details, refer to 4.2 Simple ISP.

The following Figure 1.1 outlines the process of this sample program.

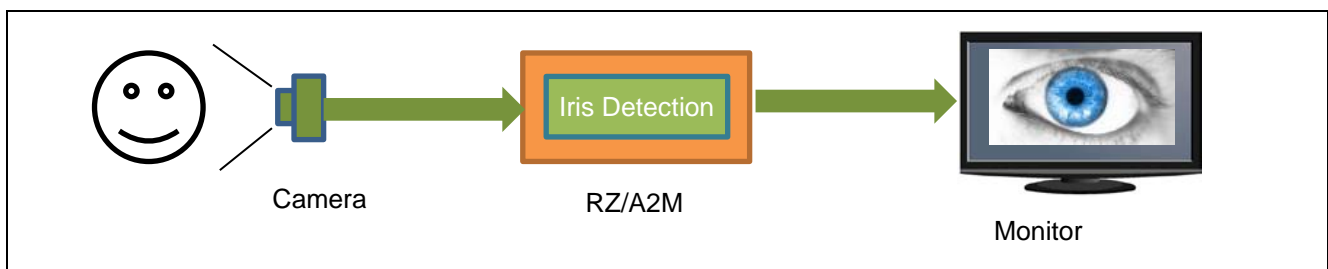

**Figure 1.1 System overview of iris detection sample program**

The assumed use-case of this sample program is an authentication system using cloud connection.

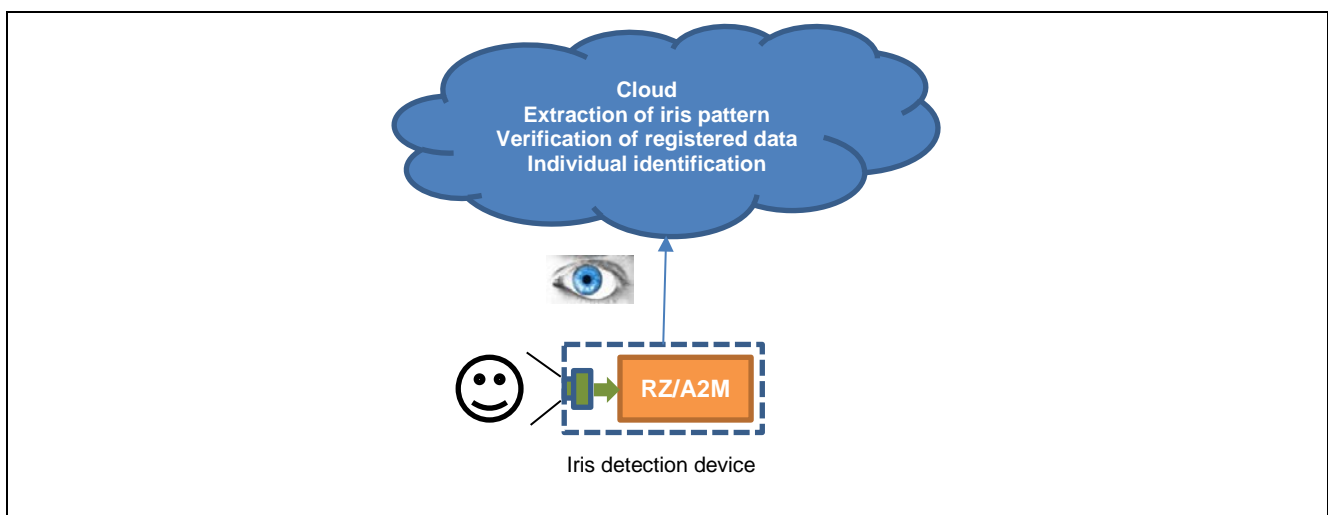

**Figure 1.2 Iris recognition system**

## 2. Operation Confirmation Conditions

Figure 2.1 shows the environment for checking the operation of this sample program. Refer to the release notes for DIP SW and jumper settings. For the display contents of the monitor, refer to Section 4.1.1 Specification of Input.

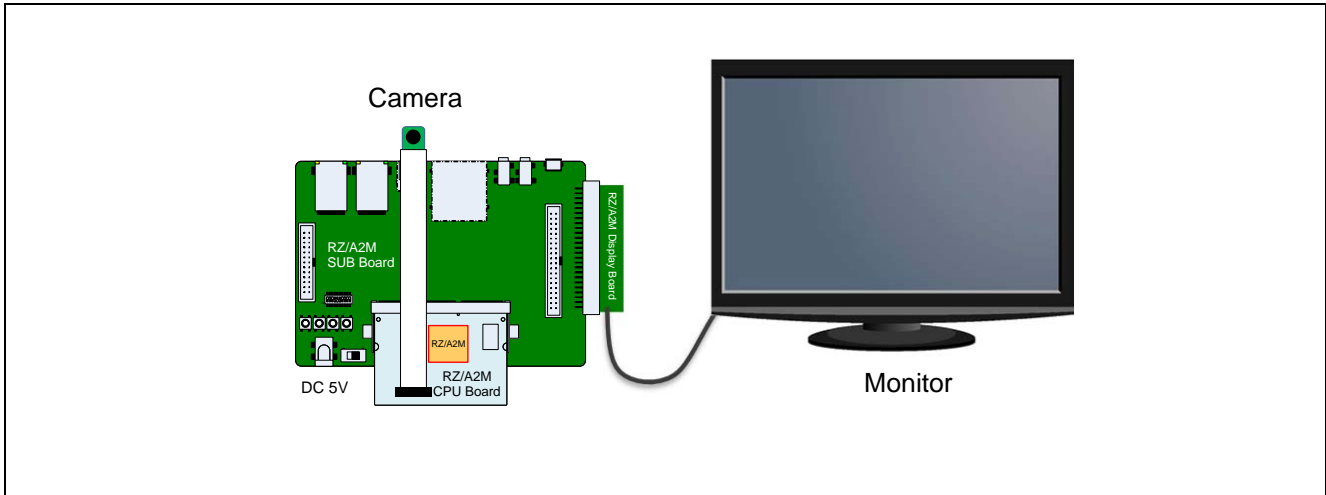

**Figure 2.1 Operation check conditions**

For this sample program, the cameras shown in Table 2.1 can be used. There is no difference in the connection method for each camera. It is also not necessary to change the source code.

No.1 is included in the RZ/A2M Evaluation Board Kit, so you can use it immediately after purchasing the RZ/A2M Evaluation Board Kit. No. 2 is most suitable for iris detection in darkness compared to No.1. No.3 can detect the iris at a distance of about 20 cm from the camera to the face. Compared to No.3, No.4 is best suited for detecting irises in the dark.

**Table 2.1 List of available cameras**

No.	Camera	Manufacturer	Distance between the camera and face	Note
1	Raspberry Pi Camera V2	Raspberry Pi Foundation	About 10 to 12 cm	Included with RZ/A2M Evaluation Board Kit
2	Raspberry Pi NoIR Camera V2	Raspberry Pi Foundation	About 10 to 12 cm	No infrared cut-off filter
3	B0102-V2 IMX219 Camera module with CS lens 2718	Arducam	About 20 cm	-
4	B0153 IMX219 Camera module with CS lens 2718	Arducam	About 20 cm	No infrared cut-off filter

The sample code of this application has been verified using the following conditions.

**Table 2.2 Operation Confirmation Conditions**

Item	Contents
Microcomputer	RZ/A2M
Operating frequency*1 [MHz]	CPU Clock (I $\phi$ ): 528MHz Image Processing Clock (G $\phi$ ): 264MHz Internal Bus Clock (B $\phi$ ): 132MHz Peripheral Clock 1 (P1 $\phi$ ): 66MHz Peripheral Clock 0 (P0 $\phi$ ): 33MHz QSPI0_SPCLK: 66MHz CKIO: 132MHz
Operating voltage	Power supply voltage (I/O): 3.3 V Power supply voltage (either 1.8V or 3.3V I/O (PVcc SPI)): 3.3V Power supply voltage (internal): 1.2 V
Integrated development environment	e2 studio (Refer to the release notes for e2 studio version.)
C compiler	GNU Arm Embedded Toolchain 6-2017-q2-update Compiler options (except directory path) Release: -mcpu=cortex-a9 -march=armv7-a -marm -mlittle-endian -mfloat-abi=hard -mfpu=neon -mno-unaligned-access -O2 -ffunction-sections -fdata-sections -Wunused -Wuninitialized -Wall -Wextra -Wmissing-declarations -Wconversion -Wpointer-arith -Wpadded -Wshadow -Wlogical-op -Waggregate-return -Wfloat-equal -Wnull-dereference -Wmaybe-uninitialized -g3 -Wstack-usage=100 -fabi-version=0 Hardware Debug: -mcpu=cortex-a9 -march=armv7-a -marm -mlittle-endian -mfloat-abi=hard -mfpu=neon -mno-unaligned-access -Og -ffunction-sections -fdata-sections -Wunused -Wuninitialized -Wall -Wextra -Wmissing-declarations -Wconversion -Wpointer-arith -Wpadded -Wshadow -Wlogical-op -Waggregate-return -Wfloat-equal -Wnull-dereference -Wmaybe-uninitialized -g3 -Wstack-usage=100 -fabi-version=0
Operation mode	Boot mode 3 (Serial Flash boot 3.3V)
Board	RZ/A2M CPU board RTK7921053C00000BE RZ/A2M SUB board RTK79210XXB00000BE Display Output Board RTK79210XXB00010BE
Camera	Camera for Raspberry Pi using IMX 219 CMOS sensor
Monitor	Full-WXGA (1366 x 768) monitor compatible with resolution
Device (functionality to be used on the board)	Serial flash memory allocated to SPI multi-I/O bus space (channel 0) Manufacturer: Macronix Inc. Model Name: MX25L51245GXD HyperRAM™ <sup>2</sup> (Connected to HyperRAM™ space) Manufacturer: Cypress Inc. Model Name: S27KS0641DPBH020

Note: 1. The operating frequency used in clock mode 1 (Clock input of 24MHz from EXTAL pin).

2. HyperRAM™ is a registered trademark of Cypress Semiconductor Corporation.

### 3. Folder Structure

For the folder structure, refer to the release note for the RZ/A2M Group IRIS Package(R01AN4584).

The following open source software is bundled with this sample program.

**Table 3.1 List of open source software packaged**

Name	Description
FreeRTOS	It is open source software distributed under the MIT license. Regarding the MIT license, Please refer to <a href="https://opensource.org/licenses/mit-license.php">https://opensource.org/licenses/mit-license.php</a> . FreeRTOS is a real-time operation system kernel for embedded microcomputers. In this sample program, Kernel v10.0.0 is used. For the location of the FreeRTOS source code, refer to the folder structure.

### 4. Sample Program

This section describes the iris processing, the specification of input and output, and the memory footprint.

Iris processing consists of three functions: "Simple ISP", "Circle Detection", and "Cropping Image".

Please refer to Section 4.2 Simple ISP ~ 4.4 Cropping Image for details of each function.

1. Simple ISP: Controls camera exposure and suppresses noise for improved image quality and enhanced accuracy of iris detection.
2. Circle Detection: Detects circles in the image processed by the Simple ISP.
3. Cropping Image: Crops and outputs an image from the Circle Detection result which conforms to the requirements of ISO/IEC 19794-6:2011.

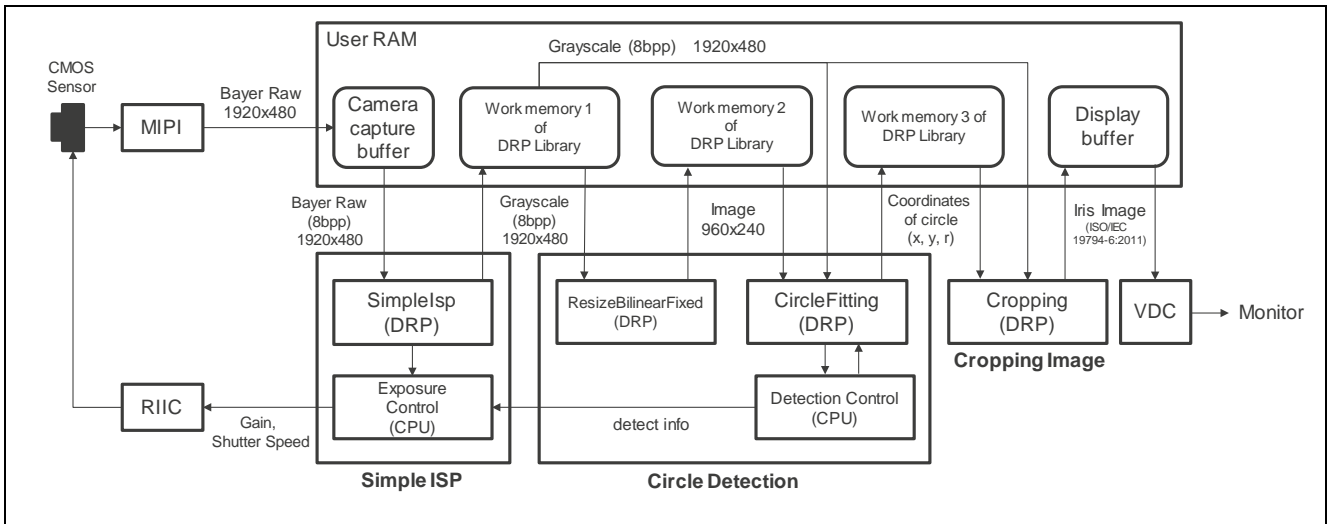

Figure 4.1 System block of iris detection sample program

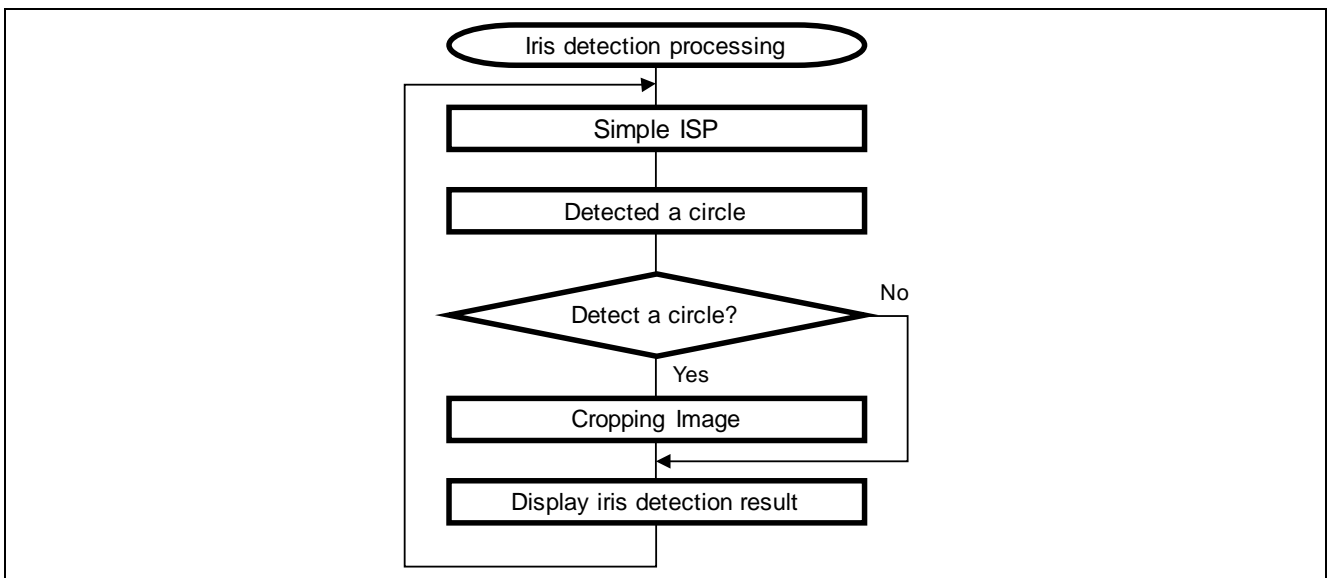

Figure 4.2 Flow chart of iris detection processing

## 4.1 Specification of Input / Output

### 4.1.1 Specification of Input

The input specification is shown in Table 4.1 Camera settings.

The Auto Exposure (AE) can be turned on/off by pushing SW3 on the Sub board.

**Table 4.1 Camera settings**

Input image format	Bayer format 8[bit per pixel]
Image capture size	1920 × 480
Capture frame rate	Capture frame rate will fluctuate, by ON/OFF of 4.2.1Auto Exposure Correction (AE). ON : 12~24fps <sup>*1</sup> OFF : 20fps <sup>*2</sup>

Note 1. The set value is 24 fps. However, it fluctuates between 12 and 24 fps due to changes in shutter speed.

2. The set value is 24 fps. However, because the shutter speed is 1/20 second, it is 20 fps.

### 4.1.2 Specification of Output

This sample program outputs an iris image which conforms to the requirements of ISO/IEC 19794-6:2011. This image is then output to a monitor.

The output format for the monitor is shown Table 4.2.

**Table 4.2 Monitor output specification**

Image resolution	1366 × 768
Image display frame rate	60 fps

An example of monitor output is shown Figure 4.3.

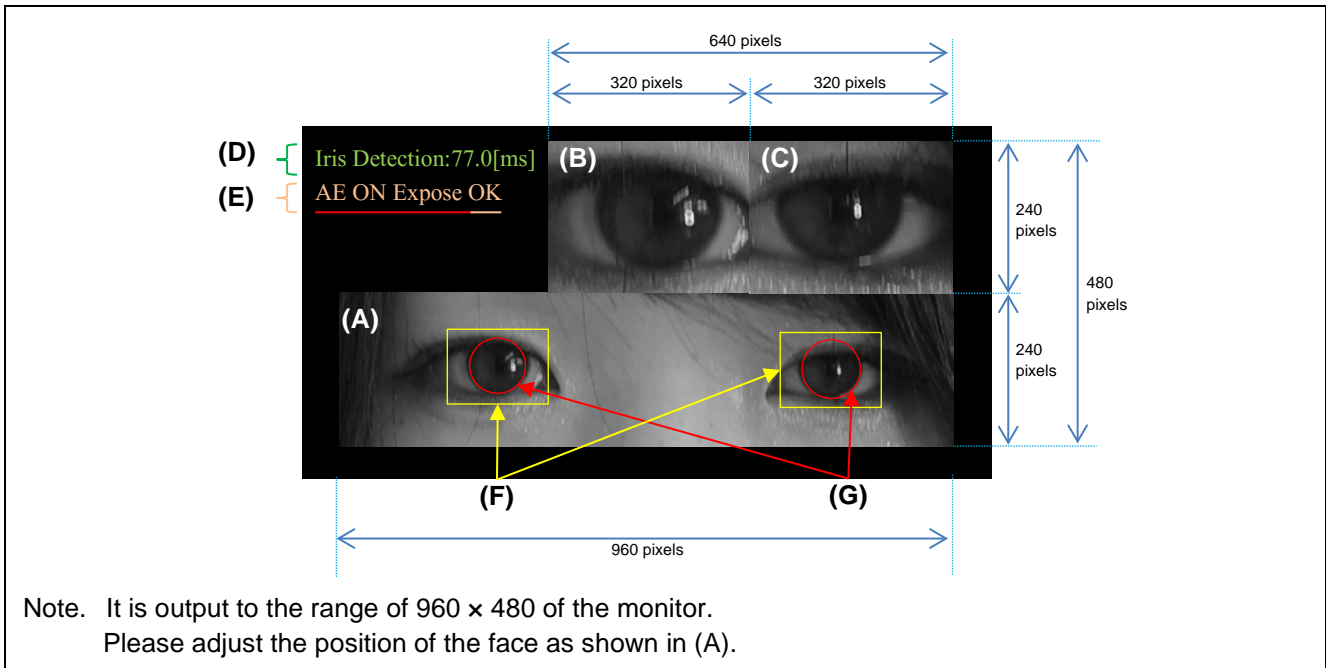

**Figure 4.3 Display of iris detection result**

- (A) Displays a resized image of the face captured by the camera.
- (B) Displays the left eye, cropped to meet the ISO/IEC 19794-6:2011 format requirements, when the iris of both eyes is detected.
- (C) Displays the right eye, cropped to meet the ISO/IEC 19794-6:2011 format requirements, when the iris of both eyes is detected.
- (D) Display the time taken for the whole iris detection process (from AE to cropping the image).
- (E) Display on/off status of AE and the brightness.
- (F) Displays a square frame of the cropped image according to ISO/IEC 19794-6:2011.
- (G) Displays a circular frame around the detected iris.



## 4.2 Simple ISP

Simple ISP controls camera exposure and suppresses noise for improved image quality and enhanced iris detection accuracy.

The image data is converted to grayscale and output, because color information is not necessary for iris detection.

This function uses Simpleisp of DRP Library. Please refer to "DRP Library user's manual (R01US0367)" for details of the Simpleisp.

The explanation for this section is continued in the sample program source code "r\_bcd\_main.c", onwards from the comment "/\* Function : Simple ISP(AE, Bayer to grayscale conversion, Noise reduction) \*/".

### 4.2.1 Auto Exposure Correction (AE)

Auto Exposure correction (AE) controls the exposure of the camera referring to the brightness output from Simpleisp.

The CPU handles calculations of the correction value and camera control. A flowchart describing the camera control process is shown in Figure 4.5, Figure 4.6 and Figure 4.7.

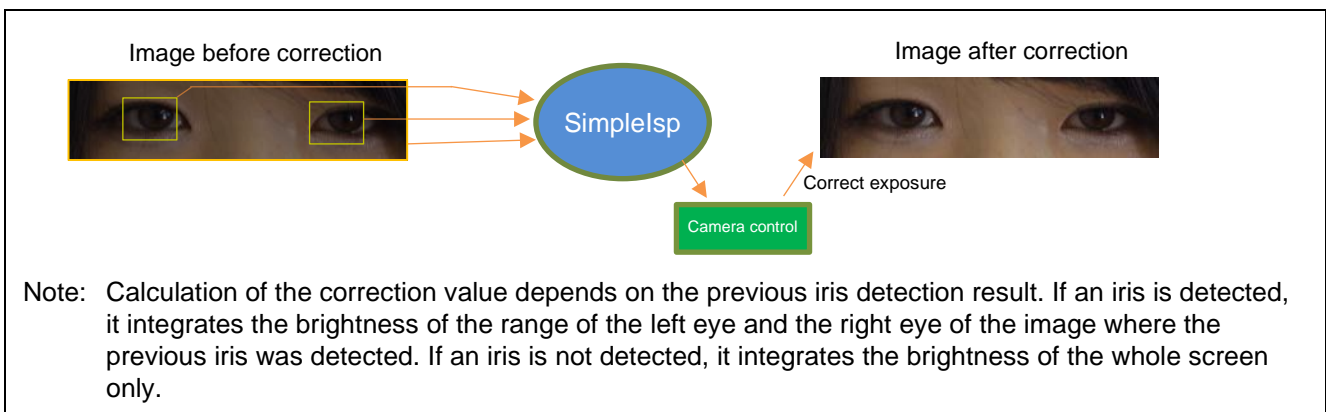

Figure 4.4 Lightness integrating process

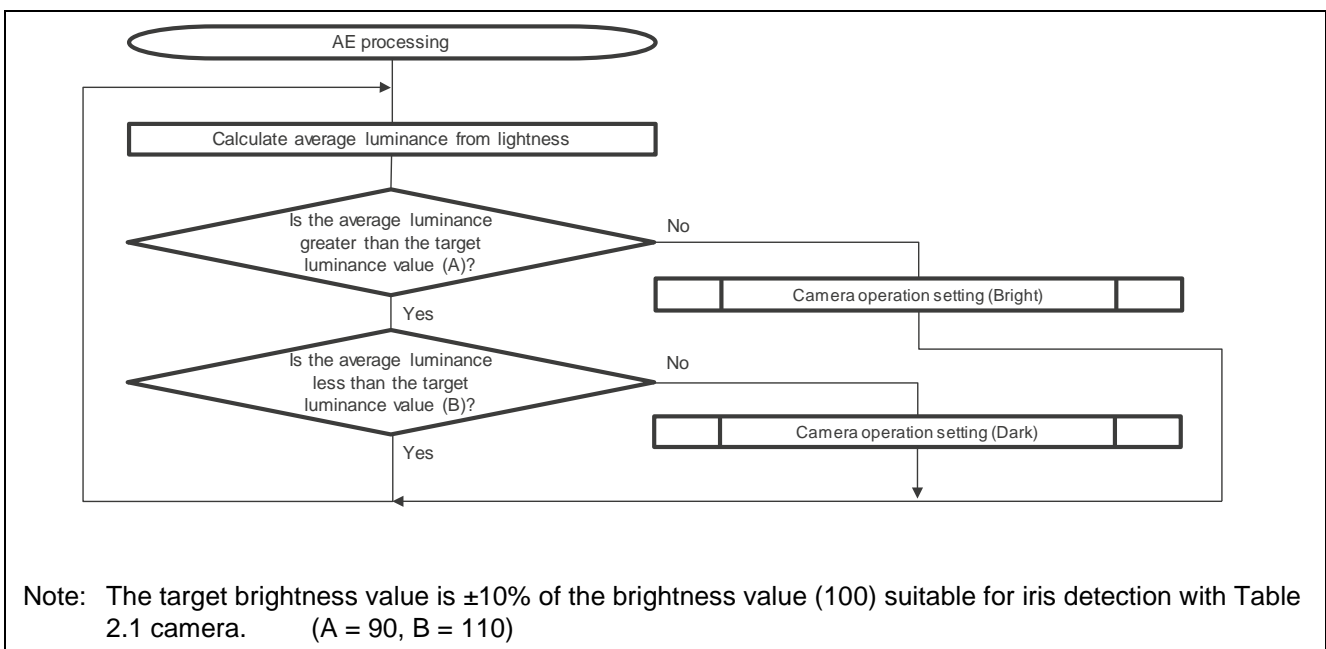

Figure 4.5 AE processing flow

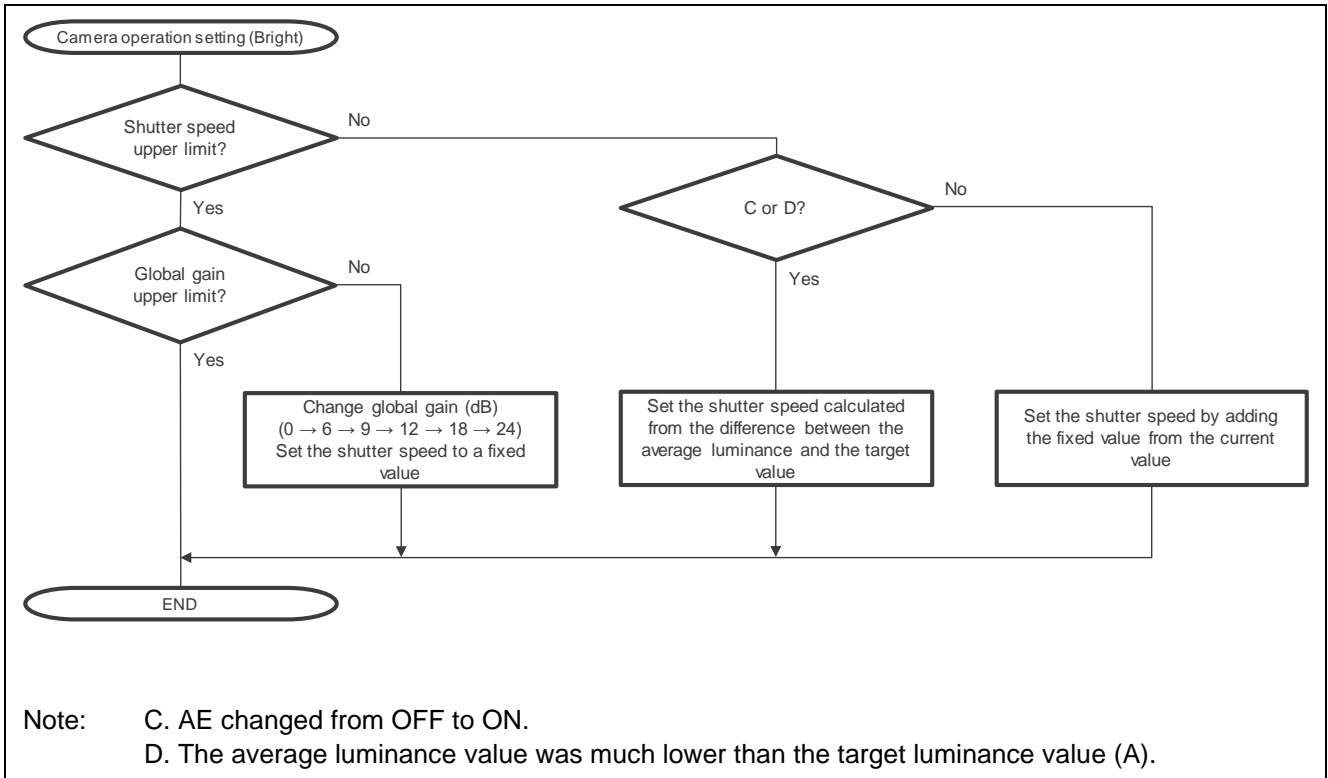

Figure 4.6 Camera operation setting (Bright) flowchart

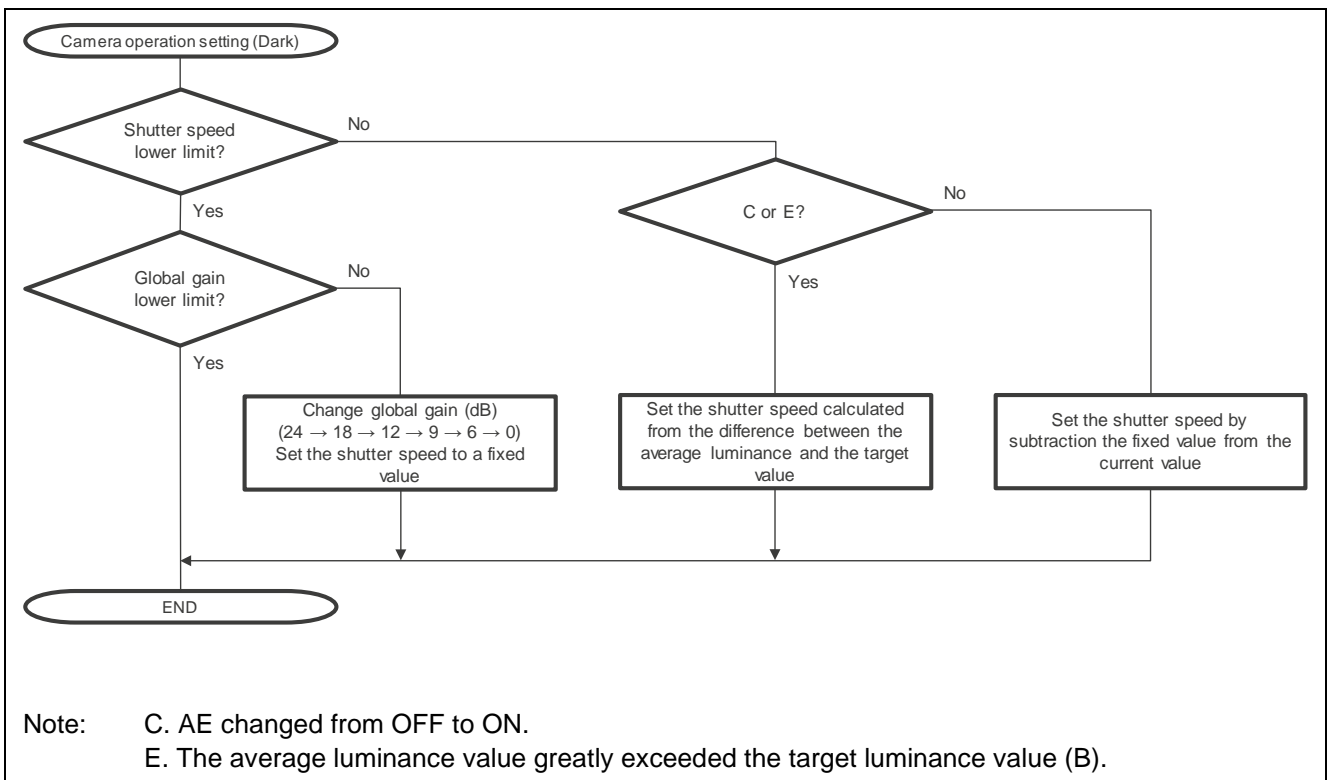

Figure 4.7 Camera operation setting (Dark) flowchart

### 4.2.2 Convert Format to Grayscale

Convert from Bayer Raw input to Grayscale using the SimpleIsp.

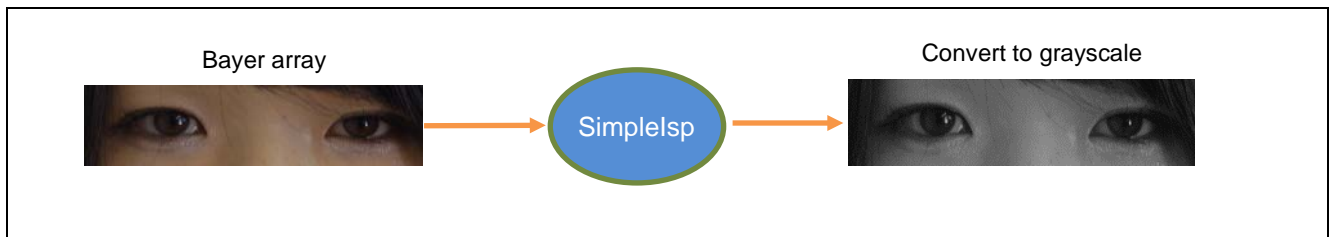
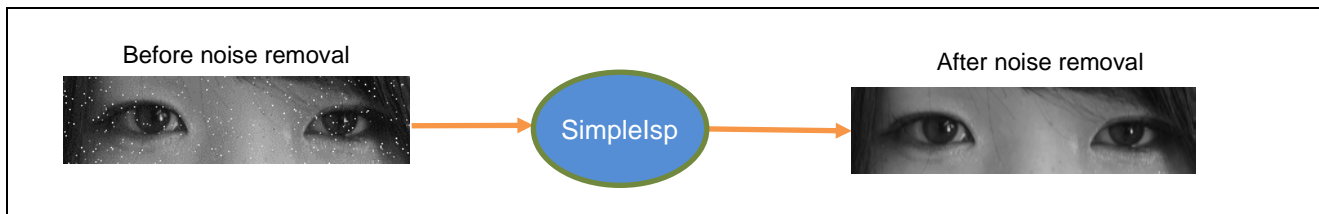

Figure 4.8 Conversion processing from Bayer array to grayscale

### 4.2.3 Suppress Noise

Suppress noise from converted grayscale image using Median filter.



**Figure 4.9 Noise Removal Processing**

### 4.3 Circle Detection

For shortening detection time, the Circle Detection function consists of a Rough Detection step that detects the iris position roughly and a Fine Detection step that detects the iris accurately.

#### 4.3.1 Rough Detection

The Rough Detection function detects a circle from a resized small size image. The resized small size image is only used for Rough Detection function.

This function uses the `ResizeBilinearFixed` function from the DRP Library. Please refer to "DRP Library user's manual (R01US0367)" for details of the `ResizeBilinearFixed` function.

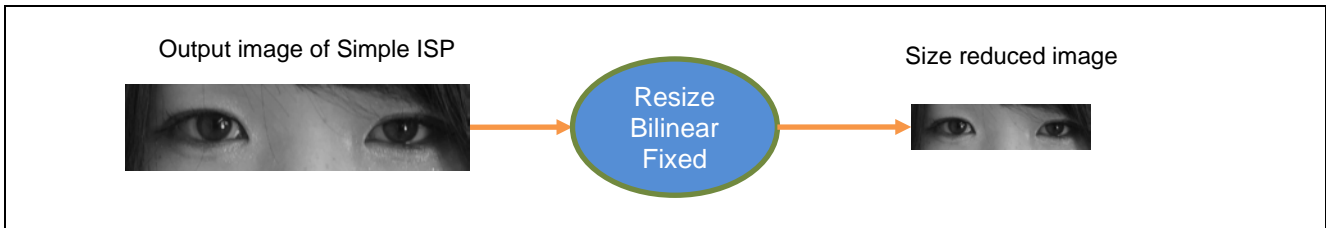
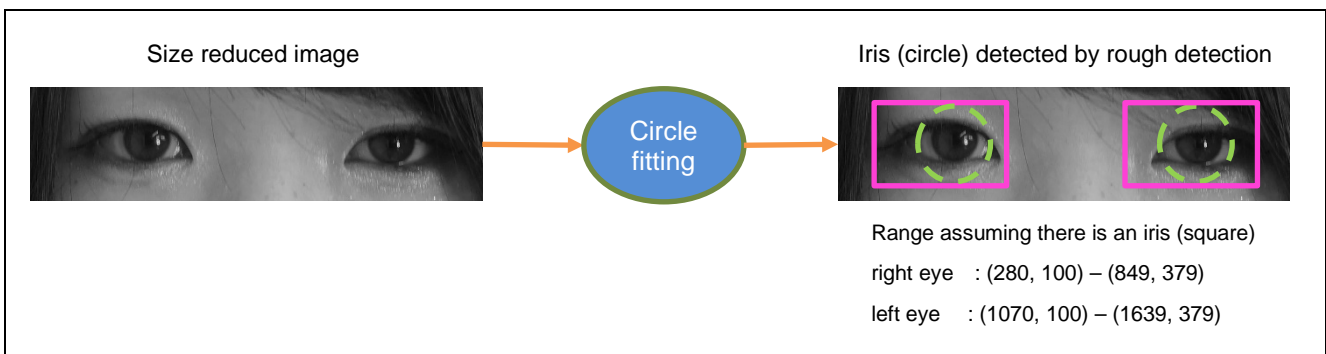

**Figure 4.10 Processing to reduce image size**

Detects an iris from the narrowed down pink square area that is assumed to include an eye in the resized image. The square area is fixed.

This function uses the `CircleFitting` function in the DRP Library. Please refer to "DRP Library user's manual (R01US0367)" for details of the `CircleFitting` function.

Further explanation on this section is described onwards from the comment `/* Function : Rough circle detection */` in the sample program source code `"r_bcd_main.c"`.



**Figure 4.11 Rough detection processing**

### 4.3.2 Fine Detection

Searches the circle accurately from the image detected by the Rough Detection function using CircleFitting and get accurate iris position.

This function uses CircleFitting of DRP Library. Please refer "DRP Library user's manual (R01US0367)" for detail of CircleFitting.

A process of explanation on this section is described in comment "/\* Function : Fine circle detection \*/" of sample program source code "r\_bcd\_main.c".

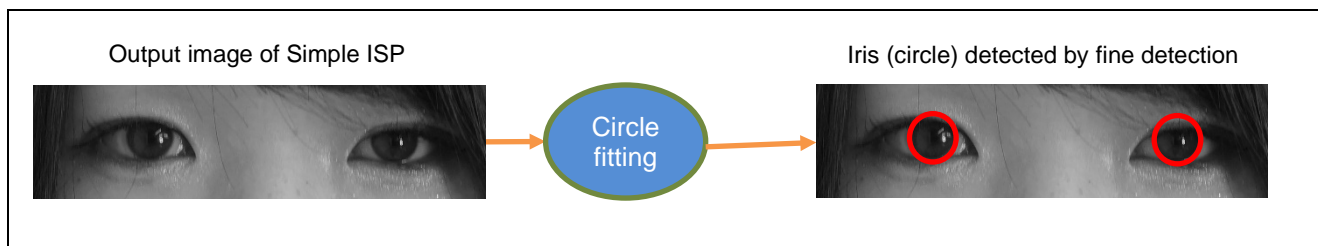

Figure 4.12 Fine Detection processing

#### 4.4 Cropping Image

Crop from image detected by 4.3.2 Fine Detection, and output data that is conformed to the requirement of ISO/IEC 19794-6:2011.

A process of explanation on this section is described in comment " /\* Function : Cropping \*/" of sample program source code "r\_bcd\_main.c".

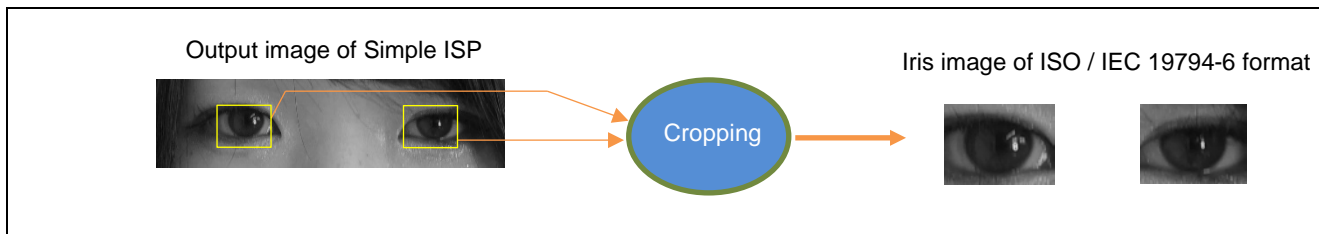

Figure 4.13 Cropping Image

#### 4.5 Memory footprint

For the memory footprint, refer to the release note for the RZ/A2M Group IRIS Package(R01AN4584).



## 5. DRP Library

This sample program detects the iris using the DRP Library shown in Table 5.1. Refer to the DRP Library user's manual (R01US0367) for the DRP Library specifications.

**Table 5.1 List of functions of the DRP Library to be used**

Function name	Use
SimpleIsp	Calculation of correction value used for AE, conversion to gray scale, noise removal. Used in 4.2 Simple ISP.
ResizeBilinearFixed	Reducing the image. Used in 4.3.1 Rough Detection.
CircleFitting	Detection of iris. Used in 4.3.1 Rough Detection and 4.3.2 Fine Detection.
Cropping	Cropping Image. Used in 4.4 Cropping Image.

## 6. Reference Documents

### User's Manual: Software

RZ/A2M Group DRP Driver User's Manual (R01US0355)

The latest version can be downloaded from the Renesas Electronics website.

RZ/A2M Group DRP Library User's Manual (R01US0367)

The latest version can be downloaded from the Renesas Electronics website.

### User's Manual: Hardware

RZ/A2M Group User's Manual: Hardware

The latest version can be downloaded from the Renesas Electronics website.

RTK7921053C00000BE (RZ/A2M CPU board) User's Manual

The latest version can be downloaded from the Renesas Electronics website.

RTK79210XXB00000BE (RZ/A2M SUB board) User's Manual

The latest version can be downloaded from the Renesas Electronics website.

ARM Architecture Reference Manual ARMv7-A and ARMv7-R edition Issue C

The latest version can be downloaded from the ARM website.

Arm Cortex™-A9 Technical Reference Manual Revision: r4p1

The latest version can be downloaded from the ARM website.

Arm Generic Interrupt Controller Architecture Specification - Architecture version2.0

The latest version can be downloaded from the ARM website.

Arm CoreLink™ Level 2 Cache Controller L2C-310 Technical Reference Manual Revision: r3p3

The latest version can be downloaded from the ARM website.

### Technical Update/Technical News

The latest information can be downloaded from the Renesas Electronics website.

### User's Manual: Development Tools

Integrated development environment e2studio User's Manual can be downloaded from the Renesas Electronics website.

The latest version can be downloaded from the Renesas Electronics website.

**Revision History**

Rev.	Date	Description	
		Page	Summary
1.00	Sep 28,2018	-	First edition issued
1.01	Apr 15,2019	4	Table 2.2: Integrated development environment version updated. Board name modified. Compiler options added.
		5	Figure 3.1 Folder Structure, updated.
1.10	May 17,2019	4	Table 2.2 Remove compiler option "-mthumb-interwork"
		5	Figure 3.1 Folder Structure, updated.
1.11	Sep 30, 2019	4	Table 2.2: Integrated development environment updated.
1.12	Dec 17, 2019	5	Figure 3.1 Folder Structure, deleted.
		16	4.5 Memory footprint, deleted.

# General Precautions in the Handling of Microprocessing Unit and Microcontroller Unit Products

The following usage notes are applicable to all Microprocessing unit and Microcontroller unit products from Renesas. For detailed usage notes on the products covered by this document, refer to the relevant sections of the document as well as any technical updates that have been issued for the products.

## 1. Precaution against Electrostatic Discharge (ESD)

A strong electrical field, when exposed to a CMOS device, can cause destruction of the gate oxide and ultimately degrade the device operation. Steps must be taken to stop the generation of static electricity as much as possible, and quickly dissipate it when it occurs. Environmental control must be adequate. When it is dry, a humidifier should be used. This is recommended to avoid using insulators that can easily build up static electricity.

Semiconductor devices must be stored and transported in an anti-static container, static shielding bag or conductive material. All test and measurement tools including work benches and floors must be grounded. The operator must also be grounded using a wrist strap. Semiconductor devices must not be touched with bare hands. Similar precautions must be taken for printed circuit boards with mounted semiconductor devices.

## 2. Processing at power-on

The state of the product is undefined at the time when power is supplied. The states of internal circuits in the LSI are indeterminate and the states of register settings and pins are undefined at the time when power is supplied. In a finished product where the reset signal is applied to the external reset pin, the states of pins are not guaranteed from the time when power is supplied until the reset process is completed. In a similar way, the states of pins in a product that is reset by an on-chip power-on reset function are not guaranteed from the time when power is supplied until the power reaches the level at which resetting is specified.

## 3. Input of signal during power-off state

Do not input signals or an I/O pull-up power supply while the device is powered off. The current injection that results from input of such a signal or I/O pull-up power supply may cause malfunction and the abnormal current that passes in the device at this time may cause degradation of internal elements. Follow the guideline for input signal during power-off state as described in your product documentation.

## 4. Handling of unused pins

Handle unused pins in accordance with the directions given under handling of unused pins in the manual. The input pins of CMOS products are generally in the high-impedance state. In operation with an unused pin in the open-circuit state, extra electromagnetic noise is induced in the vicinity of the LSI, an associated shoot-through current flows internally, and malfunctions occur due to the false recognition of the pin state as an input signal become possible.

## 5. Clock signals

After applying a reset, only release the reset line after the operating clock signal becomes stable. When switching the clock signal during program execution, wait until the target clock signal is stabilized. When the clock signal is generated with an external resonator or from an external oscillator during a reset, ensure that the reset line is only released after full stabilization of the clock signal. Additionally, when switching to a clock signal produced with an external resonator or by an external oscillator while program execution is in progress, wait until the target clock signal is stable.

## 6. Voltage application waveform at input pin

Waveform distortion due to input noise or a reflected wave may cause malfunction. If the input of the CMOS device stays in the area between  $V_{IL}$  (Max.) and  $V_{IH}$  (Min.) due to noise, for example, the device may malfunction. Take care to prevent chattering noise from entering the device when the input level is fixed, and also in the transition period when the input level passes through the area between  $V_{IL}$  (Max.) and  $V_{IH}$  (Min.).

## 7. Prohibition of access to reserved addresses

Access to reserved addresses is prohibited. The reserved addresses are provided for possible future expansion of functions. Do not access these addresses as the correct operation of the LSI is not guaranteed.

## 8. Differences between products

Before changing from one product to another, for example to a product with a different part number, confirm that the change will not lead to problems. The characteristics of a microprocessing unit or microcontroller unit products in the same group but having a different part number might differ in terms of internal memory capacity, layout pattern, and other factors, which can affect the ranges of electrical characteristics, such as characteristic values, operating margins, immunity to noise, and amount of radiated noise. When changing to a product with a different part number, implement a system-evaluation test for the given product.

## Notice

1. Descriptions of circuits, software and other related information in this document are provided only to illustrate the operation of semiconductor products and application examples. You are fully responsible for the incorporation or any other use of the circuits, software, and information in the design of your product or system. Renesas Electronics disclaims any and all liability for any losses and damages incurred by you or third parties arising from the use of these circuits, software, or information.
2. Renesas Electronics hereby expressly disclaims any warranties against and liability for infringement or any other claims involving patents, copyrights, or other intellectual property rights of third parties, by or arising from the use of Renesas Electronics products or technical information described in this document, including but not limited to, the product data, drawings, charts, programs, algorithms, and application examples.
3. No license, express, implied or otherwise, is granted hereby under any patents, copyrights or other intellectual property rights of Renesas Electronics or others.
4. You shall not alter, modify, copy, or reverse engineer any Renesas Electronics product, whether in whole or in part. Renesas Electronics disclaims any and all liability for any losses or damages incurred by you or third parties arising from such alteration, modification, copying or reverse engineering.
5. Renesas Electronics products are classified according to the following two quality grades: "Standard" and "High Quality". The intended applications for each Renesas Electronics product depends on the product's quality grade, as indicated below.
  - "Standard": Computers; office equipment; communications equipment; test and measurement equipment; audio and visual equipment; home electronic appliances; machine tools; personal electronic equipment; industrial robots; etc.
  - "High Quality": Transportation equipment (automobiles, trains, ships, etc.); traffic control (traffic lights); large-scale communication equipment; key financial terminal systems; safety control equipment; etc.Unless expressly designated as a high reliability product or a product for harsh environments in a Renesas Electronics data sheet or other Renesas Electronics document, Renesas Electronics products are not intended or authorized for use in products or systems that may pose a direct threat to human life or bodily injury (artificial life support devices or systems; surgical implantations; etc.), or may cause serious property damage (space system; undersea repeaters; nuclear power control systems; aircraft control systems; key plant systems; military equipment; etc.). Renesas Electronics disclaims any and all liability for any damages or losses incurred by you or any third parties arising from the use of any Renesas Electronics product that is inconsistent with any Renesas Electronics data sheet, user's manual or other Renesas Electronics document.
6. When using Renesas Electronics products, refer to the latest product information (data sheets, user's manuals, application notes, "General Notes for Handling and Using Semiconductor Devices" in the reliability handbook, etc.), and ensure that usage conditions are within the ranges specified by Renesas Electronics with respect to maximum ratings, operating power supply voltage range, heat dissipation characteristics, installation, etc. Renesas Electronics disclaims any and all liability for any malfunctions, failure or accident arising out of the use of Renesas Electronics products outside of such specified ranges.
7. Although Renesas Electronics endeavors to improve the quality and reliability of Renesas Electronics products, semiconductor products have specific characteristics, such as the occurrence of failure at a certain rate and malfunctions under certain use conditions. Unless designated as a high reliability product or a product for harsh environments in a Renesas Electronics data sheet or other Renesas Electronics document, Renesas Electronics products are not subject to radiation resistance design. You are responsible for implementing safety measures to guard against the possibility of bodily injury, injury or damage caused by fire, and/or danger to the public in the event of a failure or malfunction of Renesas Electronics products, such as safety design for hardware and software, including but not limited to redundancy, fire control and malfunction prevention, appropriate treatment for aging degradation or any other appropriate measures. Because the evaluation of microcomputer software alone is very difficult and impractical, you are responsible for evaluating the safety of the final products or systems manufactured by you.
8. Please contact a Renesas Electronics sales office for details as to environmental matters such as the environmental compatibility of each Renesas Electronics product. You are responsible for carefully and sufficiently investigating applicable laws and regulations that regulate the inclusion or use of controlled substances, including without limitation, the EU RoHS Directive, and using Renesas Electronics products in compliance with all these applicable laws and regulations. Renesas Electronics disclaims any and all liability for damages or losses occurring as a result of your noncompliance with applicable laws and regulations.
9. Renesas Electronics products and technologies shall not be used for or incorporated into any products or systems whose manufacture, use, or sale is prohibited under any applicable domestic or foreign laws or regulations. You shall comply with any applicable export control laws and regulations promulgated and administered by the governments of any countries asserting jurisdiction over the parties or transactions.
10. It is the responsibility of the buyer or distributor of Renesas Electronics products, or any other party who distributes, disposes of, or otherwise sells or transfers the product to a third party, to notify such third party in advance of the contents and conditions set forth in this document.
11. This document shall not be reprinted, reproduced or duplicated in any form, in whole or in part, without prior written consent of Renesas Electronics.
12. Please contact a Renesas Electronics sales office if you have any questions regarding the information contained in this document or Renesas Electronics products.

(Note1) "Renesas Electronics" as used in this document means Renesas Electronics Corporation and also includes its directly or indirectly controlled subsidiaries.

(Note2) "Renesas Electronics product(s)" means any product developed or manufactured by or for Renesas Electronics.

(Rev.4.0-1 November 2017)

## Corporate Headquarters

TOYOSU FORESIA, 3-2-24 Toyosu,  
Koto-ku, Tokyo 135-0061, Japan  
[www.renesas.com](http://www.renesas.com)

## Trademarks

Renesas and the Renesas logo are trademarks of Renesas Electronics Corporation. All trademarks and registered trademarks are the property of their respective owners.

## Contact information

For further information on a product, technology, the most up-to-date version of a document, or your nearest sales office, please visit:  
[www.renesas.com/contact/](http://www.renesas.com/contact/)