

---

## M16C/64A Group

High-performance Embedded Workshop Start-up Program in C

R01AN0044EJ0100

Rev.1.00

Nov. 30, 2010

---

### 1. Abstract

This document describes the source files created when a new workspace is created by the High-performance Embedded Workshop (HEW).

### 2. Introduction

The application example described in this document applies to the following microcomputer (MCU) and parameters:

- MCU: M16C/64A Group
- HEW version: Version 4.07
- C Compiler Package for M16C Series and R8C Family [M3T-NC30WA]: V. 5.45 Release 01

This application note can be used with other M16C Family MCUs which have the same special function registers (SFRs) as the above group. Check the user's manual for any modifications to functions. Careful evaluation is recommended before using the program described in this application note.

### 3. Outline

This application note describes source files created when “C source startup Application” is selected and a new workspace is created by HEW.

#### 3.1 Source Files Created by HEW

Table 3.1 lists the C Source Files Created by HEW, and Table 3.2 lists the Header Files Created by HEW.

**Table 3.1 C Source Files Created by HEW**

Source File Name	Outline	Content
project_name.c <sup>(1)</sup>	Main file	Source file for main function
firm.c	Definition file for firmware	Maintains program and workspace areas for FoUSB/E8 firmware when the OnChipDebugger is selected.
firm_ram.c	RAM definition file for firmware	
fvector.c	Definition file for fixed vector table	Defines fixed vector tables. Sets OFS1 address and ID code. Modify fixed vector tables when performing non-maskable interrupt handling.
heap.c	Definition file for heap area	Defines the heap area used. The heap size value set ( <code>__HEAPSIZE__</code> ) when a project is created is defined in <code>cstartdef.h</code> . Modify the value of <code>__HEAPSIZE__</code> when changing the heap size.
initsct.c	Initialize RAM file	Describes the RAM initial setting. When the user wants to initialize added areas, add the areas to be initialized.
intprg.c	Definition file for variable vector table	Defines relocatable vector tables and interrupt functions (empty functions). When maskable interrupts are used, add processes in interrupt functions.
resetprg.c	C source start-up program file	Executes the initialization processes before the main function is executed. When using the user boot function, set the user boot area in this file.

Note:

1. Insert user project name for `project_name`.

**Table 3.2 Header Files Created by HEW**

Header File Name	Outline	Content
cstartdef.h	Definition header file for stack size	Defines stack size and heap size. Select either enable/disable for the watchdog timer auto start after reset.
initsct.h	Macro definition header file to initialize sections	Defines the macro used in <code>initsct.c</code> .
resetprg.h	Header file for Initialization settings	Initializes the stack size, CPU register setting, and heap area.
sfrXX.h <sup>(1)</sup>	SFR register header file	Defines the SFR registers used for the MCU.
typedefine.h	Definition header file for data style	Defines data styles.

Note:

1. XX indicates the MCU group.

## 4. Settings of Source Files Created by HEW

### 4.1 Fixed Vector Table Setting

Fixed vector tables are defined in the `fvector.c` file. The program is executed from the address set in the reset vector of the fixed vector table after reset start. The address of the start function is set in the reset vector of the file created. Other non-maskable interrupts can be set in the same file.

Figure 4.1 shows the Fixed Vector Table Setting.

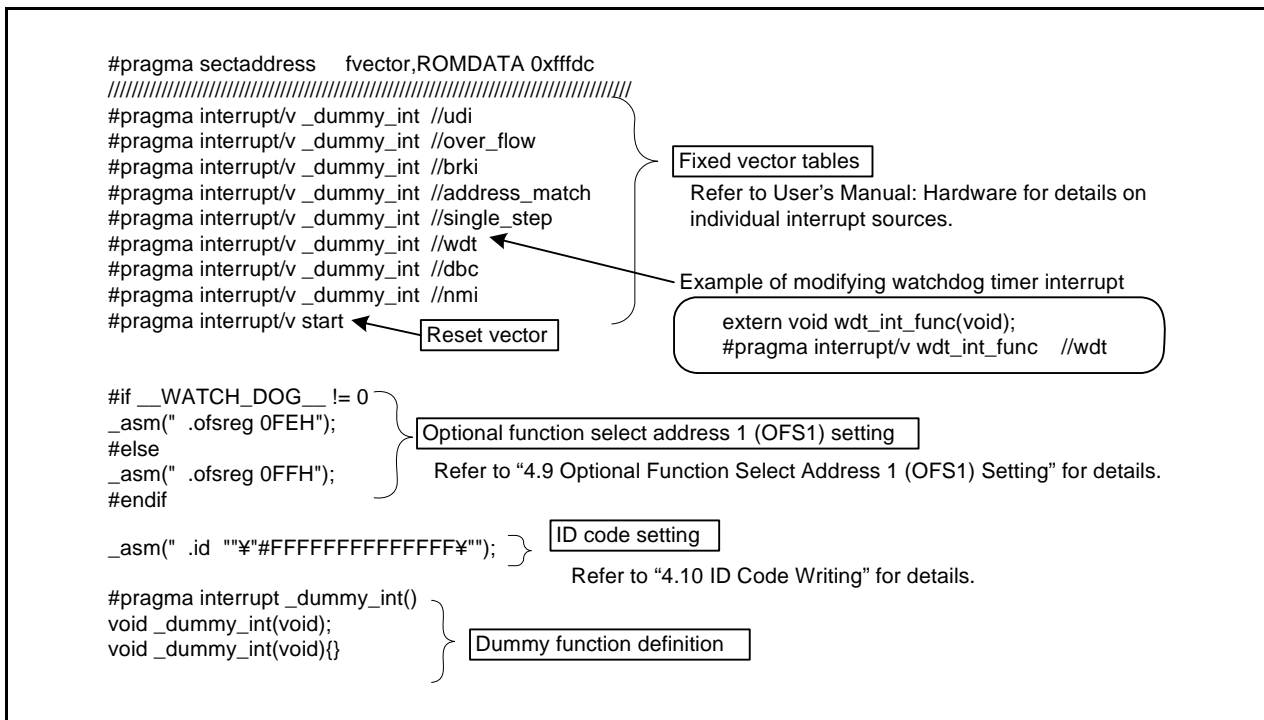

Figure 4.1 Fixed Vector Table Setting

## 4.2 cstartdef.h

When changing the project generator wizard setting values, modify them in the cstartdef.h file.

Figure 4.2 shows the cstartdef.h.

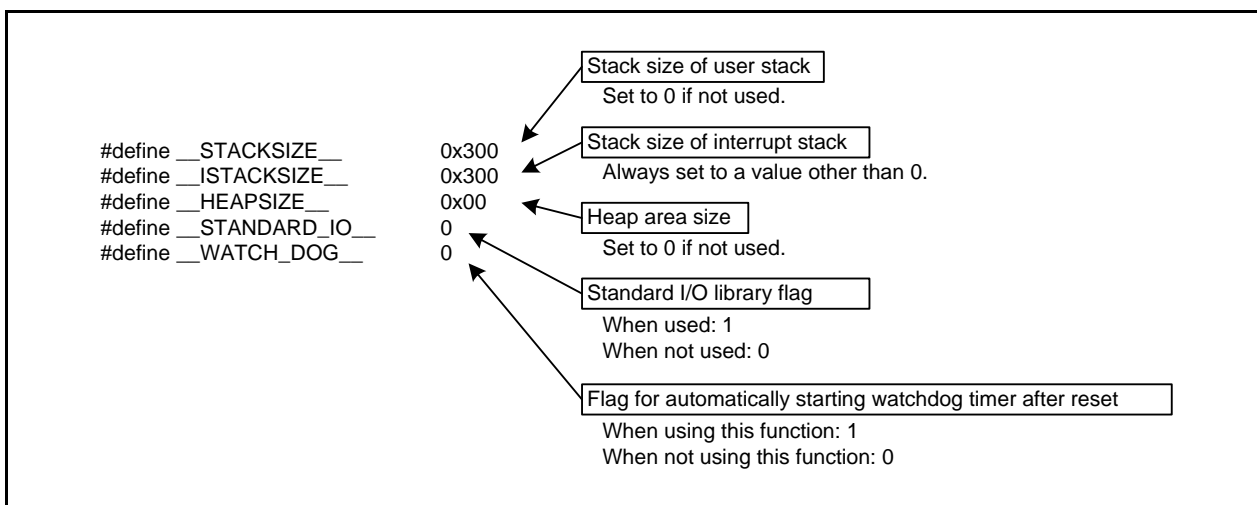

Figure 4.2 cstartdef.h

### 4.3 start Function Setting

The start function is created in the resetprg.c file.

Figure 4.3 shows the start Function Setting.

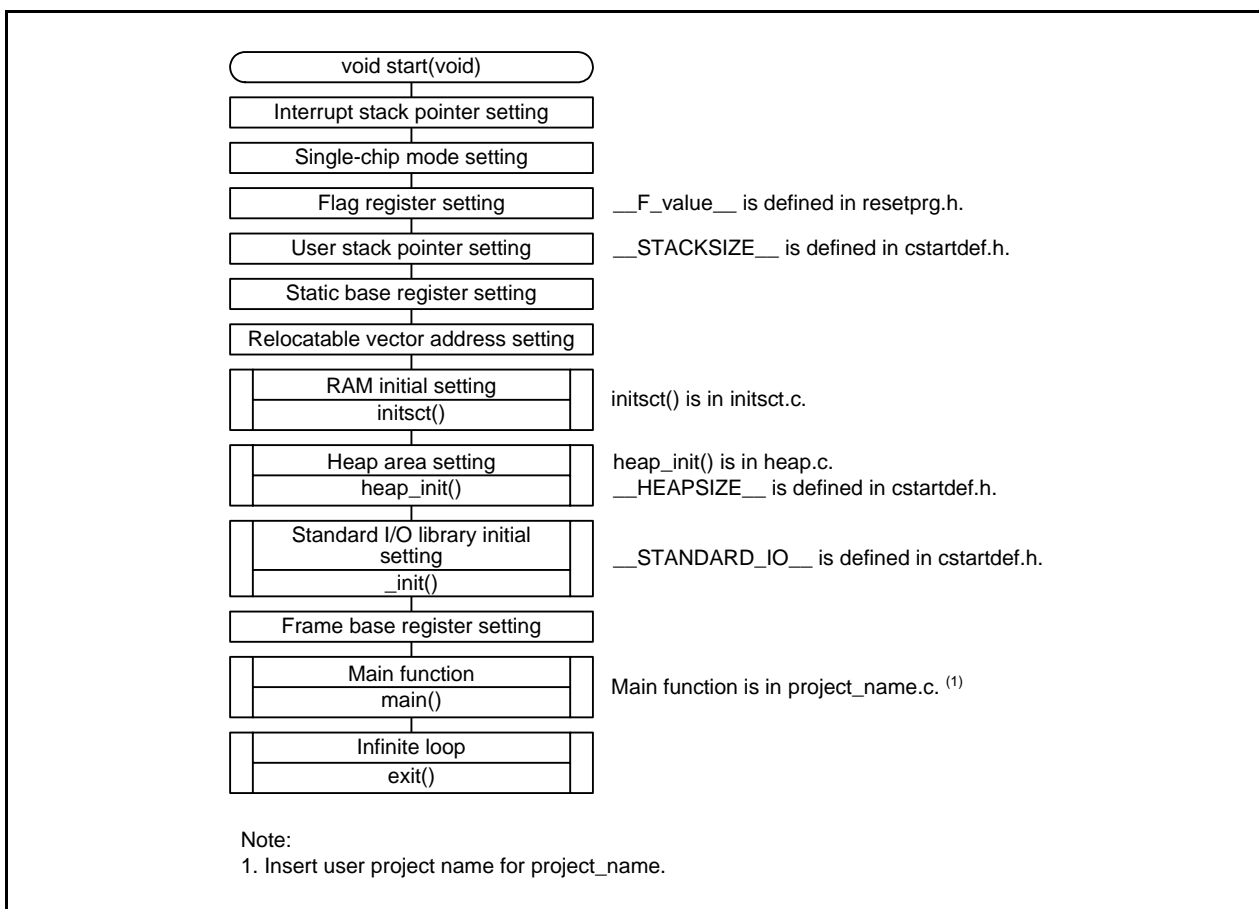

Figure 4.3 start Function Setting

## 4.4 RAM Initial Setting

The RAM initial setting process is created in the `initsct.c` file. The `initsct.c` file sets zero-clear to RAM. The initial values in ROM are transferred to RAM.

Figure 4.4 shows an Example of Initializing Added Area Using `initsct.c`.

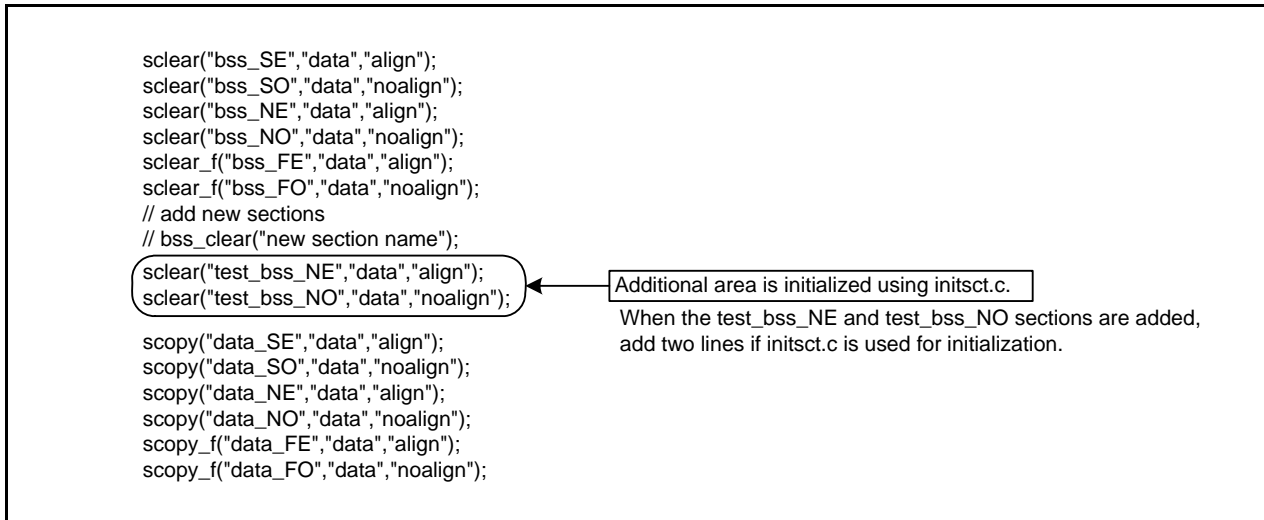

Figure 4.4 Example of Initializing Added Area Using `initsct.c`

## 4.5 Heap Area Setting

Processing to allocate the heap area is created in the `heap.c` file.

Figure 4.5 shows the Heap Area Setting.

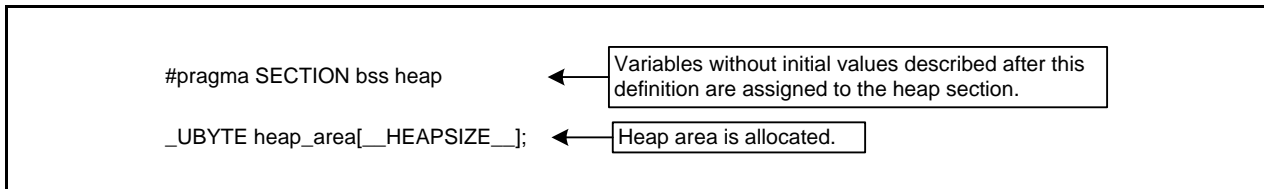

Figure 4.5 Heap Area Setting

## 4.6 Main Function Setting

The main function is created in `project_name.c` file. Add programming in this file.

## 4.7 Interrupt Function Setting

Relocatable vector tables are created in the `intrpg.c` file. Add interrupt handling to the `intrpg.c` file if needed.

## 4.8 User Boot Function Setting

The user boot function setting is created in the resetprg.c file. Addresses 13FF0h to 13FFFh are the user boot area. If “UserBoot” in ASCII code is set to these addresses, the user boot function is enabled. Refer to User’s Manual: Hardware when using the user boot function.

Figure 4.6 shows the User Boot Function Setting.

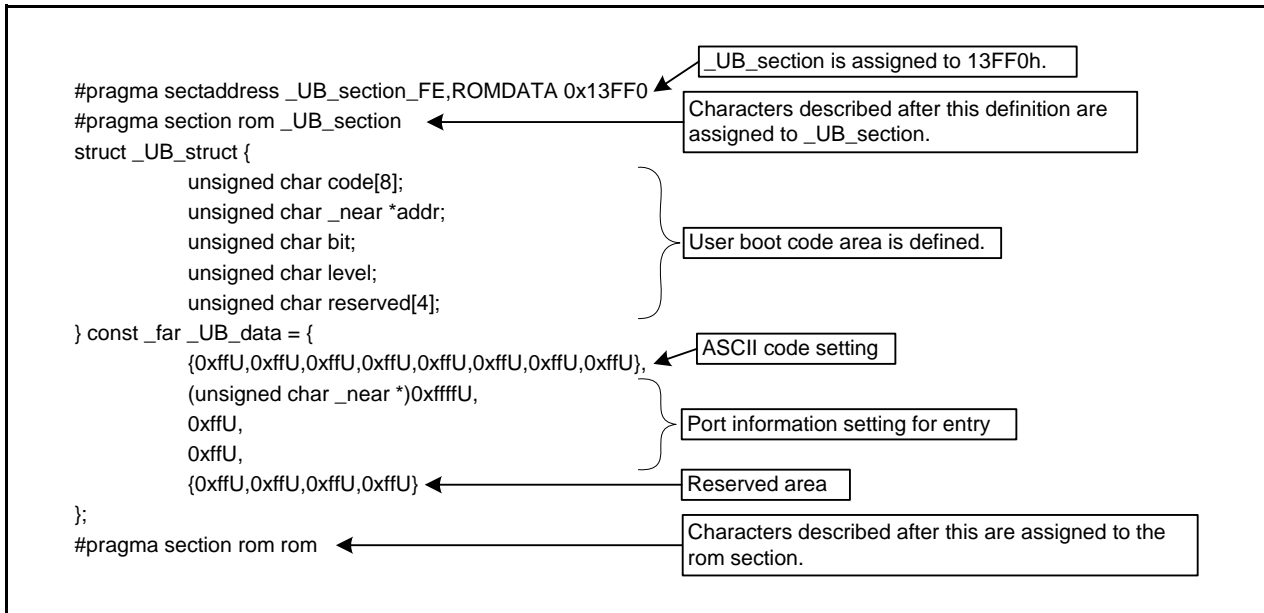

Figure 4.6 User Boot Function Setting

### 4.8.1 When Not Using the User Boot Function

When the user boot function is not used, delete or comment out the coding area written in Figure 4.6. Addresses 13FF0h to 13FFFh are used for the user boot area. Do not assign programs to these addresses.

### 4.9 Optional Function Select Address 1 (OFS1) Setting

Optional function select address 1 (OFS1) setting is created in the fvector.c file.

Figure 4.7 shows the Optional Function Select Address 1 (OFS1) Setting.

The default value is FFh. When changing the OFS1 address, modify the value below.

```
    _asm(" .ofsreg 0FFH"); ← Set FFh to the OFS1 address.
```

Figure 4.7 Optional Function Select Address 1 (OFS1) Setting

### 4.10 ID Code Writing

ID code writing process is created in the fvector.c file.

Figure 4.8 shows the ID Code Writing Process.

The default value is FFFFFFFFh. When changing the ID code setting, modify the value below.

```
    _asm(" .id ""#FFFFFFFFFFFF"); ← Set the ID code.
```

Figure 4.8 ID Code Writing Process



## 5. Other Settings

### 5.1 Watchdog Timer Setting

The watchdog timer setting is created in the `cstartdef.h` file. Set `__WATCH_DOG__` to select watchdog timer status after reset.

When using the watchdog timer in the source files created by HEW, note the following restrictions.

- The CPU clock must be set to 125 kHz on-chip oscillator divided-by-8 or higher.
- Do not use the watchdog timer count source protection mode.

When restrictions above will be problems, modify the program that the refresh process of watchdog timer in the `initsct.h` file start before watchdog timer reset occurs.

Figure 5.1 shows the Flag for Automatically Starting Watchdog Timer After Reset.

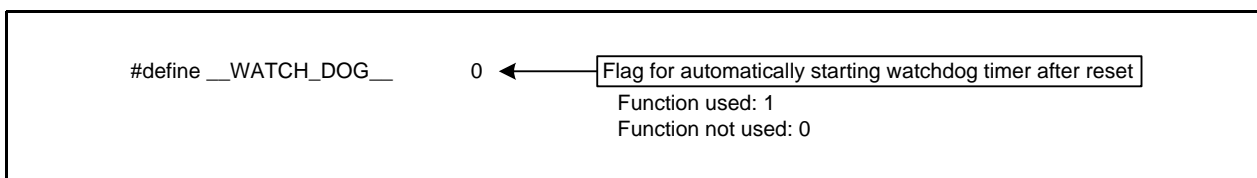

**Figure 5.1** Flag for Automatically Starting Watchdog Timer After Reset

## 5.2 Section Setting

This section shows the section setting method by HEW. Usually, the section location is set in order of “Build” → “Renesas M16C Standard Toolchain...” → “Link” → “Category” in HEW, but this application note shows an example using the map window.

“C source startup Application” must be selected for the project type to use map window when a new project is created.

The following describes how to add the test\_bss\_NO and test\_bss\_NE sections, and set reset\_times. Figure 5.3 to Figure 5.12 show the Added Sections.

- (1) Show map window. Select “Map...” from the “View” menu.

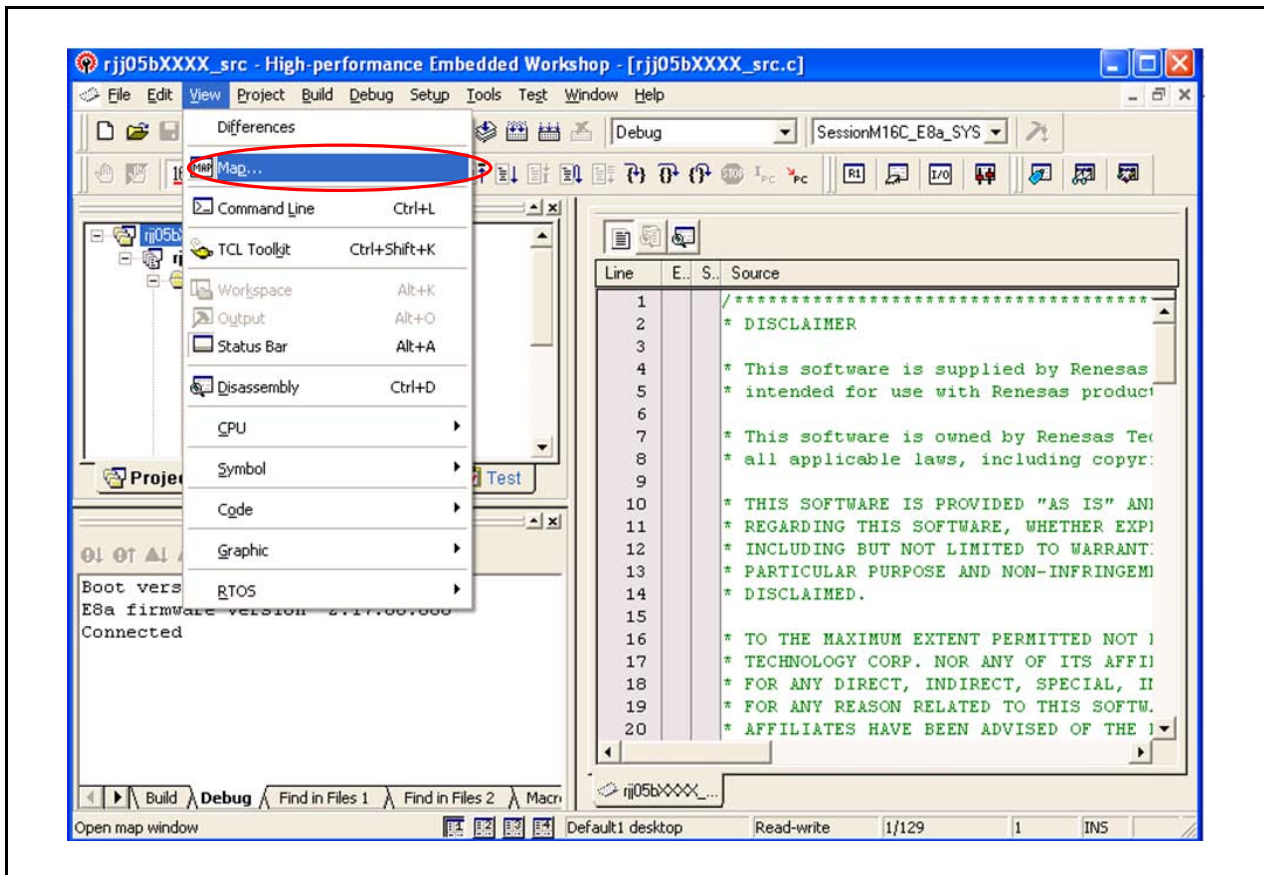

Figure 5.2 Added Section (1/9)

- (2) Select “Map Section Information” from “Map”.  
Use the same procedure to select “Map Symbol Information”.

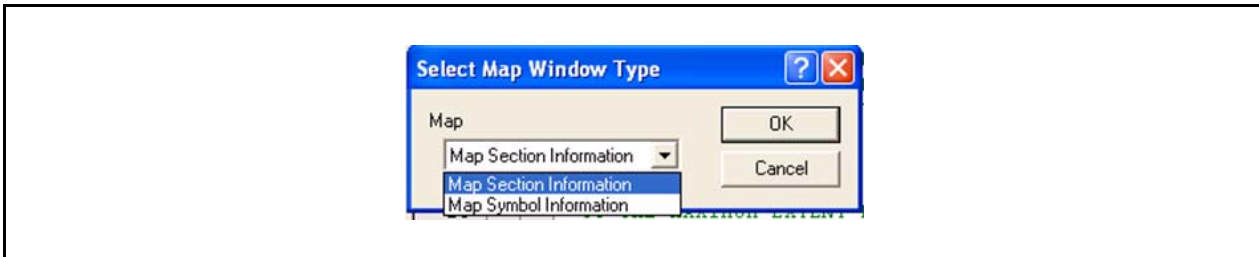

Figure 5.3 Added Section (2/9)

- (3) Click the “Edit Mode” button, and edit the section name.

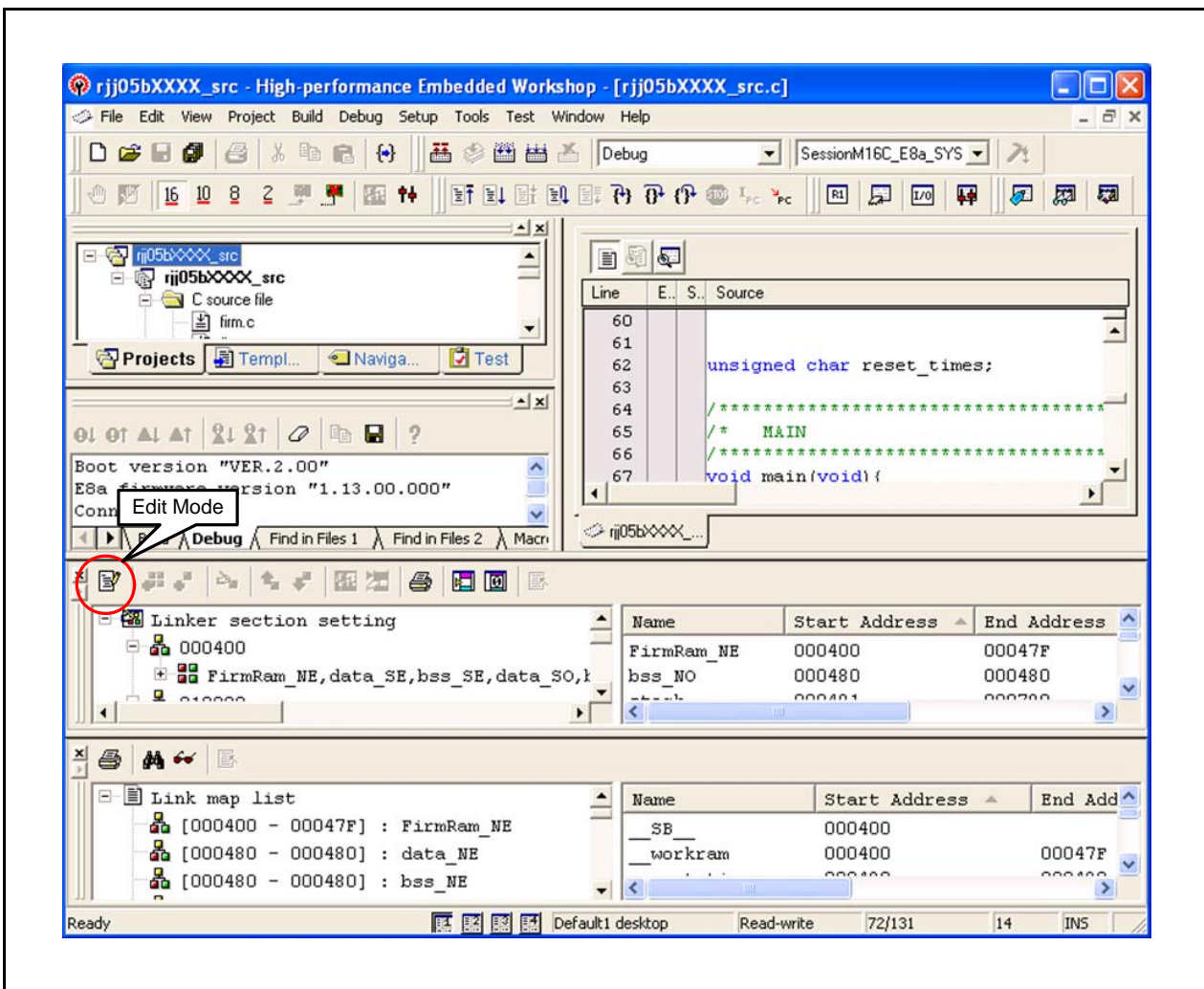

Figure 5.4 Added Section (3/9)

(4) Click the “Add Section...” button and add test\_bss\_NO.

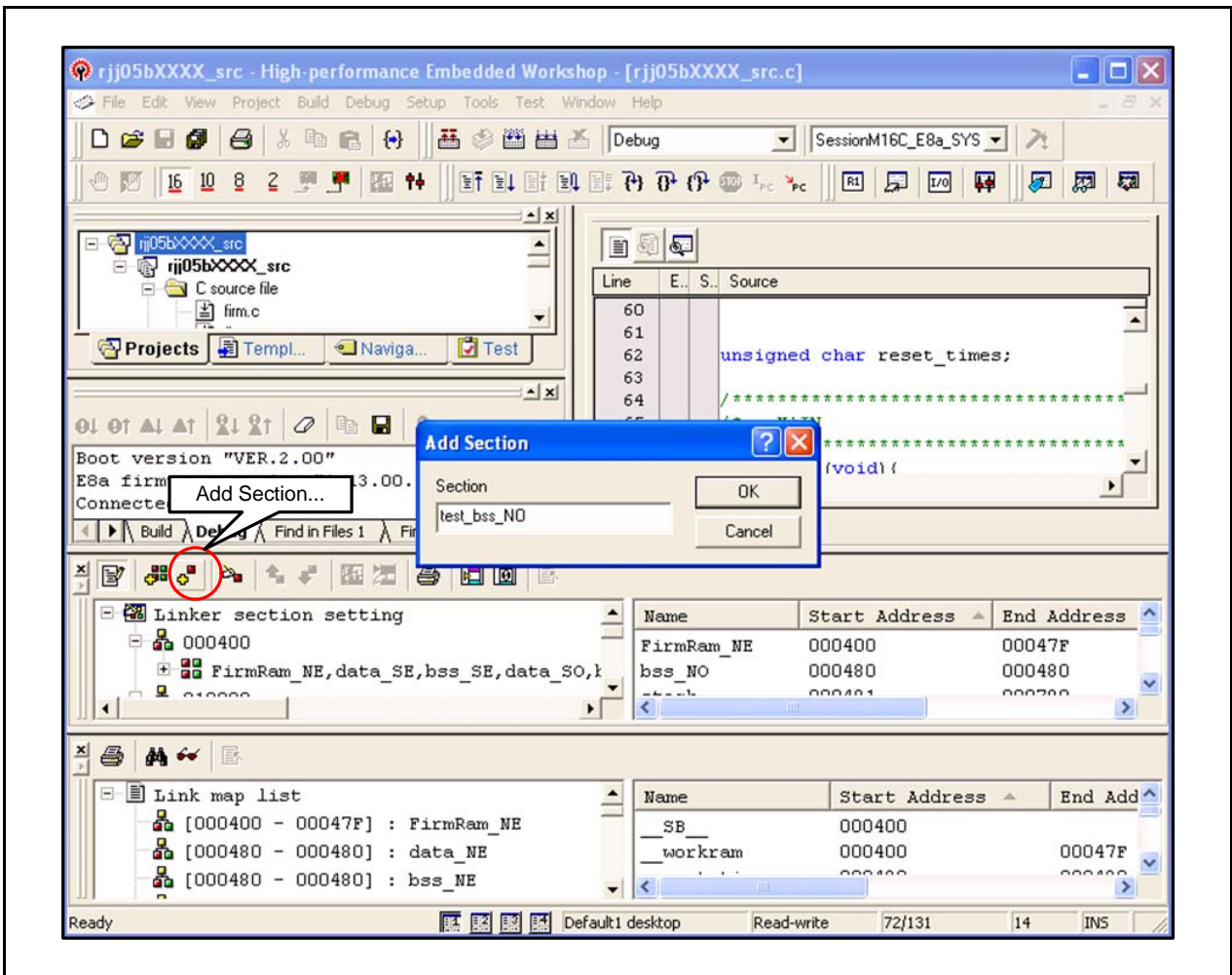

Figure 5.5 Added Section (4/9)

(5) Add test\_bss\_NE using same method in step (4).

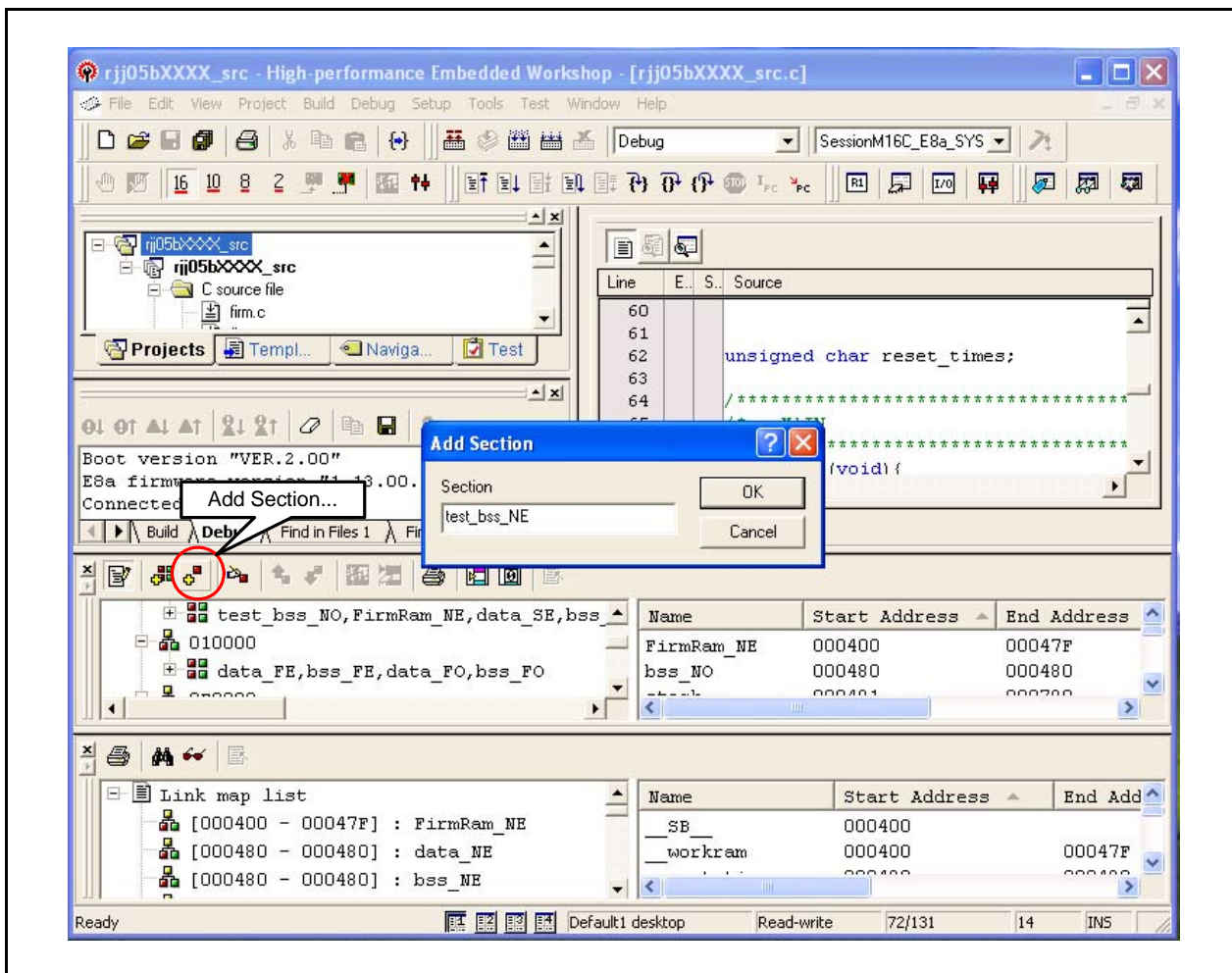

Figure 5.6 Added Section (5/9)



(6) Click the “Edit Mode” button, and confirm the changed linker section information.

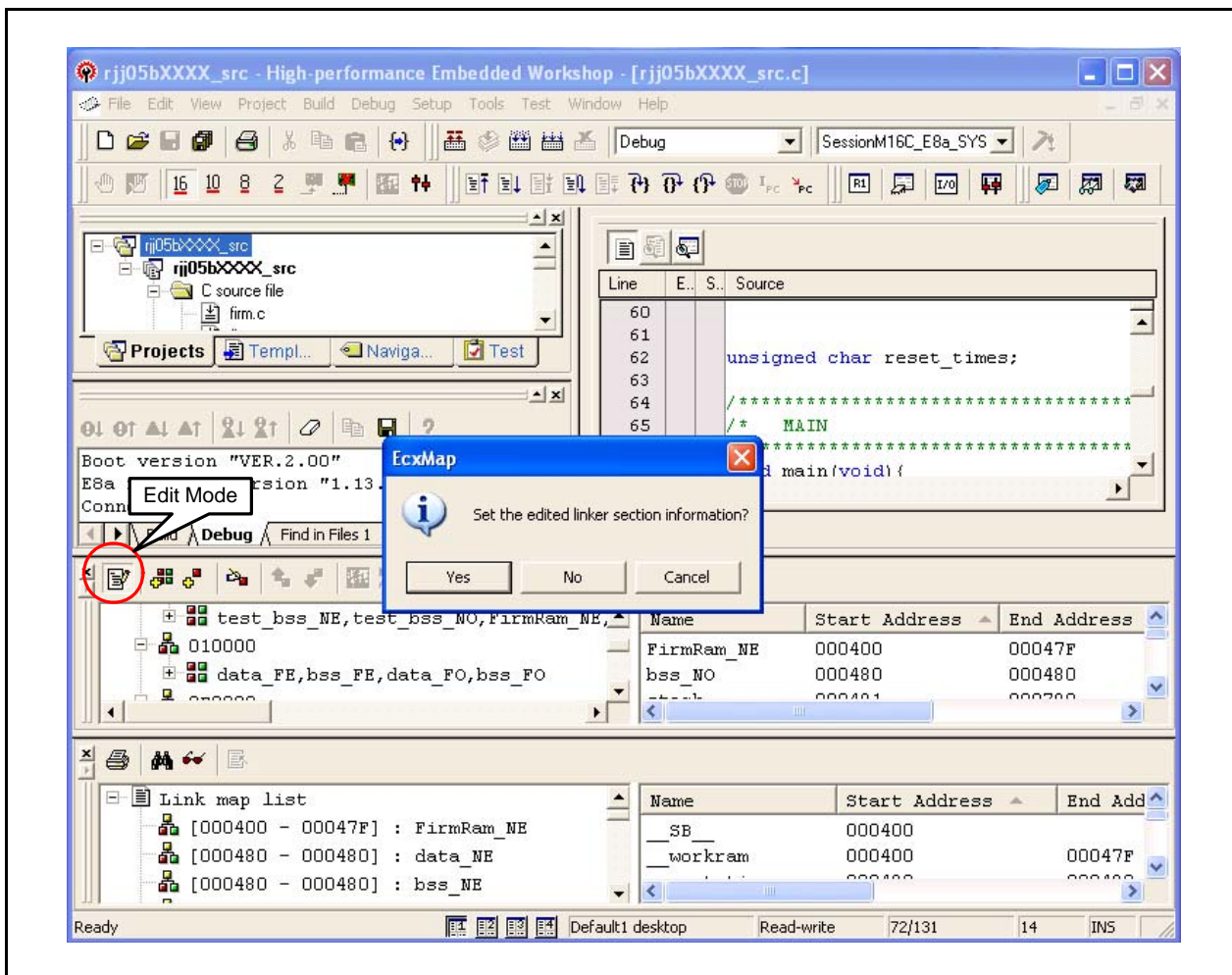

Figure 5.7 Added Section (6/9)

(7) The test\_bss\_NE and test\_bss\_NO sections are assigned.

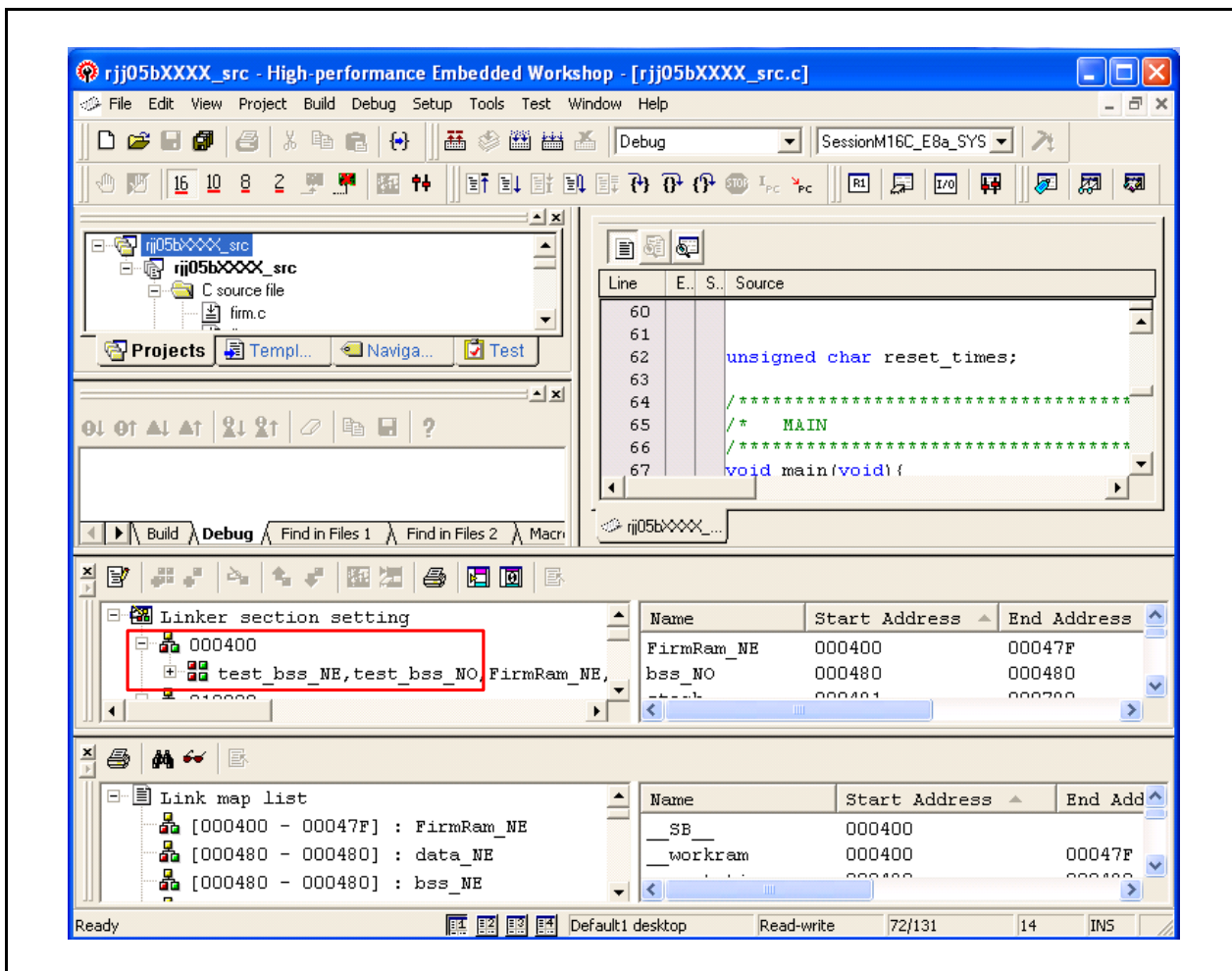

Figure 5.8 Added Section (7/9)

(8) Assign variable reset\_times to the test\_bss section by a program.

```
#pragma SECTION bss test_bss
unsigned char reset_times;
```

**Figure 5.9 Method of Setting Variable to test\_bss Section**

Variables without default values after the #pragma SECTION declaration are assigned to the test\_bss section.

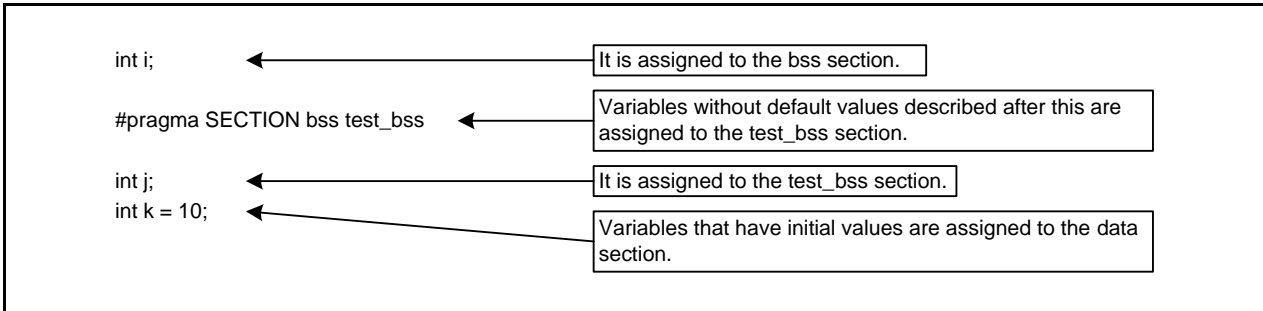

**Figure 5.10 Section Assignment Based on Variable Declaration Placement**

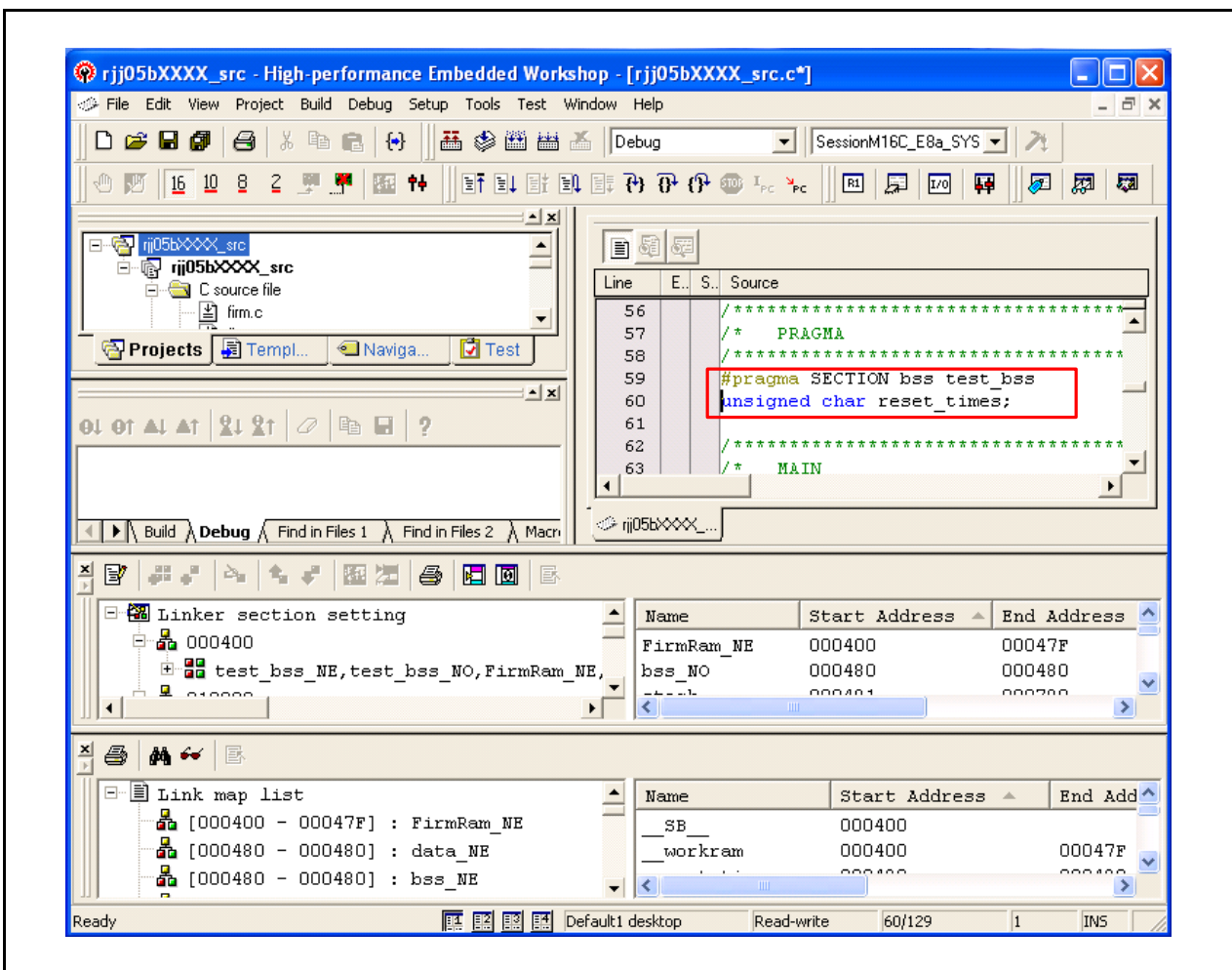

**Figure 5.11 Added Section (8/9)**



(9) When executing “Build”, variable reset\_times is assigned to the test\_bss\_NO section.

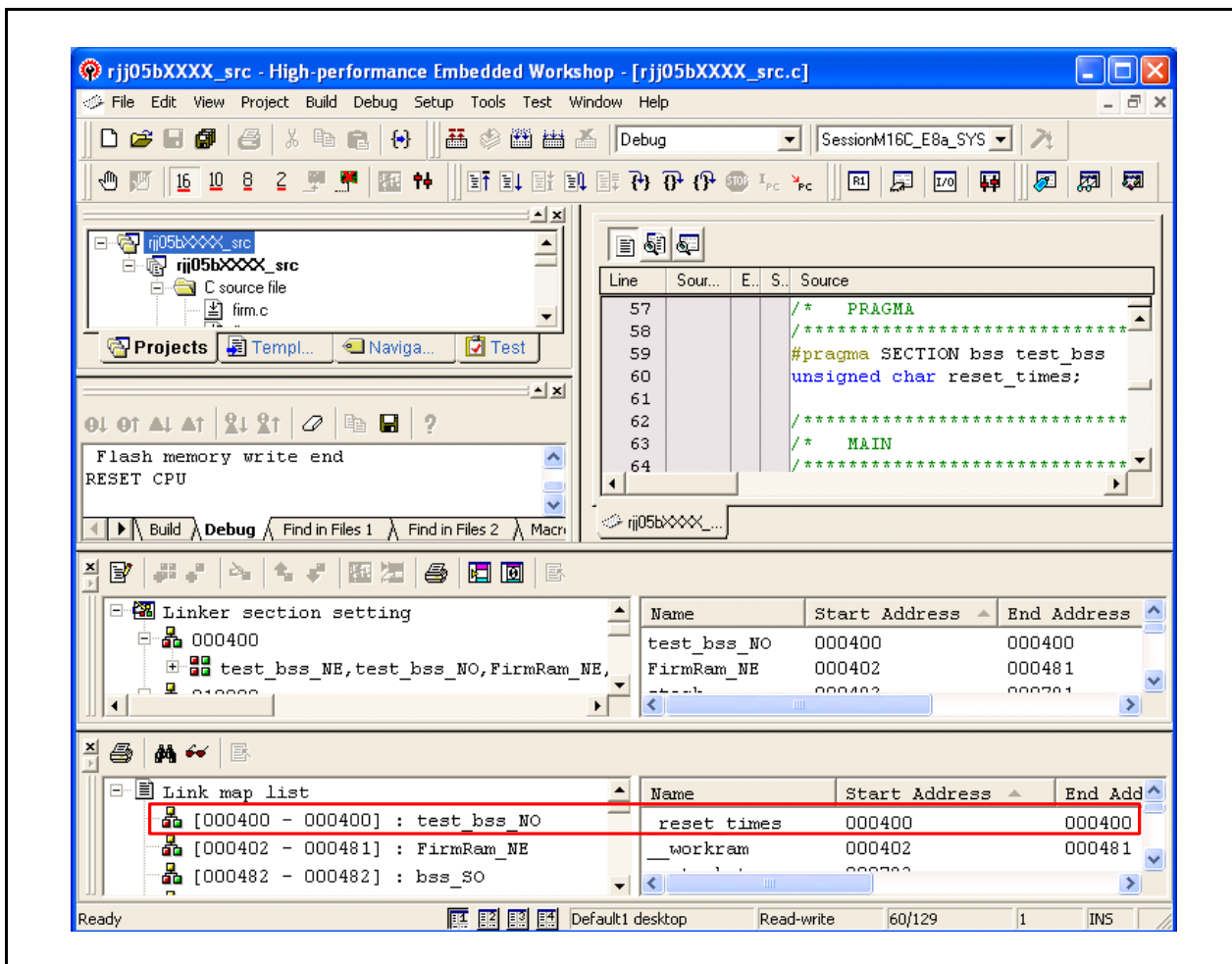

Figure 5.12 Added Section (9/9)

### 5.3 Using Standard I/O Functions in the Standard Library

The standard I/O functions <sup>(1)</sup> in the standard library used in the M16C Series have the following restrictions:

- The Address of the UITB register is defined as 3AAh in the standard I/O functions of the nc30lib.lib. Therefore, the MCUs (M16C/64, 65, etc.) which the address of that are defined as 25Ah are not supported.
- The size which read the receiving buffer register is defined wrongly in the low-level functions for the standard I/O functions (scanf, etc.).

To withdraw the above restrictions, compile the device.c file found in the sample code with the user program, and then link them. <sup>(2)</sup>

Notes:

1. Standard I/O functions indicate the following the standard input functions and standard output functions:  
Standard input functions: fgetc, getc, getchar, fgets, gets, fread, scanf, fscanf  
Standard output functions: fputc, putc, putchar, fputs, puts, fwrite, printf, fprintf, vfprintf, vprintf
2. Register the device.c file to the project when using the High-performance Embedded Workshop. Replace the device.c file, if it has already existed.

## 6. Reference Documents

Technical Update/Technical News

The latest information can be downloaded from the Renesas Electronics website.

C Compiler User's Manual

M16C Series, R8C Family C Compiler Package V.5.45

C Compiler User's Manual Rev.2.00

The latest version can be downloaded from the Renesas Electronics website.

## Website and Support

Renesas Electronics website

<http://www.renesas.com/>

Inquiries

<http://www.renesas.com/inquiry>

Revision History	M16C/64A Group High-performance Embedded Workshop Start-up Program in C
------------------	---

Rev.	Date	Description	
		Page	Summary
1.00	Nov. 30, 2010	—	First edition issued

All trademarks and registered trademarks are the property of their respective owners.

## General Precautions in the Handling of MPU/MCU Products

The following usage notes are applicable to all MPU/MCU products from Renesas. For detailed usage notes on the products covered by this manual, refer to the relevant sections of the manual. If the descriptions under General Precautions in the Handling of MPU/MCU Products and in the body of the manual differ from each other, the description in the body of the manual takes precedence.

### 1. Handling of Unused Pins

Handle unused pins in accord with the directions given under Handling of Unused Pins in the manual.

- The input pins of CMOS products are generally in the high-impedance state. In operation with an unused pin in the open-circuit state, extra electromagnetic noise is induced in the vicinity of LSI, an associated shoot-through current flows internally, and malfunctions occur due to the false recognition of the pin state as an input signal become possible. Unused pins should be handled as described under Handling of Unused Pins in the manual.

### 2. Processing at Power-on

The state of the product is undefined at the moment when power is supplied.

- The states of internal circuits in the LSI are indeterminate and the states of register settings and pins are undefined at the moment when power is supplied.

In a finished product where the reset signal is applied to the external reset pin, the states of pins are not guaranteed from the moment when power is supplied until the reset process is completed.

In a similar way, the states of pins in a product that is reset by an on-chip power-on reset function are not guaranteed from the moment when power is supplied until the power reaches the level at which resetting has been specified.

### 3. Prohibition of Access to Reserved Addresses

Access to reserved addresses is prohibited.

- The reserved addresses are provided for the possible future expansion of functions. Do not access these addresses; the correct operation of LSI is not guaranteed if they are accessed.

### 4. Clock Signals

After applying a reset, only release the reset line after the operating clock signal has become stable. When switching the clock signal during program execution, wait until the target clock signal has stabilized.

- When the clock signal is generated with an external resonator (or from an external oscillator) during a reset, ensure that the reset line is only released after full stabilization of the clock signal. Moreover, when switching to a clock signal produced with an external resonator (or by an external oscillator) while program execution is in progress, wait until the target clock signal is stable.

### 5. Differences between Products

Before changing from one product to another, i.e. to one with a different part number, confirm that the change will not lead to problems.

- The characteristics of MPU/MCU in the same group but having different part numbers may differ because of the differences in internal memory capacity and layout pattern. When changing to products of different part numbers, implement a system-evaluation test for each of the products.

## Notice

- All information included in this document is current as of the date this document is issued. Such information, however, is subject to change without any prior notice. Before purchasing or using any Renesas Electronics products listed herein, please confirm the latest product information with a Renesas Electronics sales office. Also, please pay regular and careful attention to additional and different information to be disclosed by Renesas Electronics such as that disclosed through our website.
- Renesas Electronics does not assume any liability for infringement of patents, copyrights, or other intellectual property rights of third parties by or arising from the use of Renesas Electronics products or technical information described in this document. No license, express, implied or otherwise, is granted hereby under any patents, copyrights or other intellectual property rights of Renesas Electronics or others.
- You should not alter, modify, copy, or otherwise misappropriate any Renesas Electronics product, whether in whole or in part.
- Descriptions of circuits, software and other related information in this document are provided only to illustrate the operation of semiconductor products and application examples. You are fully responsible for the incorporation of these circuits, software, and information in the design of your equipment. Renesas Electronics assumes no responsibility for any losses incurred by you or third parties arising from the use of these circuits, software, or information.
- When exporting the products or technology described in this document, you should comply with the applicable export control laws and regulations and follow the procedures required by such laws and regulations. You should not use Renesas Electronics products or the technology described in this document for any purpose relating to military applications or use by the military, including but not limited to the development of weapons of mass destruction. Renesas Electronics products and technology may not be used for or incorporated into any products or systems whose manufacture, use, or sale is prohibited under any applicable domestic or foreign laws or regulations.
- Renesas Electronics has used reasonable care in preparing the information included in this document, but Renesas Electronics does not warrant that such information is error free. Renesas Electronics assumes no liability whatsoever for any damages incurred by you resulting from errors in or omissions from the information included herein.
- Renesas Electronics products are classified according to the following three quality grades: "Standard", "High Quality", and "Specific". The recommended applications for each Renesas Electronics product depends on the product's quality grade, as indicated below. You must check the quality grade of each Renesas Electronics product before using it in a particular application. You may not use any Renesas Electronics product for any application categorized as "Specific" without the prior written consent of Renesas Electronics. Further, you may not use any Renesas Electronics product for any application for which it is not intended without the prior written consent of Renesas Electronics. Renesas Electronics shall not be in any way liable for any damages or losses incurred by you or third parties arising from the use of any Renesas Electronics product for an application categorized as "Specific" or for which the product is not intended where you have failed to obtain the prior written consent of Renesas Electronics. The quality grade of each Renesas Electronics product is "Standard" unless otherwise expressly specified in a Renesas Electronics data sheets or data books, etc.  
"Standard": Computers; office equipment; communications equipment; test and measurement equipment; audio and visual equipment; home electronic appliances; machine tools; personal electronic equipment; and industrial robots.  
"High Quality": Transportation equipment (automobiles, trains, ships, etc.); traffic control systems; anti-disaster systems; anti-crime systems; safety equipment; and medical equipment not specifically designed for life support.  
"Specific": Aircraft; aerospace equipment; submersible repeaters; nuclear reactor control systems; medical equipment or systems for life support (e.g. artificial life support devices or systems), surgical implantations, or healthcare intervention (e.g. excision, etc.), and any other applications or purposes that pose a direct threat to human life.
- You should use the Renesas Electronics products described in this document within the range specified by Renesas Electronics, especially with respect to the maximum rating, operating supply voltage range, movement power voltage range, heat radiation characteristics, installation and other product characteristics. Renesas Electronics shall have no liability for malfunctions or damages arising out of the use of Renesas Electronics products beyond such specified ranges.
- Although Renesas Electronics endeavors to improve the quality and reliability of its products, semiconductor products have specific characteristics such as the occurrence of failure at a certain rate and malfunctions under certain use conditions. Further, Renesas Electronics products are not subject to radiation resistance design. Please be sure to implement safety measures to guard them against the possibility of physical injury, and injury or damage caused by fire in the event of the failure of a Renesas Electronics product, such as safety design for hardware and software including but not limited to redundancy, fire control and malfunction prevention, appropriate treatment for aging degradation or any other appropriate measures. Because the evaluation of microcomputer software alone is very difficult, please evaluate the safety of the final products or system manufactured by you.
- Please contact a Renesas Electronics sales office for details as to environmental matters such as the environmental compatibility of each Renesas Electronics product. Please use Renesas Electronics products in compliance with all applicable laws and regulations that regulate the inclusion or use of controlled substances, including without limitation, the EU RoHS Directive. Renesas Electronics assumes no liability for damages or losses occurring as a result of your noncompliance with applicable laws and regulations.
- This document may not be reproduced or duplicated, in any form, in whole or in part, without prior written consent of Renesas Electronics.
- Please contact a Renesas Electronics sales office if you have any questions regarding the information contained in this document or Renesas Electronics products, or if you have any other inquiries.  
(Note 1) "Renesas Electronics" as used in this document means Renesas Electronics Corporation and also includes its majority-owned subsidiaries.  
(Note 2) "Renesas Electronics product(s)" means any product developed or manufactured by or for Renesas Electronics.



### SALES OFFICES

Renesas Electronics Corporation

<http://www.renesas.com>

Refer to "<http://www.renesas.com/>" for the latest and detailed information.

**Renesas Electronics America Inc.**  
2880 Scott Boulevard Santa Clara, CA 95050-2554, U.S.A.  
Tel: +1-408-588-6000, Fax: +1-408-588-6130

**Renesas Electronics Canada Limited**  
1101 Nicholson Road, Newmarket, Ontario L3Y 9C3, Canada  
Tel: +1-905-898-5441, Fax: +1-905-898-3220

**Renesas Electronics Europe Limited**  
Dukes Meadow, Millboard Road, Bourne End, Buckinghamshire, SL8 5FH, U.K  
Tel: +44-1628-585-100, Fax: +44-1628-585-900

**Renesas Electronics Europe GmbH**  
Arcadiastrasse 10, 40472 Düsseldorf, Germany  
Tel: +49-211-65030, Fax: +49-211-6503-1327

**Renesas Electronics (China) Co., Ltd.**  
7th Floor, Quantum Plaza, No.27 ZhichunLu Haidian District, Beijing 100083, P.R.China  
Tel: +86-10-8235-1155, Fax: +86-10-8235-7679

**Renesas Electronics (Shanghai) Co., Ltd.**  
Unit 204, 205, AZIA Center, No.1233 Lujiazui Ring Rd., Pudong District, Shanghai 200120, China  
Tel: +86-21-5877-1818, Fax: +86-21-6887-7858 / -7898

**Renesas Electronics Hong Kong Limited**  
Unit 1601-1613, 16/F., Tower 2, Grand Century Place, 193 Prince Edward Road West, Mongkok, Kowloon, Hong Kong  
Tel: +852-2886-9318, Fax: +852-2886-9022/9044

**Renesas Electronics Taiwan Co., Ltd.**  
7F, No. 363 Fu Shing North Road Taipei, Taiwan  
Tel: +886-2-8175-9600, Fax: +886-2-8175-9670

**Renesas Electronics Singapore Pte. Ltd.**  
1 HarbourFront Avenue, #06-10, Keppel Bay Tower, Singapore 098632  
Tel: +65-6213-0200, Fax: +65-6278-8001

**Renesas Electronics Malaysia Sdn.Bhd.**  
Unit 906, Block B, Menara Amcorp, Amcorp Trade Centre, No. 18, Jln Persiaran Barat, 46050 Petaling Jaya, Selangor Darul Ehsan, Malaysia  
Tel: +60-3-7955-9390, Fax: +60-3-7955-9510

**Renesas Electronics Korea Co., Ltd.**  
11F., Samik Laviel' or Bldg., 720-2 Yeoksam-Dong, Kangnam-Ku, Seoul 135-080, Korea  
Tel: +82-2-558-3737, Fax: +82-2-558-5141