

1. Abstract

This document describes an application example for using the voltage detector. The sample code shows how to detect the rise or fall of VCC input voltage using the voltage detector.

2. Introduction

The application example described in this document applies to the following microcomputer (MCU):

- MCU: M16C/5M Group

When using this application note with other Renesas MCUs, careful evaluation is recommended after making modifications to comply with the alternate MCU.

The sample code operates under following conditions.

- XIN frequency: 8 MHz
- Message transmission
Channel: UART1

- Communication settings

- Baud rate: 38400 bps
- Data length: 8 bits
- Parity: None
- Stop bit: 1 bit
- Flow control: None

Depending on the MCU used, the surrounding temperature, and other variables, characteristics for the voltage detector such as the detection voltage and detection time will vary within the range listed in the Electrical Characteristics chapter of the User's Manual: Hardware. The settings described in this document are examples used only for reference. The variation in the electrical characteristics should be considered when designing your system. Refer to the User's Manual: Hardware for details on electrical characteristics.

3. Application Example

3.1 Overview

In this sample code, the voltage of VCC is checked every 10 ms after the power-on reset. When VCC is equal to or above Vdet2 ten times consecutively (i.e. $VCC \geq Vdet2$ for 100 ms), the program determines that the VCC voltage is stable at or above Vdet2.

When VCC is equal to or above Vdet2 after the power-on reset.

- (1) Configure the voltage monitor interrupt.
- (2) Transmit the message "Start" to the personal computer (hereinafter referred to as PC), and perform normal operation.

When VCC is equal to or below Vdet2 after the power-on reset.

- (1) Invert the alarm port every 1 second. ⁽¹⁾
- (2) Transmit the message "Please set 5.0V" to the PC.

When a rise or a fall is detected in the VCC voltage, an interrupt occurs. Read the VW2C2 bit in the VW2C register in the interrupt handler, then determine whether the source is the voltage monitor 2 interrupt. The digital filter is not used here.

- (1) Normal operation (when voltage is stable)
Every 0.5 seconds, the count port value is incremented and then output. ⁽¹⁾
- (2) Operation when the voltage monitor 2 interrupt occurs
When VCC is equal to or below Vdet2 and the voltage monitor 2 interrupt occurs:
 - Transmit the message "Under Vdet2" to the PC.
 - Change the condition for the voltage monitor 2 interrupt to " $VCC \geq Vdet2$ ".When VCC is equal to or above Vdet2 and the voltage monitor 2 interrupt occurs:
 - Transmit the message "Over Vdet2" to the PC.
 - Change the condition for the voltage monitor 2 interrupt to " $VCC \leq Vdet2$ ".
- (3) Operation when the voltage monitor 0 reset occurs
Reset is executed.

Note:

1. Count ports: P0_0 to P0_2
Alarm port: P0_3

3.2 Circuit Example

Figure 3.1 shows the Power-On Reset Circuit.

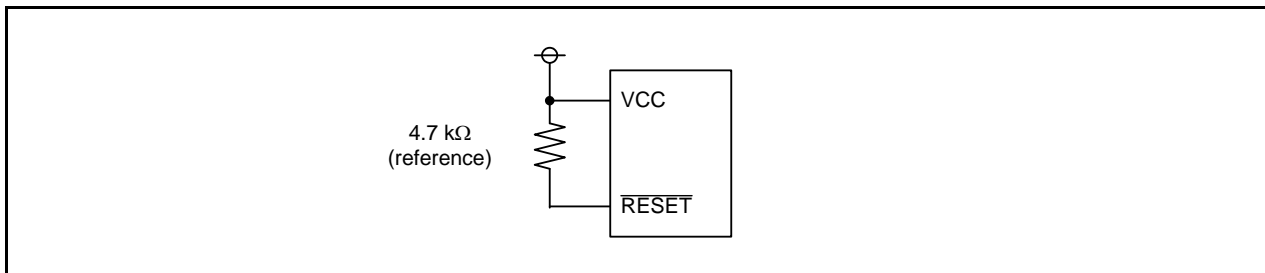

Figure 3.1 Power-On Reset Circuit

3.3 Operation

Table 3.1 lists the operations when the voltage transitions as shown in Figure 3.2.

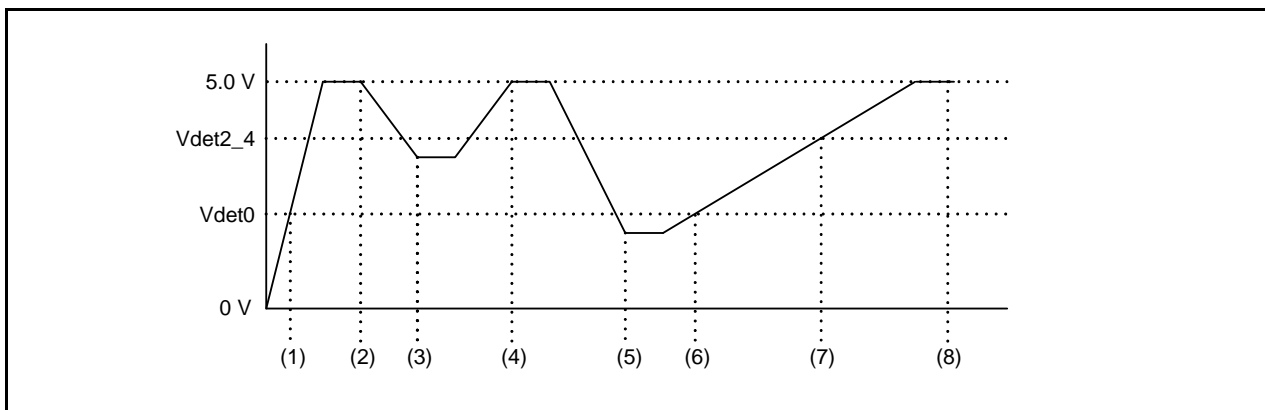

Figure 3.2 Voltage Transition

Table 3.1 Operations for (1) to (8) in Figure 3.2

	Operation	Condition
(1)	Power-on reset	When VCC is equal to or above Vdet0.
(2)	Start incrementing the count port. Transmit the message "Start" to the PC.	VCC is equal to or above Vdet2 for 100 ms.
(3)	Transmit the message "Under Vdet2" to the PC. Change the VW2C7 bit to 0 (when VCC is equal to or above Vdet2).	VCC passed downward through Vdet2.
(4)	Transmit the message "Over Vdet2" to the PC. Change the VW2C7 bit to 1 (when VCC is equal to or below Vdet2).	VCC passed upward through Vdet2.
(5)	Voltage monitor 0 reset	VCC is below Vdet0.
(6), (7)	Invert the alarm port in 1 second interval and transmit the message "Please set 5.0V" to the PC.	VCC is equal to or above Vdet0, and below Vdet2.
(8)	Start incrementing a count port. Transmit the message "Start" to the PC.	VCC is equal to or above Vdet2 for 100 ms.

3.4 Determining When $VCC \geq V_{det2}$

Figure 3.3 shows how to read the VC13 bit in the VCR1 register to determine whether VCC is equal to or above V_{det2} .

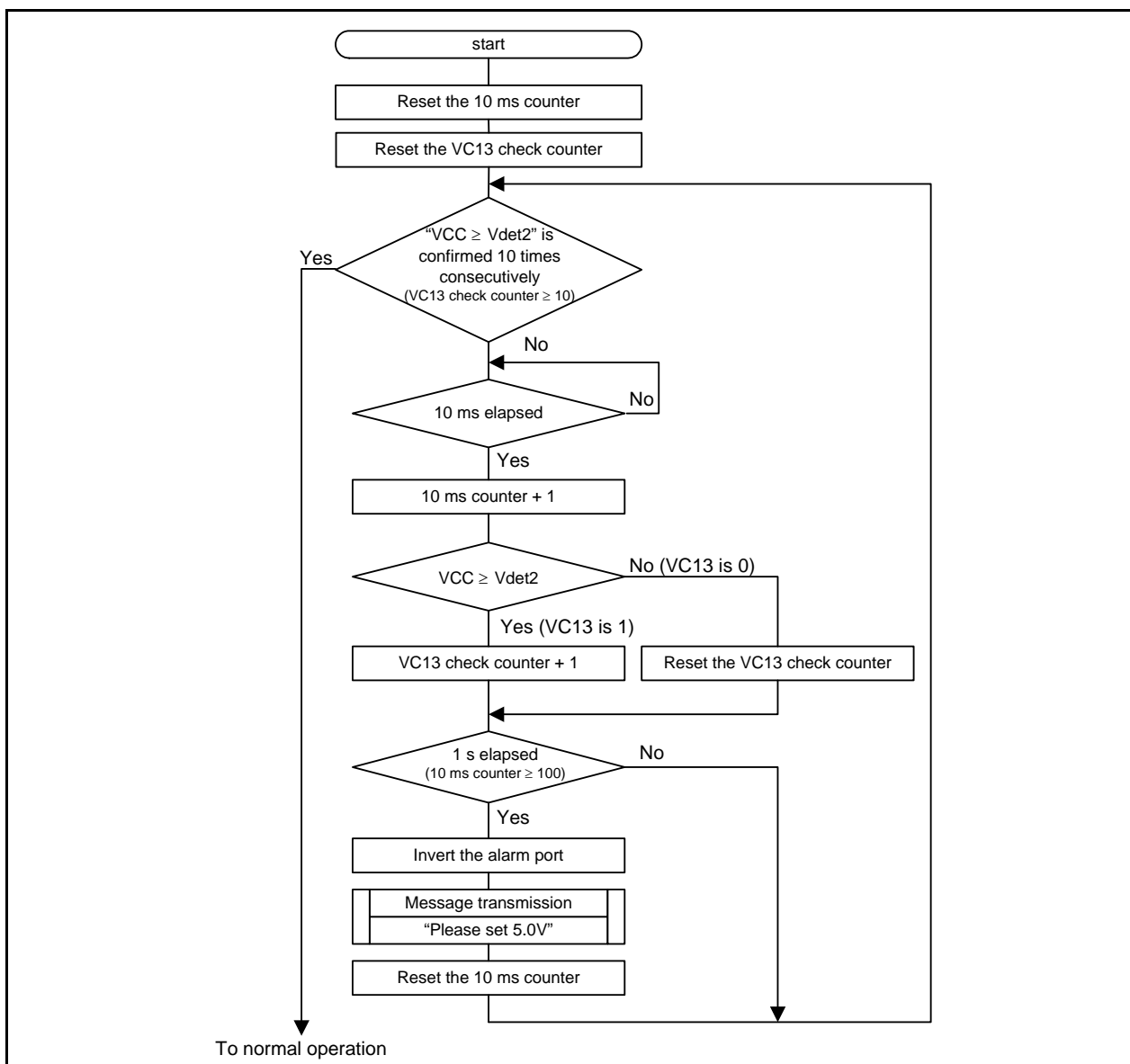

Figure 3.3 Determining When $VCC \geq V_{det2}$

3.5 Determining the Voltage Monitor Interrupt Source

Read the voltage change detection flag in the interrupt handler to determine whether the source is the voltage monitor 2 interrupt. Chattering check is not performed here. Figure 3.4 shows a flowchart for determining the voltage monitor interrupt source.

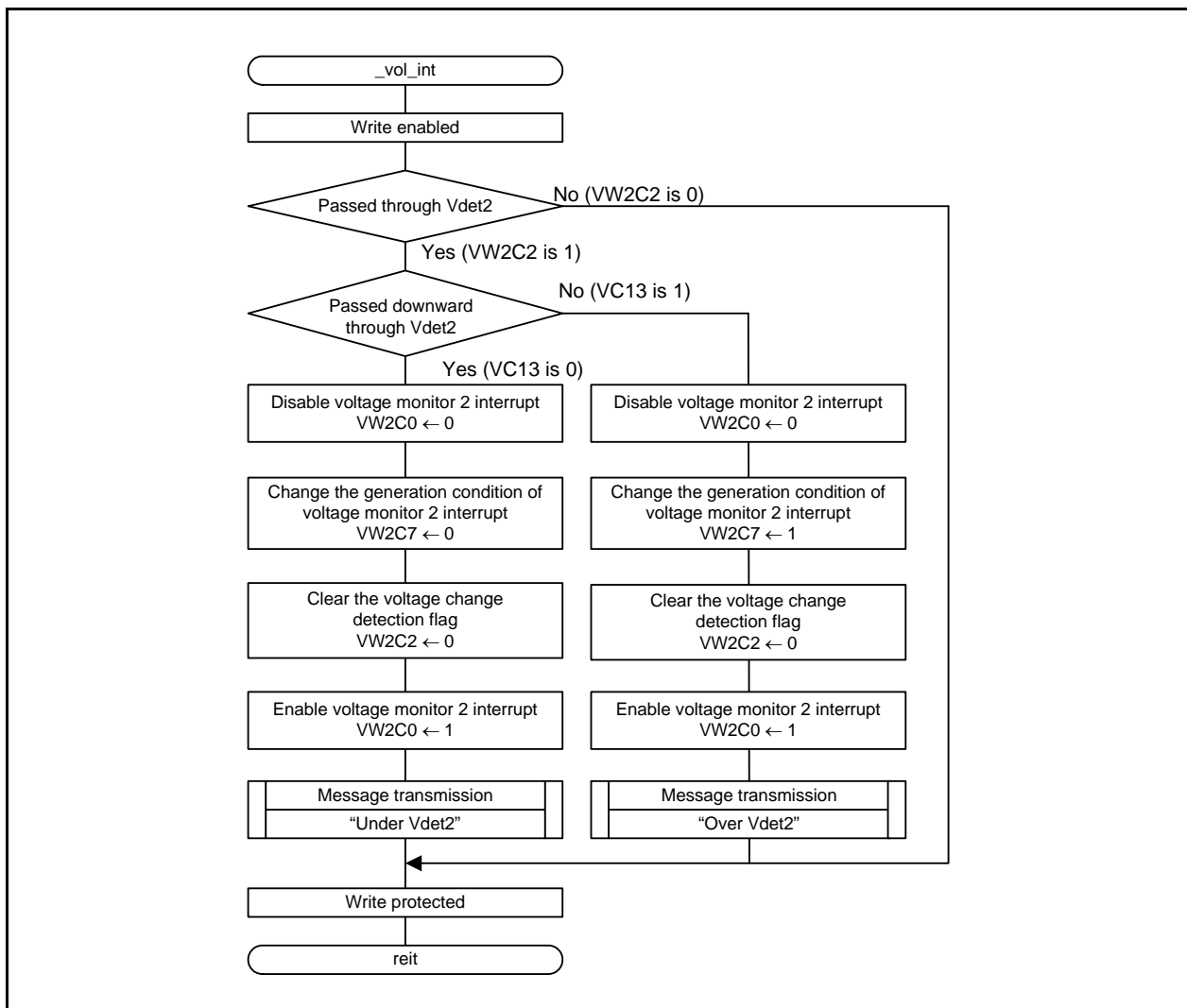

Figure 3.4 Determining the Voltage Monitor Interrupt Source

4. Setting Procedures

4.1 Setting Optional Function Select Address 1 (OFS1)

Enabling and disabling the voltage monitor 0 reset after hardware reset can be selected by setting the LVDAS bit in the OFS1 address. In this sample code, the voltage monitor 0 reset is enabled after hardware reset.

The OFS1 address is assigned to address FFFFh in the M16C/5M Group.

Refer to User's Manual: Hardware for the OFS1 address setting values.

Table 4.1 shows script examples for enabling the voltage monitor 0 reset after hardware reset in the M16C/5M Group.

Table 4.1 Script Examples for the OFS1 Address

Tool	Description
Script in C language	<code>_asm(".ofsreg 09Fh");</code>
Script in assembly language	<code>.ofsreg 09Fh</code>

4.2 Procedure for Setting Voltage Monitor Related Bits

Table 4.2 shows Procedure for Setting Voltage Monitor 0 Reset Related Bits. Table 4.3 shows Procedure for Setting Voltage Monitor 2 Interrupt/Reset Related Bits.

Table 4.2 Procedure for Setting Voltage Monitor 0 Reset Related Bits

Step	Processing
1	Set the VC25 bit in the VCR2 register to 1 (voltage detector 0 enabled).
2	Wait for td(E-A).
3	Set bits 6 and 7 in the VW0C register to 1.
4	Set bit 2 in the VW0C register to 0 (set this bit to 0 once again after step 3).
5	Set the VW0C0 bit in the VW0C register to 1 (voltage monitor 0 reset enabled).

Table 4.3 Procedure for Setting Voltage Monitor 2 Interrupt/Reset Related Bits

Step	When Using the Digital Filter		When Not Using the Digital Filter	
	Voltage Monitor 2 Interrupt	Voltage Monitor 2 Reset	Voltage Monitor 2 Interrupt	Voltage Monitor 2 Reset
1	Set the CM14 bit in the CM1 register to 0 (125 kHz on-chip oscillator on)		—	
2	Wait for digital filter sampling clock × 3 cycles.		— (no wait time)	
3	Set the VW12E bit in the VWCE register to 1 (voltage monitor 2 enabled).			
4	Use bits VD2LS3 to VD2LS0 in the VD2LS register to select Vdet2.			
5	Set the VC27 bit in the VCR2 register to 1 (voltage detector 2 enabled).			
6	Wait for td(E-A).			
7	Use bits VW2F0 to VW2F1 in the VW2C register to select the digital filter sampling clock.		Use the VW2C7 bit in the VW2C register to select the timing of the interrupt and reset request. ⁽¹⁾	
8 ⁽²⁾	Set the VW2C1 bit in the VW2C register to 0 (digital filter enabled).		Set the VW2C1 bit in the VW2C register to 1 (digital filter disabled).	
9 ⁽²⁾	Set the VW2C6 bit in the VW2C register to 0 (voltage monitor 2 interrupt mode).	Set the VW2C6 bit in the VW2C register to 1 (voltage monitor 2 reset mode).	Set the VW2C6 bit in the VW2C register to 0 (voltage monitor 2 interrupt mode).	Set the VW2C6 bit in the VW2C register to 1 (voltage monitor 2 reset mode).
10	Set the VW2C2 bit in the VW2C register to 0 (Vdet2 passage not detected).			
11	Set the VW2C0 bit in the VW2C register to 1 (voltage monitor 2 interrupt/reset enabled).			

Notes:

1. Set the VW2C7 bit to 1 for the voltage monitor 2 reset (When VCC reaches or goes below Vdet2).
2. When the VW2C0 bit is 0, steps 7, 8, and 9 can be executed simultaneously (with one instruction).

5. Setting Method

The setting procedures and values in this chapter are used to achieve the example described in 3. “Application Example”. Refer to the User’s Manual: Hardware for details on registers.

5.1 Setting Optional Function Select Address 1 (OFS1)

Figure 5.1 shows Setting Optional Function Select Address 1 (OFS1).

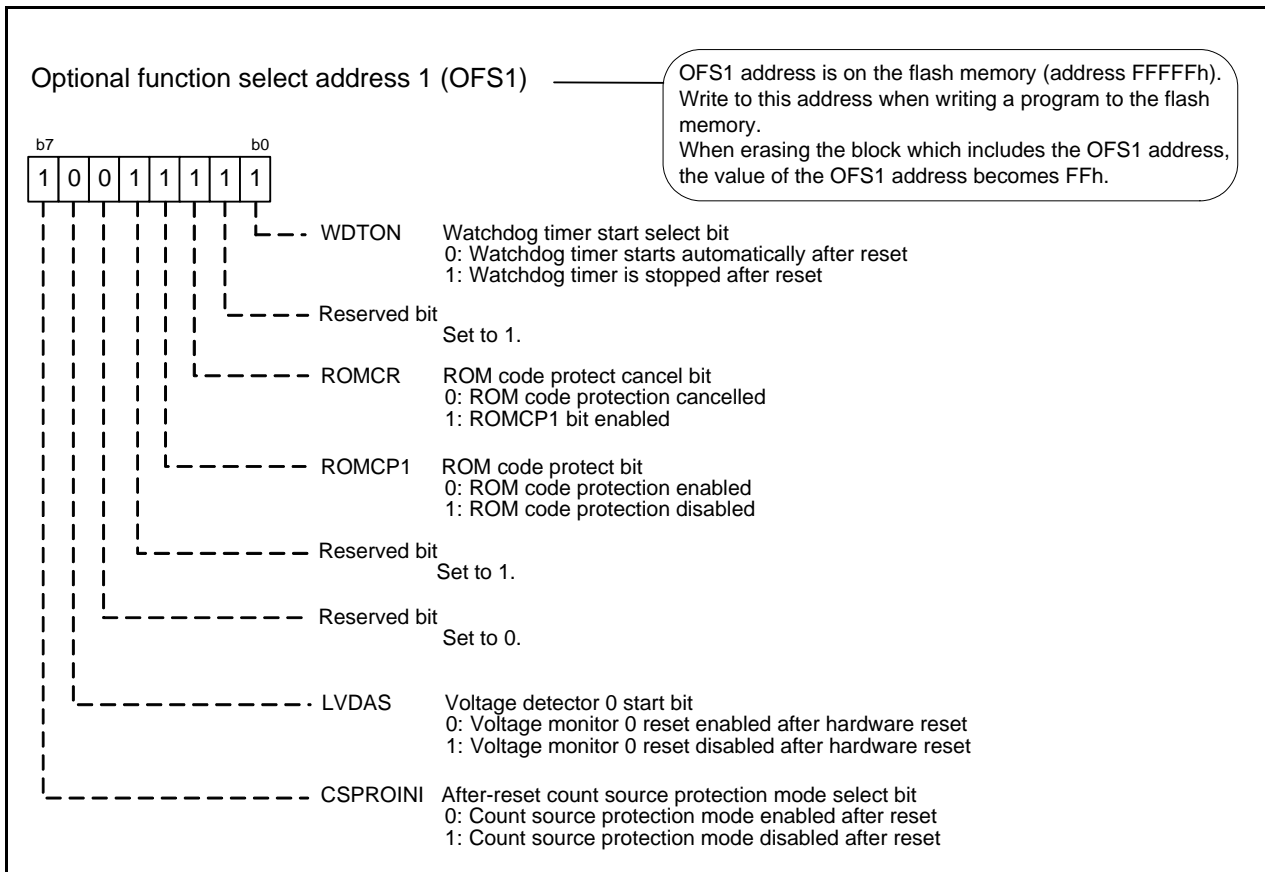

Figure 5.1 Setting Optional Function Select Address 1 (OFS1)

5.2 Setting Registers Associated with Voltage Detectors

Figure 5.2 to Figure 5.3 show register settings associated with voltage detectors.

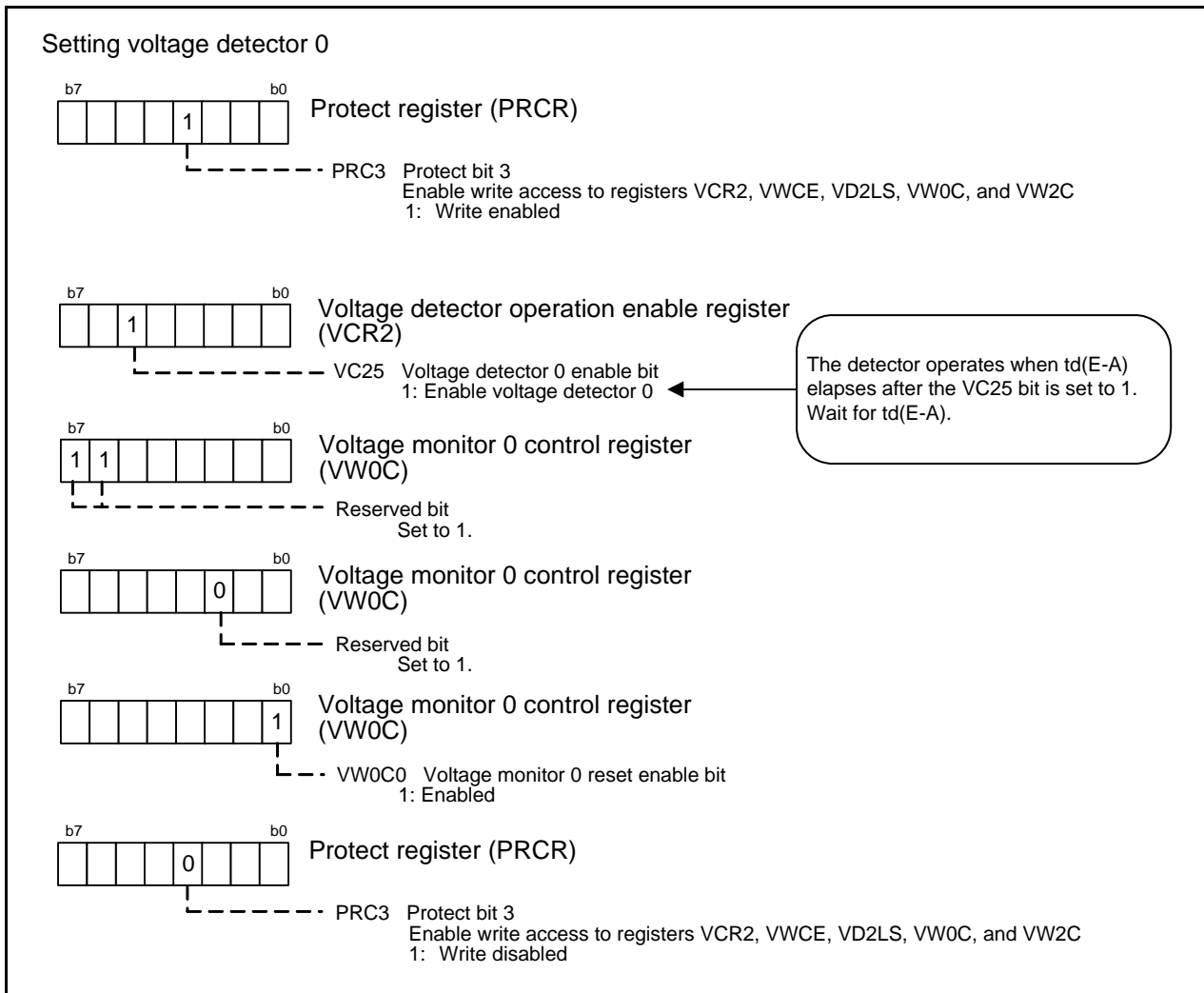

Figure 5.2 Setting Registers Associated with Voltage Monitor 0

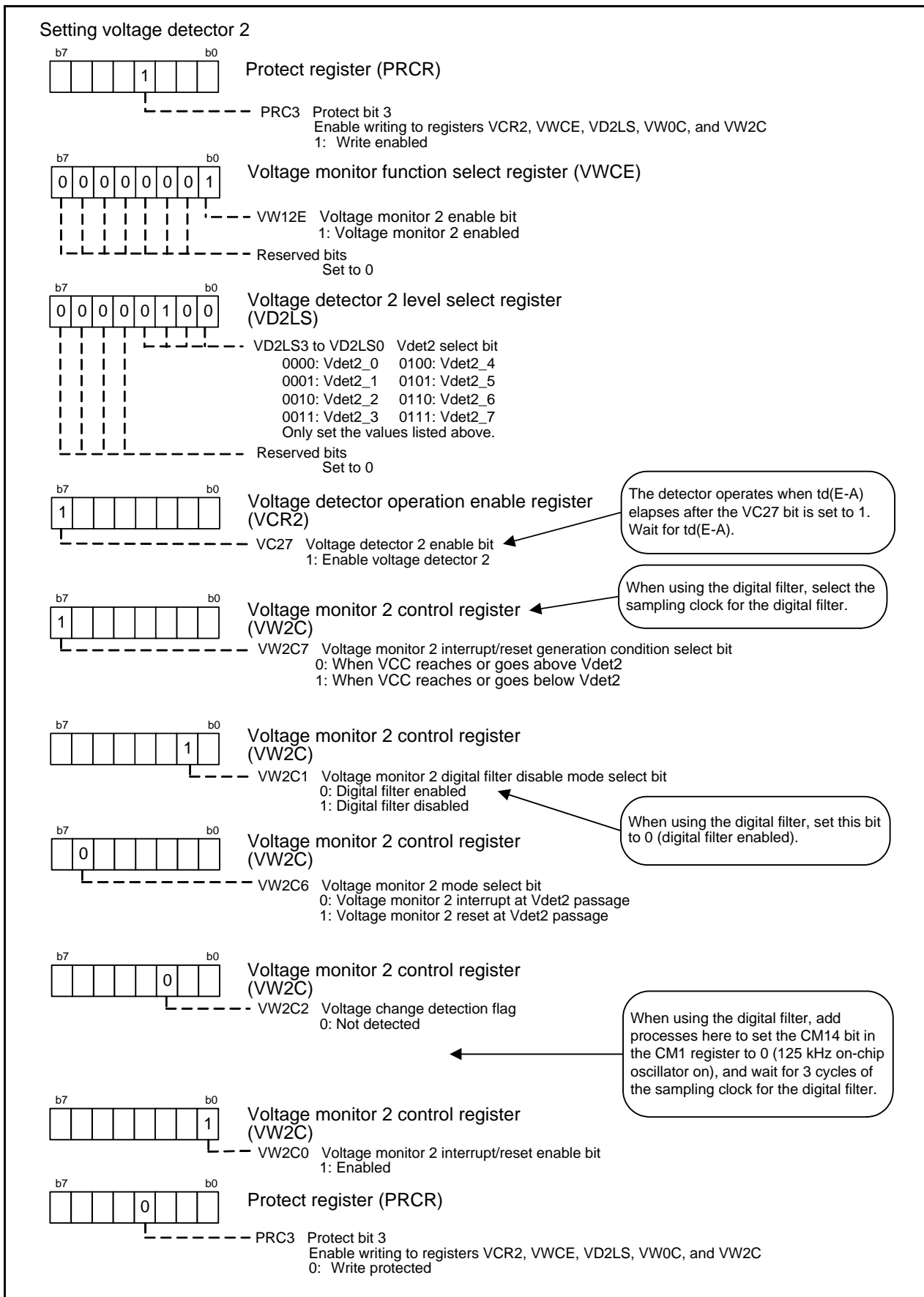

Figure 5.3 Setting Registers Associated with Voltage Monitor 2

5.3 Interrupt Handling and Register Setting

Figure 5.4 shows interrupt handling and register setting.

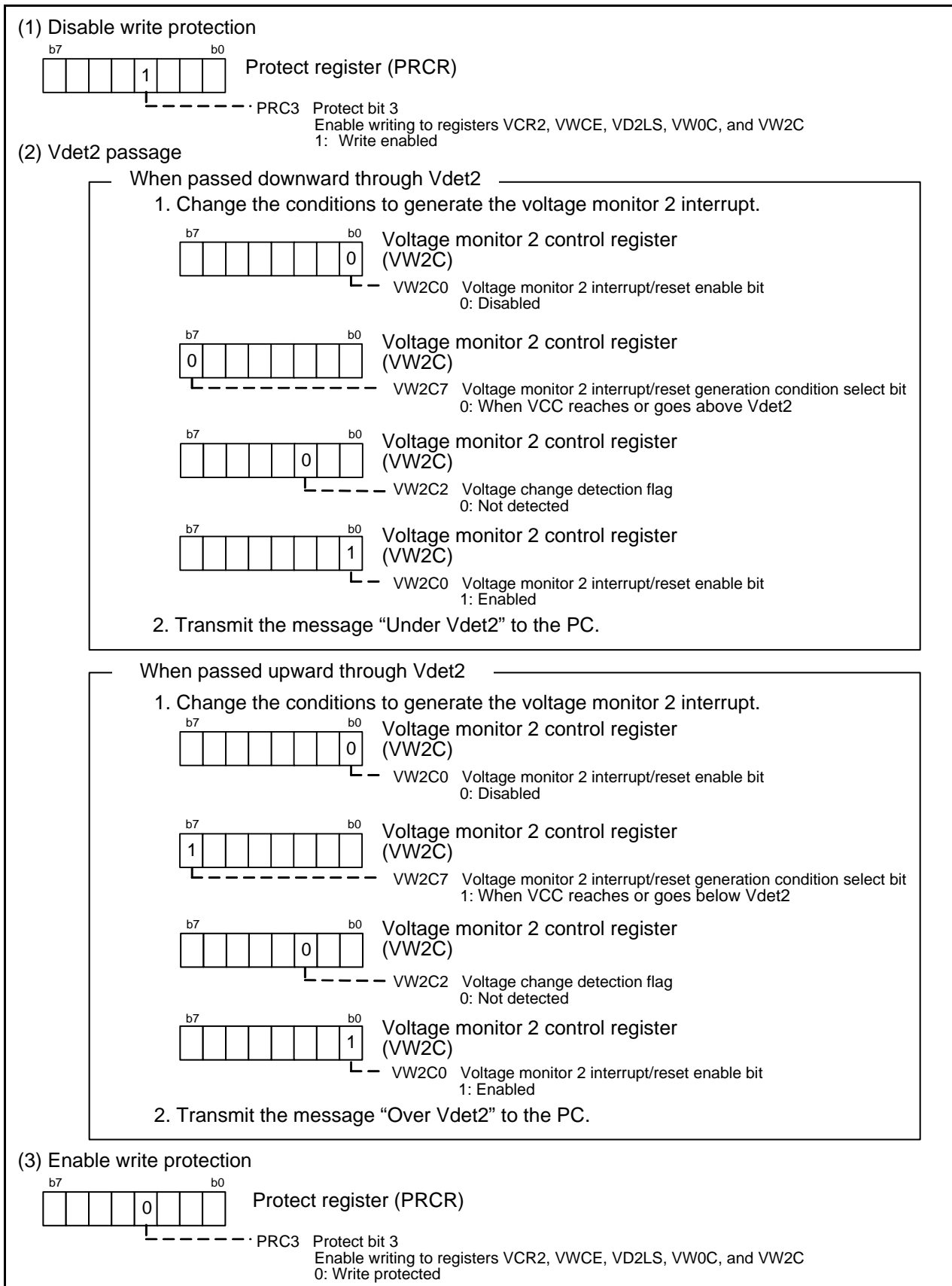

Figure 5.4 Interrupt Handling and Register Setting

6. Sample Code

Sample code can be downloaded from the Renesas Electronics website.

7. Reference Documents

M16C/5M Group, M16C/57 Group User's Manual: Hardware Rev. 1.01

The latest version can be downloaded from the Renesas Electronics website.

Technical Update/Technical News

The latest information can be downloaded from the Renesas Electronics website.

C Compiler Manual

M16C Series/R8C Family C Compiler Package V.5.45

C Compiler User's Manual Rev.2.00

The latest version can be downloaded from the Renesas Electronics website.

Website and Support

Renesas Electronics website

<http://www.renesas.com/>

Inquiries

<http://www.renesas.com/inquiry>

Revision History	M16C/5M Group Using the Voltage Detector
------------------	---

Rev.	Date	Description	
		Page	Summary
1.00	Sep. 30, 2011	—	First edition issued

All trademarks and registered trademarks are the property of their respective owners.

General Precautions in the Handling of MPU/MCU Products

The following usage notes are applicable to all MPU/MCU products from Renesas. For detailed usage notes on the products covered by this manual, refer to the relevant sections of the manual. If the descriptions under General Precautions in the Handling of MPU/MCU Products and in the body of the manual differ from each other, the description in the body of the manual takes precedence.

1. Handling of Unused Pins

Handle unused pins in accord with the directions given under Handling of Unused Pins in the manual.

- The input pins of CMOS products are generally in the high-impedance state. In operation with an unused pin in the open-circuit state, extra electromagnetic noise is induced in the vicinity of LSI, an associated shoot-through current flows internally, and malfunctions occur due to the false recognition of the pin state as an input signal become possible. Unused pins should be handled as described under Handling of Unused Pins in the manual.

2. Processing at Power-on

The state of the product is undefined at the moment when power is supplied.

- The states of internal circuits in the LSI are indeterminate and the states of register settings and pins are undefined at the moment when power is supplied.

In a finished product where the reset signal is applied to the external reset pin, the states of pins are not guaranteed from the moment when power is supplied until the reset process is completed.

In a similar way, the states of pins in a product that is reset by an on-chip power-on reset function are not guaranteed from the moment when power is supplied until the power reaches the level at which resetting has been specified.

3. Prohibition of Access to Reserved Addresses

Access to reserved addresses is prohibited.

- The reserved addresses are provided for the possible future expansion of functions. Do not access these addresses; the correct operation of LSI is not guaranteed if they are accessed.

4. Clock Signals

After applying a reset, only release the reset line after the operating clock signal has become stable. When switching the clock signal during program execution, wait until the target clock signal has stabilized.

- When the clock signal is generated with an external resonator (or from an external oscillator) during a reset, ensure that the reset line is only released after full stabilization of the clock signal. Moreover, when switching to a clock signal produced with an external resonator (or by an external oscillator) while program execution is in progress, wait until the target clock signal is stable.

5. Differences between Products

Before changing from one product to another, i.e. to one with a different part number, confirm that the change will not lead to problems.

- The characteristics of MPU/MCU in the same group but having different part numbers may differ because of the differences in internal memory capacity and layout pattern. When changing to products of different part numbers, implement a system-evaluation test for each of the products.

Notice

1. All information included in this document is current as of the date this document is issued. Such information, however, is subject to change without any prior notice. Before purchasing or using any Renesas Electronics products listed herein, please confirm the latest product information with a Renesas Electronics sales office. Also, please pay regular and careful attention to additional and different information to be disclosed by Renesas Electronics such as that disclosed through our website.
2. Renesas Electronics does not assume any liability for infringement of patents, copyrights, or other intellectual property rights of third parties by or arising from the use of Renesas Electronics products or technical information described in this document. No license, express, implied or otherwise, is granted hereby under any patents, copyrights or other intellectual property rights of Renesas Electronics or others.
3. You should not alter, modify, copy, or otherwise misappropriate any Renesas Electronics product, whether in whole or in part.
4. Descriptions of circuits, software and other related information in this document are provided only to illustrate the operation of semiconductor products and application examples. You are fully responsible for the incorporation of these circuits, software, and information in the design of your equipment. Renesas Electronics assumes no responsibility for any losses incurred by you or third parties arising from the use of these circuits, software, or information.
5. When exporting the products or technology described in this document, you should comply with the applicable export control laws and regulations and follow the procedures required by such laws and regulations. You should not use Renesas Electronics products or the technology described in this document for any purpose relating to military applications or use by the military, including but not limited to the development of weapons of mass destruction. Renesas Electronics products and technology may not be used for or incorporated into any products or systems whose manufacture, use, or sale is prohibited under any applicable domestic or foreign laws or regulations.
6. Renesas Electronics has used reasonable care in preparing the information included in this document, but Renesas Electronics does not warrant that such information is error free. Renesas Electronics assumes no liability whatsoever for any damages incurred by you resulting from errors in or omissions from the information included herein.
7. Renesas Electronics products are classified according to the following three quality grades: "Standard", "High Quality", and "Specific". The recommended applications for each Renesas Electronics product depends on the product's quality grade, as indicated below. You must check the quality grade of each Renesas Electronics product before using it in a particular application. You may not use any Renesas Electronics product for any application categorized as "Specific" without the prior written consent of Renesas Electronics. Further, you may not use any Renesas Electronics product for any application for which it is not intended without the prior written consent of Renesas Electronics. Renesas Electronics shall not be in any way liable for any damages or losses incurred by you or third parties arising from the use of any Renesas Electronics product for an application categorized as "Specific" or for which the product is not intended where you have failed to obtain the prior written consent of Renesas Electronics. The quality grade of each Renesas Electronics product is "Standard" unless otherwise expressly specified in a Renesas Electronics data sheets or data books, etc.
Standard: Computers; office equipment; communications equipment; test and measurement equipment; audio and visual equipment; home electronic appliances; machine tools; personal electronic equipment; and industrial robots.
High Quality: Transportation equipment (automobiles, trains, ships, etc.); traffic control systems; anti-disaster systems; anti-crime systems; safety equipment; and medical equipment not specifically designed for life support.
Specific: Aircraft; aerospace equipment; submersible repeaters; nuclear reactor control systems; medical equipment or systems for life support (e.g. artificial life support devices or systems), surgical implantations, or healthcare intervention (e.g. excision, etc.), and any other applications or purposes that pose a direct threat to human life.
8. You should use the Renesas Electronics products described in this document within the range specified by Renesas Electronics, especially with respect to the maximum rating, operating supply voltage range, movement power voltage range, heat radiation characteristics, installation and other product characteristics. Renesas Electronics shall have no liability for malfunctions or damages arising out of the use of Renesas Electronics products beyond such specified ranges.
9. Although Renesas Electronics endeavors to improve the quality and reliability of its products, semiconductor products have specific characteristics such as the occurrence of failure at a certain rate and malfunctions under certain use conditions. Further, Renesas Electronics products are not subject to radiation resistance design. Please be sure to implement safety measures to guard them against the possibility of physical injury, and injury or damage caused by fire in the event of the failure of a Renesas Electronics product, such as safety design for hardware and software including but not limited to redundancy, fire control and malfunction prevention, appropriate treatment for aging degradation or any other appropriate measures. Because the evaluation of microcomputer software alone is very difficult, please evaluate the safety of the final products or system manufactured by you.
10. Please contact a Renesas Electronics sales office for details as to environmental matters such as the environmental compatibility of each Renesas Electronics product. Please use Renesas Electronics products in compliance with all applicable laws and regulations that regulate the inclusion or use of controlled substances, including without limitation, the EU RoHS Directive. Renesas Electronics assumes no liability for damages or losses occurring as a result of your noncompliance with applicable laws and regulations.
11. This document may not be reproduced or duplicated, in any form, in whole or in part, without prior written consent of Renesas Electronics.
12. Please contact a Renesas Electronics sales office if you have any questions regarding the information contained in this document or Renesas Electronics products, or if you have any other inquiries.
(Note 1) "Renesas Electronics" as used in this document means Renesas Electronics Corporation and also includes its majority-owned subsidiaries.
(Note 2) "Renesas Electronics product(s)" means any product developed or manufactured by or for Renesas Electronics.



SALES OFFICES

Renesas Electronics Corporation

<http://www.renesas.com>

Refer to "<http://www.renesas.com/>" for the latest and detailed information.

Renesas Electronics America Inc.
2880 Scott Boulevard Santa Clara, CA 95050-2554, U.S.A.
Tel: +1-408-588-6000, Fax: +1-408-588-6130

Renesas Electronics Canada Limited
1101 Nicholson Road, Newmarket, Ontario L3Y 9C3, Canada
Tel: +1-905-898-5441, Fax: +1-905-898-3220

Renesas Electronics Europe Limited
Dukes Meadow, Millboard Road, Bourne End, Buckinghamshire, SL8 5FH, U.K
Tel: +44-1628-585-100, Fax: +44-1628-585-900

Renesas Electronics Europe GmbH
Arcadiastrasse 10, 40472 Düsseldorf, Germany
Tel: +49-211-65030, Fax: +49-211-6503-1327

Renesas Electronics (China) Co., Ltd.
7th Floor, Quantum Plaza, No.27 ZhiChunLu Haidian District, Beijing 100083, P.R.China
Tel: +86-10-8235-1155, Fax: +86-10-8235-7679

Renesas Electronics (Shanghai) Co., Ltd.
Unit 204, 205, AZIA Center, No.1233 Lujiazui Ring Rd., Pudong District, Shanghai 200120, China
Tel: +86-21-5877-1818, Fax: +86-21-6887-7858 / -7898

Renesas Electronics Hong Kong Limited
Unit 1601-1613, 16/F., Tower 2, Grand Century Place, 193 Prince Edward Road West, Mongkok, Kowloon, Hong Kong
Tel: +852-2886-9318, Fax: +852 2886-9022/9044

Renesas Electronics Taiwan Co., Ltd.
13F, No. 363, Fu Shing North Road, Taipei, Taiwan
Tel: +886-2-8175-9600, Fax: +886 2-8175-9670

Renesas Electronics Singapore Pte. Ltd.
1 HarbourFront Avenue, #06-10, Keppel Bay Tower, Singapore 098632
Tel: +65-6213-0200, Fax: +65-6278-8001

Renesas Electronics Malaysia Sdn.Bhd.
Unit 906, Block B, Menara Amcorp, Amcorp Trade Centre, No. 18, Jin Persiaran Barat, 46050 Petaling Jaya, Selangor Darul Ehsan, Malaysia
Tel: +60-3-7955-9390, Fax: +60-3-7955-9510

Renesas Electronics Korea Co., Ltd.
11F., Samik Lavied' or Bldg., 720-2 Yeoksam-Dong, Kangnam-Ku, Seoul 135-080, Korea
Tel: +82-2-558-3737, Fax: +82-2-558-5141