ISL70100SEH and ISL73100SEH

SEE Test Report

Introduction

The intense proton and heavy ion environment encountered in space applications can cause a variety of Single Event Effects (SEE) in electronic circuitry, including Single Event Upset (SEU), Single Event Transient (SET), Single Event Functional Interrupt (SEFI), Single Event Latch-Up (SEL), Single Event Gate Rupture (SEGR), and Single Event Burnout (SEB). SEE can lead to system-level performance issues including disruption, degradation, and destruction. For predictable and reliable space system operation, individual electronic components should be characterized to determine their SEE response. This report discusses the results of SEE testing performed on the ISL70100SEH product. Because the ISL73100SEH is the same silicon die as the ISL70100SEH this report applies to both parts. The ISL70100SEH is hardness assurance tested to 100krad(Si) at high dose rate (50-300krad(Si)/s) and 75krad(Si) at low dose rate (0.01rad(Si)/s), whereas the ISL73100SEH is hardness assurance tested at only the low dose rate. The pair of products are collectively referred to as ISL7x100SEH in this report.

Product Description

The ISL7x100SEH are radiation hardened 40V current sense amplifiers built on the Renesas proprietary PR40 SOI process. These devices have a wide power supply range of 2.7V to 40V. The common-mode input range is independent of the supply voltage and extends from -0.3V to 40.0V, making them ideal to use in both high-side and low-side applications.

The ISL7x100SEH are transconductance amplifiers that monitor current through an external sense resistor and output a current proportional to the sensed voltage. The overall gain is adjustable with a single resistor from output to ground.

These amplifiers have extremely low input offset voltage and input bias currents, making them ideal for precision sensing applications. They have a bandwidth of 500kHz with a slew rate of 500 μ A/ μ s that make them useful for current feedback in telemetry applications. When the parts are powered down ($V_+ = V_- = 0V$), the sense pins (RS+, RS-) are high impedance to avoid loading the monitored circuit.

The ISL7x100SEH are available in a hermetically sealed 10 lead ceramic flat-pack package or die form, and they operate across the full military ambient temperature range of -55°C to +125°C.

The ISL7x100SEH samples tested for this report were from lot XHA0LB, wafer 01. The samples were packaged without lids to allow irradiation, and only room temperature testing of the parts was done. No burn-in stressing was done on the parts.

Related Literature

For a full list of related documents, visit our website:

- [ISL70100SEH](#), [ISL73100SEH](#) device pages

1. Test Objective

The testing was intended to find the limits of the supply and sense voltages for avoiding destructive single event effects (collectively called SEB) at a Linear Energy Transfer (LET) of 86MeV·cm²/mg (gold) and 43MeV·cm²/mg (silver). The SOI process in which the part is fabricated is inherently immune to SEL. In addition, testing was carried out to look for significant SET impacting the static output at LET of 86MeV·cm²/mg (gold), 43MeV·cm²/mg (silver), 20MeV·cm²/mg (copper), 8.5MeV·cm²/mg (argon), 2.7MeV·cm²/mg (neon), and 1.3MeV·cm²/mg (nitrogen).

2. Test Facility

Single event effects testing was done at the Texas A&M University (TAMU) Radiation Effects Facility of the Cyclotron Institute in College Station, Texas. This facility is coupled to a K500 superconducting cyclotron that is capable of supplying a wide range of ion species and flux. The bulk of the testing referred to here was done November 19-22, 2019, while some additional testing was done April 8, 2020.

3. Test Set-Up

The schematic for SEE testing is shown in [Figure 1](#).

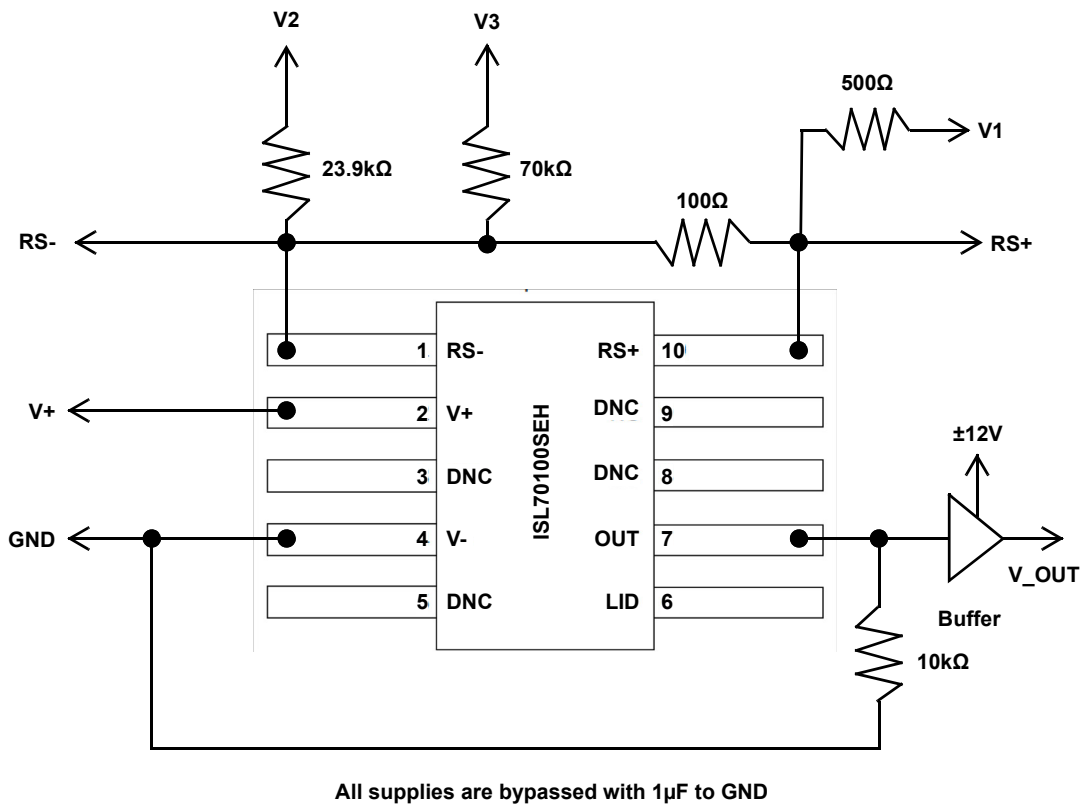

Figure 1. Schematic of the SEE Testing Arrangement for the ISL7x100SEH

For damaging single events (collectively called SEB) the inputs RS+ and V+ had a test voltage, VTEST, applied while V1 and V2 were left open, and V3 along with V- were grounded. This imposed approximately 50mV across the input RS+ to RS- (at VTEST = 35V). This led to a nominal output of 1V. Three parameters were monitored for changes indicative of irradiation damage. The currents into both RS+ and V+ (I_RS+ and I_V+), were measured before and after irradiation with ±10% change used as the damage criterion. Also, the output voltage (V_OUT) was monitored for change, and a ±2% damage criterion was used. Each irradiation was to 1x10⁷ion/cm² at approximately 5x10⁴ion/(cm²·s) using either gold ions for a LET of 86MeV·cm²/mg or silver ions for 43MeV·cm²/mg. The case temperature was maintained at 125°C with a thin film heater on the back of the PCB, and the ions had a normal incidence to the die surface.

For SET testing, the schematic was configured to impose a differential voltage across RS+ and RS- of approximately 50mV to yield a nominal output of 1V. The set of configurations are presented in [Table 1](#). The output, V_OUT, was monitored during irradiation by an oscilloscope using a $\pm 50\text{mV}$ deviation trigger and storing the captures over a time frame from $40\mu\text{s}$ before trigger to $160\mu\text{s}$ after trigger. These captured SET traces were available for post processing using MATLAB® routines. The digital processing routine applied a 51-point Gaussian convolution filter with the 4ns sample time to reduce high-frequency environmental noise. The SET irradiations were done at a case temperature of approximately 25°C to a maximum of $1 \times 10^7 \text{ion/cm}^2$ for each condition. The irradiation ions always had a normal incidence to the die surface.

Table 1. Single Event Transient Testing Configurations Used

| | V+ (V) | RS+ (V) | RS- (V) | V1 (V) | V2 (V) | V3 (V) | (RS+)-(RS-) | V_OUT (V) |
|--------|--------|---------|---------|--------|--------|--------|-----------------------|---------------|
| Case 1 | 2.7 | Open | -0.3 | 0 | Open | Open | $\approx 50\text{mV}$ | ≈ 1.0 |
| Case 2 | 35 | Open | -0.3 | 0 | Open | Open | $\approx 50\text{mV}$ | ≈ 1.0 |
| Case 3 | 12 | 12 | Open | Open | 0 | Open | $\approx 50\text{mV}$ | ≈ 1.0 |
| Case 4 | 2.7 | 35 | Open | Open | Open | 0 | $\approx 50\text{mV}$ | ≈ 1.0 |
| Case 5 | 35 | 35 | Open | Open | Open | 0 | $\approx 50\text{mV}$ | ≈ 1.0 |

4. SEB/L Testing Results at $86\text{MeV}\cdot\text{cm}^2/\text{mg}$ and $43\text{MeV}\cdot\text{cm}^2/\text{mg}$

SEB and SEL testing started with a normal incidence of gold irradiation by testing the first two parts (DUT1 and DUT2) at a test voltage starting at 34V and proceeding in 1V increments until a failure or 38V at the fifth irradiations. Each irradiation to $1 \times 10^7 \text{ion/cm}^2$ at gold accounted for approximately 13.8krad(Si) of Total Ionizing Dose (TID) so that the maximum five irradiations represent 68.8krad(Si) of TID. Subsequent parts were tested starting at 2V below the lowest failing voltage for previous DUTs and proceeding with 1V increments until either a failure or five irradiations. Testing at silver ($43\text{MeV}\cdot\text{cm}^2/\text{mg}$) began at 38V and again proceeded in 1V increments up to 42V.

A graphical summary of the SEB/L testing results is presented in [Figure 2](#). The details of the final and penultimate irradiation runs are presented in [Table 2](#). The failure criteria that determined the categorization depicted in [Figure 2](#) can be found in [Table 2](#). The species of irradiation had a profound impact on the SEB survival voltage. With gold, the survival voltage was 35V (four DUTs survived to this level). With silver, all four units survived 42V. The last two parts tested with Ag (#21 & #22) were done during the April 8, 2020 testing because in the earlier testing only two parts had been run up to 42V with Ag.

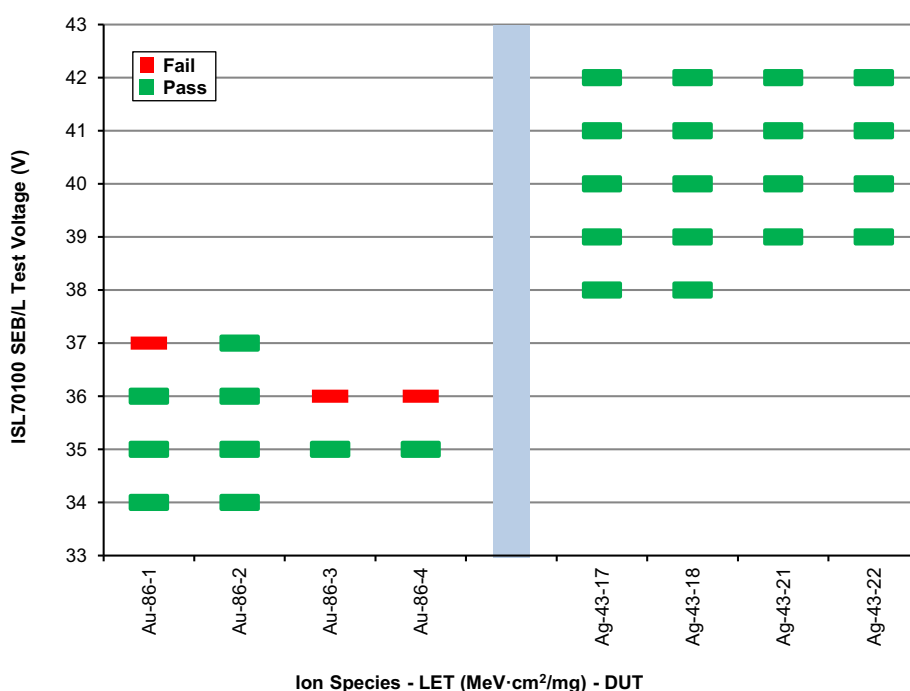

Figure 2. Graphical representation of the SEB testing results for normal incidence with both gold (Au, 86MeV·cm²/mg) and silver (Ag, 43MeV·cm²/mg). Failures were determined by pre to post changes of more than ±10% for I_{V+} and I_{RS+} and more than ±2% for V_{OUT}.

Table 2. Results of the last two SEB irradiation runs of 1x10⁷ion/cm² with normal incidence species of gold (86MeV·cm²/mg) and silver (43MeV·cm²/mg) and at case temperature of 125°C ±10°C. (Note 1)

| DUT | VTEST (V+ & RS+) | I _{V+} (±10%) | | I _{RS+} (±10%) | | V _{OUT} (±2%) | |
|----------|------------------|------------------------|-----------|-------------------------|-----------|------------------------|-----------|
| | | Pre (µA) | Post (µA) | Pre (µA) | Post (µA) | Pre (mV) | Post (mV) |
| Au-86-1 | 36 | 534 | 534 | 548 | 548 | 1040 | 1040 |
| | 37 | 534 | 312 | 548 | >1000 | 1040 | 220 |
| Au-86-2 | 36 | 534 | 532 | 547 | 547 | 1040 | 1040 |
| | 37 | 534 | 531 | 547 | 547 | 1040 | 1040 |
| Au-86-3 | 35 | 518 | 515 | 541 | 542 | 1050 | 1050 |
| | 36 | 525 | 297 | 542 | >1000 | 1050 | 31 |
| Au-86-4 | 35 | 537 | 535 | 548 | 548 | 1060 | 1060 |
| | 36 | 535 | 360 | 548 | 562 | 1060 | 32 |
| Ag-43-17 | 41 | 575 | 574 | 621 | 621 | 1210 | 1210 |
| | 42 | 589 | 588 | 651 | 651 | 1267 | 1267 |
| Ag-43-18 | 41 | 562 | 561 | 620 | 620 | 1203 | 1203 |
| | 42 | 576 | 574 | 650 | 650 | 1259 | 1259 |
| Ag-43-21 | 41 | 586 | 589 | 640 | 647 | 1785 | 1790 |
| | 42 | 595 | 592 | 659 | 654 | 1794 | 1791 |
| Ag-43-22 | 41 | 577 | 577 | 634 | 634 | 1781 | 1795 |
| | 42 | 584 | 583 | 648 | 648 | 1800 | 1789 |

Note:

1. Highlighted cells failed the change criterion at the top of the columns.

The supply current (I_{V+}) was monitored and logged with digital current meters during the SEB/L irradiations. [Figure 3](#) shows the supply currents during the 35V tests of DUTs 1-4 with normal incidence gold ($86\text{MeV}\cdot\text{cm}^2/\text{mg}$). The currents experienced a maximum spike of about $120\mu\text{A}$ (on a base of about 0.5mA) during the irradiations. There were no events indicative of SEL, and none of the spikes were prolonged beyond a single current sample. [Figure 4](#) shows the supply current for irradiation with normal incidence silver ($43\text{MeV}\cdot\text{cm}^2/\text{mg}$) at 42V. For both [Figure 3](#) and [Figure 4](#) the current data begins and ends with about 10s without irradiation.

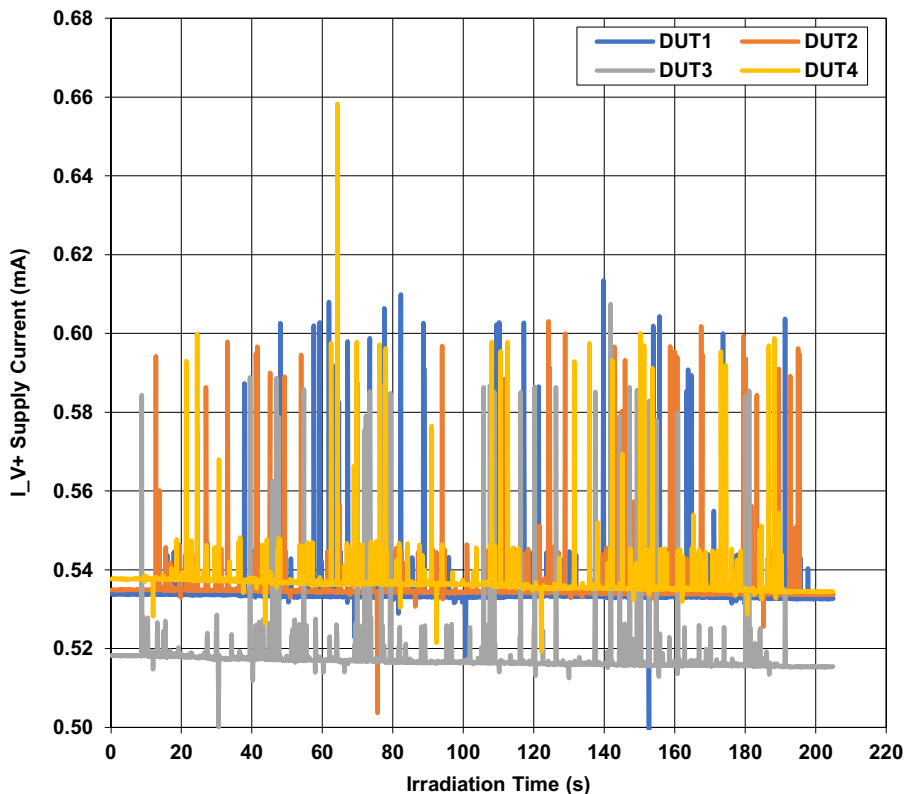

Figure 3. Supply Current (I_{V+}) During 35V SEB Runs with Normal Incidence Gold ($86\text{MeV}\cdot\text{cm}^2/\text{mg}$)

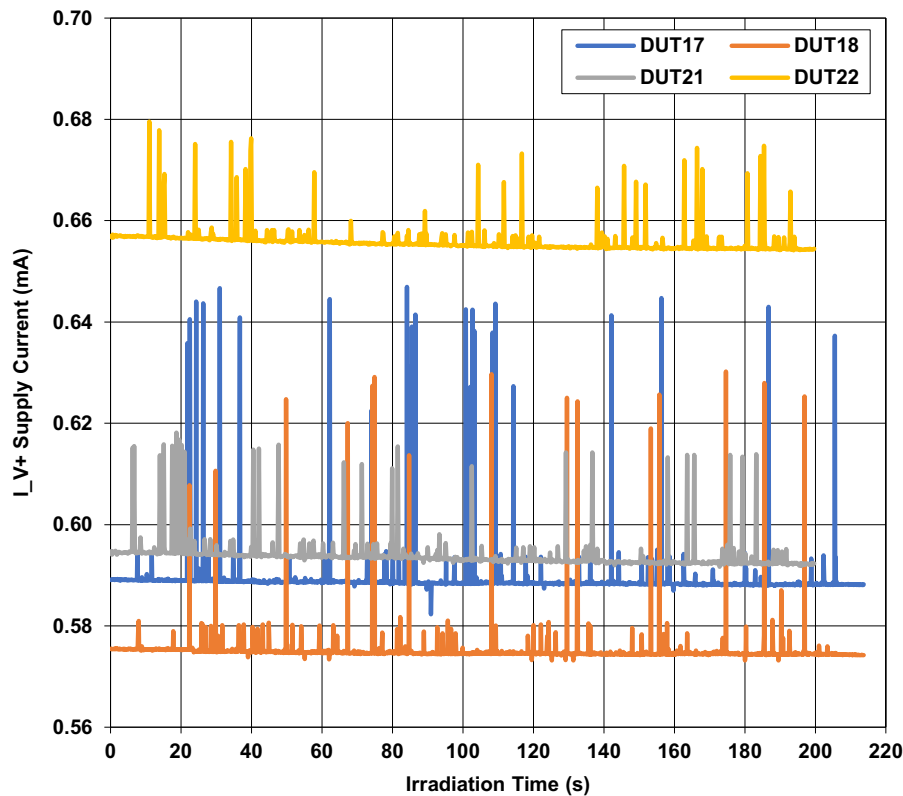

Figure 4. Supply Current (I_{V+}) During 42V SEB Runs with Normal Incidence Silver ($43\text{MeV}\cdot\text{cm}^2/\text{mg}$)

The SEB/L testing results support the conclusion that the ISL7x100SEH at 35V for both V+ and RS+ are immune to SEL and SEB for irradiation with normal incidence gold ($86\text{MeV}\cdot\text{cm}^2/\text{mg}$) and with a case temperature of $125^\circ\text{C} \pm 10^\circ\text{C}$. The voltage limitation is higher with at least 42V with normal incidence silver ($43\text{MeV}\cdot\text{cm}^2/\text{mg}$).

5. Testing Results for SET

SET testing consisted of first running four parts at LET $86\text{MeV}\cdot\text{cm}^2/\text{mg}$ (gold). Testing was also done on another set of four parts at LET of $43\text{MeV}\cdot\text{cm}^2/\text{mg}$ (silver). Finally, the third set of parts was run at $20\text{MeV}\cdot\text{cm}^2/\text{mg}$ (copper), $8.5\text{MeV}\cdot\text{cm}^2/\text{mg}$ (argon), and $2.7\text{MeV}\cdot\text{cm}^2/\text{mg}$ (neon). On a second trip to TAMU on April 8, 2020, four fresh parts were tested for SET at $1.3\text{MeV}\cdot\text{cm}^2/\text{mg}$ (nitrogen). Parts were tested in pairs at the five operating conditions as described in [Table 1](#). Although four parts at each of the five conditions were attempted, some parts were inadvertently damaged during bias condition changes, and this resulted in fewer than the four parts at five conditions being tested.

The SET captures were made with an oscilloscope triggering at $\pm 50\text{mV}$ deviations of V_OUT (nominal 1V). The oscilloscope captured and stored the SET waveforms for later analysis. The capture window on the first channel was set to 50mV per division ($\pm 200\text{mV}$ deviation range), and the time frame was set to start 40 μs before the trigger event and capture to 160 μs after the trigger event. A second channel was set to simultaneously capture V_OUT in the range -5V to +35V. This ensured that large events would be captured under any of the bias conditions. Irradiation runs were terminated once approximately 1000 SET were captured or when fluence reached $1 \times 10^7 \text{ion}/\text{cm}^2$, and the accumulated fluence was recorded. All irradiations were done with normal incidence ions.

There were 106 irradiation runs completed for which 101,336 SET traces were captured. Any analysis of these SET must be statistically based. However, it is instructive to at least look at a sample of the SET waveforms. Toward this end [Figure 5](#), [Figure 6](#), and [Figure 7](#) are offered. [Figure 5](#) shows a composite plot of the 20 longest duration SET for DUT5 irradiated with gold ($86\text{MeV}\cdot\text{cm}^2/\text{mg}$) while in biasing case 1. Because of the limited supply (2.7V), the positive deviations were limited to about 800mV. The negative deviations could go from the nominal 1V output to ground, and so these deviations reached about -1V. [Figure 6](#) shows a composite plot of the 20 longest duration SET for DUT5 irradiated with gold ($86\text{MeV}\cdot\text{cm}^2/\text{mg}$) while in biasing case 3. The 12V supply

allowed the positive deviations to reach about +10V. Again, the negative deviations ranged to about -1V because of the nominal output of 1V.

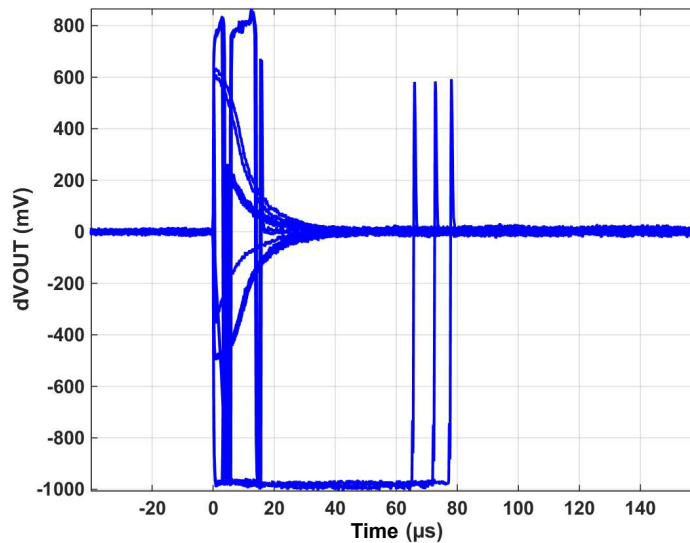

Figure 5. Composite of the 20 longest SET deviations captured for DUT5, Case 1, at 86MeV·cm²/mg. The total number of ±50mV SET captured in this run was 1,051.

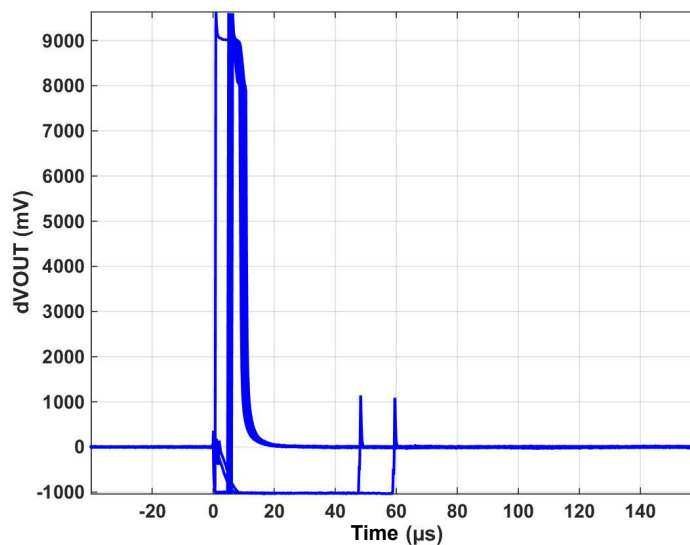

Figure 6. Composite of the 20 longest SET deviations captured for DUT5, Case 3, at 86MeV·cm²/mg. The total number of ±50mV SET captured in this run was 993.

The high supply bias conditions (35V for cases 2 and 5) yielded SET forms like [Figure 6](#) with positive deviations topping out at about +10V. The extra supply voltage did not appreciably add to the positive deviation magnitude as compared to the 12V supply. The waveforms seen for case 4 (2.7V supply) were generally like those for case 1 ([Figure 5](#)).

The magnitude and duration of the SET were reduced at irradiation by nitrogen, but the significant SET did not disappear. An example of the SET with nitrogen is provided by [Figure 7](#). The magnitudes were limited to about +850mV and -350mV, well shy of the limits seen with gold irradiation. Also, there were no prolonged SET as there were with gold. The SET with nitrogen were spikes with a typical exponential decay recovery.

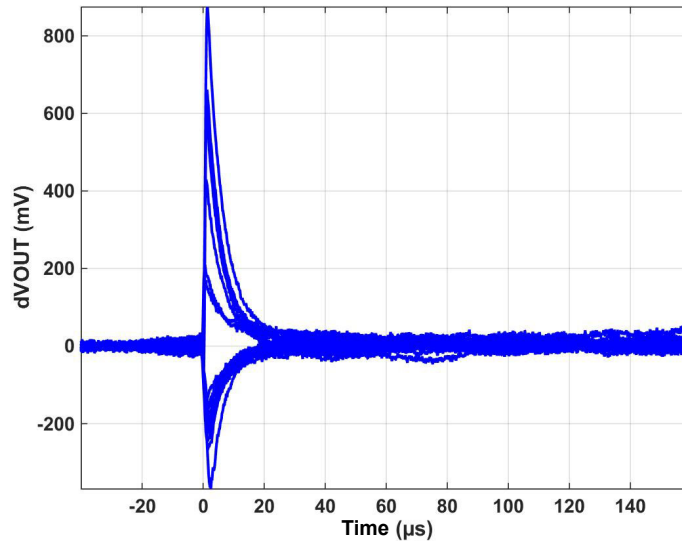

Figure 7. Composite of the 20 longest SET deviations captured for DUT23, Case 3, at 1.3MeV·cm²/mg. The total number of ±50mV SET captured in this run was 109.

The ±50mV SET count and fluence data was used to calculate the raw cross-section for each biasing case at each LET for each DUT. The data was combined to find the minimum, mean, and maximum cross-sections at each LET and bias condition. This data is graphically presented in [Figure 8](#).

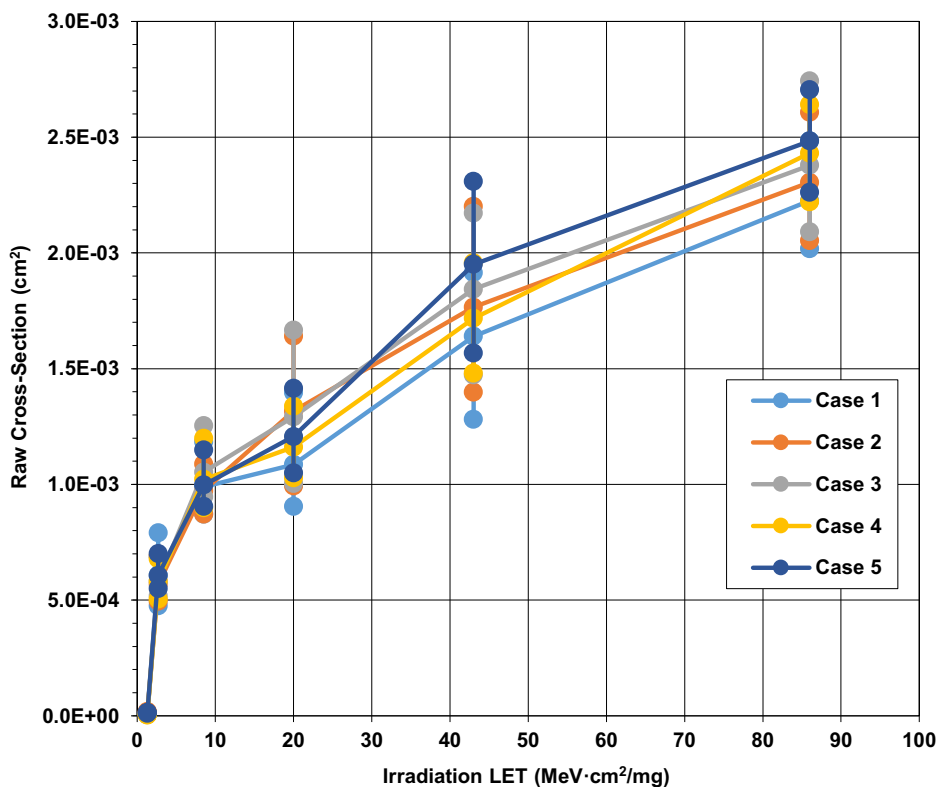

Figure 8. Raw ±50mV SET cross-sections against the irradiation LET at 25°C. Minimums and maximums are plotted and the means are connected.

Note: The raw cross-sections referenced here (run SET count divided by the run total fluence) are lower than actual values. During the event store operation of the oscilloscope, the oscilloscope is blind to further SET occurrences. This reduces the fluence over which the DUT was monitored for SET and so reduces the actual cross-section. An attempt to correct the cross-sections on a run-by-run basis led to unreasonable scatter in the results. However, taking the average correction impact on fluence resulted in a much cleaner factor of 2x the raw

cross-section. This factor is assumed for calculation of corrected cross-sections. This uniform application of a 2x factor over estimates the cross-sections at lower LET where the SET rate was reduced and so the correction would ideally be reduced, but the 2x factor provides a worst-case bound.

Although there is some minor difference between the cases as depicted in [Figure 8](#), the data for the various cases can be combined to simplify the worst-case results. This leads to the cross-section statistics as presented in [Table 3](#). There was a very strong fall off in the cross-sections seen at LET of 1.3MeV·cm²/mg with a decrease of over an order of magnitude when compared to the 2.7MeV·cm²/mg data.

Table 3. ±50mV SET Count and Worst-Case Cross-Section Statistics

| LET (MeV·cm ² /mg) | SET Count (Rad Runs) | Cross-Section (cm ²) | | | |
|-------------------------------|----------------------|----------------------------------|-----------------------|-----------------------|-----------------------|
| | | Minimum | Mean | Maximum | 2x Maximum |
| 86 | 19,607 (18) | 2.02x10 ⁻³ | 2.35x10 ⁻³ | 2.74x10 ⁻³ | 5.49x10 ⁻³ |
| 43 | 23,844 (20) | 1.28x10 ⁻³ | 1.78x10 ⁻³ | 2.31x10 ⁻³ | 4.62x10 ⁻³ |
| 20 | 22,099 (18) | 9.04x10 ⁻⁴ | 1.22x10 ⁻³ | 1.67x10 ⁻³ | 3.33x10 ⁻³ |
| 8.5 | 16,753 (15) | 8.72x10 ⁻⁴ | 1.01x10 ⁻³ | 1.25x10 ⁻³ | 2.51x10 ⁻³ |
| 2.7 | 17,107 (15) | 4.75x10 ⁻⁴ | 5.89x10 ⁻⁴ | 7.91x10 ⁻⁴ | 1.58x10 ⁻³ |
| 1.3 | 1,927 (20) | 3.40x10 ⁻⁶ | 9.64x10 ⁻⁶ | 1.88x10 ⁻⁵ | 3.76x10 ⁻⁵ |

The 2x maximum cross-sections in [Table 3](#) are plotted in [Figure 9](#) along with a bounding Weibull fit. The Weibull fitting was done to ensure that all data was below the fit line. This provides Weibull parameters for calculating the ±50mV event occurrence rates in orbit. The ±50mV trigger criterion corresponds to ±5µA of output current for the 10kΩ load resistor. This deviation is equivalent to an input change of 2.5mV for the transconductance of 2µA/mV.

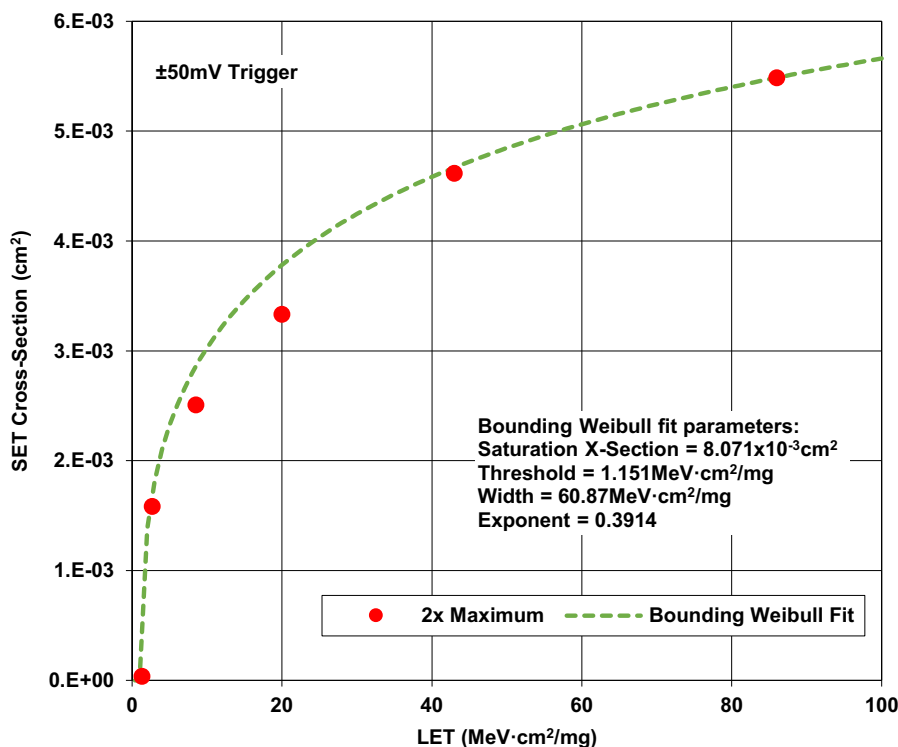

Figure 9. Corrected Maximum Cross-Sections of all ±50mV SET and Bounding Weibull Fit Versus LET

CRÈME96 simulation for Low Earth Orbit (LEO) with 100 mil Al shielding at average proton density leads to an expected 10.15 events per device day of at least ±50mV deviation. The CRÈME96 simulation for Geosynchronous Earth Orbit (GEO) results in an estimated 0.2200 events per device day. These ±50mV events must be tolerated by any in-orbit system using the ISL7x100SEH.

The SET represented in [Figure 8](#) can be analyzed by their duration outside of the $\pm 50\text{mV}$ window. The durations of the SET formed two distinct populations. The most common, better than 99.5%, were of durations less than $30\mu\text{s}$. The much rarer events exhibited longer durations in the range of $30\text{-}80\mu\text{s}$. [Figure 10](#) represents this bimodal behavior by plotting the SET duration against the proportion of SET with duration equal to or longer for irradiation with gold ($86\text{MeV}\cdot\text{cm}^2/\text{mg}$). This highlights how rare the longer events were.

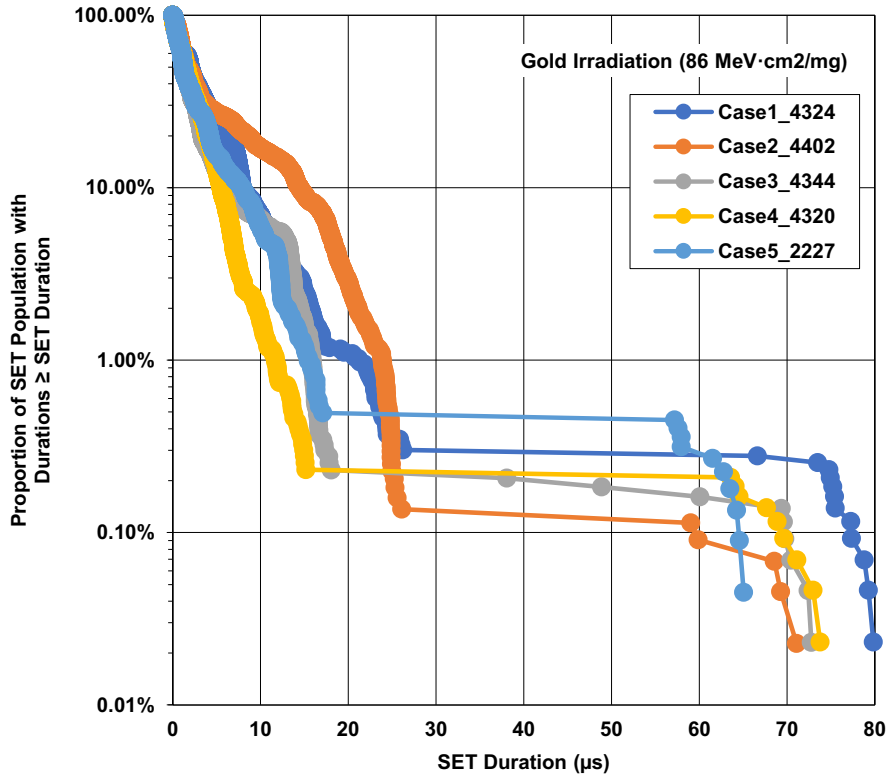

Figure 10. Composite SET duration distribution for irradiation with normal incidence gold ($86\text{MeV}\cdot\text{cm}^2/\text{mg}$) for approximately 1,000 SET per irradiation run. Trigger was $\pm 50\text{mV}$, and the number after the case identifier in the legend is the total SET count for that case.

The same SET duration analysis as represented in [Figure 10](#) was done for the other LET. [Figure 11](#) shows the results for the nitrogen ($1.3\text{MeV}\cdot\text{cm}^2/\text{mg}$) irradiations.

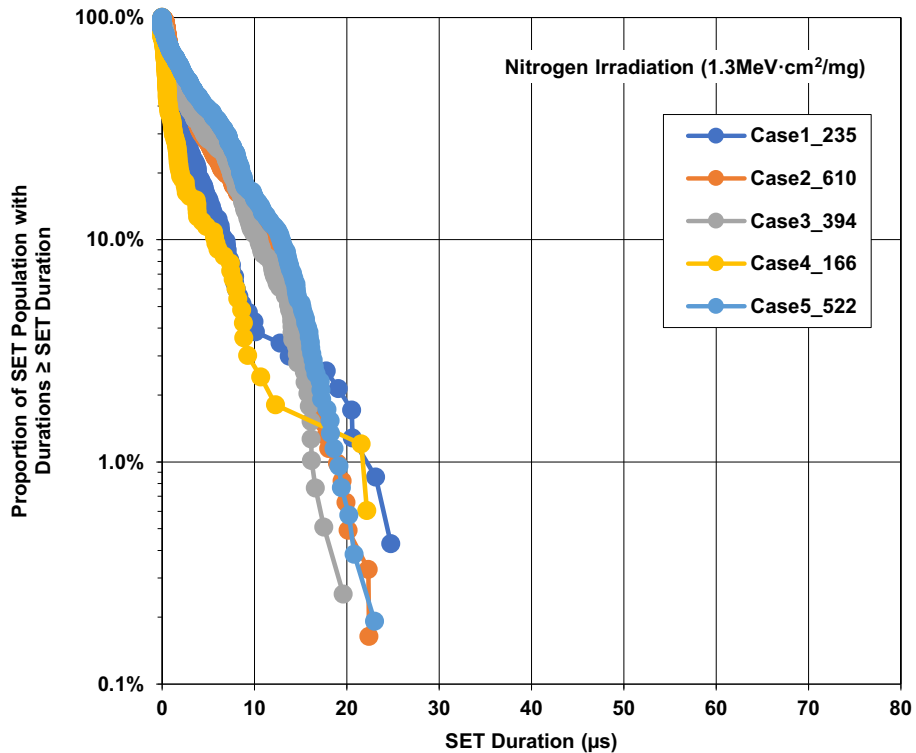

Figure 11. Composite SET duration distribution for irradiation with normal incidence nitrogen (1.3MeV·cm²/mg). Each case represents four parts with 1x10⁷ion/cm² each. Trigger was ±50mV, and the number after the case identifier in the legend is the total SET count for that case.

The captured SET data was processed with MATLAB® to count only those SET with durations (deviations outside of the ±50mV window) longer than 30µs. The 2x corrected maximum cross-sections for the ±50mV SET were multiplied by the ratio of the SET count with durations greater than 30µs to the total count of ±50mV SET. This yielded corrected maximum cross-sections for the ±50mV SET with durations greater than 30µs. This extracted cross-section data along with a bounding Weibull fit is presented in [Figure 12](#). Not only were these prolonged SET much rarer than the general ±50mV SET, but they exhibited a LET threshold of at least 2.7MeV·cm²/mg, as there were no SET of greater than 30µs duration counted for this LET or lower LET.

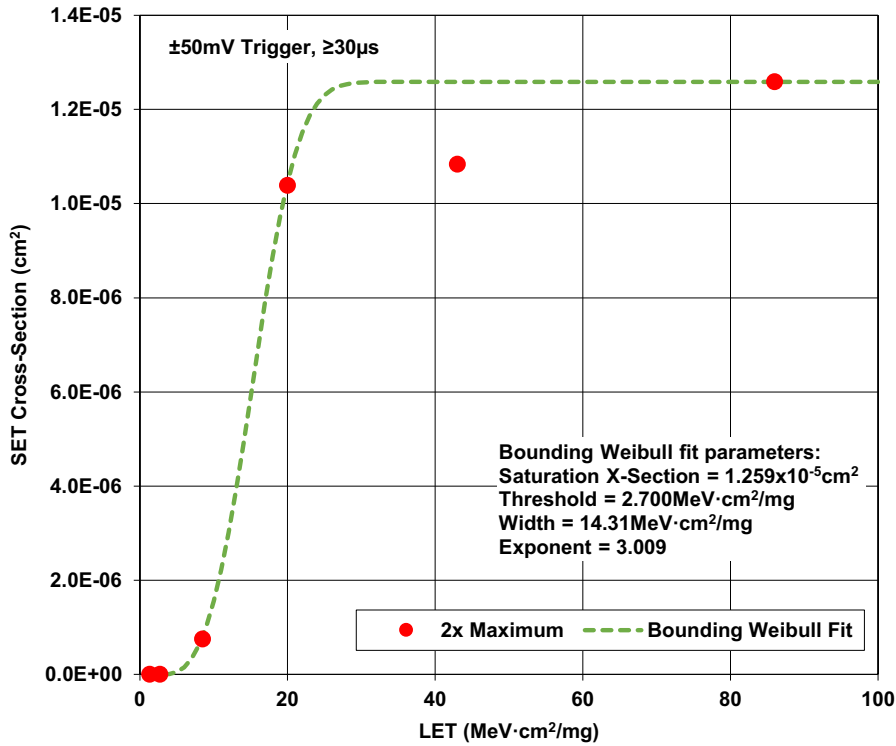

Figure 12. Corrected maximum cross-sections of ±50mV SET with duration greater than 30µs and bounding Weibull fit versus LET.

CRÈME96 simulation of these longer SET (>30µs) for LEO yield 2.85×10^{-2} events per device year. For GEO the events fall to 1.21×10^{-2} events per device year.

Another way to characterize the SET is to consider the extreme deviation of the SET. It is this analysis with respect to SET extreme deviation that is represented in [Figure 13](#) for gold irradiation. Because the nominal output was 1V, the extreme deviations for cases 1 and 4 (2.7V supply) were limited to 1V (0µA output). For the higher supply voltages used in cases 2, 3, and 5, the extreme deviations could go up to about 10V (about 1mA output). Although the trigger was ±50mV, fully 90% of the captured SET had extreme deviations of more than ±100mV. For the high supply cases (2, 3, 5), 60% of the SET had deviations of more than 500mV. For the low voltage cases (1, 4), 60% of the captures were more than 300mV deviations. Therefore, although the trigger was only ±50mV, most of the SET captured were considerably larger.

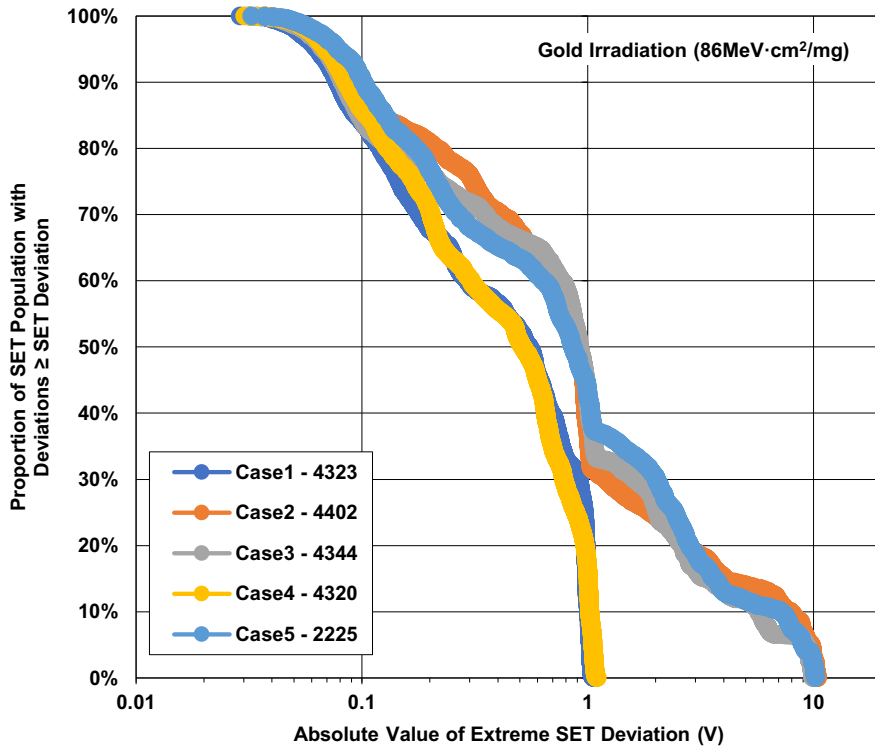

Figure 13. Composite SET deviation distribution for irradiation with normal incidence gold (86MeV·cm²/mg) for four parts with approximately 1,000 SET per irradiation run. Trigger was ±50mV, and the number after the case identifier in the legend is the total SET count for that case.

A similar SET deviation analysis for the case of nitrogen (1.3MeV·cm²/mg) irradiation is represented in Figure 14. Nearly 50% of the captured ±50mV SET had extreme deviations of greater than 100mV. Deviations of 1V or more were limited to well less than 5% of the total captures.

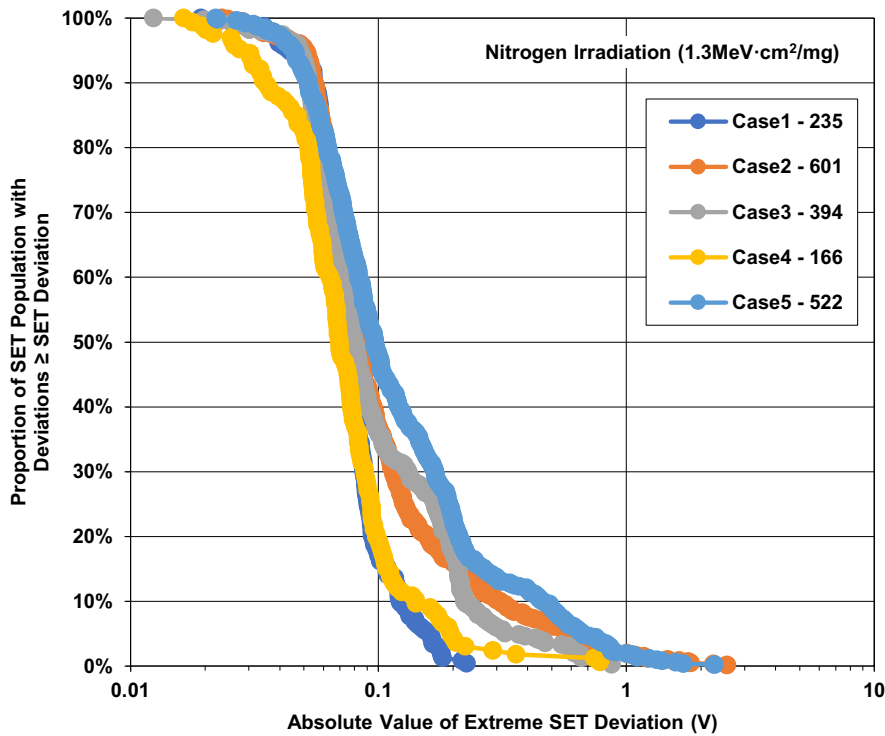

Figure 14. Composite SET deviation distribution for irradiation with normal incidence nitrogen (1.3MeV·cm²/mg) for four parts with 1x10⁷ion/cm² per irradiation run. Trigger was ±50mV, and the number after the case identifier in the legend is the total SET count for that case.

6. Discussion and Conclusions

SEB and SEL testing supports the conclusion that the ISL7x100SEH can survive environments with normal incidence gold ions for $86\text{MeV}\cdot\text{cm}^2/\text{mg}$ to $1\times 10^7\text{ion}/\text{cm}^2$ at biases of $RS+ = V+ = 35\text{V}$ while at $125^\circ\text{C} \pm 10^\circ\text{C}$ case temperature. Four units passed SEB testing at 35V with gold irradiation. Two units failed at 36V with gold irradiation. With silver irradiation ($43\text{MeV}\cdot\text{cm}^2/\text{mg}$), four units passed at 42V. No signs of SEL were observed in any of the SEB tests. See [Figures 2, 3, and 4](#) for details. These results lead to the absolute maximum ratings of the supply at 42V without ion bombardment and 35V with ion bombardment.

SET testing indicated that the ISL7x100SEH is susceptible to $\pm 50\text{mV}$ ($\pm 5\mu\text{A}$) output SET down to $1.3\text{MeV}\cdot\text{cm}^2/\text{mg}$ (normal incidence nitrogen) with a cross-section of $3.76\times 10^{-5}\text{cm}^2$. The worst of these SET at nitrogen had a duration of less than $30\mu\text{s}$, as shown in [Figure 11](#). About 50% of the SET captured with nitrogen had deviation magnitudes of greater than 100mV ($10\mu\text{A}$), as shown in [Figure 14](#). With gold irradiation ($86\text{MeV}\cdot\text{cm}^2/\text{mg}$) the $\pm 50\text{mV}$ SET cross-section for the ISL7x100SEH was $5.49\times 10^{-3}\text{cm}^2$. Of those events, 0.5% were longer than $30\mu\text{s}$ ([Figure 10](#)), and about 85% were larger than 100mV ([Figure 13](#)).

CRÈME96 modeling for LEO with 100 mil Al shielding at average proton density leads to a predicted 10.15 events per device day of at least $\pm 50\text{mV}$ deviation. CRÈME96 simulation for GEO results in an estimated 0.220 events per device day for the $\pm 50\text{mV}$ events. If only events with a duration of greater than $30\mu\text{s}$ are considered, CRÈME96 simulation for LEO yield 0.0285 events per device year. For GEO the events fall to 0.0121 events per device year. These lower occurrences represent the impact of the LET threshold for events greater than $30\mu\text{s}$ being $2.7\text{MeV}\cdot\text{cm}^2/\text{mg}$.

Proper application of the ISL7x100SEH for in-orbit use must accommodate the SET. The most direct method of mitigation would be to filter the output with a capacitor across the output resistor. For example, a $0.1\mu\text{F}$ capacitor across the $10\text{k}\Omega$ load resistor ($RC = 1\text{ms}$) would limit the resultant SET from the 9V positive deviations for $10\mu\text{s}$ seen in [Figure 6](#) to 90mV. This same capacitor would limit the long ($80\mu\text{s}$) negative 1V SET ([Figure 5](#)) to about 77mV. Increasing the capacitor value would proportionally reduce the resultant SET further. This filter would, of course, significantly slow the circuit response to real changes at the input.

7. Revision History

| Rev. | Date | Description |
|------|----------|-----------------|
| 1.00 | May.5.20 | Initial release |

IMPORTANT NOTICE AND DISCLAIMER

RENESAS ELECTRONICS CORPORATION AND ITS SUBSIDIARIES (“RENESAS”) PROVIDES TECHNICAL SPECIFICATIONS AND RELIABILITY DATA (INCLUDING DATASHEETS), DESIGN RESOURCES (INCLUDING REFERENCE DESIGNS), APPLICATION OR OTHER DESIGN ADVICE, WEB TOOLS, SAFETY INFORMATION, AND OTHER RESOURCES “AS IS” AND WITH ALL FAULTS, AND DISCLAIMS ALL WARRANTIES, EXPRESS OR IMPLIED, INCLUDING, WITHOUT LIMITATION, ANY IMPLIED WARRANTIES OF MERCHANTABILITY, FITNESS FOR A PARTICULAR PURPOSE, OR NON-INFRINGEMENT OF THIRD PARTY INTELLECTUAL PROPERTY RIGHTS.

These resources are intended for developers skilled in the art designing with Renesas products. You are solely responsible for (1) selecting the appropriate products for your application, (2) designing, validating, and testing your application, and (3) ensuring your application meets applicable standards, and any other safety, security, or other requirements. These resources are subject to change without notice. Renesas grants you permission to use these resources only for development of an application that uses Renesas products. Other reproduction or use of these resources is strictly prohibited. No license is granted to any other Renesas intellectual property or to any third party intellectual property. Renesas disclaims responsibility for, and you will fully indemnify Renesas and its representatives against, any claims, damages, costs, losses, or liabilities arising out of your use of these resources. Renesas' products are provided only subject to Renesas' Terms and Conditions of Sale or other applicable terms agreed to in writing. No use of any Renesas resources expands or otherwise alters any applicable warranties or warranty disclaimers for these products.

(Rev.1.0 Mar 2020)

Corporate Headquarters

TOYOSU FORESIA, 3-2-24 Toyosu,
Koto-ku, Tokyo 135-0061, Japan
www.renesas.com

Contact Information

For further information on a product, technology, the most up-to-date version of a document, or your nearest sales office, please visit:
www.renesas.com/contact/

Trademarks

Renesas and the Renesas logo are trademarks of Renesas Electronics Corporation. All trademarks and registered trademarks are the property of their respective owners.