

Product Change Notice (PCN)

Subject: Part Marking Change for the Listed QML Products

Publication Date: 4/27/2018

Effective Date: 4/27/2018 Manufacturing lots starting with the date code 1817

Revision Description:

Initial Release

Description of Change:

The marking for the products listed below will be changed (per appendix A). As space permits either the Renesas Electronics America Inc cage code (34371) or the registered trademark “i” will be marked on the product.

Vendor Part Number	SMD Part Number
ISL70040SEHVL	5962R1723301VXC
ISL70321SEHVF	5962R1722501VXC
ISL71590SEHVF	5962F1321501VXC
ISL72813SEHVL	5962R1720801VXA
ISL73040SEHVL	5962L1723302VXC
ISL73051ASEHVF	5962L1121204VXC

Vendor Part Number	SMD Part Number
ISL73051ASEHVFE	5962L1121204VYC
ISL73321SEHVF	5962L1722502VXC
ISL73590SEHVF	5962L1321502VXC
ISL75051ASEHVF	5962R1121203VXC
ISL75051ASEHVFE	5962R1121203VYC

Reason for Change:

Per MIL-PRF-38535 paragraph 3.6 “d” “Manufacturer’s identification (see 3.6.4)”. The microcircuits shall, as a minimum identify the manufacturer by the marking of name or Trademark of the manufacturer or the manufacturer may also mark the manufacturer's Commercial and Government Entity (CAGE) code.

Impact on fit, form, function, quality & reliability:

The change is to the product marking only and will have no other impact on the form, fit, function, quality, reliability and environmental compliance of the devices. The change to the marking will be effective starting with material date code 1817. **Product produced prior to date code 1817 will not be remarked.**

Product Identification:

Product affected by this change is identifiable via Renesas Electronic America’s internal traceability system.

Qualification status: No qualification required, marking change only

Device material declaration: Available upon request

Questions or requests pertaining to this change notice, including additional data or samples, must be sent to Intersil within 30 days of the publication date.

For additional information regarding this notice, please contact your regional change coordinator (below)			
Americas: US@renesas.com	Europe: EU@Renesas.com	Japan: Jp@Renesas.com	Asia Pac: APAC@Renesas.com

Appendix A – Marking Changes

1. ISL70040SEHVL GanFET Low Side Driver

Before

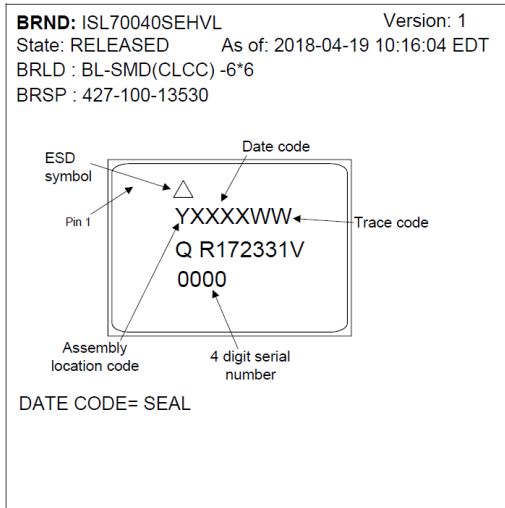

After

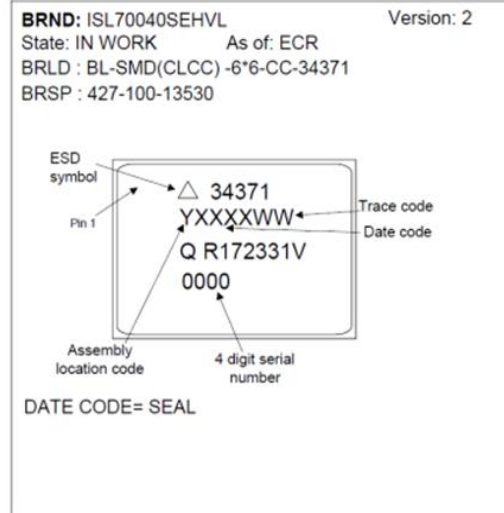

2. ISL73040SEHVL GanFET Low Side Driver

Before

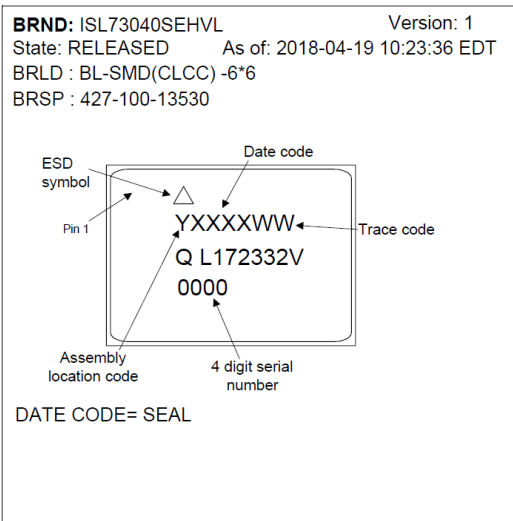

After

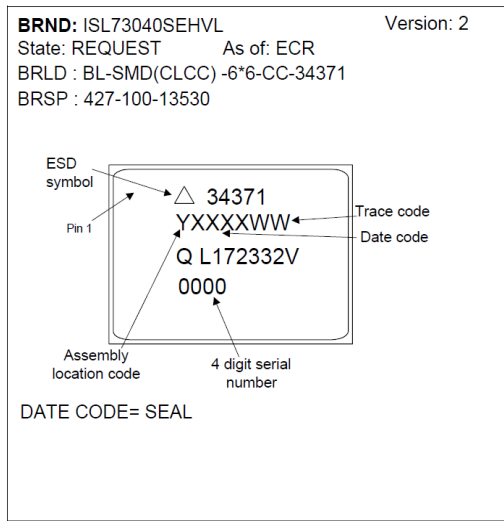

3. ISL75051ASEHVF 5V LDO

Before



After



4. ISL75051ASEHVFE 5V LDO

Before



After



5. ISL73051ASEHVF 5V LDO

Before



After

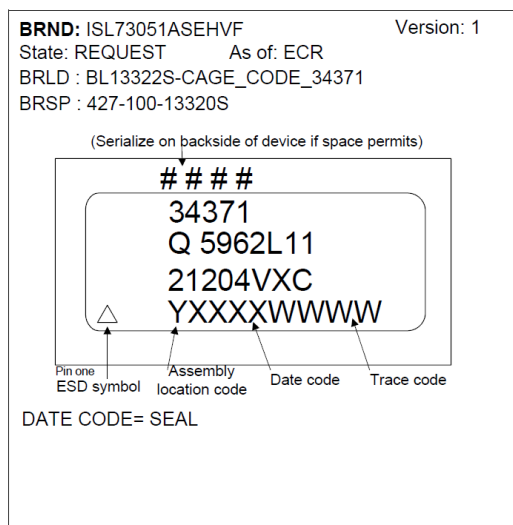

6. ISL73051ASEHVFE 5V LDO

Before



After

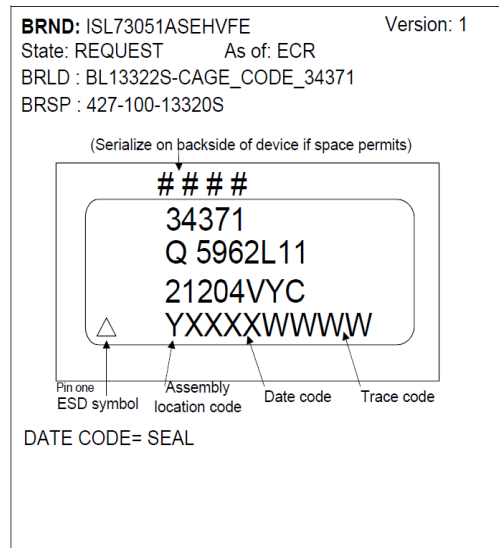

7. ISL73321SEHVF Quad Sequencer

Before

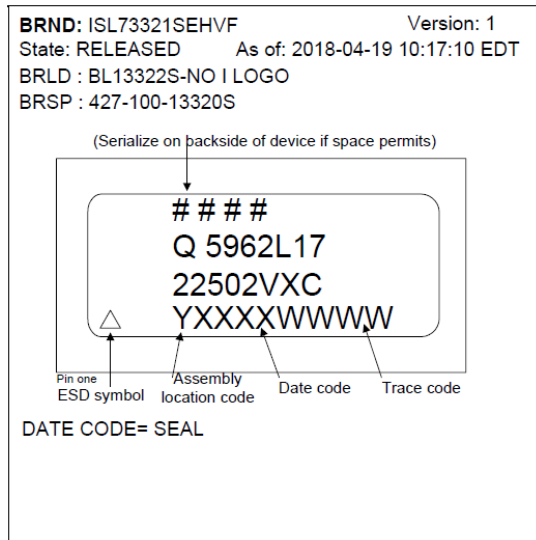

After

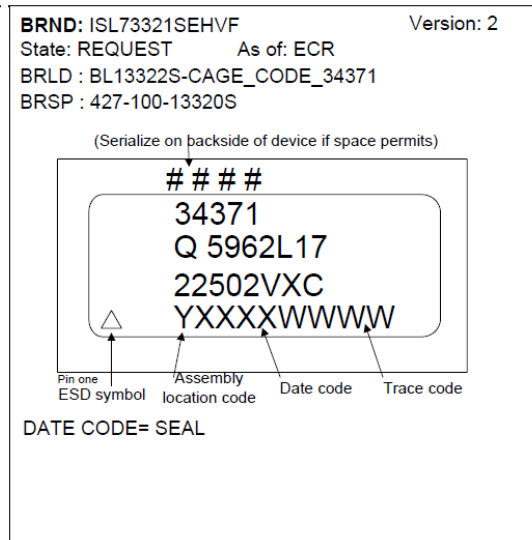

8. ISL70321SEHVF Quad Sequencer

Before

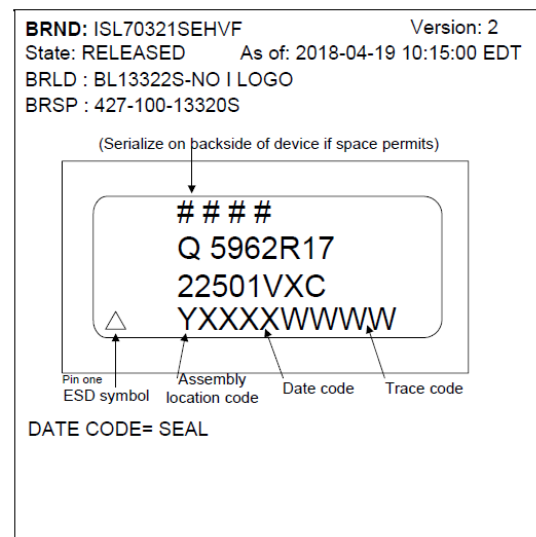

After



9. ISL72813SEHVL Current Driver

Before

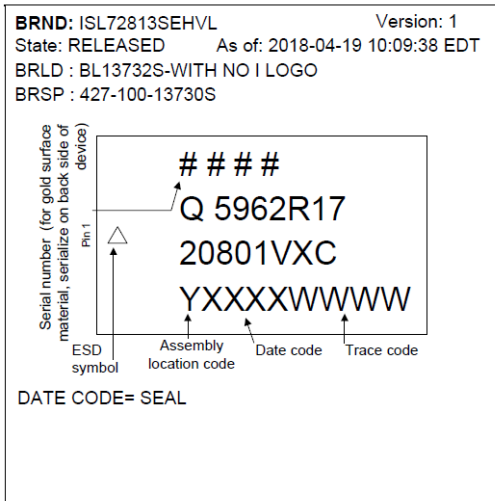

After

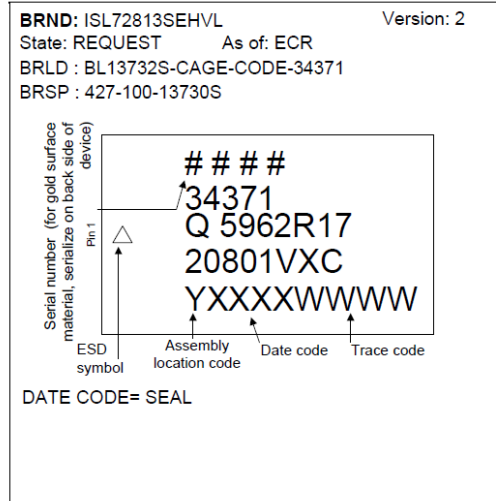

10. ISL71590SEHVF Temperature Sensor

Before

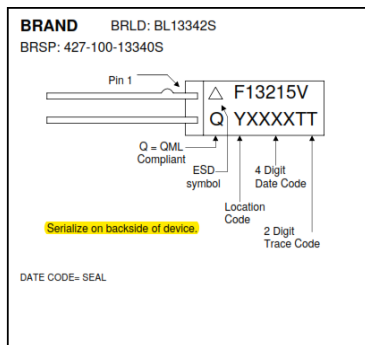

After: (logo will be on the backside with the serial number)

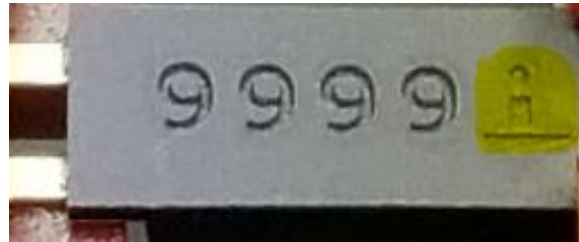

11. ISL73590SEHVF Temperature Sensor

Before

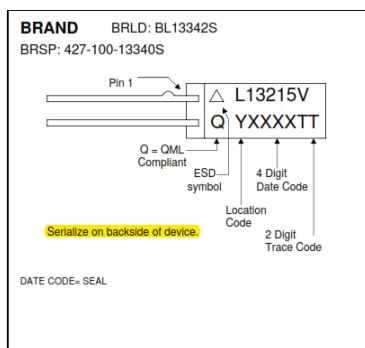

After: (logo will be on the backside with the serial number)

