

ISL85415DEMO1Z

Wide VIN 500mA Synchronous Buck Regulator

AN1860
Rev 2.00
May 16, 2014

Description

The ISL85415DEMO1Z kit is intended for use for point-of-load applications sourcing from 3V to 36V. The kit is used to demonstrate the performance of the ISL85415 Wide VIN Low Quiescent Current High Efficiency Sync Buck Regulator with 500mA output current.

The ISL85415 is offered in a 4mmx3mm 12 Ld DFN package with 1mm maximum height. The converter occupies 1.516 cm² area.

Key Features

- Wide input voltage range 3V to 36V
- Synchronous operation for high efficiency
- No compensation required
- Integrated high-side and low-side NMOS devices
- Selectable PFM or forced PWM mode at light loads
- Internal fixed (500kHz) or adjustable switching frequency 300kHz to 2MHz
- Continuous output current up to 500mA
- Internal or external soft-start
- Minimal external components required
- Power-good and enable functions available

Recommended Equipment

The following materials are recommended to perform testing:

- 0V to 50V power supply with at least 2A source current capability
- Electronic Loads capable of sinking current up to 1.5A
- Digital multimeters (DMMs)
- 100MHz quad-trace oscilloscope
- Signal generator

Quick Setup Guide

1. Ensure that the circuit is correctly connected to the supply and loads prior to applying any power.
2. Connect the bias supply to VIN, the plus terminal to VIN (P4) and the negative return to GND (P5).
3. Turn on the power supply.
4. Verify the output voltage is 3.3V for V_{OUT}.

Evaluating the Other Output Voltage

The ISL85415DEMO1Z kit output is preset to 3.3V; however, output voltages can be adjusted from 0.6V to 15V. The output voltage programming resistor, R₂, will depend on the desired output voltage of the regulator and the value of the feedback resistor R₁, as shown in [Equation 1](#).

$$R_2 = R_1 \left(\frac{0.6}{V_{OUT} - 0.6} \right) \quad (\text{EQ. 1})$$

If the output voltage desired is 0.6V, then R₁ is shorted. Please note that if V_{OUT} is less than 1.8V, the switching frequency and compensation must be changed for 300kHz operation due to minimum on-time limitation. Please refer to datasheet [ISL85415](#) for further information.

[Table 1](#) on [page 2](#) shows the component selection that should be used for the respective V_{OUTs}.



FIGURE 1. FRONT OF EVALUATION BOARD ISL85415DEMO1Z



FIGURE 2. BACK OF EVALUATION BOARD ISL85415DEMO1Z

TABLE 1. EXTERNAL COMPONENT SELECTION

V _{OUT} (V)	L ₁ (μH)	C _{OUT} (μF)	R ₁ (kΩ)	R ₂ (kΩ)	C _{FB} (pF)	R _{FS} (kΩ)	R _{COMP} (kΩ)	C _{COMP} (pF)
12	45	10	90.9	4.75	22	115	100	470
5	22	2x22	90.9	12.4	100	120	100	470
3.3	22	2x22	90.9	20	100	120	100	470
2.5	22	2x22	90.9	28.7	100	120	100	470
1.8	22	22	100	50	22	120	50	470

Frequency Control

The ISL85415 has an FS pin that controls the frequency of operation. Programmable frequency allows for optimization between efficiency and external component size. It also allows low frequency operation for low V_{OUTS} when minimum on time would limit the operation otherwise. Default switching frequency is 500kHz when FS is tied to V_{CC} (R₁₀ = 0). By removing R₁₀ the switching frequency could be changed from 300kHz (R₁₂ = 340k) to 2MHz (R₁₂ = 32.4k). Please refer to datasheet [ISL85415](#) for calculating the value of R₁₀. Do not leave this pin floating.

Disabling/Enabling Function

ISL85415DEMO1Z board has EN pin tied to VCC via R7. This keeps the part enabled all the time. To disable the part, remove R7 and populate R8 with a 0Ω resistor.

SYNC Control

The ISL85415 evaluation board has a SYNC pin that allows external synchronization frequency to be applied. Default board configuration has R₆ = 200k to V_{CC}, which defaults to PWM operation mode and also to the pre-selected switching frequency set by R₁₂ (see datasheet and previous section "[Frequency Control](#)" for details). If this pin is tied to GND the IC will operate in PFM mode. For PFM operation, remove R₆ and populate R₉ with 0Ω resistor.

Soft-Start /COMP Control

R₁₅ selects between internal (R₁₅ = 0) and external soft-start. R₁₁ selects between internal (R₁₁ = 0) and external compensation. Please refer to Pin Description Table (Page 3) of the [ISL85415](#) datasheet.

ISL85415DEMO1Z Schematic

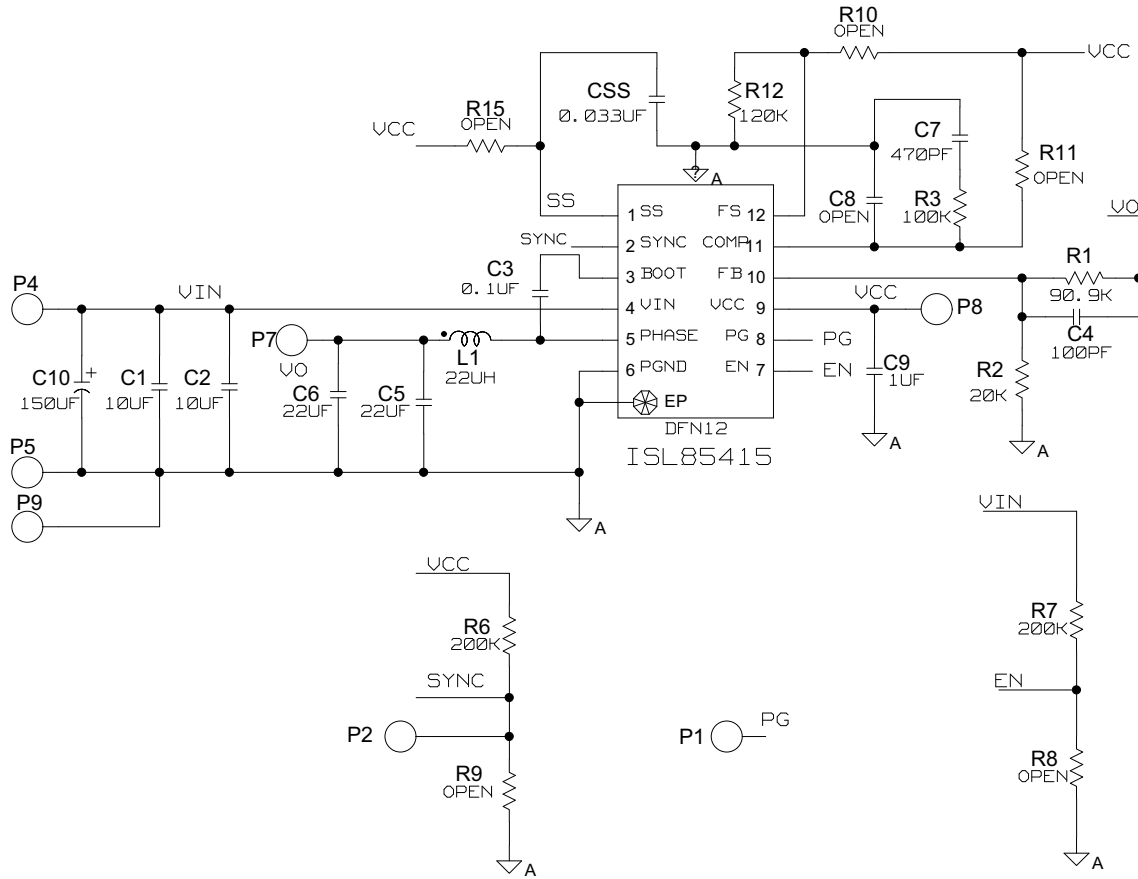

NOTE: If the IC is used in an application where the input test leads have large parasitic inductance, the input electrolytic capacitor C10 may be added to prevent transient voltages on the input pin.

ISL85415DEMO1Z Bill of Materials

PART NUMBER	QTY	UNIT	REFERENCE DESIGNATOR	DESCRIPTION	MANUFACTURER	MANUFACTURER PART
ISL85400EVAL2ZREVAPCB	1	ea	LABEL-RENAME BOARD	PWB-PCB, ISL85400EVAL2Z, REVA, ROHS	INTERSIL	ISL85400EVAL2ZREVAPCB
EEE-FK1H151P-T (DNP)	1	ea	C10 (OPTIONAL)	CAP, SMD, 10.3mm, 150µF, 50V, 20%, ROHS, ALUM.ELEC.	PANASONIC	EEE-FK1H151P
H1044-00101-50V5-T	1	ea	C4	CAP, SMD, 0402, 100pF, 50V, 5%, COG, ROHS	MURATA	GRM1555C1H101JZ01D
H1044-00333-16V10-T	1	ea	CSS	CAP, SMD, 0402, 33000pF, 16V, 10%, X7R, ROHS	MURATA	GRM36X7R333K016AQ
H1044-00471-50V10-T	1	ea	C7	CAP, SMD, 0402, 470pF, 50V, 10%, X7R, ROHS	PANASONIC	ECJ-0EB1H471K
H1044-DNP	0	ea	C8	CAP, SMD, 0402, DNP-PLACE HOLDER, ROHS		
H1045-00104-50V10-T	1	ea	C3	CAP, SMD, 0603, 0.1µF, 50V, 10%, X7R, ROHS	AVX	06035C104KAT2A
H1045-00105-16V10-T	1	ea	C9	CAP, SMD, 0603, 1µF, 16V, 10%, X5R, ROHS	MURATA	GRM188R61C105KA12D
H1065-00106-50V10-T	2	ea	C1, C2	CAP, SMD, 1206, 10µF, 50V, 10%, X5R, ROHS	TDK	C3216X5R1H106K
H1065-00226-6R3V10-T	2	ea	C5, C6	CAP, SMD, 1206, 22µF, 6.3V, 10%, X5R, ROHS	MURATA	GRM31CR60J226KE19L
74408943220	1	ea	L1	COIL-PWR INDUCTOR, SMD, 4.8mm, 22µH, 20%, 1.1A, ROHS	Würth Electronics	74408943220
5000	2	ea	P4, P7	CONN-MINI TEST PT, VERTICAL, RED, ROHS	KEYSTONE	5000
5001	2	ea	P5, P9	CONN-MINI TEST PT, VERTICAL, BLK, ROHS	KEYSTONE	5001
5002	2	ea	P1, P2	CONN-MINI TEST POINT, VERTICAL, WHITE, ROHS	KEYSTONE	5002
ISL85415FRZ	1	ea	U1	IC-500mA BUCK REGULATOR, 12P, DFN, 3x4, ROHS	INTERSIL	ISL85415FRZ
H2510-01003-1/16W1-T	1	ea	R3	RES, SMD, 0402, 100k, 1/16W, 1%, TF, ROHS	PANASONIC	ERJ2RKF1003
H2510-01203-1/16W1-T	1	ea	R12	RES, SMD, 0402, 120k, 1/16W, 1%, TF, ROHS	ROHM	MCR01MZPF1203
H2510-02002-1/16W1-T	1	ea	R2	RES, SMD, 0402, 20k, 1/16W, 1%, TF, ROHS	PANASONIC	ERJ2RKF2001
H2510-02003-1/16W1-T	2	ea	R6, R7	RES, SMD, 0402, 200k, 1/16W, 1%, TF, ROHS	ROHM	MCR01MZPF2003
H2510-09092-1/16W1-T	1	ea	R1	RES, SMD, 0402, 90.9k, 1/16W, 1%, TF, ROHS	VISHAY/DALE	CRCW040290K9FKED

ISL85415DEMO1Z Bill of Materials (Continued)

PART NUMBER	QTY	UNIT	REFERENCE DESIGNATOR	DESCRIPTION	MANUFACTURER	MANUFACTURER PART
H2510-DNP	0	ea	R8-R11, R15	RES, SMD, 0402, DNP, DNP, DNP, TF, ROHS		
2X3-STATIC-BAG	1	ea	PLACE ASSY IN BAG	BAG, STATIC, 2x3, ZIP LOC	TBD	S-6509
LABEL-DATE CODE	1	ea	AFFIX TO BACK OF PCB	LABEL-DATE CODE_BOM REV#_SERIAL# LABEL ON ZIL & QUEL	INTERSIL	LABEL-DATE CODE
LABEL-RENAME BOARD	1	ea	RENAME TOP PCB TO: ISL85415DEMO1Z	LABEL, TO RENAME BOARD	INTERSIL	LABEL-RENAME BOARD

ISL85415DEMO1Z Board Layout

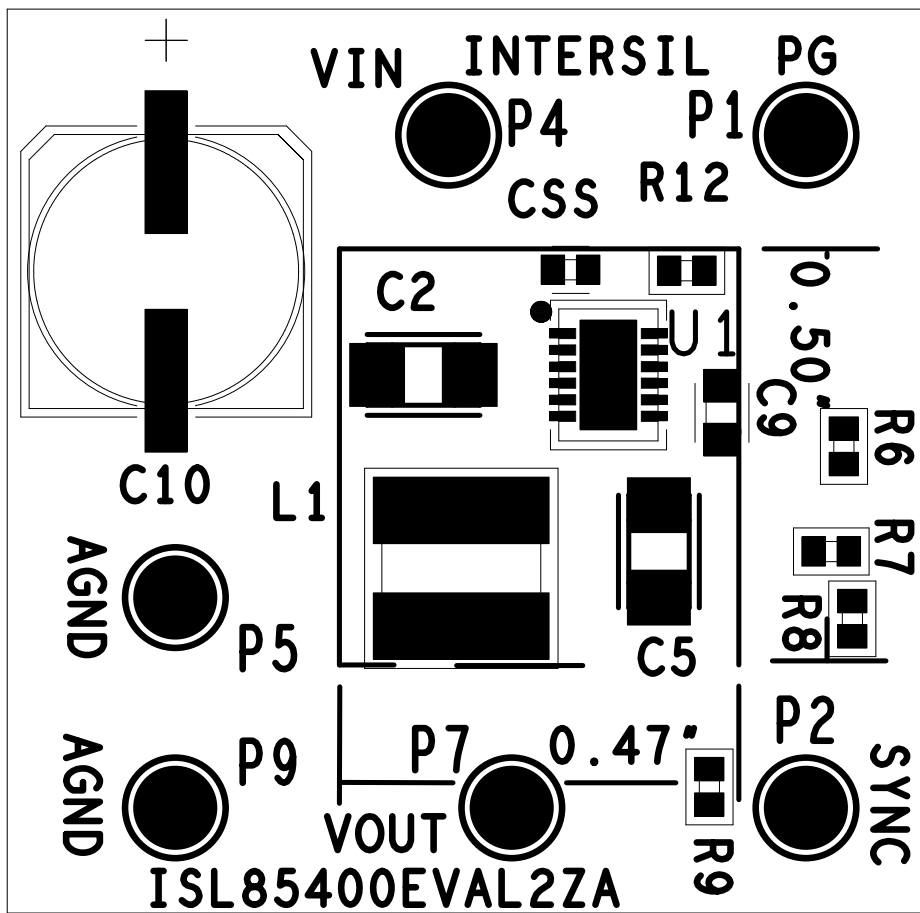

FIGURE 3. SILK SCREEN TOP

ISL85415DEMO1Z Board Layout (Continued)

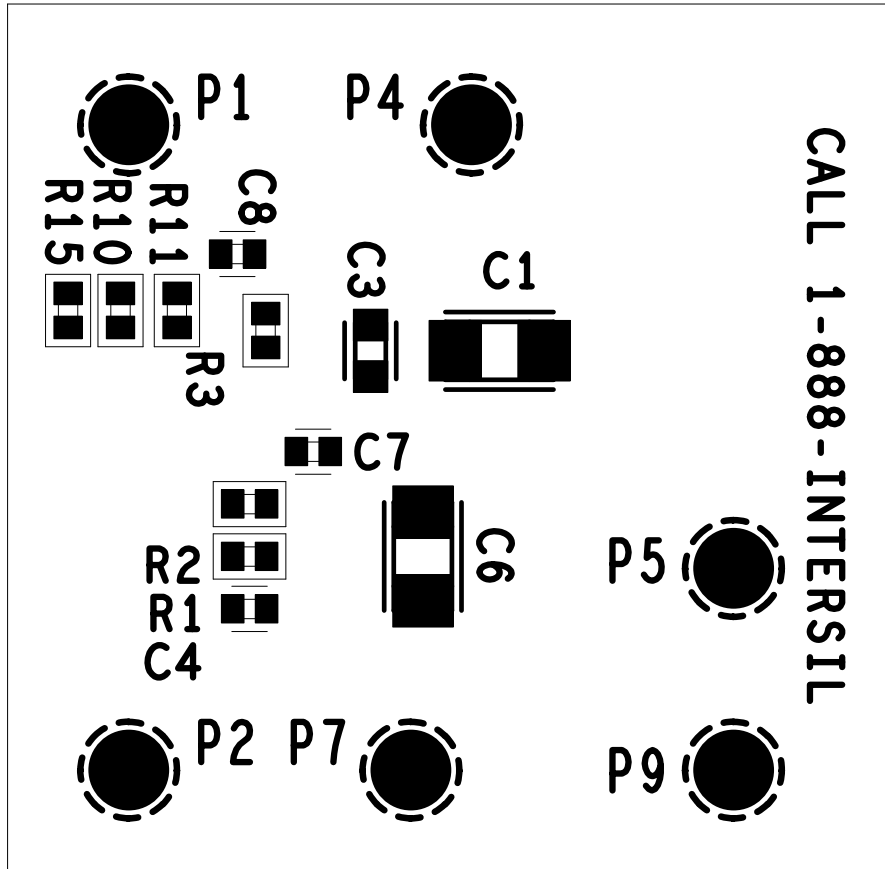

FIGURE 4. SILKSCREEN BOTTOM

Efficiency Curves $F_{SW} = 800kHz, T_A = +25^\circ C$

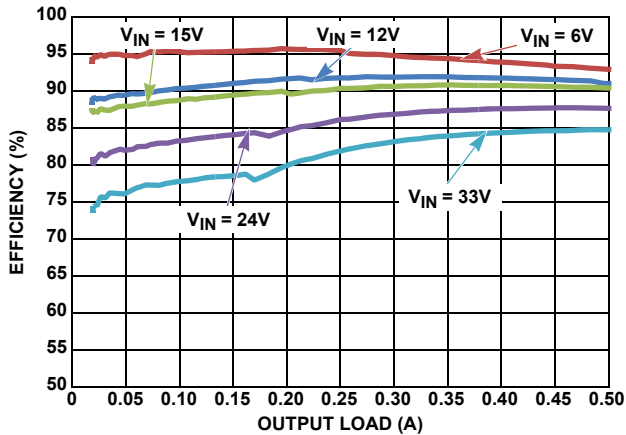

FIGURE 5. EFFICIENCY vs LOAD, PFM, $V_{OUT} = 5V$

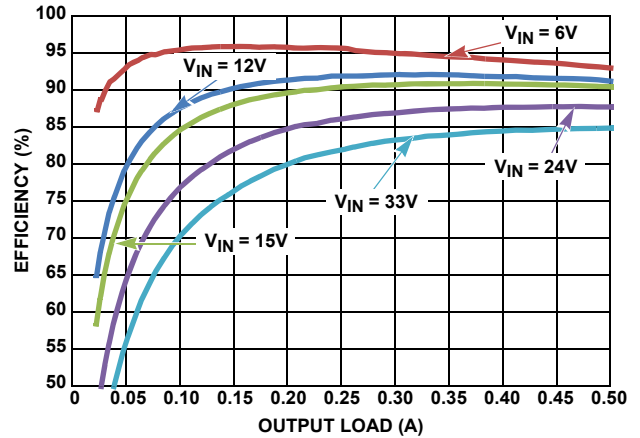

FIGURE 6. EFFICIENCY vs LOAD, PWM, $V_{OUT} = 5V$

Efficiency Curves $F_{SW} = 800kHz, T_A = +25^{\circ}C$ (Continued)

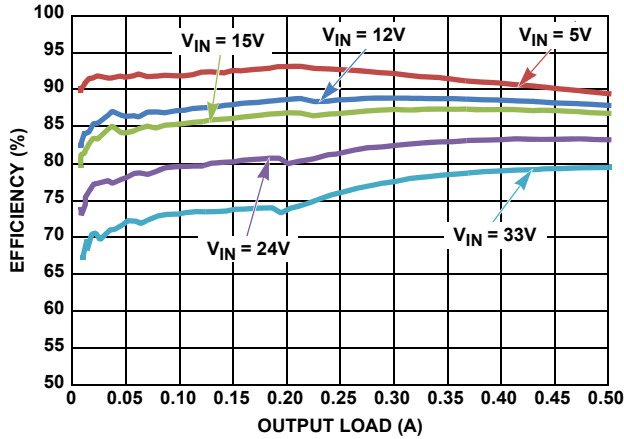

FIGURE 7. EFFICIENCY vs LOAD, PFM, $V_{OUT} = 3.3V$

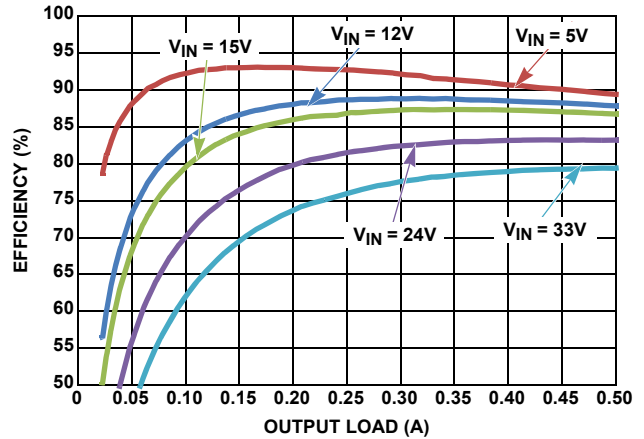

FIGURE 8. EFFICIENCY vs LOAD, PWM, $V_{OUT} = 3.3V$

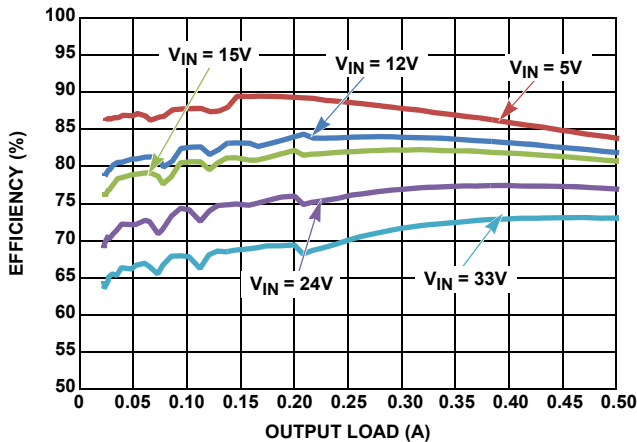

FIGURE 9. EFFICIENCY vs LOAD, PFM, $V_{OUT} = 1.8V$

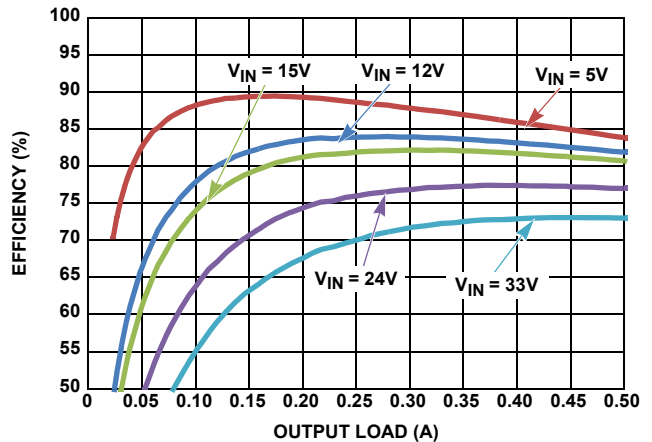

FIGURE 10. EFFICIENCY vs LOAD, PWM, $V_{OUT} = 1.8V$

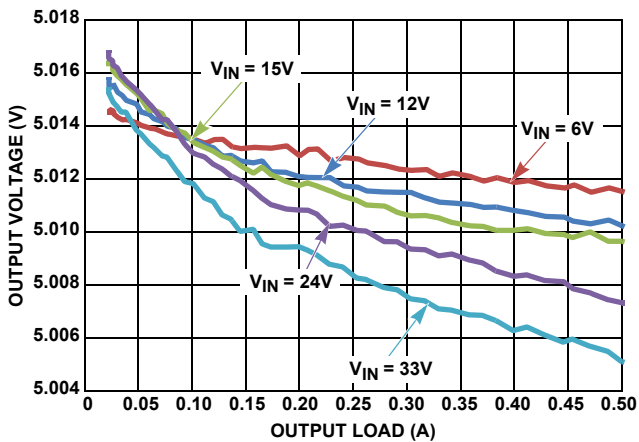

FIGURE 11. V_{OUT} REGULATION vs LOAD, PWM, $V_{OUT} = 5V$

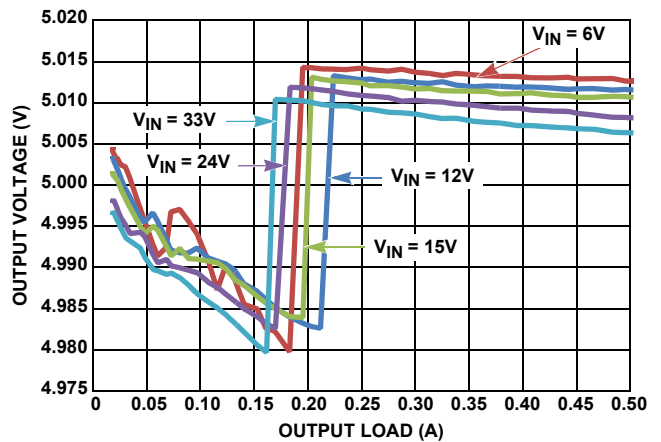

FIGURE 12. V_{OUT} REGULATION vs LOAD, PFM, $V_{OUT} = 5V$

Efficiency Curves $F_{SW} = 800kHz, T_A = +25^\circ C$ (Continued)

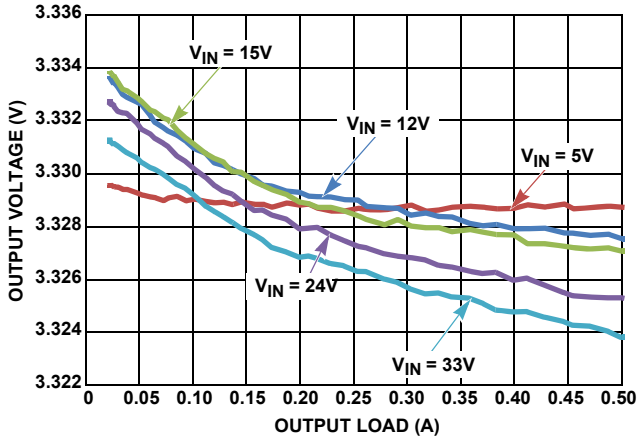

FIGURE 13. V_{OUT} REGULATION vs LOAD, PWM, $V_{OUT} = 3.3V$

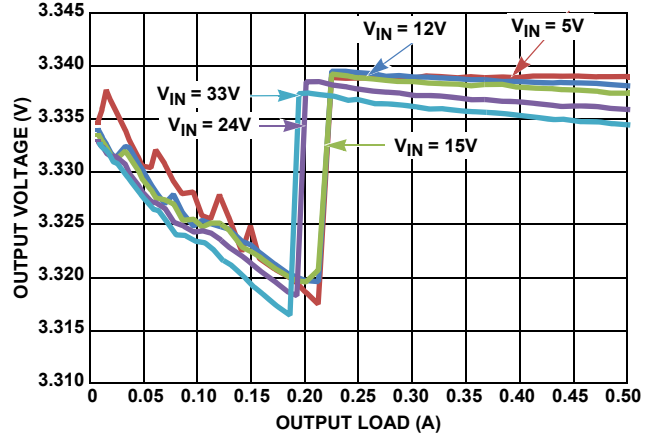

FIGURE 14. V_{OUT} REGULATION vs LOAD, PFM, $V_{OUT} = 3.3V$

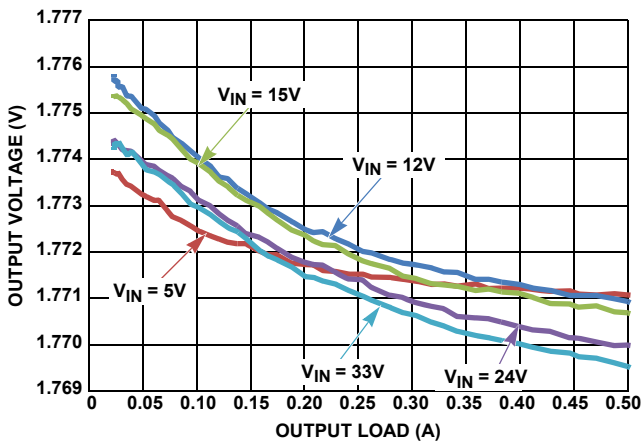

FIGURE 15. V_{OUT} REGULATION vs LOAD, PWM, $V_{OUT} = 1.8V$

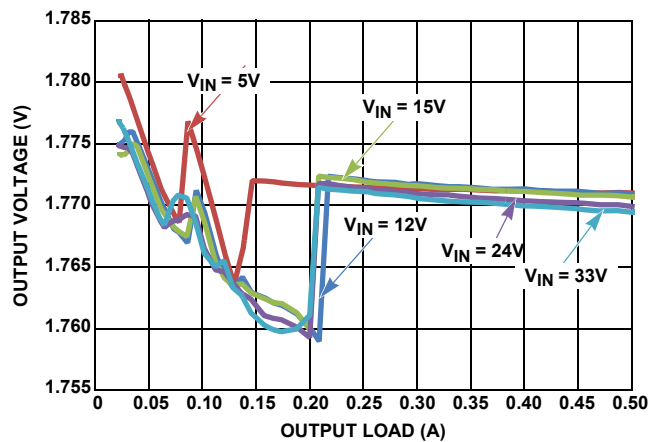

FIGURE 16. V_{OUT} REGULATION vs LOAD, PFM, $V_{OUT} = 1.8V$

Typical Performance Curves $V_{IN} = 24V, V_{OUT} = 3.3V, F_{SW} = 800kHz, T_A = +25^\circ C$

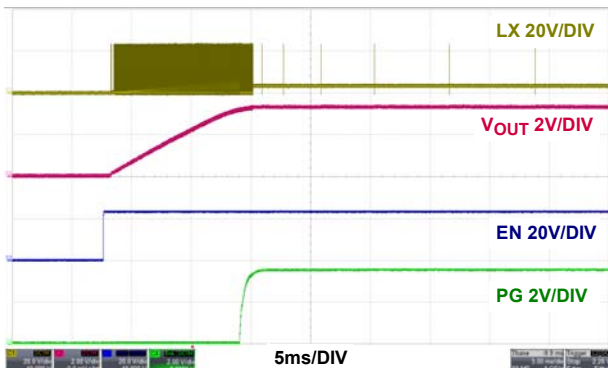

FIGURE 17. START-UP AT NO LOAD, PFM

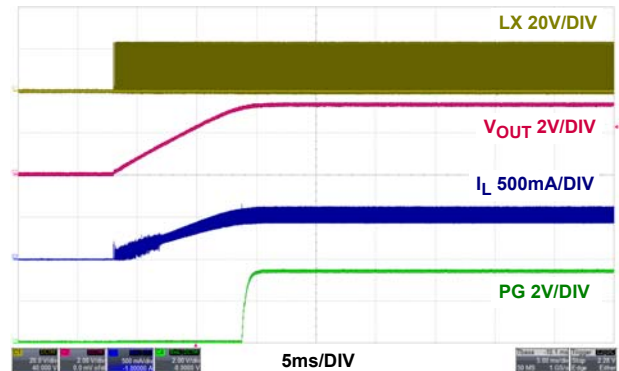

FIGURE 18. START-UP AT 500mA, PWM

Typical Performance Curves $V_{IN} = 24V, V_{OUT} = 3.3V, F_{SW} = 800kHz, T_A = +25^\circ C.$ (Continued)

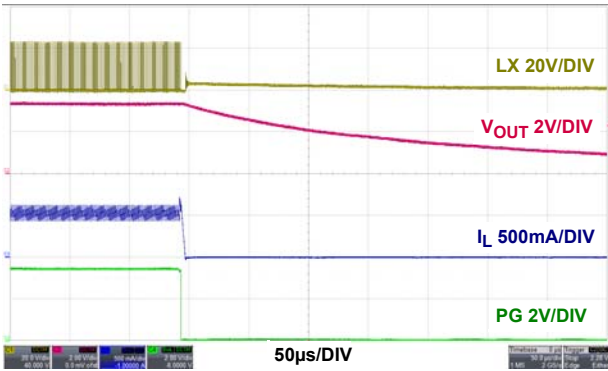

FIGURE 19. SHUTDOWN AT 500mA, PWM

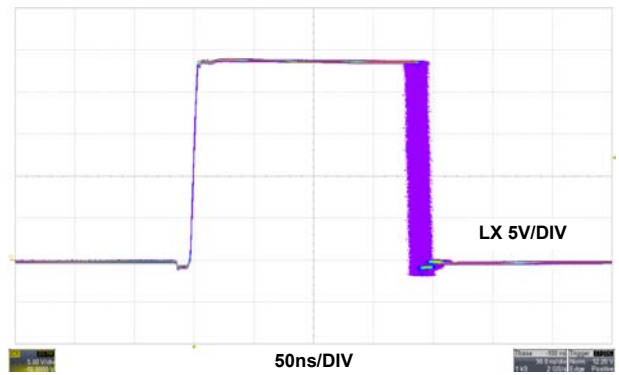

FIGURE 20. JITTER AT 500mA, PWM

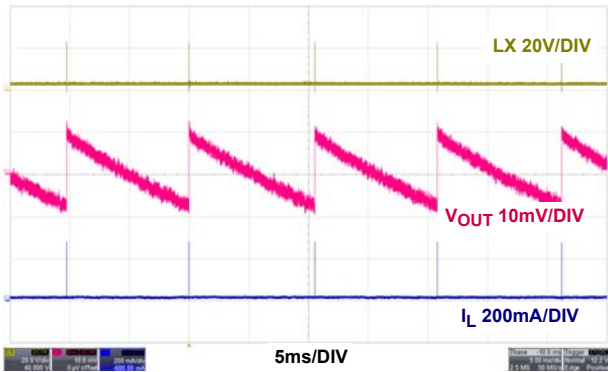

FIGURE 21. STEADY STATE AT NO LOAD, PFM

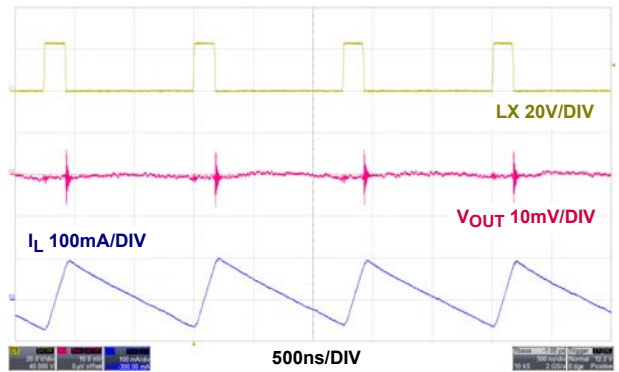

FIGURE 22. STEADY STATE AT NO LOAD, PWM

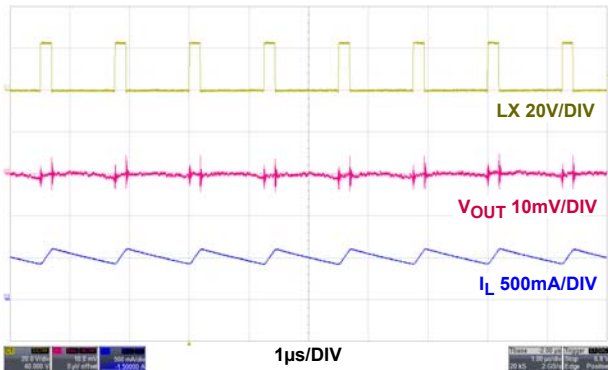

FIGURE 23. STEADY STATE AT 500mA LOAD, PWM

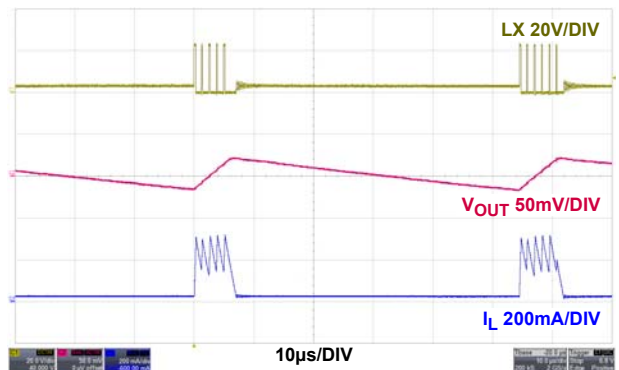

FIGURE 24. LIGHT LOAD OPERATION AT 20mA, PFM

Typical Performance Curves $V_{IN} = 24V, V_{OUT} = 3.3V, F_{SW} = 800kHz, T_A = +25^\circ C.$ (Continued)

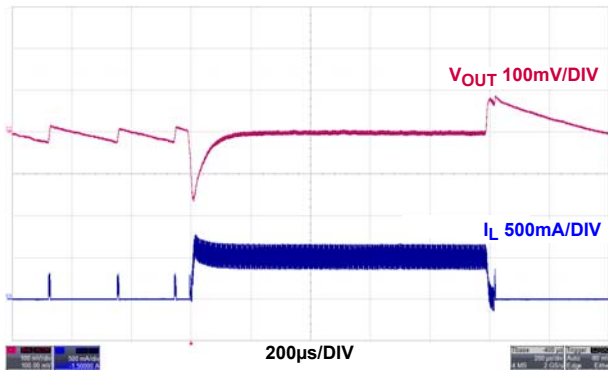

FIGURE 25. LOAD TRANSIENT, PFM

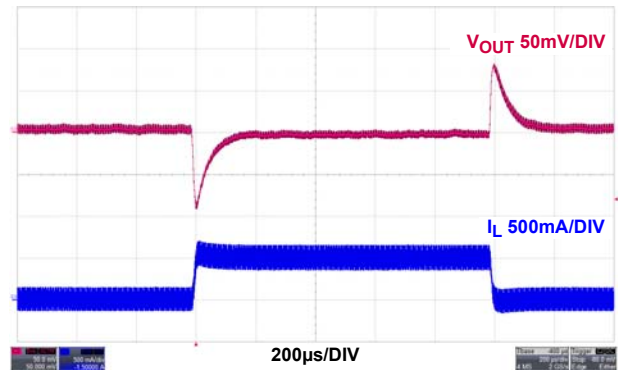

FIGURE 26. LOAD TRANSIENT, PWM

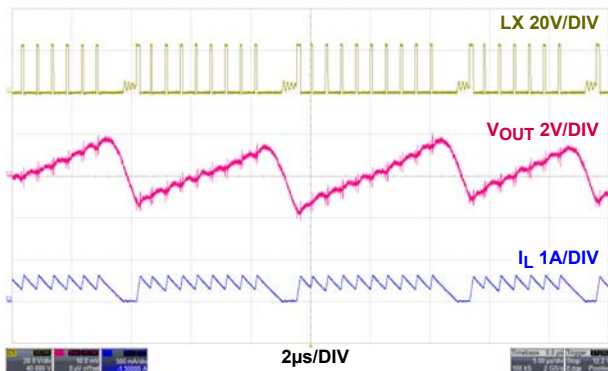

FIGURE 27. PFM TO PWM TRANSITION

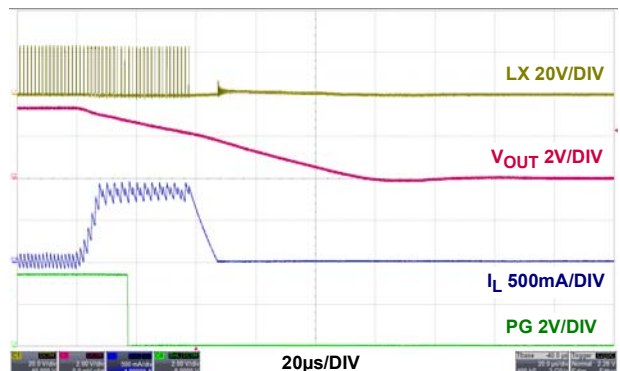

FIGURE 28. OVERCURRENT PROTECTION, PWM

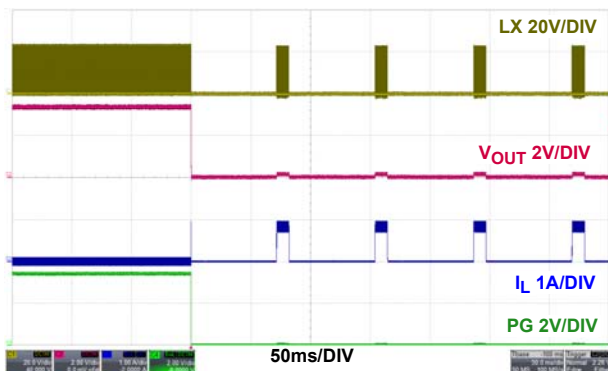

FIGURE 29. OVERCURRENT PROTECTION HICCUP, PWM

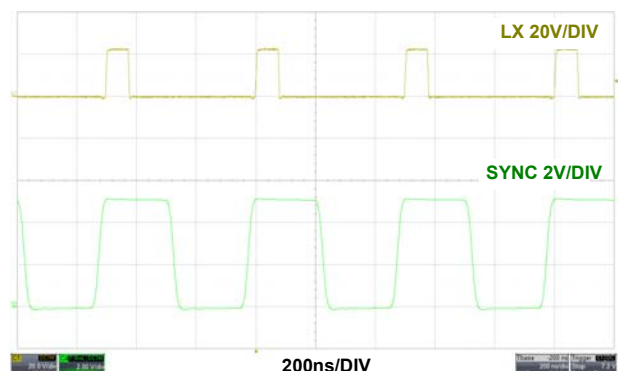

FIGURE 30. SYNC AT 500mA LOAD, PWM

Typical Performance Curves $V_{IN} = 24V, V_{OUT} = 3.3V, F_{SW} = 800kHz, T_A = +25^\circ C.$ (Continued)

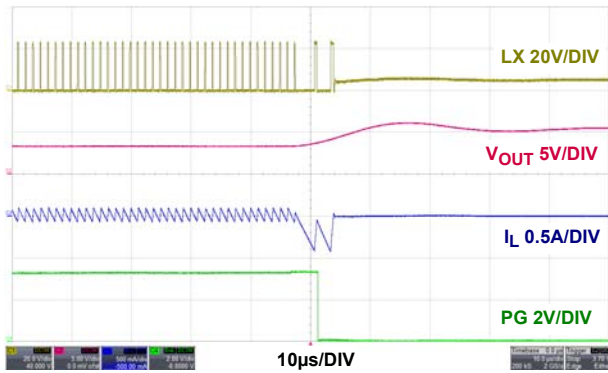

FIGURE 31. NEGATIVE CURRENT LIMIT, PWM

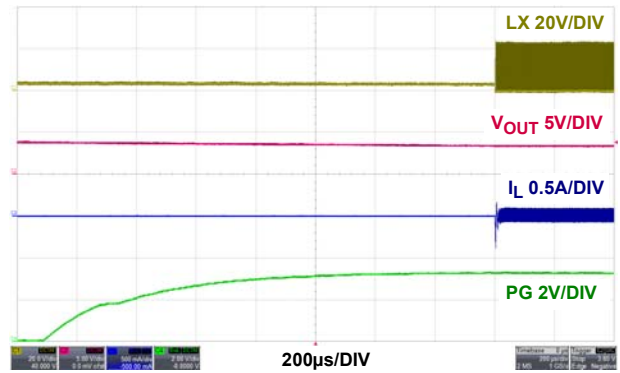

FIGURE 32. NEGATIVE CURRENT LIMIT RECOVERY, PWM

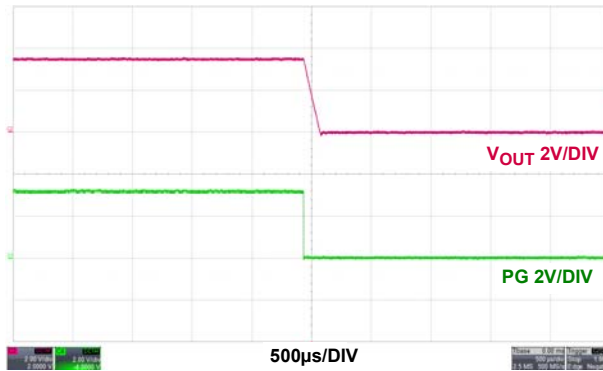

FIGURE 33. OVER-TEMPERATURE PROTECTION, PWM

Notice

1. Descriptions of circuits, software and other related information in this document are provided only to illustrate the operation of semiconductor products and application examples. You are fully responsible for the incorporation or any other use of the circuits, software, and information in the design of your product or system. Renesas Electronics disclaims any and all liability for any losses and damages incurred by you or third parties arising from the use of these circuits, software, or information.
2. Renesas Electronics hereby expressly disclaims any warranties against and liability for infringement or any other claims involving patents, copyrights, or other intellectual property rights of third parties, by or arising from the use of Renesas Electronics products or technical information described in this document, including but not limited to, the product data, drawings, charts, programs, algorithms, and application examples.
3. No license, express, implied or otherwise, is granted hereby under any patents, copyrights or other intellectual property rights of Renesas Electronics or others.
4. You shall not alter, modify, copy, or reverse engineer any Renesas Electronics product, whether in whole or in part. Renesas Electronics disclaims any and all liability for any losses or damages incurred by you or third parties arising from such alteration, modification, copying or reverse engineering.
5. Renesas Electronics products are classified according to the following two quality grades: "Standard" and "High Quality". The intended applications for each Renesas Electronics product depends on the product's quality grade, as indicated below.
"Standard": Computers; office equipment; communications equipment; test and measurement equipment; audio and visual equipment; home electronic appliances; machine tools; personal electronic equipment; industrial robots; etc.
"High Quality": Transportation equipment (automobiles, trains, ships, etc.); traffic control (traffic lights); large-scale communication equipment; key financial terminal systems; safety control equipment; etc.
Unless expressly designated as a high reliability product or a product for harsh environments in a Renesas Electronics data sheet or other Renesas Electronics document, Renesas Electronics products are not intended or authorized for use in products or systems that may pose a direct threat to human life or bodily injury (artificial life support devices or systems; surgical implantations; etc.), or may cause serious property damage (space system; undersea repeaters; nuclear power control systems; aircraft control systems; key plant systems; military equipment; etc.). Renesas Electronics disclaims any and all liability for any damages or losses incurred by you or any third parties arising from the use of any Renesas Electronics product that is inconsistent with any Renesas Electronics data sheet, user's manual or other Renesas Electronics document.
6. When using Renesas Electronics products, refer to the latest product information (data sheets, user's manuals, application notes, "General Notes for Handling and Using Semiconductor Devices" in the reliability handbook, etc.), and ensure that usage conditions are within the ranges specified by Renesas Electronics with respect to maximum ratings, operating power supply voltage range, heat dissipation characteristics, installation, etc. Renesas Electronics disclaims any and all liability for any malfunctions, failure or accident arising out of the use of Renesas Electronics products outside of such specified ranges.
7. Although Renesas Electronics endeavors to improve the quality and reliability of Renesas Electronics products, semiconductor products have specific characteristics, such as the occurrence of failure at a certain rate and malfunctions under certain use conditions. Unless designated as a high reliability product or a product for harsh environments in a Renesas Electronics data sheet or other Renesas Electronics document, Renesas Electronics products are not subject to radiation resistance design. You are responsible for implementing safety measures to guard against the possibility of bodily injury, injury or damage caused by fire, and/or danger to the public in the event of a failure or malfunction of Renesas Electronics products, such as safety design for hardware and software, including but not limited to redundancy, fire control and malfunction prevention, appropriate treatment for aging degradation or any other appropriate measures. Because the evaluation of microcomputer software alone is very difficult and impractical, you are responsible for evaluating the safety of the final products or systems manufactured by you.
8. Please contact a Renesas Electronics sales office for details as to environmental matters such as the environmental compatibility of each Renesas Electronics product. You are responsible for carefully and sufficiently investigating applicable laws and regulations that regulate the inclusion or use of controlled substances, including without limitation, the EU RoHS Directive, and using Renesas Electronics products in compliance with all these applicable laws and regulations. Renesas Electronics disclaims any and all liability for damages or losses occurring as a result of your noncompliance with applicable laws and regulations.
9. Renesas Electronics products and technologies shall not be used for or incorporated into any products or systems whose manufacture, use, or sale is prohibited under any applicable domestic or foreign laws or regulations. You shall comply with any applicable export control laws and regulations promulgated and administered by the governments of any countries asserting jurisdiction over the parties or transactions.
10. It is the responsibility of the buyer or distributor of Renesas Electronics products, or any other party who distributes, disposes of, or otherwise sells or transfers the product to a third party, to notify such third party in advance of the contents and conditions set forth in this document.
11. This document shall not be reprinted, reproduced or duplicated in any form, in whole or in part, without prior written consent of Renesas Electronics.
12. Please contact a Renesas Electronics sales office if you have any questions regarding the information contained in this document or Renesas Electronics products.
(Note 1) "Renesas Electronics" as used in this document means Renesas Electronics Corporation and also includes its directly or indirectly controlled subsidiaries.
(Note 2) "Renesas Electronics product(s)" means any product developed or manufactured by or for Renesas Electronics.

(Rev.4.0-1 November 2017)



SALES OFFICES

Renesas Electronics Corporation

<http://www.renesas.com>

Refer to "<http://www.renesas.com/>" for the latest and detailed information.

Renesas Electronics America Inc.
1001 Murphy Ranch Road, Milpitas, CA 95035, U.S.A.
Tel: +1-408-432-8888, Fax: +1-408-434-5351

Renesas Electronics Canada Limited
9251 Yonge Street, Suite 8309 Richmond Hill, Ontario Canada L4C 9T3
Tel: +1-905-237-2004

Renesas Electronics Europe Limited
Dukes Meadow, Millboard Road, Bourne End, Buckinghamshire, SL8 5FH, U.K
Tel: +44-1628-651-700, Fax: +44-1628-651-804

Renesas Electronics Europe GmbH
Arcadiastrasse 10, 40472 Düsseldorf, Germany
Tel: +49-211-6503-0, Fax: +49-211-6503-1327

Renesas Electronics (China) Co., Ltd.
Room 1709 Quantum Plaza, No.27 ZhichunLu, Haidian District, Beijing, 100191 P. R. China
Tel: +86-10-8235-1155, Fax: +86-10-8235-7679

Renesas Electronics (Shanghai) Co., Ltd.
Unit 301, Tower A, Central Towers, 555 Langao Road, Putuo District, Shanghai, 200333 P. R. China
Tel: +86-21-2226-0888, Fax: +86-21-2226-0999

Renesas Electronics Hong Kong Limited
Unit 1601-1611, 16/F., Tower 2, Grand Century Place, 193 Prince Edward Road West, Mongkok, Kowloon, Hong Kong
Tel: +852-2265-6688, Fax: +852-2886-9022

Renesas Electronics Taiwan Co., Ltd.
13F, No. 363, Fu Shing North Road, Taipei 10543, Taiwan
Tel: +886-2-8175-9600, Fax: +886-2-8175-9670

Renesas Electronics Singapore Pte. Ltd.
80 Bendemeer Road, Unit #06-02 Hyflux Innovation Centre, Singapore 339949
Tel: +65-6213-0200, Fax: +65-6213-0300

Renesas Electronics Malaysia Sdn.Bhd.
Unit 1207, Block B, Menara Amcorp, Amcorp Trade Centre, No. 18, Jln Persiaran Barat, 46050 Petaling Jaya, Selangor Darul Ehsan, Malaysia
Tel: +60-3-7955-9390, Fax: +60-3-7955-9510

Renesas Electronics India Pvt. Ltd.
No.777C, 100 Feet Road, HAL 2nd Stage, Indiranagar, Bangalore 560 038, India
Tel: +91-80-67208700, Fax: +91-80-67208777

Renesas Electronics Korea Co., Ltd.
17F, KAMCO Yangjae Tower, 262, Gangnam-daero, Gangnam-gu, Seoul, 06265 Korea
Tel: +82-2-558-3737, Fax: +82-2-558-5338