

Description

The ZSSC324x SSC Evaluation Kit is designed for sensor module evaluation, laboratory setup, and module calibration development for the ZSSC324x Sensor Signal Conditioner (SSC).

The main purpose of the ZSSC324x Evaluation Kit is to enable the communication between the user and the ZSSC324x device with the GUI (Graphical User Interface). The ZSSC324x-GUI establishes the communication via a USB port (configured as a virtual COM port) to the SSC Communication Board (CB). The microcontroller on the SSC CB interprets these commands, converts them to the configured interface (I2C, SPI or OWI), and provides it to the ZSSC324x located on the ZSSC324x SSC Evaluation Board.

Almost all possible applications can be tested with the Evaluation Kit and the GUI, so that the customer can easily get the first experience and also evaluate in detail the ZSSC324x functionalities.

Kit Contents

- ZSSC324x Evaluation Board -ZSSC324xEVB
- [SSC Communication Board](#) - SSCCOMMBOARDV4P1C
- [SRB \(Sensor Replacement Board\)](#) SSCSENSORREPBVD2P0
- ZSSC324x 24-PQFN 4 × 4 mm Samples (5 pcs)
- USB Cable

ZSSC324x Demo Kit



Features

- I2C, SPI or OWI communication interface enables quick and easy configuration and calibration of the ZSSC324x using the user's computer.
- Connections are provided on the ZSSC324x SSC Evaluation Board for user's sensor module, which can be used instead of the SSC Sensor Replacement Board.
- A potentiometer on the SSC Sensor Replacement Board controls a voltage that simulates a sensor signal ranging from 2mV to 110mV, which can be input to the analog frontend of the ZSSC324x (INP and INN pins) for evaluation of basic features or for demonstrating a "dry-run" calibration.
- Modular design allows reuse of kit components for evaluation of select ZSSC324x products.
- Clamshell 24-PQFN socket for ZSSC324x device under test (DUT) facilitates testing multiple DUTs without soldering.
- Software is available for download from the Renesas web site.

Note: The SSC Communication Board must have the V4.12 firmware (or higher version) in order to recognize the ZSSC324x. If using an older Communication Board, contact Renesas regarding firmware update procedures. For more detailed information about the SSC Communication Board, refer to the SSC Communication Board Data Sheet available at www.IDT.com/SSC-COMM-BD.

Important Notes

Disclaimer

Integrated Device Technology, Inc. and its affiliated companies (herein referred to as "Renesas") shall not be liable for any damages arising out of defects resulting from

- (i) delivered hardware or software
- (ii) non-observance of instructions contained in this manual and in any other documentation provided to user, or
- (iii) misuse, abuse, use under abnormal conditions, or alteration by anyone other than Renesas.

TO THE EXTENT PERMITTED BY LAW, Renesas HEREBY EXPRESSLY DISCLAIMS AND USER EXPRESSLY WAIVES ANY AND ALL WARRANTIES, WHETHER EXPRESS, IMPLIED, OR STATUTORY, INCLUDING, WITHOUT LIMITATION, IMPLIED WARRANTIES OF MERCHANTABILITY AND OF FITNESS FOR A PARTICULAR PURPOSE, STATUTORY WARRANTY OF NON-INFRINGEMENT, AND ANY OTHER WARRANTY THAT MAY ARISE BY REASON OF USAGE OF TRADE, CUSTOM, OR COURSE OF DEALING.

Restrictions in Use

Renesas' ZSSC324x, consisting of the SSC Communication Board (SSC CB), ZSSC324x Evaluation Board (SSC EVB), SSC Sensor Replacement Board (SSC RB), and ZSSC324x Software, is designed for module evaluation, laboratory setup, and module calibration development only. Renesas' ZSSC324x hardware and software must not be used for module production or production test setups.



Important Equipment Warning: Ensure the correct connection of all cables. Supplying the board using the wrong polarity could result in damage to the board and/or the equipment. Check that all jumpers have been removed from the board before applying power.

Contents

1.	Evaluation Kit Setup	6
1.1	Required or Recommended User Equipment	6
1.2	User Computer Requirements and Setup	7
1.2.1	Computer Requirements	7
1.2.2	Software Installation and Setup	7
1.3	Boards Configuration and Connections	7
1.4	Kit Hardware Connections (Default)	12
1.5	Communication Interfaces	13
1.6	External Equipment Connections	13
1.7	Power Supply Option	14
1.8	Power-up Procedure	15
2.	GUI	17
2.1	Menu Bar	17
2.1.1	NVM Control	17
2.1.2	Interface Setup	18
2.1.3	Output Interrupt Signaling	20
2.2	Current Interface Settings	20
2.3	Measurement Control	21
2.3.1	Measurement Commands	21
2.4	Display Control	23
2.5	Logging Options	24

2.5.1	Communication Log.....	24
2.5.2	Measurement Data Log.....	25
2.6	Status.....	25
2.6.1	IC Status.....	25
2.6.2	Hardware Connection.....	26
2.6.3	Sensor and Temperature Readings	27
2.7	Tabs.....	27
2.7.1	Measurement Tab	27
2.7.2	NVM Tab	27
2.7.3	Calibration Tab	30
2.7.4	Diagnostic / Cyclic Configuration / Command Section	32
2.8	Main Buttons.....	36
2.9	Information Bar	37
3.	Calibration Process, Configuration and Calibration Example.....	38
3.1	Process Flowchart	38
3.2	Connect EVK and Start GUI	39
3.3	Configuration	39
3.4	Data Collection	41
3.5	Coefficients Calculation	43
3.6	Memory Programming	44
3.7	Verification.....	45
4.	Board Supply by External JFET	46
5.	Analog Output.....	47
5.1	Enabling Analog Output Pin	47
5.2	Amplified Analog Output.....	48
5.3	Current Loop Output.....	48
6.	Troubleshooting.....	49
6.1	GUI Launched while the Communication Board is Not Connected	49
6.2	Unplugging Communication Board with Port Open	50
7.	Schematic, Bill of Materials	50
8.	Glossary	51
9.	Ordering Information.....	52
10.	Revision History.....	52

List of Figures

Figure 1.	Connected boards	6
Figure 2.	ZSSC324x SSC Evaluation Board – Overview.....	8
Figure 3.	Signal Connections: SSC Communication Board and ZSSC324x EVB	9
Figure 4.	Signal Connections: ZSSC324x EVB and SRB.....	10
Figure 5.	Jumpers on the SSC Communication Board and the ZSSC324x EVB	13
Figure 6.	Lab Equipment Connections	14
Figure 7.	LEDs Status CB - Ready for Operation (without GUI Running).....	15

Figure 8. LED Status after Starting the Evaluation SW	16
Figure 9. Initial GUI Display	16
Figure 10. ZSSC324x GUI Main Screen.....	17
Figure 11. NVM_config text file.....	18
Figure 12. Communication Interface Setup SPI	19
Figure 13. Communication Interface Setup - I2C.....	19
Figure 14. Communication Interface Setup - OWI.....	19
Figure 15. Threshold Setup	20
Figure 16. Corrected Measurement Oversampling.....	21
Figure 17. Cyclic Measurements – Busy Status	22
Figure 18. Measurements Visualization.....	23
Figure 19. Resolution Range from Chip to GUI	24
Figure 20. Logging Options	24
Figure 21. Communication log SPI.....	24
Figure 22. Communication log I2C	24
Figure 23. Communication OWI	25
Figure 24. IC status	25
Figure 25. HW Connection	27
Figure 26. Sensor and Temperature Display.....	27
Figure 27. NVM Table.....	28
Figure 28. SM Config 1/2 Sub-Tab.....	29
Figure 29. Ext Temp. 1/2 Sub-Tab	29
Figure 30. Smart Sensor Function I/O 1 Sub-tab	30
Figure 31. Smart Sensor Function I/O 2 Sub-Tab	30
Figure 32. Calibration Tab	31
Figure 33. Raw Data to Calibrated Data in Percentage.....	31
Figure 34. Diagnostic / Cyclic Configuration /Command Section	33
Figure 35. Cyclic Operation Parameters.....	33
Figure 36. ADC and DAC Diagnostics.....	34
Figure 37. Sensor Check Selection Settings	35
Figure 38. Single Commands Options.....	36
Figure 39. Read/Write Operations via Terminal.....	36
Figure 40. Main Buttons.....	37
Figure 41. Information Bar Message	37
Figure 42. Calibration process flowchart	38
Figure 43. NVM Coefficients before Calibration	39
Figure 44. AFE Settings.....	40
Figure 45. Display and Control Settings	40
Figure 46. Output Swing.....	40
Figure 47. Saturation Condition	41
Figure 48. Calibration Points Set Options.....	41
Figure 49. 2-Points Calibration – Reference Points.....	41
Figure 50. 2-Points Calibration – Points Position	42

Figure 51. 2-Points Calibration – First Point	42
Figure 52. 2 Points Calibration – Raw Values	43
Figure 53. Calculated Coefficients.....	43
Figure 54. Calculation Error Message	43
Figure 55. NVM View with New Register Values after Calibration.....	44
Figure 56. Calibrated Sensor Measurement.....	45
Figure 57. External Supply Connections	46
Figure 58. External Supply GUI Settings	46
Figure 59. Measurement Control for Analog Output.....	47
Figure 60. Analog and Digital Output Synchronous Swing.....	47
Figure 61. Connection Error Message.....	49
Figure 62. Resume Communication	49
Figure 63. Close Port before unplugging the Communication Board.....	50

List of Tables

Table 1. Sensor Signal at Connectors.....	8
Table 2. LEDs.....	9
Table 3. Signal Connections: SSC Communication Board and ZSSC324x Evaluation Board.....	9
Table 4. Signal Connections: ZSSC324x Evaluation Board and the Sensor Replacement Board.....	10
Table 5. Evaluation Board Connections Descriptions.....	11
Table 6. Jumper Settings for Analog Output Selection.....	12
Table 7. Jumper Settings for Digital Interface Selection.....	12
Table 8. Power Supply Selection.....	15
Table 9. Measurement Commands	22
Table 10. IC Status Indicators	26
Table 11. Supported Default Calibration Types.....	32
Table 12. Jumper Settings for Amplified Analog Output.....	48
Table 13. Abbreviations and terms used in the document.....	51

1. Evaluation Kit Setup

This document describes the ZSSC324x Evaluation Kit, including the hardware components, the product-specific configuration, the ZSSC324x Evaluation Software, and its installation. The software is designed for Windows®-based operating systems to communicate with the ZSSC324x Evaluation Kit via a USB connection on the user’s computer, which functions as a master. Reading the ZSSC324x Data Sheet before using the kit is strongly recommended.

Three boards are included in the ZSSC324x Evaluation Kit:

- Communication board (SSC-CB) - The SSC Communication Board V4.1 can provide the power supply for the evaluation hardware and handle the communication with a PC via a USB interface. The board provides galvanic isolation between the PC’s USB port and the Evaluation Board by on board digital isolators for the data lines and an isolated DC/DC converter for the power line. Detailed documentation is available at the following link: <https://www.idt.com/products/sensor-products/sensor-signal-conditioners/ssc-cb-ssc-communication-board>.
- Evaluation Board (SSC-EVB) - This board provides all the required circuitry for the operation, evaluation and calibration of the ZSSC324x device under test. The Evaluation Board provides also a connection for a sensor replacement device (e.g., the SRB) or a user sensor board. **Note:** Only user sensor or the SRB must be connected to the Evaluation Board at any given time.
- Sensor Replacement Board (SSC-SRB) can be connected to the SSC EVB as a replacement for an actual sensor and can be used for the first step of a calibration demonstration or a dry-run calibration. Detailed documentation is available at the following link: <https://www.idt.com/products/sensor-products/sensor-signal-conditioners/ssc-srb-ssc-replacement-board>.

The three boards are shown connected on Figure 1.

Figure 1. Connected boards

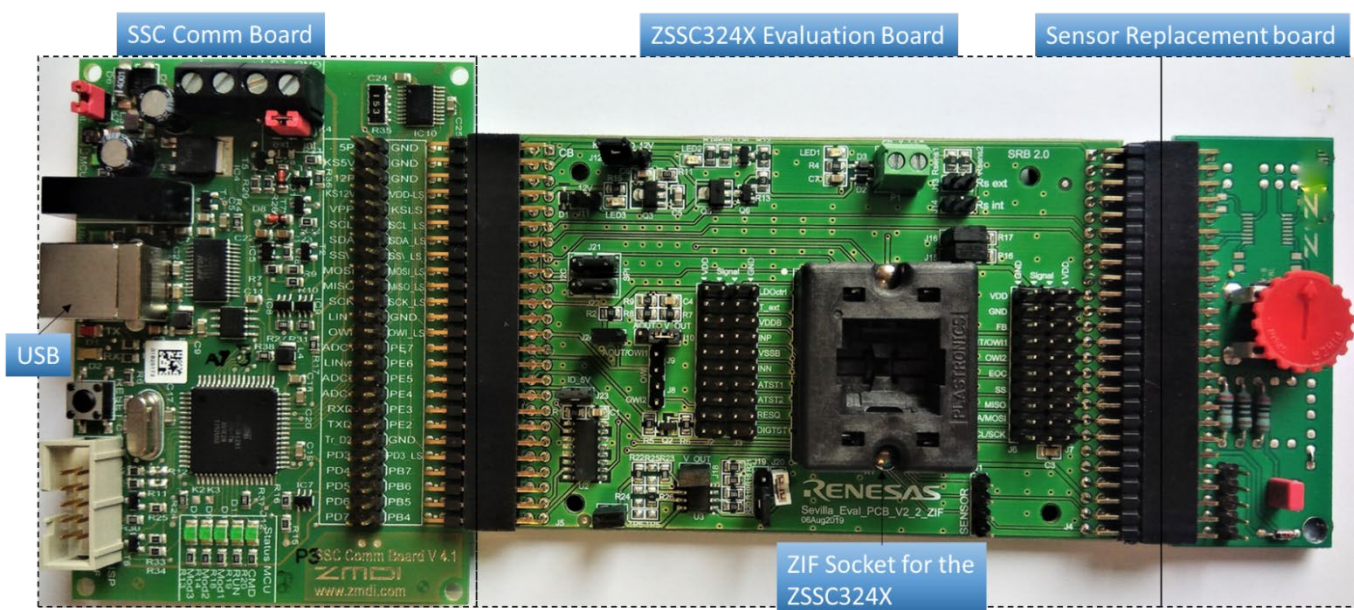

1.1 Required or Recommended User Equipment

- A Windows®-based computer is required for interfacing with the kit and configuring the ZSSC324x.
- Optional equipment:
 - The ZSSC324x power (VDD) can be supplied by the user’s external power supply. See 1.7 for connection details.
 - DC Voltmeter 0-50V and DC Ampmeter (0-100mA)
 - 4 channel 100MHz Oscilloscope

1.2 User Computer Requirements and Setup

1.2.1 Computer Requirements

A Windows®-based computer is required for interfacing with the kit and configuring the part. The user must have administrative rights on the computer to download and install the Evaluation Software for the kit.

The computer must meet the following requirements:

- Windows® XP SP3, Vista SP1 or later, 7 (including SP1), 8, 8.1, 10
- Supported architecture: x86 and x64
- Available USB port
- Internet access

1.2.2 Software Installation and Setup

The ZSSC324x Evaluation Software required for the kit is not included with the kit. To ensure use of the latest version of the software, it is available for download in zip file format from the Renesas web site.

Note: FTDI USB drivers are needed for communication. If these drivers are not already installed on the user's computer, they can be downloaded from the FTDI's homepage, <https://www.ftdichip.com/FTDrivers.htm>.

Further details to the Communication Board, the according drivers and its configuration options are explained in the CB datasheet,

Follow the procedure to use the Evaluation Kit Software on the user's computer:

1. Downloading the *ZSSC3240_Evaluation_SW_vX.XX.zip* file to the user's computer and extract the contents.
The Evaluation Software does not need installation, all drivers and libraries are transferred within a single EXE-file.
2. Connect the kit hardware as described in Figure 1 to the host PC using the provided USB cable.
3. Start installation by double clicking the *ZSSC324x_Evaluation_SW_vX.XX.exe* file.
Installation can take some time due to unpacking the EXE file. The process is further slowed down by anti-virus software that checks each unpacked file.

1.3 Boards Configuration and Connections

Sections 1.3, 1.4, 1.5, 1.6, 1.7, and 1.8 describe information about features of the evaluation kit HW. Some of the most important jumpers, connectors, and test points are shown in Table 1 to Table 8

Figure 2. ZSSC324x SSC Evaluation Board – Overview

Left: internal power supply (5V from Comm Board)
 Right: external power supply (from P1 or 12V from Comm Board)

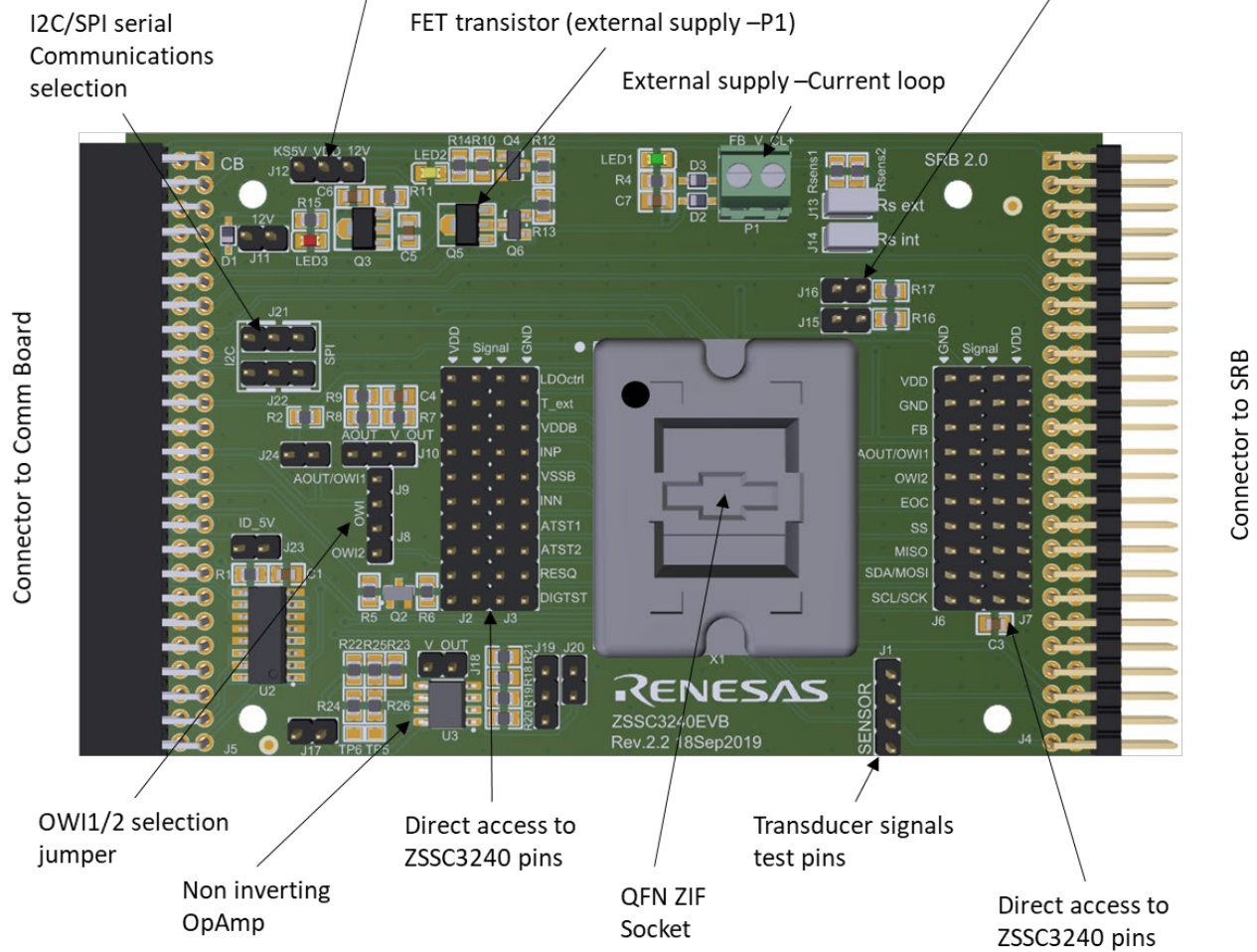

Table 1. Sensor Signal at Connectors

Signal	J1	J2	J3	J4
VDDB	1	6	5	45
INP	3	8	7	47
INN	2	12	11	49
VSSB	4	10	9	43

Table 2. LEDs

Connector	Type	Description
LED1	Green	Indication for presence of VDD voltage.
LED2	Yellow	Indication for presence of KS5V voltage.
LED3	Red	Indication for presence of KS12V voltage.

Table 3. Signal Connections: SSC Communication Board and ZSSC324x Evaluation Board

Name	Pin	Description
5P	1	5VDC power supply.
KS5P	3	5VDC power supply switch controlled (for timing)
GND	2,4,6,24,40	Ground connection
KS12V	7	12V supply from SSC COMM BOARD
SCL/SDA	11,13	I2C interface, logic level
MISO, MOSI, SCK,SS	15,17,19,21	SPI interface, 5V logic (used for SSC EVB identification by I2C).
OWI	25	One Wire Interface
PE7	28	GPIO Control with internal pull-up resistors used to reset the ZSSC324x.
PD3	41	Control signal to the EOC pin of the ZSSC324x; logic level defined by the VDD_LS.
PD4	43	Bi-directional I/O port with internal pull-up resistors.
PD7	49	PD7 U2 8-bit serial shift register settings on EVB ; set by the ZSSC324x Evaluation Software

Signals are highlighted on Figure 3

Figure 3. Signal Connections: SSC Communication Board and ZSSC324x EVB

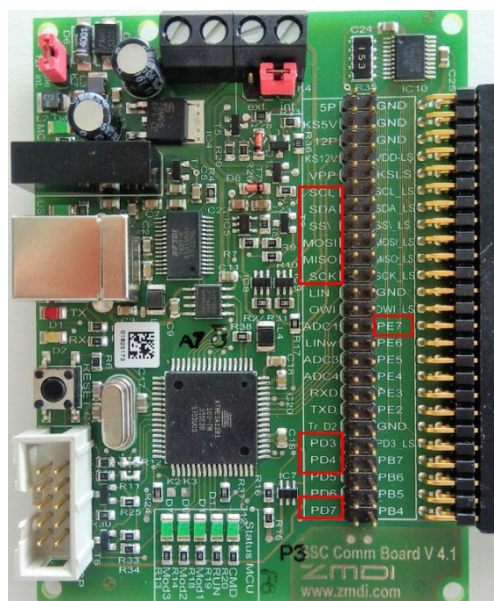

For a complete description of the SSC CB, refer to the relevant datasheet available at the following link:

<https://www.idt.com/products/sensor-products/sensor-signal-conditioners/ssc-cb-ssc-communication-board>.

Table 4. Signal Connections: ZSSC324x Evaluation Board and the Sensor Replacement Board

Name	Pin	Description
5P	1	5VDC
GND	2-4-...-48-50	Ground
SCL	11	I2C Clock
SDA	13	I2C Data
AnodeD1	37	Diode for external temperature sensing
VSSB	43	Bridge negative supply voltage
VDDB	45	Bridge positive supply voltage
INP	47	Bridge positive signal
INN	49	Bridge negative signal

Refer to Figure 4, to display the odd numbered pins on the PCB.

Figure 4. Signal Connections: ZSSC324x EVB and SRB

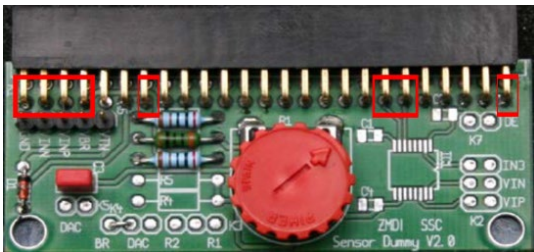

Table 5. Evaluation Board Connections Descriptions

Refer to Figure 2 to identify the connections listed in Table 5

Connector	Type	Description
J1	4-Pin Header	Bi-directional connections to sensor module
J4	2×25-Pin Header Male Right Angle	Bi-directional connection from Evaluation Board to Sensor Replacement Board.
J5	2×25-Pin Header Female Right Angle	Bi-directional connection from SSC Communication Board to Evaluation Board.
J2, J3, J6, J7	2×10-Pin Header – Male	Direct access to the pins of the ZSSC324x. Each chip pin can be connected to VDD or GND with optional 2.54mm jumper.
X1	24-Pin ZIF socket	ZSSC324x socket
J15	2-Pin Header – Male	Jumper for selecting additional I2C pull up resistor on the SDA line. Leave disconnected when I2C is not used.
J16	2-Pin Header – Male	Jumper for selecting additional I2C pull up resistor on the SCL line. Leave disconnected when I2C is not used.
J24	2-Pin Header – Male	Jumper for selecting additional pull up resistor on the OWI line. Leave disconnected when OWI is not used.
J21	3-Pin Header – Male	Jumper for selecting I2C or SPI communication. Place a jumper between pins 1-2 for I2C, or between pins 2-3 for SPI operation.
J22	3-Pin Header – Male	Jumper for selecting I2C or SPI communication. Place a jumper between pins 1-2 for I2C, or between pins 2-3 for SPI operation.
J17	2-Pin Header – Male	Jumper for supplying power to the non-inverting amplifier.
J18	2-Pin Header – Male	Jumper for connecting the output of the ZSSC324x to input of the non-inverting amplifier.
J19	3-Pin Header – Male	Jumper for selecting the gain of the non-inverting amplifier. Connect pins 1-2 for gain 10, or 2-3 for gain 2. Pin 1 is the one facing R20.
J20	2-Pin Header – Male	Jumper for additional 10kΩ load on the output of the non-inverting amplifier.
J8	2-Pin Header – Male	Allows connecting the OWI2 pin to the SSC CB OWI pin
J9	2-Pin Header – Male	Allows connecting the AOUT/OWI1 pin to the SSC CB OWI pin
J10	3-Pin Header – Male	Selects either Voltage or Current output signal. Place a jumper between pins 1-2 for Voltage output signal (0-1V, 0-5V, 0-10V with the onboard amplifier, or OWI) or between pins 2-3 for Current output signal (4-20mA or OWI with Aout-Current Loop)
J11	2-Pin Header – Male	Place a jumper to supply the EVB with 12VDC (in conjunction with J12 setting)
J12	3-Pin Header – Male	Jumper for selecting the source for the VDD voltage. It can be supplied either from: <ul style="list-style-type: none"> • KS5V rail, from the CB. Short pins 1-2. • KS12V rail, from the CB. Short pins 2-3. • For current loop operation a jumper connecting pins 2-3 must be inserted.
J23	2-Pin Header – Male	HW identification

Table 6. Jumper Settings for Analog Output Selection

Output Type	Signal Type	Analog Output	Power			Amplifier			V/I	Rsense		Notes
			J11	J12	P1	J17	J18	J19	J10	J13	J14	
Analog	Voltage	0-1V	open	1-2	open	open	open	open	[b]	open	open	- J10 can be set for LP-filter application at AOUT - Output voltage at AOUT
		0-5V	open	1-2	open	open	open	open	[b]	open	open	
		0-10V	open	1-2	open	1-2	1-2	2-3	1-2	open	open	- Output voltage at pin 1 of J20
	Current	4-20mA	[a][b]	2-3	external	open	open	open	2-3	[a]	open	- Connect an ampere meter at J13 for measuring the current in the current loop

[a] Ammeter
[b] Not relevant

Table 7. Jumper Settings for Digital Interface Selection

Output Type	IF Choice	J15	J16	J21	J22	J24	J8	J9	Notes
Digital	OWI	[b]	[b]	[b]	[b]	1-2	open	1-2	- Communication via OWI1 only
		[b]	[b]	[b]	[b]	1-2	1-2	1-2	- Communication via OWI1 / OWI2 - In case of Current Loop communication with only works unidirectional.
	I2C	open	open	1-2	1-2	[b]	open	open	
	SPI ^[a]	open	open	2-3	2-3	[b]	open	open	

[a] Default
[b] Not relevant

1.4 Kit Hardware Connections (Default)

The following steps describe the start-up of the kit with default settings:

- JP12: Jumper between VDD and KS5V (from the SSC CB)
- JP21/22: Communication interface to the SSC: SPI (short SDA/MOSI to MOSI pin and SCL/SCK to SCK pin)

Follow these steps to connect the three PCBs as shown in Figure 1:

1. Connect the ZSSC324x Evaluation Board (J5) to the SSC CB v4.1 (K6)
2. Connect the ZSSC324x Evaluation Board (J4) to the Sensor Replacement Board

Important: Do not connect the SRB to the SSC EVB if a custom sensor module is used.

3. Replace the dummy IC in the socket with an actual ZSSC324x device under test (DUT). Take care to orient the pin 1 as shown in Figure 5. An ESD safe vacuum suction pen should be used for correct handling of the ICs. The smallest suction cup is best suited for the ZSSC324x samples.

The assembled kit looks like as per Figure 1, with jumpers as per Figure 5. See section 1.6 for the steps regarding the external lab equipment connections.

Figure 5. Jumpers on the SSC Communication Board and the ZSSC324x EVB

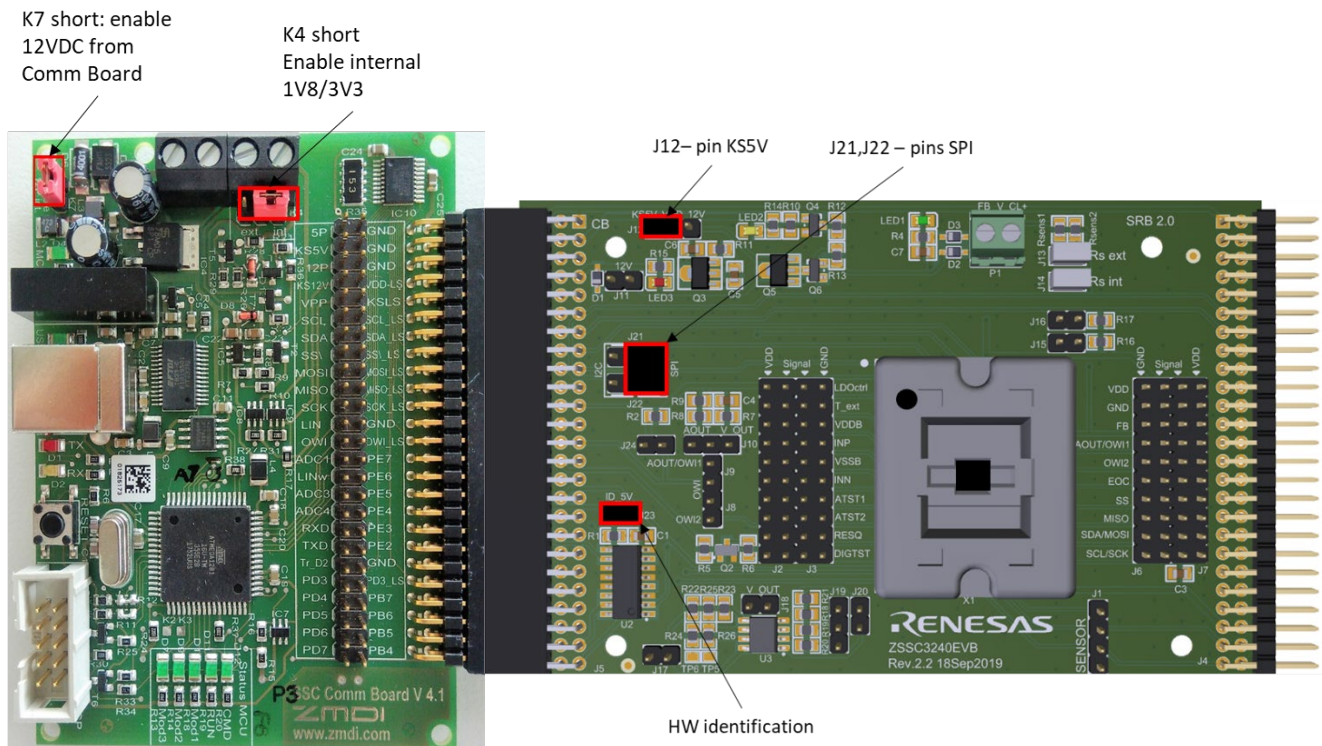

1.5 Communication Interfaces

The ZSSC324x device supports SPI, I2C and OWI as communication interfaces. The Evaluation Board supports all three of them, while only one can be active a time. Section 2.1.2 provides details about the corresponding Graphical User Interface (GUI) settings.

The ZSSC324x Evaluation Board is using the SSC CB to translate these interfaces to USB. Only one SSC CB can be connected to the user's computer to operate GUI normally.

The ZSSC324x Evaluation Software is intended for demonstration purposes and calibration of single units. Upon request, Renesas provides the user with algorithms and assistance in developing their full production calibration software.

1.6 External Equipment Connections

Follow these steps to connect the lab equipment and user's computer to the kit as shown in Figure 6:

1. Connect the ammeter (J13) to monitor the current in the 4-20mA current loop (optional step).
2. Connect the voltmeter (J6 GND pin and J7 AOUT/OW11 pin) to monitor the analog output voltage of the ZSSC324x, (optional step)
3. Connect the USB cable from the USB connector on the SSC CB to an available port on the user's computer.

Important: Make sure that there is no other SSC CBs connected to the user's computer.

Figure 6. Lab Equipment Connections

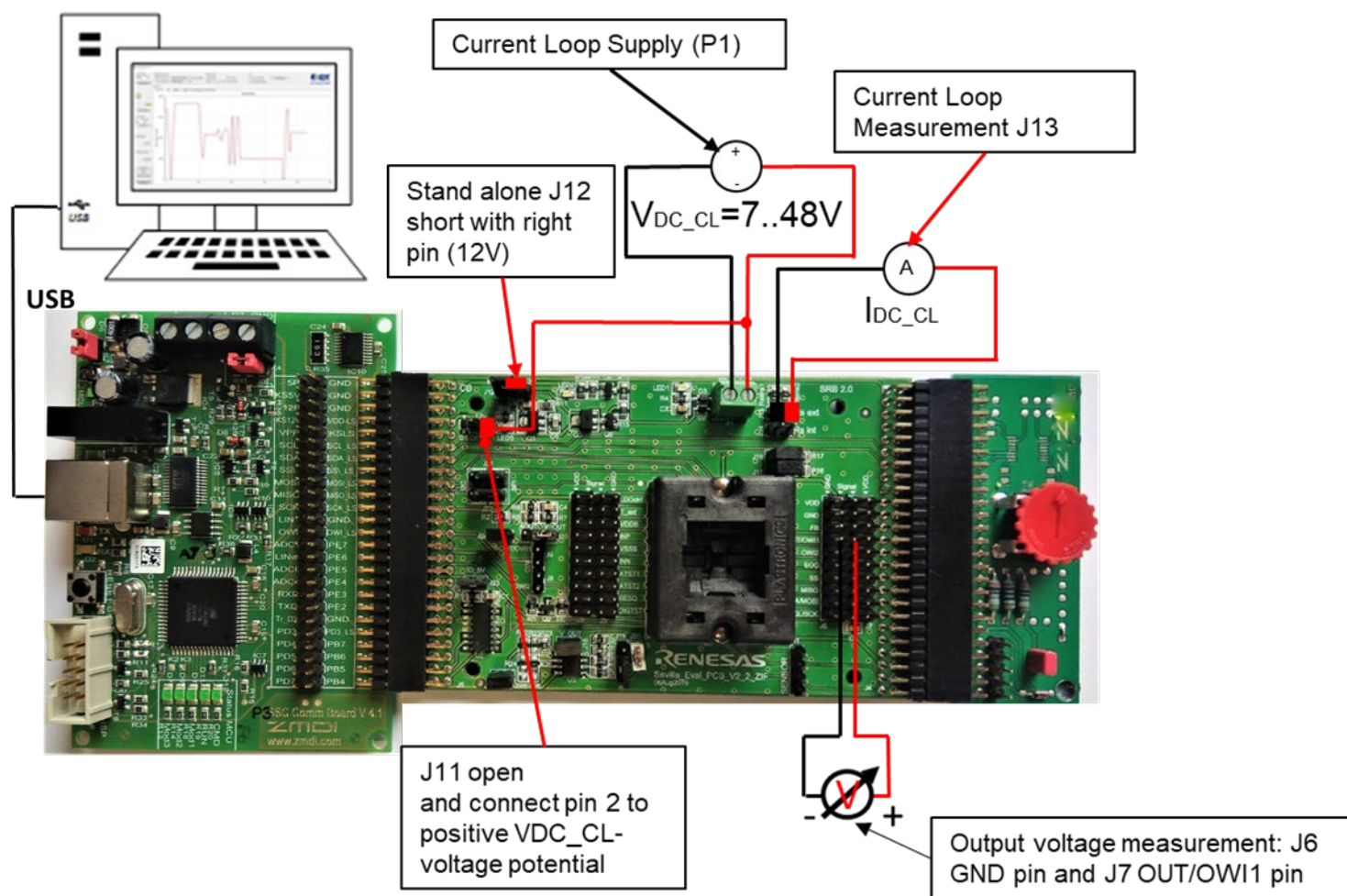

1.7 Power Supply Option

The ZSSC324x power (VDD) can be supplied in different ways:

- SSC Communication Board KS5V rail – default option. The 5V directly power the ZSSC324x device.
- SSC Communication Board KS12V rail. The 12V is regulated down to a value between 4.8V and 5.4V (depending on the configuration settings) by the ZSSC324x and the onboard pass transistor Q5.
- Current loop master device. Typically, the current loop is supplied with a voltage between 7V and 48V, which is then regulated down to a value between 4.8V and 5.4V (depending on the configuration settings) by the ZSSC324x and the onboard pass transistor Q5.
- Externally connected supply. A low-noise laboratory power supply or battery could be used to achieve better performance or accuracy.

Note: If an externally connected supply is used, adjust the external power supply to the proper voltage and current levels (see also Table 8) before connecting the supply to the kit.

Important: The maximum voltage for an external supply is 48V. If using an external power supply, do not apply the power connection until jumpers are properly set and HV option has been selected in the GUI.

Table 8. Power Supply Selection

Source		P1	J11	J12	J13	J14	Notes
Internal source	5V from the SSC Communication Board	Open	open	1-2	open	open	
	12V from the SSC Communication Board	Open	1-2	2-3	open	open	LDO ctrl must be enabled.
External source	Power from the current loop	Apply source here	open	2-3	To current loop	open	LDO ctrl must be enabled. Pin 1 of P1 is the Positive terminal.
	7V - 48V	Open	Apply source here	2-3	open	open	LDO ctrl must be enabled. Positive terminal to J11, LED3 facing pin, negative terminal to any GND pin

1.8 Power-up Procedure

After connecting the CB via USB to the user's PC, the LEDs provide the status of the Communication Board. Figure 7 shows the status of a correctly connected and powered CB.

Figure 7. LEDs Status CB - Ready for Operation (without GUI Running)

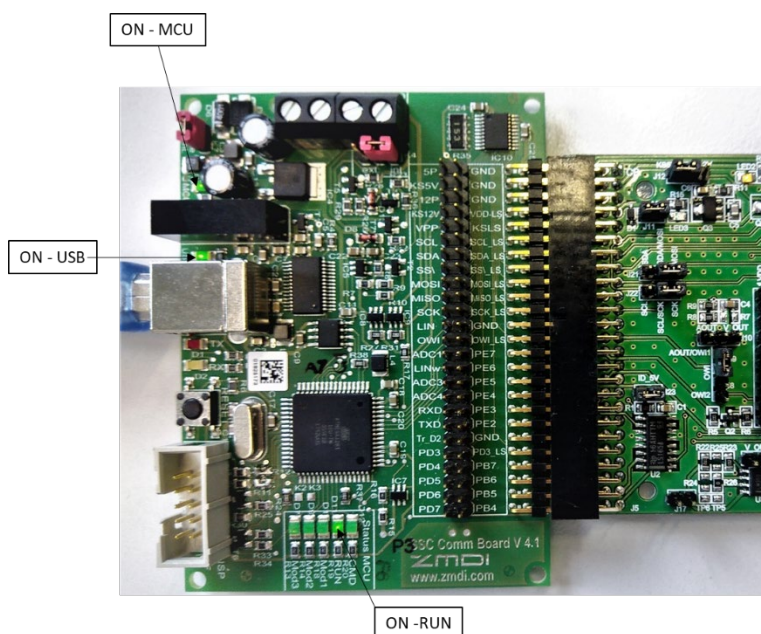

Once the Kit is set up as instructed, the final step is to launch the GUI. To do this go to the Host PC location where the ZSSC3240_Evaluation_SW_vX.XX.zip file was extracted and run the ZSSC324x_Evaluation_SW_vX.XX.exe. Once the GUI has established the connection to open the assigned virtual COM port, it powers the ZSSC324x Evaluation Board from the CB with 5V, and configures SPI as initial communication interface. This turns ON the green LED1 and orange LED2 (both on the SSC EVB, see Figure 8), indicating that the ZSSC324x is powered from the KS5V rail of the SSC CB. Additionally, the IC status section of the GUI reflects this by highlighting the virtual LEDs **Powered** and **CMD Mode** Figure 9. The kit is now ready to use.

Figure 8. LED Status after Starting the Evaluation SW

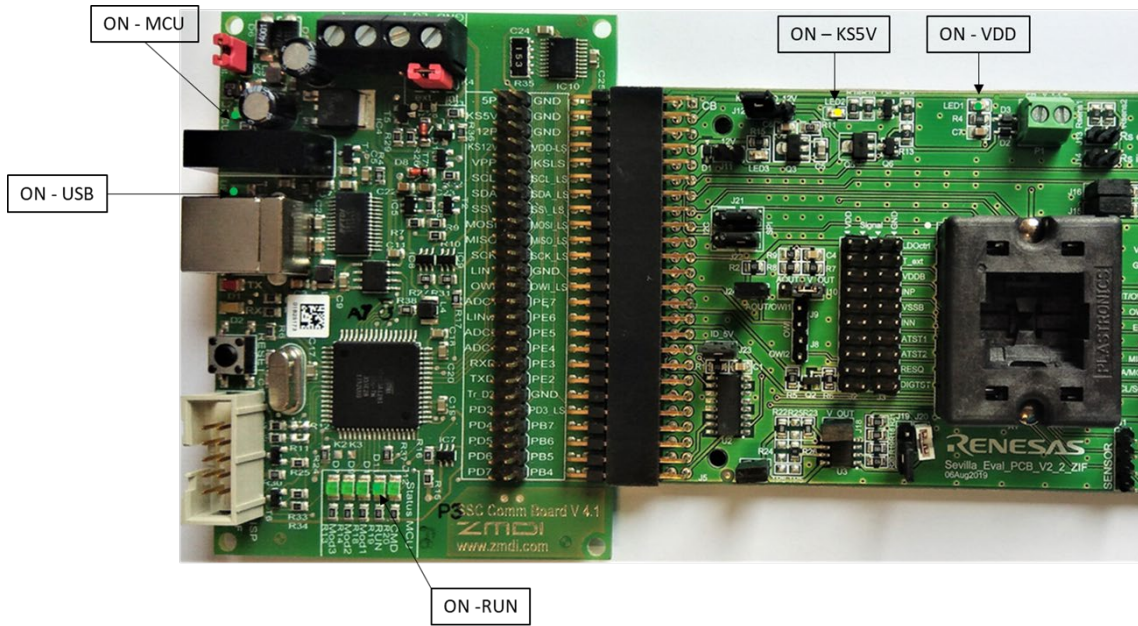
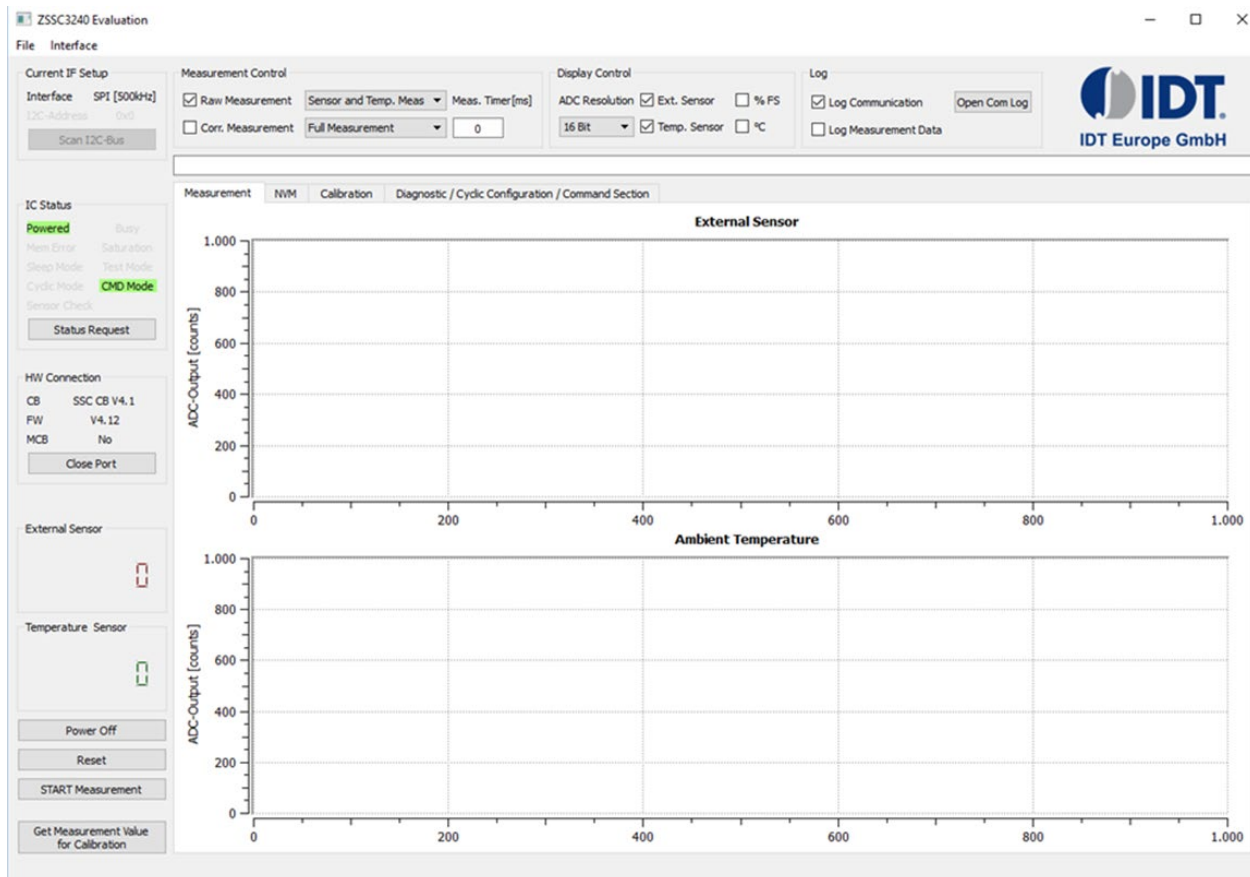

Figure 9. Initial GUI Display



2. GUI

The main screen of the GUI is shown on Figure 10. It is divided in nine parts, which allow the user to carry out each step when evaluating the ZSSC324x device.

1. Menu Bar - provides Save \ Load capabilities for NVM content and interface configuration changes; for details see section 2.1.
2. Interface Settings - the selected communication interface and its configuration are shown here; for details see section 2.1.2.
3. Measurement Control – allows selection between display of Raw or Corrected data for both the sensor data and temperature; for details see section 2.3.
4. Display Control – controls the choice of how and which measured data are displayed on the GUI, for example, ADC resolution; for details see section 2.4.
5. Logging Options – both the communication data and the measurement data can be logged selecting the relevant options; for details see section 2.5.
6. Status – displays the status of the ZSSC324x with the last sensor and temperature reading. Data for the Communication Board is also provided; for details see section 2.6.
7. Tabs – four main tabs are used for setting up the ZSSC324x device and then verifying its correct operation; for details see section 2.7.
8. Information Bar – provides basic information for some of the operations of the ZSSC324x, for example, calculating the calibration coefficients and the save/load NVM contents; for details see section 2.9.
9. Main Buttons - Power, reset, measurements, measurements for calibration; for details see section 2.8.

Figure 10. ZSSC324x GUI Main Screen

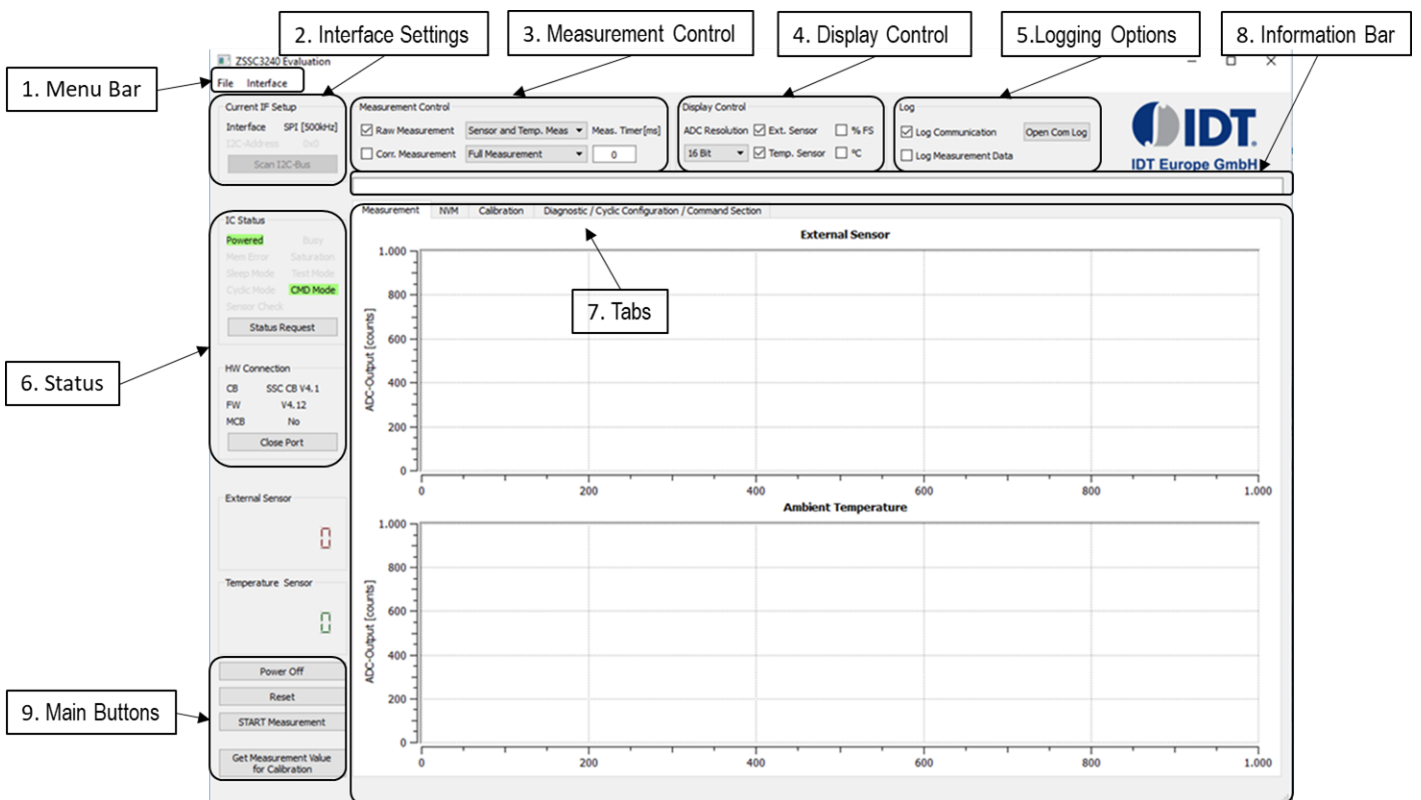

2.1 Menu Bar

This section controls the file operations regarding the NVM content and the communication interface setup of the ZSSC324x device.

2.1.1 NVM Control

The content of the NVM can be Saved or Loaded from the File menu.

Figure 8. ZSSC324x NVM Memory Map

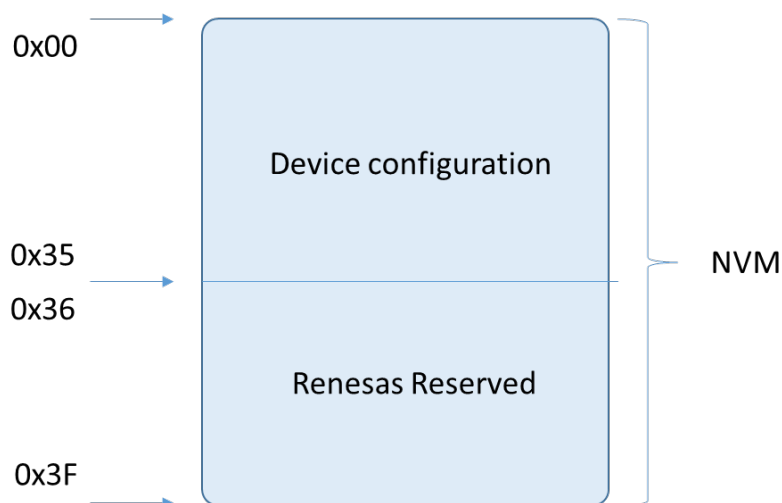

2.1.1.1 Save NVM Config

This menu item saves the last read content of the NVM to a readable text file. Each row of the file represents the content of each NVM register value represented in decimal notation. The file shows 64 NVM registers, while only the first 54 are accessible by the user. Do not modify the last 10 NVM registers (0x36 to 0x3F), as they contain factory information.

Figure 11 shows the first three lines that represents the contents of the first three addresses in the NVM. In this example, the *Customer_ID* fields are left empty, while the Interface Config register has a value of 72_{DEC} = 48_{HEX}. This file is located by default in the same folder as the GUI executable file. The GUI overwrites the already existing NVM dump file, therefore it is recommended to rename the saved file just after the finish of the saving. After a successful saving, the information bar displays a note with the full path to the saved file.

Figure 11. NVM_config text file

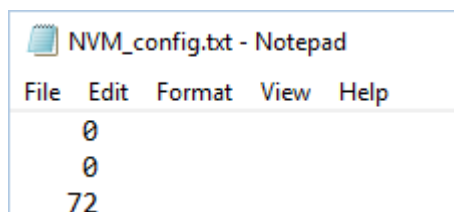

When NVM saving is executed (by selecting *File > Save NVM Config*), the saved content is always the one shown on the GUI. To transfer the actual NVM content of the ZSSC324x device to the shadow copy, the *Read NVM* button must be used. See section 2.7.2 for information about reading the NVM. In some cases, the NVM shadow copy content in the GUI may differ from the actual content of the ZSSC324x. An example of such case is when there is more than one master device that communicates with the IC. In order to minimize this risk, disable any other master devices that communicates with the ZSSC324x and always read the content of the NVM before saving it to file.

2.1.1.2 Load NVM Config

To load a configuration file, select *File > Load NVM Config*.

Note: The decimal values are automatically displayed as hexadecimal values on the NVM tab. The loaded configuration data is displayed in red font on the NVM tab and can be written into the memory.

Load NVM Config allows loading a previously saved NVM configuration to the GUI. When applied, a dialog window appears that allows the user to select a file. Pressing the *OK* button in the window, loads the contents of the file to the shadow copy of the NVM on the GUI. Information on how to write the data to ZSSC324x device is presented in section 2.7.2.

Before loading the NVM, stop any ongoing measurements.

2.1.2 Interface Setup

This menu allows setup of the communication interfaces: OWI, SPI and I2C.

2.1.2.1 SPI

The GUI starts with 500kHz SPI as the default selection. Selecting a communication interface from the menu, runs the desired interface using its default settings. Changes to these settings are done via the *Setup* menu item. As shown on Figure 12, only the settings for the currently selected interface are enabled.

By default the SPI serial communication is selected.

Figure 12. Communication Interface Setup SPI

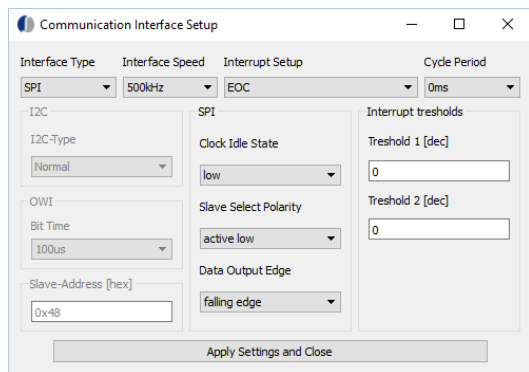

2.1.2.2 I2C

If I2C is the applied interface, the setup shows the parameters as displayed in Figure 13. The default values are loaded to the GUI from the register content 02_{HEX}. If the default address is changed, the Slave-address needs to be changed on this sub-tab.

Figure 13. Communication Interface Setup - I2C

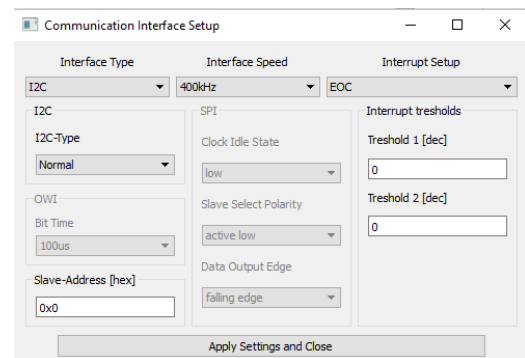

2.1.2.3 OWI

When the OWI interface type is selected, the available configuration options are displayed as in Figure 14. The default values are loaded to the GUI from the register content 02_{HEX}. If the default address is changed, the Slave-address needs to be changed on this sub-tab.

Figure 14. Communication Interface Setup - OWI

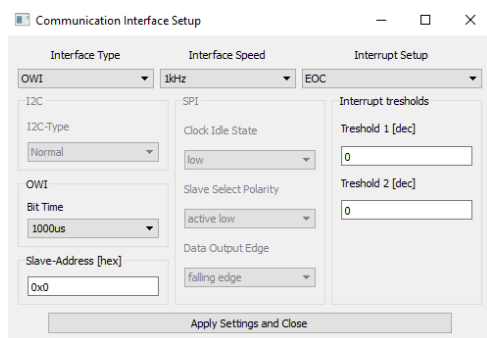

For using the above serial interfaces, the correct jumper setting is required before attempting to establish communication, see Table 7.

2.1.3 Output Interrupt Signaling

The EOC pin can be configured to two different purposes, either as End-Of-Conversion signaling or as Interrupt output. Both options require the ZSSC324x device to use corrected data. If the device is set to provide only raw data, the EOC pin is not functional. Information on how to set the device to work with corrected data is presented in section 2.3.1 .

With the EOC configuration $INT_setup = 00_{BIN}$, the EOC pulse is approximately 5 μ s long. After setting the threshold 1 / 2 values, pressing the *Apply Settings and Close* button converts the inputs in the proper format (the values must be input in the decimal representation).

Figure 15 displays the selectable lower and upper threshold values for the interrupt configuration (see *ZSSC324x Data Sheet* for details on thresholds).

Modifications entered in the dialog are valid for further communication after this window is closed. To save the changes in the ZSSC324x's memory, adjust the parameters as needed and click the *Copy Settings to Memory* button to transfer it to the *NVM* tab on the GUI. As a result, the register 02_{HEX} (*Interface Configuration*) and/or registers 18_{HEX} , 19_{HEX} , and $1A_{HEX}$ (interrupt thresholds) appear red if their content changed. Click the *Write NVM* button at the bottom of the GUI to write the new content into the memory.

Figure 15. Threshold Setup

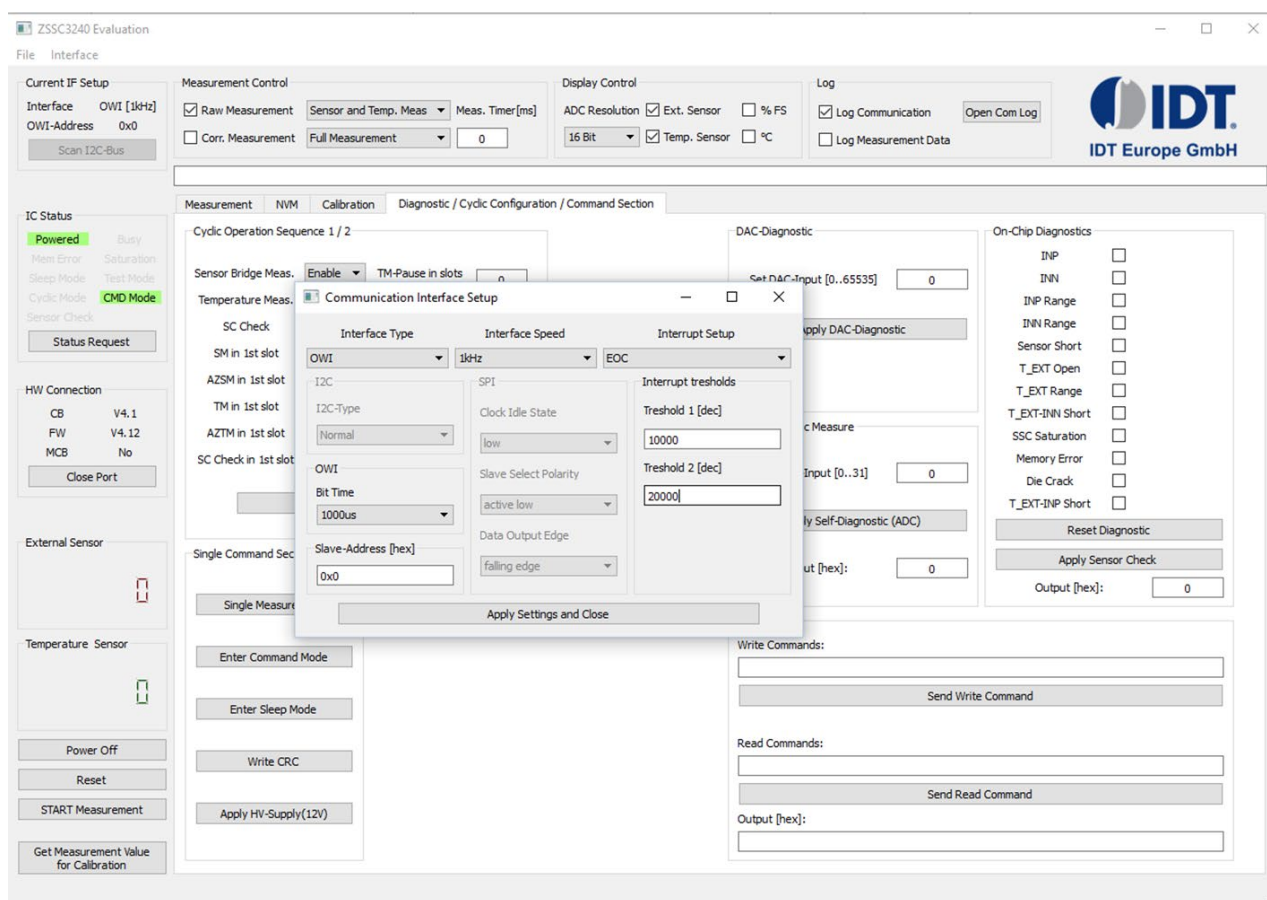

2.2 Current Interface Settings

When the I2C communication interface is selected (see Figure 13), the *Scan I2C bus* button is enabled on the main screen. It provides the ability to scan the I2C bus to determine the I2C address of the ZSSC324x. Selecting *Scan I2C address* triggers the scan during which the ZSSC324x status is requested for each address ranging from 00_{HEX} to $7F_{HEX}$. When, at a certain I2C address, a valid IC-status is provided by the ZSSC324x, the scan stops, and this address is used for further communication during the current GUI session. The result of the scan is indicated on the *Information Bar*:

- Status window message for a successful I2C scan: Valid I2C address found: 0xXX!
- Status window message for an I2C scan without slave acknowledge: No valid I2C address found!

The I2C address information is lost if the GUI or the communication port is closed. Communication to the ZSSC324x with an I2C address other than 00HEX can also be established by entering it manually to the Interface Setup dialog. The dialog is accessible via the top menu bar by selecting *Interface Setup* and entering the hexadecimal address in the *I2C Slave Address* field.

2.3 Measurement Control

2.3.1 Measurement Commands

The ZSSC324x can provide either the raw or corrected measurement results. Depending on which of the two checkboxes is selected, the GUI sends different commands to the IC. When the raw measurement is selected, the GUI sends first the raw sensor measurement command, and then after reading the received data, the raw temperature measurement command is sent to the IC.

The raw data output provides the results directly after the analog-to-digital conversion (ADC).

In case of SSC corrected measurements, the raw ADC output is passed to the math core where the calculated coefficients are applied. This measurement mode provides reasonable results only after a valid calibration of the ZSSC324x. The corrected data is from either a single measurement, or as an average of 2, 4, 8, or 16 consecutive samples.

If one oversampling option is selected from the dropdown menu, see Figure 16, the software sends the corresponding measurement command to the ZSSC324x to enable IC-internal averaging of the measurement results. The drop down menu selection determines the number of measurements that are used for calculating the average result, which is displayed in the measurement results fields and on the main graph. The commands used for the implementation of these measurements are listed in Table 9. Averaging extends the time until the results appear on the GUI by the factor of adjusted average values.

Figure 16. Corrected Measurement Oversampling

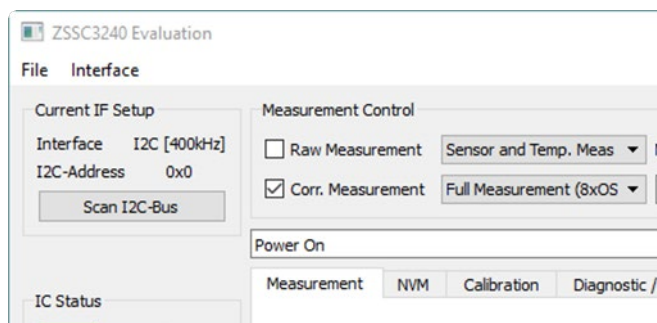

In the same drop down menu, it is possible to set the measurement command to Measure Cyclic (Command AB_{HEX}), which triggers a continuous full measurement, as it is configured in the SSF2 register and in the measurement scheduler. Pressing the *START Measurement* button starts the Cyclic Mode. After that, the ZSSC324x internally triggers the measurements, such that the GUI is sending only reading sequences in order to periodically read the output registers. If *STOP Measurement* is applied, the command BF_{HEX} and A9_{HEX} are sent. The first stops the Cyclic Mode, the second sets the IC in Command Mode (CM).

Note: In Cyclic Mode, the ZSSC324x always provides BUSY=1 (see Figure 17) until the *STOP_CYC* (Command BF_{HEX}) command is sent.

Figure 17. Cyclic Measurements – Busy Status

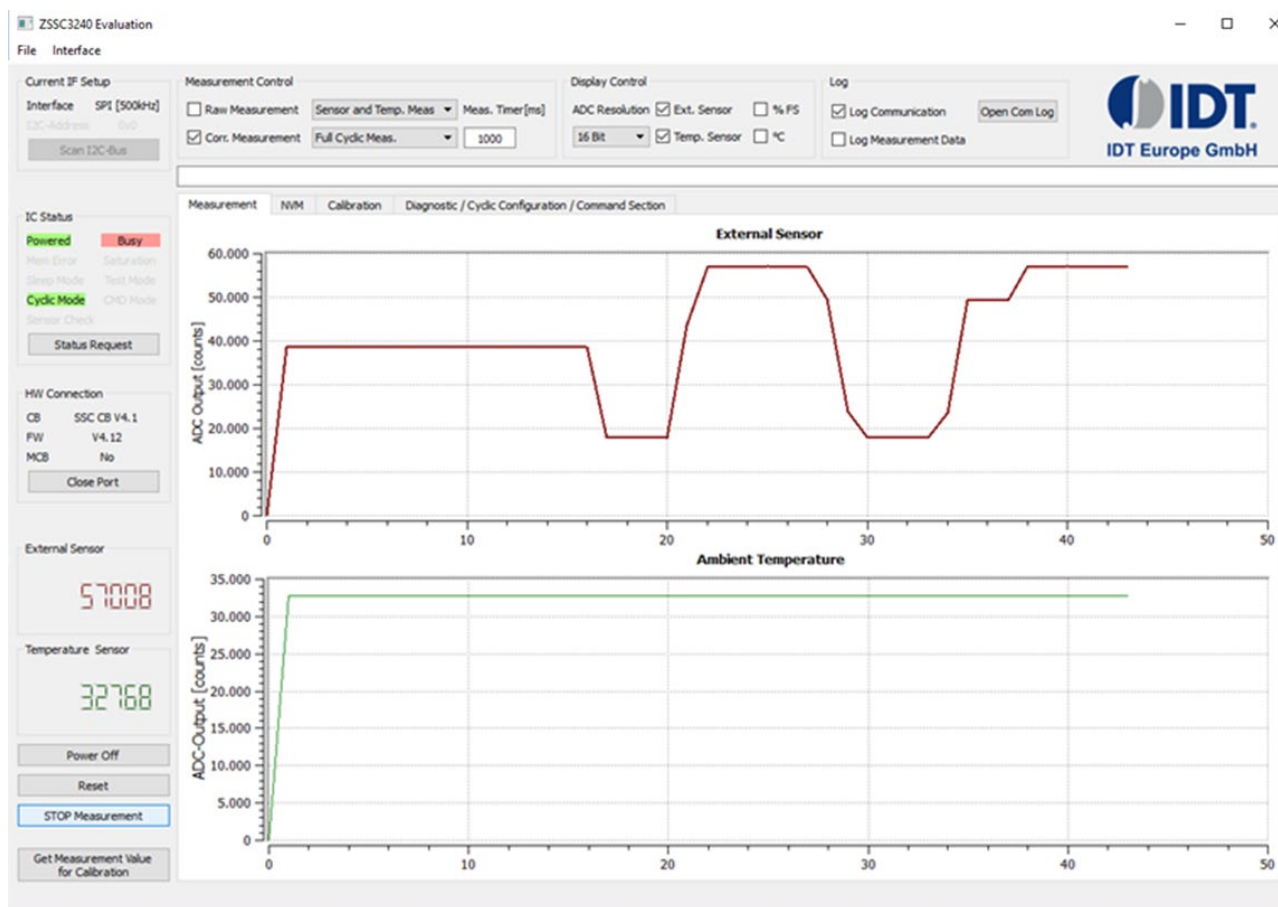

Regardless of the measurement data type, a delay (in ms) could be added between the triggered measurements and the following reading sequence. The default value is 0ms, which allows the highest update rate, mainly limited by the USB timings. In case the BUSY flag is getting red in the IC status panel (see Figure 17), a delay can be added to return to normal status (except in Cyclic Mode). The list of non-cyclic measurements commands is shown in Table 9.

Table 9. Measurement Commands

Command	Data type	Description
A2 _{HEX}	raw	Raw Sensor Measurement
A4 _{HEX}		Raw Temperature Measurement
AA _{HEX}	corrected	Measure – trigger full measurement (depending on configuration) and perform SSC-correction
AC _{HEX}		Oversample-2 Measure - mean value generation; 2 full measurements (like triggered with AA _{HEX} , not cyclic) are performed and the resulting mean value is provided as output
AD _{HEX}		Oversample-4 Measure - mean value generation; 4 full measurements (like triggered with AA _{HEX} , not cyclic) are performed and the resulting mean value is provided as output
AE _{HEX}		Oversample-8 Measure - mean value generation; 8 full measurements (like triggered with AA _{HEX} , not cyclic) are performed and the resulting mean value is provided as output
AF _{HEX}		Oversample-16 Measure - mean value generation; 16 full measurements (like triggered with AA _{HEX} , not cyclic) are performed and the resulting mean value is provided as output

2.4 Display Control

The measurement tab displays by default both the Sensor and the Temperature data. If required, one (or both) can be turned off by unchecking the box on the display control area (see Figure 18).

Figure 18. Measurements Visualization

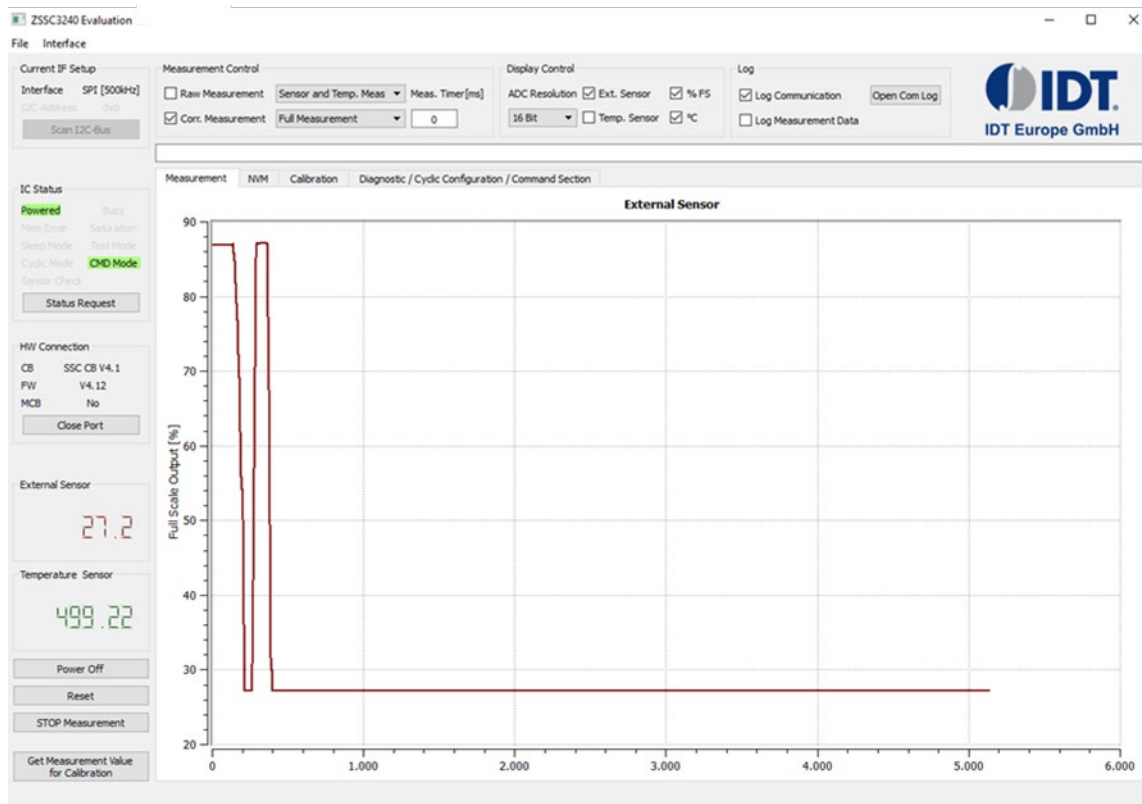

For most applications the maximum resolution of 24bits of data is not needed. The ADC resolution drop down menu allows scaling of the displayed data, regardless of the actual ADC setting of the ZSSC324x, as shown in Figure 18.

Measurement results are numerically displayed on the left of the main graph. Both digitally displayed numbers are adjusted to the resolution that is configured for the particular measurement; for example, if executing an external sensor measurement with a resolution of 24 bits, the GUI shows a raw digital output with a minimum input of -8388608 and maximum output of 8388607 counts.

Each measurement result coming from the ZSSC324x is structured in 3 bytes (24-bit). The GUI limits the data display to the selected resolution via software. The original stream of bits can be viewed by logging the communication. The graph shown in Figure 19 is an example of the resolution range from the chip through the communication channel to the GUI display.

Figure 19. Resolution Range from Chip to GUI

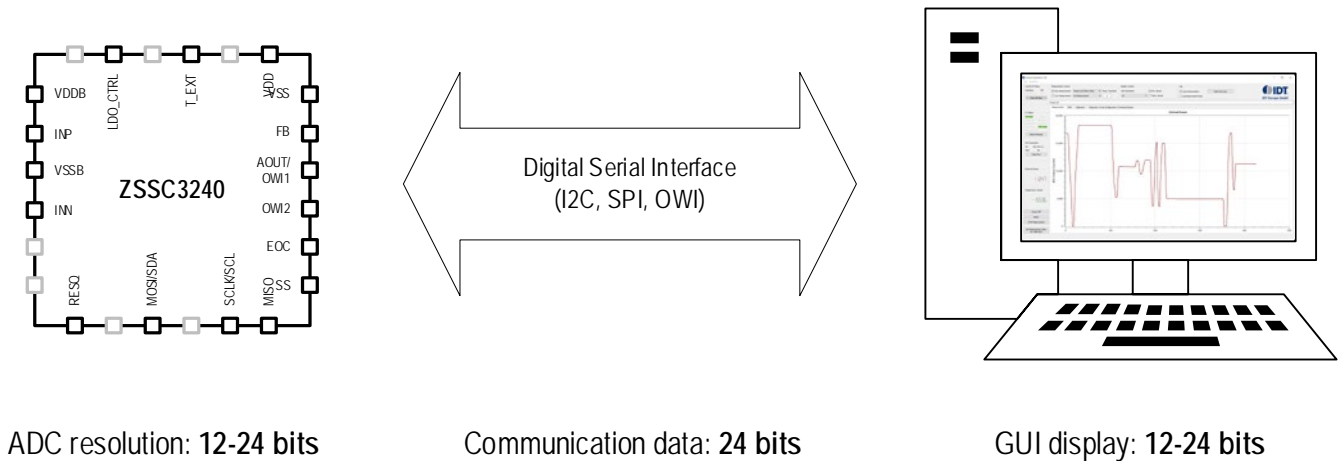

2.5 Logging Options

The GUI offers two powerful logging options (shown in Figure 20):

- Logging of the communication stream between the ZSSC324x and the microcontroller on the SSC Communication Board. The communication log is always enabled. Click on the *Open Com Log* button to visualize the traced communication.
- Logging of the Measurements Data from the ZSSC324x
Click on the relevant checkbox to enable the measurement data log. Click on the *Open Meas Log* button to visualize the traced measurements.

Log files are stored in the same folder as the *ZSSC324x_Evaluation_SW_vX.XX.exe* file.

Figure 20. Logging Options

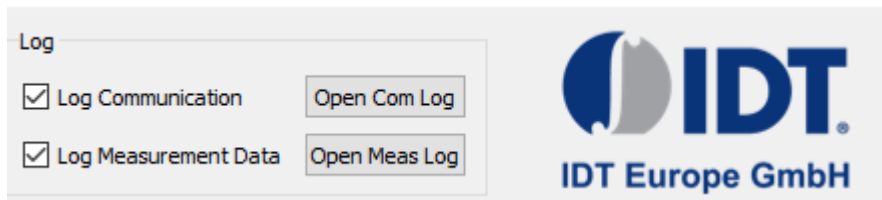

2.5.1 Communication Log

In Figure 21, Figure 22, and Figure 23, examples of command logs in case of SPI, I2C and OWI serial interfaces communication are shown.

Figure 21. Communication log SPI

```
send_spi: 'SW_008AA0000000000000' response: 'ACK'
receive_spi: 'SR_007' response: '441E26DF800000'
send_spi: 'SW_008AA0000000000000' response: 'ACK'
receive_spi: 'SR_007' response: '441E2702800000'
```

Figure 22. Communication log I2C

```
send_i2c: 'IW_48001AA' response: 'ACK'
receive_i2c: 'IR_48007' response: '441E3541800000'
send_i2c: 'IW_48001AA' response: 'ACK'
receive_i2c: 'IR_48007' response: '441E3541800000'
```

Figure 23. Communication OWI

```
send_owi: 'OW_00001A2' response: 'ACK', ''
receive_owi: 'OR_00004' response: 'ACK', '40701D47'
send_owi: 'OW_00001A4' response: 'ACK', ''
receive_owi: 'OR_00004' response: 'ACK', '40F1BE00'
```

2.5.2 Measurement Data Log

Measurement data can also be recorded in the measurement log file by clicking on the *Log Measurements Data* checkbox in the top section of the GUI (see Figure 10). Note that this will clear any previous measurement data in the measurement tab, and will start a new log file. Once the *Log Measurement Data* is checked, users can start and stop the measurements and experiment with the ZSSC324x. All the data are appended to the log file, until the *Log Measurements Data* box is unchecked again.

The data is logged in the same way as it is displayed. Any change of the measurement control and display control affect the log file.

2.6 Status

2.6.1 IC Status

For every bit in the status byte there is a text that represents its meaning (Figure 24). When the bit is equal to “0”, the text is grayed out, while when the bit is “1” the text is colored either in green (for Powered, Sleep Mode, Test Mode, Cyclic Mode, CMD Mode) or red (for Busy, Mem Error, Saturation, Sensor Check).

The status is updated automatically for any reading sequence from the ZSSC324x. It can also be updated manually by clicking on the *Status Request* button. Table 10 shows the meaning of the various status indicators according to relevant background color.

Figure 24. IC status

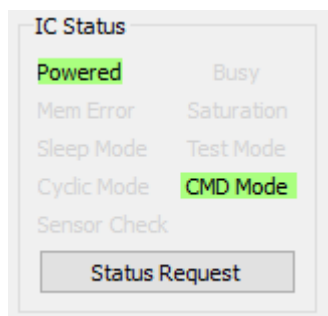

Table 10. IC Status Indicators

Control	GUI	Default	Virtual LED Indication
Powered	Powered		The ZSSC324x is not powered correctly or no valid communication is present.
	Powered	✓	The ZSSC324x is powered correctly.
Busy	Busy	✓	The ZSSC324x device is not busy, commands can be processed.
	Busy		The ZSSC324x device is busy, which indicates that the data for the last command is not available yet. No new commands are processed.
Mem Error	Mem Error	✓	The CRC (Cyclic Redundancy Check) test passed.
	Mem Error		The CRC test has failed.
Saturation	Saturation	✓	No saturation of the ALU.
	Saturation		An error has occurred due saturation of the internal ALU (Arithmetic Logic Unit).
Sleep Mode	Sleep Mode	✓	The ZSSC324x is not in Sleep Mode.
	Sleep Mode		The ZSSC324x is in Sleep Mode.
Test Mode	Test Mode	✓	The ZSSC324x is Not in Test Mode.
	Test Mode		The ZSSC324x is in Test Mode (only for Renesas use).
Cyclic Mode	Cyclic Mode	✓	The ZSSC324x is not in Cyclic Mode.
	Cyclic Mode		The ZSSC324x is in Cyclic Mode.
CMD Mode	CMD Mode		The ZSSC324x is not in Command Mode.
	CMD Mode	✓	The ZSSC324x is in Command Mode and remains active and ready to receive dedicated commands.
Sensor Check	Sensor Check	✓	Check the range of the bridge inputs (INP and INN) to ensure no breaks and shorts are present.
	Sensor Check		Break or short is detected.

2.6.2 Hardware Connection

This section (see Figure 25) provides basic information regarding the Communication Board and the Mass Calibration Board (MCB).

Figure 25. HW Connection

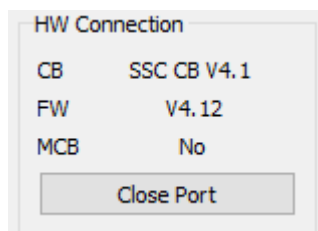

The *Open Port / Close Port* button allows opening and closing the USB communication port. This is useful for making hardware changes (for example, switching the DUT or jumper settings) without exiting the GUI.

2.6.3 Sensor and Temperature Readings

The data for the sensor reading and temperature reading received from the ZSSC324x device is shown in Figure 26. It is converted to decimal notation, and it is affected by the selected *ADC resolution* in the Display Control, see section 2.4.

Figure 26. Sensor and Temperature Display

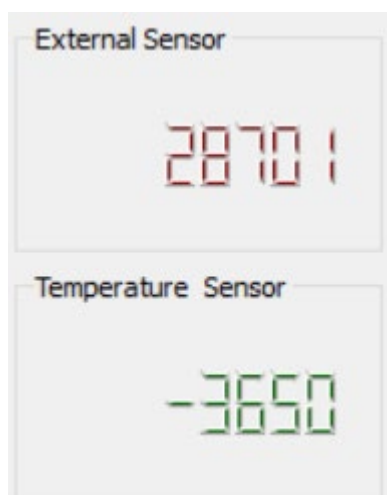

2.7 Tabs

The different tabs on the GUI contain the main tools for configuration and interaction of/with the ZSSC324x.

Each tab groups similar controls that are managing different features of the ZSSC324x.

2.7.1 Measurement Tab

The measurement tab (see Figure 9) presents the data from the external and the temperature sensor in two separate graphs. Each graph is auto scaled according to the Min and Max value of the collected data. Up to 10000 measurements are represented on the screen. Every new measurement data after the initial 10000 clears the earliest data, therefore the displayed graph is made from the data of the last 10000 points maximum. Every time the *START Measurements* button is clicked, the plots are cleared from previous data.

2.7.2 NVM Tab

2.7.2.1 NVM Table

The *NVM* tab is used to display the memory data. The data is displayed in hexadecimal format for each of the first 35_{HEX} (63_{DEC}) registers in the NVM. The final register 35_{HEX} (63_{DEC}) contains the checksum of the entire memory contents. As shown in Figure 27, the first column is the address number; the second column is the description name for the corresponding register, the third column is the data in the register.

The user can change the register content in the NVM table by modifying the desired value directly in the table, or by using the drop down menus of the single parameters. For more information regarding the drop down menu settings, refer to the ZSSC324x datasheet.

Color coding is used to easily identify important information on the table:

- Blue: the selected register.
- Red: modified register (content is different from the last read value).
- Orange: the GUI attempted to write the data to the register, but failed.

The new settings are only effective after the modified registers are written to ZSSC324x NVM and the device is reset. After modifying the NVM, the *Mem Error* flag is set due to differences between the CRC of the old data and the new data. The ZSSC324x can be forced to calculate the new CRC by pressing the *Write CRC* button, see Figure 38

On start-up, the GUI automatically attempts to read the memory content of the connected part. If it fails, the NVM Tab displays the value 0_{HEX} for all registers. The operations for manually reading and writing the NVM are controlled by the *Write NVM* and *Read NVM* buttons below the table. The *Write NVM* button writes only the addresses for which the content is shown in red font on the NVM table. The ZSSC324x must be in Command Mode or Sleep Mode in order to write to the NVM.

Figure 27. NVM Table

Address	Name	Value [hex]
00	Customer_ID_0	0
01	Customer_ID_1	0
02	Interface Config	C8
03	Smart Sensor F. I/O 1	0
04	Smart Sensor F. I/O 2	251
05	OFFSET_S	3300
06	GAIN_S	5338
07	TCG	0
08	TCO	0
09	SOT_TCO	0
0A	SOT_TCG	0
0B	SOT_SENS	0
0C	OFFSET_T	0
0D	GAIN_T	0
0E	SOT_T	0
0F	OFFSET_S / GAIN_S	885F
10	TCG / TCO	0
11	SOT_TCO / SOT_TCG	0
12	SOT_SENS / OFFSET_T	0
13	GAIN_T / SOT_T	0
14	SM_CONFIG 1	C45
15	SM_CONFIG 2	110
16	EXT_TEMP_CNFG1	0
17	EXT_TEMP_CNFG2	0

Write NVM Read NVM

2.7.2.2 SM Config 1/2

This sub-tab provides access to the programmable parameters of the analog front end (AFE). The controls provided are changing the content of registers 14_{HEX} and 15_{HEX} and are shown in Figure 28. For a description of the registers down to bit level refer to the ZSSSC324x Data Sheet.

Figure 28. SM Config 1/2 Sub-Tab



2.7.2.3 Ext Temp. Config 1/2

This sub-tab provides access to the programmable parameters of the analog front end (AFE). The controls provided are changing the content of registers 16_{HEX} and 17_{HEX} and are shown in Figure 29. For a description of the registers down to bit level, refer to the ZSSSC324X Data Sheet.

Figure 29. Ext Temp. 1/2 Sub-Tab



2.7.2.4 Smart Sensor Function I/O 1

This sub-tab provides accessibility to a number of programmable parameters relevant the overall sensor system as Inputs, OWI selection, etc. The controls provided are changing the content of registers 03_{HEX} and are shown in Figure 30. For a description of the registers down to bit level, refer to the ZSSSC3240 Data Sheet.

Figure 30. Smart Sensor Function I/O 1 Sub-tab

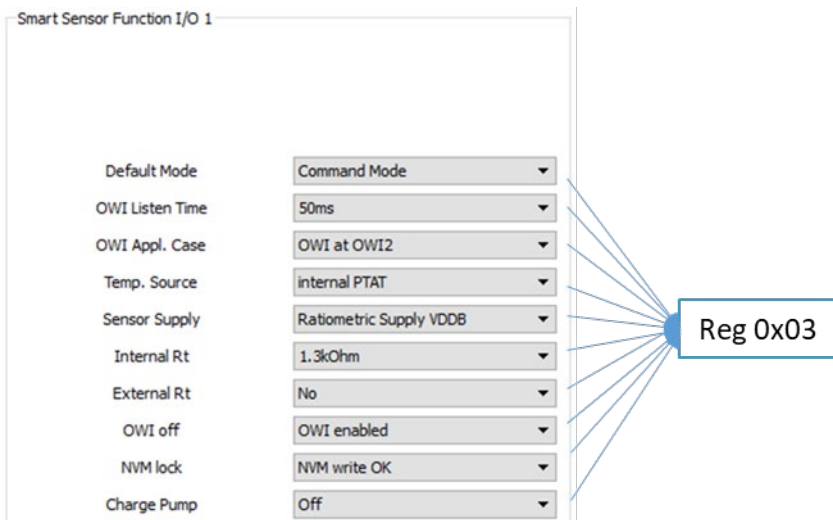

Note: activating the NVM lock bit and writing to memory does not allow a further change in the NVM content.

2.7.2.5 Smart Sensor Function I/O 2

This sub-tab provides accessibility to a number of programmable parameters relevant to the overall sensor system as analog output configuration, DAC resolution, internal LDO (Low Dropout Regulator), etc. The controls provided are changing the content of register 04_{HEX} and are shown in Figure 31. For a description of the registers down to bit level, refer to the ZSSSC3240 Data Sheet.

Figure 31. Smart Sensor Function I/O 2 Sub-Tab

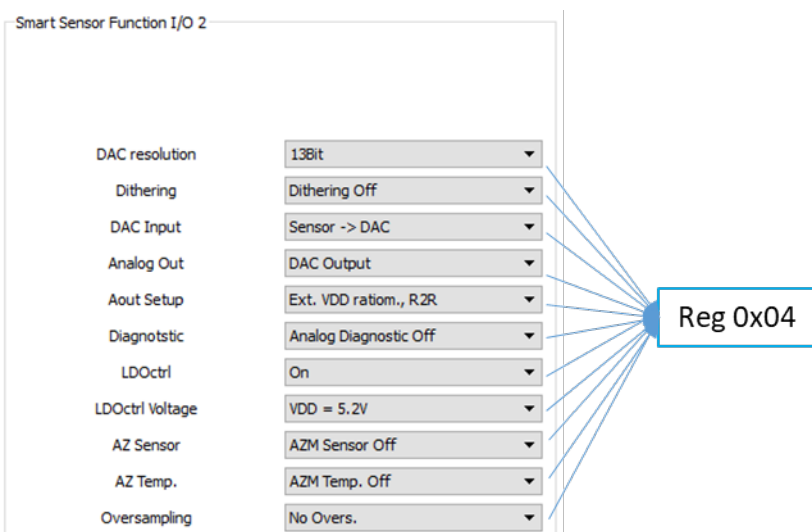

2.7.3 Calibration Tab

The Calibration Tab (Figure 32) allows the user to execute the calibration procedure for the external bridge sensor and/or the temperature sensor. The tab is divided into three main areas:

- Calibration points positions – provides visual representation of the calibration points.
- Calibration points – allows selection of the calibration type.
- Coefficients – shows the calculated calibration coefficients.

Figure 32. Calibration Tab

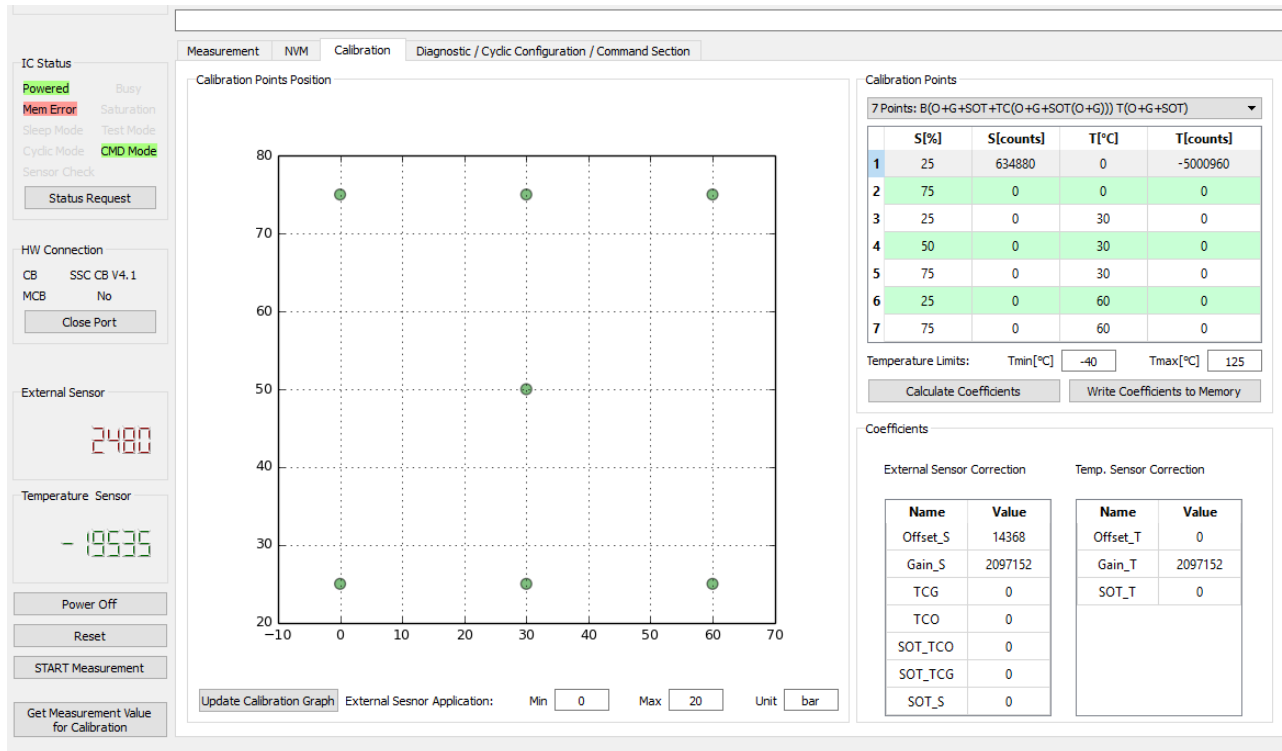

The primary purpose of the *Calibration* tab is the overview of the calibration data and the resulting coefficients. On the top right, the calibration input is displayed where the calibration points are entered. The resulting coefficients, which are the output of the calibration process, are shown below the *Calibration Point* table, see Figure 32.

The first step in using the *Calibration* tab is to select the type of calibration desired. This defines the number of measurement points for the sensor signal at various temperatures (if temperature compensation is selected).

The reference value for the external sensor targets, in the first column of the *Calibration Points* table, represents the final output data in percentage of the ADC full scale (FS) range from the ZSSC324x output, after signal conditioning.

In the example below, a raw bridge sensor value of -6727367 (24-bit resolution) counts should be mapped by calibration to 10% of FSO, which results in a corrected output of $2^{24} = 1677722$ counts.

Figure 33. Raw Data to Calibrated Data in Percentage

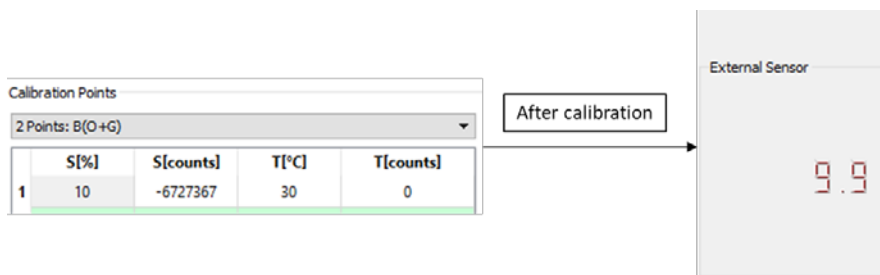

2.7.3.1 Calibration Points

The data input section is located in the upper right side of the *Calibration* tab. In this table, calibration points are defined (raw measurement results with their reference information) for the external and temperature sensor. Above the *Calibration Points Position* area (see Figure 32), the calibration type can be selected in a drop-down menu. Available default calibration types are described in Table 11.

Table 11. Supported Default Calibration Types

Type	GUI	Calculated coefficients									Required set points		
		OFFSET_S	GAIN_S	TCO	TCG	SOT_S	SOT_TCO	SOT_TCG	OFFSET_T	GAIN_T	SOT_T	External Sensor	Temperature
2 Point	B(O+G)	✓	✓									2	0
3 Point	B(O+G + SOT)	✓	✓			✓						3	0
4 Point	B(O+G +TC(O+G) T(O+G))	✓	✓	✓	✓				✓	✓		2	2
5 Point	B(O+G +SOT + TC(O+SOT(O))) T(O+G+SOT))	✓	✓	✓		✓	✓		✓	✓	✓	3	3
6 Point	B(O+G+TC(O+G+SOT(O+G))) T(O+G+SOT))	✓	✓	✓	✓		✓	✓	✓	✓	✓	3	2
7 Point	B(O+G+SOT+TC(O+G+SOT(O+G))) T(O+G+SOT))	✓	✓	✓	✓	✓	✓	✓	✓	✓	✓	3	3
2 Point	T(O+G)								✓	✓		0	2
3 Point	T(O+G+SOT)								✓	✓	✓	0	3

Depending on the calibration type, the corresponding number of calibration points is displayed in the *Calibration Points Position* graph to illustrate the coverage of the measurement range. The table below the drop-down menu automatically updates the number of entries, based on the selected calibration type. It contains up to 7 rows and 4 columns for each combination of sensor and temperature conditions.

- **S[%]** External sensor measurement reference point. The point should be entered as a percent of the full measurement range.
- **S[counts]** Raw external sensor measurement result in counts.
- **T[°C]** Temperature measurement reference point. Enter this point in Celsius degrees.
- **T[counts]** Raw temperature measurement result in counts.

The columns S[%] and T[°C] have predefined values entered that could be changed if necessary. The columns S[counts] and T[counts] are usually updated with the result from the measurement when the button *Get Measurement Value for Calibration* is pressed, see Figure 40. Alternatively the raw measurement input can be done manually by entering the number into the cell after a double click on it.

2.7.3.2 Coefficients

The bottom right section in the *Calibration* tab is the *Coefficient* table, where the coefficients are displayed after calculation. If one of the coefficients exceeds the range limits, its value appears as a red number. In this case, the status window displays **“Calculated coefficients out of range!”**

2.7.4 Diagnostic / Cyclic Configuration / Command Section

In Figure 34 the overview of the tab is provided. There are 5 sub-tab areas that are discussed in sections 2.7.4.1, 2.7.4.2, 2.7.4.3, 2.7.4.4, and 2.7.4.5.

Figure 34. Diagnostic / Cyclic Configuration /Command Section

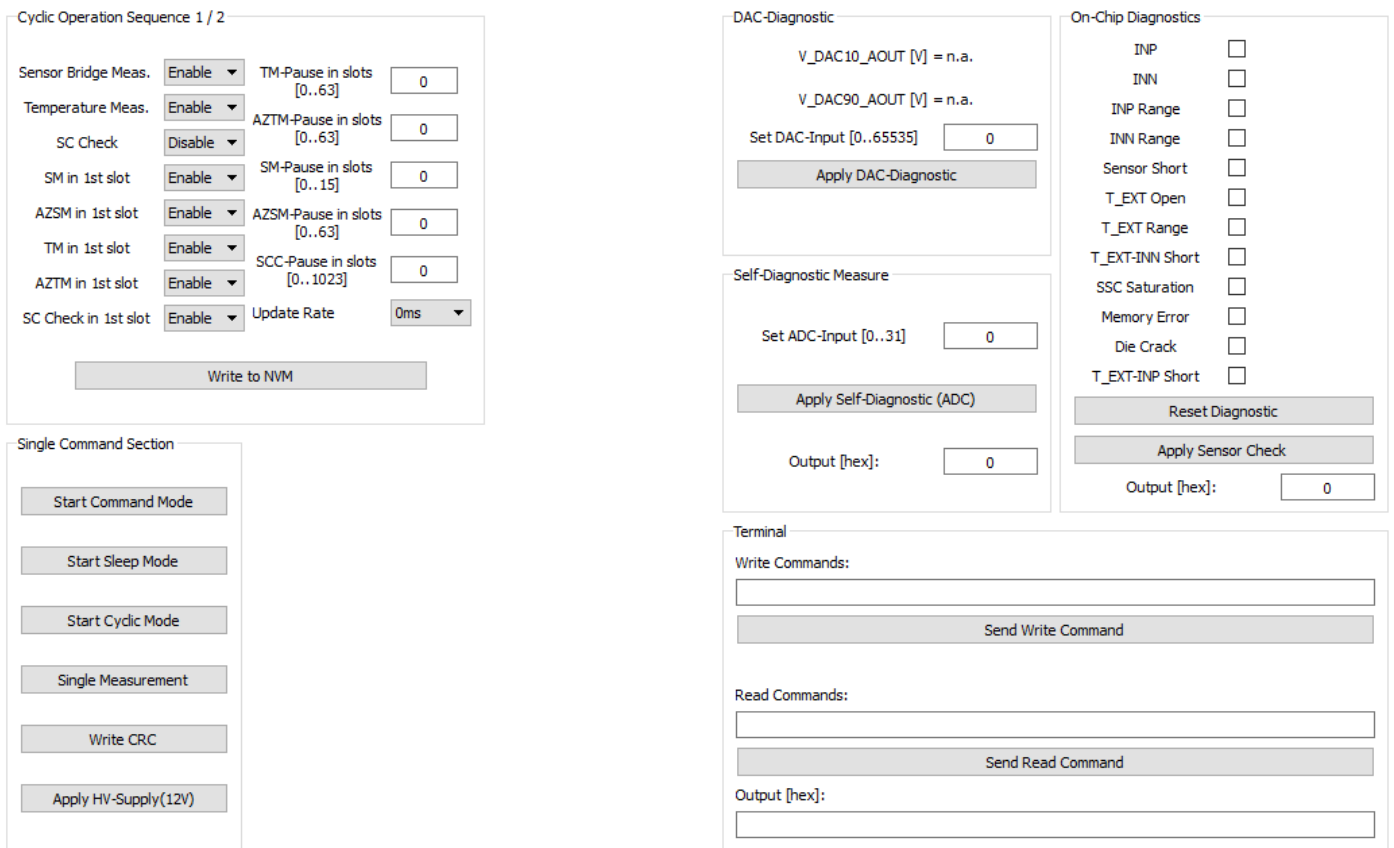

2.7.4.1 Cyclic Operations Sequence 1/2

The ZSSC324x can be configured for cyclic measurement sequences. The continuously running measurement sequence consists of individual measurement slots in which all or a selectable subset of measurements and checks can be scheduled and allocated. Refer to the ZSSC324x Data Sheet for a detailed description of the continuously running measurement sequence. In Figure 35, the registers affected by each parameter in this sub-tab are shown. Refer to the register map in the datasheet for a detailed description of the function of each bit.

Figure 35. Cyclic Operation Parameters

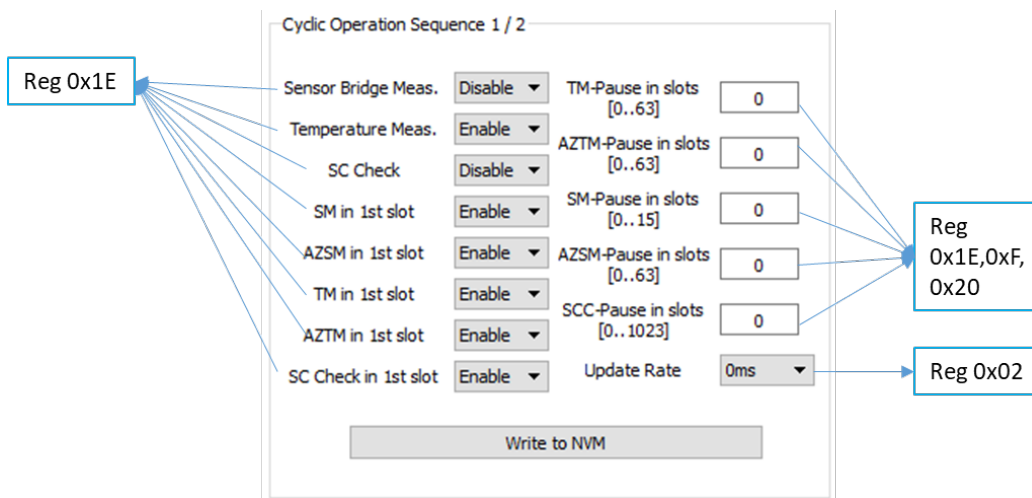

2.7.4.2 ADC and DAC Diagnostic

The ZSSC324x offers analog and digital diagnostic features to enable a better evaluation or debugging options. Figure 36 shows the relevant sub tab, which is divided in the section for the DAC and the section for the ADC.

Figure 36. ADC and DAC Diagnostics

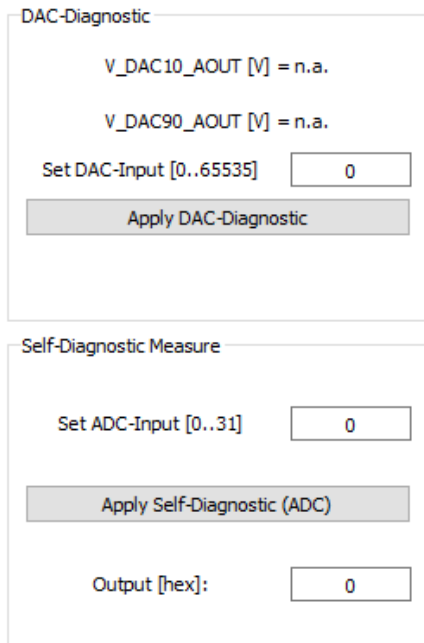

The DAC section gives the user the possibility to set a digital value to the input of the DAC. By clicking on the button *Apply DAC-Diagnostic*, the DAC output is updated and can be checked against its value in the selected output range. For further details, refer to the ZSSC324x Data Sheet.

The DAC output is available on the AOUT/OWI1 pin, independently from the signal level connected to the chip input.

The ADC section provides the functionality to disconnect the ADC inputs from the chip pins, and to route to the ADC a set of predetermined pseudo input values (-15mV to +15mV) in order to test that signal chain functionality. For further details, refer to the ZSSC324x Data Sheet. Press the *Apply Self-Diagnostic (ADC)* button to enable the ADC input.

2.7.4.3 Sensor Check Selection

A description of the diagnostic feature offered in the sub-tab showed in Figure 37. For further details, refer to the ZSSC324x Data Sheet.

Enabling one or more of the check boxes, affects the value of NVM register 21_{HEX}. To enable the diagnostic, click the *Apply Sensor Check* button, and the value of the register 21_{HEX} (selection sensor checks) is written in NVM.

The selected checks are executed and signaled when triggering the commands B0_{HEX} or B2_{HEX}. Those commands are described in the ZSSC324x Data Sheet.

For a new status check, click the *Reset Diagnostic* button and then, to verify the status of the diagnostic, click the *Apply Sensor Check* button.

Figure 37. Sensor Check Selection Settings

On-Chip Diagnostics	
INP	<input checked="" type="checkbox"/>
INN	<input checked="" type="checkbox"/>
INP Range	<input checked="" type="checkbox"/>
INN Range	<input type="checkbox"/>
Sensor Short	<input checked="" type="checkbox"/>
T_EXT Open	<input type="checkbox"/>
T_EXT Range	<input type="checkbox"/>
T_EXT-INN Short	<input type="checkbox"/>
SSC Saturation	<input type="checkbox"/>
Memory Error	<input type="checkbox"/>
Die Crack	<input checked="" type="checkbox"/>
T_EXT-INP Short	<input type="checkbox"/>
Reset Diagnostic	
Apply Sensor Check	
Output [hex]:	<input type="text" value="0"/>

2.7.4.4 Single Command Section

The buttons showed in this sub-tab (see Figure 38) have the following functionalities:

- *Start Command Mode* (command: A9_{HEX})
- *Start Sleep Mode* (command: A8_{HEX})
- *Start Cyclic Mode* (command: AB_{HEX})
- *Single Measurement* (command: as defined in the *Measurement Control* section)
- *Write CRC* (command: 39_{HEX})
 It triggers the IC-internal CRC calculation over the current memory contents and writes it to register 35_{HEX}. It should be the last step of the calibration process, after AFE configuration, coefficient calculation, and writing. After the checksum is written and the ZSSC324x is reset, the *Memory Error* LED turns off (see Figure 24 and Table 10).
- *Apply HV-Supply (12V)/Turn HV-Supply Off* (command string: PS_A61 / PS_A60)
 These commands are not part of the ZSSC324x command set. The controller on the CB interprets them and switches on /off the 12V for HV application on the EVB. LED L3 is indicating whether this voltage is available on the EVB (see Figure 2 and Table 2)

Figure 38. Single Commands Options

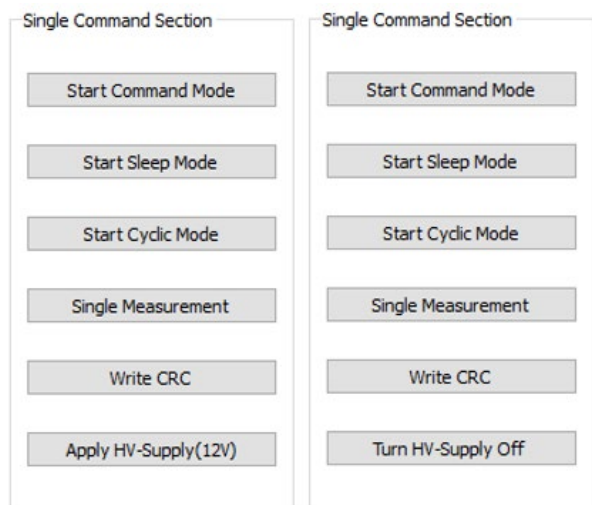

2.7.4.5 Terminal

In the *Terminal* section, the user can send commands directly to the ZSSC324x. For a reading command, the response is displayed in the output line.

A simple example of Write/Read command is given in Figure 39: enter a write command and click the *Send Write Command* button; enter a read command and click the *Send read Command* button. The read data is provided in the *Output [hex]* field.

The command syntax can be found in the *SSC Command Syntax for V4.x Communication Boards* spreadsheet, which is available under the following location: <http://www.idt.com/products/sensor-products/sensor-signal-conditioners/ssc-cb-ssc-communication-board>.

Figure 39. Read/Write Operations via Terminal

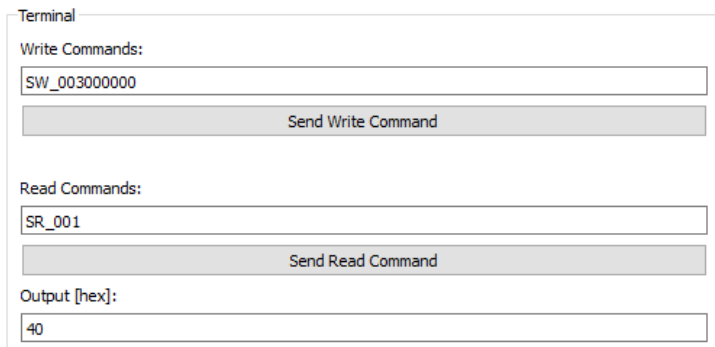

2.8 Main Buttons

These buttons are located in the bottom left corner of the GUI (Figure 40)

- *Power On/Off* – Applies the supply voltage to the chip in the socket on the EVB. The button label toggles according to the relevant status.
- *Reset* – Triggers a HIGH-LOW-HIGH-transition (active-low reset) at the RES pin. Clicking this button resets the ZSSC324x.
- *Start/Stop* – Trigger the start and stop of measurements acquisition. Its label toggles according to the relevant status.
- *Get Measurements Value for Calibration* – It is used in combination with the *Calibration* tab (see section 2.7.3).

Figure 40. Main Buttons

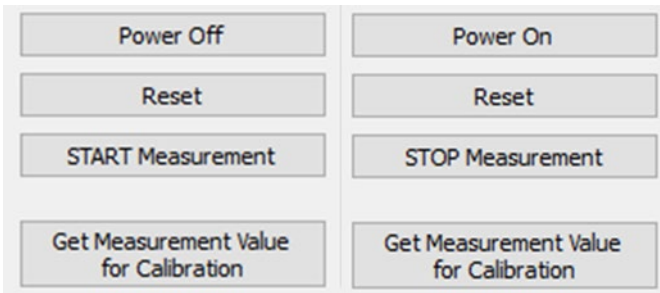

2.9 Information Bar

This bar returns a status message when specific status is requested. An example is shown in Figure 41, where, using the I2C interface, and a scan of the addresses of the bus is requested by clicking on the *Scan I2C-Bus* button.

Figure 41. Information Bar Message

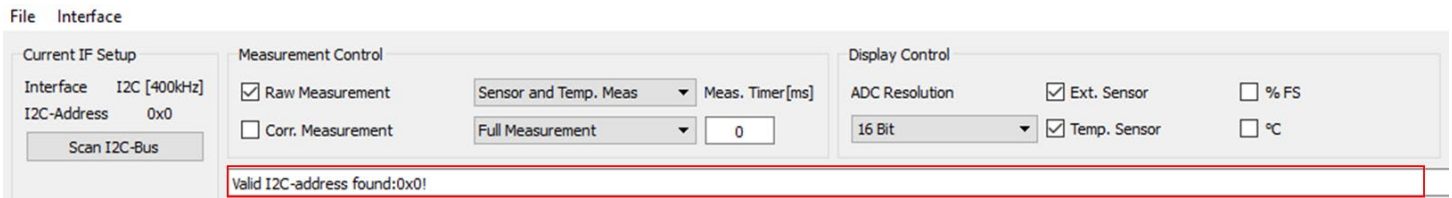

3. Calibration Process, Configuration and Calibration Example

3.1 Process Flowchart

The calibration procedure is illustrated in Figure 42.

Figure 42. Calibration process flowchart

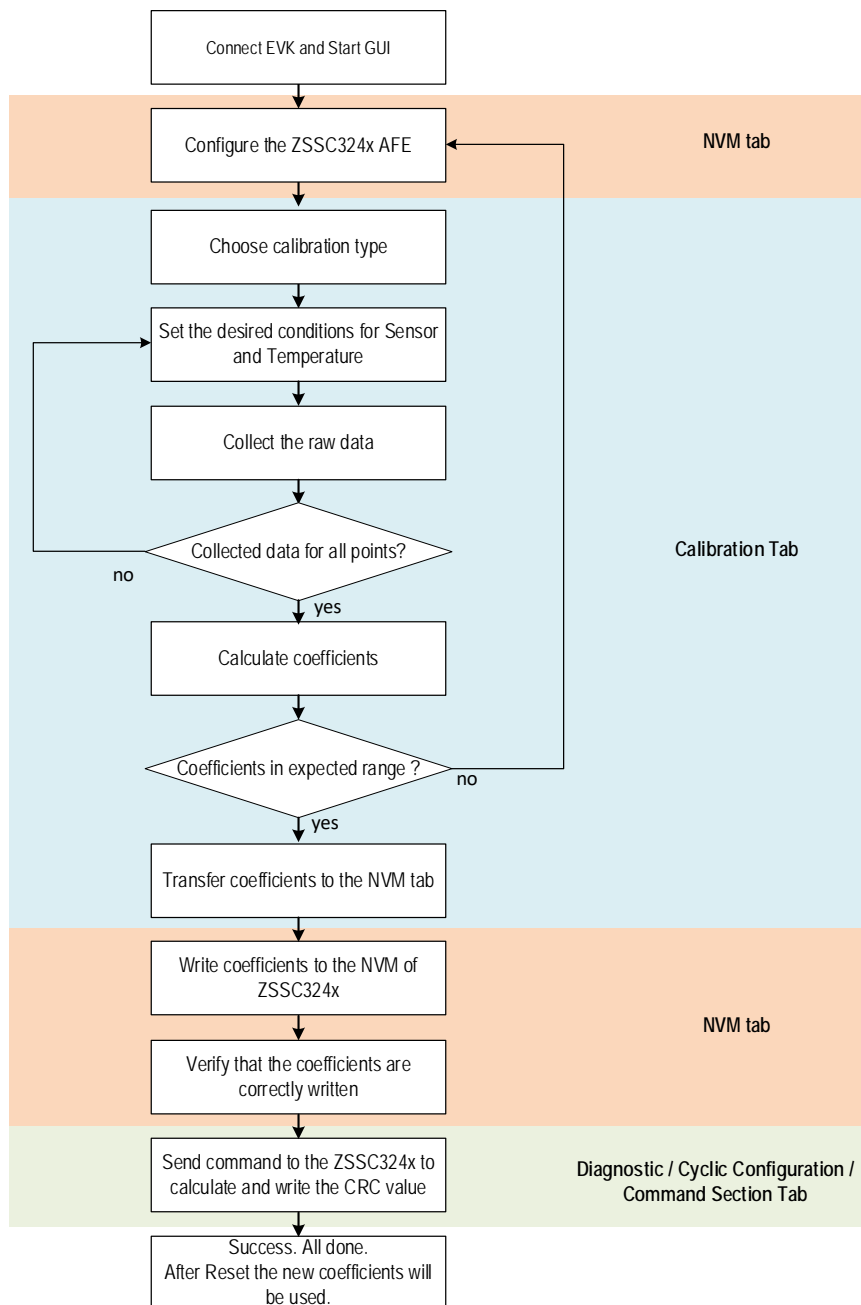

This calibration example uses the [Sensor Replacement Board](#) (SRB) to emulate a sensor signal. A typical calibration flow includes the five basic steps:

1. Setup and initialization, see section 3.3.
2. Data collection, see section 3.4.
3. Coefficient calculation, see section 3.5.

4. Memory programming, see section 3.6.
5. Verification, see section 3.7.

3.2 Connect EVK and Start GUI

For the following calibration examples, ensure that the SRB is connected to the EVB through the 50-pin connector J4 (see Figure 1)

If HW is connected correctly to the evaluation kit, the SW opens a communication port automatically to the CB via USB by starting the GUI. If the jumper settings and the interface settings in the GUI are consistent, the communication to the ZSSC324x is established.

3.3 Configuration

Prior to measurement, the coefficients have to be programmed correctly to the default values. It is needed to set the *GAIN_S* and *GAIN_T* coefficients to 20000_{HEX} in the *NVM* tab. This coefficient values cause a multiplication by one in the digital math core, on the raw measurement. All other coefficients have to be set to zero, see Figure 43.

Note: The above step is not mandatory for a successful calibration process in general. The calibration is usually established via raw measurement commands where the coefficients are not applied.

In the following example these coefficient values are used to detect if saturation occurs. The saturation bit is only set when SSC commands are applied, but not using raw measurement commands.

Figure 43. NVM Coefficients before Calibration

Register	Value[hex]	
05	OFFSET_S	0000
06	GAIN_S	0000
07	TCG	0000
08	TCO	0000
09	SOT_TCO	0000
0A	SOT_TCG	0000
0B	SOT_SENS	0000
0C	OFFSET_T	0000
0D	GAIN_T	0000
0E	SOT_T	0000
0F	OFFSET_S / GAIN_S	0020
10	TCG / TCO	0000
11	SOT_TCO / SOT_TCG	0000
12	SOT_SENS / OFFSET_T	0000
13	GAIN_T / SOT_T	2000

The emulated sensor input from the Sensor Replacement Board can be measured by clicking the *Start* button on the main application tab.

The configuration of the ZSSC324x parameters is performed by accessing the registers *SM_Config_1* and *SM_Config_2* in the *NVM*, as shown in Figure 28.

The gain of AFE is chosen, in this example, such that IC output is as high as possible in order to take full advantage of the ADC's dynamic range, without saturating. In this example it is used a gain of 30, but it can vary due to the resistor tolerances of the SRB.

Settings are summarized in Figure 44.

Figure 44. AFE Settings

Gain	30
Polarity	Positive
ADC Resolution	24 Bit
ADC Offset	37.5%
ADC Reference	Ratiometric
CM Offset	-5mV
T bias out	5uA
ADC Gain/Offset	On
CM Adjustment	On

The *Corr. Measurement* check box in the *Measurement Control* options as been selected, and the *Display Control* the *ADC Resolution* has been set to 24 bits (see Figure 45).

Figure 45. Display and Control Settings

Current I/F Setup		Measurement Control		Display Control	
Interface	I2C [400kHz]	<input type="checkbox"/> Raw Measurement	Sensor and Temp. Meas	ADC Resolution	<input checked="" type="checkbox"/> Ext. Sensor
I2C-Address	0x0	<input checked="" type="checkbox"/> Corr. Measurement	Full Measurement	24 Bit	<input checked="" type="checkbox"/> % FS
Scan I2C-Bus			Meas. Timer [ms]		<input checked="" type="checkbox"/> °C
			0		

A measurement is performed using the Measurement tab while rotating the cursor of the potentiometer in clockwise direction from one extreme to the other of the movement range, see Figure 46:

Figure 46. Output Swing

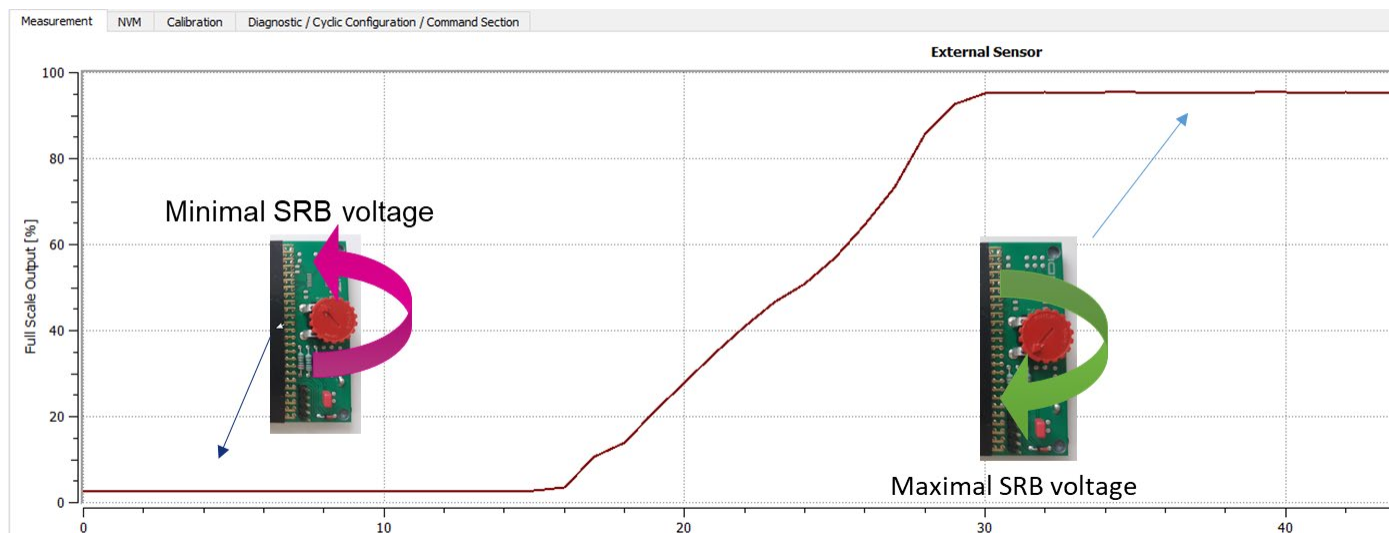

The output swings from 2,5% to 95% of the full scale.

The same configuration of the AFE could also cause a saturation at the top (or bottom) limit of the full scale output, as it is illustrated in the Figure 47. In this case, it is recommended to reduce the gain or increase offset value.

Figure 47. Saturation Condition

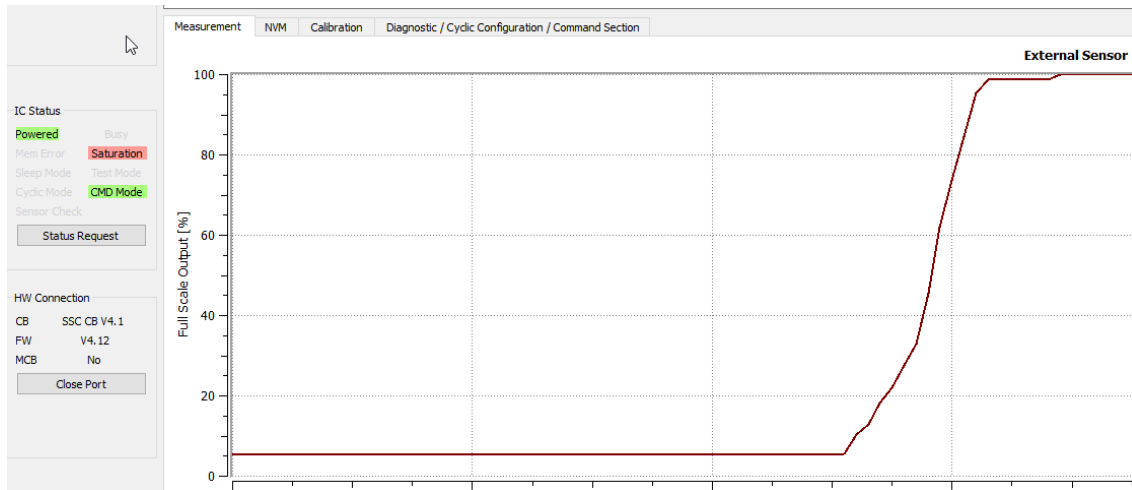

Once a preliminary acquisition, as shown in this example is completed, select one of the available calibration points set options: refer to Figure 48 and Table 11.

Figure 48. Calibration Points Set Options

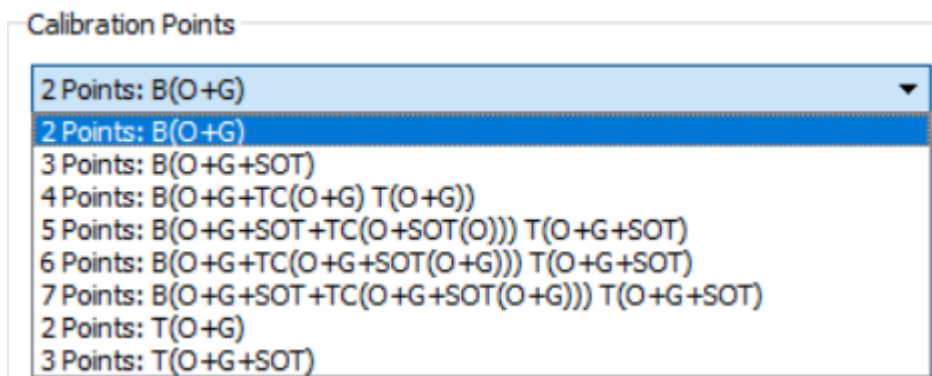

3.4 Data Collection

To describe data collection, an example is used with a 2-points calibration to obtain the gain and offset compensation for the emulated sensor signal from the Sensor Replacement Board. With reference to Figure 49, choose the *2 Point* option from the drop-down menu under *Calibration Points*, which enables the first two rows and the relevant data fields. The S[%] column is target range of the ADC in percentage of the full scale. For this example the reference points of 10% and 90% are used.

Figure 49. 2-Points Calibration – Reference Points

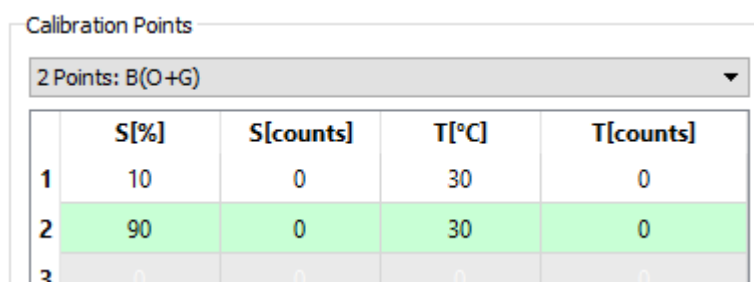

The graph for *Calibration Points Position* provides the view as shown in Figure 50, where the x-axis represents the temperature and the y-axis the percentage of the full scale for the bridge sensor.

Figure 50. 2-Points Calibration – Points Position

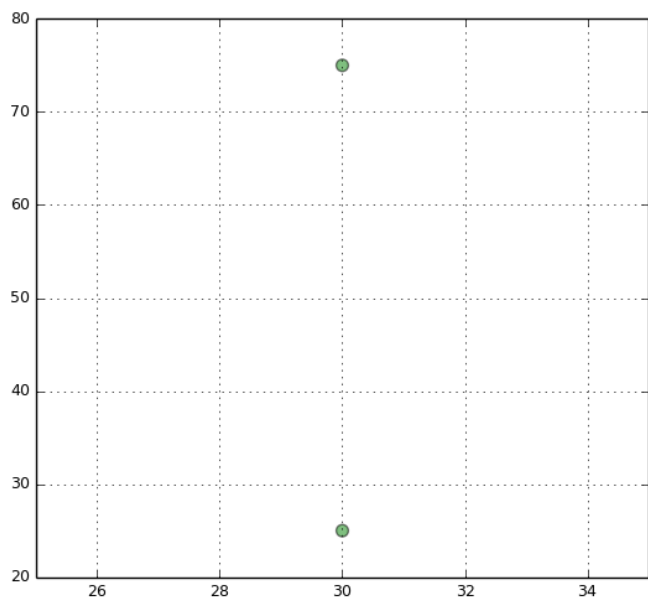

Note: The definition of the temperature range in the calibration must be entered in the T[°C] column. The degree Celsius entries in the *Calibration Points* table must match the range definition given in the fields *Temperature Limits* below the table.

The setup is ready for raw data collection.

Ensure that the first row is selected by clicking in one of the cells of it (blue background), then click *Start Measurement* button and turn the potentiometer cursor until the *External Sensor* numerical display shows 10% (see Figure 51). Stop the measurement, and click the *Get Measurement Value for Calibration* button in the bottom left corner of the GUI.

Figure 51. 2-Points Calibration – First Point

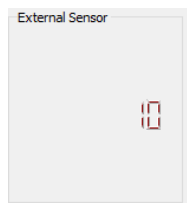

Ensure that the second row is selected (blue background), then click the *Start Measurement* button and turn the potentiometer cursor until the *External Sensor* numerical display shows 90%. Stop the measurement, and click the *Get Measurement Value for Calibration* button in the bottom left corner of the GUI.

The table on the *Calibration Points* sub-tab is filled with relevant raw values in the S[count] column, as displayed in Figure 52.

Figure 52. 2 Points Calibration – Raw Values

Calibration Points

2 Points: B(O+G)

	S[%]	S[counts]	T[°C]	T[counts]
1	10	-6704653	30	0
2	90	6698923	30	0
3	0	0	0	0
4	0	0	0	0
5	0	0	0	0
6	0	0	0	0
7	0	0	0	0

Temperature Limits: Tmin[°C] -40 Tmax[°C] 125

Calculate Coefficients Write Coefficients to Memory

Notes:

- If the ADC resolution in the *Display Control* is not set to 24 bit (for example 16), the *S[counts]* fields are still displayed in the 24-bit range.
- The *S[counts]* field displays the decimal representation of the raw value output from the ADC. The raw ADC output is provided as two's complement numbers.

3.5 Coefficients Calculation

The coefficient calculation is performed by the CalibrationL6.DLL included in the SW, after clicking the *Calculate Coefficients* button. The results are displayed in the *External Sensor Correction* table, see Figure 53.

Figure 53. Calculated Coefficients

Coefficients

External Sensor Correction		Temp. Sensor Correction	
Name	Value	Name	Value
Offset_S	716	Offset_T	0
Gain_S	2099998	Gain_T	0
TCG	0	SOT_T	0
TCO	0		
SOT_TCO	0		
SOT_TCG	0		
SOT_S	0		

If one or more of the coefficients are displayed in red, an error message appears on the information bar (see Figure 54). To remove the error, test adjusting the reference values of the calibration points.

Figure 54. Calculation Error Message

Measurement Control

Raw Measurement Corr. Measurement

Sensor and Temp. Meas Full Measurement Meas. Timer [ms] 0

Display Control ADC Resol 24 Bit

Calculated coefficients out of range!

Measurement NVM Calibration Diagnostic / Cyclic Configuration / Command Section

The calculation DLL is also accessible by any software, and it is provided to the customer as means for calibration on a large scale and integration with the customer's existing workflow.

Description of the DLL content, algorithm details, and further information on the calibration options are provided in the ZSSC324x Calibration Guide available through the product folder.

3.6 Memory Programming

Values resulting from successful coefficients calculation, must be written to the NVM of the ZSSC324x. This is done by the following sequence:

1. Click the *Write coefficients to Memory* button.
Assigns the coefficients into the NVM tab and assigns those to the appropriate registers (see Figure 52). The NVM map is shown with the new register memory values ready to be programmed in the NVM (see Figure 55).
2. Click the *Write to NVM* button on the *NVM* tab.
Writes the new NVM content to the ICs memory.
3. Select *Single Command Section -> Write CRC* button on the *Diagnostic / Cyclic Configuration / Command Section* tab.
Triggers the CRC calculation over the new memory content and writes it.
4. Click the *Reset* button.
Resets the ZSSC324x, and the status bit 'Memory Error' is set to 0BIN.

Figure 55. NVM View with New Register Values after Calibration

	Name	Value [hex]
00	Customer_ID_0	0000
01	Customer_ID_1	0000
02	Interface Config	0000
03	Smart Sensor F. I/O 1	0000
04	Smart Sensor F. I/O 2	0824
05	OFFSET_S	02CC
06	GAIN_S	0B1E
07	TCG	0000
08	TCO	0000
09	SOT_TCO	0000
0A	SOT_TCG	0000
0B	SOT_SENS	0000
0C	OFFSET_T	0000
0D	GAIN_T	0000
0E	SOT_T	0000
0F	OFFSET_S / GAIN_S	0020
10	TCG / TCO	0000
11	SOT_TCO / SOT_TCG	0000
12	SOT_SENS / OFFSET_T	0000
13	GAIN_T / SOT_T	0000
14	SM_CONFIG 1	8417
15	SM_CONFIG 2	0200

Write NVM Read NVM

3.7 Verification

After programming the new coefficients into the NVM, a recommended practice is to read the memory content and verify in the "Measurement" tab that correct data is read from the sensor.

Measurement data values have to swing between 0 and 100% of full scale without saturation, as shown in Figure 56. Also, the SRB position which were used as calibration points (10% and 90%) must provide the same percentage output, as calibrated.

Figure 56. Calibrated Sensor Measurement

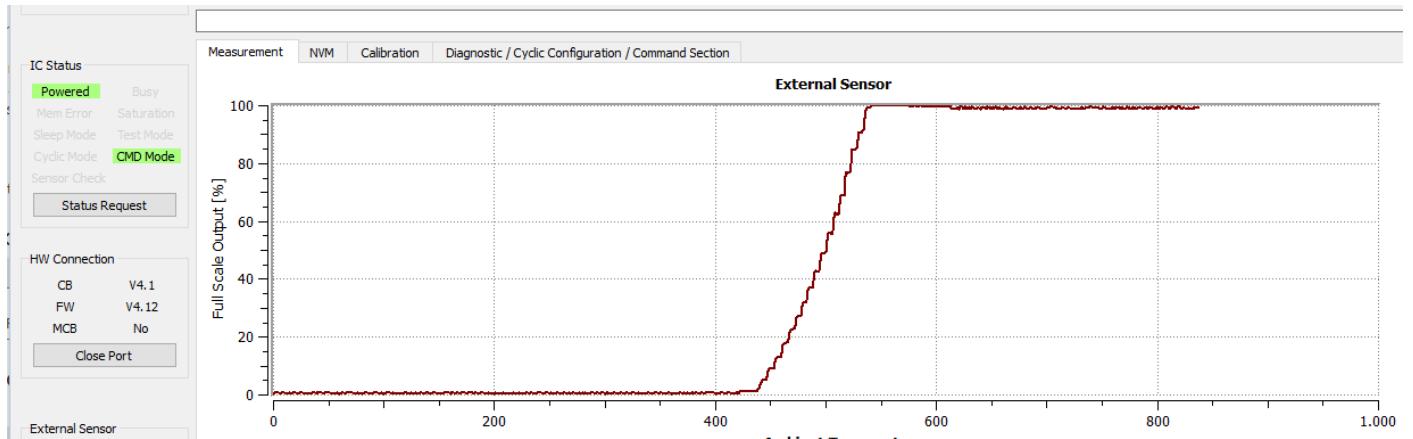

4. Board Supply by External JFET

The EVB is designed with capability to be supplied by an external power supply up to 48V. This is possible with the use of an external JFET (Q5) controlled by the LDOctrl signal, available at pin 23 (QFN-24 package), refer to the *ZSSC3240 EVB V2 2 Schematic BOM* document on the project site on www.IDT.com/ZSSC3240. Board connections are described in Figure 57.

Figure 57. External Supply Connections

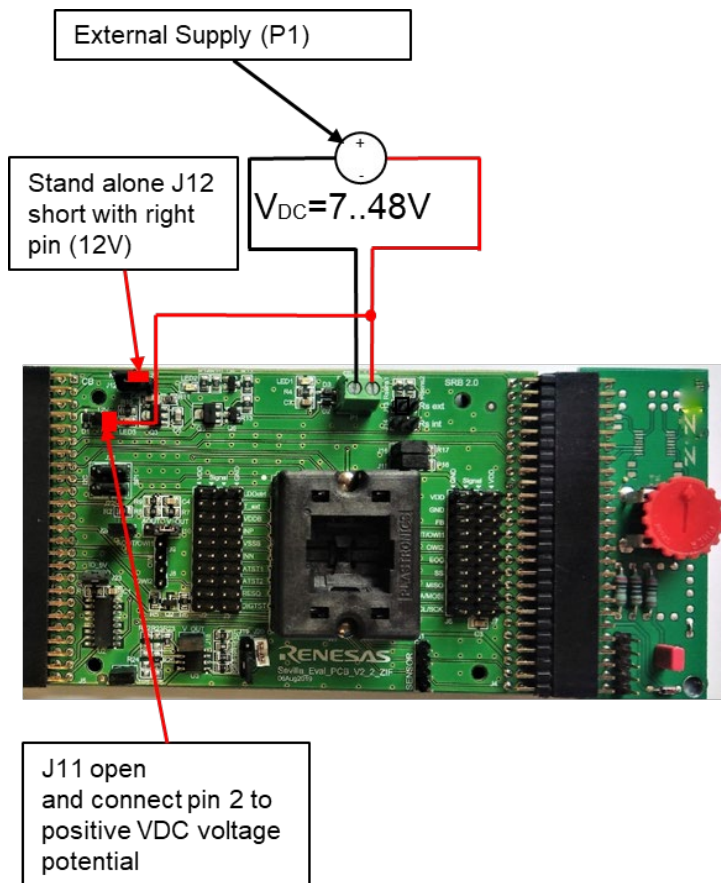

Configuring this application includes two relevant parameters: LDOctrl and VDD_ldoctrl_target (*LDOctrl Voltage* in the GUI), as shown in Figure 58.

Figure 58. External Supply GUI Settings

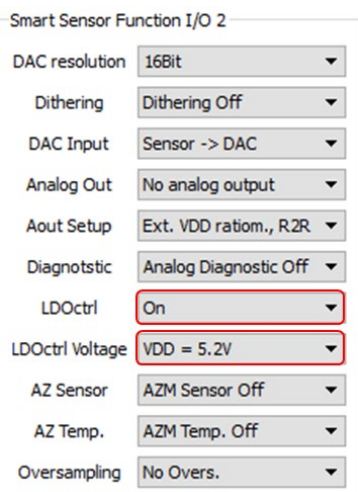

Note: LED3 at EVB does not light on when the supply voltage is provided externally, through connector P1.

5. Analog Output

5.1 Enabling Analog Output Pin

Analog output is available in Command Mode applying full measurement commands or after IC-reset continuously in Cyclic Mode.

To apply full measurement commands, follow these steps:

1. Enable *Corr. Measurement* checkbox in the Measurement Control area, see Figure 59.

Figure 59. Measurement Control for Analog Output

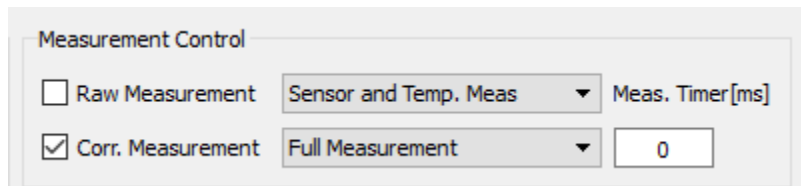

2. Select in the Smart Sensor Function I/O 2 sub tab (see Figure 31) and make the following settings:

- DAC resolution: As needed
- DAC input: External sensor or Temperature, both can be the analog output
- Analog Out: Must be enabled (set to 0_{BIN})
- Aout Setup: As needed

3. Save the changed configuration in the NVM.

4. Reset the IC to have the new NVM memory having effect.

In Command Mode, the measurements have to be triggered via the *Start Measurements* button.

Digitally captured results are displayed on the GUI, in the main graph (see the bottom of Figure 60), while the analog output voltage is available at the Aout/OWI1 pin. The analog, processed sensor signal can be displayed by connecting a scope probe to the Aout/OWI1 pin, see the top of Figure 60:

Figure 60. Analog and Digital Output Synchronous Swing

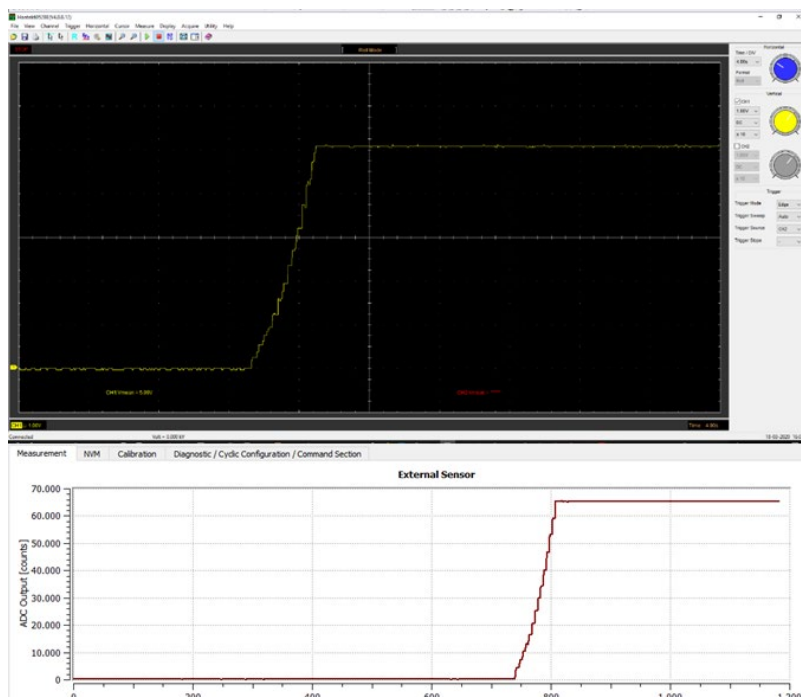

With a complete swing of a resistive bridge connected to the input of the IC, the analog output swings from 0V to about 5V (scale:1V/div.), while the digital output moves from a few hundreds to about 64K counts (corrected measurement visualized with a 16 bits resolution).

5.2 Amplified Analog Output

For a possible evaluation of a voltage output of 0V to 10V, the EVB comprises a circuitry for the amplification of the Aout/OWI1 signal. Detailed description of the analog output options can be found in the ZSSC3240x Data Sheet.

To use the feature, follow these steps:

1. Connect the jumpers in the relevant configuration, see Table 12.
There are two options to set gain including the LM358AM on the EVB
 - Amplification by 2: In combination with one of the 5V default analog output options, this is the recommended way to get 0..10V at the output of the LM358AM.
 - Amplification by 10: In combination with the default 0..1V analog output configuration, 0..10V are available at the output of the LM358AM.

Table 12. Jumper Settings for Amplified Analog Output

Jumper	Connection
J10	Silkscreen= VOUT
J17	Short
J18	Short
J19	Outer side of board short : Vout x 10
J19	Inner side of board short : Vout x 2

2. Click *Apply HV-Supply(12V)* button in the *Diagnostic / Cyclic Configuration / Command Section* tab (see Figure 34) to enable the +12V supply for the LM358AM provided by the Communication Board to the Evaluation Board

The operational amplifier supply is 12V and the amplification factor is determined by the position of the jumper J19. The operational amplifier provides a maximum output voltage of about 10V.

5.3 Current Loop Output

This functionality is described in a dedicated application note. Refer to the device product folder to access the AN, or ask the application support team.

6. Troubleshooting

6.1 GUI Launched while the Communication Board is Not Connected

If the GUI is launched but the SSC CB is not connected, the message in Figure 61 is displayed.

Figure 61. Connection Error Message

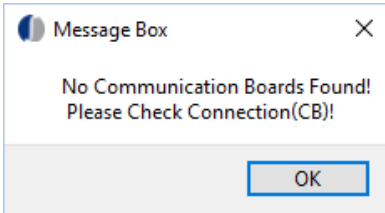

By clicking the *OK* button, the GUI is displayed, but no ZSSC324x interaction is available, except functions in the *Calibration* tab.

Connecting the SSC Communication Board is possible, to enable the GUI functions follow these steps:

1. Connect the Communication Board to the PC
2. Click the *Open Port* button.
3. Click the *Power on* button, see Figure 62.

Figure 62. Resume Communication

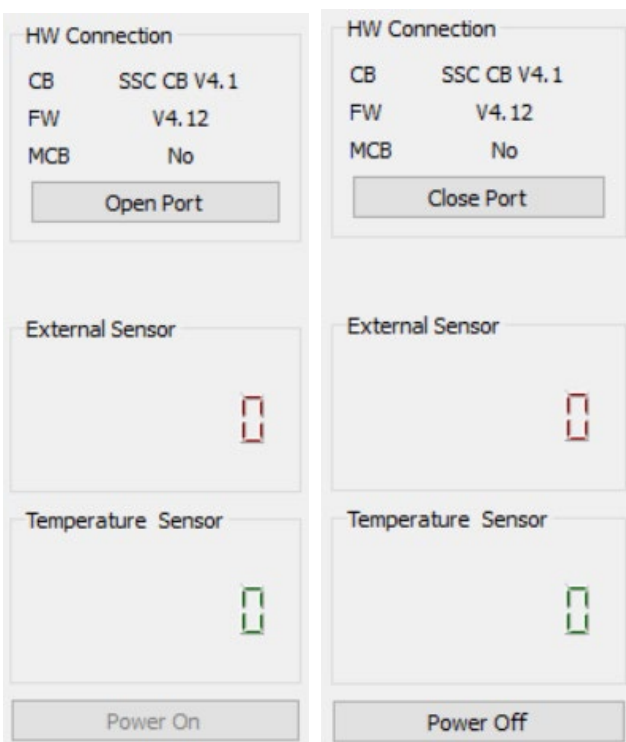

6.2 Unplugging Communication Board with Port Open

If there were a successful connection, but the CB is unplugged without clicking on the *Close Port* button as shown in Figure 63, the GUI freezes and cannot reconnect. It needs to be closed and restarted to have communication working again.

Figure 63. Close Port before unplugging the Communication Board

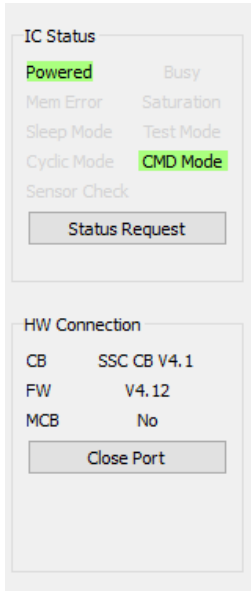

7. Schematic, Bill of Materials

For detailed information on PCB, including a high quality evaluation board schematic, refer to the *ZSSC3240 EVB V2 2 Schematic BOM* document on the project site on www.IDT.com/ZSSC3240.

8. Glossary

Table 13. Abbreviations and terms used in the document

Abbreviation	Description
AFE	Analog Front End
BTC	Binary Two's Complement
EVB	Evaluation Board
CB	Communication Board
CRC	Cyclic Redundancy Check
SRB	Sensor Replacement board
SSC	Sensor Signal Conditioner
NVM	Non Volatile Memory
A2D	Analog-to-Digital
ACK	Acknowledge (interface's protocol indicator for successful data/command transfer)
ADC	Analog-to-Digital Converter or Conversion
ALU	Arithmetic Logic Unit
AZ	Auto-Zero (unspecific)
AZSM	Auto-Zero Measurement for External Sensor
AZTM	Auto-Zero Measurement for Temperature
CDIP	Ceramic Dual-Inline Package
CLK	Clock
DF	Data Fetch (this is a command type)
DLL	Dynamic-Link Library
DUT	Device Under Test
DSP	Digital Signal Processor (digital configuration, calibration, calculation, communication unit)
FSO	Full Scale Output (value in percent relative to the ADC maximum output code; resolution dependent)
LDO	Low Dropout Regulator
LSB	Least Significant Bit ("fine" portion of the converted signal)
MSB	Most Significant Bit ("coarse" portion of the converted signal)
NACK	Not Acknowledge (interface's protocol indicator for unsuccessful data/command transfer)
PCB	Printed Circuit Board
POR	Power-On-Reset
PQFN	Power Quad Flat No Leads
SM	Signal Measurement
SOT	Second-Order Term

Abbreviation	Description
SRB	Sensor Replacement Board
TM	Temperature Measurement

9. Ordering Information

Orderable Part Number	Description
ZSSC324xEVB	ZSSC324x Evaluation Board
SSCCOMMBOARDV4P1C	SSC Communication Board V 4.1
SSCSENSORREPBDV2P0	SRB (Sensor Replacement Board) V2.0

10. Revision History

Revision Date	Description of Change
April 15, 2020	Initial release.

Notice

1. Descriptions of circuits, software and other related information in this document are provided only to illustrate the operation of semiconductor products and application examples. You are fully responsible for the incorporation or any other use of the circuits, software, and information in the design of your product or system. Renesas Electronics disclaims any and all liability for any losses and damages incurred by you or third parties arising from the use of these circuits, software, or information.
2. Renesas Electronics hereby expressly disclaims any warranties against and liability for infringement or any other claims involving patents, copyrights, or other intellectual property rights of third parties, by or arising from the use of Renesas Electronics products or technical information described in this document, including but not limited to, the product data, drawings, charts, programs, algorithms, and application examples.
3. No license, express, implied or otherwise, is granted hereby under any patents, copyrights or other intellectual property rights of Renesas Electronics or others.
4. You shall be responsible for determining what licenses are required from any third parties, and obtaining such licenses for the lawful import, export, manufacture, sales, utilization, distribution or other disposal of any products incorporating Renesas Electronics products, if required.
5. You shall not alter, modify, copy, or reverse engineer any Renesas Electronics product, whether in whole or in part. Renesas Electronics disclaims any and all liability for any losses or damages incurred by you or third parties arising from such alteration, modification, copying or reverse engineering.
6. Renesas Electronics products are classified according to the following two quality grades: "Standard" and "High Quality". The intended applications for each Renesas Electronics product depends on the product's quality grade, as indicated below.
 - "Standard": Computers; office equipment; communications equipment; test and measurement equipment; audio and visual equipment; home electronic appliances; machine tools; personal electronic equipment; industrial robots; etc.
 - "High Quality": Transportation equipment (automobiles, trains, ships, etc.); traffic control (traffic lights); large-scale communication equipment; key financial terminal systems; safety control equipment; etc.
- Unless expressly designated as a high reliability product or a product for harsh environments in a Renesas Electronics data sheet or other Renesas Electronics document, Renesas Electronics products are not intended or authorized for use in products or systems that may pose a direct threat to human life or bodily injury (artificial life support devices or systems; surgical implantations; etc.), or may cause serious property damage (space system; undersea repeaters; nuclear power control systems; aircraft control systems; key plant systems; military equipment; etc.). Renesas Electronics disclaims any and all liability for any damages or losses incurred by you or any third parties arising from the use of any Renesas Electronics product that is inconsistent with any Renesas Electronics data sheet, user's manual or other Renesas Electronics document.
7. No semiconductor product is absolutely secure. Notwithstanding any security measures or features that may be implemented in Renesas Electronics hardware or software products, Renesas Electronics shall have absolutely no liability arising out of any vulnerability or security breach, including but not limited to any unauthorized access to or use of a Renesas Electronics product or a system that uses a Renesas Electronics product. RENESAS ELECTRONICS DOES NOT WARRANT OR GUARANTEE THAT RENESAS ELECTRONICS PRODUCTS, OR ANY SYSTEMS CREATED USING RENESAS ELECTRONICS PRODUCTS WILL BE INVULNERABLE OR FREE FROM CORRUPTION, ATTACK, VIRUSES, INTERFERENCE, HACKING, DATA LOSS OR THEFT, OR OTHER SECURITY INTRUSION ("Vulnerability Issues"). RENESAS ELECTRONICS DISCLAIMS ANY AND ALL RESPONSIBILITY OR LIABILITY ARISING FROM OR RELATED TO ANY VULNERABILITY ISSUES. FURTHERMORE, TO THE EXTENT PERMITTED BY APPLICABLE LAW, RENESAS ELECTRONICS DISCLAIMS ANY AND ALL WARRANTIES, EXPRESS OR IMPLIED, WITH RESPECT TO THIS DOCUMENT AND ANY RELATED OR ACCOMPANYING SOFTWARE OR HARDWARE, INCLUDING BUT NOT LIMITED TO THE IMPLIED WARRANTIES OF MERCHANTABILITY, OR FITNESS FOR A PARTICULAR PURPOSE.
8. When using Renesas Electronics products, refer to the latest product information (data sheets, user's manuals, application notes, "General Notes for Handling and Using Semiconductor Devices" in the reliability handbook, etc.), and ensure that usage conditions are within the ranges specified by Renesas Electronics with respect to maximum ratings, operating power supply voltage range, heat dissipation characteristics, installation, etc. Renesas Electronics disclaims any and all liability for any malfunctions, failure or accident arising out of the use of Renesas Electronics products outside of such specified ranges.
9. Although Renesas Electronics endeavors to improve the quality and reliability of Renesas Electronics products, semiconductor products have specific characteristics, such as the occurrence of failure at a certain rate and malfunctions under certain use conditions. Unless designated as a high reliability product or a product for harsh environments in a Renesas Electronics data sheet or other Renesas Electronics document, Renesas Electronics products are not subject to radiation resistance design. You are responsible for implementing safety measures to guard against the possibility of bodily injury, injury or damage caused by fire, and/or danger to the public in the event of a failure or malfunction of Renesas Electronics products, such as safety design for hardware and software, including but not limited to redundancy, fire control and malfunction prevention, appropriate treatment for aging degradation or any other appropriate measures. Because the evaluation of microcomputer software alone is very difficult and impractical, you are responsible for evaluating the safety of the final products or systems manufactured by you.
10. Please contact a Renesas Electronics sales office for details as to environmental matters such as the environmental compatibility of each Renesas Electronics product. You are responsible for carefully and sufficiently investigating applicable laws and regulations that regulate the inclusion or use of controlled substances, including without limitation, the EU RoHS Directive, and using Renesas Electronics products in compliance with all these applicable laws and regulations. Renesas Electronics disclaims any and all liability for damages or losses occurring as a result of your noncompliance with applicable laws and regulations.
11. Renesas Electronics products and technologies shall not be used for or incorporated into any products or systems whose manufacture, use, or sale is prohibited under any applicable domestic or foreign laws or regulations. You shall comply with any applicable export control laws and regulations promulgated and administered by the governments of any countries asserting jurisdiction over the parties or transactions.
12. It is the responsibility of the buyer or distributor of Renesas Electronics products, or any other party who distributes, disposes of, or otherwise sells or transfers the product to a third party, to notify such third party in advance of the contents and conditions set forth in this document.
13. This document shall not be reprinted, reproduced or duplicated in any form, in whole or in part, without prior written consent of Renesas Electronics.
14. Please contact a Renesas Electronics sales office if you have any questions regarding the information contained in this document or Renesas Electronics products.

(Note1) "Renesas Electronics" as used in this document means Renesas Electronics Corporation and also includes its directly or indirectly controlled subsidiaries.

(Note2) "Renesas Electronics product(s)" means any product developed or manufactured by or for Renesas Electronics.

(Disclaimer Rev.5.0-1)

Corporate Headquarters

TOYOSU FORESIA, 3-2-24 Toyosu,
Koto-ku, Tokyo 135-0061, Japan
www.renesas.com

Trademarks

Renesas and the Renesas logo are trademarks of Renesas Electronics Corporation. All trademarks and registered trademarks are the property of their respective owners.

Contact Information

For further information on a product, technology, the most up-to-date version of a document, or your nearest sales office, please visit:
www.renesas.com/contact/