

RX140 Group

RX140 Flat panel HMI PoC with touch keys and LCD

Introduction

This application note introduces an HMI solution using the RX140 flat panel HMI PoC with touch keys and LCD (hereinafter referred to as “RX140 PoC”) to realize touch functionality and serial LCD display.

The sample program described in this application note is configured using the following libraries.

LCD Display : Embedded GUI software emWin (hereinafter referred to as “emWin”)

Target Device

RX140 Group

When using this application note with other Renesas MCUs, careful evaluation is recommended after making modifications to comply with the alternate MCU.

Target Tool

RX140 PoC

Contents

1. Outline.....	4
2. Operation Confirmation Conditions	6
3. Sample Programs	7
3.1 Demonstration Screen Flowchart	7
3.2 Flowchart	10
3.2.1 Overall Flowchart.....	10
3.2.2 Processing at touch keys operation	11
3.2.3 Processing at touch slider operation	12
3.2.4 Processing when the "home" button is touched.....	13
3.2.5 Processing when the "select" button is touched	14
3.2.6 Processing when the "start" button is touched.....	15
3.2.7 Processing of CTSU2SL initialization.....	16
3.2.8 Processing of CTSU2SL baseline settings	17
3.2.9 Processing of software standby mode transition and CTSU2SL low power consumption measurement.....	18
3.2.10 Processing of normal operation mode transition.....	19
3.2.11 Processing of CTSU2SL normal measurement	20
3.2.12 Processing of touch judgement	21
3.2.13 Processing of startup screen display	22
3.2.14 Processing of 5 seconds wait.....	23
3.2.15 Processing of screen initialization	24
3.2.16 Processing of peripheral function initialization	25
3.2.17 Processing of offset initialization for tuning	26
3.2.18 Processing of menu display resumption	27
3.2.19 Processing of setting LED pattern to sleep	28
3.2.20 Processing of LED control.....	29
3.3 Pins Used	30
3.4 Sample Program Structure	31
3.4.1 Peripheral Functions Used	31
3.4.2 Components Used.....	31
3.4.3 Peripheral Function Settings	32
3.4.4 File Structure	35
3.4.5 Variables.....	36
3.4.6 Constants	37
3.4.7 Functions	38
3.4.8 Function Specifications	39
3.4.9 ROM/RAM usage	42
4. Importing a Project.....	43

4.1	Procedure in e ² studio	43
4.2	Procedure in CS+	44
5.	Start Demonstration.....	45
5.1	Powered on RX140 PoC and menu screen	46
5.2	Menu screen.....	46
5.3	Cook setting.....	47
5.3.1	Move to mode selection screen.....	47
5.3.2	Select mode.....	47
5.3.3	Select Auto	48
5.3.4	Select Manual.....	48
5.3.4.1	Set the number of watts	49
5.3.4.2	Move the cursor.....	49
5.3.4.3	Set the number of seconds	50
5.3.4.4	Start cooking	50
5.4	Defrost setting	51
5.4.1	Move to mode selection screen.....	51
5.4.2	Select mode.....	51
5.4.3	Select Manual.....	52
5.4.3.1	Set the level of defrosting.....	52
5.4.3.2	Move the cursor.....	53
5.4.3.3	Set the number of grams.....	53
5.4.3.4	Start defrosting	54
5.4.4	Select Fish.....	54
5.4.5	Select Meat.....	55
5.5	Recipe setting.....	56
5.5.1	Move to recipe selection screen.....	56
5.5.2	Select recipe.....	56
5.5.3	Select Beef Stew	57
5.5.4	Select Garlic Shrimp.....	57
5.5.5	Select Cup Cake.....	58
5.5.5.1	Set the number of cupcakes	58
5.5.5.2	Start cooking	59
5.6	About the “home” button.....	60
5.7	About the cooking completion screen	61
5.8	Smart wakeup function	61
6.	Reference Documents.....	62
	Revision History.....	63

1. Outline

This application note describes the operation and structure of the RX140 PoC. RX140 PoC is equipped with touch buttons, touch slider and LCD (240 × 320) and can be used as a demonstration to control the display and settings by imagining a microwave oven.

The overall RX140 PoC image is shown below.

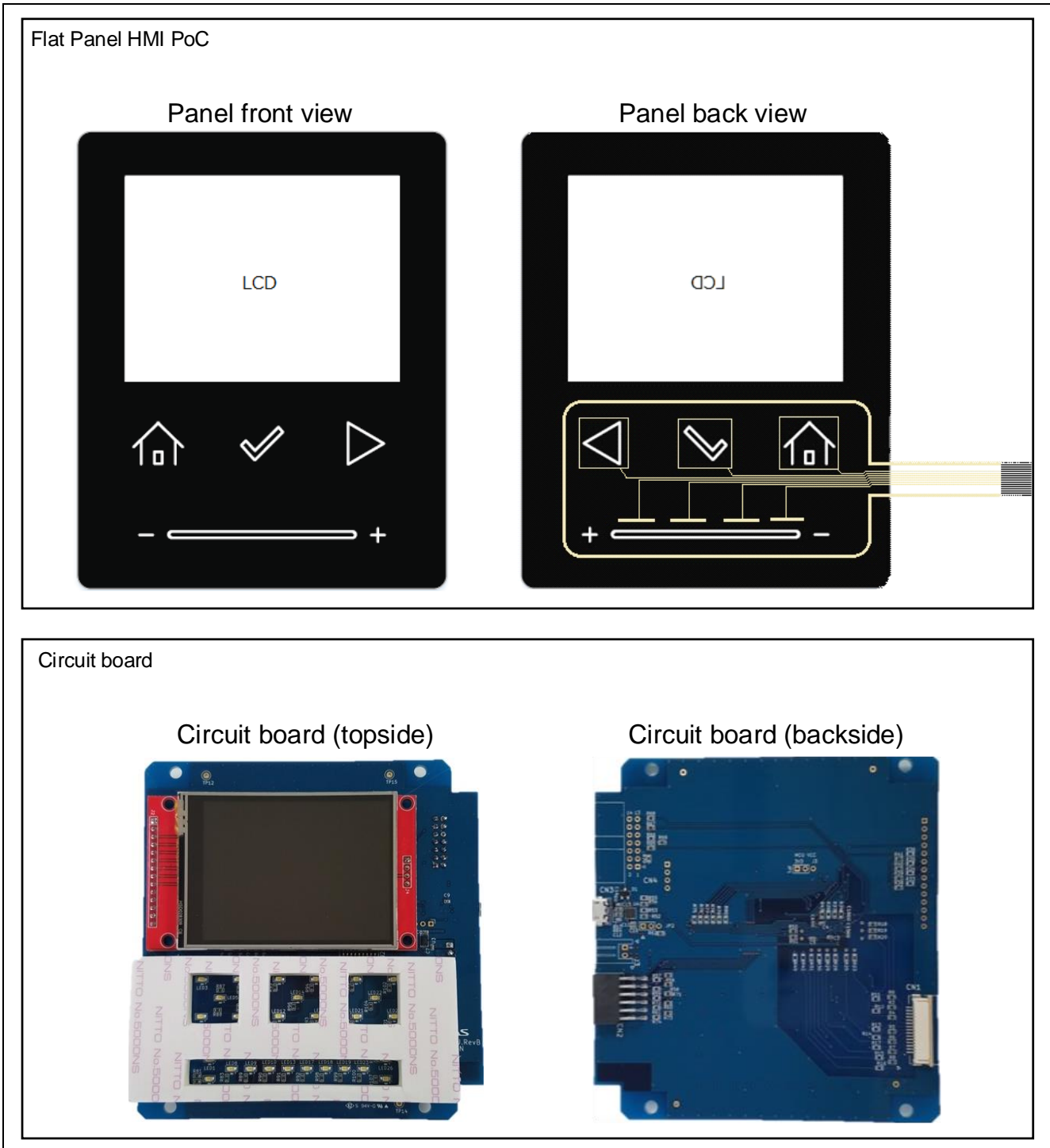

Figure 1-1 Overall RX140 PoC image

The system configuration is shown below.

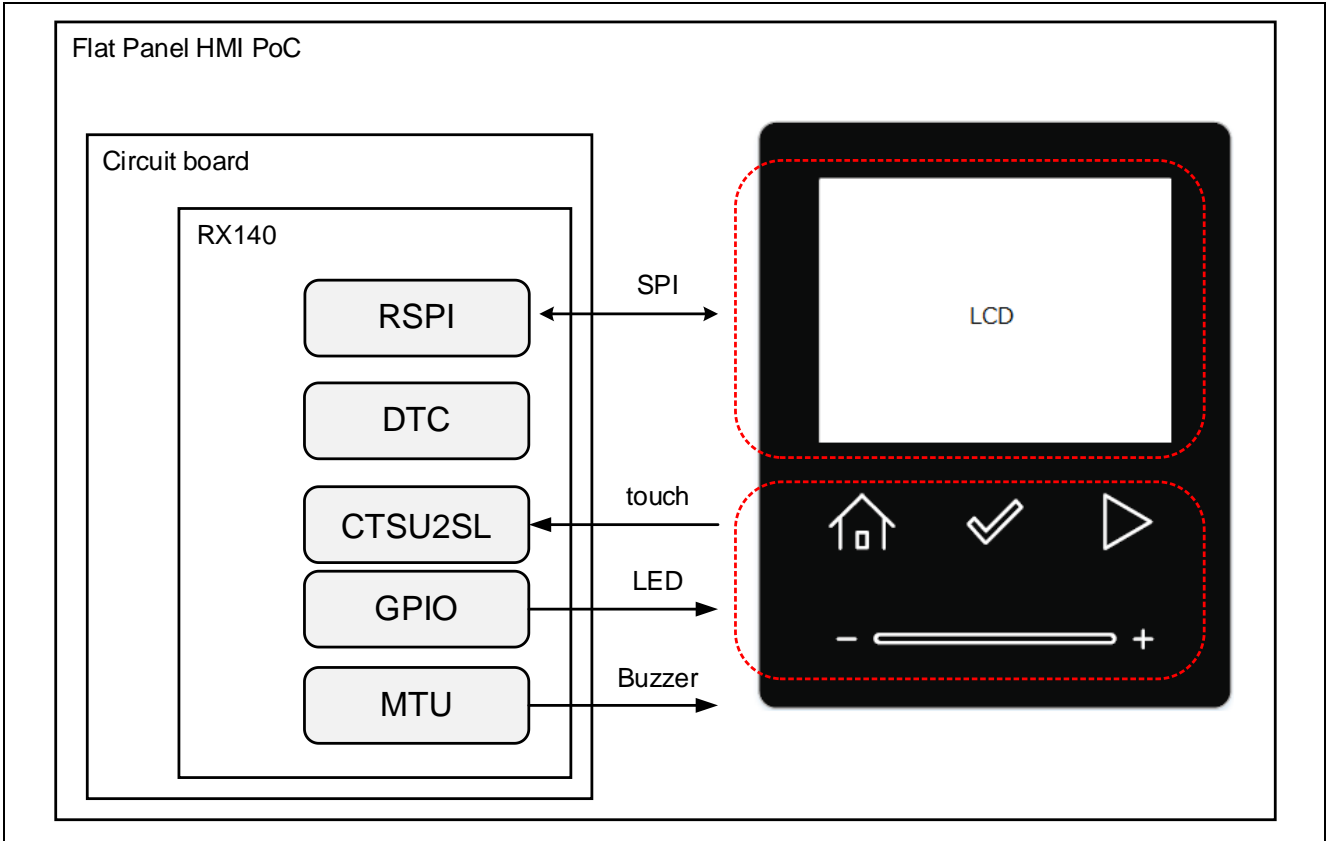

Figure 1-2 System configuration

The software configuration is shown below.

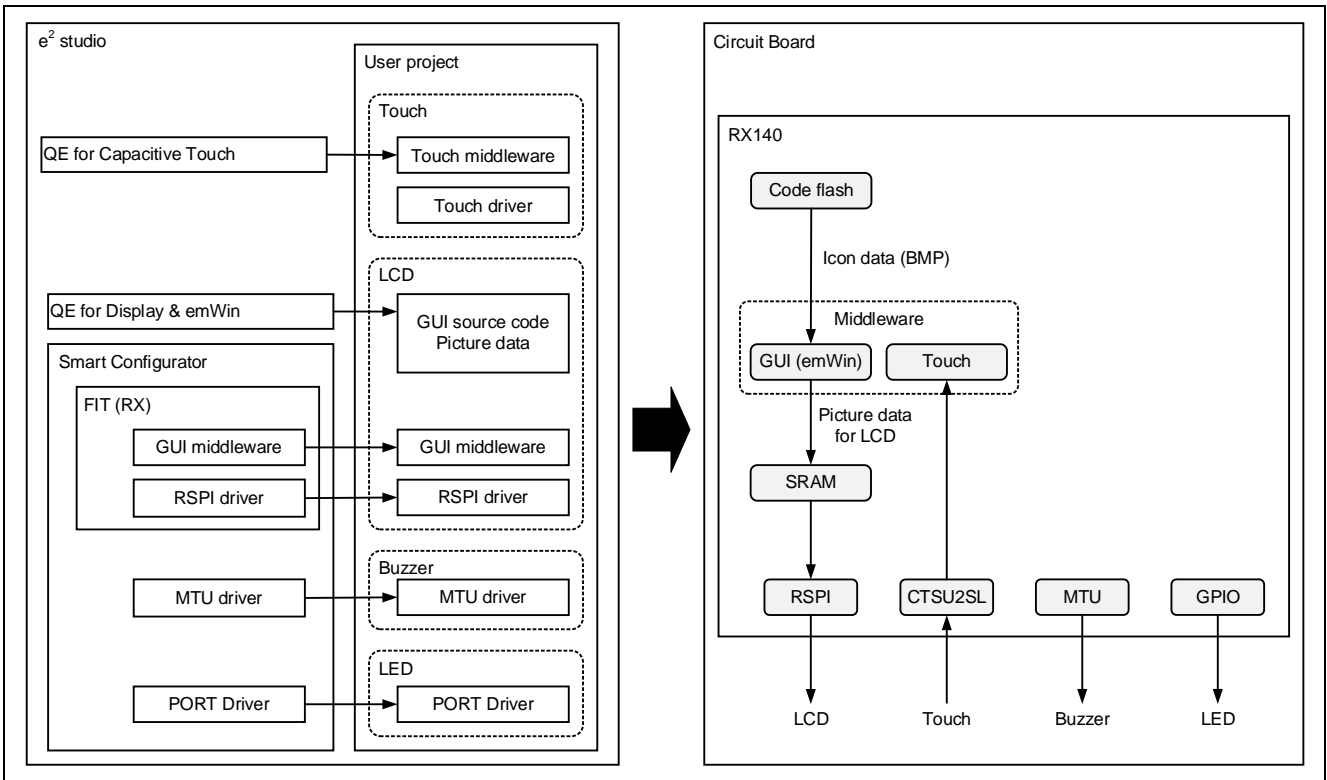

Figure 1-3 Software configuration

2. Operation Confirmation Conditions

The operation of the sample program has been confirmed under the following conditions.

Table 2-1 Operation Confirmation Conditions

Item	Contents
MCU used	R5F51406ADFM (RX140 Group)
Operating frequency	Operating frequency (ICLK) : 48MHz Peripheral operating frequency (PCLKB) : 24MHz
Operating voltage	3.3V
Integrated development	Renesas Electronics e ² studio 2023-01 (23.1.0)
C compiler	Renesas Electronics C/C++ Compiler Package for RX Family V3.05.00
	Compiler option — optimize=max — speed — inline=800
Smart Configurator	RX 2.16.0
Board support package (r_bsp)	V7.21
Endian order	Little Endian
Operating mode	Single chip mode
Processor mode	Super visor mode
Sample code version	V1.00
Emulator	E2 Emulator Lite

Table 2-2 Operation Confirmation Conditions (LCD)

Item	Contents
LCD module	2.8 TFT SPI 240 x 320 serial port module

3. Sample Programs

3.1 Demonstration Screen Flowchart

The demonstration screen flowchart of this sample program is shown below. For detail on each screen, refer to chapter 5.

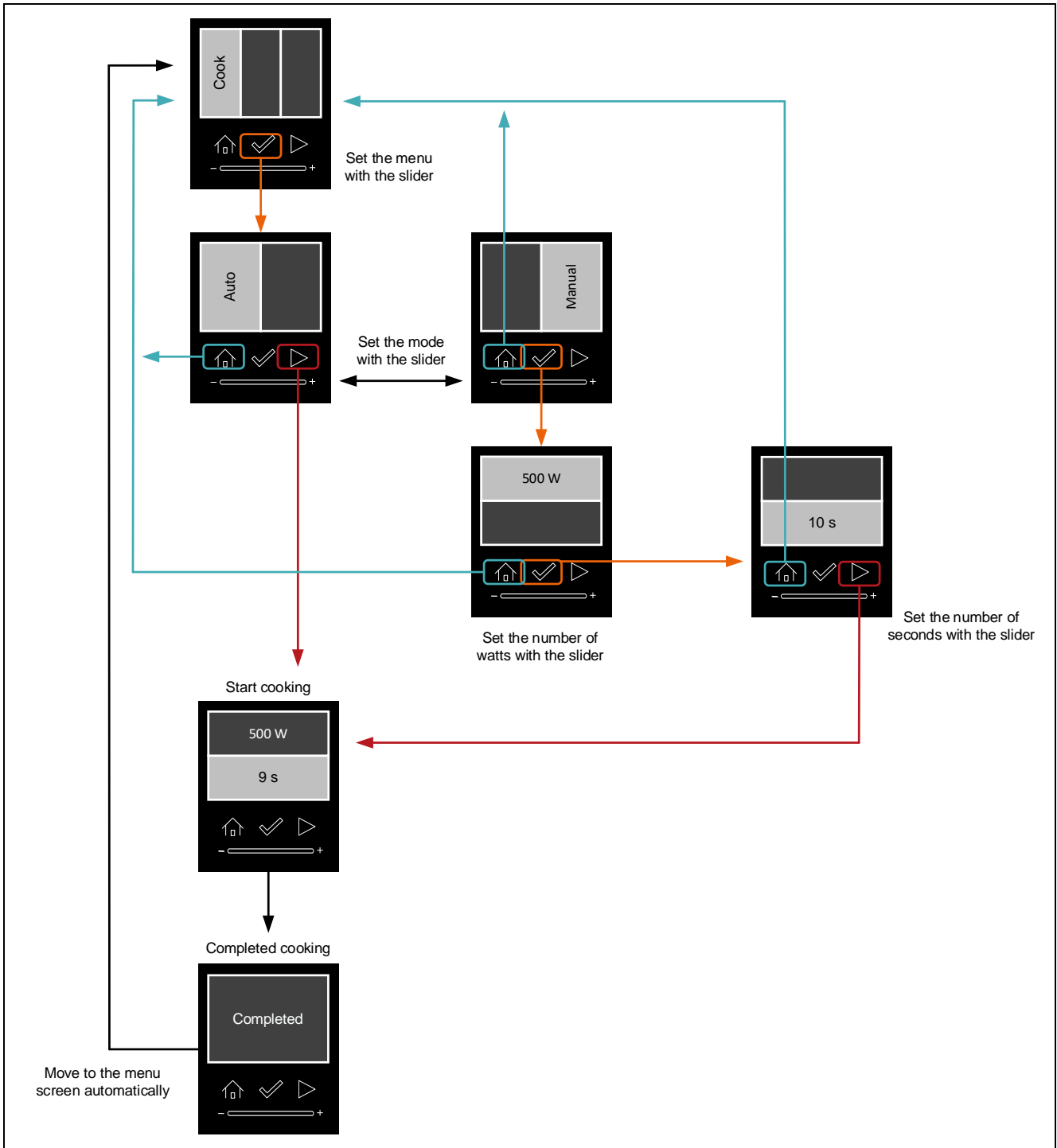

Figure 3-1 Flowchart of demonstration screen (Cook)

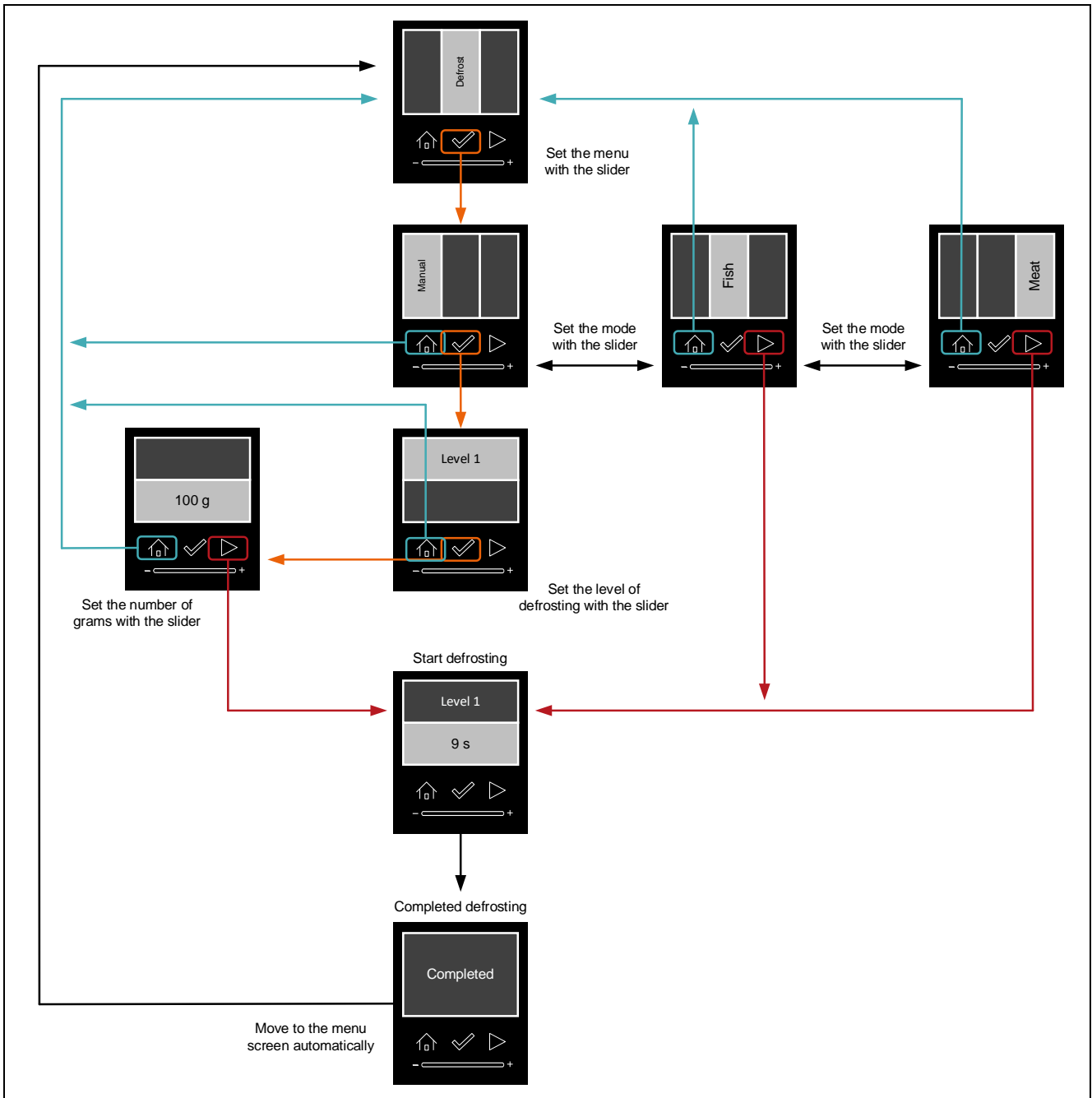

Figure 3-2 Flowchart of demonstration screen (Defrost)

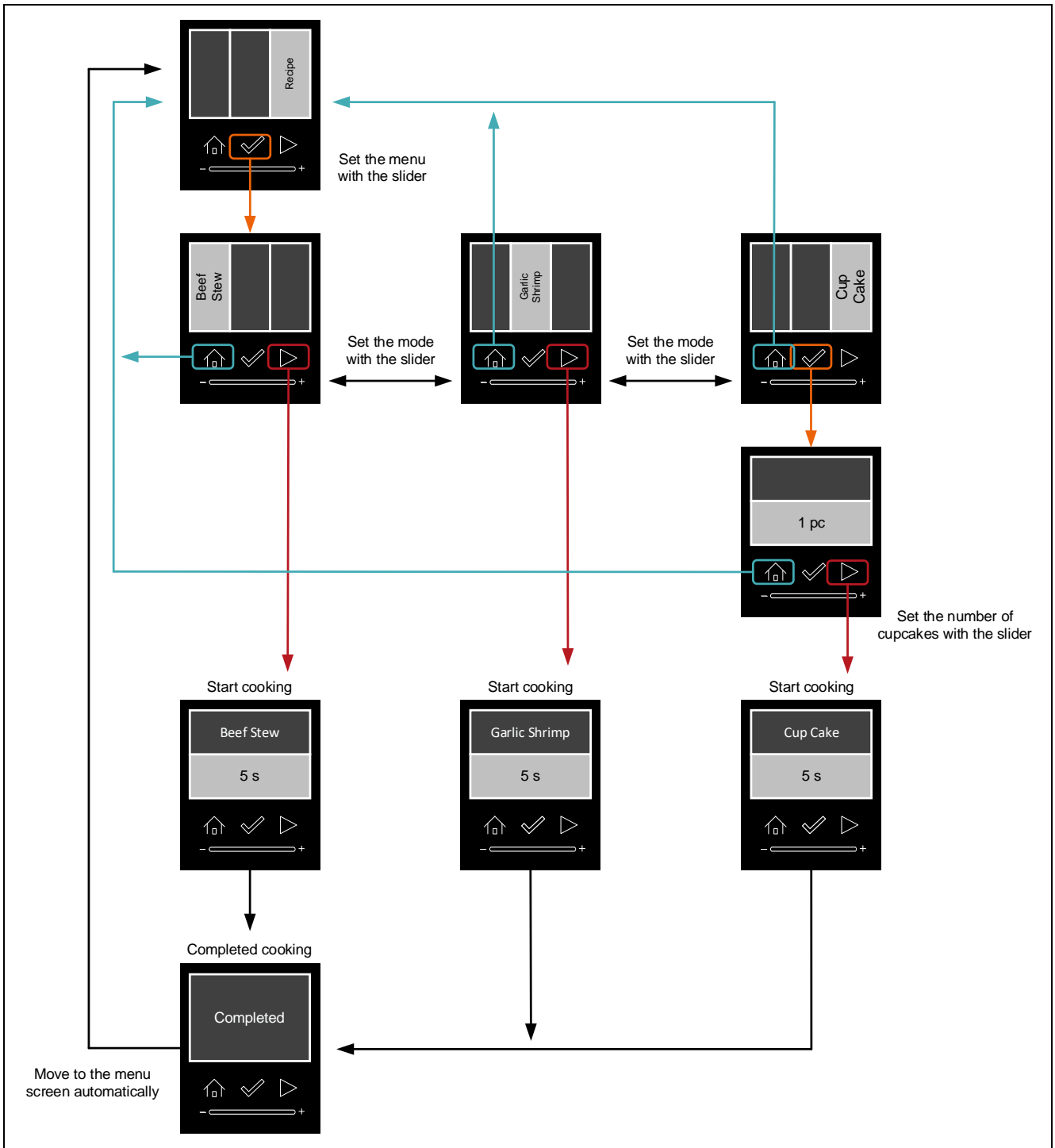

Figure 3-3 Flowchart of demonstration screen (Recipe)

3.2 Flowchart

3.2.1 Overall Flowchart

The overall flowchart is shown below.

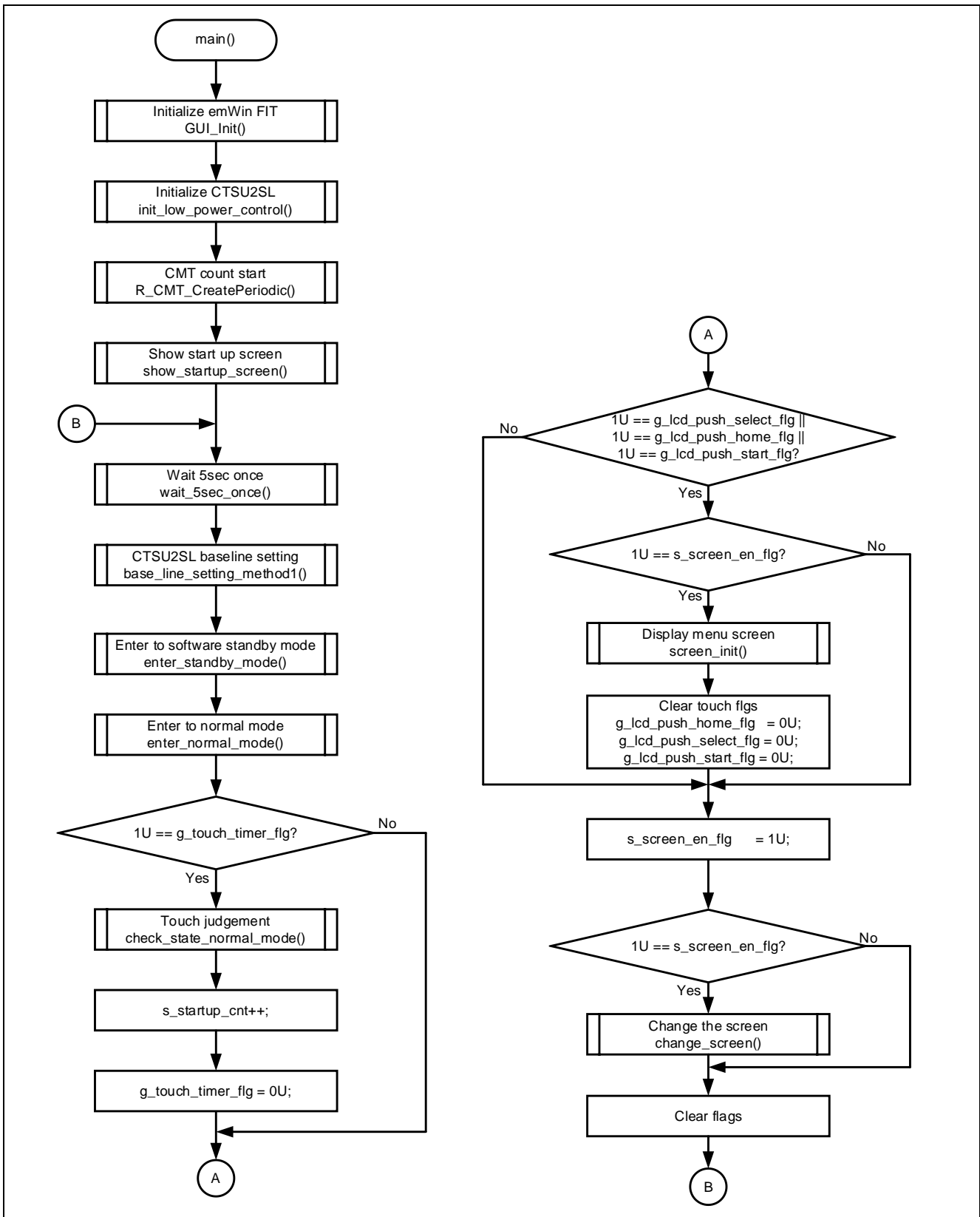

Figure 3-4 Overall flowchart

3.2.2 Processing at touch keys operation

The flowchart for touch keys operation is shown below.

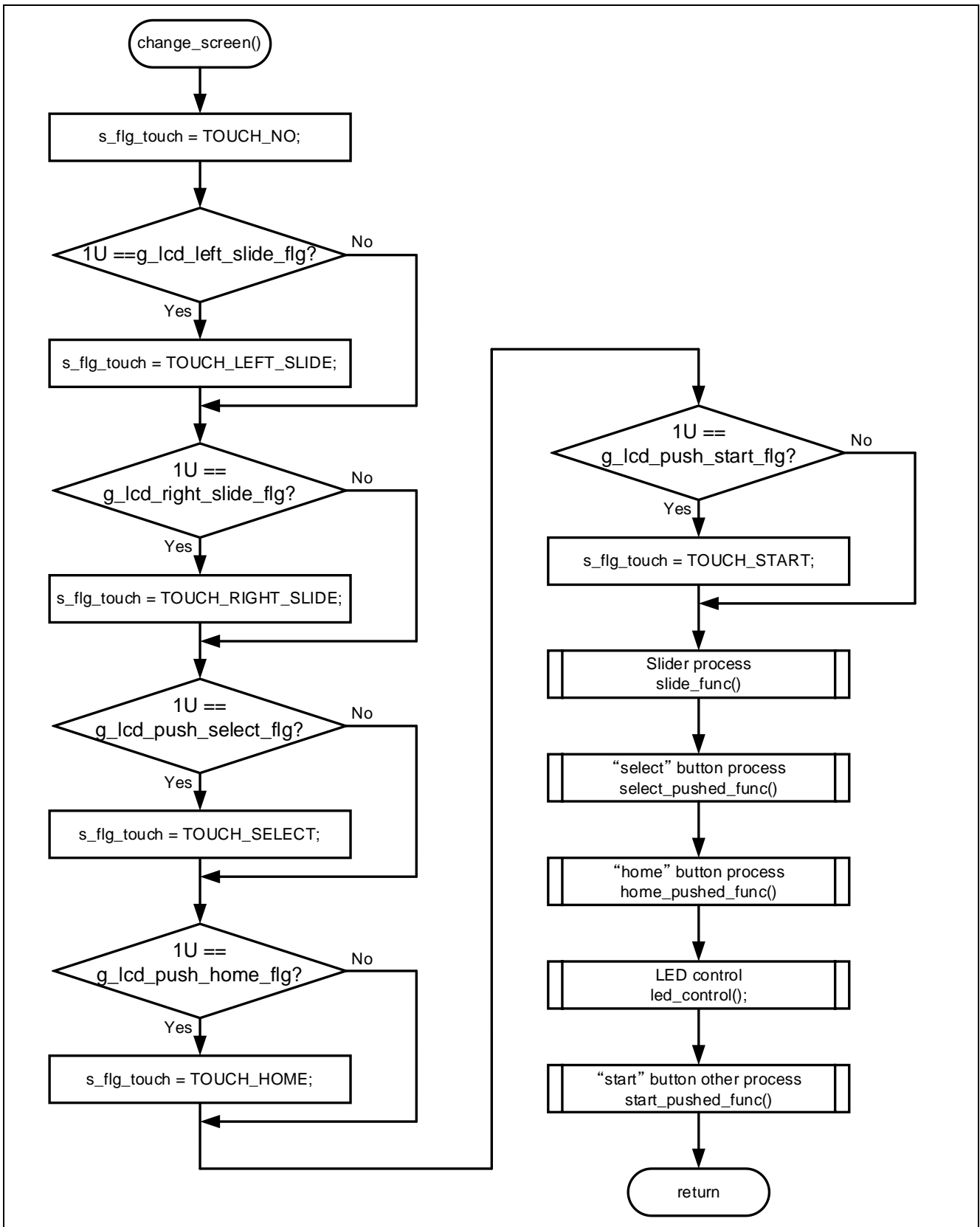

Figure 3-5 Flowchart for touch keys operation

3.2.3 Processing at touch slider operation

The flowchart for touch slider operation is shown below.

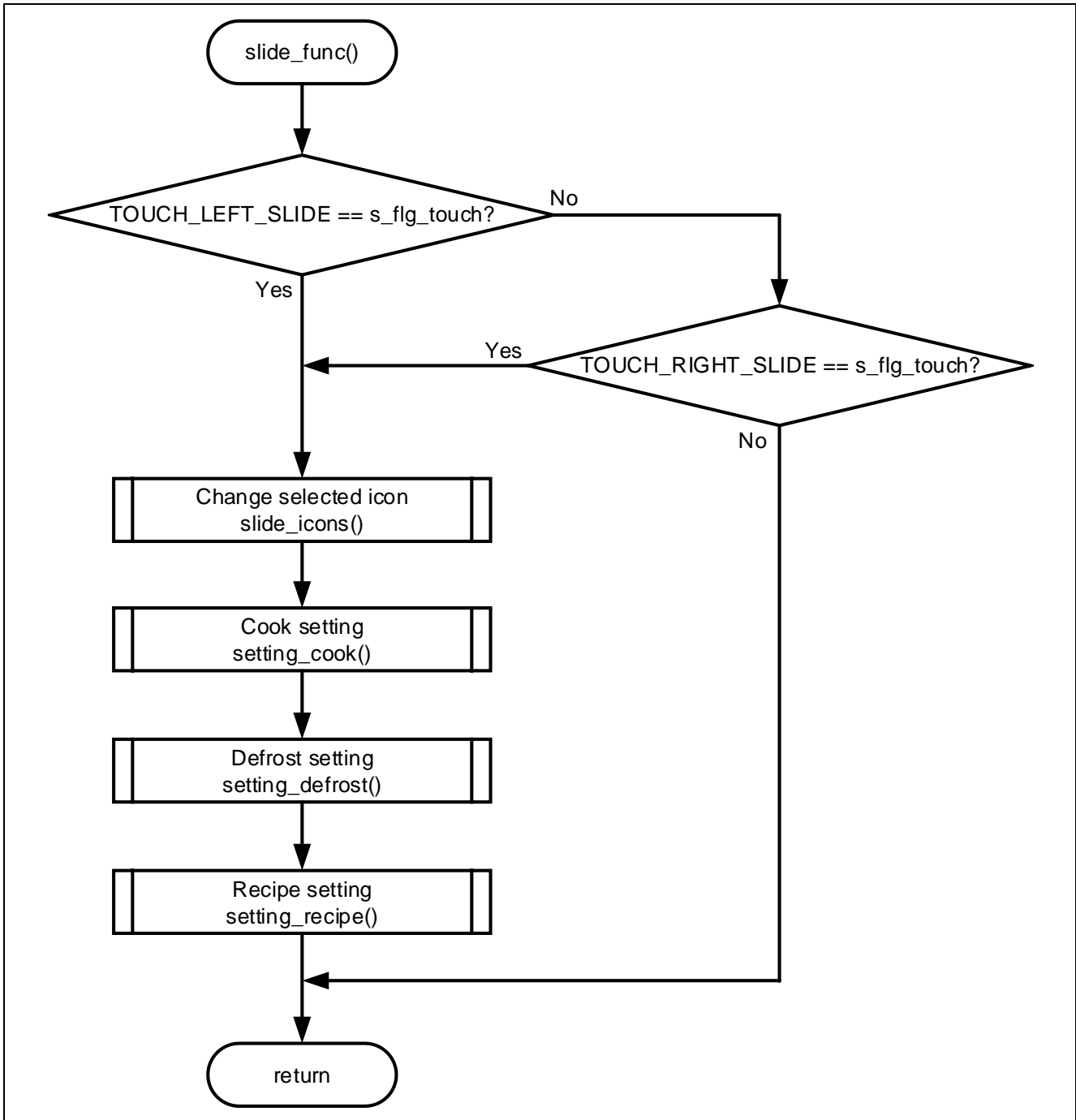

Figure 3-6 Flowchart for touch slider operation

3.2.4 Processing when the "home" button is touched

The flowchart when the "home" button is touched is shown below.

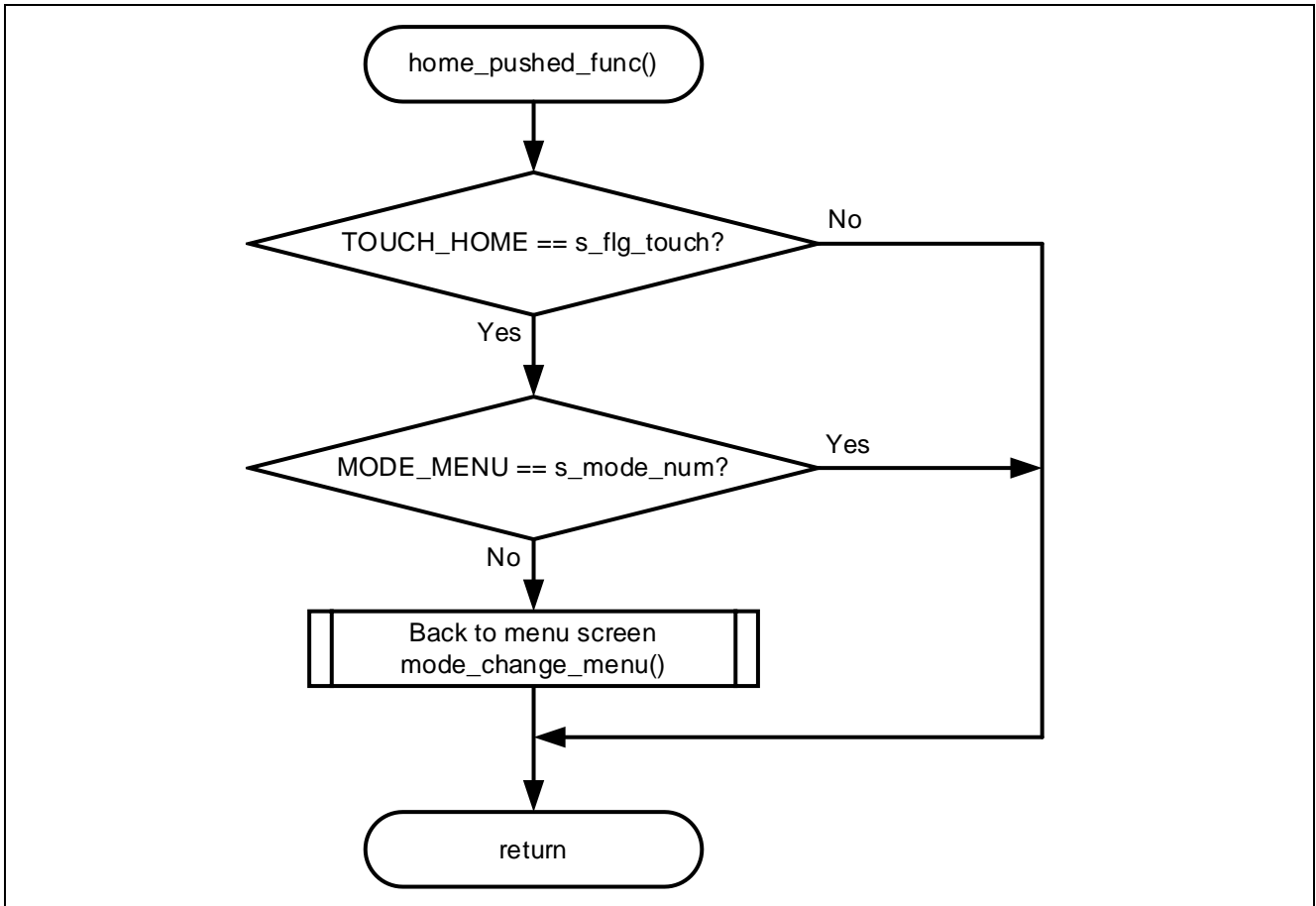

Figure 3-7 Flowchart when the "home" button is touched

3.2.5 Processing when the "select" button is touched

The flowchart when the "select" button is touched is shown below.

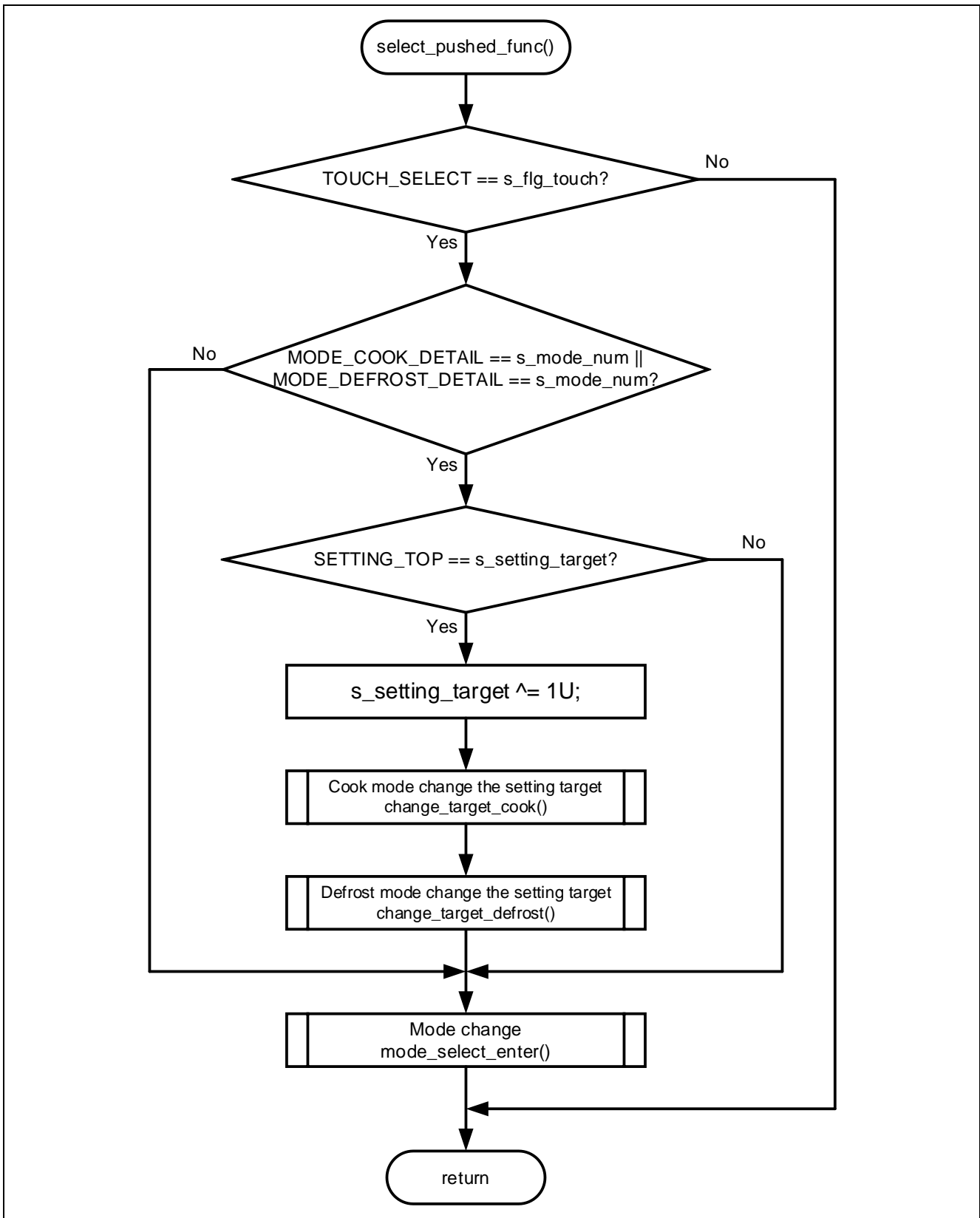

Figure 3-8 Flowchart when the "select" button is touched

3.2.6 Processing when the "start" button is touched

The flowchart when the "start" button is touched is shown below.

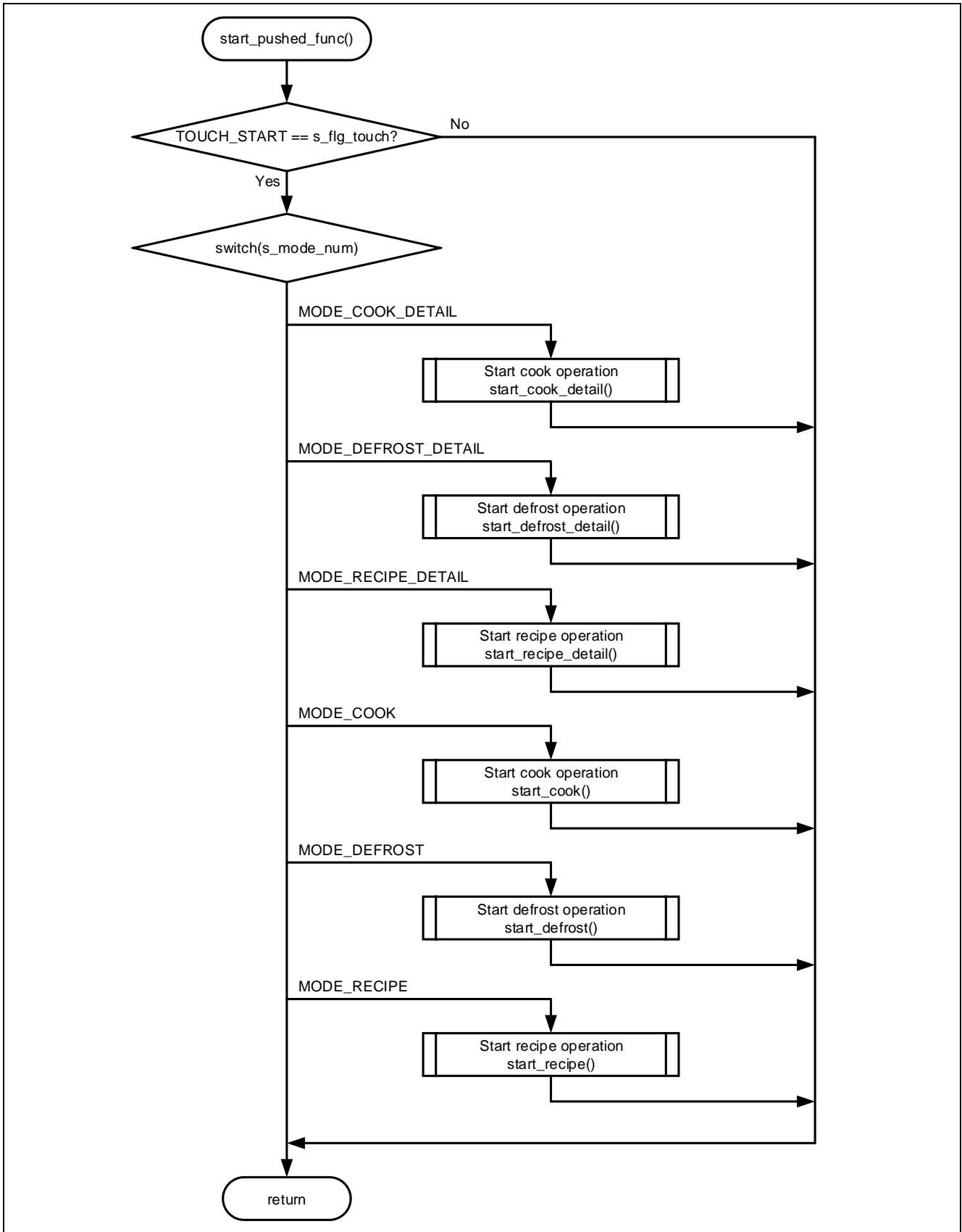

Figure 3-9 Flowchart when the "start" button is touched

3.2.7 Processing of CTSU2SL initialization

The flowchart of CTSU2SL initialization is shown below.

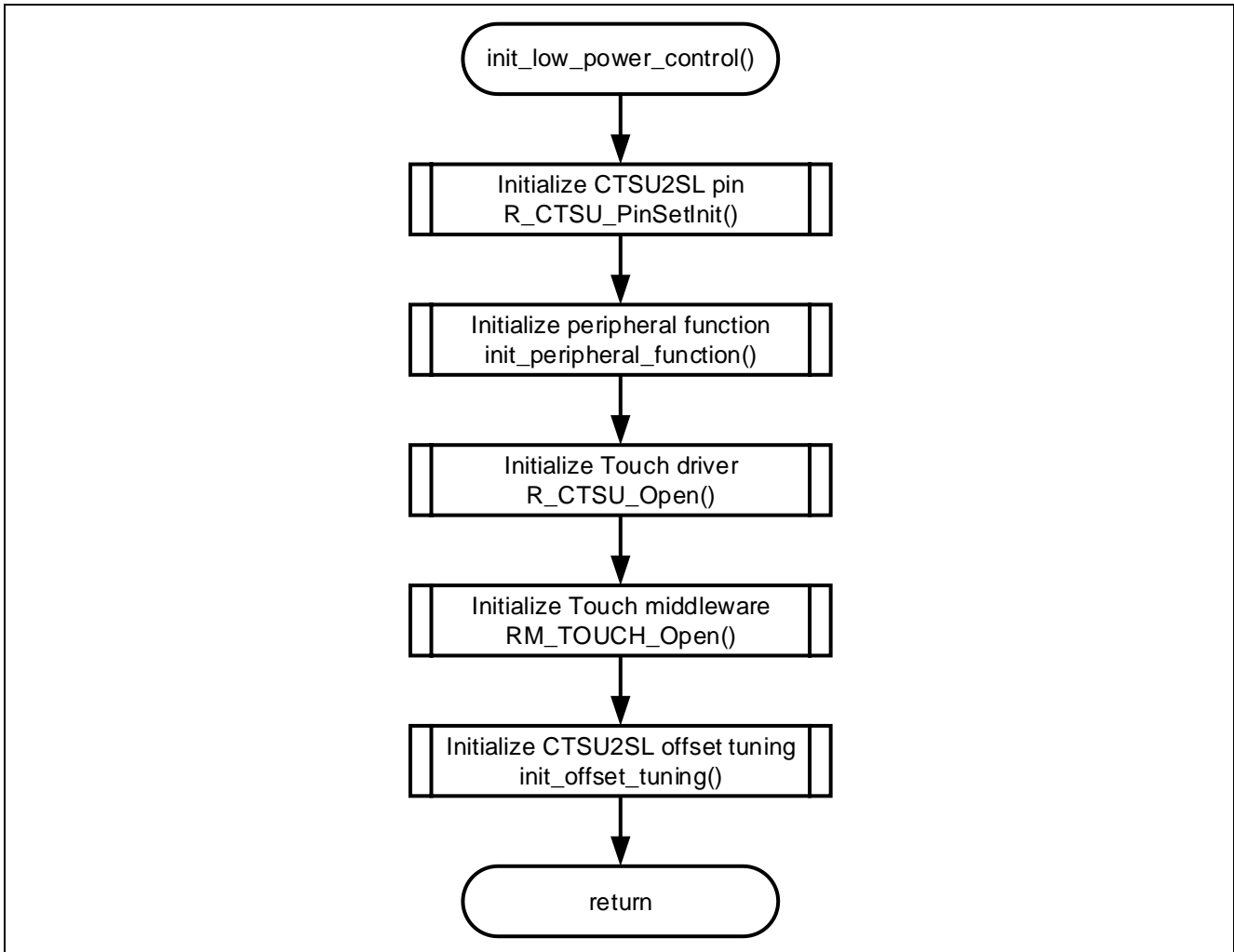

Figure 3-10 Flowchart of CTSU2SL initialization

3.2.8 Processing of CTSU2SL baseline settings

The flowchart of CTSU2SL baseline settings is shown below.

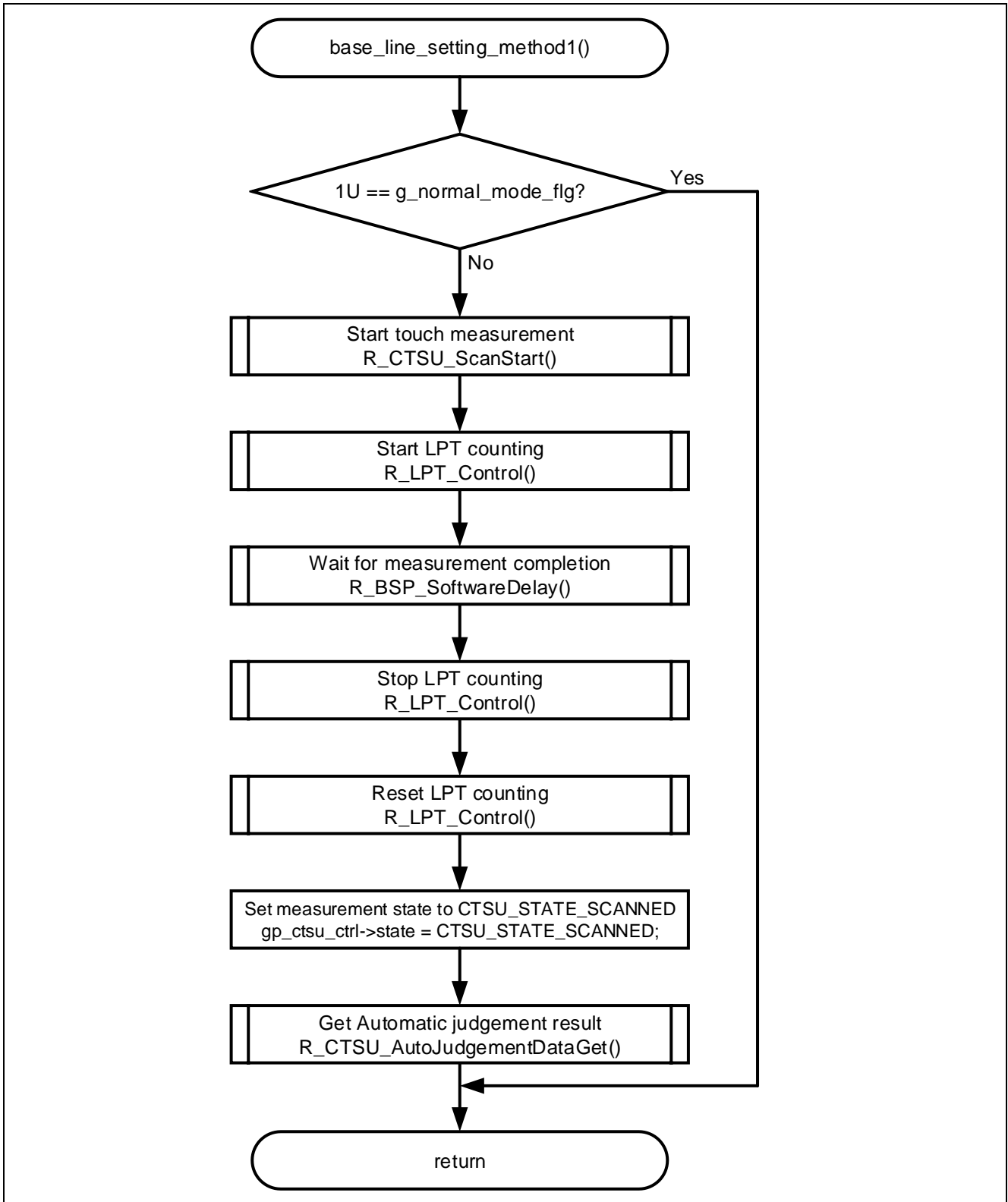

Figure 3-11 Flowchart of CTSU2SL baseline settings

3.2.9 Processing of software standby mode transition and CTSU2SL low power consumption measurement

The flowchart of software standby mode transition and CTSU2SL low power consumption measurement is shown below.

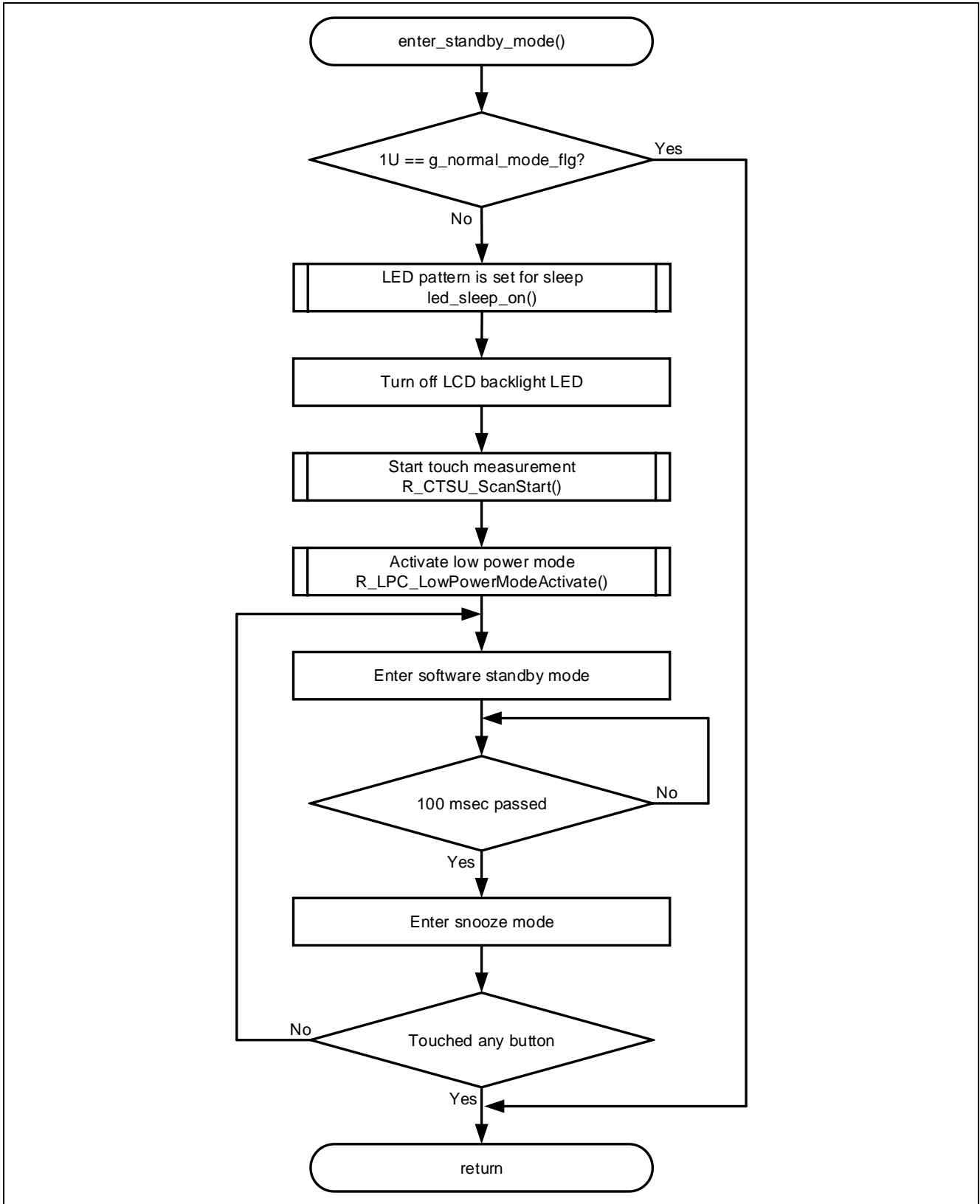

Figure 3-12 Flowchart of software standby mode transition and CTSU2SL low power consumption measurement

3.2.10 Processing of normal operation mode transition

The flowchart of normal operation mode transition is shown below.

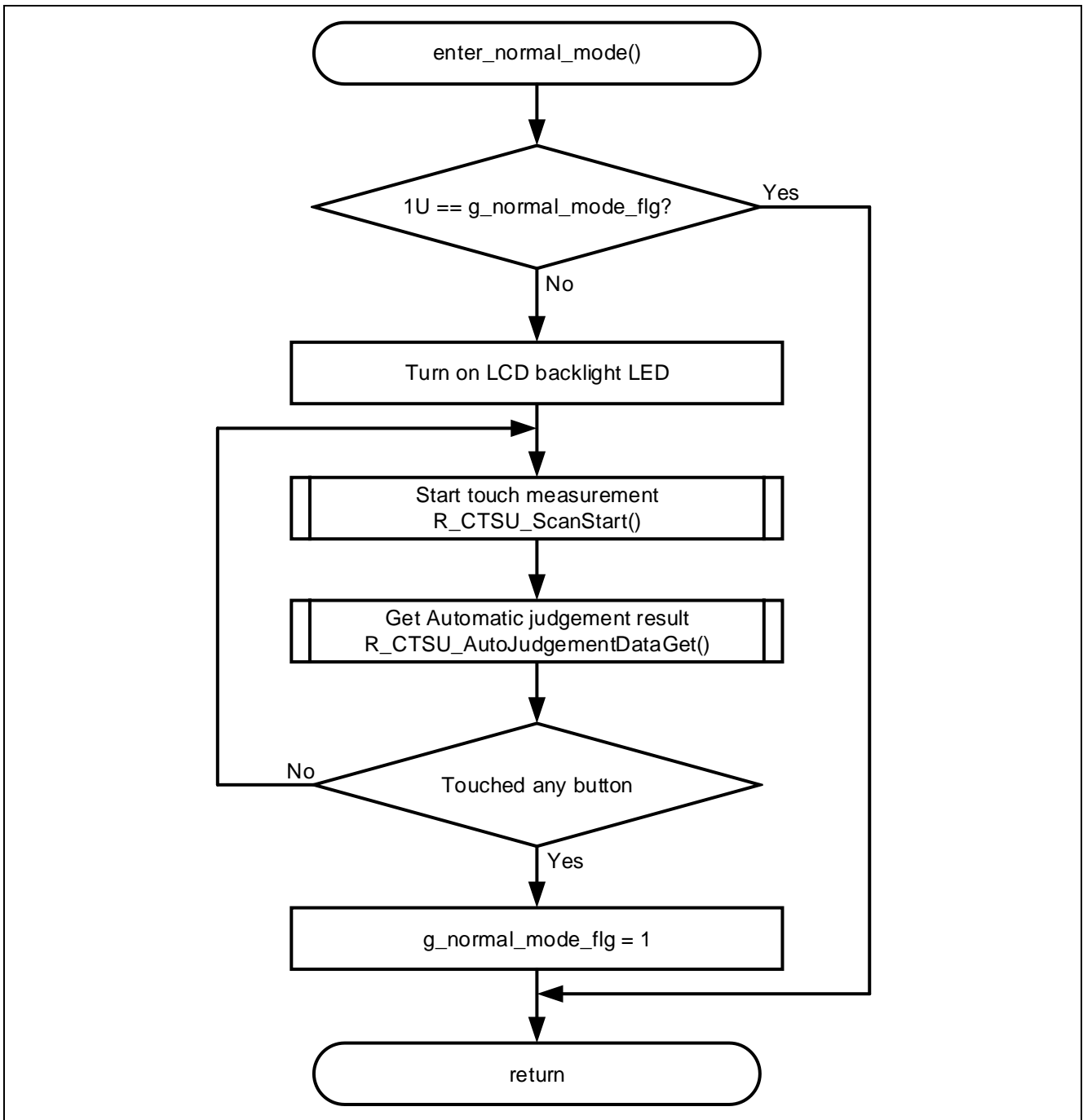

Figure 3-13 Flowchart of normal operation mode transition

3.2.11 Processing of CTSU2SL normal measurement

The flowchart of CTSU2SL normal measurement is shown below.

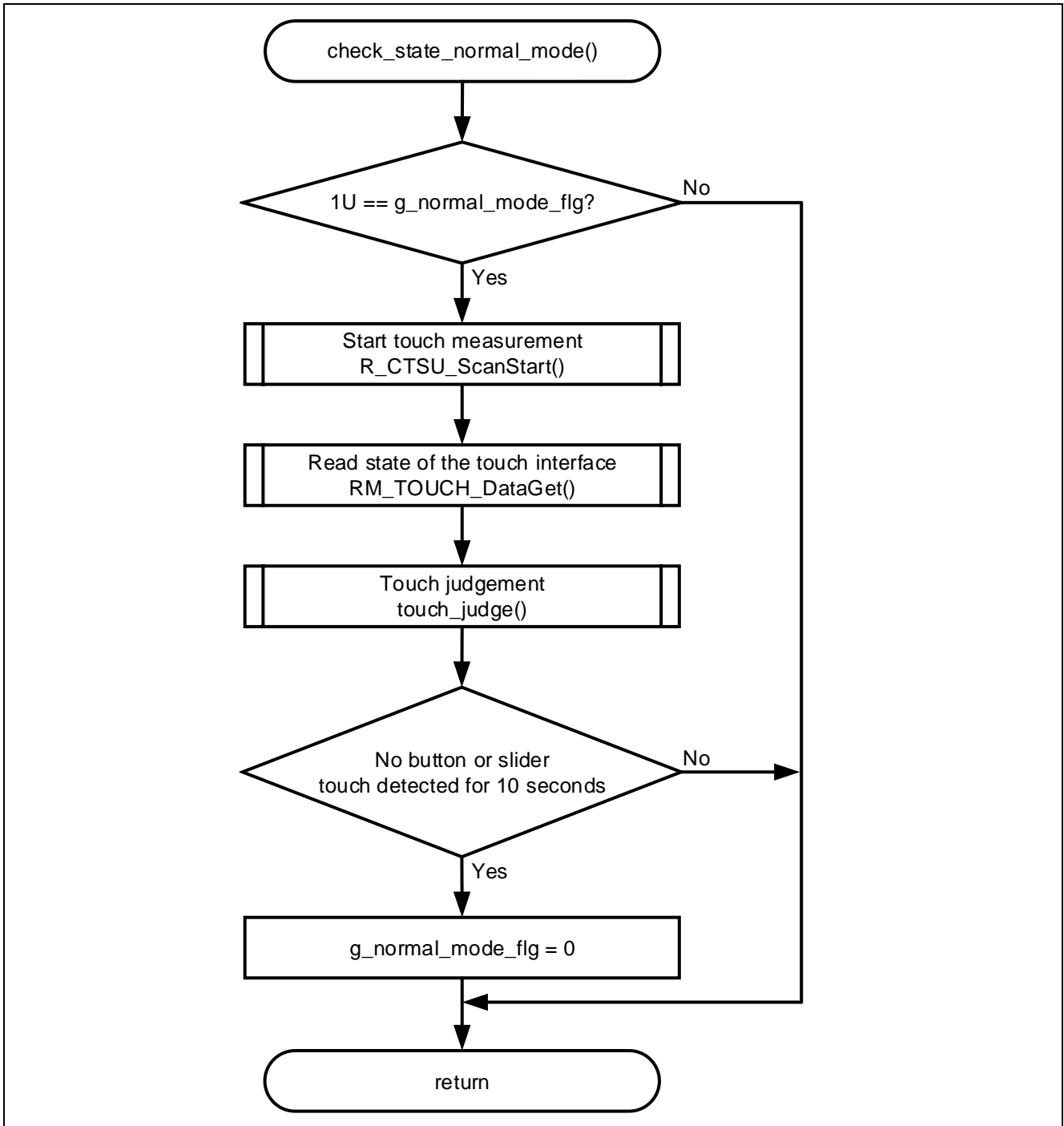

Figure 3-14 Flowchart of CTSU2SL normal measurement

3.2.12 Processing of touch judgement

The flowchart of touch judgement is shown below.

If the left side of the touch slider is touched after touching the right side of the touch slider, the touch slider is judged to have slid to the left. The same is true on the opposite side.

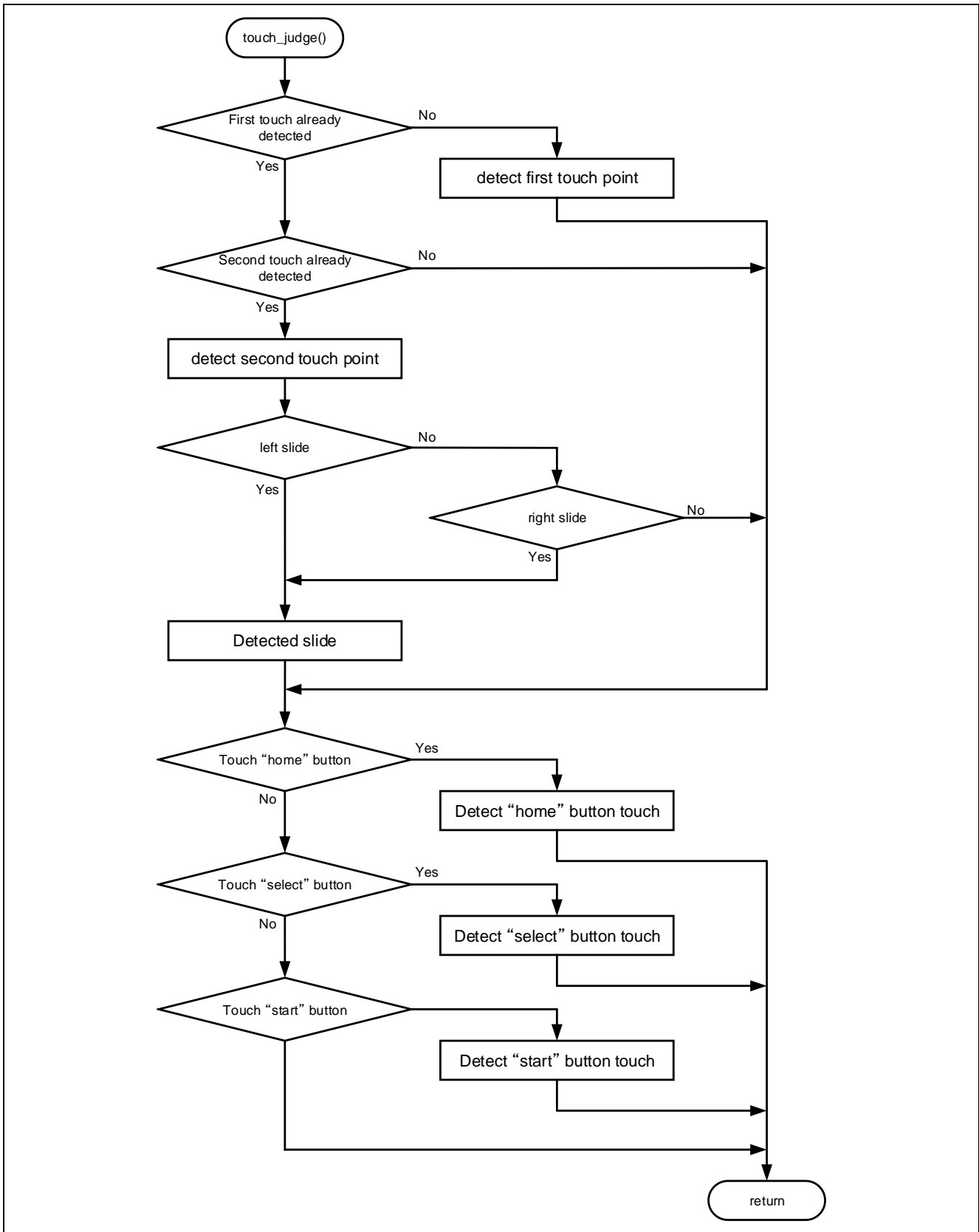

Figure 3-15 Flowchart of touch judgement

3.2.13 Processing of startup screen display

The flowchart of startup screen display is shown below.

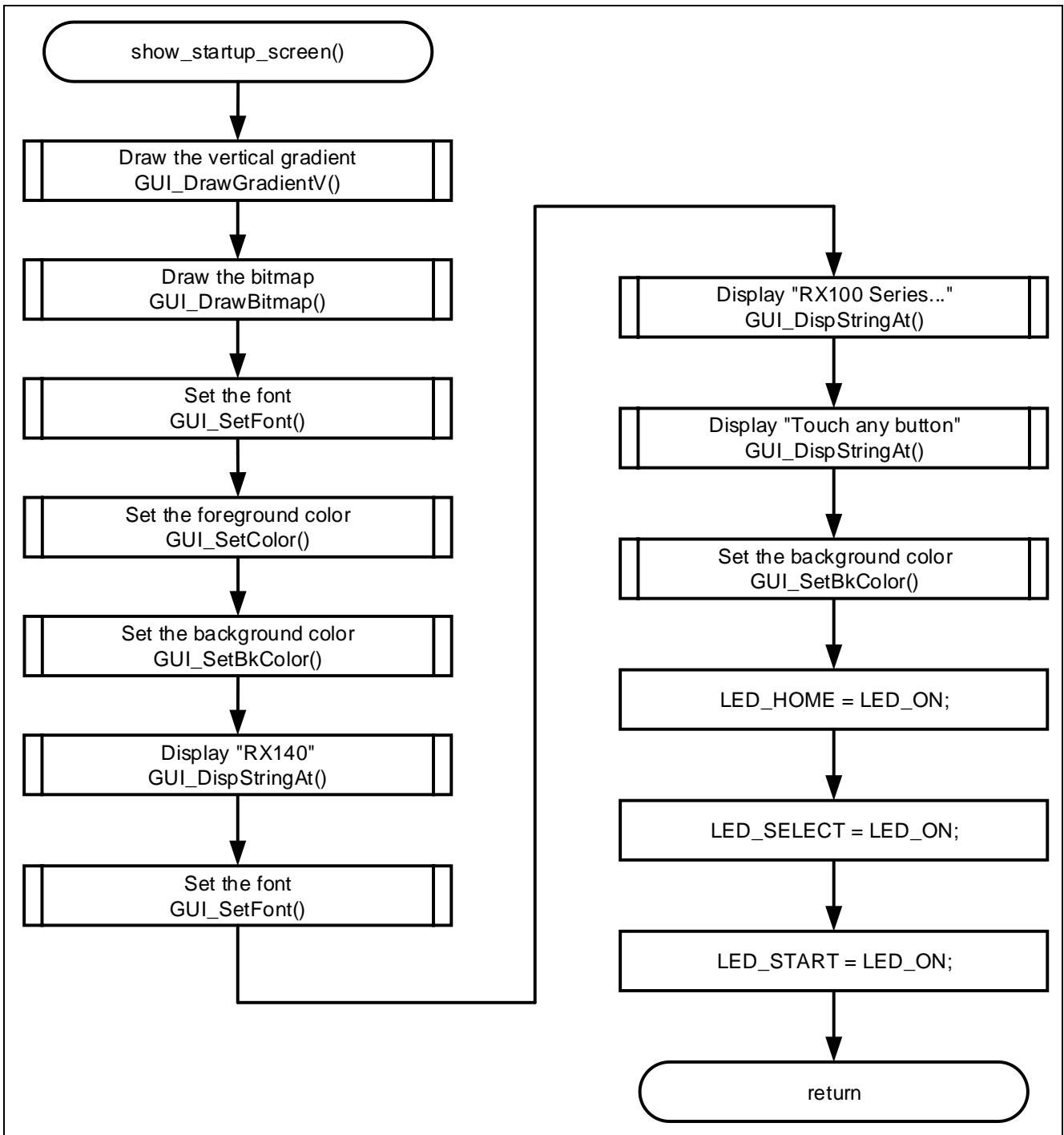

Figure 3-16 Flowchart of startup screen display

3.2.14 Processing of 5 seconds wait

The flowchart of 5 seconds wait is shown below.

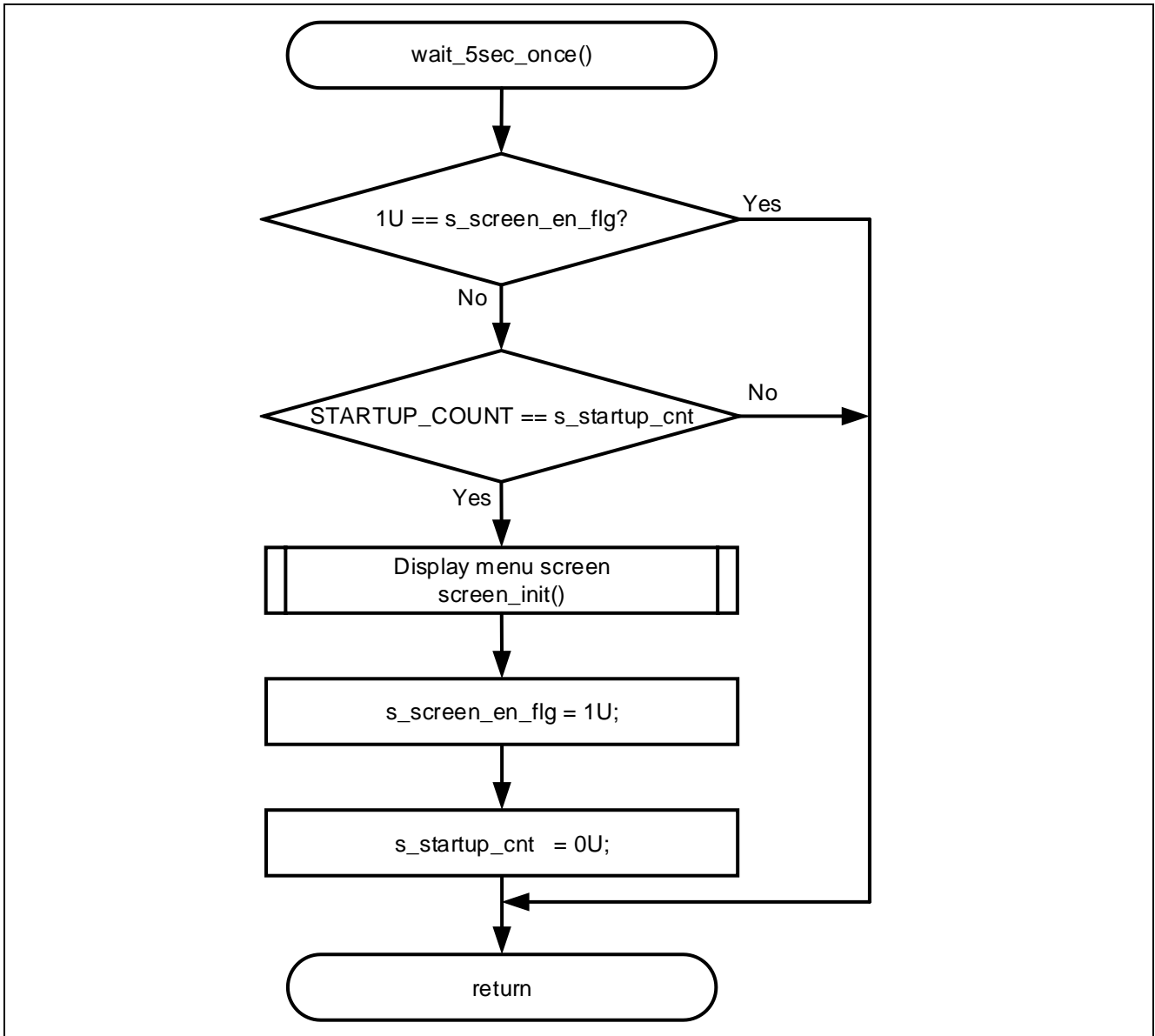

Figure 3-17 Flowchart of 5 seconds wait

3.2.15 Processing of screen initialization

The flowchart of screen initialization is shown below.

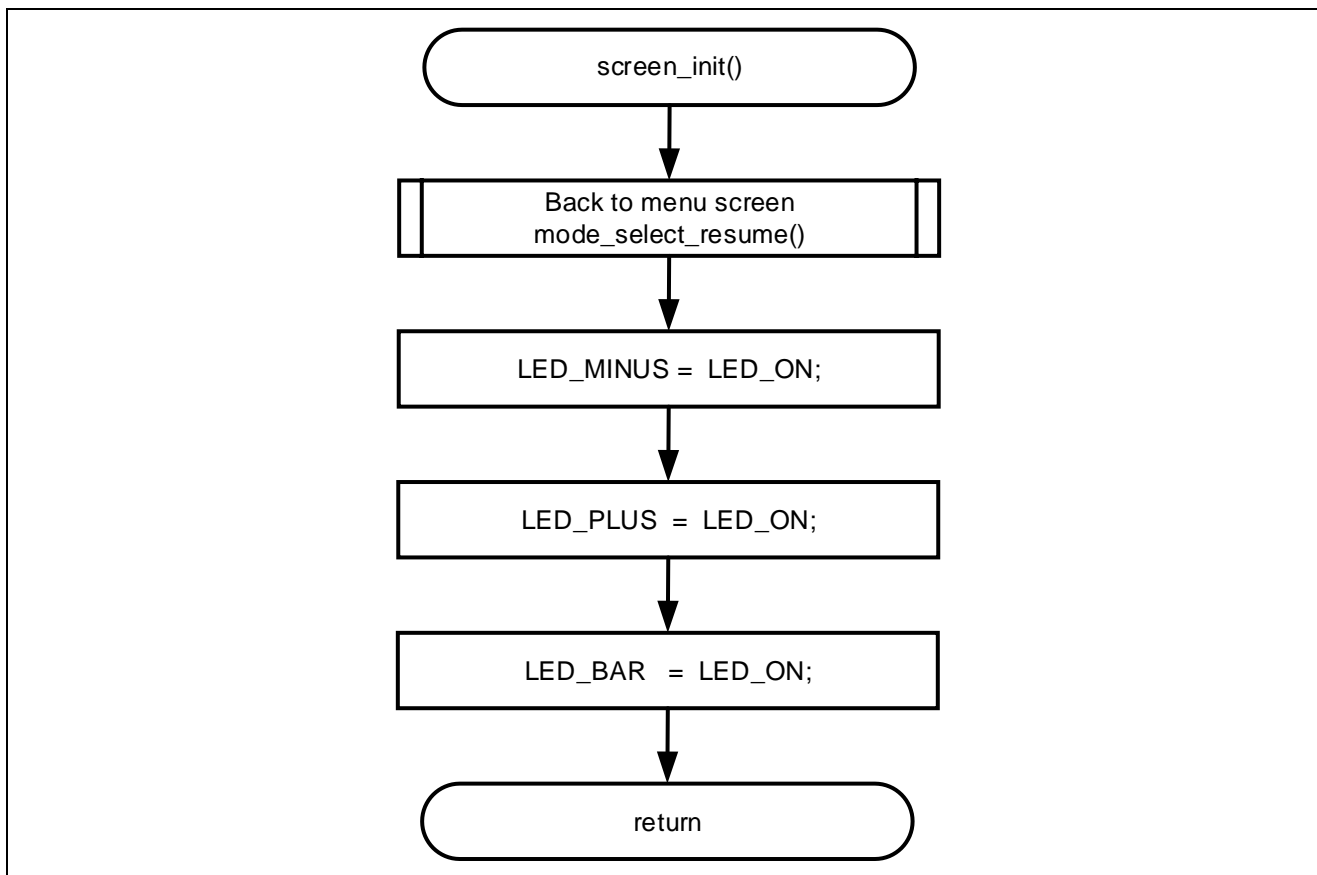

Figure 3-18 Flowchart of screen initialization

3.2.16 Processing of peripheral function initialization

The flowchart of peripheral function initialization is shown below.

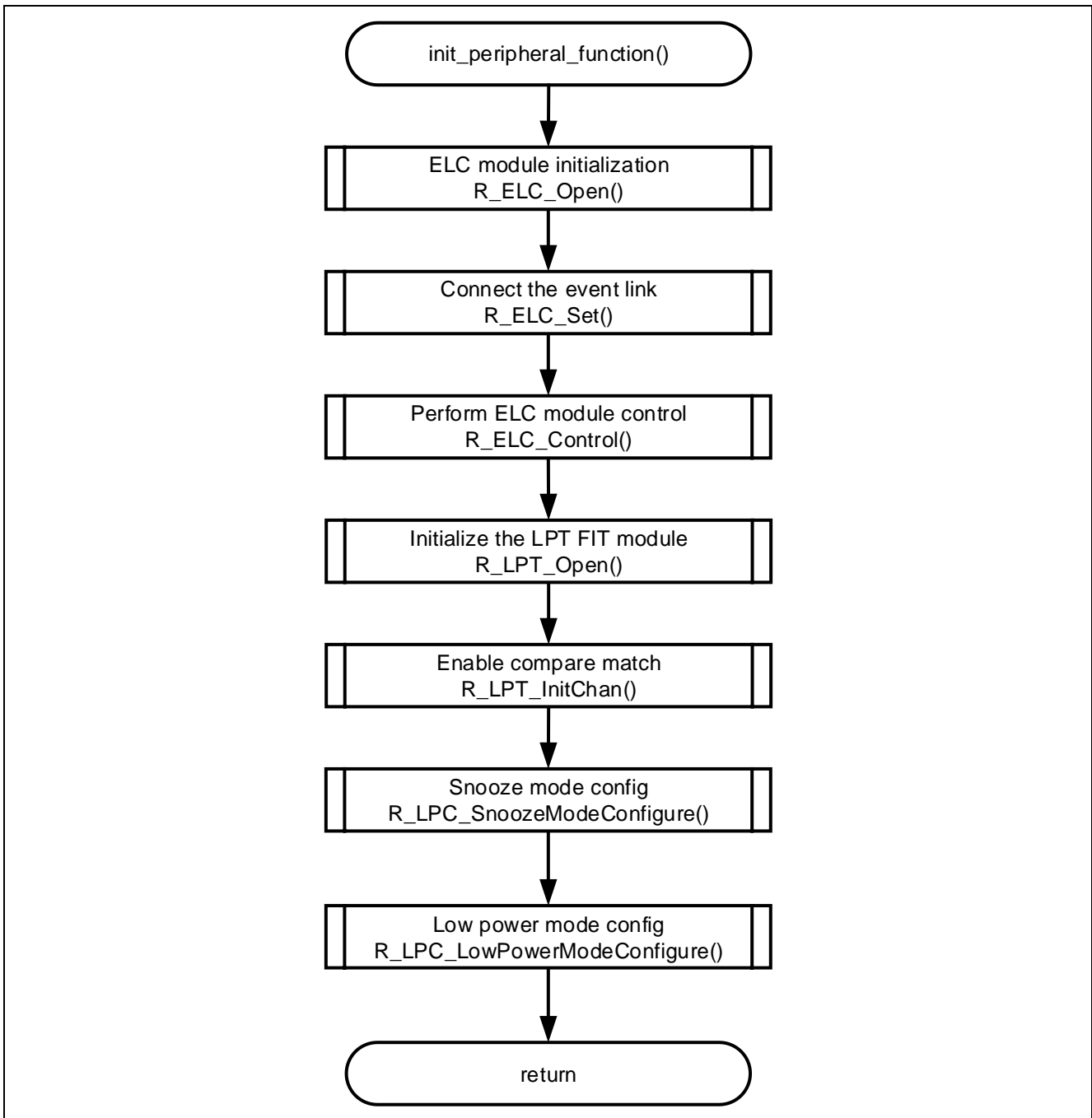

Figure 3-19 Flowchart of peripheral function initialization

3.2.17 Processing of offset initialization for tuning

The flowchart of offset initialization for tuning is shown below.

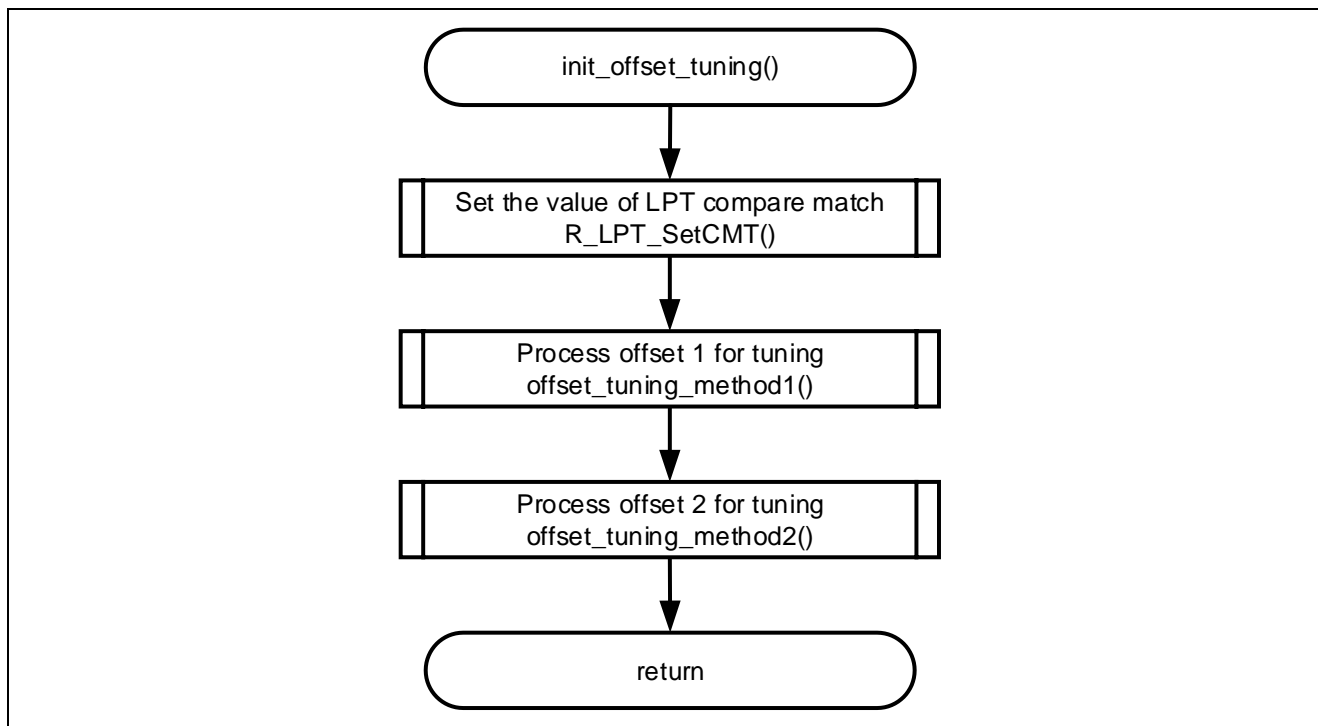

Figure 3-20 Flowchart of offset initialization for tuning

3.2.18 Processing of menu display resumption

The flowchart of menu display resumption is shown below.

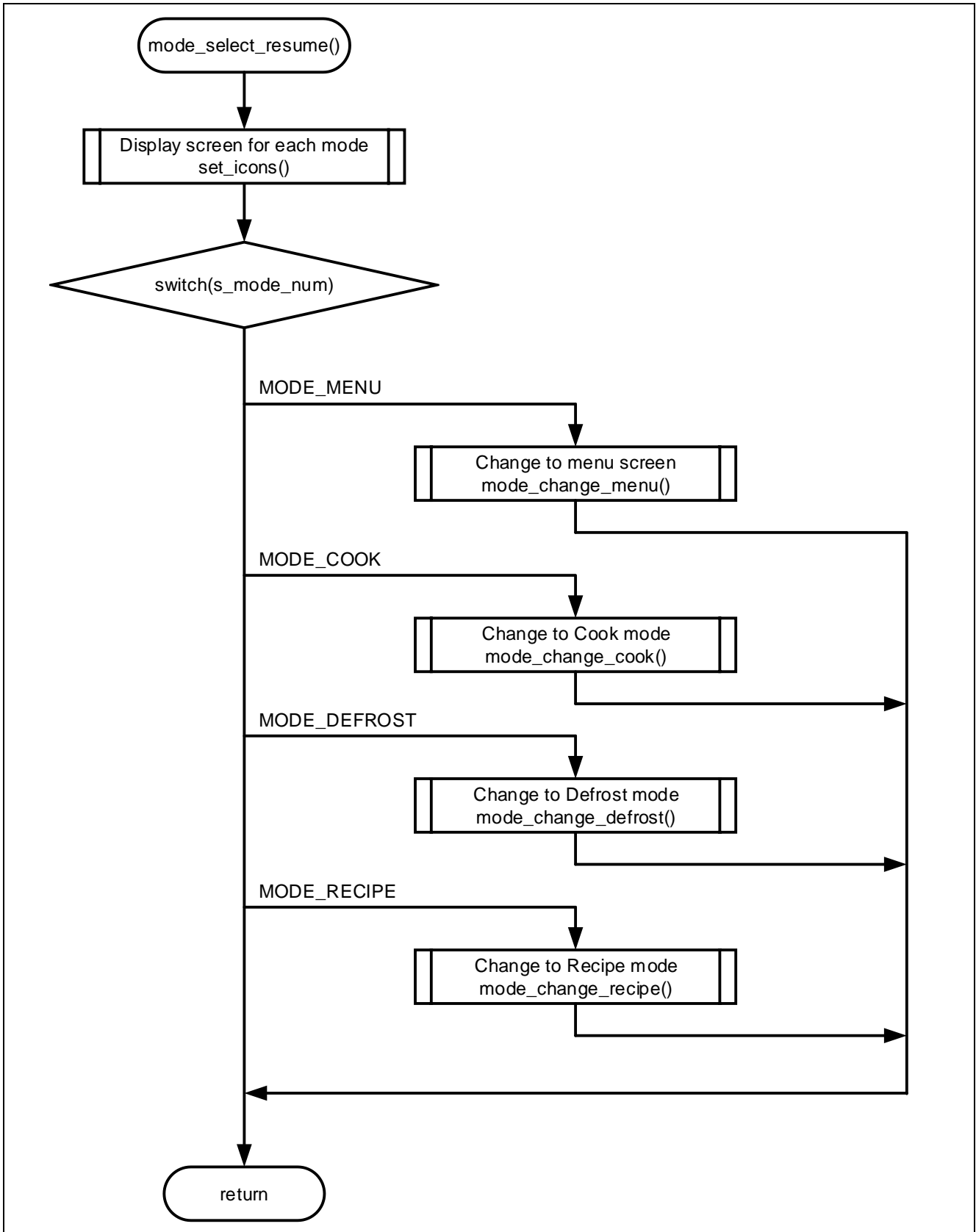

Figure 3-21 Flowchart of menu display resumption

3.2.19 Processing of setting LED pattern to sleep

The flowchart of setting LED pattern to sleep is shown below.

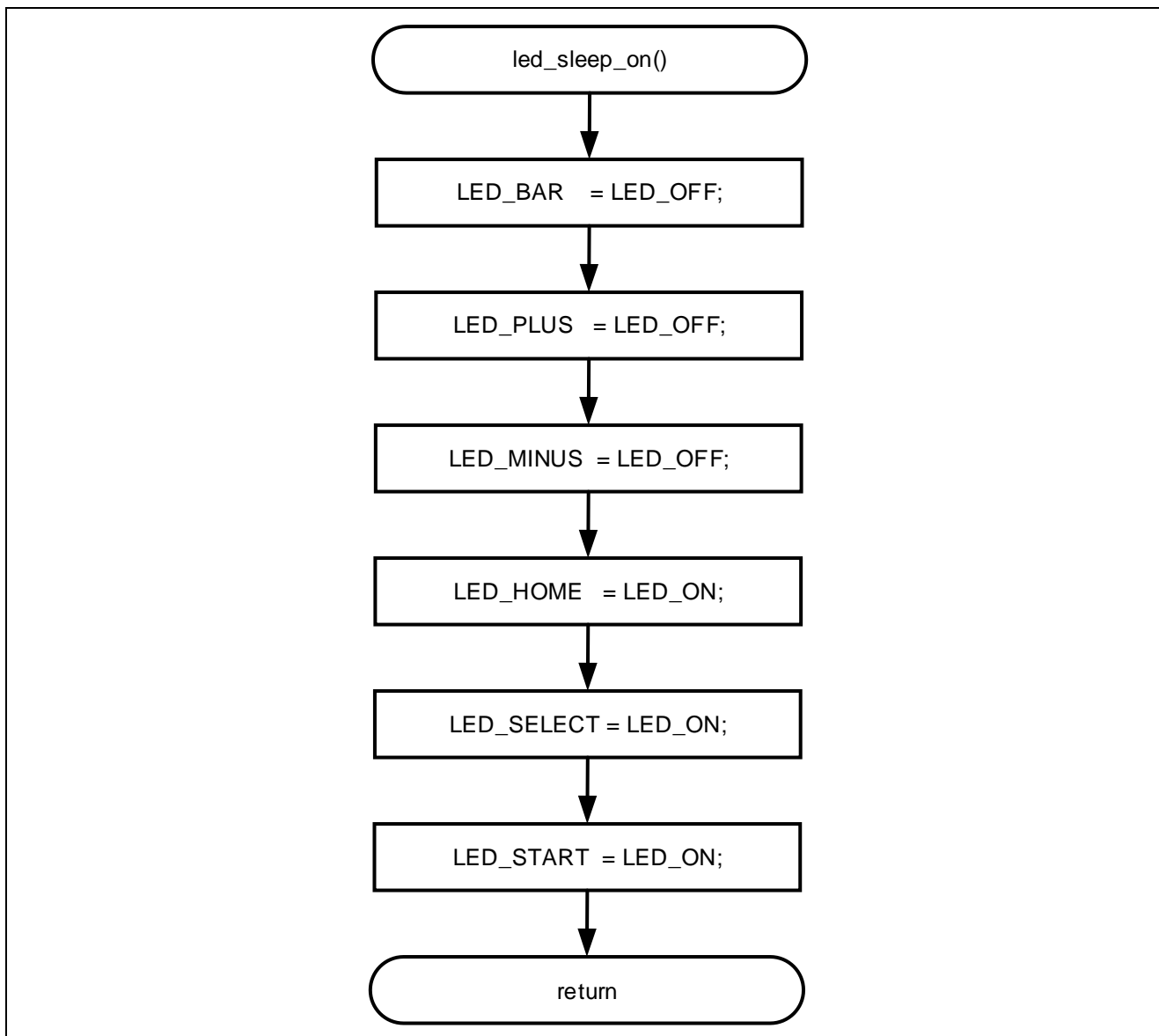

Figure 3-22 Flowchart of setting LED pattern to sleep

3.2.20 Processing of LED control

The flowchart of LED control is shown below.

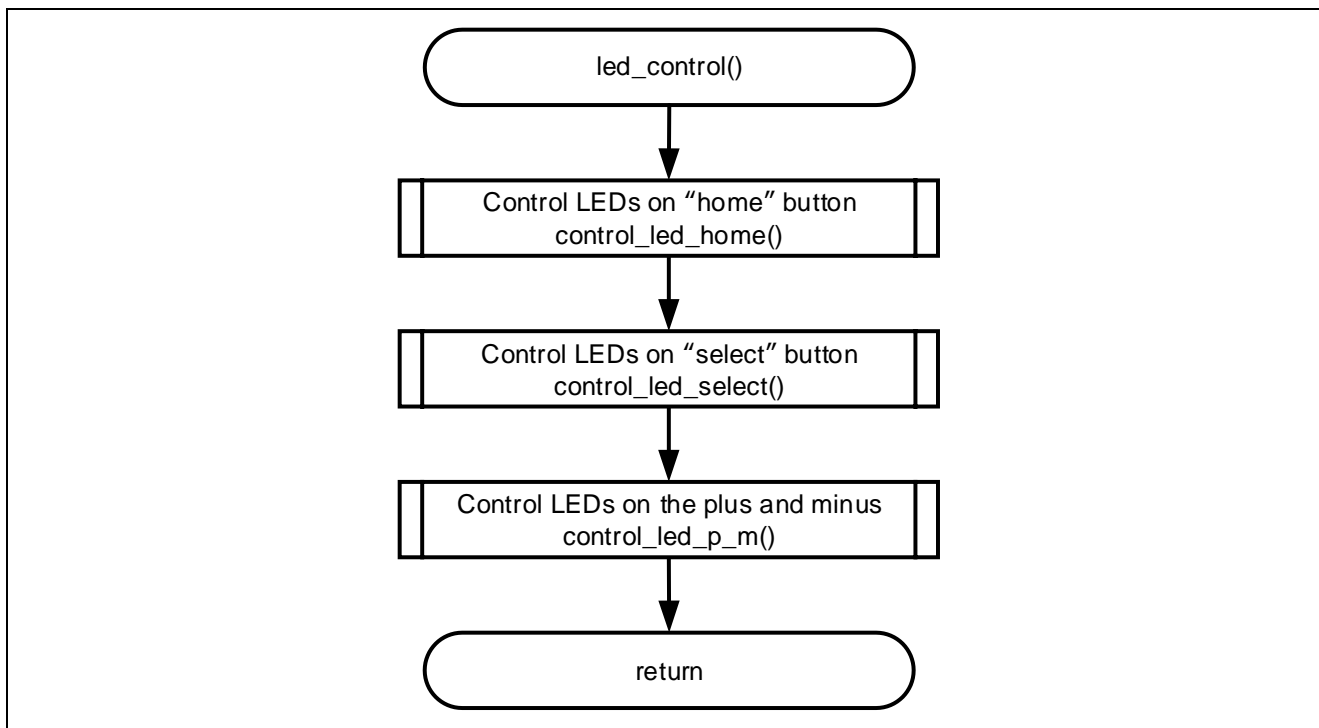

Figure 3-23 Flowchart of LED control

3.3 Pins Used

The following shows lists pins used in this sample program.

Table 3-1 List of Pins and Functions

Pin Name	Input/Output	Function
PB0/RSPCKA	Input/Output	RSPI0 clock pin
PC7/MISOA	Input	RSPI0 MISO pin
PA6/MOSIA	Output	RSPI0 MOSI pin
PC4/TSCAP	-	TSCAP pin
P30/TS2	Input	Electrostatic capacitance measurement pin
P27/TS3	Input	Electrostatic capacitance measurement pin
P26/TS4	Input	Electrostatic capacitance measurement pin
P15/TS5	Input	Electrostatic capacitance measurement pin
PC6/TS14	Input	Electrostatic capacitance measurement pin
PC5/TS15	Input	Electrostatic capacitance measurement pin
PC3/TS16	Input	Electrostatic capacitance measurement pin
PB5/TS20	Input	Electrostatic capacitance measurement pin
P40 ~ P45	Output	LED pin
PB3/MTIO0A	Output	Buzzer pin

3.4 Sample Program Structure

3.4.1 Peripheral Functions Used

The following shows lists peripheral functions used in this sample program.

Table 3-2 List of Peripheral Functions Used and Functions

Peripheral Functions	Function
RSPI0	SPI Communication with LCD
DTC	Used for measure CTSU2SL during snooze mode and RAM to RSPI transfer
ELC	Used for measure CTSU2SL during software standby mode
CTSU2SL	Used for with touch buttons and touch slider
CMT0	Used for inside emWin FIT
CMT2	Used for measure CTSU2SL during normal operation mode
LPT	Used for ELC triggering
PORT	Used for LED
MTU2a	Used for buzzer

3.4.2 Components Used

The following shows lists components used in this sample program.

Table 3-3 List of Components Used

Components	Abbreviation	Version
Board Support Package	r_bsp	7.21
Byte-based circular buffer library	r_byteq	2.10
CMT driver	r_cmt_rx	5.40
Control Low Power States	r_lpc_rx	2.10
CTSU QE API	r_ctsu_qe	2.20
DTC driver	r_dtc_rx	4.21
ELC Driver	r_elc_rx	2.01
GPIO Driver	r_gpio_rx	4.70
Graphic Library with Graphical User Interface	r_emwin_rx	6.32.a.1.00
Low-Power Timer Driver	r_lpt_rx	3.01
PWM Mode Timer	Config_MTU0	1.12.0
RSPI Driver	r_rsipi_rx	3.04
Touch QE API	rm_touch_qe	2.20
Port	Config_PORT	2.4.1

3.4.3 Peripheral Function Settings

The Smart Configurator settings used in this sample program are shown below. The items and settings in each table in the Smart Configurator settings are described in the notation on the configuration screen.

Settings not listed are assumed to be default settings.

Table 3-4 Parameters of Smart Configurator (1/3)

Category	Item	Setting/Description
Smart Configurator >> Clock		The following settings are made on the "Clocks" Tab.
	VCC	3.3 (V)
	Main clock	Stopped: Unchecked.
	HOCO clock	Operation: Checked. HOCO oscillation enabled after reset
	LOCO clock	Stopped: Unchecked.
	IWDT dedicated clock	Operation: Checked. Frequency: 15 (kHz)
	System clock	Clock source: HOCO Flash IF clock (FCLK): 48MHz System clock (ICLK): 48MHz Peripheral module clock (PCLKB): 24MHz Peripheral module clock (PCLKD): 48MHz CLKOUT pin: Unchecked. Low power timer clock (LPTCLK): 15kHz
Smart Configurator >> System		Debugging interfaces setting: FINE
Smart Configurator >> Components >> r_bsp		Other than the changes listed below, default settings are used.
	Heap size	0x4000
	Software Interrupt Unit1 (SWINT1)	Used
	Software Interrupt Task Buffer Number	8
	Initial value of the software interrupt priority	Priority level 1
Smart Configurator >> Components >> r_dtc_rx		Other than the changes listed below, default settings are used.
	DMAC FIT check	DMAC FIT modules is not used with DTC FIT module.
Smart Configurator >> Components >> r_elc_rx		Default settings are used.
Smart Configurator >> Components >> r_ctsu_qe		Other than the changes listed below, default settings are used.
	Data transfer of INTCTSUWR and INTCTSURD	DTC
	Select automatic judgement code	Enable
	TSCAP pin	Use: Checked.
	TS2 pin	Use: Checked.
	TS3 pin	Use: Checked.
	TS4 pin	Use: Checked.
	TS5 pin	Use: Checked.
	TS14 pin	Use: Checked.
	TS15 pin	Use: Checked.
	TS16 pin	Use: Checked.
Smart Configurator >> Components >> r_gpio_rx		Default settings are used.
Smart Configurator >> Components >> r_lpc_rx		Default settings are used.

Table 3-5 Parameters of Smart Configurator (2/3)

Category	Item	Setting/Description
Smart Configurator >> Components >> r_rsipi_rx		Other than the changes listed below, default settings are used.
	Dummy data of reception	0x00
	RSPI channel 0	Used
	RSPI channel 1	Unused
	RSPI channel 2	Unused
	Interrupt priority level of RSPI channel 0	Level 3
	RSPI0	Checked
	RSPCKA pin	Use: Checked.
	MOSIA pin	Use: Checked.
	MISOA pin	Use: Checked.
Smart Configurator >> Components >> r_cmt_rx		Default settings are used.
Smart Configurator >> Components >> r_lpt_rx		Other than the changes listed below, default settings are used.
	LPT clock source	IWDT-dedicated on-chip oscillator
Smart Configurator >> Components >> rm_touch_qe		Default settings are used.
Smart Configurator >> Components >> r_byteq		Default settings are used.
Smart Configurator >> Components >> r_emwin_rx		Other than the changes listed below, default settings are used.
	Configurations >> BasicSetting	
	Work area size for GUI	6000
	Horizontal LCD size	240
	Vertical LCD size	320
	Color depth	16 bit per pixel
	LCD orientation	ORIENTATION_CCW
	Select DMA transfer modules	DTC
	Configurations >> Select LCD Interface	
	LCD interface	LCD_IF_RSPI
	Configurations >> Select LCD Interface >> SPI Interface Setting	
	LCD interface channel number	0
	Select LCD Driver IC	LCD_DRV_IC_ILI9341
	Communication baud rate of LCD interface	12000000
	Use or unused display cache	Unuse: Unchecked
	Configurations >> Select LCD Interface >> LCD Interface Pin Setting	
	Use Display Signal Pin	Use Display Signal Pin
	Display Signal Pin	GPIO_PORT_A_PIN_1
	Use Backlight Pin	Use Backlight Pin
	Backlight Pin	GPIO_PORT_E_PIN_0
	Use Data/Command Pin	Use Data/Command Pin
	Data/Command Pin	GPIO_PORT_A_PIN_0
	Use Chip Select Pin	Use Chip Select Pin
	Chip Select Pin	GPIO_PORT_4_PIN_7
	Configurations >> Select Touch Interface	
	Use Touch function	Not use Touch function: Unchecked

Table 3-6 Parameters of Smart Configurator (3/3)

Category	Item	Setting/Description
Smart Configurator >> Components >> Config_PORT		Other than the changes listed below, default settings are used.
	PORT4	Checked.
	P40	Output: Checked
	P41	Output: Checked
	P42	Output: Checked
	P43	Output: Checked
	P44	Output: Checked
	P45	Output: Checked
Smart Configurator >> Components >> Config_MTU0		Other than the changes listed below, default settings are used.
	Counter clear source	TGRB0 compare match
	MTIOC0A pin	Output initial 0, 1 at compare match
	TGRA initial value	38
	TGRB initial value	188

3.4.4 File Structure

The following shows file structure by sample program.

Table 3-7 File Structure

Folder name, File name	Outline
Src	Folder for program source
└ main.c	Source file for main processing
└ main.h	Header file for main processing
└ LCD_custom_func.c	Source file for LCD related
└ LCD_custom_func.h	Header file for LCD related
└ r_low_power_control.c	Source file for operation mode control related
└ r_low_power_control.h	Header file for operation mode control related
└ touch_func.c	Source file for touch related
└ touch_func.h	Header file for touch related
└ Resource	Folder for image and font
└ smc_gen	Smart Configurator generation
└ Config_MTU0	
└ Config_PORT	
└ r_byteq	
└ r_cmt_rx	
└ r_ctsu_qe	
└ r_dtc_rx	
└ r_elc_rx	
└ r_emwin_rx	
└ r_gpio_rx	
└ r_lpc_rx	
└ r_lpt_rx	
└ r_rspi_rx	
└ rm_touch_qe	
└ general	
└ r_bsp	
└ r_config	
└ r_pincfg	
qe_gen	QE-Touch generation
QE-Touch	

3.4.5 Variables

The following shows the variables that are used in this sample program.

Table 3-8 List of variables used in the sample code

Variable name	Type	Contents
g_normal_mode_flg	uint8_t	The Normal operation mode flag
g_touch_timer_flg	uint8_t	The touch judgement start flag in normal operation mode
g_lcd_left_slide_flg	uint8_t	The touch slider slid to the left flag
g_lcd_push_home_flg	uint8_t	Flag indicating that "home" button is touched
g_lcd_push_select_flg	uint8_t	Flag indicating that "select" button is touched
g_lcd_push_start_flg	uint8_t	Flag indicating that "start" button is touched
s_flg_touch	uint8_t	Touch buttons status
s_mode_num	uint8_t	Mode status
s_setting_target	uint8_t	Flags indicating screen status
s_screen_en_flg	uint8_t	Flag indicating initial screen status
s_startup_cnt	uint8_t	Counter for initial screen display time management

3.4.6 Constants

The following shows the constants that are used in this sample program.

Table 3-9 List of constants used in the sample code

Constant Name	Setting Value	Contents
TOUCH_NO	(0U)	Value at no-operation
TOUCH_LEFT_SLIDE	(4U)	Value indicating that touch slider is slid to the left
TOUCH_RIGHT_SLIDE	(3U)	Value indicating that touch slider is slid to the right
TOUCH_SELECT	(1U)	Value indicating that "select" button was touched
TOUCH_HOME	(2U)	Value at moving to the previous screen
MODE_MENU	(0U)	Value of mode not selected
MODE_RECIPE_DETAIL	(6U)	Value of detail setting in Recipe mode
MODE_COOK_DETAIL	(3U)	Value of detail setting in Cook mode
MODE_DEFROST_DETAIL	(4U)	Value of detail setting in Defrost mode
MODE_COOK	(1U)	Value of start cooking in Cook mode
MODE_DEFROST	(2U)	Value of start cooking in Defrost mode
MODE_RECIPE	(5U)	Value of start cooking in Recipe mode
TOUCH_START	(5U)	Value of execution in each mode
SETTING_TOP	(0U)	Value of initial screen
LED_HOME	(PORT4.PODR.BIT.B0)	P40
LED_SELECT	(PORT4.PODR.BIT.B1)	P41
LED_START	(PORT4.PODR.BIT.B2)	P42
LED_MINUS	(PORT4.PODR.BIT.B3)	P43
LED_BAR	(PORT4.PODR.BIT.B4)	P44
LED_PLUS	(PORT4.PODR.BIT.B5)	P45
LED_ON	(1U)	Value of LED turning on
LED_OFF	(0U)	Value of LED turning off
STARTUP_COUNT	(STARTUP_TIME * CMT_FREQ)	Initial screen display time (Count)

3.4.7 Functions

The following shows the functions that are used in this sample program.

Table 3-10 List of functions used in the sample code

Function name	Outline
Main	Main process
init_low_power_control	CTSU2SL for low-power measurement initial settings
GUI_Init	Initializing emWin
R_CMT_CreatePeriodic	CMT counting start
show_startup_screen	Processing of startup screen display
wait_5sec_once	Processing of 5 seconds wait
base_line_setting_method1	CTSU2SL baseline settings
enter_standby_mode	Software standby mode transition
enter_normal_mode	Normal operation mode transition
check_state_normal_mode	Touch judgement in normal operation mode
screen_init	Processing of screen initialization
change_screen	LCD screen update
init_peripheral_function	Processing of peripheral function initialization
init_offset_tuning	Processing of offset initialization for tuning
led_sleep_on	Set LED pattern to sleep
touch_judge	Touch judgement
mode_select_resume	Processing of menu display resumption
slide_func	Processing at touch slider operation
select_pushed_func	Processing when "2" button is touched
home_pushed_func	Processing when "1" button is touched
start_pushed_func	Processing when "2" button is touched
led_control	Processing of LED control
offset_tuning_method1	Processing of offset 1 for tuning
offset_tuning_method2	Processing of offset 2 for tuning
set_icons	Processing of screen display for each mode
mode_change_menu	Move to the menu screen
mode_change_cook	Move to Cook mode
mode_change_defrost	Move to Defrost mode
mode_change_recipe	Move to Recipe mode
slide_icons	Processing of cursor movement on menu screens and mode selection screens for Cook, Defrost and Recipe
setting_cook	Setting the number of watts and seconds in Cook mode
setting_defrost	Setting the level of defrosting and the number of grams in Defrost mode
setting_recipe	Setting the number of cupcakes in Recipe mode
mode_select_enter	Change the mode and display the LCD screen according to the mode
change_target_cook	Change the setting target of the detail setting screen in Cook mode
change_target_defrost	Change the setting target of the detail setting screen in Defrost mode
start_cook	Start cooking in Cook mode
start_defrost	Start defrosting in Defrost mode
start_recipe	Start cooking in Recipe mode
start_cook_detail	Start of detail setting in Cook mode
start_defrost_detail	Start of detail setting in Defrost mode
start_recipe_detail	Start of detail setting in Recipe mode
control_led_home()	Processing LED lighting when "home" button is touched
control_led_select()	Processing LED lighting when "select" button is touched
control_led_p_m()	Processing LED lighting when using the touch slider

3.4.8 Function Specifications

The following shows function specifications that are used in this sample program.

[Function name] main

Outline	Main process
Header	None
Declaration	void main (void)
Description	Initializes peripheral functions and controls touch keys and LCD.
Arguments	None
Return value	None
Remarks	None

[Function name] init_low_power_control

Outline	CTS2SL for low-power measurement initial settings
Header	r_low_power_control.h
Declaration	void init_low_power_control (void)
Description	CTS2SL for low-power measurement initial settings.
Arguments	None
Return value	None
Remarks	None

[Function name] GUI_Init

Outline	Initializing emWin
Header	GUI.h
Declaration	void GUI_Init (void)
Description	Initializes emWin internal data structures and variables.
Arguments	None
Return value	None
Remarks	None

[Function name] show_startup_screen

Outline	Processing of startup screen display
Header	R_low_power_control.h
Declaration	void show_startup_screen (void)
Description	Performs startup screen display.
Arguments	None
Return value	None
Remarks	None

[Function name] base_line_setting_method1

Outline	CTS2SL baseline settings
Header	r_low_power_control.h
Declaration	void base_line_setting_method1 (void)
Description	CTS2SL baseline settings.
Arguments	None
Return value	None
Remarks	None

 [Function name] enter_standby_mode

Outline	Software standby mode transition
Header	r_low_power_control.h
Declaration	void enter_standby_mode (void)
Description	Turn off LCD panel backlight and transition to software standby mode.
Arguments	None
Return value	None
Remarks	None

 [Function name] enter_normal_mode

Outline	Normal operation mode transition
Header	r_low_power_control.h
Declaration	void enter_normal_mode (void)
Description	Turn on LCD panel backlight and transition to normal operation mode.
Arguments	None
Return value	None
Remarks	None

 [Function name] check_state_normal_mode

Outline	Touch judgement in normal operation mode
Header	r_low_power_control.h
Declaration	void check_state_normal_mode (void)
Description	Performs touch judgement in normal operation mode.
Arguments	None
Return value	None
Remarks	None

 [Function name] screen_init

Outline	Processing of screen initialization
Header	LCD_custom_func.h
Declaration	void screen_init (void)
Description	Performs screen initialization.
Arguments	None
Return value	None
Remarks	None

 [Function name] change_screen

Outline	LCD screen update
Header	LCD_custom_func.h
Declaration	void change_screen (void)
Description	Updates the LCD screen by touch operation.
Arguments	None
Return value	None
Remarks	None

[Function name] led_sleep_on

Outline Set LED pattern to sleep
Header LCD_custom_func.h
Declaration void led_sleep_on (void)
Description Sets LED pattern to sleep
Arguments None
Return value None
Remarks None

[Function name] touch_judge

Outline Touch judgement
Header touch_func.h
Declaration void touch_judge (uint64_t button_status, uint16_t slider_position)
Description Performs touch judgement and sets the judgement result to a flag.
Arguments button_status, slider_position
Return value None
Remarks None

3.4.9 ROM/RAM usage

ROM/RAM usage for this sample program is shown below.

Table 3-11 ROM usage

Size (KByte)	description
63	LCD Graphic data
112	emWin, LCD control
16	Touch (sleep)
17	demo program
27	Other
Total 235Kbyte	MAX 256Kbyte (91.7% Used)

Table 3-12 RAM usage

Size (KByte)	Description
25	bitmap work area
16	heap area
6	emWin work area
8	Other
Total 55KByte	MAX 64KByte (86% Used)

4. Importing a Project

The sample programs are distributed in e² studio project format. This section shows how to import a project into e² studio or CS+. After importing a project, check the build and debug settings.

4.1 Procedure in e² studio

To use sample programs in e² studio, follow the steps below to import them into e² studio. In projects managed by e² studio, do not use space codes, multibyte characters, and symbols such as "\$", "#", "%" in folder names or paths to them.

(Note that depending on the version of e² studio you are using, the interface may appear somewhat different from the screenshots below.)

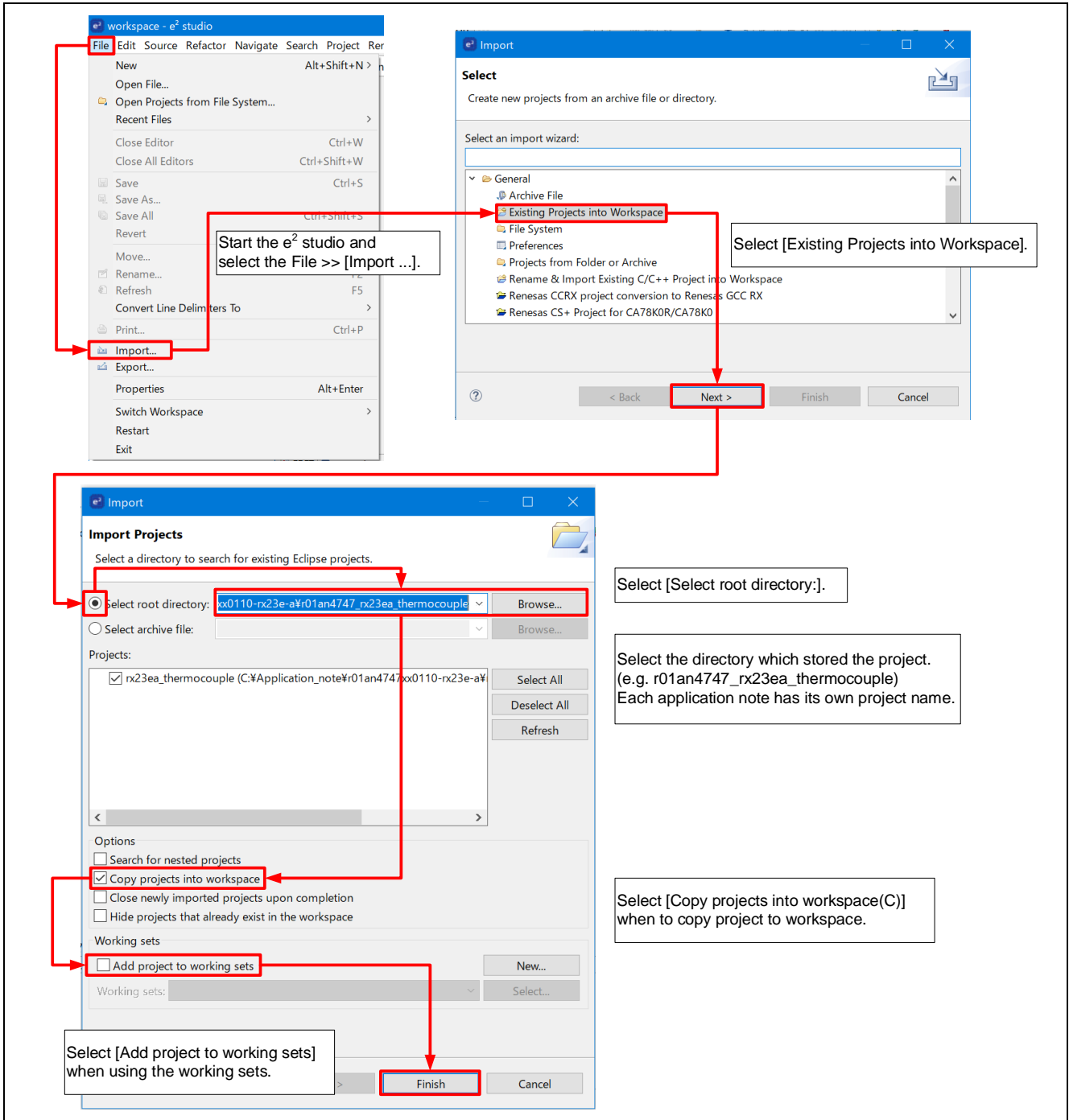

Figure 4-1 Import a Project into e² Studio

4.2 Procedure in CS+

To use sample programs in CS+, follow the steps below to import them into CS+. In projects managed by CS+, do not use space codes, multibyte characters, and symbols such as "\$", "#", "%" in folder names or paths to them.

(Note that depending on the version of CS+ you are using, the interface may appear somewhat different from the screenshots below.)

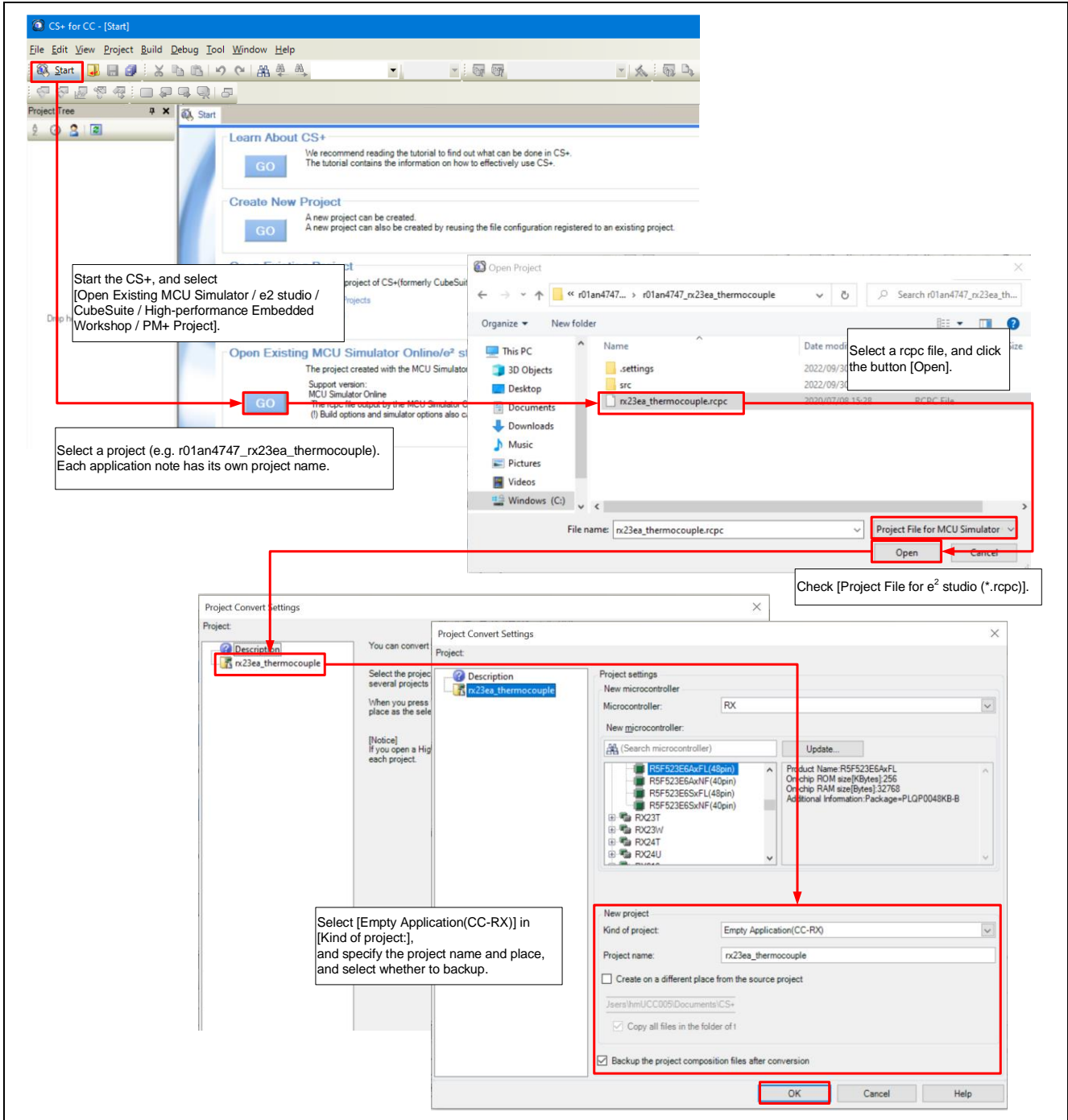

Figure 4-2 Import a Project into CS+

5. Start Demonstration

Disconnect the E2 Emulator Lite and turn on the RX140 PoC to start the demonstration program. This demonstration program assumes control of the display and settings of a microwave oven. Set the cooking conditions and recipe selections using the touch buttons and touch slider while checking the LCD.

Hereinafter, touch buttons are described as buttons and touch slider is described as slider.

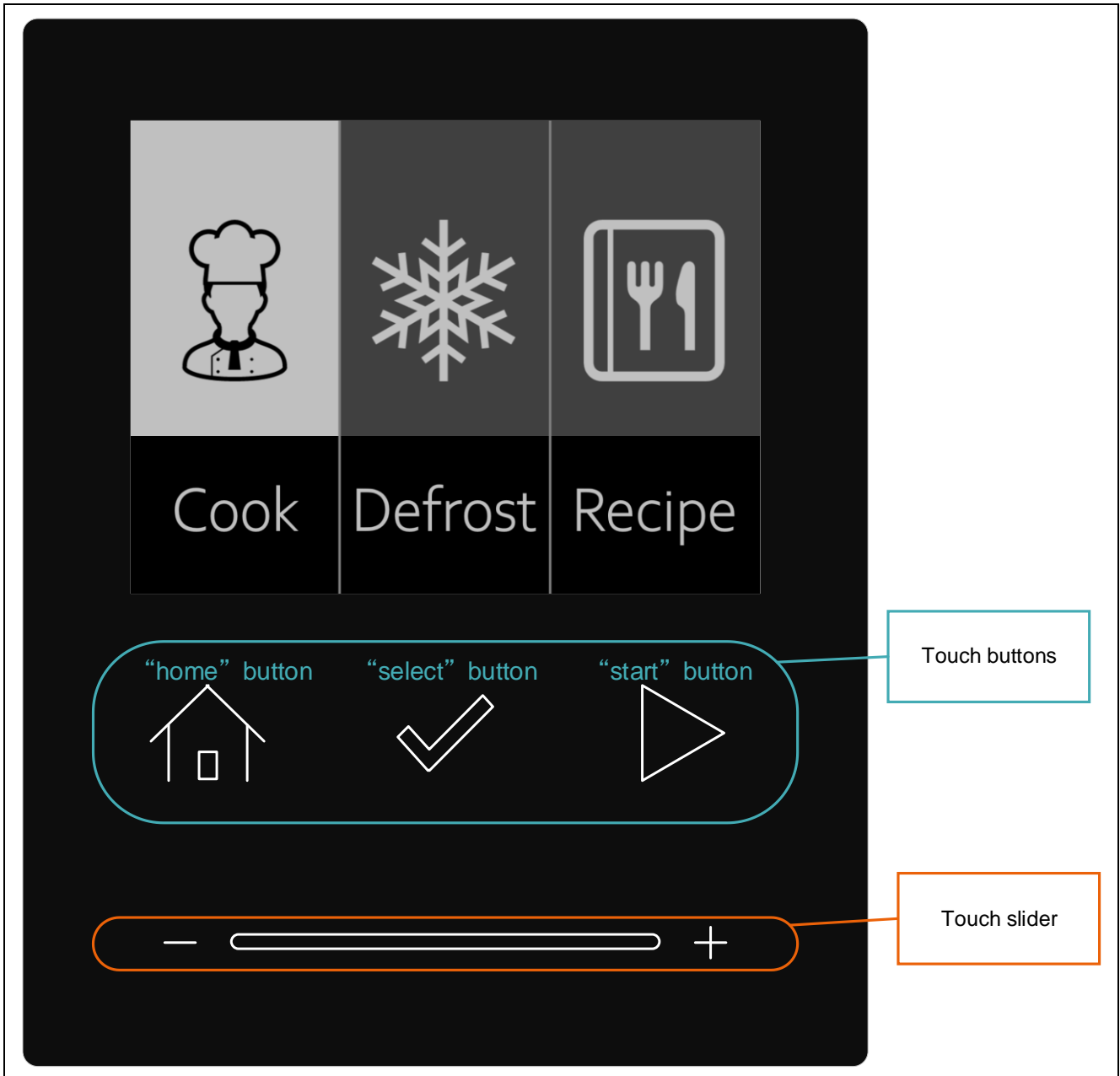

Figure 5-1 Demonstration screen and operation panel

5.1 Powered on RX140 PoC and menu screen

When RX140 PoC is powered on, the LCD panel displays the RX logo and RX140 features (initial screen) for approximately 5 seconds. When the display finishes, the sample program starts and becomes a menu screen.

And while the initial screen is displayed, can immediately move to the menu screen by touching any button.

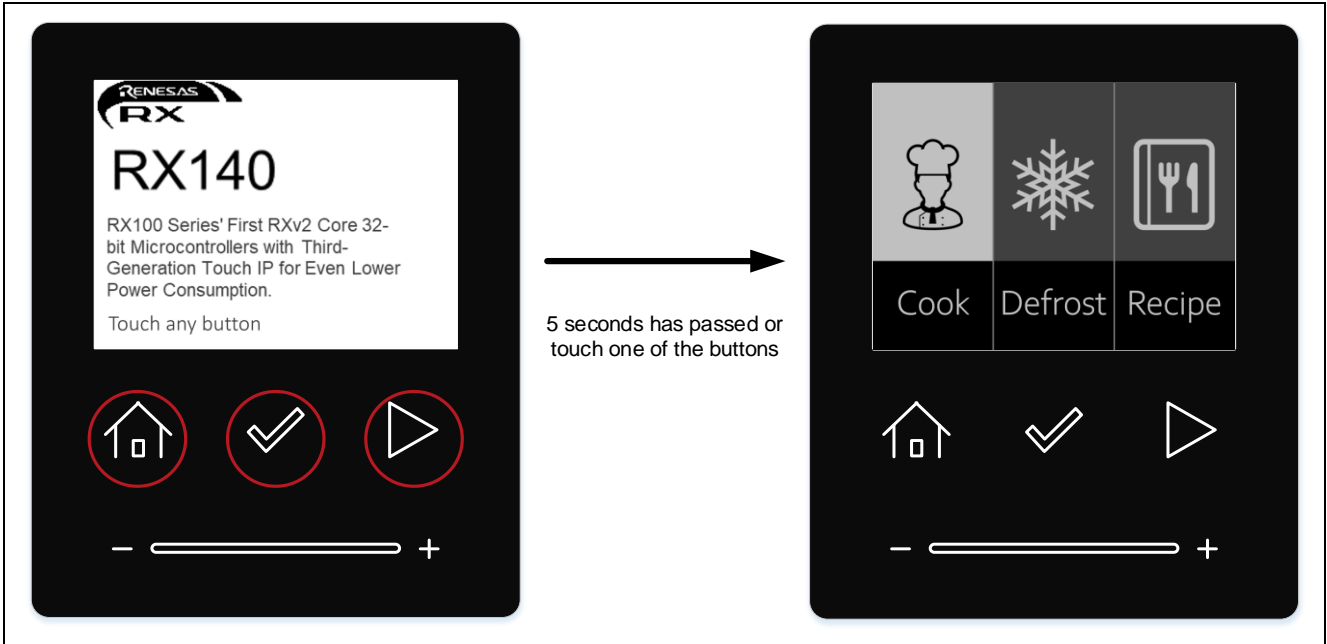

Figure 5-2 Start of the demonstration

5.2 Menu screen

"Cook", "Defrost" or "Recipe" can be selected with the slider operation on the menu screen.

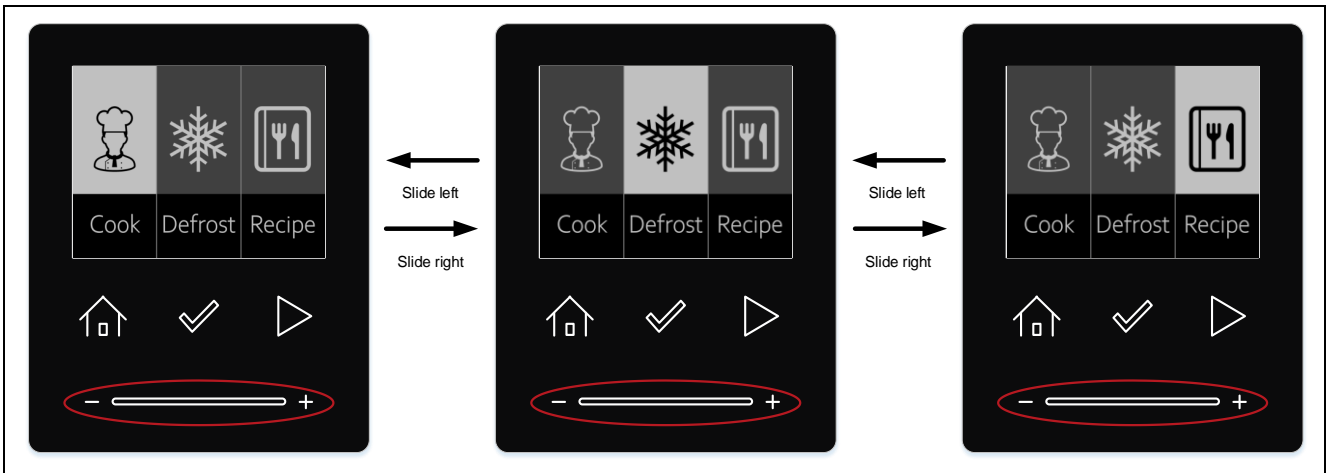

Figure 5-3 How to operate the menu screen

5.3 Cook setting

5.3.1 Move to mode selection screen

While "Cook" is selected on the menu screen, touching the "select" button can move to the Cook mode selection screen.

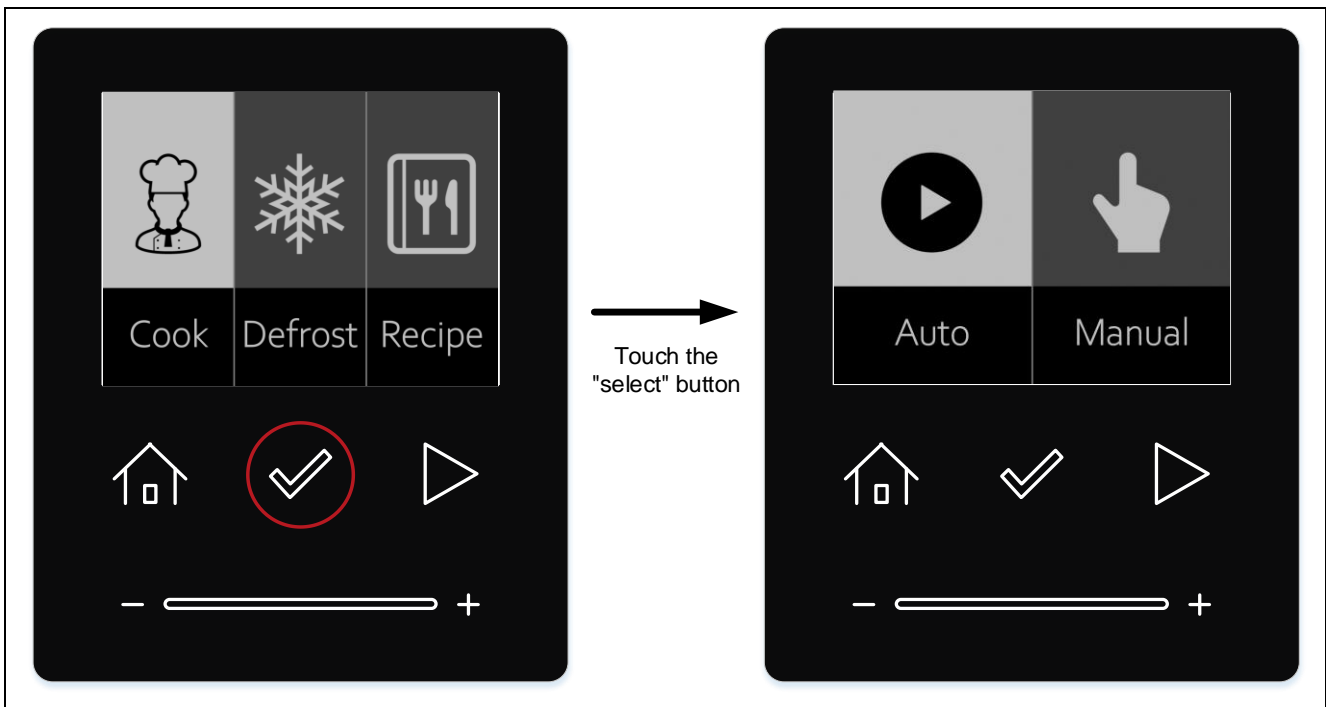

Figure 5-4 Move to the Cook mode selection screen

5.3.2 Select mode

While the Cook mode selection screen is displayed, "Auto" or "Manual" can be selected with the slider operation.

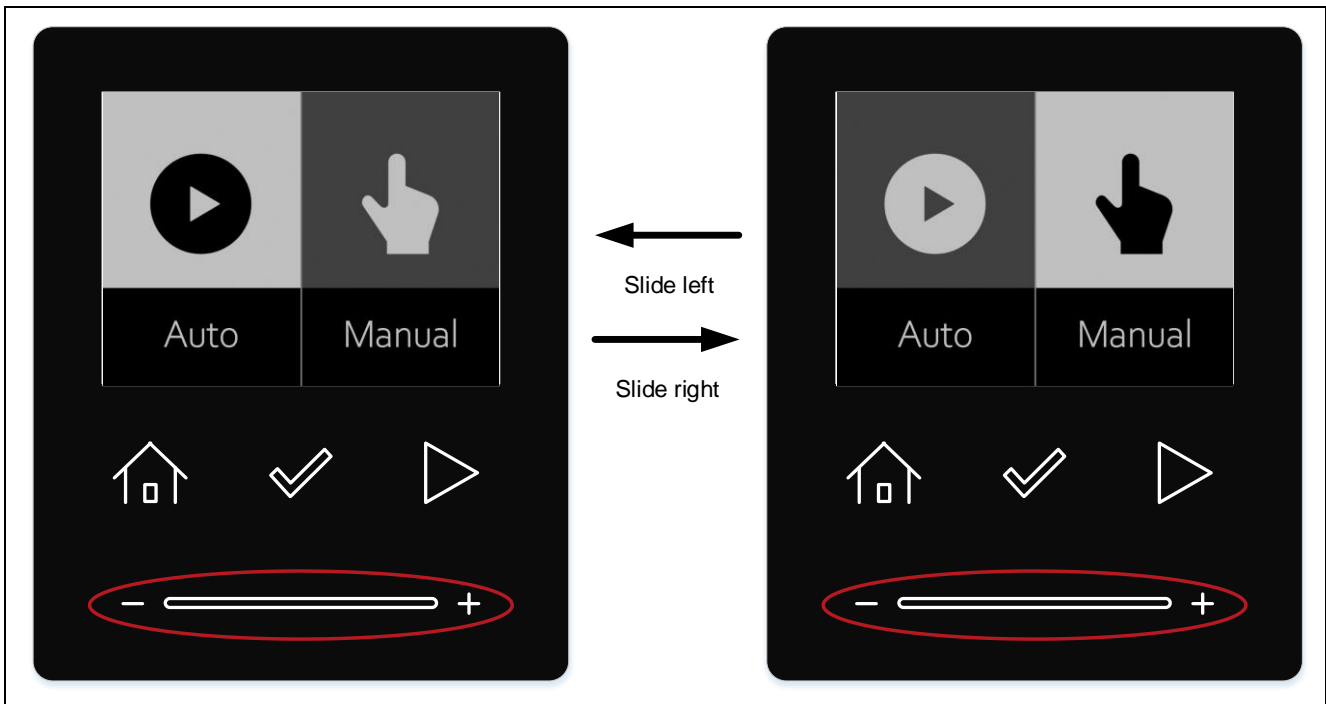

Figure 5-5 How to operate the Cook mode selection screen

5.3.3 Select Auto

While "Auto" is selected on the Cook mode selection screen, touching the "start" button can start cooking.

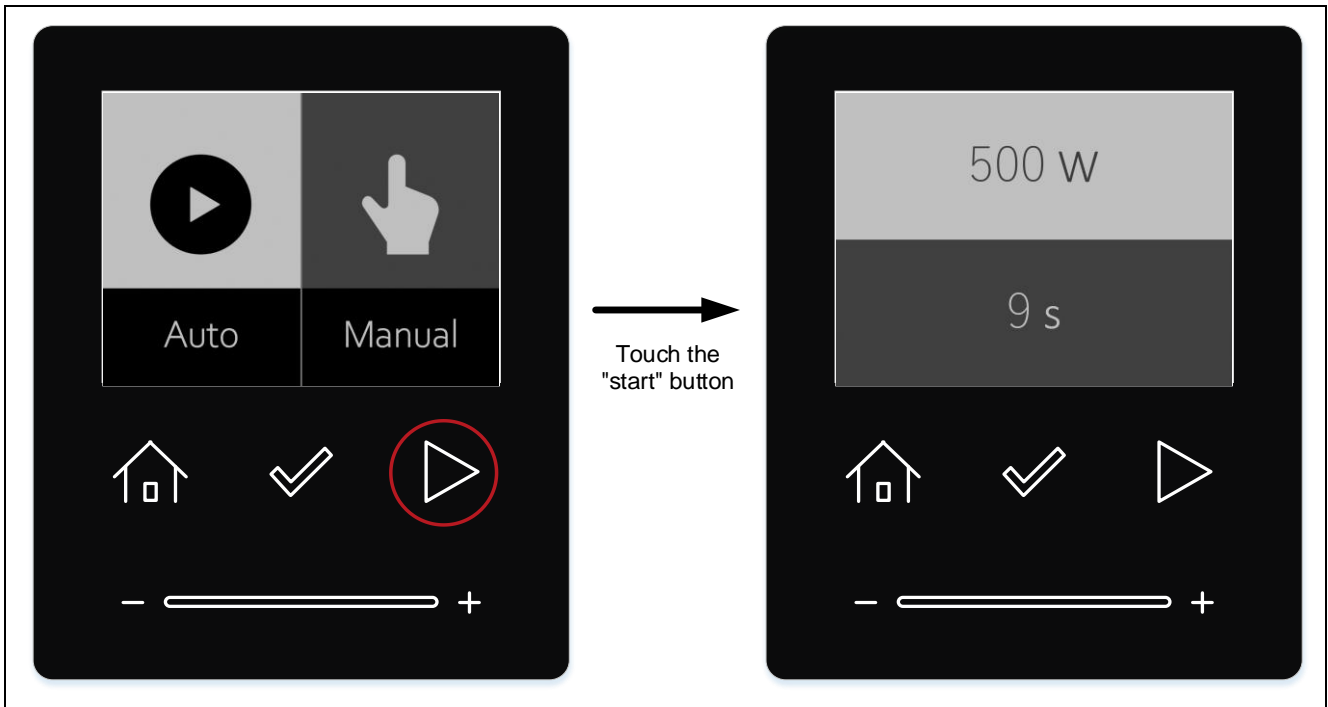

Figure 5-6 Start cooking in Auto mode

5.3.4 Select Manual

While "Manual" is selected on the Cook mode selection screen, touching the "select" button can move to the Cook detail setting screen.

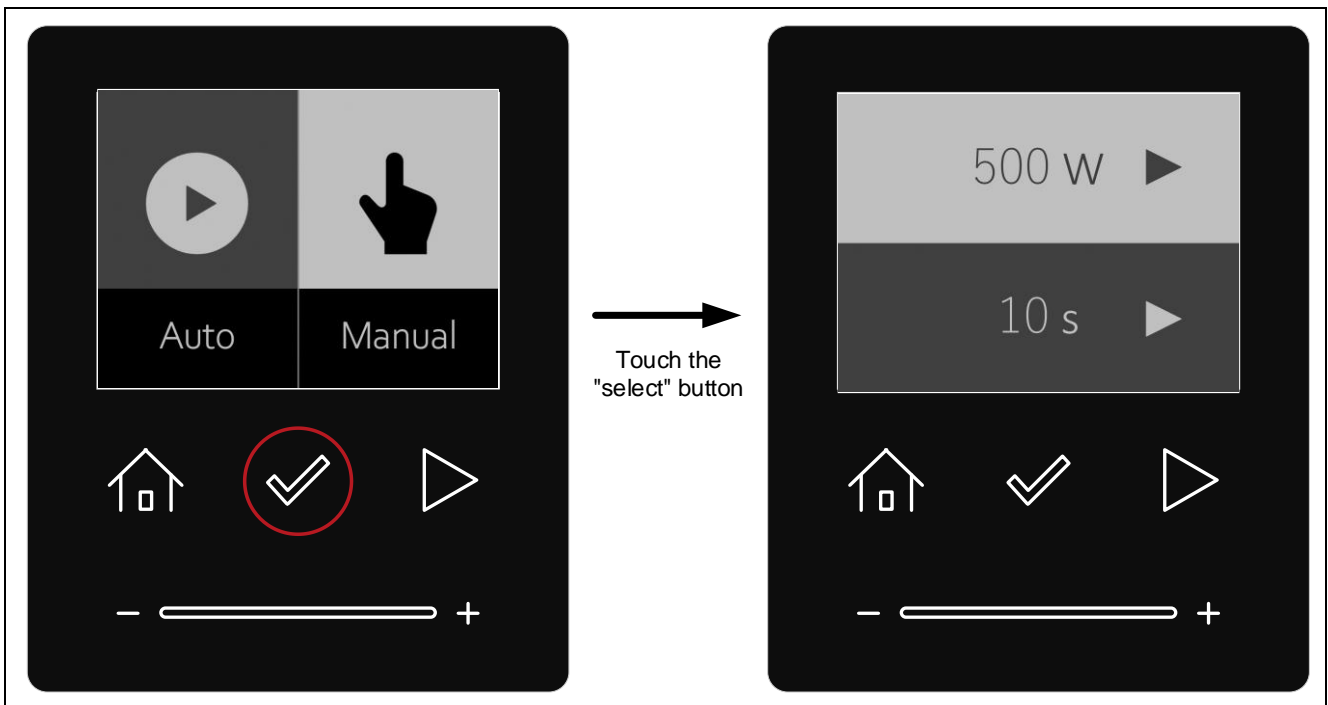

Figure 5-7 Move to the Cook detail setting screen

5.3.4.1 Set the number of watts

While the cursor is on the upper side, the number of watts can be set with the slider. "500W", "600W" and "700W" can be selected as the power level.

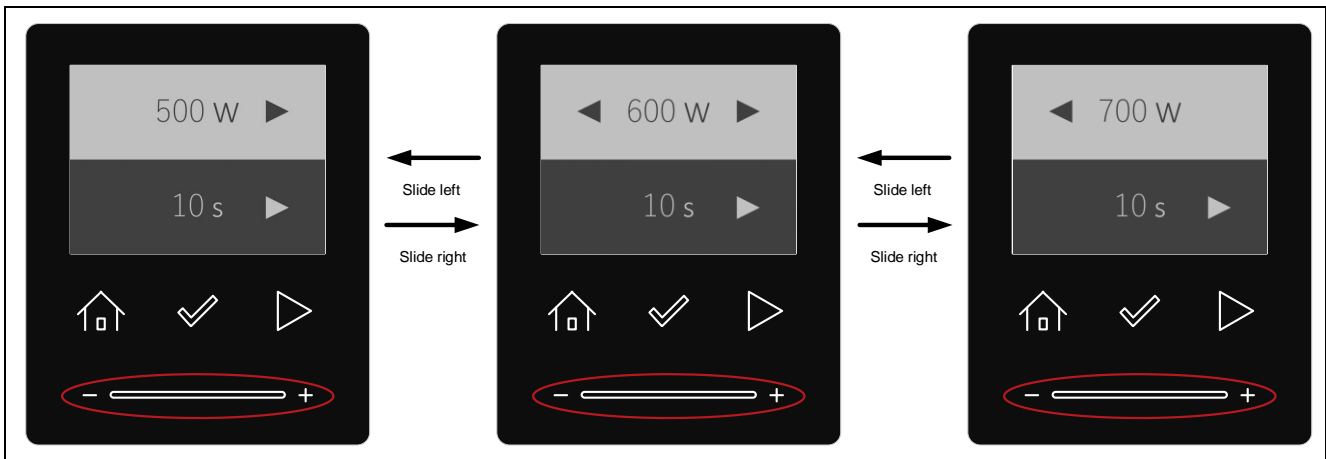

Figure 5-8 Setting the number of watts

5.3.4.2 Move the cursor

While the Cook detail setting screen is displayed, touching the "select" button can move the cursor. The item with a light-colored background is selected.

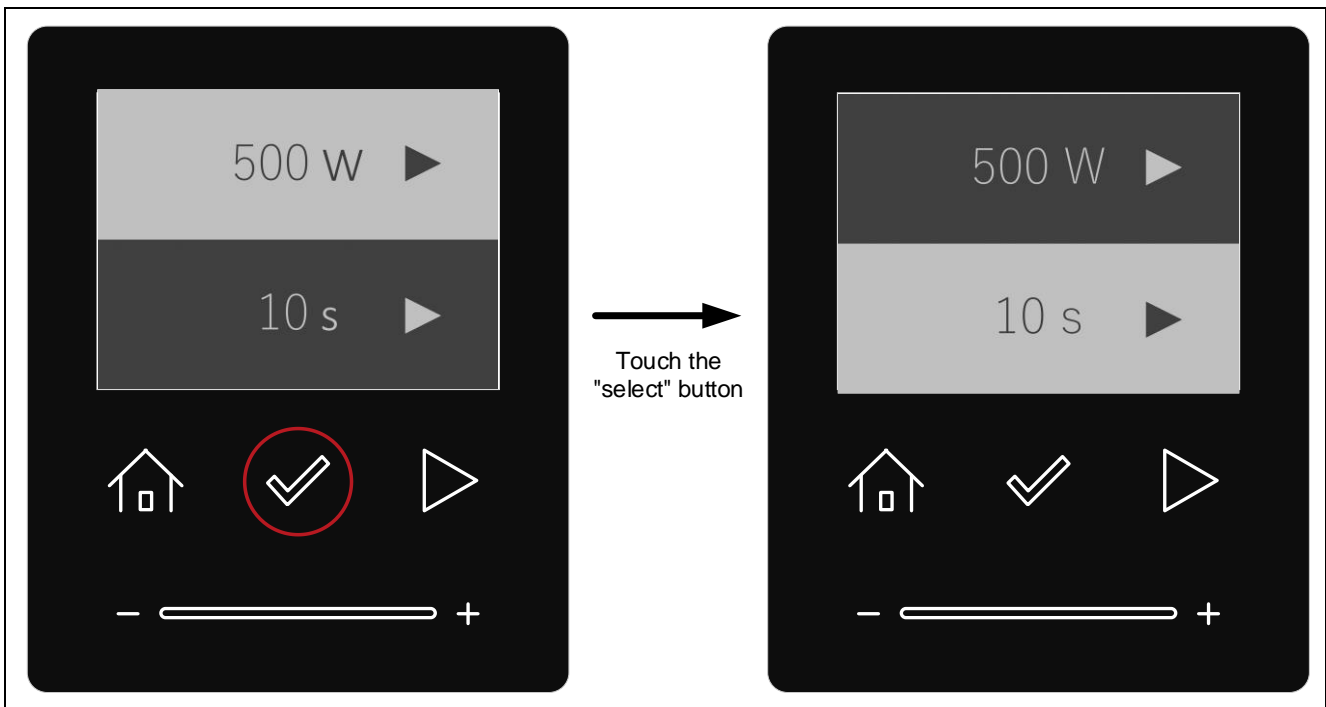

Figure 5-9 How to operate the cursor on the Cook detail setting screen

5.3.4.3 Set the number of seconds

While the cursor is on the lower side, the number of seconds can be set with the slider. "10s", "20s" and "30s", can be selected as the cooking time.

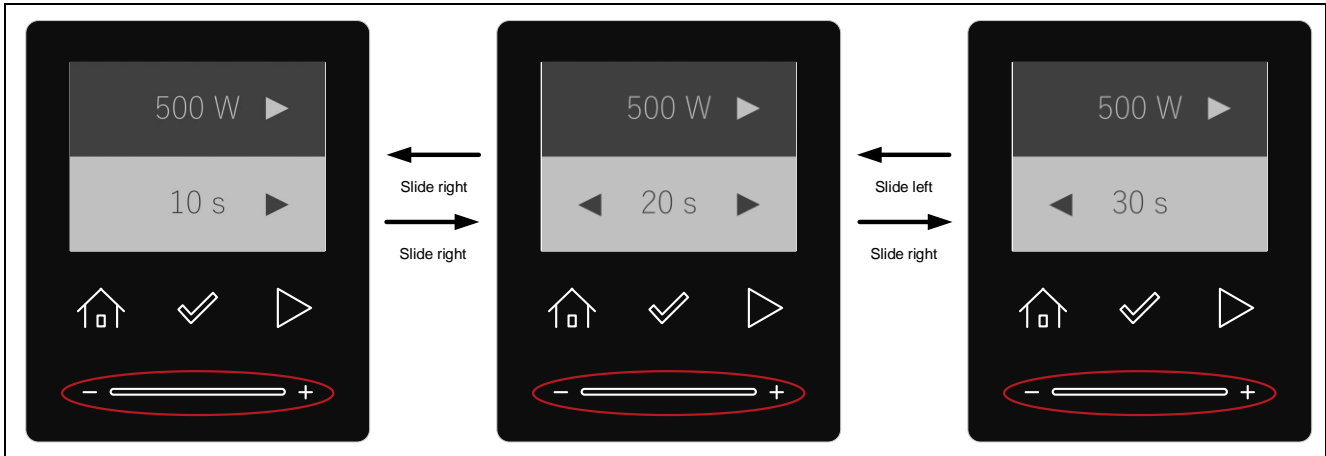

Figure 5-10 Setting the number of seconds

5.3.4.4 Start cooking

While the Cook detail setting screen is displayed and the cursor is on the lower side, touching the "start" button can start cooking.

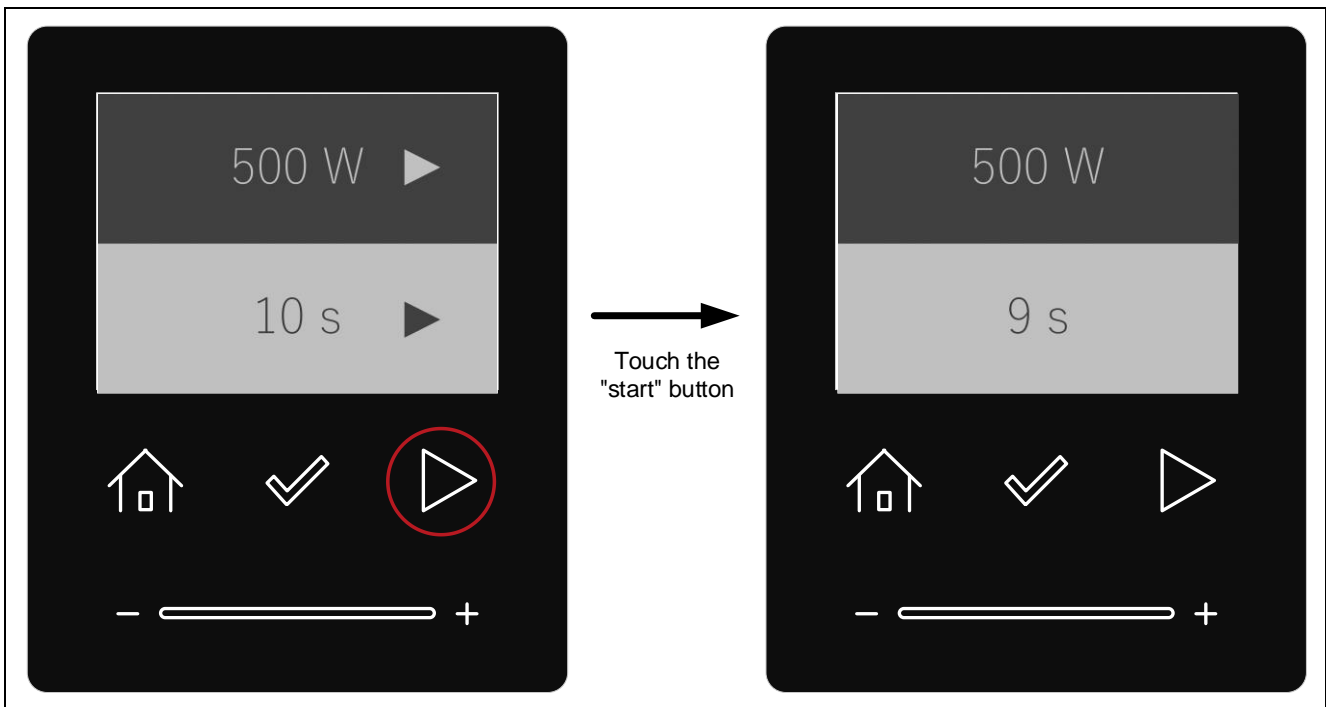

Figure 5-11 Start cooking in Manual mode

5.4 Defrost setting

5.4.1 Move to mode selection screen

While "Defrost" is selected on the menu screen, touching the "select" button can move to the Defrost mode selection screen.

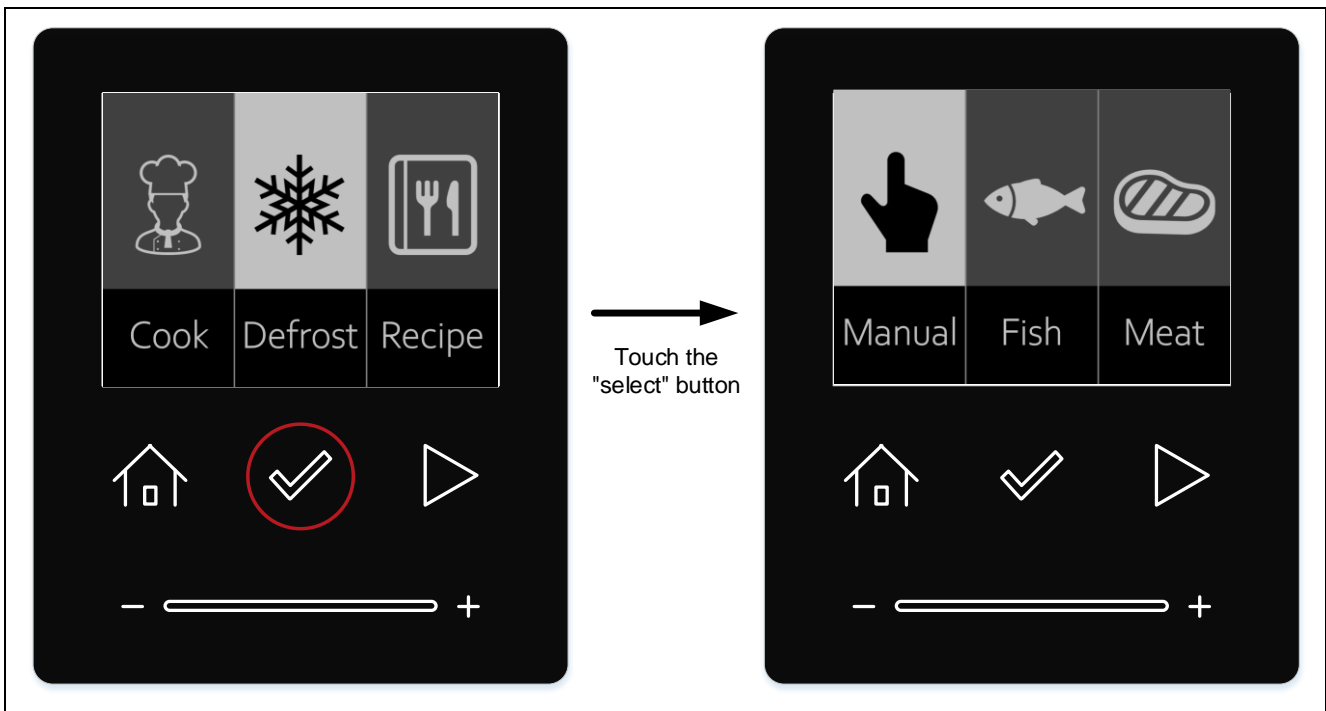

Figure 5-12 Move to the Defrost mode selection screen

5.4.2 Select mode

While the Defrost mode selection screen is displayed, "Manual", "Fish" or "Meat" can be selected with the slider operation.

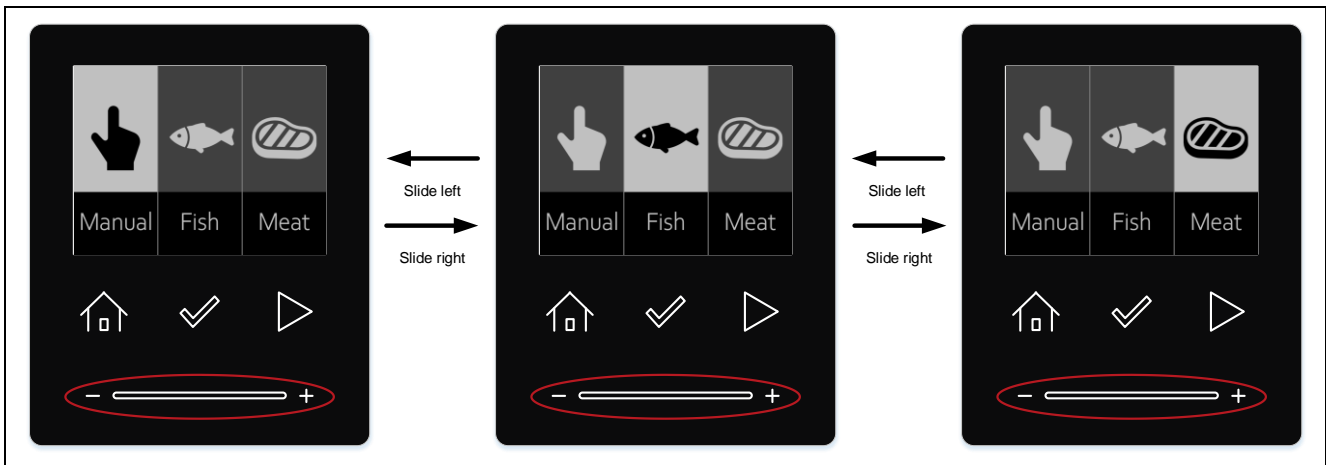

Figure 5-13 How to operate the Defrost mode selection screen

5.4.3 Select Manual

While "Manual" is selected on the Defrost mode selection screen, touching the "select" button can move to the Defrost detail setting screen.

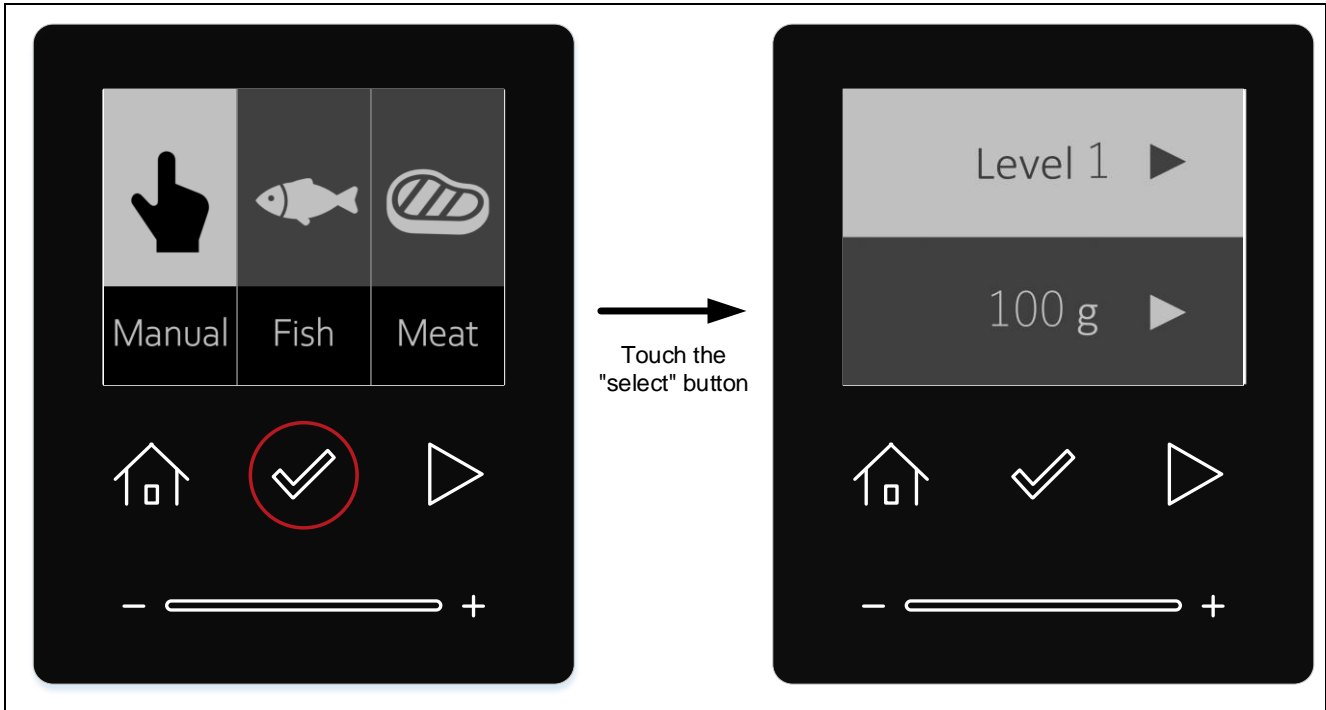

Figure 5-14 Move to the Defrost detail setting screen

5.4.3.1 Set the level of defrosting

While the cursor is on the upper side, the level of defrosting can be set with the slider. "Level1", "Level2" and "Level3" can be selected as the defrosting level.

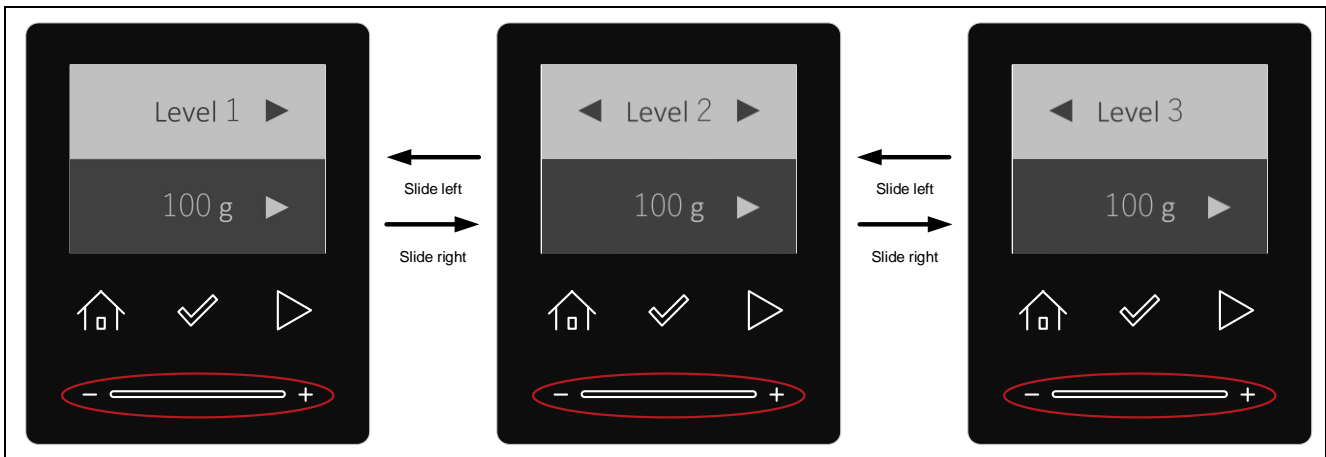

Figure 5-15 Setting the level of defrosting

5.4.3.2 Move the cursor

While the Defrost detail setting screen is displayed, touching the "select" button can move the cursor. The item with a light-colored background is selected.

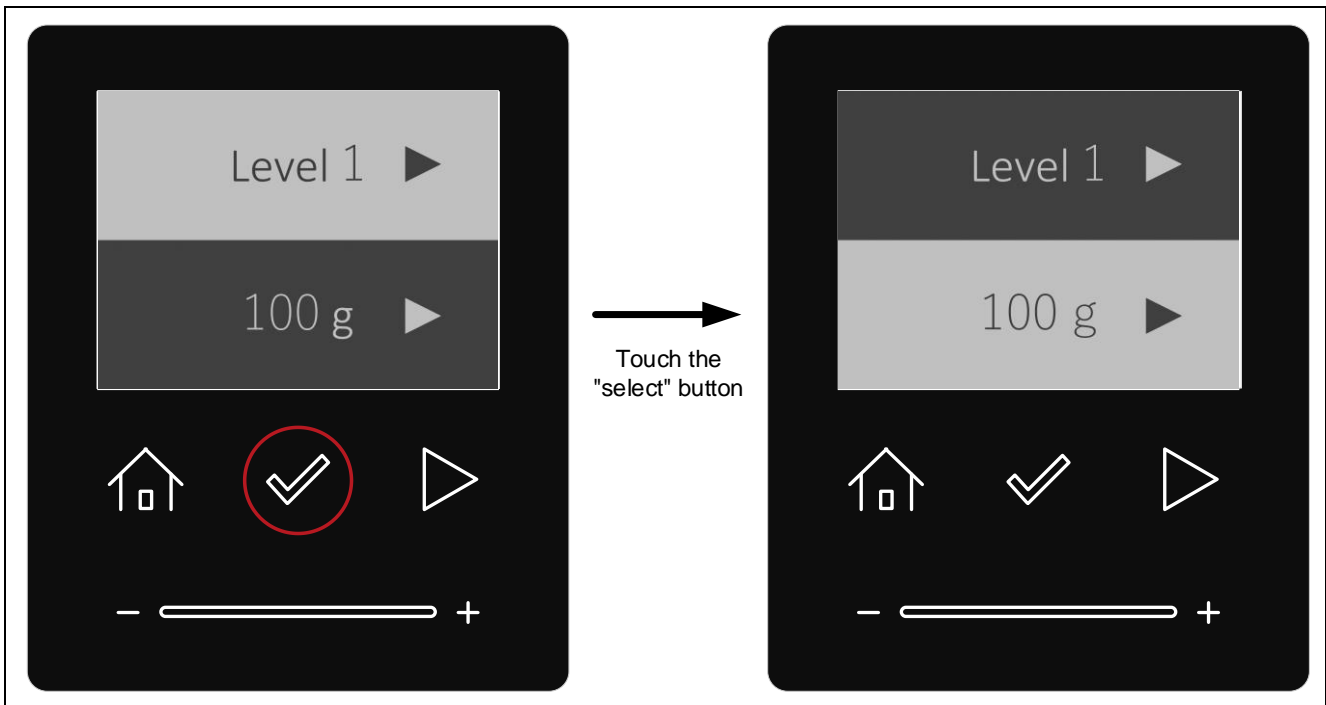

Figure 5-16 How to operate the cursor on the Defrost detail setting screen

5.4.3.3 Set the number of grams

While the cursor is on the lower side, the number of grams can be set with the slider. "100g", "200g" and "300g" can be selected as the defrosting amount.

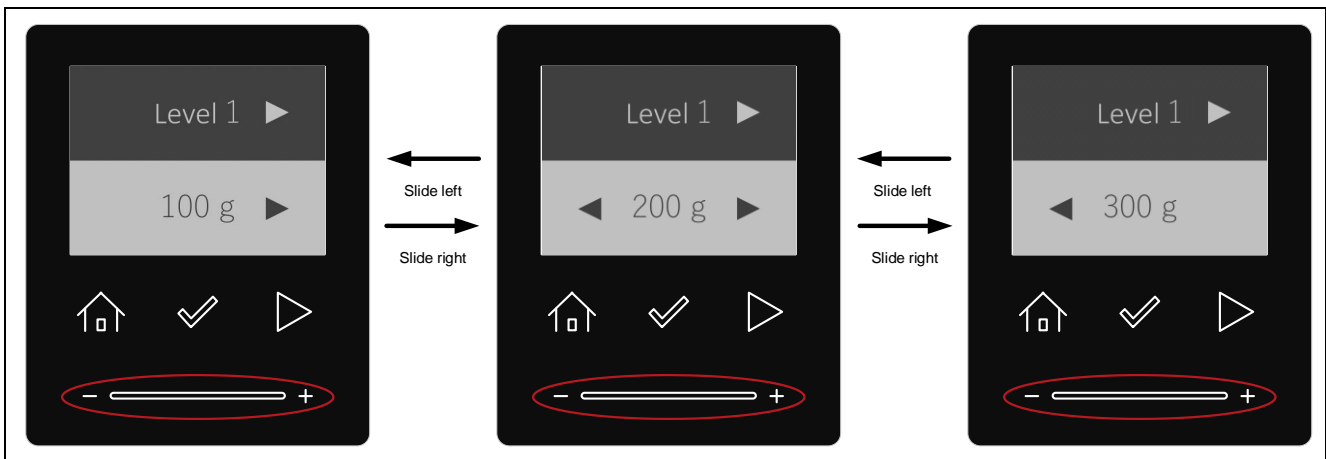

Figure 5-17 Setting the number of grams

5.4.3.4 Start defrosting

While the Defrost detail setting screen is displayed and the cursor is on the lower side, touching the "start" button can start defrosting.

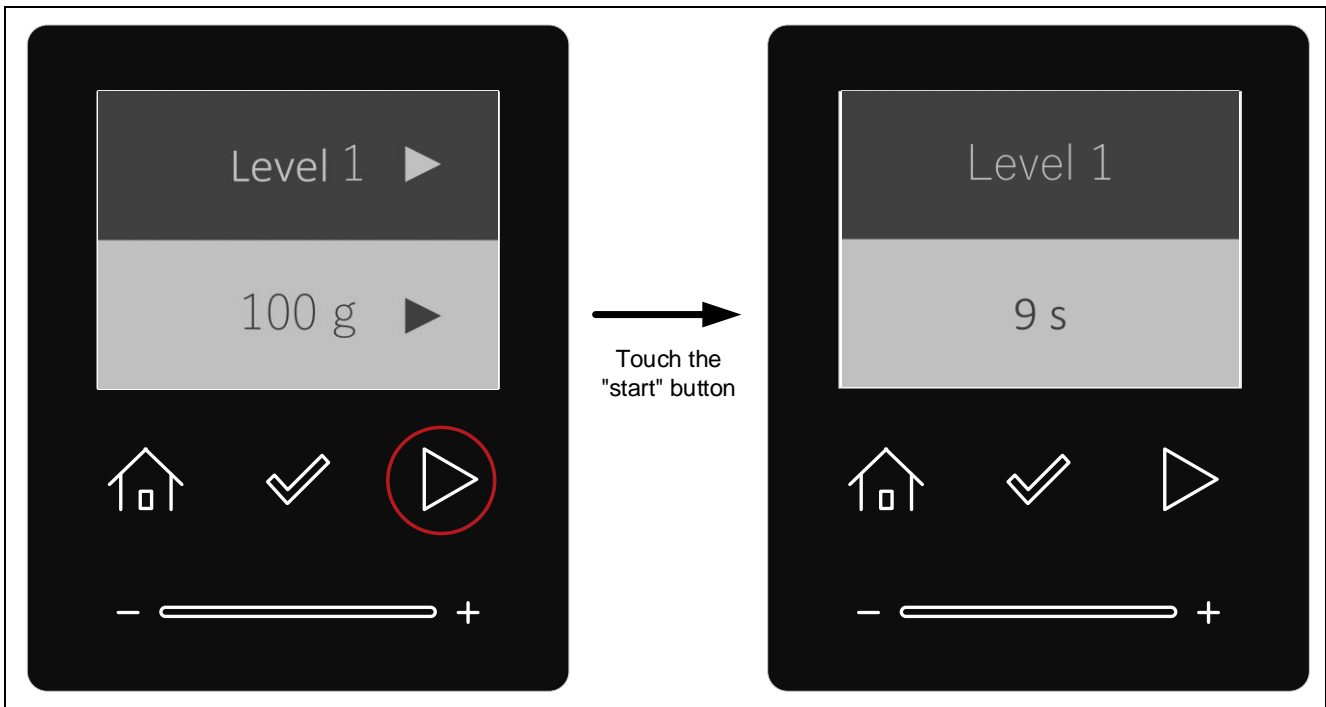

Figure 5-18 Start defrosting in Manual mode

5.4.4 Select Fish

While "Fish" is selected on the Defrost mode selection screen, touching the "start" button can start defrosting with the settings for "Fish".

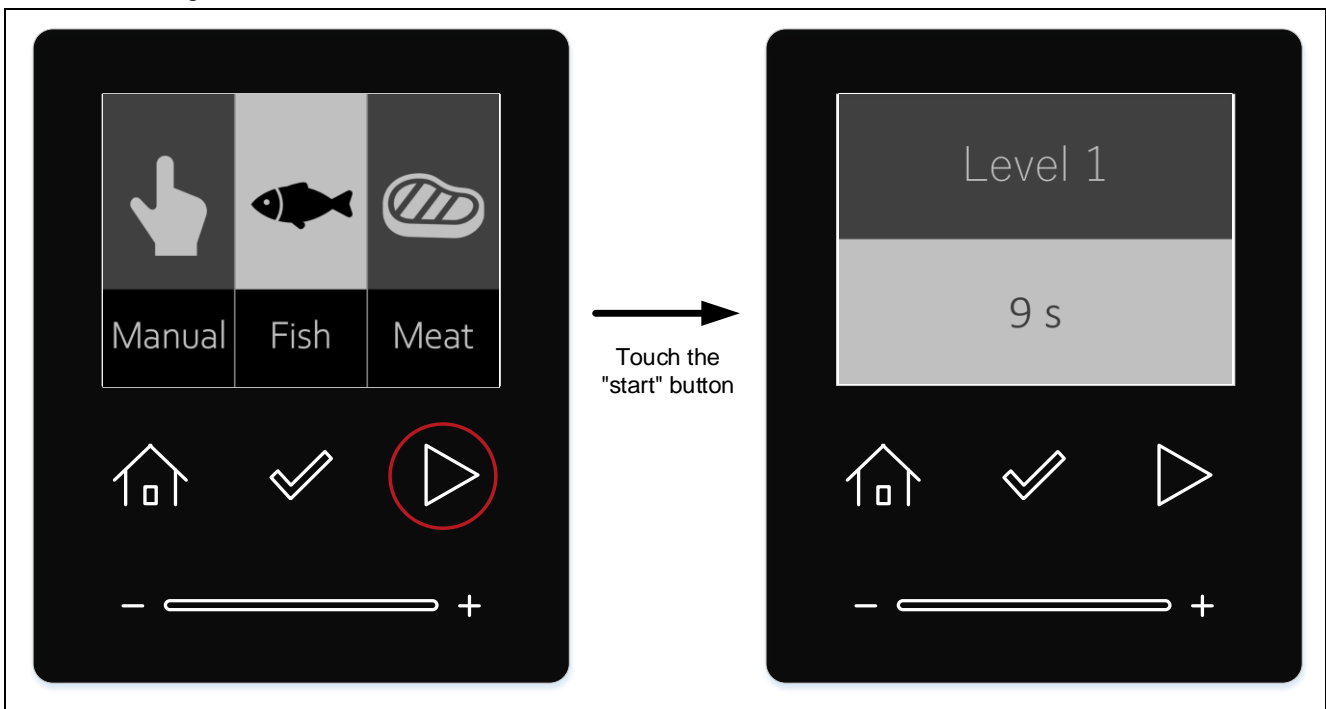

Figure 5-19 Start defrosting in Fish mode

5.4.5 Select Meat

While "Meat" is selected on the Defrost mode selection screen, touching the "start" button can start defrosting with the settings for "Meat".

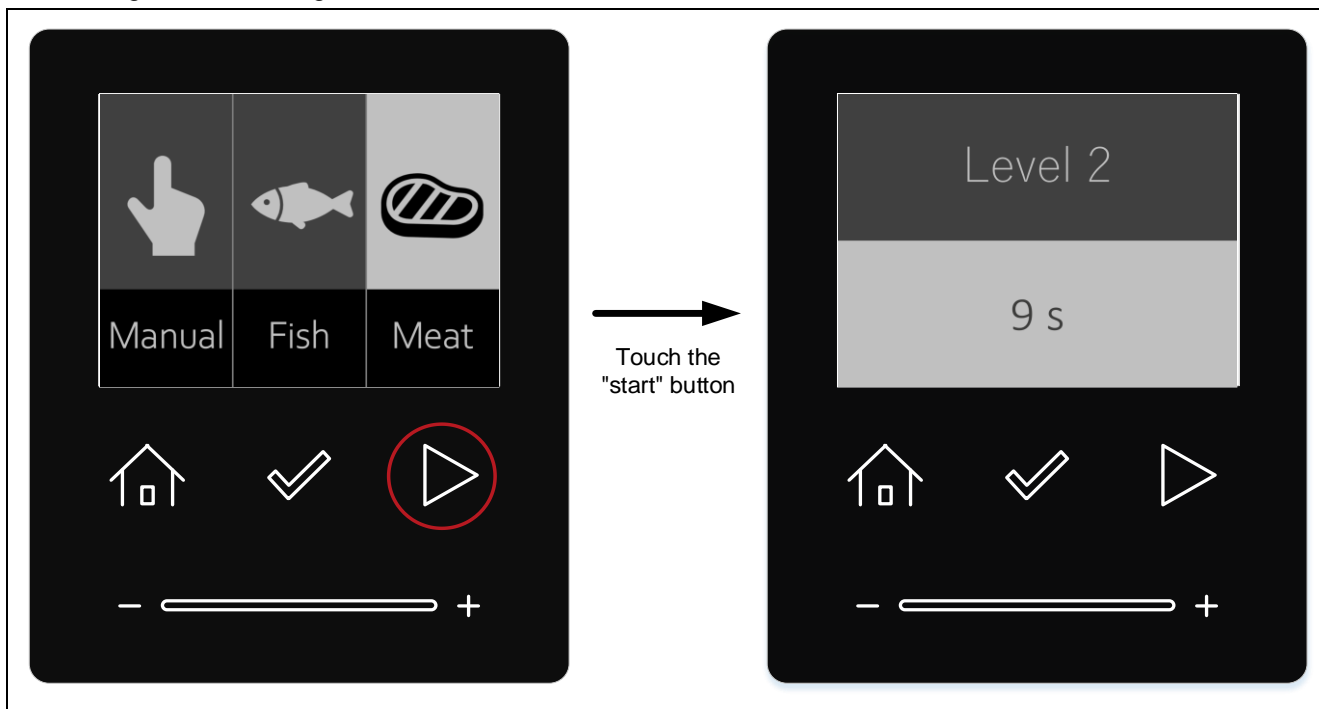

Figure 5-20 Start defrosting in Meat mode

5.5 Recipe setting

5.5.1 Move to recipe selection screen

While "Recipe" is selected on the menu screen, touching the "select" button can move to the Recipe selection screen.

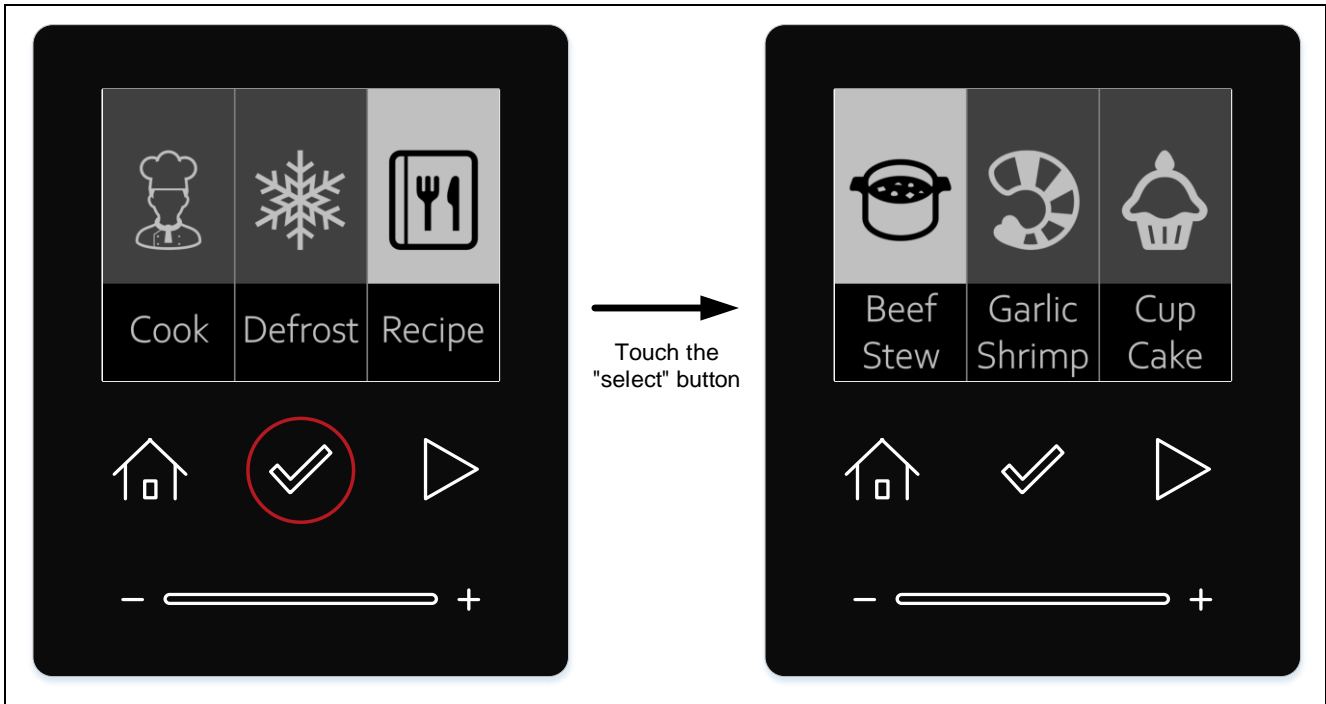

Figure 5-21 Move to the Recipe selection screen

5.5.2 Select recipe

While the Recipe selection screen is displayed, "Beef Stew", "Garlic Shrimp" or "Cup Cake" can be selected with the slider operation.

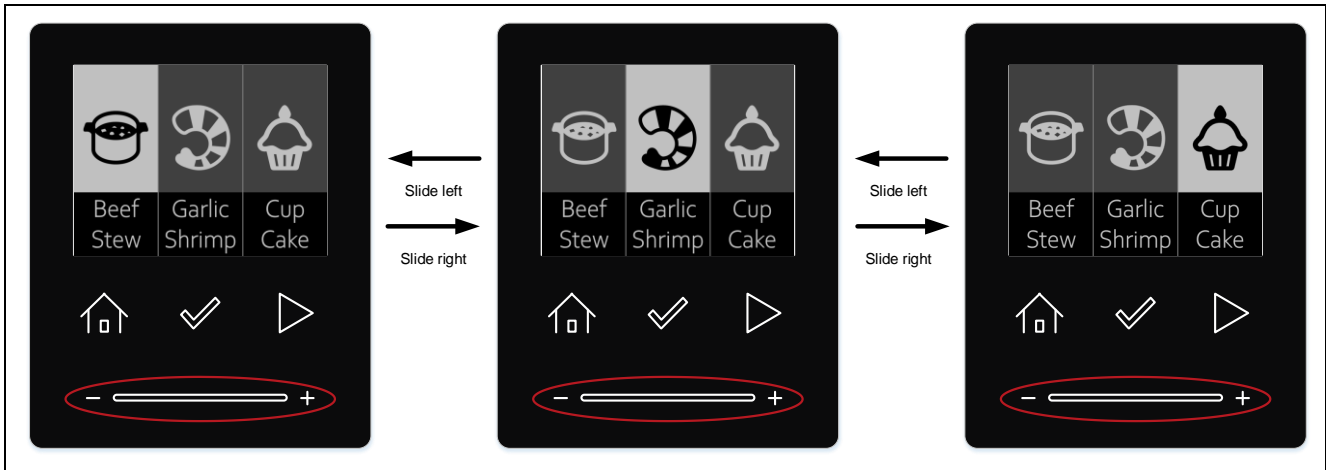

Figure 5-22 How to operate the Recipe selection screen

5.5.3 Select Beef Stew

While "Beef Stew" is selected on the Recipe selection screen, touching the "start" button can start cooking for the Settings for Beef Stew.

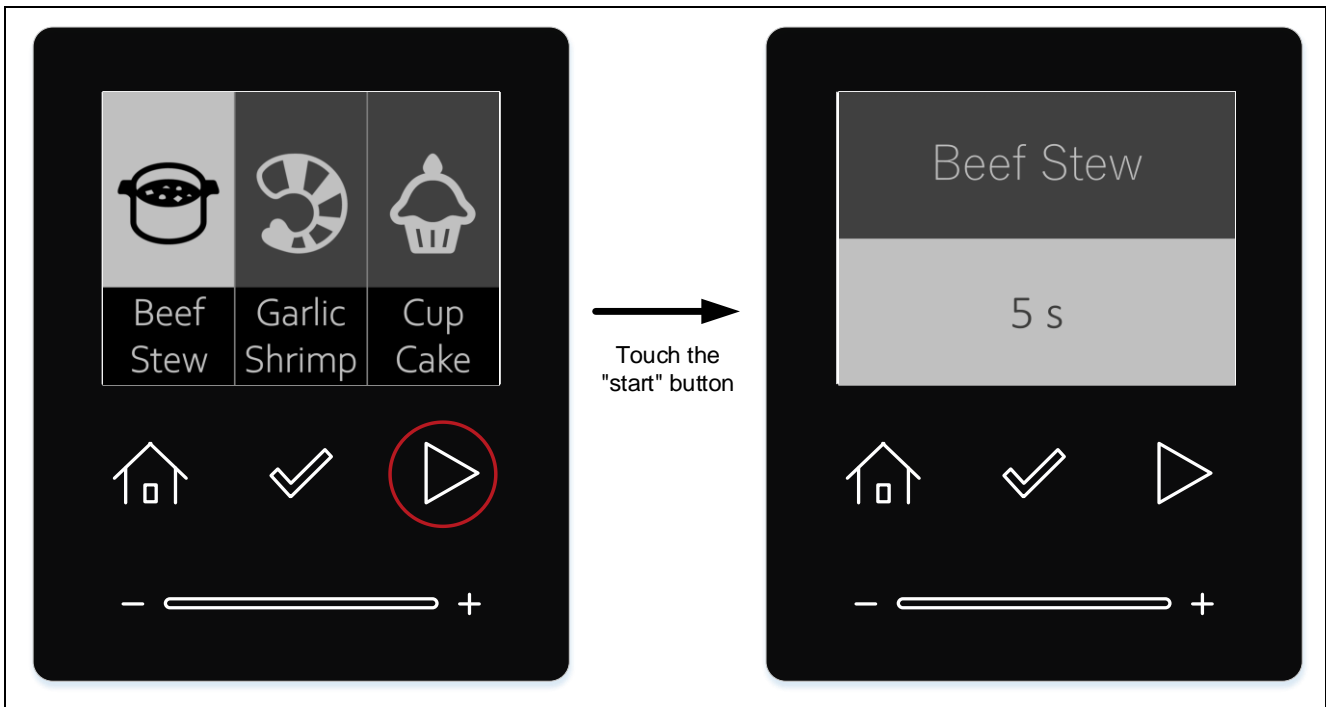

Figure 5-23 Start cooking in Beef Stew mode

5.5.4 Select Garlic Shrimp

While "Garlic Shrimp" is selected on the Recipe selection screen, touching the "start" button can start cooking for the Settings for Garlic Shrimp.

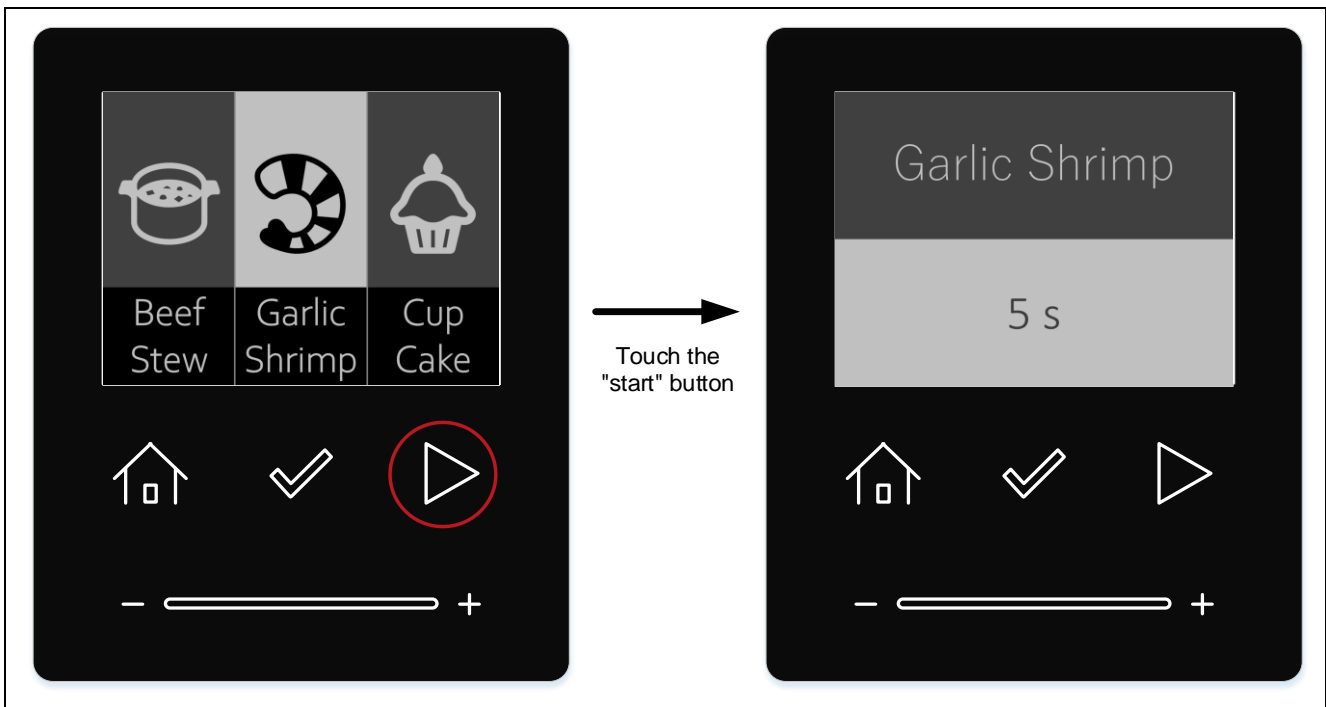

Figure 5-24 Start cooking in Garlic Shrimp mode

5.5.5 Select Cup Cake

While "Cup Cake" is selected on the Recipe selection screen, touching the "start" button can start cooking for the Settings for Cup Cake.

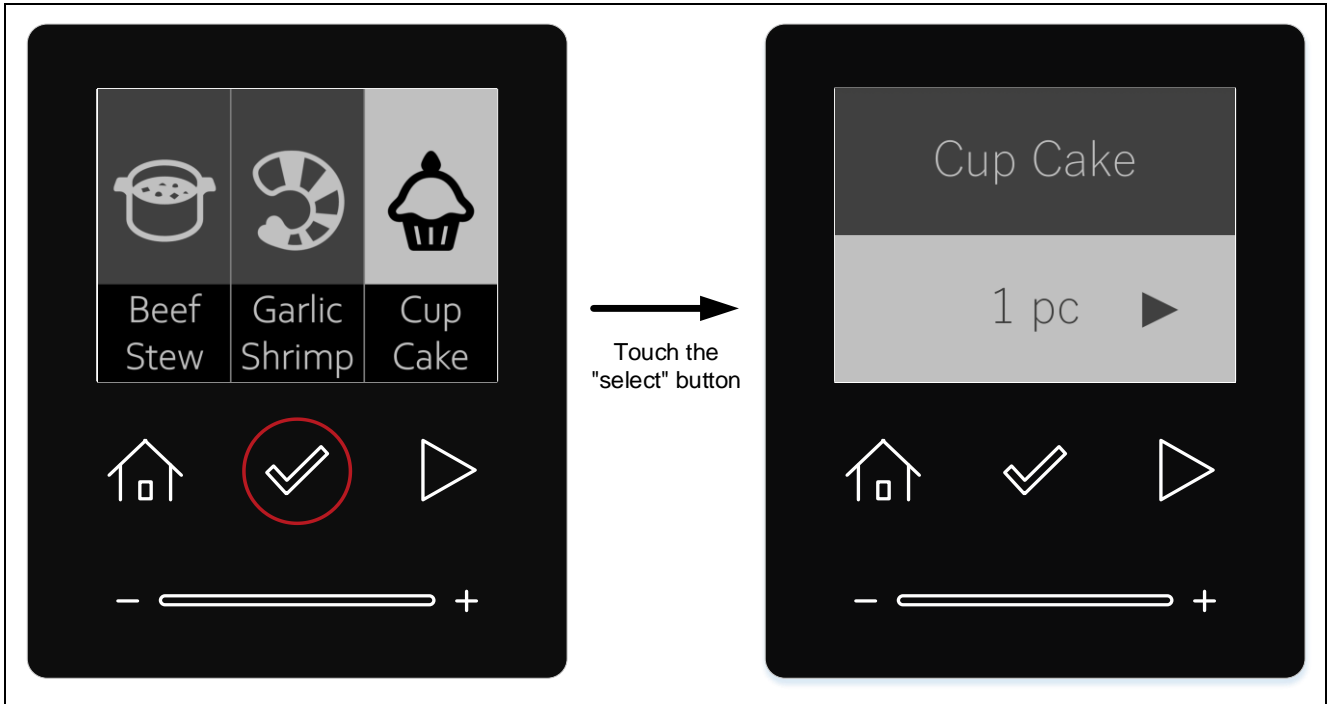

Figure 5-25 Move to the Cup Cake detail setting screen

5.5.5.1 Set the number of cupcakes

You can set the number of cupcakes with the slider. "1pc", "2pcs" and "3pcs" can be selected as the cooking amount.

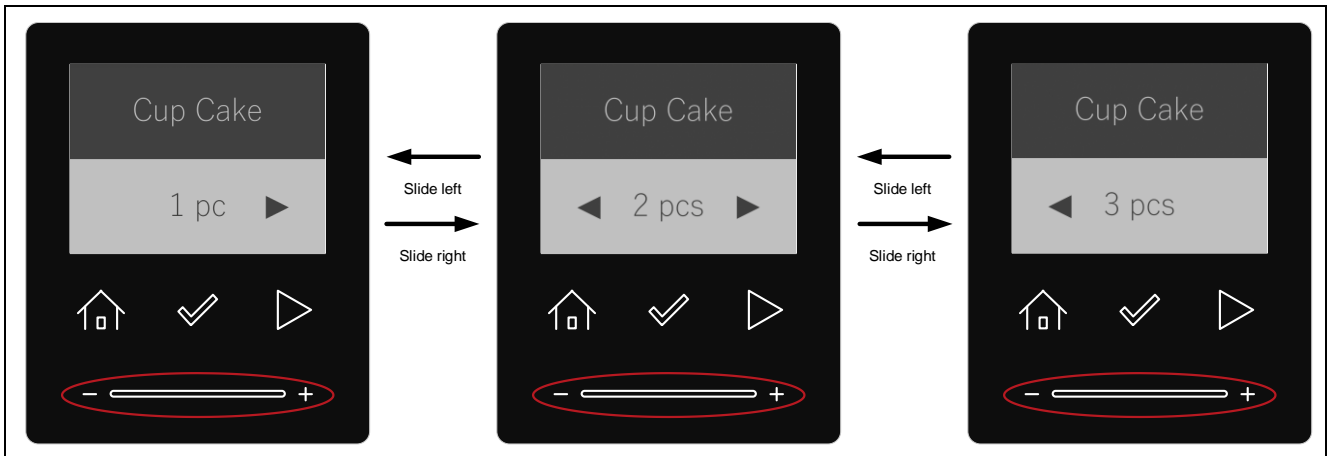

Figure 5-26 Setting the number of cupcakes

5.5.5.2 Start cooking

While the Cup Cake detail setting screen is displayed, touching the "start" button can start cooking.

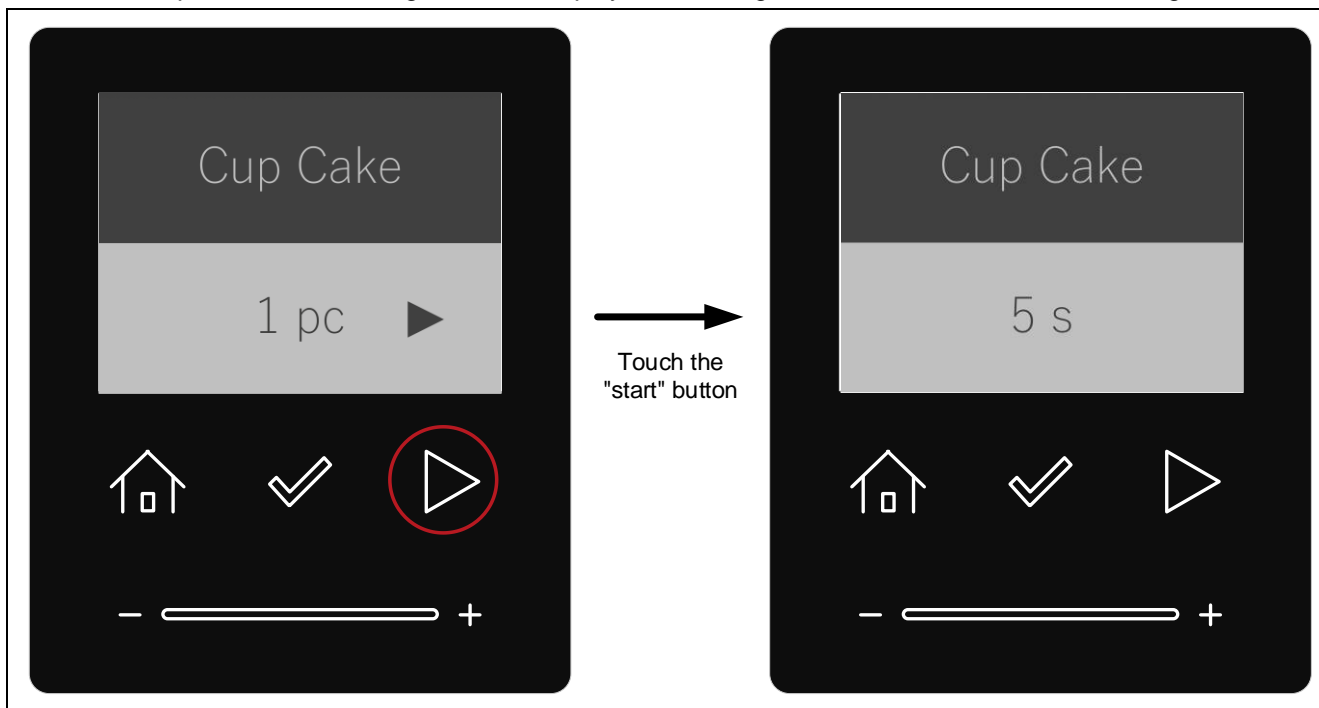

Figure 5-27 Start cooking in Cup Cake mode

5.6 About the "home" button

The "home" button returns to the menu screen from any screen.

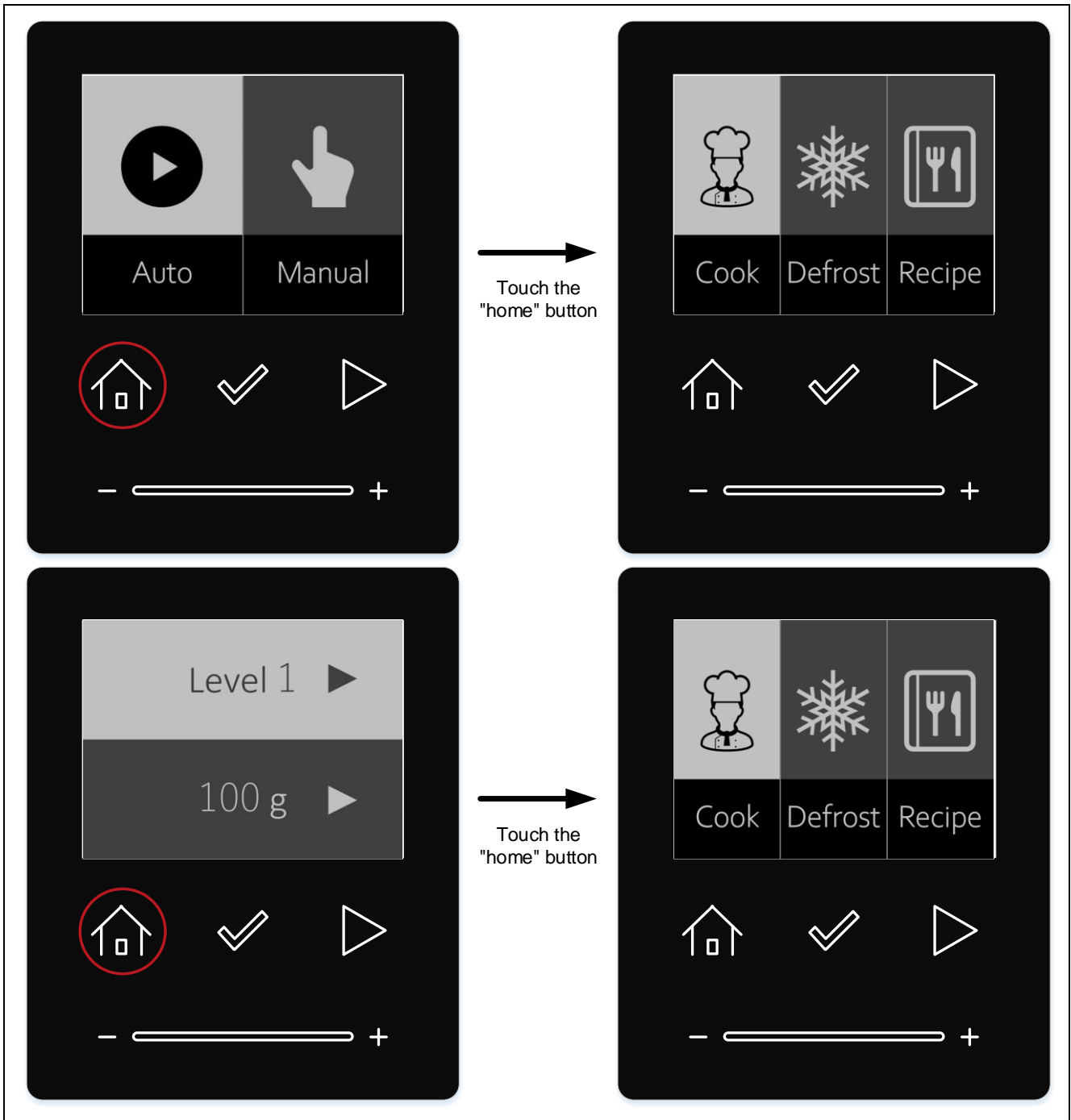

Figure 5-28 Example of "home" button operation

5.7 About the cooking completion screen

While completed cooking, the cooking completion screen is displayed for 3 seconds. After that, move to the menu screen automatically.

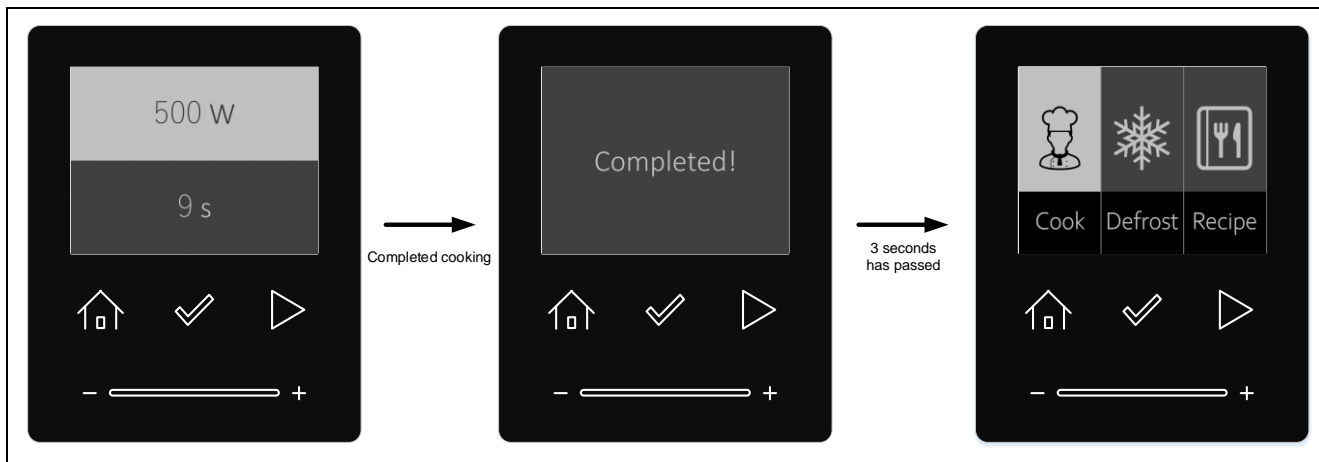

Figure 5-29 Example of cooking completion operation

5.8 Smart wakeup function

If no touch operation is performed for 10 seconds, the LCD is turned off and the RX140 transitions to software standby mode. For detail on Smart Wakeup, refer to “RX140 Group Smart Wakeup Solution”.

Long touch any button to return to the previous screen.

6. Reference Documents

- RX140 Group User's Manual: Hardware (R01UH0905)
- RX140 Group Smart Wakeup Solution (R11AN0613)
- RX Family Using QE and FIT to Develop Capacitive Touch Applications (R01AN4516)
- RX Family QE for Display GUI Display Application Development Guide (R20AN0688)

The latest version can be downloaded from the Renesas Electronics website.

All trademarks and registered trademarks are the property of their respective owners.

Revision History

Rev.	Date	Description	
		Page	Summary
1.00	Apr.24.23	—	First edition

General Precautions in the Handling of Microprocessing Unit and Microcontroller Unit Products

The following usage notes are applicable to all Microprocessing unit and Microcontroller unit products from Renesas. For detailed usage notes on the products covered by this document, refer to the relevant sections of the document as well as any technical updates that have been issued for the products.

1. Precaution against Electrostatic Discharge (ESD)

A strong electrical field, when exposed to a CMOS device, can cause destruction of the gate oxide and ultimately degrade the device operation. Steps must be taken to stop the generation of static electricity as much as possible, and quickly dissipate it when it occurs. Environmental control must be adequate. When it is dry, a humidifier should be used. This is recommended to avoid using insulators that can easily build up static electricity.

Semiconductor devices must be stored and transported in an anti-static container, static shielding bag or conductive material. All test and measurement tools including work benches and floors must be grounded. The operator must also be grounded using a wrist strap. Semiconductor devices must not be touched with bare hands. Similar precautions must be taken for printed circuit boards with mounted semiconductor devices.

2. Processing at power-on

The state of the product is undefined at the time when power is supplied. The states of internal circuits in the LSI are indeterminate and the states of register settings and pins are undefined at the time when power is supplied. In a finished product where the reset signal is applied to the external reset pin, the states of pins are not guaranteed from the time when power is supplied until the reset process is completed. In a similar way, the states of pins in a product that is reset by an on-chip power-on reset function are not guaranteed from the time when power is supplied until the power reaches the level at which resetting is specified.

3. Input of signal during power-off state

Do not input signals or an I/O pull-up power supply while the device is powered off. The current injection that results from input of such a signal or I/O pull-up power supply may cause malfunction and the abnormal current that passes in the device at this time may cause degradation of internal elements. Follow the guideline for input signal during power-off state as described in your product documentation.

4. Handling of unused pins

Handle unused pins in accordance with the directions given under handling of unused pins in the manual. The input pins of CMOS products are generally in the high-impedance state. In operation with an unused pin in the open-circuit state, extra electromagnetic noise is induced in the vicinity of the LSI, an associated shoot-through current flows internally, and malfunctions occur due to the false recognition of the pin state as an input signal become possible.

5. Clock signals

After applying a reset, only release the reset line after the operating clock signal becomes stable. When switching the clock signal during program execution, wait until the target clock signal is stabilized. When the clock signal is generated with an external resonator or from an external oscillator during a reset, ensure that the reset line is only released after full stabilization of the clock signal. Additionally, when switching to a clock signal produced with an external resonator or by an external oscillator while program execution is in progress, wait until the target clock signal is stable.

6. Voltage application waveform at input pin

Waveform distortion due to input noise or a reflected wave may cause malfunction. If the input of the CMOS device stays in the area between V_{IL} (Max.) and V_{IH} (Min.) due to noise, for example, the device may malfunction. Take care to prevent chattering noise from entering the device when the input level is fixed, and also in the transition period when the input level passes through the area between V_{IL} (Max.) and V_{IH} (Min.).

7. Prohibition of access to reserved addresses

Access to reserved addresses is prohibited. The reserved addresses are provided for possible future expansion of functions. Do not access these addresses as the correct operation of the LSI is not guaranteed.

8. Differences between products

Before changing from one product to another, for example to a product with a different part number, confirm that the change will not lead to problems. The characteristics of a microprocessing unit or microcontroller unit products in the same group but having a different part number might differ in terms of internal memory capacity, layout pattern, and other factors, which can affect the ranges of electrical characteristics, such as characteristic values, operating margins, immunity to noise, and amount of radiated noise. When changing to a product with a different part number, implement a system-evaluation test for the given product.

Notice

1. Descriptions of circuits, software and other related information in this document are provided only to illustrate the operation of semiconductor products and application examples. You are fully responsible for the incorporation or any other use of the circuits, software, and information in the design of your product or system. Renesas Electronics disclaims any and all liability for any losses and damages incurred by you or third parties arising from the use of these circuits, software, or information.
2. Renesas Electronics hereby expressly disclaims any warranties against and liability for infringement or any other claims involving patents, copyrights, or other intellectual property rights of third parties, by or arising from the use of Renesas Electronics products or technical information described in this document, including but not limited to, the product data, drawings, charts, programs, algorithms, and application examples.
3. No license, express, implied or otherwise, is granted hereby under any patents, copyrights or other intellectual property rights of Renesas Electronics or others.
4. You shall be responsible for determining what licenses are required from any third parties, and obtaining such licenses for the lawful import, export, manufacture, sales, utilization, distribution or other disposal of any products incorporating Renesas Electronics products, if required.
5. You shall not alter, modify, copy, or reverse engineer any Renesas Electronics product, whether in whole or in part. Renesas Electronics disclaims any and all liability for any losses or damages incurred by you or third parties arising from such alteration, modification, copying or reverse engineering.
6. Renesas Electronics products are classified according to the following two quality grades: "Standard" and "High Quality". The intended applications for each Renesas Electronics product depends on the product's quality grade, as indicated below.
 - "Standard": Computers; office equipment; communications equipment; test and measurement equipment; audio and visual equipment; home electronic appliances; machine tools; personal electronic equipment; industrial robots; etc.
 - "High Quality": Transportation equipment (automobiles, trains, ships, etc.); traffic control (traffic lights); large-scale communication equipment; key financial terminal systems; safety control equipment; etc.Unless expressly designated as a high reliability product or a product for harsh environments in a Renesas Electronics data sheet or other Renesas Electronics document, Renesas Electronics products are not intended or authorized for use in products or systems that may pose a direct threat to human life or bodily injury (artificial life support devices or systems; surgical implantations; etc.), or may cause serious property damage (space system; undersea repeaters; nuclear power control systems; aircraft control systems; key plant systems; military equipment; etc.). Renesas Electronics disclaims any and all liability for any damages or losses incurred by you or any third parties arising from the use of any Renesas Electronics product that is inconsistent with any Renesas Electronics data sheet, user's manual or other Renesas Electronics document.
7. No semiconductor product is absolutely secure. Notwithstanding any security measures or features that may be implemented in Renesas Electronics hardware or software products, Renesas Electronics shall have absolutely no liability arising out of any vulnerability or security breach, including but not limited to any unauthorized access to or use of a Renesas Electronics product or a system that uses a Renesas Electronics product. RENESAS ELECTRONICS DOES NOT WARRANT OR GUARANTEE THAT RENESAS ELECTRONICS PRODUCTS, OR ANY SYSTEMS CREATED USING RENESAS ELECTRONICS PRODUCTS WILL BE INVULNERABLE OR FREE FROM CORRUPTION, ATTACK, VIRUSES, INTERFERENCE, HACKING, DATA LOSS OR THEFT, OR OTHER SECURITY INTRUSION ("Vulnerability Issues"). RENESAS ELECTRONICS DISCLAIMS ANY AND ALL RESPONSIBILITY OR LIABILITY ARISING FROM OR RELATED TO ANY VULNERABILITY ISSUES. FURTHERMORE, TO THE EXTENT PERMITTED BY APPLICABLE LAW, RENESAS ELECTRONICS DISCLAIMS ANY AND ALL WARRANTIES, EXPRESS OR IMPLIED, WITH RESPECT TO THIS DOCUMENT AND ANY RELATED OR ACCOMPANYING SOFTWARE OR HARDWARE, INCLUDING BUT NOT LIMITED TO THE IMPLIED WARRANTIES OF MERCHANTABILITY, OR FITNESS FOR A PARTICULAR PURPOSE.
8. When using Renesas Electronics products, refer to the latest product information (data sheets, user's manuals, application notes, "General Notes for Handling and Using Semiconductor Devices" in the reliability handbook, etc.), and ensure that usage conditions are within the ranges specified by Renesas Electronics with respect to maximum ratings, operating power supply voltage range, heat dissipation characteristics, installation, etc. Renesas Electronics disclaims any and all liability for any malfunctions, failure or accident arising out of the use of Renesas Electronics products outside of such specified ranges.
9. Although Renesas Electronics endeavors to improve the quality and reliability of Renesas Electronics products, semiconductor products have specific characteristics, such as the occurrence of failure at a certain rate and malfunctions under certain use conditions. Unless designated as a high reliability product or a product for harsh environments in a Renesas Electronics data sheet or other Renesas Electronics document, Renesas Electronics products are not subject to radiation resistance design. You are responsible for implementing safety measures to guard against the possibility of bodily injury, injury or damage caused by fire, and/or danger to the public in the event of a failure or malfunction of Renesas Electronics products, such as safety design for hardware and software, including but not limited to redundancy, fire control and malfunction prevention, appropriate treatment for aging degradation or any other appropriate measures. Because the evaluation of microcomputer software alone is very difficult and impractical, you are responsible for evaluating the safety of the final products or systems manufactured by you.
10. Please contact a Renesas Electronics sales office for details as to environmental matters such as the environmental compatibility of each Renesas Electronics product. You are responsible for carefully and sufficiently investigating applicable laws and regulations that regulate the inclusion or use of controlled substances, including without limitation, the EU RoHS Directive, and using Renesas Electronics products in compliance with all these applicable laws and regulations. Renesas Electronics disclaims any and all liability for damages or losses occurring as a result of your noncompliance with applicable laws and regulations.
11. Renesas Electronics products and technologies shall not be used for or incorporated into any products or systems whose manufacture, use, or sale is prohibited under any applicable domestic or foreign laws or regulations. You shall comply with any applicable export control laws and regulations promulgated and administered by the governments of any countries asserting jurisdiction over the parties or transactions.
12. It is the responsibility of the buyer or distributor of Renesas Electronics products, or any other party who distributes, disposes of, or otherwise sells or transfers the product to a third party, to notify such third party in advance of the contents and conditions set forth in this document.
13. This document shall not be reprinted, reproduced or duplicated in any form, in whole or in part, without prior written consent of Renesas Electronics.
14. Please contact a Renesas Electronics sales office if you have any questions regarding the information contained in this document or Renesas Electronics products.

(Note1) "Renesas Electronics" as used in this document means Renesas Electronics Corporation and also includes its directly or indirectly controlled subsidiaries.

(Note2) "Renesas Electronics product(s)" means any product developed or manufactured by or for Renesas Electronics.

(Rev.5.0-1 October 2020)

Corporate Headquarters

TOYOSU FORESIA, 3-2-24 Toyosu,
Koto-ku, Tokyo 135-0061, Japan
www.renesas.com

Trademarks

Renesas and the Renesas logo are trademarks of Renesas Electronics Corporation. All trademarks and registered trademarks are the property of their respective owners.

Contact information

For further information on a product, technology, the most up-to-date version of a document, or your nearest sales office, please visit:
www.renesas.com/contact/.