

# RA FAMILY

Industry-Leading Arm® Cortex®-M Family,  
Delivering the Ultimate Promise of Security,  
Connectivity and Intelligent IoT



# INTRODUCING THE RA FAMILY

Delivering the Ultimate Promise of IoT with Software Flexibility



## CONTENT

RA Family Overview	04
RA0 Series	05
RA2 Series	06
RA4 Series	07
RA6 Series	08
RA8 Series	10
Target Applications	11
Functional Safety, IEC 60730	12
Flexible Software Package	13
Development Environment	14
RA Microcontroller Kits	15
RA Family Partners	19
RA Family Selection Guide	20



### Strong Security

- Leading-edge, integrated Renesas Security IP
- An extra layer of embedded hardware security providing tamper detection and resistance to side-channel attacks
- Integrated Arm® v8-M TrustZone®



### Arm Core

- Arm Cortex®-M23 core for the most cost/power sensitive applications
- Arm Cortex-M4/M33 cores to deliver the best balance of performance and power
- Arm Cortex-M85 core with Helium™ technology for unprecedented performance



### Flexible Software Solution

- Supported by an open and flexible ecosystem concept, the Flexible Software Package (FSP)
- Can be replaced and expanded by any other RTOS or middleware



### Best-in-Class Peripheral IP

- Excellent HMI capacitive touch technology
- The industry's highest code flash memory capacity
- Wide range of connectivity solutions

Arm®, Cortex® and TrustZone® are registered trademarks of Arm Limited (or its subsidiaries) in the EU and/or elsewhere.

## What is the Renesas RA Family?

The flexible Renesas Advanced (RA) 32-bit MCUs are industry leading 32-bit MCUs with the Arm Cortex-M23, -M33, -M4 and -M85 processor cores and PSA Certified™ assurance. The RA Family delivers key advantages compared to competitive Arm Cortex-M MCUs by providing stronger embedded security, superior CoreMark® performance, and ultra-low power operation. PSA Certified provides customers the confidence and assurance to quickly deploy secure IoT endpoint and edge devices, and smart factory equipment for Industry 4.0.

- Renesas Advanced: Innovative market-leading products based on Arm Cortex-M cores
- Ultimate promise of IoT security by further enhancing Renesas' popular Secure Crypto Engine (SCE) IP
- Best-in-class peripheral IP provided by Renesas
- Easy development of IoT edge applications using the Flexible Software Package



**Arm  
Core**

**High performance  
using Arm Cortex-M Cores**

**Up to  
2MB**

**High Flash memory integration**

**Security**

**Renesas' leading security IP  
with options based on TrustZone**

**USB  
CAN-FD  
Ethernet**

**Broad connectivity**

**Scalable**

**16-pin to 224-pin packages  
32MHz to 480MHz performance  
Feature and pin compatible**

## RA Family Overview

The Renesas RA Family lineup can be separated into four product series. Each of these series has a unique feature set, making it ideal for various applications and market needs.

The RA8 Series is the high-end product series targeting the highest performance, highest integration and advanced security. The RA8 Series supports operation at CPU speeds over 240MHz with single or dual core, with the largest Flash and RAM integration to suit applications where performance really matters most.

The RA6 Series offers the widest integration of communication interfaces, with integrated Ethernet and TFT display drivers. Memory densities range from 128KB Flash to 2MB Flash. The RA6 Series offers up to 240MHz performance running on the Cortex-M4 or Cortex-M33 core with TrustZone. The RA6 Series supports full security integration, making these devices widely desired for security applications.

The RA4 Series balances the requirements for low power with the demand for connectivity. It offers up to 1MB Flash and a wide range of communication interfaces. The utilized core is the Cortex-M4 or Cortex-M33 with TrustZone and additional security IP integration. Memory densities range from 128KB Flash up to 1MB Flash. These devices provide a CPU frequency of up to 100MHz.

On the lower end is the RA2 Series, where the low power requirements of an application matter most for these device definitions. To achieve the best performance, special power-down modes are provided, making these devices well suited for battery-powered applications. The RA2 Series provides memory densities of up to 256KB embedded Flash and a wide single voltage supply range of 1.6V to 5.5V. These devices use the Cortex-M23 core at up to 64MHz.

The RA0 series is the lowest power series within the RA Family, featuring up to 64KB Flash and a wide voltage supply range of 1.6V to 5.5V. The utilized core is the Cortex-M23 at up to 32MHz.

Series	Group					
<b>RA8</b> Over 240MHz Highest Performance, Largest Flash and RAM	<b>RA8M1</b> 480MHz Cortex-M85 ~2MB Flash	<b>RA8D1</b> 480MHz Cortex-M85 ~2MB Flash			<b>RA8T1</b> 480MHz Cortex-M85 ~2MB Flash	
	<b>RA6</b> Up to 240MHz Advanced Performance, Connectivity, Security, Scalability	<b>RA6M3</b> 120MHz Cortex-M4 ~2MB Flash	<b>RA6M5</b> 200MHz Cortex-M33 ~2MB Flash	<b>RA6E2</b> 200MHz Cortex-M33 ~256KB Flash		<b>RA6T2</b> 240MHz Cortex-M33 ~512KB Flash
<b>RA6M2</b> 120MHz Cortex-M4 ~1MB Flash		<b>RA6M4</b> 200MHz Cortex-M33 ~1MB Flash	<b>RA6E1</b> 200MHz Cortex-M33 ~1MB Flash		<b>RA6T3</b> 200MHz Cortex-M33 256KB Flash	
<b>RA6M1</b> 120MHz Cortex-M4 512KB Flash					<b>RA6T1</b> 120MHz Cortex-M4 ~512KB Flash	
<b>RA4</b> Up to 100MHz Excellent power/high-performance mix, Security		<b>RA4M3</b> 100MHz Cortex-M33 ~1MB Flash	<b>RA4E2</b> 100MHz Cortex-M33 128KB Flash			
	<b>RA4M1</b> 48MHz Cortex-M4 256KB Flash	<b>RA4M2</b> 100MHz Cortex-M33 ~512KB Flash	<b>RA4E1</b> 100MHz Cortex-M33 ~512KB Flash	<b>RA4W1</b> 48MHz Cortex-M4 512KB Flash	<b>RA4T1</b> 100MHz Cortex-M33 ~256KB Flash	
<b>RA2</b> Up to 64MHz Low power, Fast wake-up, Capacitive Touch			<b>RA2E3</b> 48MHz Cortex-M23 ~64KB Flash	<b>RA2A2</b> 48MHz Cortex-M23 ~512KB Flash		
		<b>RA2L1</b> 48MHz Cortex-M23 ~256KB Flash	<b>RA2E2</b> 48MHz Cortex-M23 ~64KB Flash	<b>RA2A1</b> 48MHz Cortex-M23 256KB Flash		
			<b>RA2E1</b> 48MHz Cortex-M23 ~128KB Flash			
<b>RA0</b> Up to 32MHz Low power, Fast wake-up			<b>RA0E1</b> 32MHz Cortex-M23 ~64KB Flash			
	Mainstream Line / Low Power		Entry Line	Rich Analog	Wireless	Motor Control

## RA0 Series

The RA0 series is the RA Family's value line 32-bit MCU, offering excellent cost effectiveness and ultra-low power consumption. It delivers up to 32MHz of CPU performance using Arm Cortex-M23 core with up to 64KB of embedded flash memory and a wide supply voltage range from 1.6V to 5.5V. In addition, implements the optimized peripherals for reduced BOM cost and simplified design for the low-end MCU market. The RA0 series is ideal for cost-sensitive applications such as Low power and Lower cost for consumer electronics, System control for small appliances, Industrial system control and Building automation.

### RA0 Series Product Groups

**RA0** Up to 32MHz  
Low power, Fast wake-up

**RA0E1**  
32MHz Cortex-M23  
~64KB Flash

Entry Line

### RA0 Series Benefits

- Best-in class Active/Standby power consumption for Arm Cortex-M23 microcontroller
- Reduction of system current consumption by low power process, low power system and features.
- Reduced BOM cost with on-chip peripheral functions, including high precision (1.0%) and wide operating temp range supported high-speed oscillator, 5V tolerant ports and background operation data flash supporting 1 million erase / program cycles.
- Connectivity to various modules through abundant serial functions
- Support many kinds of application by Wide voltage/temp range, and Safety features.

### Overview of each Product Groups

- The RA0E1 group is a basic, simple MCU in the entry line of the RA0 series. It supports up to 64KB of code flash, 12KB of SRAM memory, and a wide operating voltage range of 1.6V to 5.5V.

## RA2 Series

The RA2 Series is the RA Family's entry-level 32-bit MCU, offering excellent cost, performance, and ultra-low power consumption. It delivers up to 64MHz of CPU performance using an Arm Cortex-M23 core with up to 256KB of embedded flash memory and a wide single voltage supply range from 1.6V to 5.5V. With cutting-edge peripherals like high accuracy analog and capacitive touch sensing, the RA2 Series is ideal for system control or user interface applications such as healthcare devices, home appliances, office equipment, and measuring equipment.

### RA2 Series Product Groups

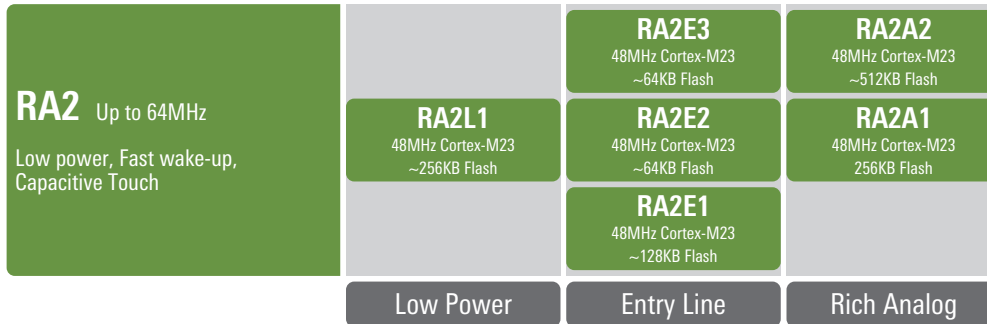

### RA2 Series Benefits

- RA2 Series use Arm cortex-M23 core which most compact and efficient Cortex-M implementation based on Armv8-M architecture profile offering high code density, low gate count, Thumb-2 instruction set, and hardware divide features.
- Large product lineup is from 16 up to 100 pin and Flash memory size starting from 16KB up to 512KB, including some very small package options, including QFN, LGA, BGA and smallest WLCSP
- Best-in class Active/Standby power consumption for Arm Cortex-M23 microcontroller
- On-chip analog components include a high accuracy 16-bit ADC, 24-bit sigma-delta ADC, fast response 12-bit DAC, rail-to-rail low-offset operational amplifiers, and high-speed/low-power comparators
- Reduced cost with on-chip peripheral functions, including high precision (1.0%) high-speed oscillator, temperature sensor, 5V tolerant ports and background operation data flash supporting 1 million erase/program cycles
- Enhanced capacitive touch sensing unit (CTSU) with high sensitivity and high noise immunity that realizes intuitive, high-quality HMI designs
- Various communication interfaces such as USB, CAN and I<sup>3</sup>C, which support IoT applications

### Overview of each Product Groups

- RA2L1 Group is Industry leading ultra-low power 32-bit Arm Cortex-M23 MCU. RA2L1 also features an enhanced Capacitive Touch Sensing Unit (CTSU2), a set of serial communication interfaces, highly accurate converters and timers.
- RA2E1 Group is entry level general-purpose MCU. RA2E1 provides pin and peripheral compatibility with the RA2L1 group and is ideal for battery-operated applications and other systems requiring high performance and low-energy consumption.
- RA2E2 Group offers ultra-low power operation and high speed serial communication with smallest package options of 20-pin and 24-pin QFN and 16-pin wafer-level CSP package, satisfying the needs of cost-sensitive and space-constrained applications.
- RA2E3 Group provides an optimized feature set for cost-sensitive applications by supporting pin-to pin and peripheral compatibility with RA2E1 Group. Ultra-low power consumption contributes to energy-efficient system design, required for IoT applications and battery-operated systems to achieve longer battery life.
- RA2A1 provides highly integrated, high-accuracy analog capabilities. This group of ICs offers a complete MCU with analog solution for signal conditioning and measurement.
- RA2A2 Group is an entry-line, single chip 32-bit Arm MCU supporting rich peripheral features to deliver better a design experience that allows high level analog sensing while reducing power consumption, system cost and overall footprint.

## RA4 Series

The RA4 Series bridges the need for reasonable low power with the demand for connectivity and performance. These MCUs deliver up to 100MHz of CPU performance using an Arm Cortex-M33 core or M4 core with up to 1MB of embedded flash memory. The series offers a wide set of peripherals, including USB, CAN/CAN FD, I<sup>2</sup>C, ADC, Bluetooth Low Energy 5.0, capacitive touch, segment LCD controller, and additional security IP integration, making it suitable for IoT, industrial equipment, home appliances, office equipment, healthcare products, and meters.

### RA4 Series Product Groups

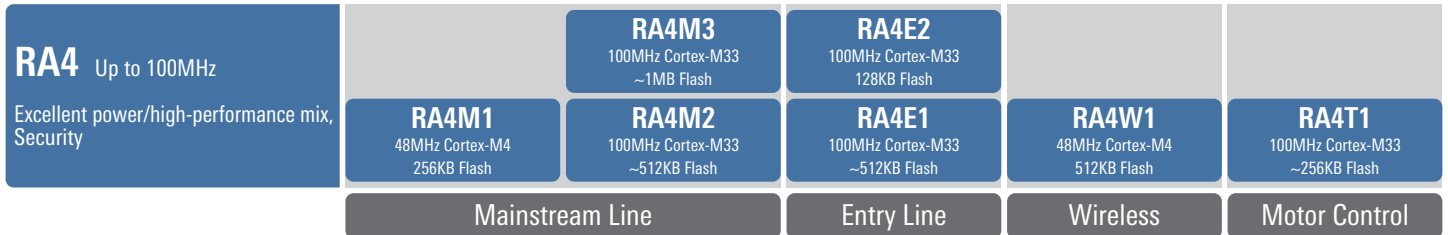

### RA4 Series Benefits

- Secure element functionality providing better performance, unlimited secure key storage, key management, and lower BOM cost
- High-performance and low power at the same time with 81µA/MHz while running the CoreMark algorithm from flash at 100MHz
- High-integration up to 1MB code flash memory with background operation and flash block SWAP operation for flexible and memory optimized firmware updates, 8KB data flash memory, and 128KB SRAM with Parity/ECC
- Rich connectivity with Bluetooth 5.0, USB 2.0 Full-Speed, CAN/CAN FD, SDHI, QSPI, I<sup>2</sup>C, I<sup>3</sup>C, HDMI-CEC, and advanced analog
- Wide range of compact BGA packages available for applications where space is at a premium

### Overview of each Product Groups

- RA4M1 Group uses the high-performance 48 MHz Arm® Cortex®-M4 core and offers a segment LCD controller and a capacitive touch sensing unit input for applications such as user interfaces and meters where low power along with a large number of capacitive touch channels and a segment LCD controller are required.
- RA4M2 group uses a high-performance 100 MHz Arm Cortex-M33 core with TrustZone along with an advanced secure crypto engine, offering the features of a secure element on-chip and the ability to secure your application. The RA4M2 is suitable for IoT applications requiring multiple communication channels with support for USB, CAN and QSPI as well as multiple channels of I<sup>2</sup>C and SCI, a large embedded SRAM, and low active power consumption.
- RA4M3 group uses the high-performance 100 MHz Arm Cortex-M33 core with TrustZone along with an advanced secure crypto engine, and support for applications that require large on-chip Flash and SRAM. The RA4M3 security engine offering the features of a secure element on-chip and Trustzone allows you to secure your application. The RA4M3 is suitable for IoT applications requiring multiple communication channels with support for USB, CAN and QSPI as well as multiple channels of I<sup>2</sup>C and SCI, and low active power consumption.
- RA4E1 group uses the high-performance 100 MHz Arm Cortex-M33 core with TrustZone and supports large on-chip Flash and SRAM. The RA4E1 has been developed to support entry IoT applications requiring a value optimized feature set, total system cost reduction and an optimized mixture of high performance and lowest active power consumption while still offering a wide range of connectivity features.
- RA4E2 Group offers high-performance and optimized peripheral functions along with the smallest package options including space saving 36-pin BGA and 32-pin QFN packages. These satisfy the needs of both cost-sensitive and space-constrained applications.
- RA4T1 Group offers optimized peripheral functions for motor control and inverter control with small 32-pin QFN and LQFP package options. These satisfy the needs of high-performance, cost-sensitive and spaceconstrained applications.

## RA6 Series

The RA6 Series offers the widest integration of communication interfaces as well as the best performance level. These MCUs aim for up to 240MHz of CPU performance using an Arm Cortex-M4 or M33 core and a memory range from 128KB to 2MB Flash. The series offers Ethernet, USB Full Speed and High Speed, QSPI, OctaSPI, CAN/CAN FD, I<sup>3</sup>C, and TFT display driver integration. The embedded security engines are full of features you can leverage in your higher-level solutions with secure element services. The RA6 Series addresses a broad range of applications for IoT endpoints such as white goods, meters, and other industrial and consumer applications.

### RA6 Series Product Groups

<b>RA6</b> Up to 240MHz Advanced Performance, Connectivity, Security, Scalability	<b>RA6M3</b> 120MHz Cortex-M4 ~2MB Flash	<b>RA6M5</b> 200MHz Cortex-M33 ~2MB Flash	<b>RA6E2</b> 200MHz Cortex-M33 ~256KB Flash	<b>RA6T2</b> 240MHz Cortex-M33 ~512KB Flash
	<b>RA6M2</b> 120MHz Cortex-M4 ~1MB Flash	<b>RA6M4</b> 200MHz Cortex-M33 ~1MB Flash	<b>RA6E1</b> 200MHz Cortex-M33 ~1MB Flash	<b>RA6T3</b> 200MHz Cortex-M33 256KB Flash
	<b>RA6M1</b> 120MHz Cortex-M4 512KB Flash			<b>RA6T1</b> 120MHz Cortex-M4 512KB Flash
	Mainstream Line		Entry Line	Motor Control

### RA6 Series Benefits

- Secure element functionality providing better performance, unlimited secure key storage, key management, and lower BOM cost
- High-performance and low-power with 80µA/MHz while running the CoreMark algorithm from flash at 200MHz
- High-integration up to 2MB code flash memory with background operation, Dual-bank, and flash block SWAP operation for extremely flexible and memory optimized firmware updates, 8KB Data flash memory, and 512KB SRAM with Parity/ECC
- Rich connectivity with Ethernet MAC controller, CAN FD, USB 2.0 High-Speed and Full-Speed, SDHI, Quad and Octa SPI, I<sup>2</sup>C, I<sup>3</sup>C, HDMI-CEC, and advanced analog with three sample and hold per ADC, PGA and high-speed comparators
- Wide range of compact BGA packages available for applications where space is at a premium

### Overview of each Product Groups

- RA6M1 group uses a high-performance, 120MHz Arm Cortex-M4 core optimised to provide an attractive price for cost sensitive applications. The RA6M1 is suitable for IoT applications requiring security, large, embedded SRAM and low power consumption. With support for a wide range of connectivity requirements including USB, CAN, QSPI and SDHI as well as multiple channels of SCI, SPI and I<sup>2</sup>C.
- RA6M2 uses a high-performance, 120MHz Arm Cortex-M4 core and offers Ethernet MAC with individual DMA, to ensure high data throughput along with advanced security functions and a wide range of other connectivity features such as USB and QSPI, as well as multiple channels of CAN, SDHI, SCI, SPI and I<sup>2</sup>C. The RA6M2 is suitable for IoT applications requiring Ethernet, security, large, embedded SRAM, and low active power consumption.
- RA6M3 uses a high-performance, 120MHz Arm Cortex-M4 core and offers a TFT controller with 2D accelerator and JPEG decoder. Additionally, the RA6M3 MCU offers Ethernet MAC with individual DMA and USB high-speed interface to ensure high data throughput along with a wide range of other connectivity features as well as advanced security functions. The RA6M3 is suitable for IoT applications requiring TFT, Ethernet, security, large, embedded SRAM, and USB High Speed (HS).
- RA6M4 uses a high-performance, 200MHz Arm Cortex-M33 core with TrustZone along with an advanced secure crypto engine, offering the features of a secure element on-chip and the ability to secure your application. The RA6M4 includes an integrated Ethernet MAC with individual DMA ensures high data throughput along with a wide range of other connectivity options including USB, CAN, SDHI, QSPI and OctaSPI. The RA6M4 is suitable for IoT applications requiring Ethernet, advanced security, large embedded SRAM, and low active power consumption.



- RA6M5 uses a high-performance, 200MHz Arm Cortex-M33 core with TrustZone along with an advanced secure crypto engine, offering the features of a secure element on-chip and the ability to secure your application. The RA6M5 offers large on-chip memories with up to 2Mbytes of on-chip Flash and 512Kbytes of SRAM, it also includes a wide range of connectivity functionality including an integrated Ethernet MAC with individual DMA ensures high data throughput along with a wide range of other connectivity options including USB, CAN, SDHI, QSPI and OctaSPI. The RA6M5 is suitable for IoT applications requiring Ethernet, advanced security, large embedded memories and low active power consumption.
- RA6E1 uses a high-performance, 200MHz Arm Cortex-M33 core with TrustZone and provides the perfect, cost effective entry point into the RA Family of microcontrollers. The RA6E1 is suitable for entry IoT applications requiring streamlined feature and connectivity integration including Ethernet and large on-chip memories, and provides unprecedented performance with 790.75 CoreMark, which are 3.95 CoreMark / MHz.
- RA6E2 Group offers best-in-class performance as an entry-line microcontroller while pursuing cost optimization. Pin and peripheral compatibility with the RA4E2 group makes it ideal for applications requiring higher performance, small footprint, and lower pin counts.
- RA6T1 Group combines an Arm Cortex-M4 at 120MHz and a rich peripheral function for motor such as PWM timer, high-speed 12-bit ADC, PGA, comparator. It can also control up to two brushless DC motors with one chip.
- RA6T2 combines an Arm Cortex-M33 with a hardware accelerator for motor control and high-speed flash memory for high-speed real-time performance at 240MHz. It can also realize high-speed, high-response motor algorithms and improve parallel processing performance such as other communication processing.
- RA6T3 is pin and function compatible with the RA4T1 group and can be seamlessly upgraded, making it an ideal solution for motor control and inverter control applications requiring higher performance.

## RA8 Series

The RA8 series are the Industry's first high performance 32-bit MCUs featuring the Arm Cortex-M85 (CM85) with a feature set optimized to address diverse general purpose as well as HMI/graphics, motor control and voice and vision AI applications in industrial, home appliance, consumer, medical and building and office automation market segments. The RA8 MCUs integrate the high-performance CM85 core with large flash and SRAM, multiple connectivity options (Ethernet, CAN-FD, I<sup>2</sup>C/I<sup>3</sup>C, SPI, Octal SPI etc.), graphics peripherals (LCD controller with parallel RGB and MIPI-DSI interfaces, 2D graphics drawing engine, 16-bit camera interface), analog features and external memory interfaces, to address the diverse needs in these market segments.

### RA8 Series Product Groups

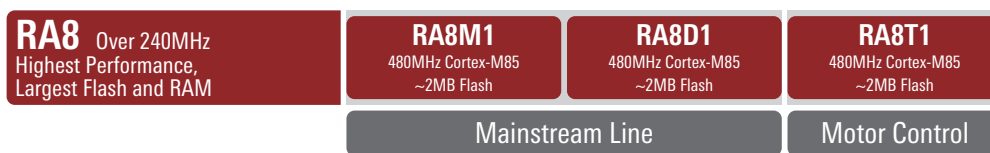

### RA8 Series Benefits

- Unprecedented performance of 6.39 Coremarks/MHz or over 3000 Coremarks with the RA8 Series MCUs running at 480MHz. These MCUs bridge the gap between MCUs and MPUs and enable compute intensive applications with the lower power and ease-of-use of an MCU.
- Advanced Security with TrustZone, leading-edge cryptographic accelerators for symmetric and asymmetric cryptography with the latest Renesas Security IP, immutable storage for first stage bootloader on-chip, secure boot and tamper and side-channel protection
- High integration enable lower BOM costs and simplified design for our customers, with large embedded flash and SRAM, rich peripheral set, graphics integration, several connectivity options, multiple external memory interfaces, and timer and analog features.
- Advanced graphics capabilities enable high resolution HMI/Graphics and Vision AI applications by combining the high performance of the CM85 core and Helium with graphics features such as graphics LCD controller with parallel RGB and MIPI-DSI interfaces, large on-chip SRAM, 2D graphics drawing engine, 16bit camera interface and 32-bit external memory interface.
- Lower overall system power consumption with multiple low power sleep and standby modes, CPU sleep modes, low speed active modes, a wide operating voltage range, Vcc/Vcc2 domain and DCDC and external power supply options.
- Comprehensive solutions that include Flexible Software Package, development tools, EKs and solutions.

### Overview of each Product Groups

- RA8M1 Group based on the Arm Cortex-M85 core with TrustZone and Helium, running at up to 480MHz are high performance general-purpose MCUs optimized for a broad range of applications in industrial, metering, office automation, consumer and medical applications. The RA8M1 MCUs are suited for compute intensive applications that require the high performance of the CM85 core accelerated with Helium, advanced security and the rich peripheral set including many connectivity options (CAN-FD, USBHS/FS, Ethernet, I<sup>2</sup>C/I<sup>3</sup>C. Octal SPI, SPI etc.), external memory interfaces, analog and timing features and functional safety.
- RA8D1 Group based on the Cortex-M85 core with TrustZone and Helium, and running at up to 480MHz, are specialized MCUs for advanced HMI, high resolution graphics and Vision AI applications. These MCUs feature an LCD Controller with RGB and MIPI-DSI interface, 2D drawing engine, a 16-bit camera interface and a 32-bit SDRAM interface, very suited for high resolution graphics. In addition, these devices include advanced security, several connectivity options (CAN-FD, USBHS/FS, Ethernet, I<sup>2</sup>C/I<sup>3</sup>C. Octal SPI, SPI etc.), external memory interfaces, and analog and timing features.
- RA8T1 Group based on the Cortex-M85 core with TrustZone and Helium, running at up to 480MHz, are specialized MCUs with a feature set optimized to address diverse real-time control such as motor control, power supply and so on, in industrial automation (IA), building automation (BA) and smart home (HA) markets. These MCU are optimized for single and dual motor control applications and predictive maintenance AI use cases. For motor control, RA8T1 MCUs have 14ch PWM timers which operate at 120MHz, 2 A/D converters and 3ch sample-and-hold (on ADC unit0), 2ch analog comparators, port output enable circuit, and more. In addition, various communication features such as Ethernet MAC, CAN FD, USB FS, and I<sup>2</sup>C/I<sup>3</sup>C enable connectivity with other devices.

## Target Applications and Markets















































The Renesas RA Family targets various application fields. Due to its scalability, the RA Family offers parts which cover many different applications and customer needs.

The feature set of the Renesas RA Family is well suited for industrial applications due to its long product life with 105° Celsius support. Dedicated analog feature integration like ADC, PGA, and comparators, combined with powerful and flexible timers, makes the RA Family an ideal fit for motor control applications.

Features like connectivity peripherals, hardware-accelerated cryptography, and scalability make the whole RA Family a perfect fit for customers who want to design secure and connected products in areas such as building or industrial automation.

Customers with Electricity Metering applications will enjoy the scalability and long product life of the RA Family, in addition to the on-chip security engines.

The integrated Capacitive Touch interface, combined with the scalability of the RA Family, make the RA Family an ideal fit for white goods applications, enabling innovative HMI designs.

	Best Suitable Product Series	Application Examples
<b>Industrial Automation</b> 	    	<ul style="list-style-type: none"> <li>Robotics</li> <li>Door Openers</li> <li>AC Drive</li> <li>AC Servo</li> <li>UPS</li> <li>Functional Safety</li> </ul>
<b>Building Automation</b> 	    	<ul style="list-style-type: none"> <li>Fire Panels</li> <li>HVAC</li> <li>Boiler Control</li> <li>Vending Machines</li> <li>Motion Detection</li> <li>Monitoring Systems</li> </ul>
<b>Metering</b> 	   	<ul style="list-style-type: none"> <li>Electricity Meters</li> <li>Automated Meter Reading</li> <li>Network Cards</li> <li>Flow Meters</li> <li>Power Meters</li> </ul>
<b>Home Appliance</b> 	    	<ul style="list-style-type: none"> <li>HVAC</li> <li>Air Cleaners</li> <li>Coffee Machines</li> <li>Vacuum Cleaners</li> <li>Cleaning Robots</li> <li>White Goods</li> </ul>
<b>Connectivity</b> 	    	<ul style="list-style-type: none"> <li>ASIS / IO-Link Gateways</li> <li>Communication Gateways</li> <li>Data Concentrators</li> <li>Wired Ethernet</li> <li>Fleet Tracking</li> </ul>
<b>Security</b> 	  	<ul style="list-style-type: none"> <li>Fire Detectors</li> <li>Burglar Detection</li> <li>Panel Control</li> <li>Door Openers</li> <li>Monitoring Systems</li> <li>Access Control</li> </ul>
<b>Motor Control</b> 	  	<ul style="list-style-type: none"> <li>Brushless DC Motors</li> <li>Induction Motors</li> <li>Stepper Motors</li> <li>Magnetic Encoders</li> <li>Optical Encoders</li> <li>Hall Sensors</li> </ul>
<b>Low Power</b> 	  	<ul style="list-style-type: none"> <li>IO-Link Sensors</li> <li>Heat Cost Allocators</li> <li>Portable Audio Devices</li> <li>Smoke Detectors</li> <li>IoT Sensing Nodes</li> <li>Wearable Devices</li> </ul>
<b>HMI</b> 	  	<ul style="list-style-type: none"> <li>Voice Recognition</li> <li>Capacitive Touch Panels</li> <li>Printers</li> <li>Vending Machines</li> <li>Home Appliances</li> <li>Medical Equipment</li> </ul>
<b>Wireless</b> 		<ul style="list-style-type: none"> <li>Wearable Devices</li> <li>Healthcare</li> <li>Panel Control</li> <li>Gateway Units</li> <li>Door Openers</li> <li>Smart Home</li> </ul>

## Integrated Hardware-based Security

In the rapidly growing area of IoT and highly-connected devices, increasing consumer awareness and government legislation is forcing embedded device manufacturers to take the topic of security seriously. Already under the constraints of needing to create cost- and energy-efficient solutions, developers nowadays are required to design and implement security with limited additional time and budget.

The RA Family was designed with security in mind and scalable hardware-based security features including:

- Isolated cryptographic operations with integrated security engines
- Unlimited secure key storage
- Hardware-enforced isolation using Arm® TrustZone® technology
- Side-channel protections

The Flexible Software Package provides integrated, easy-to-configure support for these features, and a collection of Application Projects enables you to easily incorporate them into your design.

The RA Family has achieved the following certifications, providing assurance of these security capabilities and giving you confidence in your product's security.

- PSA Certified Level 1 and Level 2
- SESIP
- NIST CAVP



# IEC61508 Functional Safety Solution

The importance of functional safety is increasing in order to prevent hazards and risks to people, machinery, and the environment from failure or error at the manufacturing site. However, designing the system and being certified under functional safety standards such as IEC 61508 requires a great deal of effort and time, which increases cost and could delay the product release significantly compared to non-safe development.

Renesas offers a one-stop functional safety solution comprised of general-purpose 32-bit microcontrollers (MCUs) with software solution components.



## Solution Introduction

The Self-Test Software Kit provides a self-diagnostics software library for microcontroller, a complete safety manual, user guide and IEC61508 SIL3 Certificate test report certified by TÜV Rheinland Industrie Service GmbH (Germany). For safe system development, developers can use the information they require from the safety manual and make use of the self-diagnostics software library to alleviate the burden on microcontroller-level development to conform to functional safety.



**This Kit diagnoses the permanent failure of CPU, internal ROM, and internal RAM.**

\* Please refer to the reference document for permanent failure diagnosis of other modules and transient failure diagnosis.

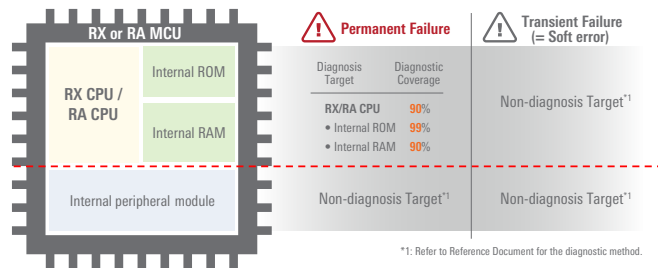

## Target Application

Safety System for:

- AC Servo & Drive
- Remote IO
- Programmable Logic Controller
- Sensor and Actuator



Industrial Robot Arm



PLC



AC Drive, Inverter

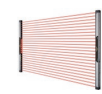

Light Curtain, Sensor

## Target Safety System Example (Motor Control + Network Control + Safety)

Example 1

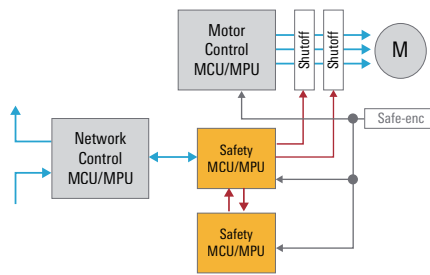

Example 2

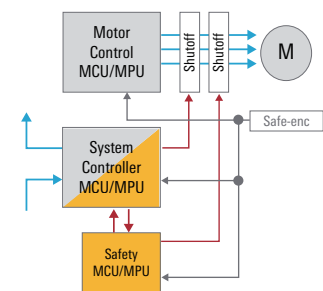

# IEC 60730 Safety Classes Support **VDE**

The IEC/UL 60730 is the harmonized safety standard for household appliances.

It describes requirements for automatic controls including heating and air-conditioning applications. Renesas offers for the RA Family a self-test library to fulfill Class B requirements of the IEC 60730 standard, as this is the most commonly used requirement.

The related Appendix H lists all the specific faults that must be tested and details the need to place the equipment into a safe state for any single point failure.

In response to the need of designing IEC/UL 60730 certified applications, Renesas provides an RA Family IEC 60730 Self-Test Library designed to reduce the burden on customers developing their own solutions. The package comes with the sample code and the certification done by VDE.

## Flexible Software Package

The Renesas Flexible Software Package (FSP) is an enhanced software package designed to provide easy-to-use, scalable, high-quality software for embedded system designs using Renesas RA Family Microcontrollers. With the support of Arm® TrustZone® and other advanced security features, FSP provides a quick and versatile way to build secure, connected IoT devices using production-ready drivers, Azure® RTOS, FreeRTOS™, and other middleware stacks.

FSP uses an open software ecosystem and provides flexibility in using bare-metal programming, included Azure RTOS or FreeRTOS, your preferred RTOS, legacy code, and third-party ecosystem solutions.

The combination of the flexible open architecture of the FSP plus the wide choice of 3rd party solutions as part of the Arm ecosystem increases the range of choice for application development. This means that developers can choose the software model that best suits their needs while utilizing Renesas's excellent Arm-based silicon solutions as well as speed up the implementation time of complex areas like connectivity and security.

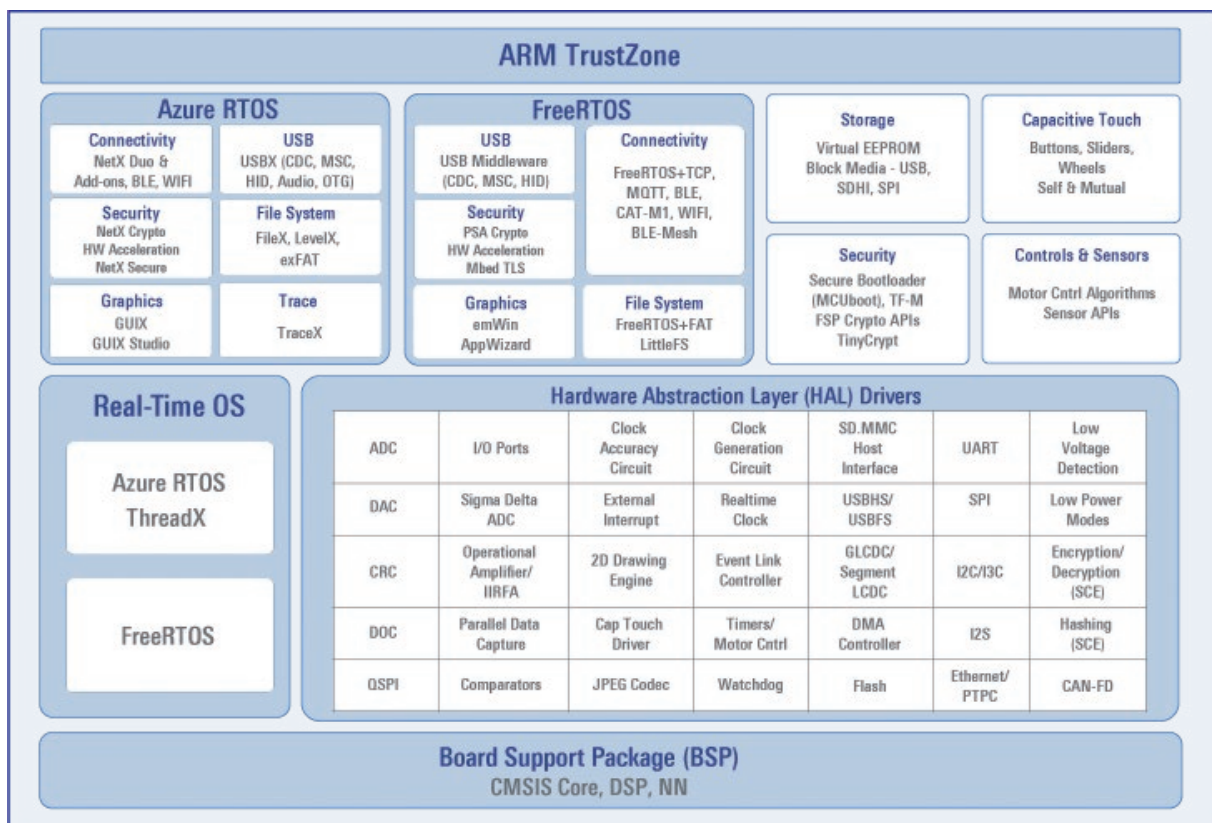

### Benefits

- Provides an easy-to-use, scalable, high-quality software for embedded system designs using the Renesas RA Family of Arm microcontrollers
- Includes best-in-class HAL drivers with high performance and low memory footprint
- Middleware stacks with Azure RTOS and FreeRTOS integration are included to ease the implementation of complex modules like communication and security
- The e<sup>2</sup> studio IDE provides support with intuitive configurators and intelligent code generation to make programming and debugging easier and faster
- Uses an open software ecosystem and provides flexibility in using bare-metal programming, included Azure RTOS and FreeRTOS, your preferred RTOS, legacy code, and third-party ecosystem solutions
- Integrated package with all required components for easy setup and starting development (single installer with e<sup>2</sup> studio, CMSIS packs, tool chain and SEGGER J-Link drivers)
- Complete source code available through GitHub

## Development Environment

The RA family development environment offers flexibility in terms of different supported on-chip debuggers, IDEs, and compilers. Customers can use the Renesas e<sup>2</sup> studio, Keil MDK and IAR Embedded Workbench. All tools can use the RA configurators for FSP driver and middleware selection and configuration, in addition to pin mapping and clock tree configuration.

### Overview

	Renesas e <sup>2</sup> studio	IAR Systems Embedded Workbench for Arm	Keil Microcontroller Development Kit
<b>Compilers</b>	<ul style="list-style-type: none"> <li>- GCC</li> <li>- LLVM</li> <li>- Arm Compiler *</li> <li>- IAR Arm Compiler *</li> </ul>	<ul style="list-style-type: none"> <li>- IAR Arm Compiler *</li> </ul>	<ul style="list-style-type: none"> <li>- Arm Compiler *</li> </ul>
<b>Debugger probes</b>	<ul style="list-style-type: none"> <li>- Renesas E2/E2 Lite</li> <li>- SEGGER J-Link</li> </ul>	<ul style="list-style-type: none"> <li>- Renesas E2/E2 Lite</li> <li>- SEGGER J-Link</li> <li>- IAR I-Jet</li> </ul>	<ul style="list-style-type: none"> <li>- SEGGER J-Link</li> <li>- Keil ULINK (limited support)</li> </ul>
<b>Smart Configurator</b>	<ul style="list-style-type: none"> <li>Built-in</li> <li>- BSP</li> <li>- Clock</li> <li>- Pin</li> <li>- Drivers</li> <li>- Interrupts</li> </ul>	<ul style="list-style-type: none"> <li>Supplied as RASC</li> <li>- BSP</li> <li>- Clock</li> <li>- Pin</li> <li>- Drivers</li> <li>- Interrupts</li> </ul>	<ul style="list-style-type: none"> <li>Supplied as RASC</li> <li>- BSP</li> <li>- Clock</li> <li>- Pin</li> <li>- Drivers</li> <li>- Interrupts</li> </ul>
<b>Application specific configurator</b>	<ul style="list-style-type: none"> <li>- QE for Capacitive Touch</li> <li>- QE for BLE</li> <li>- QE for AFE</li> <li>- Motor Control Workbench</li> </ul>	NA	NA

\*: Compiler must be purchased and licensed directly from 3rd-party.

### Benefits

The eclipse-based e<sup>2</sup> studio along with a GCC or LLVM compiler and SEGGER J-Link debugger is the primary development solution for RA MCUs and Flexible Software Package (FSP). e<sup>2</sup> studio offers a complete development flow from initial project generators, graphical FSP configuration and comprehensive debugger options.

As the RA MCU family includes TrustZone-enabled devices, configuration options ensure that a development engineer can concentrate on the application rather than the underlying technology.

Renesas recognizes that Arm based MCUs benefit from a wide ecosystem, so we have worked with Keil and IAR Systems to develop the RA Smart Configurator (RASC) that inherits all the FSP configurator options from e<sup>2</sup> studio to extend the rich development options into the MDK and EWARM IDEs. To complement the powerful SEGGER J-Link probes, RA MCUs are also supported by the Renesas E2 and E2 Lite debug probes.

Production programming options are available from Renesas (RFP and PG-FP6) in addition to numerous 3rd-party solutions such as SEGGER Flasher and PEmicro Cyclone. Please contact your preferred partner to request RA production device programming support.

## RA Microcontroller Kits

### Effortless Innovation Made Possible

The RA microcontroller kits enable users to effortlessly evaluate the features of different RA MCU Groups & develop sophisticated IoT & embedded systems applications. The kits are based on a novel architecture that provides an unparalleled combination of standardization & flexibility. The kit design helps users shorten the learning curve & accelerate development, providing more time for differentiated innovation or taking products to market faster. Users can utilize rich on-board features along with their choice of popular ecosystem add-ons to bring their big ideas to life.



#### Innovation Ready

A winning combination of standardization & flexibility that enables shorter learning curve & faster time to market



#### Ecosystem Ready

Enhance functionality on your terms & choose from hundreds of 3rd-party add-ons from popular ecosystems



#### World Ready

Compliant with many international standards. Documentation available in English & Japanese



#### Fun Ready

Take the guesswork out of your innovation experience for an unmatched, systematic & methodical approach to start developing

### Differentiation that Sets You Apart

The RA microcontroller kits portfolio consists of a variety of kits to suit many use cases such as functional evaluation, getting started reference, prototyping, proof-of-concepts, solutions demo, research & academia.

RA Kits Portfolio	RA8 MCU Series	RA6 MCU Series	RA4 MCU Series	RA2 MCU Series	RA0 MCU Series
<b>General-purpose kits</b> <ul style="list-style-type: none"> <li>Differentiated functionality</li> <li>Remarkable ease of use</li> <li>Broad ecosystem compatibility</li> <li>Multiple debugging modes</li> <li>Feature scalability &amp; expansion across RA MCU series: RA6, RA4 &amp; RA2</li> </ul>	EK-RA8M1 EK-RA8D1	EK-RA6M5 EK-RA6M4 EK-RA6M3 EK-RA6M3G EK-RA6E2	EK-RA4M3 EK-RA4M2 EK-RA4E2	EK-RA2E2 EK-RA2E1 EK-RA2L1 EK-RA2A2	
<ul style="list-style-type: none"> <li>Basic MCU pin access</li> <li>Limited ecosystem compatibility</li> <li>Basic on-board debugging</li> <li>Design reuse across Renesas MCU families: RA, RX, RL78 &amp; Synergy</li> </ul>		EK-RA6M2 EK-RA6M1 FPB-RA6E1 FPB-RA6E2	EK-RA4M1 EK-RA4W1 FPB-RA4E1 FPB-RA4E2	EK-RA2A1 FPB-RA2E1 FPB-RA2E2 FPB-RA2E3	FPB-RA0E1
<b>Application-specific kits</b> <ul style="list-style-type: none"> <li>References for specific end-applications</li> </ul>	MCK-RA8T1 Motor	CK-RA6M5 Cloud MCK-RA6T3 Motor MCK-RA6T2 Motor RSSK-RA6T1 Motor RSSK-RA6M2 Touch VOICE-RA6E1 VUI	MCK-RA4T1 Motor VOICE-RA4E1 VUI	RSSK-RA2L1 Touch VOICE-RA2L1 VUI	
<b>3rd-Party/Partner kits</b> <ul style="list-style-type: none"> <li>Access to partner's ecosystem &amp; tools</li> </ul>		M13-RA6M3-EK	RA4M1 Clicker	-	

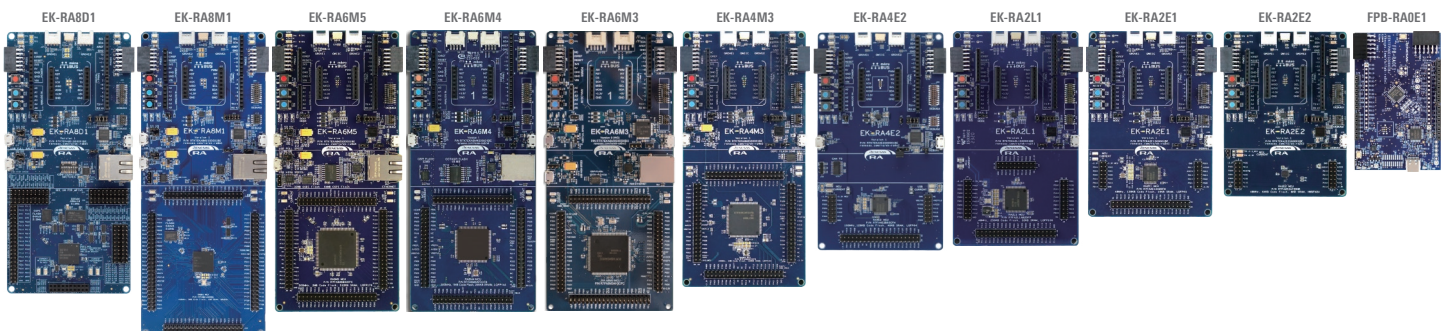

Examples of RA Microcontroller Kits

Learn more: [renesas.com/ra/kits](https://www.renesas.com/ra/kits)

## Motor Control Solution

RA Motor Control Development Kits are development kits that enables easy evaluation of motor control using permanent magnet synchronous motors (brushless DC motors). These kits are configured to run the application note sample code that can be downloaded from the homepage. In addition, development support tools such as Renesas Motor Workbench, which can analyze and tune motors, and QE for Motor are available, so you can immediately start evaluating motor control using the RA-T series.

### Features

- The CPU board is equipped with the RA-T series devices as the motor control MCU.
- Inverter board for 3-phase BLDC motor
- Supports 3-shunt current sensing
- Overcurrent detection
- Supports Motor Control Development Support Tool Renesas Motor Workbench

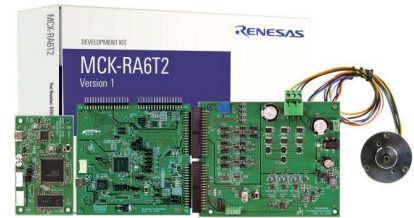

MCK-RA6T2 (RTK0EMA270S00020BJ)

	RA8T1	RA6T1	RA6T2	RA6T3	RA4T1
Motor control evaluation Kits	MCK-RA8T1 (RTK0EMA5K0S00020BJ)	RSSK-RA6T1 (RTK0EMA170S00020BJ)	MCK-RA6T2 (RTK0EMA270S00020BJ)	MCK-RA6T3 (RTK0EMA330S00020BJ)	MCK-RA4T1 (RTK0EMA430S00020BJ)
Included items	RA8T1 CPU board Inverter board (MCI-LV-1) Communication board (MC-COM) Permanent magnet synchronous motor Accessories (cables, standoffs, etc.)	RA6T1 CPU card Inverter board (RTK0EM000B10020BJ) Permanent magnet synchronous motor Accessories (cables, standoffs, etc.)	RA6T2 CPU board Inverter board (MCI-LV-1) Communication board (MC-COM) Permanent magnet synchronous motor Accessories (cables, standoffs, etc.)	RA6T3 CPU board Inverter board (MCI-LV-1) Permanent magnet synchronous motor Accessories (cables, standoffs, etc.)	RA4T1 CPU board Inverter board (MCI-LV-1) Permanent magnet synchronous motor Accessories (cables, standoffs, etc.)

## Capacitive Touch Sensing Solution

Renesas offers revolutionary design to switching devices and equipment with our 2nd generation capacitive touch solution that enables a user-friendly environment to support manufacturing processes and lowers hurdles in capacitive touch sensor development.

QE for Capacitive Touch is a solution toolkit that runs in the e<sup>2</sup> studio integrated development environment. It speeds up the development of integrated systems utilizing capacitive touch sensors by simplifying tasks such as configuring initial settings or tuning the sensitivity of the touch interface.

The capacitive touch evaluation system includes a CPU board and a self-capacitance evaluation board for use as a touch application board. It has everything you'll need to get started evaluating applications incorporating buttons, sliders, and wheels.

### QE for Capacitive Touch: Development Assistance Tool for Capacitive Touch Sensors

#### Monitoring and parameter adjustment functions

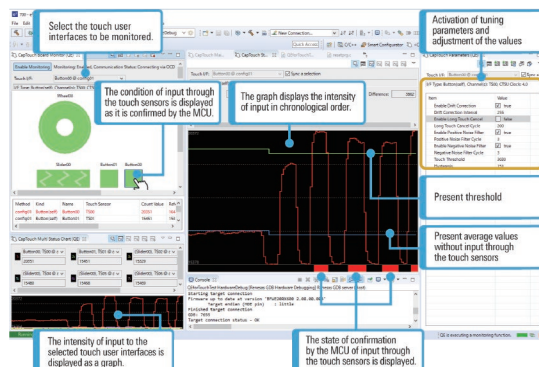

### Capacitive Touch Evaluation System for RA6M2



For more information, visit <https://www.renesas.com/rssk-touch-ra6m2>

### Capacitive Touch Evaluation System for RA2L1



For more information, visit <https://www.renesas.com/rssk-touch-ra2l1>



## Graphics Solution

Renesas offers rich graphics solutions that address demanding HMI requirements in diverse application areas. The graphics solutions include the RA MCU hardware, comprehensive graphics software and tools, and a rich set of ecosystem partner solutions.

The RA8D1 and RA6M3 MCUs support a rich set of peripherals including a graphics LCD controller with RGB parallel interface and MIPI-DSI interface (on RA8D1 only) that offloads the main CPU and drives a variety of TFT displays. Both devices also support a 2D drawing engine, and on and off-chip memory for storage of graphics assets and frame buffers. The RA6M3 also supports a JPEG codec. Together with easy-to-use graphics APIs and AppWizard GUI tools, these devices enable development of sophisticated graphics applications.

The EK-RA8D1 and EK-RA6M3 Evaluation Kits enable users to seamlessly evaluate the features of the RA8D1 and RA6M3 MCUs and develop embedded systems applications using Renesas' Flexible Software Package (FSP and e2 Studio IDE). The EK-RA8D1 and EK-RA6M3 kits consist of EK boards featuring the RA8D1 and RA6M3 MCUs with on-chip graphics LCD controller and graphics expansion boards featuring a TFT LCD panel with capacitive touch overlay. The EK-RA8D1 supports a MIPI-DSI based LCD panel, and the RA6M3 support a parallel RGB panel. The RA8D1 EK also includes on-board Octal Flash and SDRAM memory and a camera module.

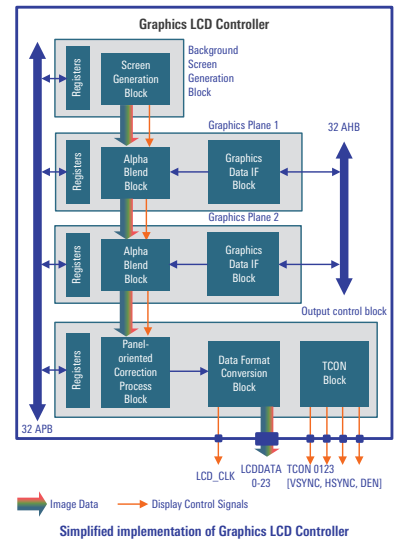

## Analog Sensing Solution

Renesas provides development assistance tool for developing embedded systems that perform high-accuracy sensing for AFE (Analog Front End) integrated microcontrollers. The AFE configuration can be set or changed by using a circuit diagram. Possible to adjust analog signals while viewing the AD conversion results (waveform and histogram) on the monitor screen without the need for an oscilloscope.

### QE for AFE

The Renesas QE (Quick and Effective) tool solution goes beyond conventional development tools by providing detailed support for developing various applications.

Key features of QE for AFE

- GUI configuration for intuitive operation
- Stand-alone operation without depending on User's specific development environment
- Auto code generation capability of AFE configuration by using e<sup>2</sup> studio plug-in version

Target device: RA2A1, RX23E-B, RA2A2

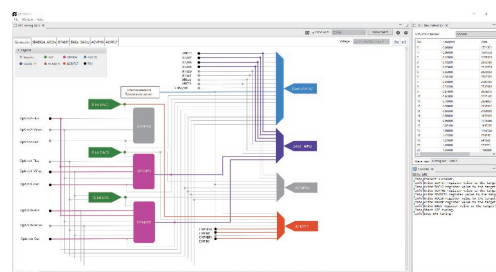
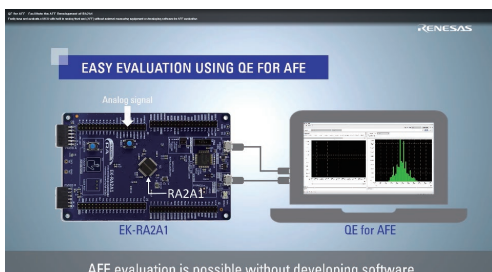

## Endpoint AI/ML Solution

### Optimized Performance and Scalability

- Renesas RA family MCUs excel in low power consumption and high performance, making them ideal for energy-efficient TinyML applications. The RA family offers a wide range of MCUs, ensuring scalability and seamless migration across different projects.

### Advanced Security Features

- RA family MCUs come with the latest integrated security features ensuring data privacy and protecting TinyML applications from potential cyber threats.



### Support for a Wide Range of ML Tools

- EAI translator that provides efficient conversion from a variety of ML frameworks into C/C++.
- Reality AI's end-to-end cloud tool streamlines the ML development process from data acquisition to deployment.
- Compatibility with open-source inference software such as TensorFlow Lite for microcontrollers.

### Cutting-Edge TinyML Solutions with Industry-Leading Partners

- Easily integrate vision AI like person detection from PlumerAI, person authentication with AIZIP, and enhance interactions using local voice triggers powered by Cyberon.
- Elevate projects with seamless, production-grade solutions.



# RA Family Partners

Renesas is enabling a comprehensive partner ecosystem to deliver an array of software and hardware building blocks that will work out-of-the-box with [Renesas RA Family MCUs](#). The Renesas RA ecosystem will help accelerate the development of IoT applications, including core technologies such as security, safety, connectivity, and HMI among others.



**Expansive Third Party Solutions Portfolio**

- 200+ partners, 300+ solutions and growing
- Coverage across all key IoT technologies
- Robust GTM and strong digital drumbeat



**Commercial Grade Building Block Solutions**

- Commercial grade software
- Work out-of-the-box with Renesas products
- Bundling options for select solutions



**Problem Solving at Heart**

- Address specific design problems
- Address specific skill-set gaps
- Customer-centric approach

## Partner Overview

The partner overview shown might not be complete since the partner network is extending almost daily. For best reference and latest data, we recommend checking our webpage at: [www.renesas.com/ra-partners](http://www.renesas.com/ra-partners)

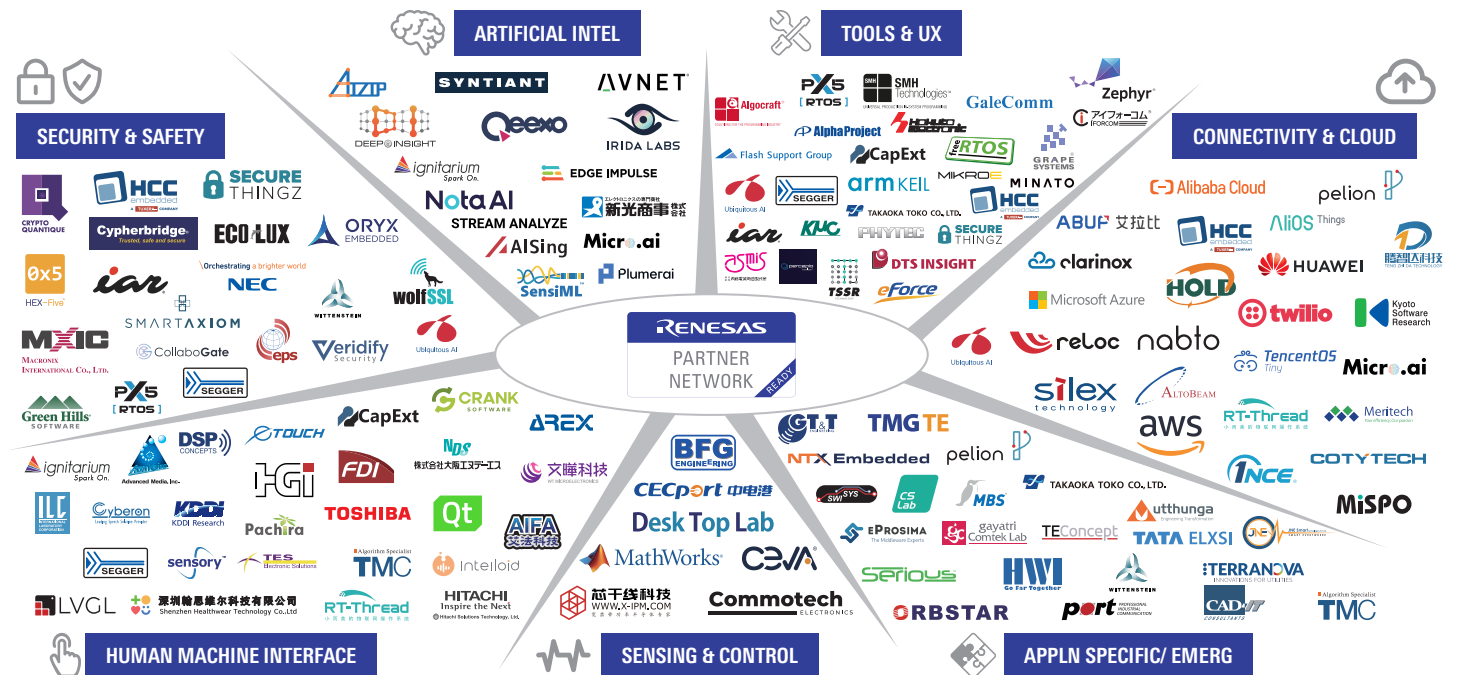







Low-Power Analog Comparator (ch)	PDA (ch)	OPAMP (ch)	Temp. Sensor (ch)	Ethernet (ch)	EtherCat (ch)	USBSFS Host (ch) device (ch)	USBSHS Host (ch) device (ch)	CAN-FD (ch)	SCI (ch)	SPI (ch)	PC (ch)	ICA (ch)	UARTA (ch)	LIN (ch)	OSPI (ch)	OSPI (ch)	SDHI (ch)	IOVA	Wireless	Segment LCD	Graphics LCD controller	MIP1 Interface (DS/C/S)	Camera (Parallel)	JPEG codec	2D drawing engine	Capacitive Touch (ch)	ECC SRAM	Security & Encryption	Suggested Kits
2	0	4	1	0	0	(1/1)	(0/0)	1	0	4	2	2	0	0	0	1	0	0	No	No	No	No	No	No	27	Yes	128-bit Unique ID, TRNG, AES128/256, GHASH	EK-BA0M1	
2	0	4	1	0	0	(1/1)	(0/0)	1	0	4	2	2	0	0	0	1	0	0	No	No	No	No	No	No	27	Yes	128-bit Unique ID, TRNG, AES128/256, GHASH	EK-BA0M1	
2	0	3	1	0	0	(1/1)	(0/0)	1	0	4	2	2	0	0	0	0	0	0	No	No	No	No	No	No	24	Yes	128-bit Unique ID, TRNG, AES128/256, GHASH	EK-BA0M1	
2	0	3	1	0	0	(1/1)	(0/0)	1	0	4	2	2	0	0	0	0	0	0	No	No	No	No	No	No	24	Yes	128-bit Unique ID, TRNG, AES128/256, GHASH	EK-BA0M1	
2	0	1	1	0	0	(1/1)	(0/0)	1	0	4	2	2	0	0	0	0	0	0	No	No	No	No	No	No	15	Yes	128-bit Unique ID, TRNG, AES128/256, GHASH	EK-BA0M1	
2	0	1	1	0	0	(1/1)	(0/0)	1	0	4	2	2	0	0	0	0	0	0	No	No	No	No	No	No	15	Yes	128-bit Unique ID, TRNG, AES128/256, GHASH	EK-BA0M1	
1	0	0	1	0	0	(1/1)	(0/0)	1	0	4	1	2	0	0	0	0	0	0	No	No	No	No	No	No	10	Yes	128-bit Unique ID, TRNG, AES128/256, GHASH	EK-BA0M1	
0	0	0	1	0	0	(1/1)	(0/0)	1	0	6	1	2	0	0	0	0	1	1	0	No	No	No	No	No	12	Yes	128-bit Unique ID, TRNG, AES128/192/256, ECC/RS(A)K/DSA, SHA2/3/SHA256, GHASH, Tamper Detection, Arm TrustZone	EK-BA0M2	
0	0	0	1	0	0	(1/1)	(0/0)	1	0	6	1	2	0	0	0	0	0	1	1	0	No	No	No	No	7	Yes	128-bit Unique ID, TRNG, AES128/192/256, ECC/RS(A)K/DSA, SHA2/3/SHA256, GHASH, Tamper Detection, Arm TrustZone	EK-BA0M2	
0	0	0	1	0	0	(1/1)	(0/0)	1	0	6	1	1	0	0	0	0	0	1	0	0	No	No	No	No	4	Yes	128-bit Unique ID, TRNG, AES128/192/256, ECC/RS(A)K/DSA, SHA2/3/SHA256, GHASH, Tamper Detection, Arm TrustZone	EK-BA0M2	
0	0	0	1	0	0	(1/1)	(0/0)	1	0	6	1	2	0	0	0	0	1	1	0	No	No	No	No	No	12	Yes	128-bit Unique ID, TRNG, AES128/192/256, ECC/RS(A)K/DSA, SHA2/3/SHA256, GHASH, Tamper Detection, Arm TrustZone	EK-BA0M2	
0	0	0	1	0	0	(1/1)	(0/0)	1	0	6	1	2	0	0	0	0	1	1	0	No	No	No	No	No	7	Yes	128-bit Unique ID, TRNG, AES128/192/256, ECC/RS(A)K/DSA, SHA2/3/SHA256, GHASH, Tamper Detection, Arm TrustZone	EK-BA0M2	
0	0	0	1	0	0	(1/1)	(0/0)	1	0	6	1	1	0	0	0	0	1	1	0	No	No	No	No	No	4	Yes	128-bit Unique ID, TRNG, AES128/192/256, ECC/RS(A)K/DSA, SHA2/3/SHA256, GHASH, Tamper Detection, Arm TrustZone	EK-BA0M2	
0	0	0	1	0	0	(1/1)	(0/0)	1	0	6	1	1	0	0	0	0	1	1	0	No	No	No	No	No	4	Yes	128-bit Unique ID, TRNG, AES128/192/256, ECC/RS(A)K/DSA, SHA2/3/SHA256, GHASH, Tamper Detection, Arm TrustZone	EK-BA0M2	
0	0	0	1	0	0	(1/1)	(0/0)	2	0	6	1	2	0	0	0	0	1	1	0	No	No	No	No	No	20	Yes	128-bit Unique ID, TRNG, AES128/192/256, ECC/RS(A)K/DSA, SHA2/3/SHA256, GHASH, Tamper Detection, Arm TrustZone	EK-BA0M3	
0	0	0	1	0	0	(1/1)	(0/0)	2	0	6	1	2	0	0	0	0	1	1	0	No	No	No	No	No	20	Yes	128-bit Unique ID, TRNG, AES128/192/256, ECC/RS(A)K/DSA, SHA2/3/SHA256, GHASH, Tamper Detection, Arm TrustZone	EK-BA0M3	
0	0	0	1	0	0	(1/1)	(0/0)	2	0	6	1	2	0	0	0	0	1	1	0	No	No	No	No	No	12	Yes	128-bit Unique ID, TRNG, AES128/192/256, ECC/RS(A)K/DSA, SHA2/3/SHA256, GHASH, Tamper Detection, Arm TrustZone	EK-BA0M3	
0	0	0	1	0	0	(1/1)	(0/0)	2	0	6	1	2	0	0	0	0	1	1	0	No	No	No	No	No	7	Yes	128-bit Unique ID, TRNG, AES128/192/256, ECC/RS(A)K/DSA, SHA2/3/SHA256, GHASH, Tamper Detection, Arm TrustZone	EK-BA0M3	
0	0	0	1	0	0	(1/1)	(0/0)	2	0	6	1	2	0	0	0	0	1	1	0	No	No	No	No	No	7	Yes	128-bit Unique ID, TRNG, AES128/192/256, ECC/RS(A)K/DSA, SHA2/3/SHA256, GHASH, Tamper Detection, Arm TrustZone	EK-BA0M3	
0	0	0	1	0	0	(1/1)	(0/0)	2	0	6	1	2	0	0	0	0	1	1	0	No	No	No	No	No	20	Yes	128-bit Unique ID, TRNG, AES128/192/256, ECC/RS(A)K/DSA, SHA2/3/SHA256, GHASH, Tamper Detection, Arm TrustZone	EK-BA0M3	
0	0	0	1	0	0	(1/1)	(0/0)	2	0	6	1	2	0	0	0	0	1	1	0	No	No	No	No	No	20	Yes	128-bit Unique ID, TRNG, AES128/192/256, ECC/RS(A)K/DSA, SHA2/3/SHA256, GHASH, Tamper Detection, Arm TrustZone	EK-BA0M3	
0	0	0	1	0	0	(1/1)	(0/0)	2	0	6	1	2	0	0	0	0	1	1	0	No	No	No	No	No	12	Yes	128-bit Unique ID, TRNG, AES128/192/256, ECC/RS(A)K/DSA, SHA2/3/SHA256, GHASH, Tamper Detection, Arm TrustZone	EK-BA0M3	
0	0	0	1	0	0	(1/1)	(0/0)	2	0	6	1	2	0	0	0	0	1	1	0	No	No	No	No	No	7	Yes	128-bit Unique ID, TRNG, AES128/192/256, ECC/RS(A)K/DSA, SHA2/3/SHA256, GHASH, Tamper Detection, Arm TrustZone	EK-BA0M3	
0	0	0	0	0	0	(1/1)	(0/0)	1	0	4	1	1	0	0	0	0	0	0	0	No	No	No	No	No	0	Yes	128-bit Unique ID, TRNG, Arm TrustZone	FPB-BA0E1	
0	0	0	0	0	0	(1/1)	(0/0)	1	0	4	1	1	0	0	0	0	0	0	0	No	No	No	No	No	0	Yes	128-bit Unique ID, TRNG, Arm TrustZone	FPB-BA0E1	
0	0	0	0	0	0	(1/1)	(0/0)	1	0	4	1	1	0	0	0	0	0	0	0	No	No	No	No	No	0	Yes	128-bit Unique ID, TRNG, Arm TrustZone	FPB-BA0E1	
0	0	0	0	0	0	(1/1)	(0/0)	1	0	4	1	1	0	0	0	0	0	0	0	No	No	No	No	No	0	Yes	128-bit Unique ID, TRNG, Arm TrustZone	FPB-BA0E1	
0	0	0	0	0	0	(1/1)	(0/0)	1	0	4	1	1	0	0	0	0	0	0	0	No	No	No	No	No	0	Yes	128-bit Unique ID, TRNG, Arm TrustZone	FPB-BA0E1	
1	0	1	1	0	0	(0/0)	(0/0)	1	0	4	2	2	0	0	0	0	0	0	No	Bluetooth 5.0	Yes	No	No	No	No	11	Yes	128-bit Unique ID, TRNG, AES128/256, GHASH	EK-BA0V1
0	0	0	1	0	0	(0/0)	(0/0)	0	1	2	2	0	1	0	0	0	0	0	0	No	No	No	No	No	0	Yes	128-bit Unique ID, TRNG, Arm TrustZone	MCK-BA0T1	
0	0	0	1	0	0	(0/0)	(0/0)	0	1	2	2	0	1	0	0	0	0	0	0	No	No	No	No	No	0	Yes	128-bit Unique ID, TRNG, Arm TrustZone	MCK-BA0T1	
0	0	0	1	0	0	(0/0)	(0/0)	0	1	2	2	0	1	0	0	0	0	0	0	No	No	No	No	No	0	Yes	128-bit Unique ID, TRNG, Arm TrustZone	MCK-BA0T1	
0	0	0	1	0	0	(0/0)	(0/0)	0	1	2	2	0	1	0	0	0	0	0	0	No	No	No	No	No	0	Yes	128-bit Unique ID, TRNG, Arm TrustZone	MCK-BA0T1	
0	0	0	1	0	0	(0/0)	(0/0)	0	1	2	2	0	1	0	0	0	0	0	0	No	No	No	No	No	0	Yes	128-bit Unique ID, TRNG, Arm TrustZone	MCK-BA0T1	
0	0	0	1	0	0	(0/0)	(0/0)	0	1	2	2	0	1	0	0	0	0	0	0	No	No	No	No	No	0	Yes	128-bit Unique ID, TRNG, Arm TrustZone	MCK-BA0T1	
0	0	0	1	0	0	(0/0)	(0/0)	0	1	2	2	0	1	0	0	0	0	0	0	No	No	No	No	No	0	Yes	128-bit Unique ID, TRNG, Arm TrustZone	MCK-BA0T1	







# RA Family Selection Guide

Series	Group	Part Number	CPU	Max. Freq (MHz)	Code Flash (KB)	Data Flash (KB)	SRAM (KB)	Package Type	Pin Count	Package Code	Package dimension (mm)	Package pitch	I/O Parts	Operating Voltage Range (V)	Operating Temperature Range	External Memory Bus (bit)	Floating Point Unit	DMA/DTC	External Interrupt Pins	32-bit ULPI (ch)	32-bit High Res Timer (ch)	32-bit Enhanced Timer (ch)	32-bit Timer (ch)	16-bit High Res Timer (ch)	16-bit Enhanced Timer (ch)	16-bit Timer (ch)	8-bit Timer (ch)	AGT	WDT	RTC	24-bit Sigma-Delta A/D Converter (ch)	16-bit A/D Converter (ch)	14-bit A/D Converter (ch)	12-bit A/D Converter (ch)	10-bit A/D Converter (ch)	12-bit D/A Converter (ch)	10-bit D/A Converter (ch)	8-bit D/A Converter (ch)	High-Speed Analog Comparator (ch)	
RA8M1		R7F8M1AHEC8D	Arm Cortex-M85	480	2048	12	1024	BGA	224	PL8G0224GD-A	13 x 13 x 1.47	0.8	174	1.68 to 3.6	Tj=-40 to 125	32/16/8	Double/Single/Half	8/1	16	2	0	0	8	0	0	6	0	2	2	Yes	0	0	0	25	0	2	0	0	2	
		R7F8M1AFEC8D	Arm Cortex-M85	480	1024	12	1024	BGA	224	PL8G0224GD-A	13 x 13 x 1.47	0.8	174	1.68 to 3.6	Tj=-40 to 125	32/16/8	Double/Single/Half	8/1	16	2	0	0	8	0	0	6	0	2	2	Yes	0	0	0	25	0	2	0	0	2	
		R7F8M1AHECF8	Arm Cortex-M85	400	2048	12	1024	LQFP	176	PLOP0176KJ-A	24 x 24 x 1.4	0.5	128	1.68 to 3.6	Tj=-40 to 125	16/8	Double/Single/Half	8/1	16	2	0	0	8	0	0	6	0	2	2	Yes	0	0	0	24	0	2	0	0	2	
		R7F8M1AHECFB	Arm Cortex-M85	400	2048	12	1024	LQFP	144	PLOP0144KA-B	20 x 20 x 1.4	0.5	106	1.68 to 3.6	Tj=-40 to 125	No	Double/Single/Half	8/1	16	2	0	0	8	0	0	6	0	2	2	Yes	0	0	0	18	0	2	0	0	2	
		R7F8M1AFECF8	Arm Cortex-M85	400	1024	12	1024	LQFP	176	PLOP0176KJ-A	24 x 24 x 1.4	0.5	128	1.68 to 3.6	Tj=-40 to 125	16/8	Double/Single/Half	8/1	16	2	0	0	8	0	0	6	0	2	2	Yes	0	0	0	24	0	2	0	0	2	
		R7F8M1AFECFB	Arm Cortex-M85	400	1024	12	1024	LQFP	144	PLOP0144KA-B	20 x 20 x 1.4	0.5	106	1.68 to 3.6	Tj=-40 to 125	No	Double/Single/Half	8/1	16	2	0	0	8	0	0	6	0	2	2	Yes	0	0	0	18	0	2	0	0	2	
		R7F8M1AHECFP	Arm Cortex-M85	360	2048	12	1024	LQFP	100	PLOP0100KP-A	14 x 14 x 1.4	0.5	70	1.68 to 3.6	Tj=-40 to 125	No	Double/Single/Half	8/1	16	2	0	0	8	0	0	6	0	2	2	Yes	0	0	0	10	0	2	0	0	2	
R7F8M1AHECFP	Arm Cortex-M85	360	1024	12	1024	LQFP	100	PLOP0100KP-A	14 x 14 x 1.4	0.5	70	1.68 to 3.6	Tj=-40 to 125	No	Double/Single/Half	8/1	16	2	0	0	8	0	0	6	0	2	2	Yes	0	0	0	10	0	2	0	0	2			
RA8D1		R7F8D1AHEC8D	Arm Cortex-M85	480	2048	12	1024	BGA	224	PL8G0224GD-A	13 x 13 x 1.47	0.8	165	1.68 to 3.6	Tj=-40 to 125	32/16/8	Double/Single/Half	8/1	16	2	0	0	8	0	0	6	0	2	2	Yes	0	0	0	25	0	2	0	0	2	
		R7F8D1BHEC8D	Arm Cortex-M85	480	2048	12	1024	BGA	224	PL8G0224GD-A	13 x 13 x 1.47	0.8	174	1.68 to 3.6	Tj=-40 to 125	32/16/8	Double/Single/Half	8/1	16	2	0	0	8	0	0	6	0	2	2	Yes	0	0	0	25	0	2	0	0	2	
		R7F8D1AFEC8D	Arm Cortex-M85	480	1024	12	1024	BGA	224	PL8G0224GD-A	13 x 13 x 1.47	0.8	165	1.68 to 3.6	Tj=-40 to 125	32/16/8	Double/Single/Half	8/1	16	2	0	0	8	0	0	6	0	2	2	Yes	0	0	0	25	0	2	0	0	2	
		R7F8D1BHEC8D	Arm Cortex-M85	480	1024	12	1024	BGA	224	PL8G0224GD-A	13 x 13 x 1.47	0.8	174	1.68 to 3.6	Tj=-40 to 125	32/16/8	Double/Single/Half	8/1	16	2	0	0	8	0	0	6	0	2	2	Yes	0	0	0	25	0	2	0	0	2	
		R7F8D1AHECF8	Arm Cortex-M85	400	2048	12	1024	LQFP	176	PLOP0176KJ-A	24 x 24 x 1.4	0.5	119	1.68 to 3.6	Tj=-40 to 125	16/8	Double/Single/Half	8/1	16	2	0	0	8	0	0	6	0	2	2	Yes	0	0	0	24	0	2	0	0	2	
		R7F8D1BHECF8	Arm Cortex-M85	400	2048	12	1024	LQFP	176	PLOP0176KJ-A	24 x 24 x 1.4	0.5	128	1.68 to 3.6	Tj=-40 to 125	16/8	Double/Single/Half	8/1	16	2	0	0	8	0	0	6	0	2	2	Yes	0	0	0	24	0	2	0	0	2	
		R7F8D1AFECF8	Arm Cortex-M85	400	1024	12	1024	LQFP	176	PLOP0176KJ-A	24 x 24 x 1.4	0.5	119	1.68 to 3.6	Tj=-40 to 125	16/8	Double/Single/Half	8/1	16	2	0	0	8	0	0	6	0	2	2	Yes	0	0	0	24	0	2	0	0	2	
R7F8D1BHECF8	Arm Cortex-M85	400	1024	12	1024	LQFP	176	PLOP0176KJ-A	24 x 24 x 1.4	0.5	128	1.68 to 3.6	Tj=-40 to 125	16/8	Double/Single/Half	8/1	16	2	0	0	8	0	0	6	0	2	2	Yes	0	0	0	24	0	2	0	0	2			
RA8T1		R7F8T1AHEC8D	Arm Cortex-M85	480	2048	12	1024	BGA	224	PL8G0224GD-A	13 x 13 x 1.47	0.8	174	1.68 to 3.6	Tj=-40 to 125	32/16/8	Double/Single/Half	8/1	16	2	0	0	8	0	0	6	0	2	2	No	0	0	0	21	0	2	0	0	2	
		R7F8T1AFEC8D	Arm Cortex-M85	480	1024	12	1024	BGA	224	PL8G0224GD-A	13 x 13 x 1.47	0.8	174	1.68 to 3.6	Tj=-40 to 125	32/16/8	Double/Single/Half	8/1	16	2	0	0	8	0	0	6	0	2	2	No	0	0	0	21	0	2	0	0	2	
		R7F8T1AHECF8	Arm Cortex-M85	400	2048	12	1024	LQFP	176	PLOP0176KJ-A	24 x 24 x 1.4	0.5	128	1.68 to 3.6	Tj=-40 to 125	16/8	Double/Single/Half	8/1	16	2	0	0	8	0	0	6	0	2	2	No	0	0	0	20	0	2	0	0	2	
		R7F8T1AHECFB	Arm Cortex-M85	400	2048	12	1024	LQFP	144	PLOP0144KA-B	20 x 20 x 1.4	0.5	106	1.68 to 3.6	Tj=-40 to 125	No	Double/Single/Half	8/1	16	2	0	0	8	0	0	6	0	2	2	No	0	0	0	16	0	2	0	0	2	
		R7F8T1AFECF8	Arm Cortex-M85	400	1024	12	1024	LQFP	176	PLOP0176KJ-A	24 x 24 x 1.4	0.5	128	1.68 to 3.6	Tj=-40 to 125	16/8	Double/Single/Half	8/1	16	2	0	0	8	0	0	6	0	2	2	No	0	0	0	20	0	2	0	0	2	
		R7F8T1AFECFB	Arm Cortex-M85	400	1024	12	1024	LQFP	144	PLOP0144KA-B	20 x 20 x 1.4	0.5	106	1.68 to 3.6	Tj=-40 to 125	No	Double/Single/Half	8/1	16	2	0	0	8	0	0	6	0	2	2	No	0	0	0	16	0	2	0	0	2	
		R7F8T1AHECFP	Arm Cortex-M85	360	2048	12	1024	LQFP	100	PLOP0100KP-A	14 x 14 x 1.4	0.5	70	1.68 to 3.6	Tj=-40 to 125	No	Double/Single/Half	8/1	16	2	0	0	8	0	0	6	0	2	2	No	0	0	0	11	0	2	0	0	2	
R7F8T1AHECFP	Arm Cortex-M85	360	1024	12	1024	LQFP	100	PLOP0100KP-A	14 x 14 x 1.4	0.5	70	1.68 to 3.6	Tj=-40 to 125	No	Double/Single/Half	8/1	16	2	0	0	8	0	0	6	0	2	2	No	0	0	0	11	0	2	0	0	2			



## Renesas Electronics Corporation TOYOSU FORESIA, 3-2-24 Toyosu, Koto-ku, Tokyo 135-0061, Japan

### Notice

1. Descriptions of circuits, software and other related information in this document are provided only to illustrate the operation of semiconductor products and application examples. You are fully responsible for the incorporation or any other use of the circuits, software, and information in the design of your product or system. Renesas Electronics disclaims any and all liability for any losses and damages incurred by you or third parties arising from the use of these circuits, software, or information.
  2. Renesas Electronics hereby expressly disclaims any warranties against and liability for infringement or any other claims involving patents, copyrights, or other intellectual property rights of third parties, by or arising from the use of Renesas Electronics products or technical information described in this document, including but not limited to, the product data, drawings, charts, programs, algorithms, and application examples.
  3. No license, express, implied or otherwise, is granted hereby under any patents, copyrights or other intellectual property rights of Renesas Electronics or others.
  4. You shall be responsible for determining what licenses are required from any third parties, and obtaining such licenses for the lawful import, export, manufacture, sales, utilization, distribution or other disposal of any products incorporating Renesas Electronics products, if required.
  5. You shall not alter, modify, copy, or reverse engineer any Renesas Electronics product, whether in whole or in part. Renesas Electronics disclaims any and all liability for any losses or damages incurred by you or third parties arising from such alteration, modification, copying or reverse engineering.
  6. Renesas Electronics products are classified according to the following two quality grades: "Standard" and "High Quality". The intended applications for each Renesas Electronics product depends on the product's quality grade, as indicated below.  
 "Standard": Computers; office equipment; communications equipment; test and measurement equipment; audio and visual equipment; home electronic appliances; machine tools; personal electronic equipment; industrial robots; etc.  
 "High Quality": Transportation equipment (automobiles, trains, ships, etc.); traffic control (traffic lights); large-scale communication equipment; key financial terminal systems; safety control equipment; etc.  
 Unless expressly designated as a high reliability product or a product for harsh environments in a Renesas Electronics data sheet or other Renesas Electronics document, Renesas Electronics products are not intended or authorized for use in products or systems that may pose a direct threat to human life or bodily injury (artificial life support devices or systems; surgical implantations; etc.), or may cause serious property damage (space system; undersea repeaters; nuclear power control systems; aircraft control systems; key plant systems; military equipment; etc.). Renesas Electronics disclaims any and all liability for any damages or losses incurred by you or any third parties arising from the use of any Renesas Electronics product that is inconsistent with any Renesas Electronics data sheet, user's manual or other Renesas Electronics document.
  7. No semiconductor product is absolutely secure. Notwithstanding any security measures or features that may be implemented in Renesas Electronics hardware or software products, Renesas Electronics shall have absolutely no liability arising out of any vulnerability or security breach, including but not limited to any unauthorized access to or use of a Renesas Electronics product or a system that uses a Renesas Electronics product. RENESAS ELECTRONICS DOES NOT WARRANT OR GUARANTEE THAT RENESAS ELECTRONICS PRODUCTS, OR ANY SYSTEMS CREATED USING RENESAS ELECTRONICS PRODUCTS WILL BE INVULNERABLE OR FREE FROM CORRUPTION, ATTACK, VIRUSES, INTERFERENCE, HACKING, DATA LOSS OR THEFT, OR OTHER SECURITY INTRUSION ("vulnerability issues"). RENESAS ELECTRONICS DISCLAIMS ANY AND ALL RESPONSIBILITY OR LIABILITY ARISING FROM OR RELATED TO ANY VULNERABILITY ISSUES. FURTHERMORE, TO THE EXTENT PERMITTED BY APPLICABLE LAW, RENESAS ELECTRONICS DISCLAIMS ANY AND ALL WARRANTIES, EXPRESS OR IMPLIED, WITH RESPECT TO THIS DOCUMENT AND ANY RELATED OR ACCOMPANYING SOFTWARE OR HARDWARE, INCLUDING BUT NOT LIMITED TO THE IMPLIED WARRANTIES OF MERCHANTABILITY, OR FITNESS FOR A PARTICULAR PURPOSE.
  8. When using Renesas Electronics products, refer to the latest product information (data sheets, user's manuals, application notes, "General Notes for Handling and Using Semiconductor Devices" in the reliability handbook, etc.), and ensure that usage conditions are within the ranges specified by Renesas Electronics with respect to maximum ratings, operating power supply voltage range, heat dissipation characteristics, installation, etc. Renesas Electronics disclaims any and all liability for any malfunctions, failure or accident arising out of the use of Renesas Electronics products outside of such specified ranges.
  9. Although Renesas Electronics endeavors to improve the quality and reliability of Renesas Electronics products, semiconductor products have specific characteristics, such as the occurrence of failure at a certain rate and malfunctions under certain use conditions. Unless designated as a high reliability product or a product for harsh environments in a Renesas Electronics data sheet or other Renesas Electronics document, Renesas Electronics products are not subject to radiation resistance design. You are responsible for implementing safety measures to guard against the possibility of bodily injury, injury or damage caused by fire, and/or danger to the public in the event of a failure or malfunction of Renesas Electronics products, such as safety design for hardware and software, including but not limited to redundancy, fire control and malfunction prevention, appropriate treatment for aging degradation or any other appropriate measures. Because the evaluation of microcomputer software alone is very difficult and impractical, you are responsible for evaluating the safety of the final products or systems manufactured by you.
  10. Please contact a Renesas Electronics sales office for details as to environmental matters such as the environmental compatibility of each Renesas Electronics product. You are responsible for carefully and sufficiently investigating applicable laws and regulations that regulate the inclusion or use of controlled substances, including without limitation, the EU RoHS Directive, and using Renesas Electronics products in compliance with all these applicable laws and regulations. Renesas Electronics disclaims any and all liability for damages or losses occurring as a result of your noncompliance with applicable laws and regulations.
  11. Renesas Electronics products and technologies shall not be used for or incorporated into any products or systems whose manufacture, use, or sale is prohibited under any applicable domestic or foreign laws or regulations. You shall comply with any applicable export control laws and regulations promulgated and administered by the governments of any countries asserting jurisdiction over the parties or transactions.
  12. It is the responsibility of the buyer or distributor of Renesas Electronics products, or any other party who distributes, disposes of, or otherwise sells or transfers the product to a third party, to notify such third party in advance of the contents and conditions set forth in this document.
  13. This document shall not be reprinted, reproduced or duplicated in any form, in whole or in part, without prior written consent of Renesas Electronics.
  14. Please contact a Renesas Electronics sales office if you have any questions regarding the information contained in this document or Renesas Electronics products.
- (Note 1) "Renesas Electronics" as used in this document means Renesas Electronics Corporation and also includes its directly or indirectly controlled subsidiaries.  
 (Note 2) "Renesas Electronics product(s)" means any product developed or manufactured by or for Renesas Electronics.

(Rev.5.0-1 2020.10)

■ Contact Us  
<https://www.renesas.com/contact-us>



# Renesas Electronics Corporation

[www.renesas.com](http://www.renesas.com)