

POWERED UP AND READY TO GO

Renesas and Intersil are now one company

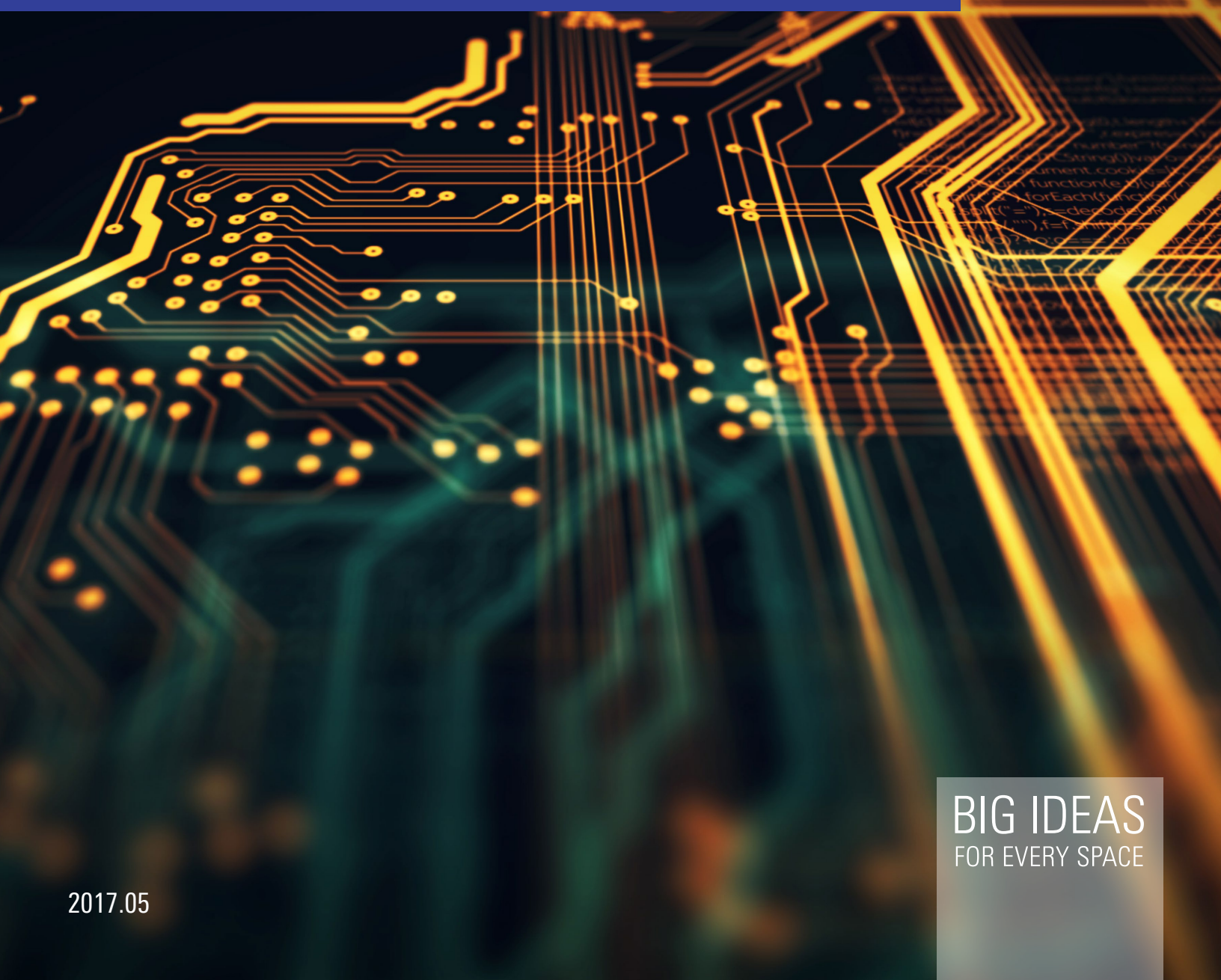

BIG IDEAS
FOR EVERY SPACE

RENESAS AND INTERSIL: PROCESSORS AND POWER

To take your design capabilities virtually anywhere.



Complete system solutions at your fingertips.

In today's fast paced technology environment, designers need to be innovative without compromising time to market. Thinking at the system level is crucial to being able to address design challenges upfront. By offering quality solutions for the two most critical parts of your design, processors and power, Renesas accelerates your development and enables differentiation, while bringing predictability to your application. Whatever your product field – automotive, industrial, home electronics, office automation or information communication technology – Renesas, with Intersil, is the partner you can rely on from design to production.

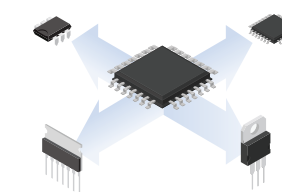

A top-to-bottom, front-to-back product offering will help speed design and bring quality, compatibility, and predictability to your applications.

The number one supplier of microcontrollers

Renesas Electronics delivers trusted embedded design innovation with complete semiconductor solutions that enable billions of connected, intelligent devices to enhance the way people work and live – securely and safely.

The number one global supplier of microcontrollers, and a leader in SoC and analog and power products, Renesas provides the expertise, quality, and comprehensive solutions for a broad range of applications, including automotive, industrial, and home electronics, to help shape a limitless future.

The leading provider of innovative power management and precision analog solutions

Intersil's products form the building blocks of increasingly intelligent, mobile and power hungry electronics, enabling advances in power management to improve efficiency and extend battery life.

With a deep portfolio of intellectual property and a rich history of design and process innovation, Intersil is the trusted partner to leading companies in some of the world's largest markets, including industrial and infrastructure, mobile computing, automotive and aerospace.

Renesas Embedded Systems Platform, Microprocessors and Microcontrollers

Renesas Synergy™ Platform	R-Car	RZ	RH850	RX	RL78
<ul style="list-style-type: none"> A complete hardware/software platform Processors range from ultra-low power to high performance 32 MHz to 240 MHz <p><i>Included Development Tools:</i></p> <ul style="list-style-type: none"> ThreadX® FileX® NetX™ GUIX™ USBX™ TraceX® IAR Embedded Workbench® for Renesas Synergy C-RUN® Renesas e² Studio 	<ul style="list-style-type: none"> 47,000 DMIPS Multimedia SoC Automotive – Scalable solutions for Infotainment, Cluster and ADAS 28 nm 	<ul style="list-style-type: none"> 25,000 DMIPS Linux, Android Industrial & Automotive 45 and 28 nm 10 MB SRAM/XIP or DDR interface 	<ul style="list-style-type: none"> 1,344 DMIPS Real Time Automotive 40nm, 32-bit, 6 families 48-484 pins, 80-533 MHz, 256 k-8 MB, 1-4 cores 	<ul style="list-style-type: none"> 480 DMIPS FPU, DSP Industrial 40 nm, 32-bit 100 µA/MHz, 350 nA standby 4 MB Flash 	<ul style="list-style-type: none"> 44 DMIPS True Low Power Consumer, Industrial & Automotive 130 nm, 16-bit 66 µA/MHz, 220 nA standby

Intersil Power Management and Precision Analog

Power Management	Amplifiers & Buffers	Audio & Video	Data Converters	Switches & Multiplexers	Optoelectronics	Timing & Digital
<ul style="list-style-type: none"> Battery Management Systems (BMS) Computing Power VRM/IMVP Digital Power Display Power and Backlighting Hot Swap & ORing Isolated Power Supply LED Drivers LNB Regulators Low Dropout Regulator ICs MOSFET Drivers PMIC Power Modules 	<ul style="list-style-type: none"> Buffers Comparators Current Sense Differential Amplifiers Display Amplifiers and Buffers Gain Blocks High-Speed Op Amps Instrumentation Amplifiers Line Drivers Precision Op Amps Sample and Hold Amplifiers Transistor Arrays 	<ul style="list-style-type: none"> Switches Automotive Infotainment & Security Surveillance Buffered Video MUXs D2Audio DVI/HDMI Display ICs HD Video Analog Front End (AFEs) Surveillance ICs Video Decoders/Encoders Video ICs 	<ul style="list-style-type: none"> D/A Converters Digital Potentiometers (DCPs) High-Speed A/D Converters Precision A/D Converters Voltage References 	<ul style="list-style-type: none"> High Voltage Low Voltage Medium Voltage USB – High-Speed – High-Speed plus 2ch Stereo Audio – High-Speed UART Dual 3-1 MUX 	<ul style="list-style-type: none"> Ambient Light Sensors Ambient Light and Proximity Sensors Laser Diode Drivers (LDD) Proximity Sensors <p>Interface</p> <ul style="list-style-type: none"> RS-485 & RS-422 RX-232 2-Wire Bus Buffers Signal Integrity 	<ul style="list-style-type: none"> Clock Generators Counters/Time Base ICs DSP Memory Microprocessors and Peripherals Real Time Clocks <p>Space & Harsh Environment</p> <ul style="list-style-type: none"> Radiation Hardened Defense & Hi-Reliability

SUPERIOR PROCESSING FOR ALL OF YOUR EMBEDDED DESIGN NEEDS

RENESAS SYNERGY™ PLATFORM

Develop from the API and innovate more with the Renesas Synergy Platform

The Renesas Synergy Platform integrates a scalable family of microcontrollers with a commercial-grade real-time operating system and middleware, and provides application frameworks that expose scalable Application Programming Interfaces (APIs). All the elements of the Synergy Platform are designed from the ground up as a single platform to provide unprecedented scalability and compatibility, not just across hardware, but also across software, allowing unparalleled design reuse.



Standardized API

- Abstracts dependencies, ensures portability, and accelerates product development
- Provides easy access to the SSP and Software Add-ons

Powerful Software

- Consists of widely-deployed, commercial-grade ThreadX® RTOS, extensive Middleware, Application Frameworks, Functional Libraries, and Hardware Abstraction Layer (HAL) Drivers

Versatile Microcontrollers

- Comprised of low-power Cortex® M0+ MCUs to high-performance Cortex M4-based chips
- Up to 4 MB of flash and cryptographic algorithms in hardware

Rich Tools & Kits

- Includes industry-leading IDE, debug and design tools: IAR Embedded Workbench® for Renesas Synergy™, C-RUN®, C-STAT®, GUIX™ and TraceX™
- Development Kits to jump-start evaluation

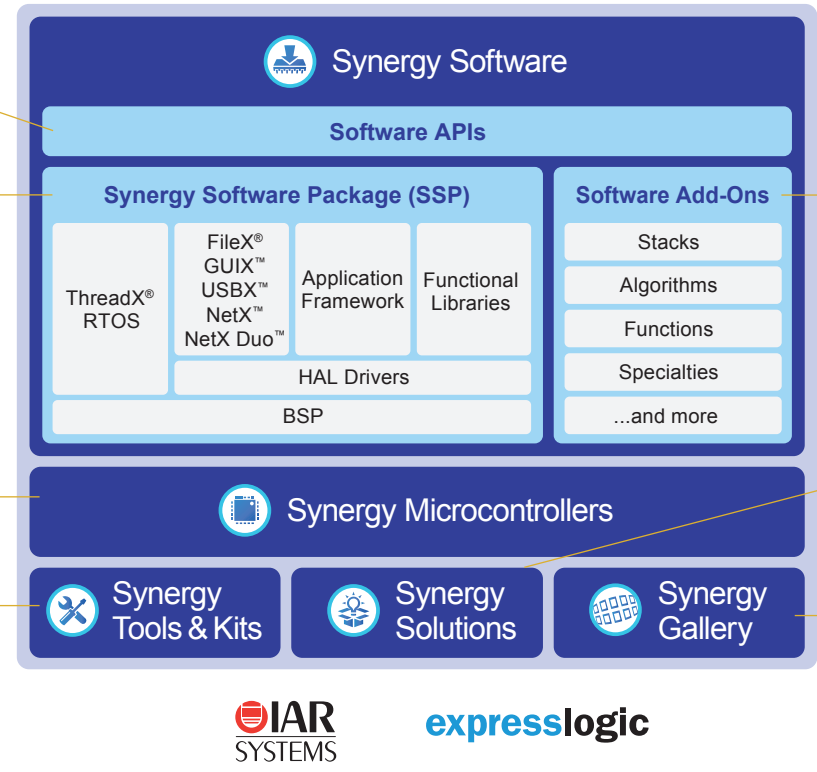

Software Add-Ons

- Verified Software Add-ons (VSAs) add specialty functions from third-party experts; certified by Renesas to be SSP compatible
- Qualified Software Add-ons (QSAs) are tested, licensed, and serviced by Renesas

Full Solution

- Application Examples (AEs) to highlight key technologies enabled by the Synergy Platform
- Product Examples (PEs) provide design instances of actual end products for a great start

Single-Source Delivery

- Implements the online destination for everything related to Synergy Software
- Go to production with simple click-through licensing

RENESAS RZ FAMILY OF MPUs

Combining high-performance, control, and connectivity

The RZ Family of high-end ARM®-based microprocessors (MPUs) fuses control and information technology (IT) to provide the solutions necessary to enable the smart society of the future. From the RZ/A MPU, with up to 10 MB of on-chip SRAM for applications such as human machine interface (HMI), to the RZ/G Series of MPUs with support for 3D graphics and full high-definition (FHD) video, to the RZ/T Series SoC for industrial automation and high-performance motor control, Renesas has the microprocessors you need to realize your next “big idea.”



Linux, Android, and QNX	RZ/G1E	1 GHz Dual ARM® Cortex®-A7 3D Graphics (SGX540) (3,800 DMIPS)	RZ/G1N	1.5 GHz Dual ARM Cortex-A15 3D Graphics (SGX544MP2) (10,500 DMIPS)
	RZ/G1M	1.5 GHz Dual ARM Cortex-A15 and 64 b memory bus 3D Graphics (SGX544MP2) (10,500 DMIPS)	RZ/G1H	1.4 GHz Quad ARM Cortex-A15 and 780 MHz Quad ARM Cortex-A7 3D Graphics (G6400) (25,528 DMIPS) Coming Soon!
Motion Control and Industrial Ethernet	RZ/T1	300-600MHz ARM Cortex-R4 w/ tightly coupled memory + Cortex M3 (960 DMIPS)		
RTOS, Linux	RZ/A1M	5 MB RAM 400 MHz ARM ARM Cortex-A9 (1000 DMIPS)	RZ/A1H	10 MB RAM 400 MHz ARM ARM Cortex-A9 (1000 DMIPS)
	RZ/A1LC	2 MB RAM 400 MHz ARM ARM Cortex-A9 (1000 DMIPS)	RZ/A1L	3 MB RAM 400 MHz ARM ARM Cortex-A9 (1000 DMIPS)
			RZ/A1LU	3 MB RAM 400 MHz ARM ARM Cortex-A9 (1000 DMIPS)



Range, Features, Scalability, and much more. The Renesas Synergy Platform includes four different series of upward software-, architecture-, and pin-compatible Synergy MCUs. The advanced S7 Series (High Performance), S5 Series (High Integration), S3 Series (High Efficiency), and S1 Series (Ultra-Low Power) MCUs utilize the popular ARM® Cortex®-M CPU architecture. The devices implement easy connectivity, rock-solid security, dependable safety, and facilitate the creation of easy-to-use human-machine interfaces.

S7	The high-performance 240 MHz S7 Series MCUs feature secure connectivity and industry-leading flash memory density.
S5	The highly integrated 120 MHz S5 Series MCUs balance processing performance with large memory and an extensive array of built-in features.
S3	High-efficiency 48 MHz S3 Series MCUs are low-power chips that integrate up to 1 MB of Flash and 192 KB of SRAM.
S1	Ultra-low-power 32 MHz S1 Series MCUs operate down to 1.6 V and feature low-power operating modes and fast wake-up times.

Renesas Synergy Gallery

The Synergy Gallery is your online destination for everything related to Synergy Software and development from both Renesas and third-party vendors participating in the rich platform ecosystem. Simple click-through licensing enables you to start your development immediately without hassles.

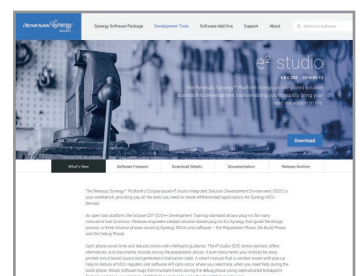

To learn more, visit: synergycastle.renesas.com

RZ Family Linux Solutions & Resources

- elinux.org/RZ-A**
 - Quick-start instructions on running Linux on RZ/A1 RSK
 - Building Linux images for standard and XIP Linux
- github.com/renesas-rz/rskrza1_bsp**
 - Linux BSP for RZ/A1 RSK
- elinux.org/RZ-G**
 - Instructions on using RZ/G1E and RZ/G1M Starter Kits
 - Building Linux images from Yocto for RZ/G1E and RZ/G1M Starter Kit
- github.com/renesas-rz/meta-renesas**
 - Yocto recipes to build basic Linux BSP for RZ/G1
- github.com/renesas-rz/meta-rzg-demos**
 - Yocto recipes to build Door phone and Qt demos

To learn more, visit: www.renesas.com/RZ

RENESAS RX FAMILY MICROCONTROLLERS

RX600/RX700 SERIES

Up to 240 DMIPS at 120 MHz & 4.25 CoreMark®/MHz

The Renesas RX600 Series of 32-bit microcontrollers (MCUs) is ideal for systems that require high performance, excellent connectivity, LCD drive, and motor control capability. The RX Family MCUs deliver superior performance in core processing, code efficiency, and power consumption.



High Performance

- With the RXv2 core, newer RX600/RX700 MCUs offer 2.00 DMIPS/MHz and 4.25 CoreMark/MHz with enhancements for floating point and DSP operations
- Industry's only 40 nm embedded flash process with zero wait states up to 120 MHz, integrating up to 4 MB Flash and 512 KB SRAM
- With RXv2 CPU core and 40 nm, RX64M/RX71M consume only 133 µA per MHz with peripherals off

Superior Connectivity

- Dual Ethernet with IEEE 1588 Version 2 support
- Dual USB with full-speed support
- Three CAN channels
- SD Host Interface transfer speed up to 15 Mbytes/sec
- MMC Interface transfer speed up to 30 Mbytes/sec
- QSPI transfer speed up to 120 Mbits/sec
- SPI transfer speed up to 30 Mbits/sec
- SCI with FIFO transfer speed up to 15 Mbits/sec
- Camera Interface with 8-bit parallel data interface
- Two-channel I²S compliant serial-sound interface

RX64M MCU Block Diagram

Memory	System	Communication	Timers	Encryption/Safety
Flash up to 4 MB SRAM 512 KB ECC RAM: 32 KB Standby RAM: 8 KB Data Flash 64 KB	Data Transfer Controller ExDMA Controller x 2 ch DMA Controller x 8 ch Interrupt Controller 16 levels, 16 pins Clock Generation Circuit PLL High-speed On-chip Oscillator Power-on Reset Voltage Detection Circuit Event Link Controller	Ethernet Controller 2 ch IEEE 1588 Clock Synchronization Control USB High-Speed: 1 ch USB Full-Speed: 1 ch I ² C Bus Interface x 2 ch Serial Communications Interface x 13 ch (incl. 4 ch with FIFO) Serial Peripheral Interface Quad Serial Peripheral Interface SD Host Interface MMC Host Interface Serial Sound Interface 2 ch CAN: 2 ch External Bus 8-, 16-, or 32-bit	Multifunction Timer Pulse Unit (MTU3) 16-bit 8 ch 32-bit 1 ch General PWM Timer (GPT) 16-bit 4 ch Timer Pulse Unit (TPU) 16-bit 6 ch Programmable Pulse Generator (PPG) 8-bit Timer (TMR) 8-bit 4 ch 16-bit Timer (CMT) x 4 ch 32-bit Timer (CMTW) x 2 ch Real-time Clock Calendar Function	Encryption Modules AES/DES/SHA/RNG Memory Protection Unit Register Write Protection Unit Clock Frequency Accuracy Measurement Circuit CRC Calculator Data Operation Circuit Watchdog Timer 14-bit 1 ch Independent Watchdog Timer 14-bit 1 ch Trusted Memory Function
Analog	Image Capture			
12-bit ADC: 29 ch 12-bit DAC: 2 ch Temp Sensor	Parallel Data Capture Unit			

RX200 SERIES

88 DMIPS Performance at 54 MHz; 120 µA/MHz 32-bit MCUs

The 32-bit MCUs in the Renesas RX200 Series, like those in the high-performance RX600 Series and the entry-level RX100 Series, are based on the high-performance RX CPU core and feature-rich RX architecture. The RX200 Series is optimized for power efficiency and offers best-in-class digital-signal processing (DSP) capabilities and advanced peripherals, making it the ideal choice for applications requiring moderately high levels of computing capability.

Low Power

- 120 µA/MHz (peripherals off)
- 0.8 µA power down with RTC on
- 0.3 µA power down with RTC off
- 0.5 µs wake-up

Advanced Peripherals

- Capacitive Touch
- USB 2.0
- Safety/Security
- SD Host Interface
- CAN (ISO 11898-1 Compliant)

High Performance

- 1.64 DMIPS/MHz
- 88 DMIPS at 54 MHz
- Enhanced DSP

Scalable

- 1.8 V to 5.5 V operation
- 1.8 V operation at up to 20 MHz
- Zero wait-state flash with erase/write operation down to 1.8 V

RX231 MCU Block Diagram

Memory	System	Communication	Analog	Timers
Zero-wait Flash up to 1 MB SRAM up to 96 KB Data Flash 8 KB	Event Link Controller Multifunction Pin Controller Data Mgmt. DTC/DMA Interrupt Cont. 16 levels, 9 pins Clocks OSC PLL IRC POR/LVD Safety CAC DOC CRC Security TSIP AES RING	I ² C 7 x Simple I ² C SCI/UART 7 ch SPI External Bus GPIO USB 2.0 SD Host Interface IrDA/I ² S/CAN	Comparator 4 ch ADC 12-bit 24 ch DAC 12-bit 2 ch 24-bit ΔΣ ADC Temp. Sensor	MTU2 16-bit 6 ch TMR 8-bit 4 ch RTC Calendar CMT 16-bit 4 ch WDT 14-bit 1 ch I-WDT
	User Interface			
	Capacitive Touch up to 24 touch keys			

RX100 SERIES

Lowest-power, Lowest-cost 32-bit MCUs

The 32-bit MCUs in the RX100 Series, like those in the high-performance RX600 Series and the mid-level RX200 Series, are based on the high-performance RX CPU core and feature-rich RX architecture. The RX100 Series is optimized for portable, battery-backed applications and offers best-in-class DSP capabilities, making it the ideal choice for power-sensitive applications that also require moderate levels of computing capability. RX100 MCUs offer extensive on-chip peripherals, fast zero wait-state Flash, and achieve 50 DMIPS performance at 32 MHz.

Low Power/Fast Wake-up

- 100 µA/MHz (peripherals off)
- 350 nA in standby mode
- 4.8 µs wake-up time

DSP Ready

- Single-cycle MAC
- Hardware-based divide
- Extensive DSP library

Best-In-Class Performance

- 3.08 CoreMark®/MHz
- 1.56 DMIPS/MHz
- 50 DMIPS @ 32 MHz

Advanced Peripherals

- Capacitive Touch
- USB 2.0
- LCD Control
- Safety



RL78 16-bit CPU Core 32 MHz

Safety	Memory	Power Management
RAM Parity Check ADC Self-diagnostic Clock Monitoring Memory CRC I/O Port Readback	Program Flash up to 64 KB SRAM 5.5 KB Data Flash 4 KB	HALT RTC, DTC Enabled SNOOZE Serial, ADC Enabled STOP SRAM On
Timers	Communications	Analog
Timer Array Unit 16-bit, 4 ch Timer RD 16-bit, 2 ch Timer RG 16-bit, 1 ch Timer RJ 16-bit, 1 ch Interval Timer 12-bit, 1 ch WDT 17-bit, 1 ch RTC Calendar Timer RX 16-bit, 1 ch	6 x I ² C Master 1 x I ² C Multi-Master 6 x CSI/SPI 7-, 8-bit 3 x UART 7-, 8-, 9-bit 1 x LIN 1 ch IrDA	ADC 10-bit, 17 ch Internal Vref. Temp. Sensor DAC 8-bit, 2 ch Comparator Input Selectable Comparator PGA
	System	
DTC 33 Sources Interrupt Controller 4 Levels	Clock Generation Internal, External, Sub-clock POR, LVD	ELC 22 Events Debug w/trace Single-wire

RL78 FAMILY MICROCONTROLLERS

The True Low Power™ Microcontroller Platform

The RL78 Family of microcontrollers combines advanced low-power technology, outstanding performance, and the broadest lineup in its class for the most demanding 8- and 16-bit embedded applications.

The RL78 MCUs' innovative "Snooze" mode achieves ultra-low power by allowing ADC operation and serial communication while the CPU is turned off. This makes the RL78 MCUs best-in-class for low-power applications.

Why RL78?

- World's leading low-power performance for equivalent MCUs in its class
- Scalability of lineup, including smart pin layout
- System cost-saving features
- Wide voltage operation
- Wide temperature operation
- Built-in safety features

True Low Power

- 66 µA/MHz operation¹
- 0.57 µA (RTC & LVD)
- Snooze mode

Broad Scalability

- 10 to 128 pins
- 1 KB to 512 KB Flash
- Full compatibility

System Cost Reduction

- Data flash with 1 million erase cycles
- 32 MHz internal oscillator (+/- 1%)
- Built-in temperature sensor and Vref

High Efficiency

- Up to 1.39 DMIPS/MHz
- 1.6 V to 5.5 V operation
- Up to 32 MHz operation

High Quality and Safety

- Flash memory with ECC
- IEC60730 safety functions
- High temperature support

Extensive Ecosystem

- Industry-standard development tools
- Third-party support
- Online resources

Note: 1. At 32 MHz (NOP instructions)

To learn more, visit: www.renesas.com/RL78



RX 32-bit CPU 32 MHz 50 DMIPS

Memory
Zero wait-state Flash up to 512 KB SRAM up to 64 KB Data Flash 8 KB

System	Communication	Timers
Event Link Controller Multifunction Pin Controller Data Mgmt. DTC/DMA Interrupt Cont. 16 levels Clocks OSC PLL IRC POR/LVD Safety CAC DOC CRC	I ² C 9 ch SCI/UART 8 ch SPI 9 ch USB 2.0 Host/Device/OTG GPIO IrDA I ² S	MTU2 16-bit 6 ch TMR 8-bit 2 ch CMT 16-bit 2 ch I-WDT RTC Calendar
Analog		
Comparator 2 ch ADC 12-bit 14 ch	Temp. Sensor DAC 8-bit (RX111) 12-bit (RX113)	
User Interface	Cap Touch	LCD Control

NEXT-GENERATION POWER MANAGEMENT AND PRECISION ANALOG PRODUCTS

INTERASIL AUTOMOTIVE ICs

ADAS, Infotainment, EV/HEV, and Display Solutions

High performance and precision infotainment, EV/HEV, and display ICs focused on environment, safety, connectivity, and affordability for the automotive market.

Intersil offers both standard and AEC-Q100-qualified products for automotive applications.



ADAS, Infotainment, and Display

Intersil has leveraged its extensive mixed signal video and display processing expertise to create unique and robust IC products specifically tailored to the requirements of the automotive display market.



Automotive Power and Analog

From single to multiple core embedded processors to GPUs and FPGAs, Intersil has a wealth of power experience to deliver versatile and efficient solutions for your next infotainment, navigation, or telematics platform.

AEC-Q100 Qualified



Battery Management

Intersil's automotive grade li-ion Battery Management Solutions (BMS) are specifically designed to meet the stringent safety, reliability, and performance requirements of next-generation electric vehicle applications.

ISL78226

Industry's First 6-Phase Bidirectional PWM Controller Enables Rapid Adoption of 48V Hybrid Powertrains

Intersil's ISL78226 bidirectional controller is designed to perform buck and boost power conversions between 12V and 48V automotive buses. A single automotive-grade ISL78226 delivers up to 3.75kW at greater than 95% conversion efficiency, and is able to interleave in a modular master/slave architecture to deliver higher power.

Key Features

- Master/slave architecture supports up to 4 ICs in parallel
- Average phase-to-phase current balancing and average current output
- Cycle-by-cycle peak current limiting, negative current limiting, and digitally programmable average current limit
- Dual-output flyback controller and 200mA adjustable output linear regulator
- AEC-Q100 Grade-1 qualified for operation from -40°C to +125°C

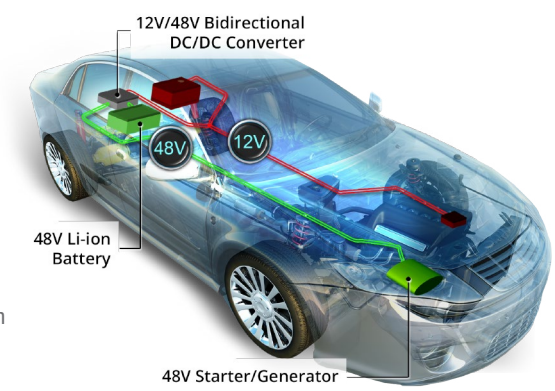

ISL79985

Video Decoder with MIPI-CSI2 Interface Generates Excellent 360-Degree Image Quality for ADAS

Intersil's ISL79985 4-channel video decoder features a MIPI-CSI2 output interface that supports the latest SOCs and ADAS processors, while also lowering the system's EMI profile. The highly integrated decoder replaces up to nine discrete components with a single chip to preserve critical board space.

Key Features

- Four NTSC/PAL/SECAM analog video decoders and 10-bit ADCs with differential and single-ended inputs
- Programmable automotive short diagnostics — short-to-battery and short-to-ground detection — on each differential input channel
- Automatic Contrast Adjustment (ACA) image enhancement feature dynamically optimizes brightness and contrast levels
- Integrated PLL to generate high frequency outputs
- AEC-Q100 Grade-2 qualified for operation from -40°C to +105°C



To learn more, visit: www.intersil.com/automotive

INTERASIL INDUSTRIAL POWER SOLUTIONS

A Complete Power Solution

Intersil offers a complete portfolio of high-performance power solutions for processor, controller, DSP, FPGA, CPLD, DDR memory or other load in your system. Whether you need standard linear regulators, highly flexible PWM controllers, or fully integrated plug-and-play power modules, these products are tailored to meet your design challenges.

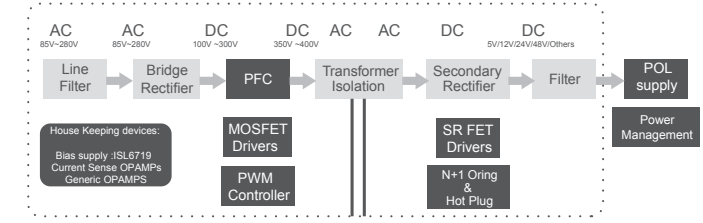

LDOs

- Fast transient response
- Best-in-class $\pm 0.5\%$ initial accuracy and $\pm 1.8\%$ total DC accuracy over full temp range
- Very low dropout (81mV @ 2A typ)
- Best-in-class package power density (Up to 3A per 9mm²)

Switching Regulators

- Complete portfolio
- Robust and reliable
- High integration

Analog Controllers

- Remote sense, Power-Good, Enable, adjustable soft-start
- Extensive protection (OCP, OVP, OTP, SCP)
- Reference tracking, voltage margining
- Pre-biased startup, external compensation
- External frequency synchronization

FPGA Power Solutions

- Xilinx
- Intel (formerly Altera)
- Microsemi
- Lattice

ISL850XX

Highly Integrated 12V Sync Buck Regulator Family

The ISL850xx sync buck regulators support input voltage of 3.8V to 18V and wide output current range, offering designers a complete portfolio of devices with high efficiency and reliable performance.

Large Selection

- Wide output current range
- Pin-compatible products

Robust & Reliable Performance

- Pgood, Enable, adj. soft start
- Extensive protection (OCP, OVP, OTP, SCP)
- External frequency synchronization

High Integration

- Integrated HS/LS FETs
- Internal compensation

Target Applications

- Servers and infrastructure POLs
- Industrial PCs, factory automation, PLCs
- General purpose POLs
- Telecom and networking systems



Part #	V _{IN} Range	I _{OUT}	Package
ISL85014	3.8V to 18V	14A	3.5x3.5 TQFN
ISL85012	3.8V to 18V	12A	3.5x3.5 TQFN
ISL85009	3.8V to 18V	9A	3.5x3.5 TQFN
ISL85005/A	4.5V to 18V	5A	3x4 DFN
ISL85003/A	4.5V to 18V	3A	3x4 DFN

To learn more, visit: www.intersil.com/12v-buck-regulators

PowerCompass Multi-Load Configurator

The PowerCompass™ tool makes product selection easy — quickly find Intersil parts that match your requirements, set up multiple rails if needed, perform high-level system analysis, and generate reference design files.

To learn more, visit: www.intersil.com/powercompass



INTERSIL INFRASTRUCTURE POWER SOLUTIONS

A Complete Power Solution

Intersil's comprehensive portfolio of digital power management DC/DC controllers and power modules are designed to provide best-in-class efficiency and help streamline the design process. Also available are highly integrated isolated and non-isolated solutions that address every stage of the power chain from high-voltage AC input, AC/DC converters, and DC/DC converters and regulators.

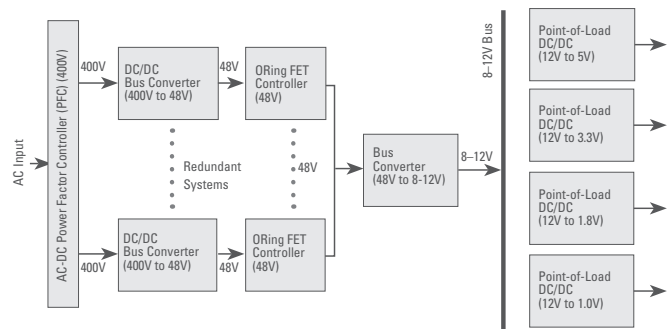

Power Modules

- Simple to design and use
- Power-dense
- Rugged and reliable
- Analog module and digital module

Digital PWM Controllers

- High performance
- Flexible
- Advanced feature sets

Multiphase Controllers

- Flexible phase configuration
- PMBus 1.3 and AVSBus compliant
- Proprietary digital control scheme
- Supports smart power stage

Smart Power Stage

- Integrated current sense
- Integrated drivers and synchronous FETs
- Integrated protection

ISL681XX AND ISL691XX

Next-Generation Digital Multiphase Controllers and Smart Power Stages

Intersil's ISL681xx and ISL691xx digital controllers provide up to seven phases assignable in any combination across two outputs and combine with smart power stages to provide a scalable solution from 10A to 450A. The result is enhanced power optimization and more energy-efficient networking and communications infrastructure equipment.

AVSBUS Interface to Communicate with ARM-based Processors

- General purpose controllers also support network processors, FPGAs, SoCs, and memory

Digital Control Technology for Fast Transient Response and Small Solution Size

- Supports cloud computing applications for the IoT backbone

Flexible Architecture with Smart Power Stages Support All CPU, Memory, and Aux Power Rails

- Customize solutions to meet any power requirements

Target Applications

- Networking equipment
- Telecom/datacom equipment
- Server/storage equipment
- Point-of-load power supply (Memory, DSP, ASIC, FPGA)



Flexible configurations to meet any rail requirements

Application	Dual Output Device	Compatible Interfaces	Output Phase Configuration
AVSBus	ISL68137	PMBus, AVSBus	X+Y ≤ 7
	ISL68134	PMBus, AVSBus	X+Y ≤ 4
General Purpose	ISL68127	PMBus	X+Y ≤ 7
	ISL68124	PMBus	X+Y ≤ 4
SVI2	ISL69147	PMBus, AMD SVI2	X+Y ≤ 7
	ISL69144	PMBus, AMD SVI2	X+Y ≤ 4
IMVP8	ISL69137	PMBus, IMVP8	X+Y ≤ 7
	ISL69134	PMBus, IMVP8	X+Y ≤ 4
IMVP8 & VR13	ISL69128	PMBus, IMVP8/VR13	X+Y ≤ 7
	ISL69127	PMBus, VR13	6+1
VR13	ISL69125	PMBus, VR13	X+Y ≤ 4
	ISL69124	PMBus, VR13	X+Y ≤ 4

To learn more, visit: www.intersil.com/digital-multiphase

INTERSIL PRECISION ANALOG PRODUCTS

High-Performance Solutions for Precision Signal Chain Design

Our broad precision analog portfolio provides for a wide range of next-gen precision instrumentation, medical, communication, and industrial process control applications where innovation, reliability and dependability are central to the analog designs.



Multi-Cell Battery Management (MCB)

Battery Management (MCB)

- Li-ion battery pack monitoring, protection, and balancing IC
- Ideal for packs from 3 to 12 cells; ensures pack safety and long run time
- Built-in fault detection for open-wire, overvoltage, undervoltage, over-temperature, and cell mismatch.

Digital Power Monitors (DPM)

- Simple integrated solution with digital output (I²C) with alerts
- Measures voltage, current (high-side and low-side, bi-directional) and calculates power
- ISL28022/23/25

Interface

- RS-232
- RS-485/422
- Dual protocol (ISL3333xE/5xE)

Precision In-Amps

- Micro-power 5V instrumentation amps down to 60µA
- Various options for low to high gain capability
- Excellent for low-power, sensor modules

Precision Op Amps

- Ultra-low noise, low distortion op amps at 5V and 40V
- 5V and 40V low drift, precision op amps
- Excellent balance of power versus performance

Precision VREF

- Excellent balance of power vs. performance
- Among the industry's best temperature drift and accuracy performances

Real Time Clocks

- High accuracy (low drift) with low parts count
- Power supervisory and backup management functions
- 3-in-1 module — feature-rich RTC with onboard crystal and temperature compensation

Digital Potentiometer

- Non-volatile and volatile
- EEPROM endurance = 1M cycles, retains data for 50 years
- Operate up to 125°C
- 16 to 1024 taps

Switches / Multiplexers

- Up to ±20V supply
- Low R_{ON}
- Low capacitance

Data Converters

- Precision Data Converters
- High-Speed Data Converters

High-Speed Op Amps

- Rail-to-rail voltage feedback amplifiers
- Current feedback amplifiers
- Slew rate enhanced voltage feedback amplifiers

ISL94202

Stand-alone Battery Protection System Accurately Monitors and Balances Rechargeable Battery Packs

The ISL94202 battery pack monitor enables ultra-small two-terminal designs, and accurately monitors, protects, and cell balances rechargeable battery packs to ensure safe operation and charging. The device supports Li-ion and other battery chemistries used in applications such as vacuum cleaners, lawn equipment, handheld power tools, e-bikes, scooters, toys, and energy storage systems.



Stand-alone Battery Management System

- Five pre-programmed stages that accurately control each cell of a battery pack to extend operating life

Programmable Protection and Monitoring Features

- Safeguard battery packs from catastrophic events such as short-circuit conditions and cell voltage shorts

Highest Level of Integration

- Cell voltage level shift, automatic cell balance, 14-bit ADC, current sense monitor, power FET control, temperature sensor interface

Target Applications

- Power tools
- Battery back-up systems
- Light electric vehicles
- Portable equipment

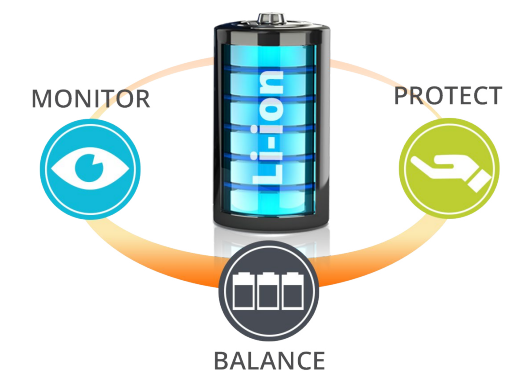

To learn more, visit: www.intersil.com/cellbalancing

SALES OFFICES

Refer to "<http://www.renesas.com/>" for the latest and detailed information.

Renesas Electronics America Inc.

2801 Scott Boulevard Santa Clara, CA 95050-2549, U.S.A.
Tel: +1-408-588-6000, Fax: +1-408-588-6130

Renesas Electronics Canada Limited

9251 Yonge Street, Suite 8309 Richmond Hill, Ontario Canada L4C 9T3
Tel: +1-905-237-2004

Renesas Electronics Europe Limited

Dukes Meadow, Millboard Road, Bourne End, Buckinghamshire, SL8 5FH, U.K
Tel: +44-1628-585-100, Fax: +44-1628-585-900

Renesas Electronics Europe GmbH

Arcadiastrasse 10, 40472 Düsseldorf, Germany
Tel: +49-211-6503-0, Fax: +49-211-6503-1327

Renesas Electronics (China) Co., Ltd.

Room 1709, Quantum Plaza, No.27 ZhiChunLu Haidian District, Beijing 100191, P.R.China
Tel: +86-10-8235-1155, Fax: +86-10-8235-7679

Renesas Electronics (Shanghai) Co., Ltd.

Unit 301, Tower A, Central Towers, 555 Langao Road, Putuo District, Shanghai, P. R. China 200333
Tel: +86-21-2226-0888, Fax: +86-21-2226-0999

Renesas Electronics Hong Kong Limited

Unit 1601-1611, 16/F., Tower 2, Grand Century Place, 193 Prince Edward Road West, Mongkok, Kowloon, Hong Kong
Tel: +852-2265-6688, Fax: +852-2886-9022

Renesas Electronics Taiwan Co., Ltd.

13F, No. 363, Fu Shing North Road, Taipei 10543, Taiwan
Tel: +886-2-8175-9600, Fax: +886-2-8175-9670

Renesas Electronics Singapore Pte. Ltd.

80 Bendemeer Road, Unit #06-02 Hyflux Innovation Centre, Singapore 339949
Tel: +65-6213-0200, Fax: +65-6213-0300

Renesas Electronics Malaysia Sdn Bhd.

Unit 1207, Block B, Menara Amcorp, Amcorp Trade Centre, No. 18, Jln Persiaran Barat, 46050 Petaling Jaya, Selangor Darul Ehsan, Malaysia
Tel: +60-3-7955-9390, Fax: +60-3-7955-9510

Renesas Electronics India Pvt. Ltd.

No.777C, 100 Feet Road, HAL II Stage, Indiranagar, Bangalore, India
Tel: +91-80-67208700, Fax: +91-80-67208777

Renesas Electronics Korea Co., Ltd.

12F., 234 Teheran-ro, Gangnam-Gu, Seoul, 135-080, Korea
Tel: +82-2-558-3737, Fax: +82-2-558-5141