

## TEST REPORT

Test report no.: 1-6565/18-01-02



### Testing laboratory

#### CTC advanced GmbH

Untertuerkheimer Strasse 6 – 10

66117 Saarbruecken / Germany

Phone: + 49 681 5 98 - 0

Fax: + 49 681 5 98 - 9075

Internet: <http://www.ctcadvanced.com>

e-mail: [mail@ctcadvanced.com](mailto:mail@ctcadvanced.com)

#### Accredited Testing Laboratory:

The testing laboratory (area of testing) is accredited according to DIN EN ISO/IEC 17025 (2005) by the Deutsche Akkreditierungsstelle GmbH (DAkkS)

The accreditation is valid for the scope of testing procedures as stated in the accreditation certificate with the registration number: D-PL-12076-01-03

### Applicant

#### Dialog Semiconductor BV

Het Zuiderkruis 53

5215 MV's Hertogenbosch / NETHERLANDS

Phone: -/-

Contact: Steven Leussink

e-mail: [steven.leussink@diasemi.com](mailto:steven.leussink@diasemi.com)

Phone: +31 73 680 22 10

### Manufacturer

#### Dialog Semiconductor BV

Het Zuiderkruis 53

5215 MV's Hertogenbosch / NETHERLANDS

### Test standard/s

ETSI EN 300 328  
V2.1.1

Wideband transmission systems; Data transmission equipment operating in the 2.4 GHz ISM band and using wide band modulation techniques; Harmonised Standard covering the essential requirements of article 3.2 of Directive 2014/53/EU

For further applied test standards please refer to section 3 of this test report.

### Test Item

**Kind of test item:** Single chip Bluetooth solution for wearables

**Model name:** DA14683

**Frequency:** ISM band 2400 MHz to 2483.5 MHz

**Technology tested:** Bluetooth® LE

**Antenna:** Integrated antenna

**Power supply:** 5.0 V DC by USB

**Temperature range:** -40°C to +85°C



This test report is electronically signed and valid without handwritten signature. For verification of the electronic signatures, the public keys can be requested at the testing laboratory.

### Test report authorized:

Joerg Warken  
Lab Manager  
Radio Communications & EMC

### Test performed:

Mihail Dorongovskij  
Lab Manager  
Radio Communications & EMC

## 1 Table of contents

1	Table of contents .....	2
2	General information .....	3
2.1	Notes and disclaimer .....	3
2.2	Application details.....	3
2.3	Test laboratories sub-contracted .....	3
3	Test standard/s .....	4
4	Test environment.....	4
5	Test item.....	5
5.1	General description.....	5
5.2	Additional information .....	5
6	Description of the test setup.....	6
6.1	Shielded fully anechoic chamber .....	7
6.2	Conducted measurements .....	8
7	Summary of measurement results .....	9
8	Additional comments.....	10
9	EUT classification: .....	11
10	Measurement results .....	12
10.1	Antenna gain .....	12
10.2	RF output power .....	13
10.3	Power spectral density.....	14
10.4	Occupied channel bandwidth .....	17
10.5	Transmitter unwanted emissions in the out-of-band domain .....	19
10.6	Transmitter unwanted emissions in the spurious domain.....	21
10.7	Receiver spurious emissions .....	26
10.8	Receiver blocking .....	31
11	Measurement uncertainty.....	34
Annex A	Glossary.....	35
Annex B	Document history .....	36
Annex C	Accreditation Certificate .....	36

## 2 General information

### 2.1 Notes and disclaimer

The test results of this test report relate exclusively to the test item specified in this test report. CTC advanced GmbH does not assume responsibility for any conclusions and generalizations drawn from the test results with regard to other specimens or samples of the type of the equipment represented by the test item.

The test report may only be reproduced or published in full. Reproduction or publication of extracts from the report requires the prior written approval of CTC advanced GmbH.

The testing service provided by CTC advanced GmbH has been rendered under the current "General Terms and Conditions for CTC advanced GmbH".

CTC advanced GmbH will not be liable for any loss or damage resulting from false, inaccurate, inappropriate or incomplete product information provided by the customer.

Under no circumstances does the CTC advanced GmbH test report include any endorsement or warranty regarding the functionality, quality or performance of any other product or service provided.

Under no circumstances does the CTC advanced GmbH test report include or imply any product or service warranties from CTC advanced GmbH, including, without limitation, any implied warranties of merchantability, fitness for purpose, or non-infringement, all of which are expressly disclaimed by CTC advanced GmbH.

All rights and remedies regarding vendor's products and services for which CTC advanced GmbH has prepared this test report shall be provided by the party offering such products or services and not by CTC advanced GmbH. In no case this test report can be considered as a Letter of Approval.

This test report is electronically signed and valid without handwritten signature. For verification of the electronic signatures, the public keys can be requested at the testing laboratory.

### 2.2 Application details

Date of receipt of order:	2018-05-15
Date of receipt of test item:	2018-05-28
Start of test:	2018-05-28
End of test:	2018-05-28
Person(s) present during the test:	-/-

### 2.3 Test laboratories sub-contracted

None

### 3 Test standard/s

Test standard	Date	Description
ETSI EN 300 328 V2.1.1	2016-11	Wideband transmission systems; Data transmission equipment operating in the 2.4 GHz ISM band and using wide band modulation techniques; Harmonised Standard covering the essential requirements of article 3.2 of Directive 2014/53/EU

### 4 Test environment

Temperature	:	$T_{nom}$ $T_{max}$ $T_{min}$	+22 °C during room temperature tests +85 °C during high temperature tests -40 °C during low temperature tests
Relative humidity content	:		55 %
Barometric pressure	:		not relevant for this kind of testing
Power supply	:	$V_{nom}$ $V_{max}$ $V_{min}$	5.0 V DC by USB No tests under extreme voltage conditions required. No tests under extreme voltage conditions required.



## 6 Description of the test setup

Typically, the calibrations of the test apparatus are commissioned to and performed by an accredited calibration laboratory. The calibration intervals are determined in accordance with the DIN EN ISO/IEC 17025. In addition to the external calibrations, the laboratory executes comparison measurements with other calibrated test systems or effective verifications. Weekly chamber inspections and range calibrations are performed. Where possible, RF generating and signaling equipment as well as measuring receivers and analyzers are connected to an external high-precision 10 MHz reference (GPS-based or rubidium frequency standard).

In order to simplify the identification of the equipment used at some special tests, some items of test equipment and ancillaries can be provided with an identifier or number in the equipment list below (Lab/Item).

### **Agenda:** Kind of Calibration

k	calibration / calibrated	EK	limited calibration
ne	not required (k, ev, izw, zw not required)	zw	cyclical maintenance (external cyclical maintenance)
ev	periodic self verification	izw	internal cyclical maintenance
Ve	long-term stability recognized	g	blocked for accredited testing
vlk!	Attention: extended calibration interval		
NK!	Attention: not calibrated	*)	next calibration ordered / currently in progress

## 6.1 Shielded fully anechoic chamber

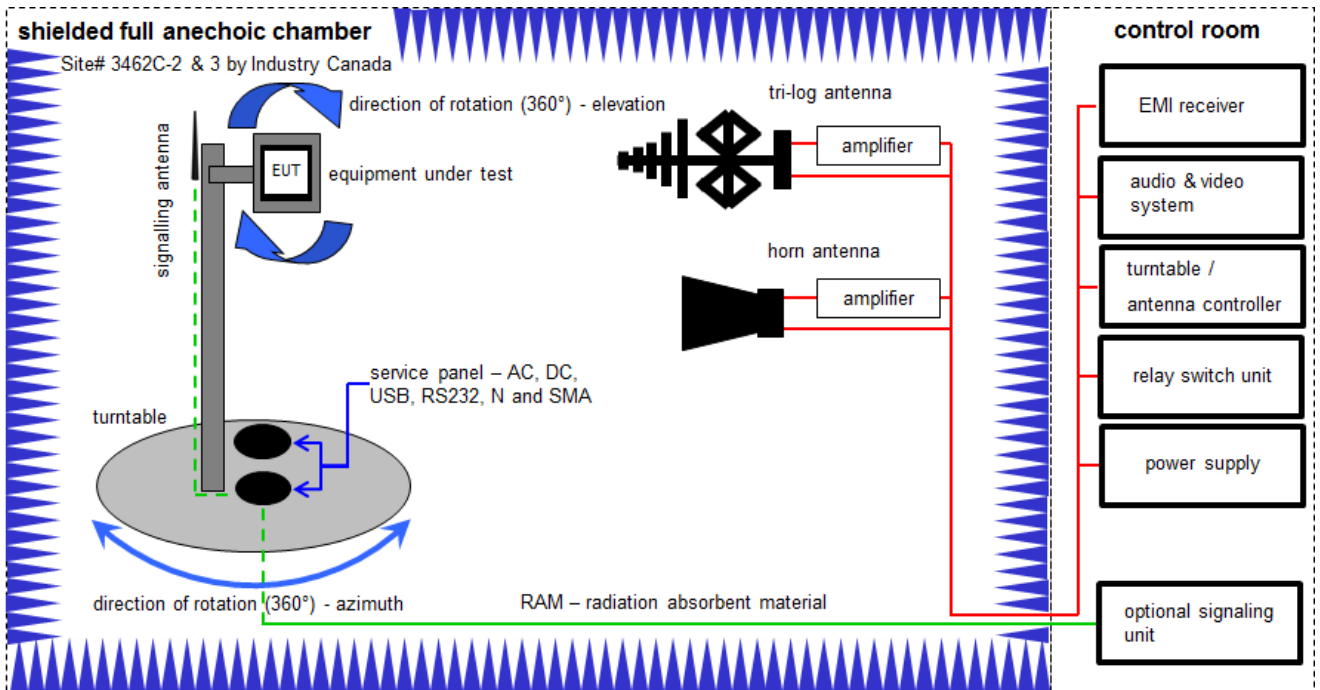

Measurement distance: tri-log antenna and horn antenna 3 meter

$$OP = AV + D - G + CA$$

(OP-radiated output power; AV-analyzer value; D-free field attenuation of measurement distance; G-antenna gain+amplifier gain; CA-loss signal path)

Example calculation:

$$OP \text{ [dBm]} = -65.0 \text{ [dBm]} + 50 \text{ [dB]} - 20 \text{ [dBi]} + 5 \text{ [dB]} = -30 \text{ [dBm]} \text{ (1 } \mu\text{W)}$$

**Equipment table:**

No.	Lab / Item	Equipment	Type	Manufacturer	Serial No.	INV. No.	Kind of Calibration	Last Calibration	Next Calibration
1	A, B	Anechoic chamber	FAC 3/5m	MWB / TDK	87400/02	300000996	ev	-/-	-/-
2	A, B	Double-Ridged Waveguide Horn Antenna 1-18.0GHz	3115	EMCO	9107-3697	300001605	vKII	14.02.2017	13.02.2019
3	A, B	Switch / Control Unit	3488A	HP	*	300000199	ne	-/-	-/-
4	B	Band Reject filter	WRCG2400/2483-2375/2505-50/10SS	Wainwright	11	300003351	ev	-/-	-/-
5	A, B	EMI Test Receiver 20Hz- 26,5GHz	ESU26	R&S	100037	300003555	k	20.12.2017	19.12.2018
6	B	Highpass Filter	WHK1.1/15G-10SS	Wainwright	3	300003255	ev	-/-	-/-
7	B	Highpass Filter	WHKX7.0/18G-8SS	Wainwright	19	300003790	ne	-/-	-/-
8	A, B	Broadband Amplifier 0.5-18 GHz	CBLU5184540	CERNEX	22049	300004481	ev	-/-	-/-
9	B	Broadband Amplifier 5-13 GHz	CBLU5135235	CERNEX	22010	300004491	ev	-/-	-/-
10	A, B	4U RF Switch Platform	L4491A	Agilent Technologies	MY50000037	300004509	ne	-/-	-/-
11	A, B	NEXIO EMV-Software	BAT EMC V3.16.0.49	EMCO		300004682	ne	-/-	-/-
12	A, B	PC	ExOne	F+W		300004703	ne	-/-	-/-
13	B	TRILOG Broadband Test-Antenna	VULB9163	Schwarzbeck Mess Elektronik	01029	300005379	k	07.04.2017	06.04.2020

## 6.2 Conducted measurements

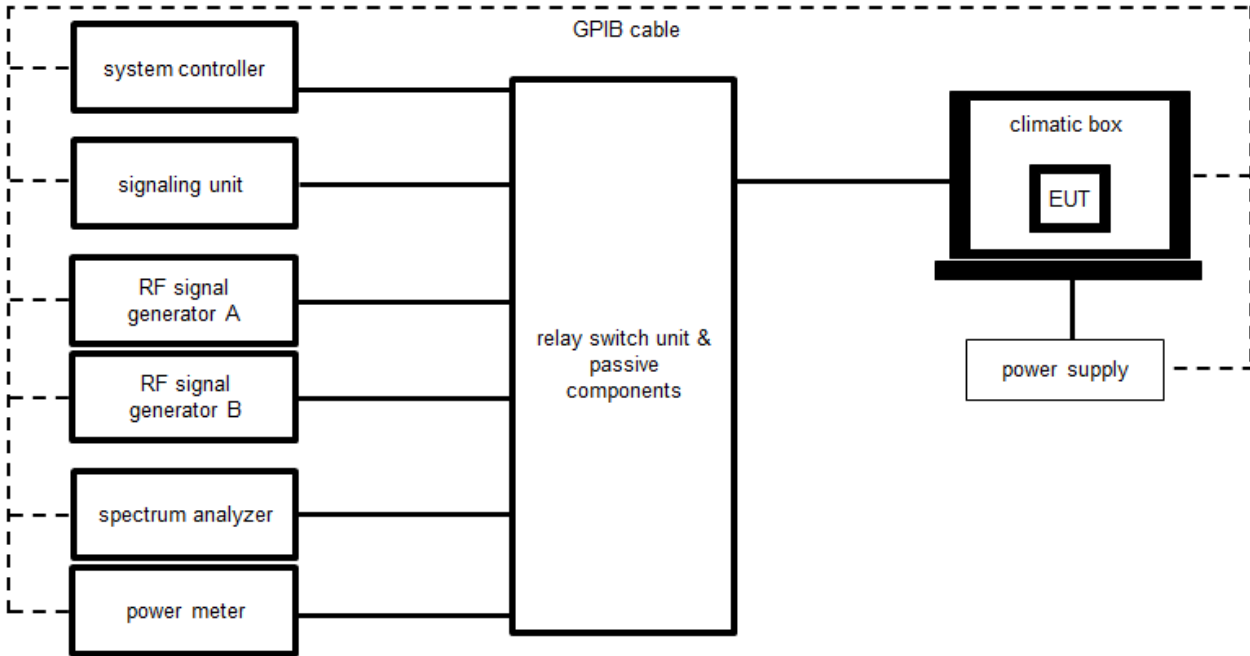

OP = AV + CA  
(OP-output power; AV-analyzer value; CA-loss signal path)

Example calculation:

OP [dBm] = 6.0 [dBm] + 11.7 [dB] = 17.7 [dBm] (58.88 mW)

**Equipment table:**

No.	Lab / Item	Equipment	Type	Manufacturer	Serial No.	INV. No.	Kind of Calibration	Last Calibration	Next Calibration
1	B	Climatic Box	VT 4011	Voetsch Industrietechnik	58566230600010	300005363	ev	01.06.2017	31.05.2019
2	A, B, C	Switch / Control Unit	3488A	HP		300000929	ne	-/-	-/-
3	A, B, C	Directional Coupler	101020010	Krytar	70215	300002840	ev	-/-	-/-
4	A, B, C	DC-Blocker	8143	Inmet Corp.	none	300002842	ne	-/-	-/-
5	A, B, C	Powersplitter	6005-3	Inmet Corp.		300002841	ev	-/-	-/-
6	C	RF and Microwave Signal Generator up to 20 GHz	SMB100A	R&S	176183	300004853	k	09.10.2017	08.10.2020
7	A	Signal Analyzer 30GHz	FSV30	R&S	103170	300004855	k	30.01.2017	29.01.2019
8	B	Open Switch and Control Unit and Power Sensors	OSP120 incl. B157	R&S	101274, 100877	300004825	ne	-/-	-/-
9	A, B, C	RF-Cable	ST18/SMAm/SMAm/48	Huber & Suhner	Batch no. 699866	400001189	ev	-/-	-/-
10	A, B, C	RF-Cable	ST18/SMAm/SMAm/48	Huber & Suhner	Batch no. 14844	400001190	ev	-/-	-/-



## 7 Summary of measurement results

<input checked="" type="checkbox"/>	No deviations from the technical specifications were ascertained
<input type="checkbox"/>	There were deviations from the technical specifications ascertained
<input type="checkbox"/>	This test report is only a partial test report. The content and verdict of the performed test cases are listed below.

TC identifier	Description	verdict	date	Remark
RF-Testing	ETSI EN 300 328 V2.1.1 (2016-11)	See table!	2018-05-30	-/-

Test specification clause	Test case	temperature conditions	power source voltages	Mode	C	NC	NA	NP	Remark
4.3.2.2 5.4.2	RF output power	Nominal	Nominal	GFSK	<input checked="" type="checkbox"/>	<input type="checkbox"/>	<input type="checkbox"/>	<input type="checkbox"/>	-/-
		Low	Nominal	GFSK	<input checked="" type="checkbox"/>	<input type="checkbox"/>	<input type="checkbox"/>	<input type="checkbox"/>	
		High	Nominal	GFSK	<input checked="" type="checkbox"/>	<input type="checkbox"/>	<input type="checkbox"/>	<input type="checkbox"/>	
4.3.2.4 5.4.2	Duty cycle, Tx-sequence, Tx-gap, medium utilization	Nominal	Nominal	-/-	<input type="checkbox"/>	<input type="checkbox"/>	<input checked="" type="checkbox"/>	<input type="checkbox"/>	-/-
4.3.2.3 5.4.3	Power spectral density	Nominal	Nominal	GFSK	<input checked="" type="checkbox"/>	<input type="checkbox"/>	<input type="checkbox"/>	<input type="checkbox"/>	-/-
4.3.1.4 5.4.4	Accumulated transmit time, freq. occupation and hopping sequence	Nominal	Nominal	-/-	<input type="checkbox"/>	<input type="checkbox"/>	<input checked="" type="checkbox"/>	<input type="checkbox"/>	-/-
4.3.1.5 5.4.5	Hopping frequency separation	Nominal	Nominal	-/-	<input type="checkbox"/>	<input type="checkbox"/>	<input checked="" type="checkbox"/>	<input type="checkbox"/>	-/-
4.3.2.6 5.4.6	Adaptivity	Nominal	Nominal	-/-	<input type="checkbox"/>	<input type="checkbox"/>	<input checked="" type="checkbox"/>	<input type="checkbox"/>	-/-
4.3.2.7 5.4.7	Occupied channel bandwidth	Nominal	Nominal	GFSK	<input checked="" type="checkbox"/>	<input type="checkbox"/>	<input type="checkbox"/>	<input type="checkbox"/>	-/-
4.3.2.8 5.4.8	Transmitter unwanted emissions in the out-of-band domain	Nominal	Nominal	GFSK	<input checked="" type="checkbox"/>	<input type="checkbox"/>	<input type="checkbox"/>	<input type="checkbox"/>	-/-
4.3.2.9 5.4.9	Transmitter unwanted emissions in the spurious domain	Nominal	Nominal	GFSK	<input checked="" type="checkbox"/>	<input type="checkbox"/>	<input type="checkbox"/>	<input type="checkbox"/>	-/-
4.3.2.10 5.4.10	Receiver spurious emissions	Nominal	Nominal	GFSK	<input checked="" type="checkbox"/>	<input type="checkbox"/>	<input type="checkbox"/>	<input type="checkbox"/>	-/-
4.3.2.11 5.4.11	Receiver blocking	Nominal	Nominal	GFSK	<input checked="" type="checkbox"/>	<input type="checkbox"/>	<input type="checkbox"/>	<input type="checkbox"/>	-/-
4.3.2.12	Geo-location	Nominal	Nominal	-/-	<input type="checkbox"/>	<input type="checkbox"/>	<input checked="" type="checkbox"/>	<input type="checkbox"/>	-/-

C	Compliant	NC	Not compliant
NA	Not applicable	NP	Not performed

## 8 Additional comments

*The Bluetooth® word mark and logos are owned by the Bluetooth SIG Inc. and any use of such marks by CTC advanced GmbH is under license.*

- Reference documents: Bluetooth® Core Specification (up to 5.0)  
Customer Questionnaire\_1-6565\_18-01 \_SL v1.docx
- Special test descriptions: The tests have been performed with the EUT mounted on an evaluation board.  
The evaluation board is powered by a notebook via USB.  
During the radiated tests, the emission at 100 MHz is caused by the notebook and its power supply.
- Configuration descriptions: TX tests were performed with 255 bytes payload packets and static PRBS pattern payload.  
RX tests were performed with 255 bytes payload packets.
- Test mode:
- Bluetooth direct test mode enabled  
(EUT is controlled via CBT/CMW)
  - Special software is used.  
EUT is transmitting pseudo random data by itself

**9 EUT classification:**

- Type of equipment:
- stand alone equipment
  - plug in radio equipment
  - combined equipment
- Modulation types:
- Wide band modulation (none hopping – e.g. DSSS, OFDM)
  - Frequency hopping spread spectrum (FHSS)
- Adaptive equipment:
- Yes, LBT-based
  - Yes, non-LBT-based
  - Yes (but can be disabled)
  - No
- Antennas and transmission operating modes:
- Operating mode 1 (single antenna)**
    - Equipment with 1 antenna,
    - Equipment with 2 diversity antennas operating in switched diversity mode by which at any moment in time only 1 antenna is used,
    - Smart antenna system with 2 or more transmit/receive chains, but operating in a mode where only 1 transmit/receive chain is used)
  - Operating mode 2 (multiple antennas, no beamforming)**
    - Equipment operating in this mode contains a smart antenna system using two or more transmit/receive chains simultaneously but without beamforming.
  - Operating mode 3 (multiple antennas, with beamforming)**
    - Equipment operating in this mode contains a smart antenna system using two or more transmit/receive chains simultaneously with beamforming. In addition to the antenna assembly gain (G), the beamforming gain (Y) may have to be taken into account when performing the measurements.

## 10 Measurement results

### 10.1 Antenna gain

#### Measurement:

The antenna gain of the system is calculated by the difference of radiated power in EIRP and the conducted power of the module.

Measurement parameters	
Detector	Peak
Sweep time	Auto
Resolution bandwidth	3 MHz
Video bandwidth	3 MHz
Trace mode	Max hold
Test setup	See sub clause 6.2 – A (conducted) See sub clause 6.1 – A (radiated)
Measurement uncertainty	See sub clause 11

#### Limits:

No restriction!

#### Results:

$T_{nom}$	$V_{nom}$	lowest channel	middle channel	highest channel
Conducted peak power [dBm] Measured with GFSK modulation		-0.3	-0.9	-0.6
Radiated peak power [dBm] Measured with GFSK modulation		2.1	1.6	0.7
Gain [dBi] Calculated		2.4	2.5	1.3

## 10.2 RF output power

### Measurement:

The Output power measurement is used to detect the maximum power of a device under test. The measurement is performed according to the EN specification 5.4.2.

### Measurement parameters:

Instrument: Power Meter measuring average burst Power of a least 10 packets

Test setup	See sub clause 6.2 – B
Measurement uncertainty	See sub clause 11

Performed:  Conducted  
 Radiated (only if no conducted sample is provided)

### Limits:

For adaptive equipment	20 dBm
For non-adaptive equipment	Declared by the supplier and shall not exceed 20 dBm

### Results:

Test conditions		Maximum conducted burst power in 10 measured bursts [dBm]		
		lowest channel	middle channel	highest channel
T <sub>nom</sub>	V <sub>nom</sub>	-0.3	-0.9	-0.6
T <sub>min</sub>	V <sub>nom</sub>	0.5	-0.1	0.3
T <sub>max</sub>	V <sub>nom</sub>	-1.0	-1.5	-1.3

**P = max cond. burst power (A) + antenna gain (G) + beamforming gain (Y)**

With:

Beamforming gain (Y) = 0 (SISO)

<b>Result P [dBm] E.I.R.P (lowest channel):</b>	0.5 dBm + 2.4 dBi = 2.9 dBm
<b>Result P [dBm] E.I.R.P (middle channel):</b>	-0.1 dBm + 2.5 dBi = 2.4 dBm
<b>Result P [dBm] E.I.R.P (highest channel):</b>	0.3 dBm + 1.3 dBi = 1.6 dBm

### 10.3 Power spectral density

#### Description:

The power spectral density is the mean equivalent isotropically radiated power (E.I.R.P.) density during a transmission burst.

Measurement parameters	
Detector	RMS
Sweep time	≥ 10s
Resolution bandwidth	10 kHz
Video bandwidth	30 kHz
Span	Start: 2400.00 MHz Stop: 2483.50 MHz
Trace mode	Max hold
Test setup	See sub clause 6.2 - A
Measurement uncertainty	See sub clause 11

Performed:  Conducted  
 Radiated (only if no conducted sample is provided)

#### Limits:

Under normal test conditions only (including antenna gain)	-20 dBW / 1 MHz 10 dBm / 1 MHz
---	-----------------------------------

#### Results:

	Measured power density		
	lowest channel	middle channel	highest channel
1) Power density (max peak) conducted [dBm/1MHz]	-1.9	-2.3	-2.0
2) Sum of all raw points [dBm]	-1.9	-2.3	-2.0
3) Max EIRP [dBm]	2.1	1.6	1.9
4) Correction factor (3-2)	4.0	3.9	3.9
Power density (max peak) radiated (1+4) [dBm/1MHz]	2.1	1.6	1.9

**Plots:**

**Plot 1: lowest channel**

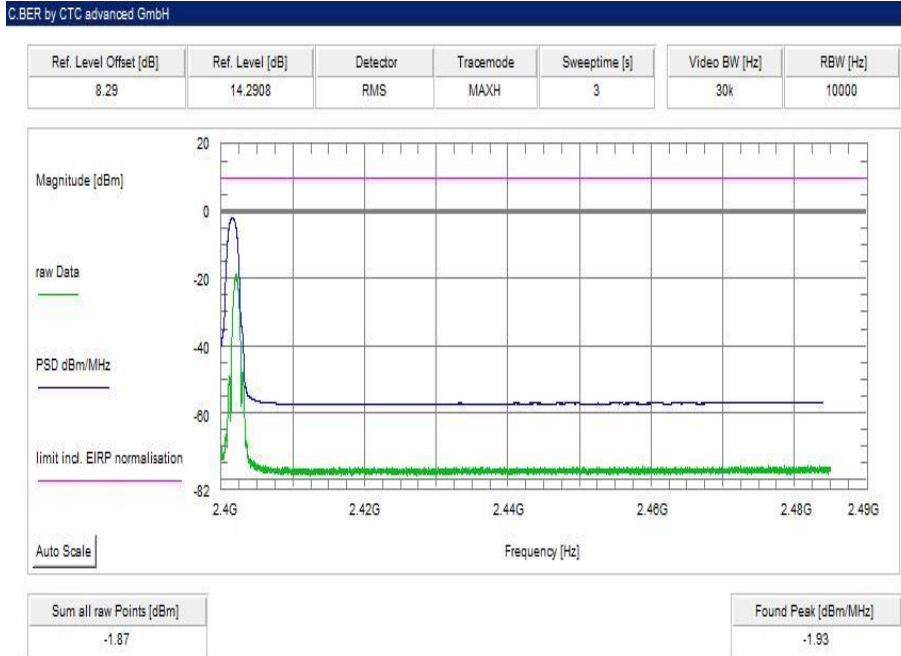

**Plot 2: middle channel**

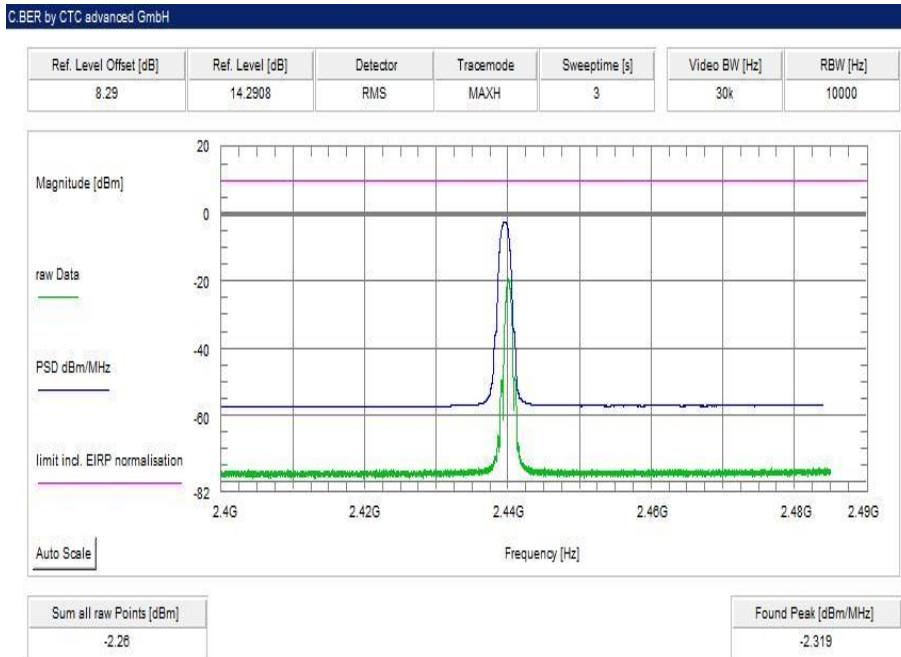

**Plot 3: highest channel**

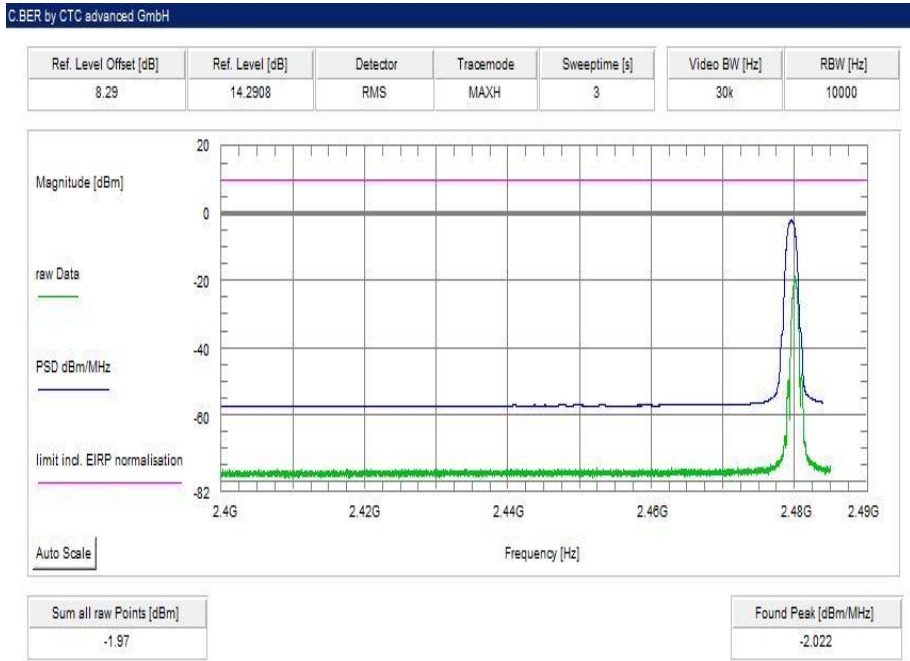



## 10.4 Occupied channel bandwidth

### Measurement:

The occupied channel bandwidth is the bandwidth that contains 99 % of the power of the signal.

Measurement parameters	
Detector	RMS
Sweep time	1s
Resolution bandwidth	30 kHz
Video bandwidth	100 kHz
Span	3 MHz
Trace mode	Max hold
Test setup	See sub clause 6.2 - A
Measurement uncertainty	See sub clause 11

Performed:  Conducted  
 Radiated (only if no conducted sample is provided)

### Limits:

The occupied channel bandwidth shall fall completely within the band.

For non-adaptive systems using wide band modulations other than FHSS and with e.i.r.p greater than 10 dBm, the occupied channel bandwidth shall be less than 20 MHz.

### Results:

99% bandwidth [kHz]	
Lowest channel	Highest channel
1053	1047

**Plots:**

**Plot 1: GFSK modulation, lowest channel**

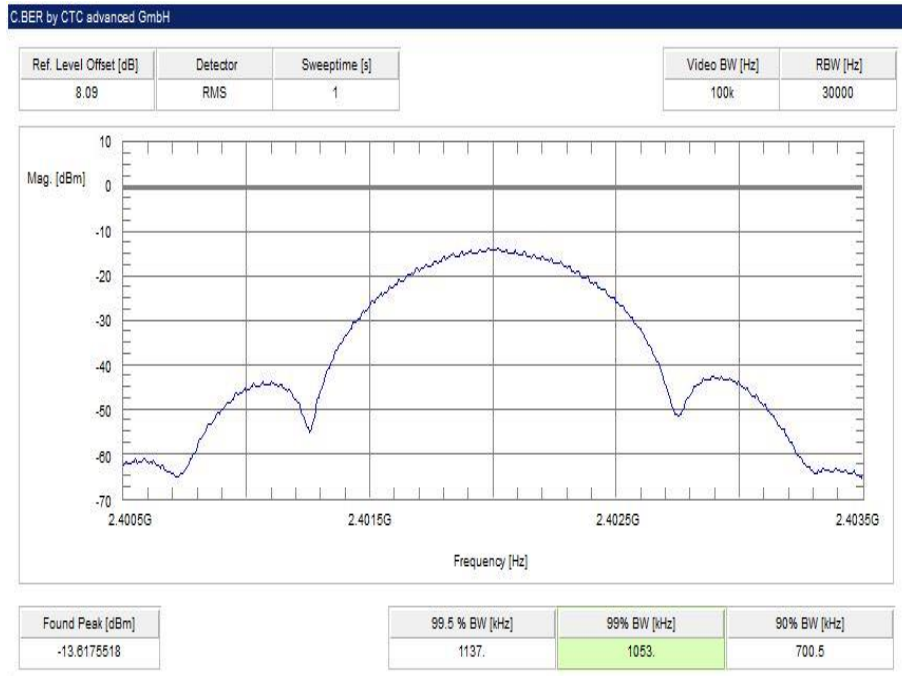

**Plot 2: GFSK modulation, highest channel**

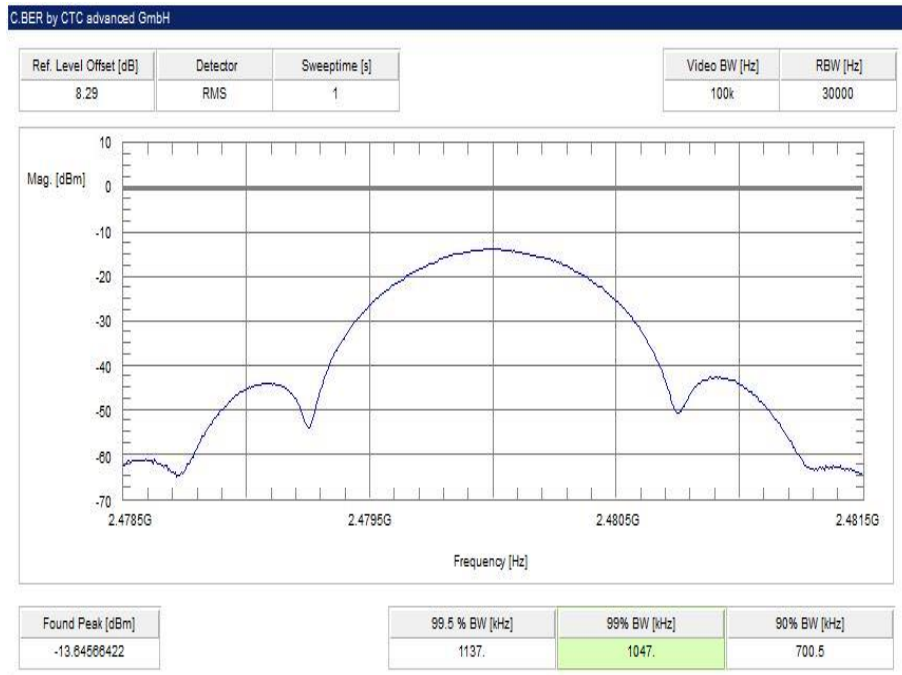

## 10.5 Transmitter unwanted emissions in the out-of-band domain

### Description:

Transmitter unwanted emissions in the out-of-band domain are emissions when the equipment is in transmit mode, on frequencies immediately outside the necessary bandwidth which results from the modulation process, but excluding spurious.

Measurement parameters	
Detector	RMS
Sweep time	depending on packet length (min 120% of packet length)
Resolution bandwidth	1 MHz
Video bandwidth	3 MHz
Span	Zero span
Trace mode	Video trigger
Test setup	See sub clause 6.2 - A
Measurement uncertainty	See sub clause 11

Performed:  Conducted  
 Radiated (only if no conducted sample is provided)

### Limits:

The transmitter unwanted emissions in the out-of-band domain but outside the allocated band, shall not exceed the values provided by the mask.

NOTE: Within the 2400 MHz to 2483.5 MHz band, the Out-of-band emissions are fulfilled by compliance with the Occupied Channel Bandwidth requirement in clause 4.3.2.6.

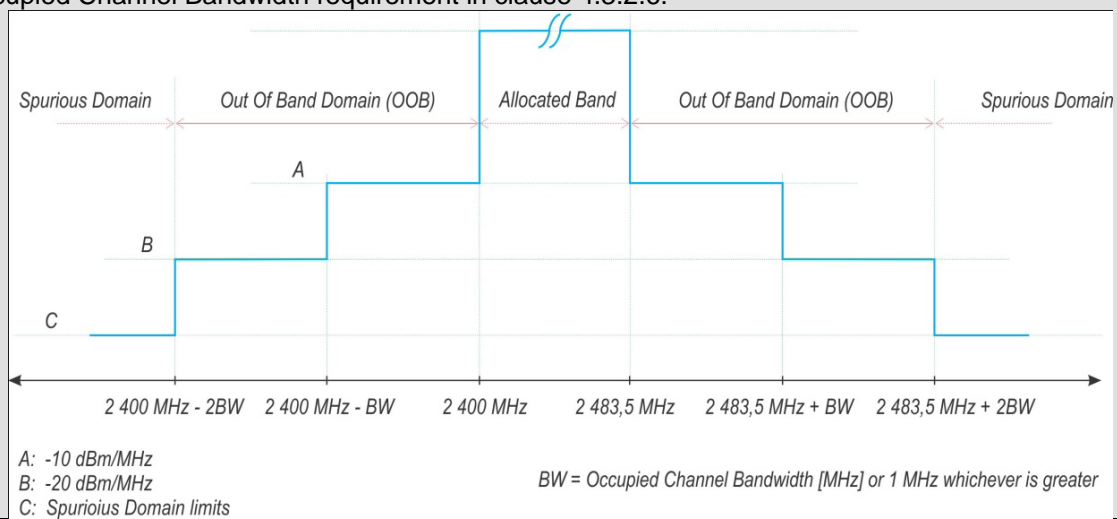

**Results**

Unwanted emissions [dBm] (including antenna gain)	
<b>GFSK, channel BW see plots</b>	
2400 MHz - 2BW to 2400 MHz – BW Limit: < -20dBm/MHz	compliant
2400 MHz - BW to 2400 MHz Limit: < -10dBm/MHz	compliant
2483.5 MHz to 2483.5 MHz + BW Limit: < -10dBm/MHz	compliant
2483.5 MHz + BW to 2483.5 MHz + 2BW Limit: < -20dBm/MHz	compliant

**Plots:**

**Plot 1:**

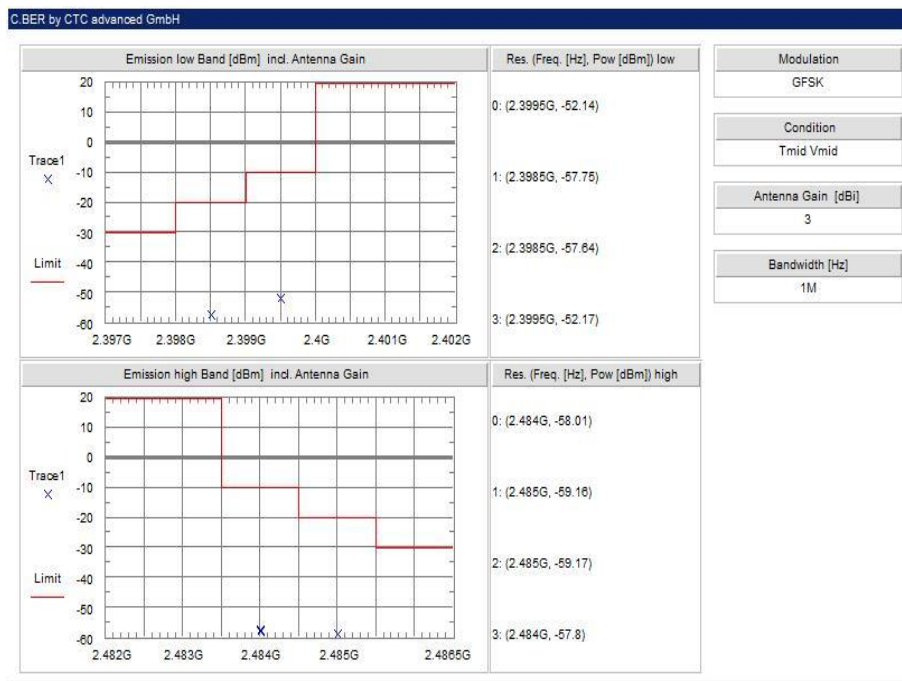

## 10.6 Transmitter unwanted emissions in the spurious domain

### Description:

Transmitter unwanted emissions in the spurious domain are emissions outside the allocated band and outside the out-of-band domain when the equipment is in transmit mode.

### Pre-scan:

Measurement parameters	
Detector	Peak
Sweep time	1s
Resolution bandwidth	Below 1 GHz: 100 kHz / above 1MHz
Video bandwidth	Below 1 GHz: 300 kHz / above 3MHz
Trace mode	Max hold
Test setup	See sub clause 6.2 – A (conducted) See sub clause 6.1 – B (radiated)
Measurement uncertainty	See sub clause 11

Any emissions identified during the sweeps in the pre-scan and that fall within the 6 dB range below the applicable limit, shall be individually measured using the procedure “retest”.

### Retest:

Measurement parameters	
Detector	RMS
Measurement mode	Time domain power
Sweep time	500ms
Resolution bandwidth	Below 1 GHz: 100 kHz / above 1MHz
Video bandwidth	Below 1 GHz: 300 kHz / above 3MHz
Span	Zero span
Trace mode	Single sweep
Test setup	See sub clause 6.2 – A (conducted) See sub clause 6.1 – B (radiated)
Measurement uncertainty	See sub clause 11

Performed:  Conducted  
 Radiated

### Limits:

State	Max. spurious level		
	47 MHz to 74 MHz 87.5 MHz to 118 MHz 174 MHz to 230 MHz 470 MHz to 862 MHz	Other frequencies ≤ 1000 MHz	All frequencies > 1000 MHz
Operating	4.0 nW (-54 dBm)	250 nW (-36 dBm)	1.00 µW (-30 dBm)
Receiver / Idle	2.0 nW (-57 dBm)	2.0 nW (-57 dBm)	20.0 nW (-47 dBm)

**Results:** conducted

lowest channel			highest channel		
f [MHz]	Detector Peak/RMS	Level [dBm]	f [MHz]	Detector Peak/RMS	Level [dBm]
4804	Peak	-35.8	All detected peaks are more than 6 dB below the limit		
4804	TDP burst	-38.7			

**Plots:**

**Plot 1: GFSK, lowest channel, positive peak**

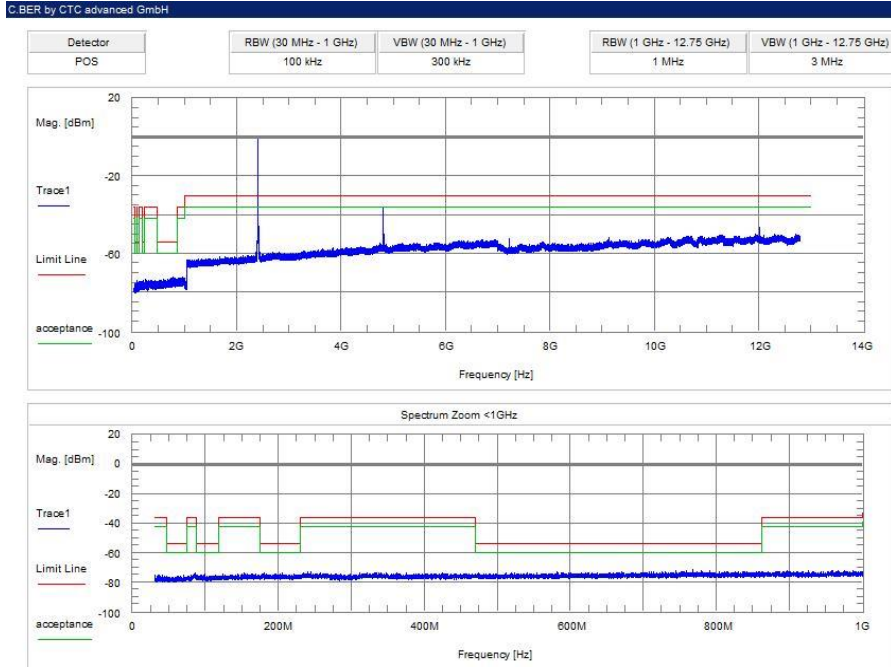

**Plot 2: GFSK, highest channel, positive peak**

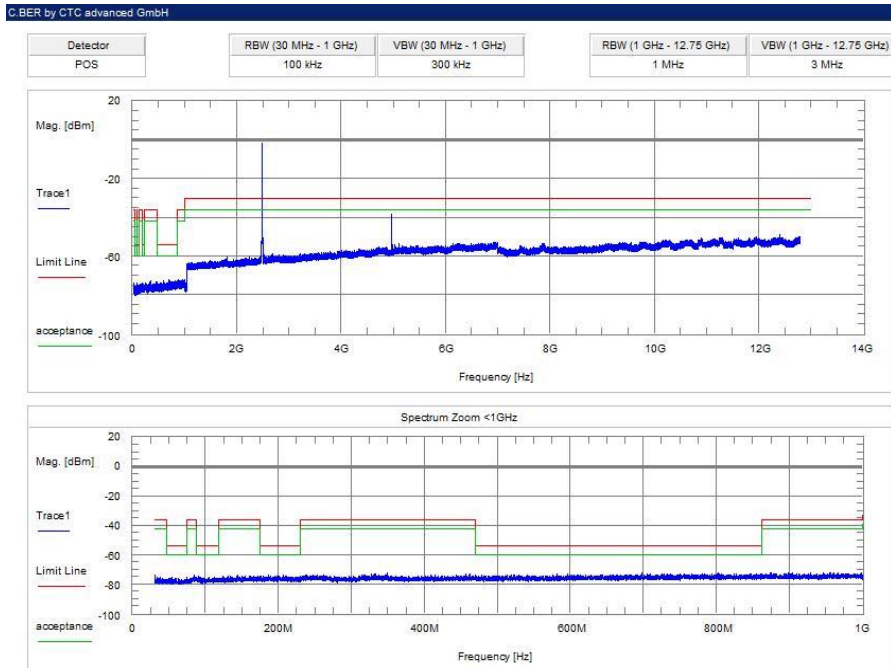

**Results:** radiated

lowest channel			highest channel		
f [MHz]	Detector Peak/RMS	Level [dBm]	f [MHz]	Detector Peak/RMS	Level [dBm]
All detected peaks are more than 6 dB below the limit			All detected peaks are more than 6 dB below the limit		

NOTE: The emission at 100 MHz is caused by the notebook and its power supply



**Plots:**

**Plot 1:** 30 MHz to 12.75 GHz, lowest channel

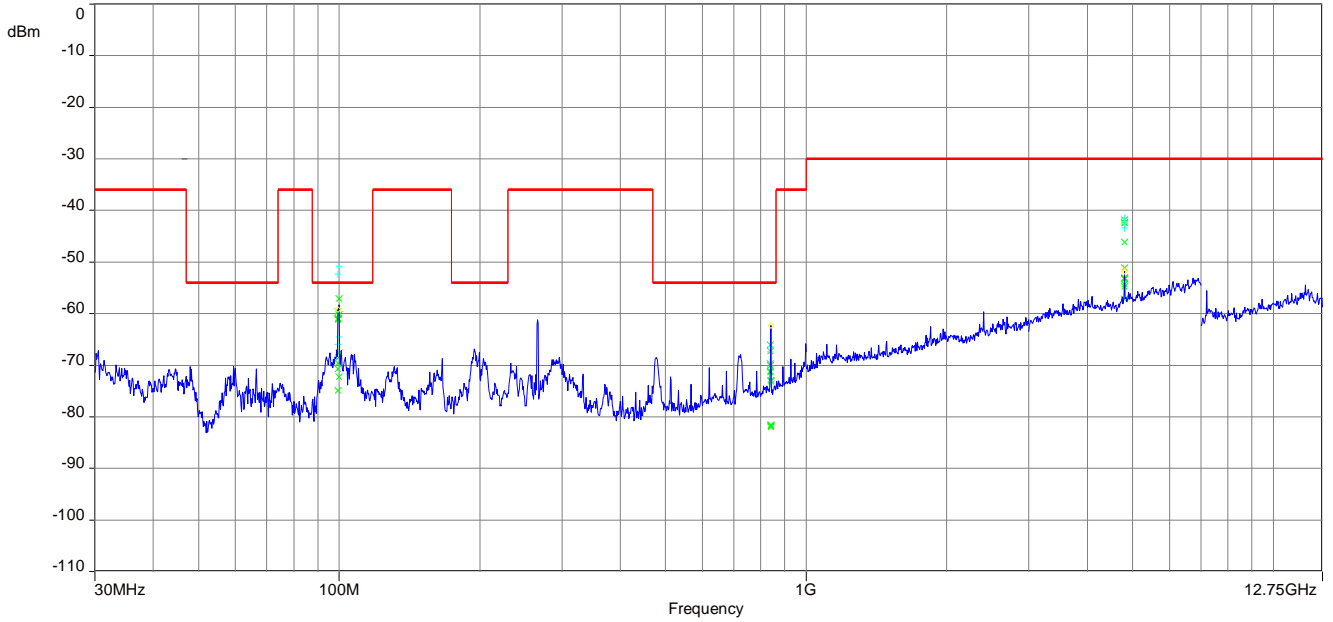

The carrier signal is notched with a 2.4 GHz band rejection filter.

**Plot 2:** 30 MHz to 12.75 GHz, highest channel

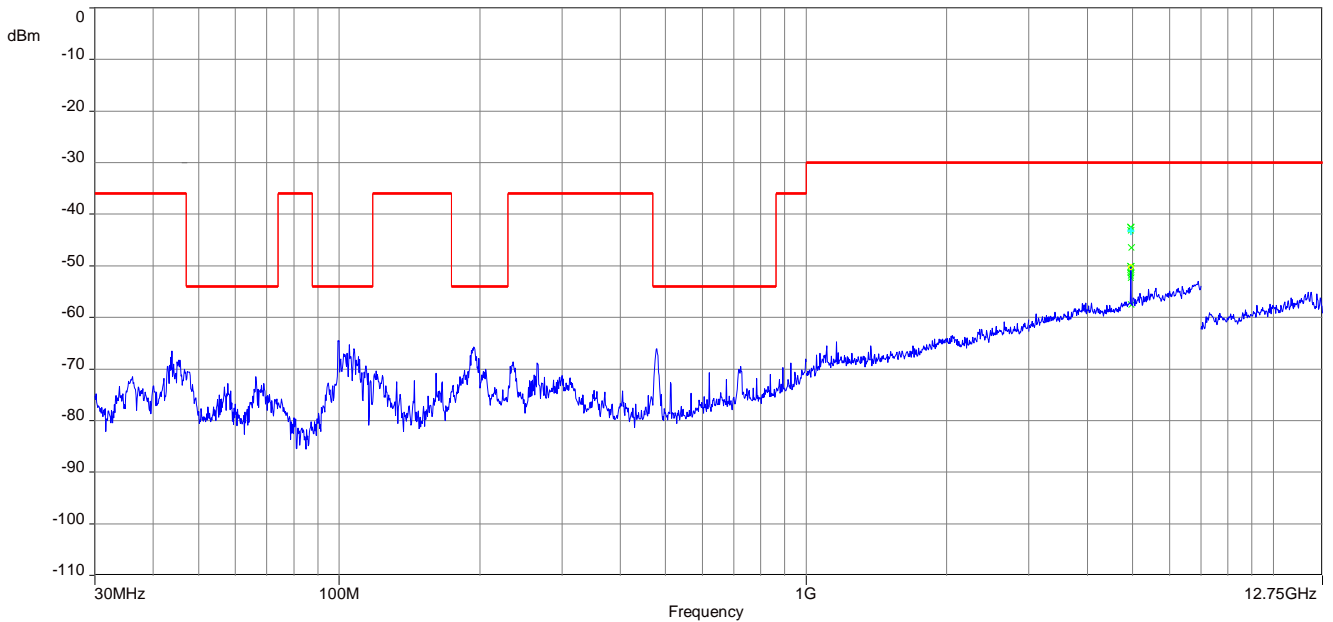

The carrier signal is notched with a 2.4 GHz band rejection filter.

## 10.7 Receiver spurious emissions

### Description:

Receiver/idle unwanted emissions in the spurious domain are emissions outside the allocated band and outside the out-of-band domain when the equipment is in receiver/idle mode.

### Pre-scan:

Measurement parameters	
Detector	Peak
Sweep time	1s
Resolution bandwidth	Below 1 GHz: 100 kHz / above 1MHz
Video bandwidth	Below 1 GHz: 300 kHz / above 3MHz
Trace mode	Max hold
Test setup	See sub clause 6.2 – A (conducted) See sub clause 6.1 – A (radiated)
Measurement uncertainty	See sub clause 11

Any emissions identified during the sweeps in the pre-scan and that fall within the 6 dB range below the applicable limit, shall be individually measured using the procedure “retest”.

### Retest:

Measurement parameters	
Detector	RMS
Measurement mode	Time domain power
Sweep time	30ms
Resolution bandwidth	Below 1 GHz: 100 kHz / above 1MHz
Video bandwidth	Below 1 GHz: 300 kHz / above 3MHz
Span	Zero span
Trace mode	Single sweep
Test setup	See sub clause 6.2 – A (conducted) See sub clause 6.1 – A (radiated)
Measurement uncertainty	See sub clause 11

Performed:  Conducted  
 Radiated

**Limits:**

State	Max. spurious level		
	47 MHz to 74 MHz 87,5 MHz to 118 MHz 174 MHz to 230 MHz 470 MHz to 862 MHz	Other frequencies ≤ 1000 MHz	All frequencies > 1000 MHz
Operating	4.0 nW (-54 dBm)	250 nW (-36 dBm)	1.00 µW (-30 dBm)
Receiver/idle	2.0 nW (-57 dBm)	2.0 nW (-57 dBm)	20.0 nW (-47 dBm)

**Results:** conducted

lowest channel			highest channel		
f [MHz]	Detector Peak/RMS	Level [dBm]	f [MHz]	Detector Peak/RMS	Level [dBm]
All detected peaks are more than 6 dB below the limit			All detected peaks are more than 6 dB below the limit		

**Plots:**

**Plot 1:** Receiver, 30 MHz to 12.75 GHz, lowest channel

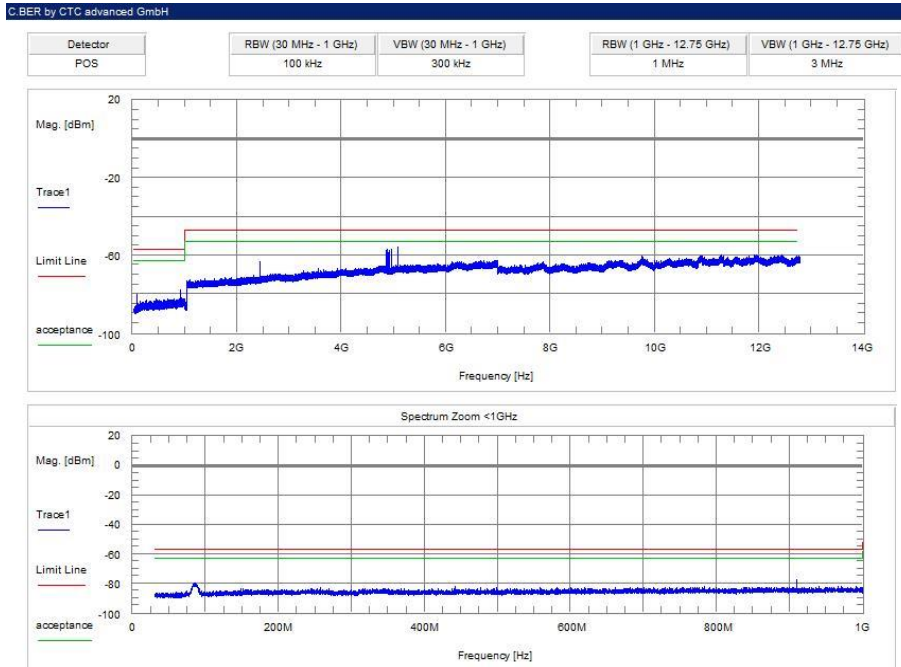

**Plot 2:** Receiver, 30 MHz to 12.75 GHz, highest channel

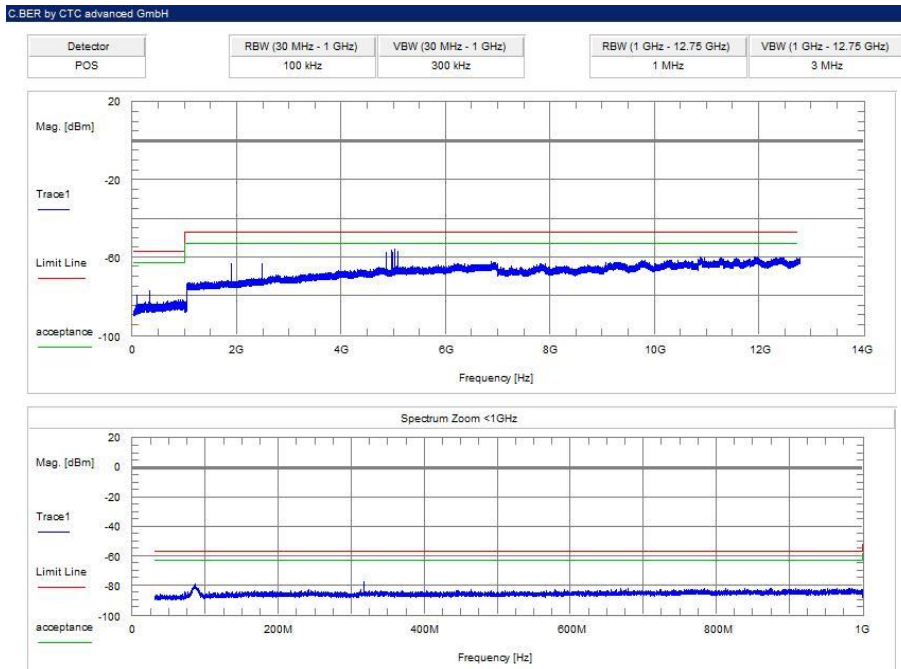

**Results:** radiated

lowest channel			highest channel		
f [MHz]	Detector Peak/RMS	Level [dBm]	f [MHz]	Detector Peak/RMS	Level [dBm]
266	Peak	-62.1	4962	Peak	-43.9
266	RMS time domain power	-70.3	4962	RMS time domain power	-50.4
4806	Peak	-45.2			
4806	RMS time domain power	-51.7			

NOTE: The emission at 100 MHz is caused by the notebook and its power supply

**Plots:**

**Plot 1:** Receiver, 30 MHz to 12.75 GHz, lowest channel

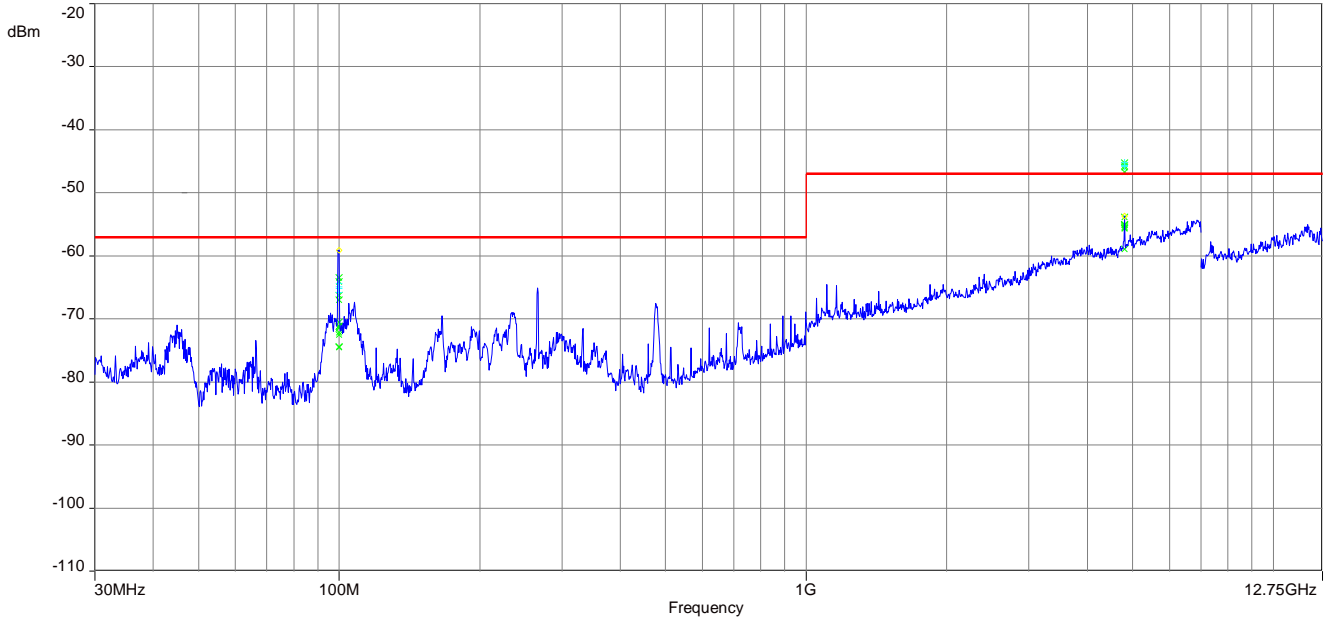

**Plot 2:** Receiver, 30 MHz to 12.75 GHz, highest channel

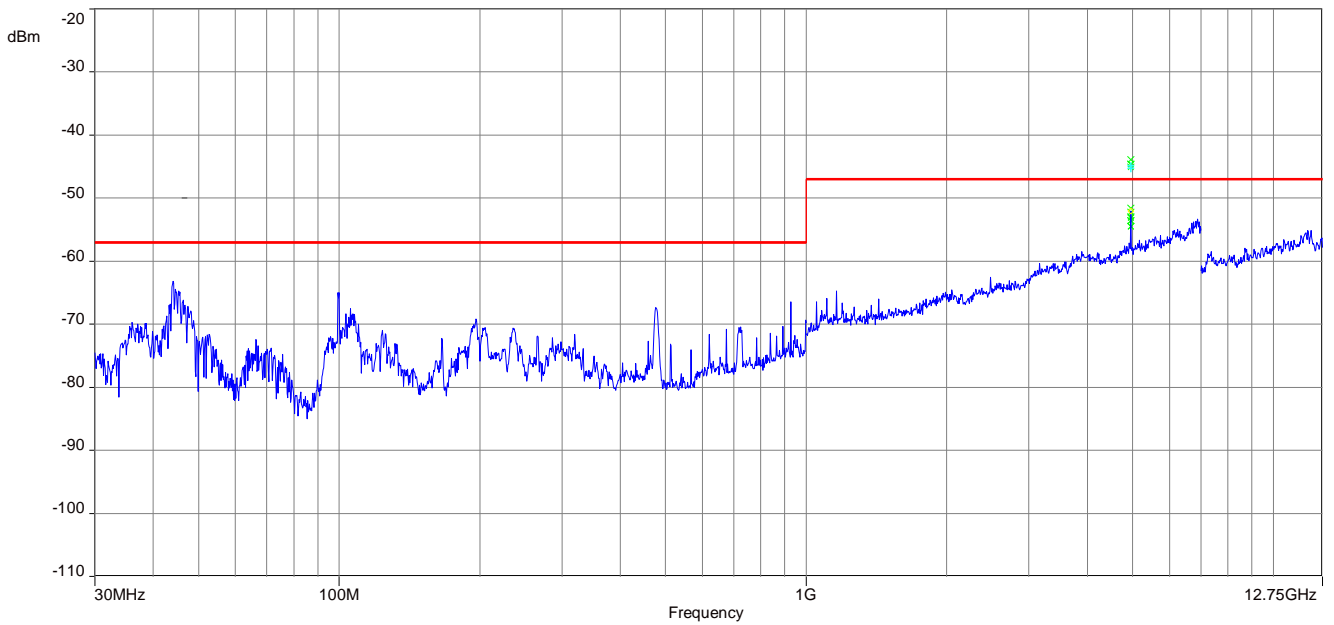

## 10.8 Receiver blocking

### Description:

Receiver blocking is a measure of the ability of the equipment to receive a wanted signal on its operating channel without exceeding a given degradation in the presence of an unwanted signal (blocking signal) on frequencies other than those of the operating band.

The CBT is used as the signalling unit. Starting at a typical high signalling level (e.g. -70.0 dBm) the CBT is sending packets to the EUT. The PER is logged and the signalling level gets reduced in 1 dB steps until the PER is higher than 10%. This is the  $P_{min}$  value which is used as described in tables 1-3 depending on the receiver category of the EUT.

Measurement parameters	
Test setup	See sub clause 6.2 – C
Measurement uncertainty	See sub clause 11

Performed:  Conducted

Radiated

**Table 1:** Receiver blocking parameters for receiver category 1 equipment:

Wanted signal mean power from companion device (dBm)	Blocking signal frequency (MHz)	Blocking signal power (dBm) (see note 2)	Type of blocking signal
$P_{min} + 6$ dB	2 380.0 2 503.5	-53	CW
$P_{min} + 6$ dB	2 300.0 2 330.0 2 360.0	-47	CW
$P_{min} + 6$ dB	2 523.5 2 553.5 2 583.5 2 613.5 2 643.5 2 673.5	-47	CW
NOTE 1:	$P_{min}$ is the minimum level of wanted signal (in dBm) required to meet the minimum performance criteria as defined in clause 4.3.1.12.3 in the absence of any blocking signal.		
NOTE 2:	The levels specified are levels in front of the UUT antenna. In case of conducted measurements, the levels have to be corrected by the actual antenna assembly gain.		

**Table 2:** Receiver blocking parameters for receiver category 2 equipment:

Wanted signal mean power from companion device (dBm)	Blocking signal frequency (MHz)	Blocking signal power (dBm) (see note 2)	Type of blocking signal
$P_{\min} + 6$ dB	2 380.0 2 503.5	-57	CW
$P_{\min} + 6$ dB	2 300.0 2 583.5	-47	CW
NOTE 1:	$P_{\min}$ is the minimum level of wanted signal (in dBm) required to meet the minimum performance criteria as defined in clause 4.3.1.12.3 in the absence of any blocking signal.		
NOTE 2:	The levels specified are levels in front of the UUT antenna. In case of conducted measurements, the levels have to be corrected by the actual antenna assembly gain.		

**Table 3:** Receiver blocking parameters for receiver category 3 equipment:

Wanted signal mean power from companion device (dBm)	Blocking signal frequency (MHz)	Blocking signal power (dBm) (see note 2)	Type of blocking signal
$P_{\min} + 12$ dB	2 380.0 2 503.5	-57	CW
$P_{\min} + 12$ dB	2 300.0 2 583.5	-47	CW
NOTE 1:	$P_{\min}$ is the minimum level of wanted signal (in dBm) required to meet the minimum performance criteria as defined in clause 4.3.1.12.3 in the absence of any blocking signal.		
NOTE 2:	The levels specified are levels in front of the UUT antenna. In case of conducted measurements, the levels have to be corrected by the actual antenna assembly gain.		

**Limits:**

	Channel	
	Lowest channel	Highest channel
Packet error rate limit	10% PER*	

\*The manufacturer may declare alternative performance criteria as long as that is appropriate for the intended use of the equipment



**Results:** Tests according requirements for category 2 receiver equipment

RX chan.....	PER.....	Psent...	Prec....	RXL[dBm]..	Limit...	IntFr. [MHz]..	IntL [dBm]..	verdict
2402000000	1.000%	1500	1485	-75	<= 10%	OFF	OFF	PASS
2402000000	1E-00%	1500	1500	-76	<= 10%	OFF	OFF	PASS
2402000000	1E-00%	1500	1500	-77	<= 10%	OFF	OFF	PASS
2402000000	1E-00%	1500	1500	-78	<= 10%	OFF	OFF	PASS
2402000000	1E-00%	1500	1500	-79	<= 10%	OFF	OFF	PASS
2402000000	1E-00%	1500	1500	-80	<= 10%	OFF	OFF	PASS
2402000000	1E-00%	1500	1500	-81	<= 10%	OFF	OFF	PASS
2402000000	0.066%	1500	1499	-82	<= 10%	OFF	OFF	PASS
2402000000	0.400%	1500	1494	-83	<= 10%	OFF	OFF	PASS
2402000000	0.266%	1500	1496	-84	<= 10%	OFF	OFF	PASS
2402000000	3.066%	1500	1454	-85	<= 10%	OFF	OFF	PASS
2402000000	1.599%	1500	1476	-86	<= 10%	OFF	OFF	PASS
2402000000	2.466%	1500	1463	-87	<= 10%	OFF	OFF	PASS
2402000000	2.600%	1500	1461	-88	<= 10%	OFF	OFF	PASS
2402000000	5.000%	1500	1425	-89	<= 10%	OFF	OFF	PASS
2402000000	9.666%	1500	1355	-90	<= 10%	OFF	OFF	PASS
2402000000	23.79%	1500	1143	-91	<= 10%	OFF	OFF	Ref.
								Sensitivity
2402000000	1E-00%	1500	1500	-85	<= 10%	2380.0	-57	PASS
2402000000	1E-00%	1500	1500	-85	<= 10%	2503.5	-57	PASS
2402000000	1E-00%	1500	1500	-85	<= 10%	2300.5	-47	PASS
2402000000	1E-00%	1500	1500	-85	<= 10%	2583.5	-47	PASS
2480000000	1E-00%	1500	1500	-75	<= 10%	OFF	OFF	PASS
2480000000	1E-00%	1500	1500	-76	<= 10%	OFF	OFF	PASS
2480000000	1E-00%	1500	1500	-77	<= 10%	OFF	OFF	PASS
2480000000	1E-00%	1500	1500	-78	<= 10%	OFF	OFF	PASS
2480000000	1E-00%	1500	1500	-79	<= 10%	OFF	OFF	PASS
2480000000	1E-00%	1500	1500	-80	<= 10%	OFF	OFF	PASS
2480000000	1E-00%	1500	1500	-81	<= 10%	OFF	OFF	PASS
2480000000	1E-00%	1500	1500	-82	<= 10%	OFF	OFF	PASS
2480000000	1E-00%	1500	1500	-83	<= 10%	OFF	OFF	PASS
2480000000	1E-00%	1500	1500	-84	<= 10%	OFF	OFF	PASS
2480000000	0.599%	1500	1491	-85	<= 10%	OFF	OFF	PASS
2480000000	1.066%	1500	1484	-86	<= 10%	OFF	OFF	PASS
2480000000	0.466%	1500	1493	-87	<= 10%	OFF	OFF	PASS
2480000000	2.933%	1500	1456	-88	<= 10%	OFF	OFF	PASS
2480000000	5.000%	1500	1425	-89	<= 10%	OFF	OFF	PASS
2480000000	13.00%	1500	1305	-90	<= 10%	OFF	OFF	Ref.
								Sensitivity
2480000000	1E-00%	1500	1500	-84	<= 10%	2380.0	-57	PASS
2480000000	1E-00%	1500	1500	-84	<= 10%	2503.5	-57	PASS
2480000000	0.066%	1500	1499	-84	<= 10%	2300.5	-47	PASS
2480000000	0.066%	1500	1499	-84	<= 10%	2583.5	-47	PASS

**11 Measurement uncertainty**

<b>Measurement uncertainty</b>	
Occupied channel bandwidth	±5 %
RF output power, conducted	±1.5 dB
Power spectral density, conducted	±3 dB
Unwanted emissions, conducted	±3 dB
All emissions, radiated	±3 dB
Temperature	±1 °C
Humidity	±5 %
DC and low frequency voltages	±3 %
Time	±5 %
Duty cycle	±5 %

## Annex A Glossary

<b>EUT</b>	Equipment under test
<b>DUT</b>	Device under test
<b>UUT</b>	Unit under test
<b>GUE</b>	GNSS User Equipment
<b>ETSI</b>	European Telecommunications Standards Institute
<b>EN</b>	European Standard
<b>FCC</b>	Federal Communications Commission
<b>FCC ID</b>	Company Identifier at FCC
<b>IC</b>	Industry Canada
<b>PMN</b>	Product marketing name
<b>HMN</b>	Host marketing name
<b>HVIN</b>	Hardware version identification number
<b>FVIN</b>	Firmware version identification number
<b>EMC</b>	Electromagnetic Compatibility
<b>HW</b>	Hardware
<b>SW</b>	Software
<b>Inv. No.</b>	Inventory number
<b>S/N or SN</b>	Serial number
<b>C</b>	Compliant
<b>NC</b>	Not compliant
<b>NA</b>	Not applicable
<b>NP</b>	Not performed
<b>PP</b>	Positive peak
<b>QP</b>	Quasi peak
<b>AVG</b>	Average
<b>OC</b>	Operating channel
<b>OCW</b>	Operating channel bandwidth
<b>OBW</b>	Occupied bandwidth
<b>OOB</b>	Out of band
<b>DFS</b>	Dynamic frequency selection
<b>CAC</b>	Channel availability check
<b>OP</b>	Occupancy period
<b>NOP</b>	Non occupancy period
<b>DC</b>	Duty cycle
<b>PER</b>	Packet error rate
<b>CW</b>	Clean wave
<b>MC</b>	Modulated carrier
<b>WLAN</b>	Wireless local area network
<b>RLAN</b>	Radio local area network
<b>DSSS</b>	Dynamic sequence spread spectrum
<b>OFDM</b>	Orthogonal frequency division multiplexing
<b>FHSS</b>	Frequency hopping spread spectrum
<b>GNSS</b>	Global Navigation Satellite System
<b>C/N<sub>0</sub></b>	Carrier to noise-density ratio, expressed in dB-Hz

**Annex B Document history**

Version	Applied changes	Date of release
-/-	Initial release	2018-05-30

**Annex C Accreditation Certificate**

first page	last page
 <p>Deutsche Akkreditierungsstelle GmbH</p> <p>Entrusted according to Section 8 subsection 1 AkkStelleG in connection with Section 1 subsection 1 AkkStelleGBV Signatory to the Multilateral Agreements of EA, ILAC and IAF for Mutual Recognition</p> <p><b>Accreditation</b> </p> <p>The Deutsche Akkreditierungsstelle GmbH attests that the testing laboratory <b>CTC advanced GmbH</b> Untertürkheimer Straße 6-10, 66117 Saarbrücken</p> <p>is competent under the terms of DIN EN ISO/IEC 17025:2005 to carry out tests in the following fields: <b>Telecommunication</b></p> <p>The accreditation certificate shall only apply in connection with the notice of accreditation of 02.06.2017 with the accreditation number D-PL-12076-01 and is valid until 21.04.2021. It comprises the cover sheet, the reverse side of the cover sheet and the following annex with a total of 43 pages.</p> <p>Registration number of the certificate: <b>D-PL-12076-01-03</b></p> <p>Frankfurt, 02.06.2017</p> <p> Dipl.-Ing. (FH) Ralf Böber Head of Division</p> <p><small>See notes enclosed.</small></p>	<p>Deutsche Akkreditierungsstelle GmbH</p> <p>Office Berlin Spittelmarkt 10 10117 Berlin</p> <p>Office Frankfurt am Main Europa-Allee 52 60327 Frankfurt am Main</p> <p>Office Braunschweig Bundesallee 100 38116 Braunschweig</p> <p>The publication of extracts of the accreditation certificate is subject to the prior written approval by Deutsche Akkreditierungsstelle GmbH (DAkKS). Exempted is the unchanged form of separate disseminations of the cover sheet by the conformity assessment body mentioned overleaf.</p> <p>No impression shall be made that the accreditation also extends to fields beyond the scope of accreditation attested by DAkKS.</p> <p>The accreditation was granted pursuant to the Act on the Accreditation Body (AkkStelleG) of 31 July 2009 (Federal Law Gazette I p. 2625) and the Regulation (EC) No 765/2008 of the European Parliament and of the Council of 9 July 2008 setting out the requirements for accreditation and market surveillance relating to the marketing of products (Official Journal of the European Union L 218 of 9 July 2008, p. 30). DAkKS is a signatory to the Multilateral Agreements for Mutual Recognition of the European co-operation for Accreditation (EA), International Accreditation Forum (IAF) and International Laboratory Accreditation Cooperation (ILAC). The signatories to these agreements recognise each other's accreditations.</p> <p>The up-to-date state of membership can be retrieved from the following websites: EA: <a href="http://www.european-accreditation.org">www.european-accreditation.org</a> ILAC: <a href="http://www.ilac.org">www.ilac.org</a> IAF: <a href="http://www.iaf.nu">www.iaf.nu</a></p>

**Note: The current certificate annex is published on the website (link see below) of the Accreditation Body DAkKS or may be received by CTC advanced GmbH on request**

<http://www.dakks.de/as/ast/d/D-PL-12076-01-03.pdf>