

RX13T CPU Card User's Manual

R12UZ0051EJ0100

Rev.1.00

Jul. 22, 2019

User's Manual

For Your Safety



Do not fail to read this manual before using the RX13T CPU card (RTK0EMXA10C00000BJ) (the product).

- Follow the indications in this manual when using the product.
- This product is the option board of "24V Motor Control Evaluation System for RX23T (RTK0EM0006S01212BJ)". Please read "Warnings Regarding Use of the Product" of the 24V Motor Control Evaluation System for RX23T User's Manual, and use this product.
- Keep this manual near the product so you can refer to it whenever necessary.
- Transfer or sale of the product to third parties is prohibited without written approval.
- The purchaser or importer of the product is responsible for ensuring compliance with local regulations. In addition, the customer is responsible for ensuring that the product is handled correctly and safely, in accordance with the laws of the customer's country (region).
- All information contained in this manual represents information on products at the time of publication of this manual. Please note that the product data, specification, sales offices, contents of website, address, etc., are subject to change by Renesas Electronics Corporation without notice due to product improvements or other reasons. Please confirm the latest information on Renesas Electronics website.
- The manual for the product, and specification (the documents) are the tool that was developed for the function and performance evaluation of Renesas Electronics semiconductor device (Renesas Electronics device) mounted on the product, and not guarantee the same quality, function and performance.
- By purchasing the product or downloading the documents from Renesas Electronics website, the support services provided from Renesas Electronics is not guaranteed.

Meaning of Notations

In this manual items related to the safe use of the product are indicated as described below.

The degree of injury to persons or damage to property that could result if the designated content in this manual is not followed is indicated as follows.

 Danger	Indicates content that, if not followed, could result in death or serious injury* ¹ to the user, and which is highly urgent.
 Warning	Indicates content that, if not followed, could result in death or serious injury to the user.
 Caution	Indicates content that, if not followed, could result in injury* ² to persons or physical damage.* ³

Note 1. Serious injury refers to conditions resulting in persistent after-effects and for which treatment would necessitate hospitalization or regular hospital visits, such as loss or impairment of eyesight, burns (high- or low-temperature), electric shock, bone fracture, or poisoning.

Note 2. Injury refers to conditions for which treatment would necessitate hospitalization or regular hospital visits.

Note 3. Physical damage refers to damage affecting the wider surroundings, such as the user's home or property.

Requirements related to the handling of the product are classified into the following categories.



- Marks indicating that an action is prohibited.

	<p>General Prohibition The indicated action is prohibited.</p>		<p>Example: Do Not Touch! Touching the specified location could result in injury.</p>
---	---	---	--

- Marks indicating that an action is prohibited.





	<p>General Caution Indicates a general need for caution that is not specified.</p>		<p>Example: Caution – Hot! Indicates the possibility of injury due to high temperature.</p>
---	---	---	--

- Marks directing that the specified action is required.







	<p>General Instruction The specified action is required.</p>		<p>Example: Turn Off (Disconnect) Power Supply! Instructs the user to turn off (disconnect) the power supply to the product.</p>
---	---	---	---

Warnings Regarding Use of the Product





■ Danger Items

 Danger	
  	<ul style="list-style-type: none"> • The product should be used only by persons (users) having a thorough knowledge of electrical and mechanical components and systems, a full knowledge of the risks associated with handling them, and training in inverter motor control and handling motors, or equivalent skills. Users should be limited to persons who have carefully read the Caution Items contained in this manual. • Unlike typical equipment, the product has no protective case to ensure safety, and it contains moving parts and high-temperature components that could be dangerous. Do not touch the evaluation board or cables while power is being supplied. • Carefully check to make sure that there are no pieces of conductive materials or dust adhering to the board, connectors, and cables. • There are moving parts, driven by a motor. Do not touch the motor while power is being supplied. • Ensure that the motor is insulated and placed in a stable location before supplying power.
	<p>Do Not Connect Load to Motor!</p> <ul style="list-style-type: none"> • This could cause fire, burns, or injury.

■ Warning Items

 Warning	
	<p>Caution – Rotating Parts!</p> <ul style="list-style-type: none"> The system includes a motor. Touching the rotating shaft could cause high-temperature burns or injury.
	<p>Always insert plugs, connectors, and cables securely, and confirm that they are fully inserted.</p> <ul style="list-style-type: none"> Incomplete connections could cause fire, burns, electric shock, or injury.
	<p>Use the power supply apparatus specified in the manual.</p> <ul style="list-style-type: none"> Failure to do so could cause fire, burns, electric shock, injury, or malfunction.
	<p>Disconnect the power supply and unplug all cables when the system will not be used for a period of time or when moving the system.</p> <ul style="list-style-type: none"> Failure to do so could cause fire, burns, electric shock, or malfunction. This will protect the system against damage due to lightning.
	<p>Use a mechanism (switch, outlet, etc.) located within reach to turn off (disconnect) the power supply.</p> <ul style="list-style-type: none"> In case of emergency, it may be necessary to cut off the power supply quickly.
	<p>Turn off the power supply immediately if you notice abnormal odor, smoke, abnormal sound, or overheating.</p> <ul style="list-style-type: none"> Continuing to use the system in an abnormal condition could cause fire, burns, or electric shock.
	<p>Do Not Disassemble, Modify, or Repair!</p> <ul style="list-style-type: none"> Doing so could cause fire, burns, electric shock, injury, or malfunction.
	<p>Do not use the product for any purpose other than initial evaluation of motor control in a testing room or lab. Do not integrate the product or any part of it into other equipment. Do not insert or remove cables or connectors when the product is powered on.</p> <ul style="list-style-type: none"> The product has no safety case. Failure to observe the above could cause fire, electric shock, burns, or malfunction. The product may not perform as expected if used for other than its intended purpose.

■ Caution Items

 Caution	
	<p>Caution – Hot!</p> <ul style="list-style-type: none"> The motor gets hot. Touching it could cause high-temperature burns.
	<p>Follow the procedure specified in the manual when powering the system on or off.</p> <ul style="list-style-type: none"> Failure to do so could cause overheating or malfunction.
	<p>Caution – Static Electricity</p> <ul style="list-style-type: none"> Use the antistatic band. Failure to do so could cause malfunction or unstable motion.

Overview

The RX13T CPU card (RTK0EMXA10C00000BJ) is an optional board for use with the 24V Motor Control Evaluation System for RX23T (RTK0EM0006S01212BJ) (the Motor RSSK). The Motor RSSK comprises a 24V system inverter board (RTK0EM0001B00012BJ) (the INV-BRD) and a RX23T CPU card (RTK0EM0013C01201BJ) (the RX23T-CRD). By replacing the RX23T-CRD with the product, motor evaluation can be performed using the RX13T.

An emulator and equipment related to the Motor RSSK must be provided by the customer.

This user's manual describes the proper handling of the product. Content related to the product is presented in chapters 1 to 3 and 5 to 6. Content related to connection of the INV-BRD supplied with the Motor RSSK is presented in chapter 4. For details of the operation of the INV-BRD, refer to the Motor RSSK user's manual (R20UT3697EJ).

Target Device

RX13T microcontroller

Related Documents

- RX13T CPU Card Schematic : R12TU0057EJ
- RX13T CPU Card BOM List : R12TU0058EJ
- RX13T CPU Card PWB Pattern Drawing : R12TU0059EJ
- Renesas Solution Starter Kit
24V Motor Control Evaluation System for RX23T (Motor RSSK) User's Manual: R20UT3697EJ

Package Contents

- RX13T CPU Card Information
- Caution regarding the Motor Control Evaluation Board – RX13T CPU Card –
- Connectors

Abbreviations

Abbreviations	Full Name	Remarks
Motor RSSK	24V Motor Control Evaluation System for RX23T	Motor control evaluation kit for RX23T Product No.: RTK0EM0006S01212BJ
INV-BRD	24V Inverter Board	Inverter board supplied with motor control evaluation kit for RX23T Product No.: RTK0EM0001B00012BJ
RX23T-CRD	RX23T CPU Card	RX23T CPU card supplied with motor control evaluation kit for RX23T Product No.: RTK0EM0013C01201BJ
E2 Lite	E2 emulator Lite	on-chip debugging emulator and flash programmer Product No.: RTE0T0002LKCE00000R

Contents

1. Specifications	6
1.1 Specification.....	6
1.2 Regulatory Compliance Notices.....	7
1.2.1 European Union regulatory notices.....	7
2. Block Diagram	8
3. Layout	9
4. Usage	10
4.1 Quick Start	10
4.1.1 Preparation	10
4.1.2 Replacing the CPU card	10
4.1.3 Preparation for Operation Test.....	10
4.1.4 Operation Test.....	10
4.1.5 Finishing the Operation Test	10
4.2 Operation	11
4.2.1 Basic Operation.....	11
4.2.2 Canceling an Error State	11
4.3 In Case of Abnormal Odor, Smoke, Abnormal Sound, Overheating, Etc.....	11
5. Functions	12
5.1 Power Supply.....	12
5.2 On-Board Emulator	12
5.3 Connecting the Inverter Board	12
5.4 Serial Communication	13
5.5 Hall Sensor Signal Input.....	13
5.6 Encoder Signal Input	14
5.7 Extension of Unused Pins.....	14
5.8 Reset Circuit	14
5.9 LEDs	14
6. RX13T CPU Card details	15
6.1 RX13T Pin Assignments.....	15
6.2 List of RX13T Pin Functions	16
7. Caution Items	17

1. Specifications

1.1 Specification

Table 1-1 Overview of RX13T CPU Card Specifications

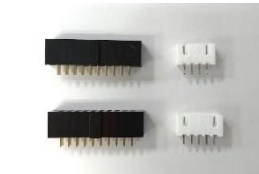
Item	Specification	
Product name	RX13T CPU card	
Board product No.	RTK0EMXA10C00000BJ	
Supported inverter board / product No.	Supplied with 24V Motor Control Evaluation System for RX23T 24V Inverter Board / RTK0EM0001B00012BJ	
Exterior view	<div style="display: flex; justify-content: space-around; align-items: center;"> <div style="text-align: center;">  <p>Board</p> </div> <div style="text-align: center;">  <p>Included items (connectors)</p> </div> </div> <p>Note: Appearance of actual product may differ from photo.</p>	
MCU	Product group	RX13T group
	Product No.	R5F513T5ADFL
	CPU max. operating frequency	32 MHz
	Bit count	32 bits
	Package / Pin count	LFQFP / 48 pins
	ROM	128KB
RAM	12KB	
MCU input clock	Crystal Oscillator is not mounted	
Input power supply voltage	DC 5 V ($\pm 5\%$) Selectable among the following: <ul style="list-style-type: none"> • Power supply from supported inverter board • Power supply from USB connector *1 	
Supported sensors	Hall sensor, encoder (through holes provided for signal monitoring test pins)	
Supported emulator	On-board emulator	
Connectors	<ul style="list-style-type: none"> • Emulator connector (USB) • Inverter board connectors x 2 (Unmounted) • Serial communication connectors x 3 (Unmounted) • Hall sensor connector (Unmounted) • Encoder connector (Unmounted) 	
Switch	MCU external reset switch	
LEDs	User control LEDs x 2	
Operating temperature	Room temperature	
Operating humidity	No condensation	

Note 1. Power supply from USB connector is not supported when INV-BRD is connected.

1.2 Regulatory Compliance Notices

1.2.1 European Union regulatory notices

This product complies with the following EU Directives. (These directives are only valid in the European Union.)

CE Certifications:

- Electromagnetic Compatibility (EMC) Directive 2014/30/EU
EN61326-1 : 2013 Class A

WARNING: This is a Class A product. This equipment can cause radio frequency noise when used in the residential area. In such cases, the user/operator of the equipment may be required to take appropriate countermeasures under his responsibility.

- Information for traceability
 - Authorised representative
Name: Renesas Electronics Corporation
Address: Toyosu Foresia, 3-2-24, Toyosu, Koto-ku, Tokyo 135-0061, Japan
 - Manufacturer
Name: Renesas Electronics Corporation
Address: Toyosu Foresia, 3-2-24, Toyosu, Koto-ku, Tokyo 135-0061, Japan
 - Person responsible for placing on the market
Name: Renesas Electronics Europe GmbH
Address: Arcadiastrasse 10, 40472 Dusseldorf, Germany
 - Trademark and Type name
Trademark: Renesas
Product name: RX13T CPU Card for Motor Control
Type name: RTK0EMXA10C00000BJ

Environmental Compliance and Certifications:

- Waste Electrical and Electronic Equipment (WEEE) Directive 2012/19/EU

2. Block Diagram

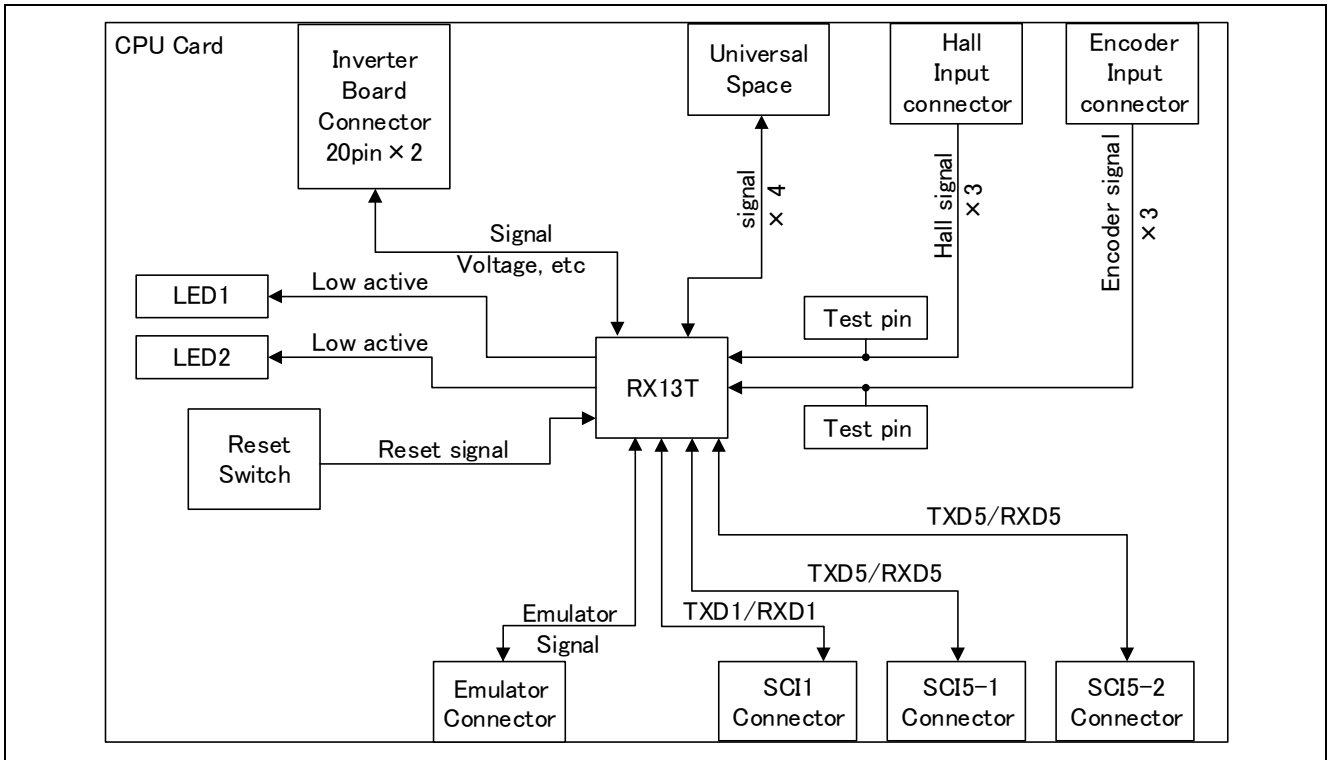

Figure 2-1 RX13T CPU Card Block Diagram

3. Layout

Layout of the product is shown in Figure 3-1 and Figure 3-2. Note that CN3, CN4, CN5, CNA and CNB are not mounted in the factory setting.

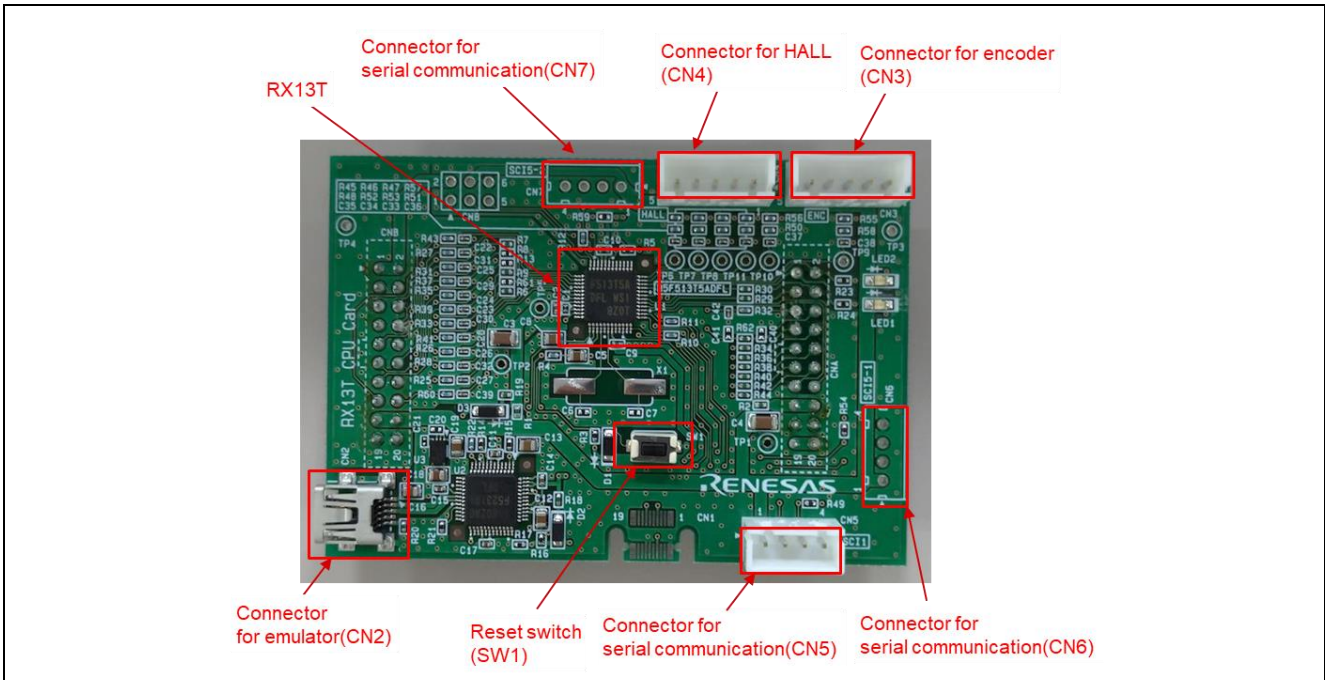

Figure 3-1 RX13T CPU Card Layout (Top View)

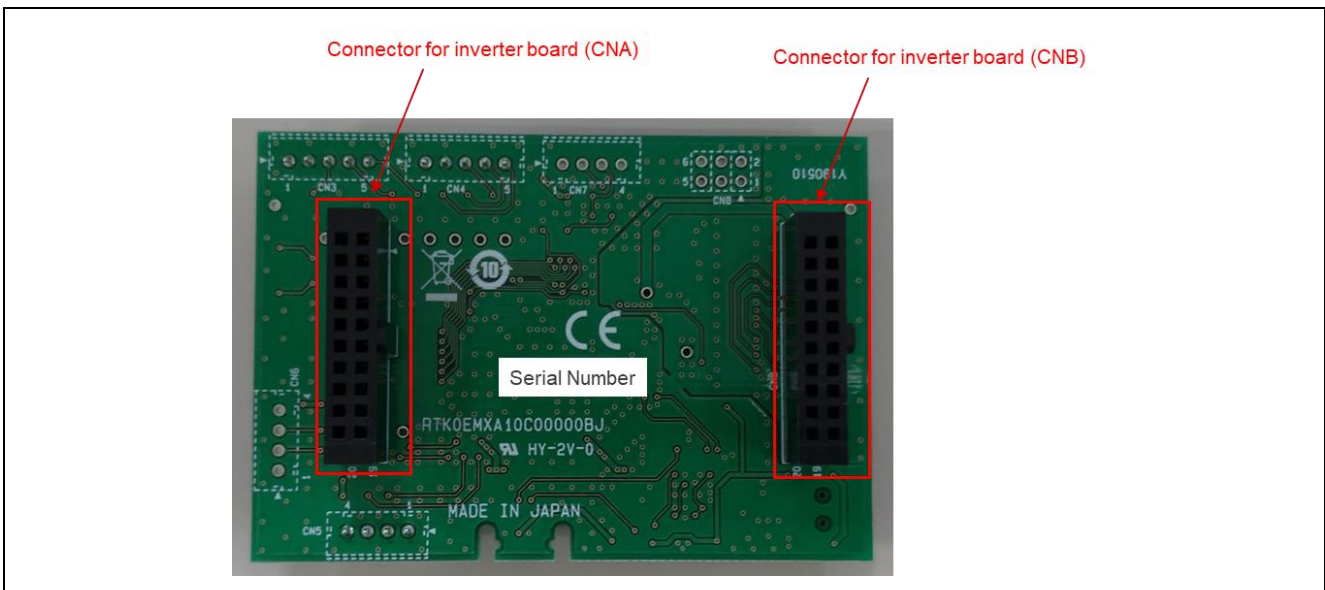

Figure 3-2 RX13T CPU Card Layout (Bottom View)

4. Usage

4.1 Quick Start

4.1.1 Preparation

Obtain the Motor RSSK, and perform the steps described in 5.1.1 and 5.1.2, Quick Start, of the user's manual. (R20UT3697EJ).

Mount CN5, CNA and CNB as shown in Figure 3-1 and Figure 3-2.

4.1.2 Replacing the CPU card

Confirm that the INV-BRD is powered off, detach the RX23T-CRD from the INV-BRD, and attach the product in its place.



Figure 4-1 CPU card replacement

4.1.3 Preparation for Operation Test

Perform the steps described in 5.1.3 to 5.1.5 of the Motor RSSK user's manual (R20UT3697EJ) to prepare for motor drive.

4.1.4 Operation Test

Perform the steps described in 5.1.6 to 5.1.9 of the Motor RSSK user's manual (R20UT3697EJ) in the order indicated, turn on the power supply, enable motor rotation, change the motor rotation speed, and stop motor rotation.

4.1.5 Finishing the Operation Test

After the operation test is finished, confirm that the motor shaft is no longer rotating and turn off the stabilized power supply output.

4.2 Operation

4.2.1 Basic Operation

The product is programmed with sensor-less vector control software for the RX13T as factory setting. Table 4-1 lists the software specifications and the basic operations when connected to the INV-BRD.

Table 4-1 Initial Software Specifications

Item	Specification
Control method	Sensorless vector control
VR1	Clockwise turn: Motor shaft rotates clockwise. Counterclockwise turn: Motor shaft rotates counterclockwise.
SW1	ON: Motor rotation enabled OFF: Motor rotation disabled
SW2	Cancels error state: OFF → ON → OFF after an error:
LED1	ON: SW1 ON and normal state. OFF: SW1 OFF or error state.
LED2	ON: error state. OFF: normal state.

4.2.2 Canceling an Error State

If an error occurs, LED2 lights on the INV-BRD and the product, and motor rotation stops. To recover, it is necessary to turn off toggle switch SW1 and turn on toggle switch SW2 on the INV-BRD, and then turn off toggle switch SW2 again.

4.3 In Case of Abnormal Odor, Smoke, Abnormal Sound, Overheating, Etc.

The INV-BRD is equipped with a toggle switch (S1) to cut off the flow of current to the inverter. If an abnormal condition (such as abnormal odor, smoke, abnormal sound, or overheating) occurs, turn off S1 to cut off current flow to the inverter.

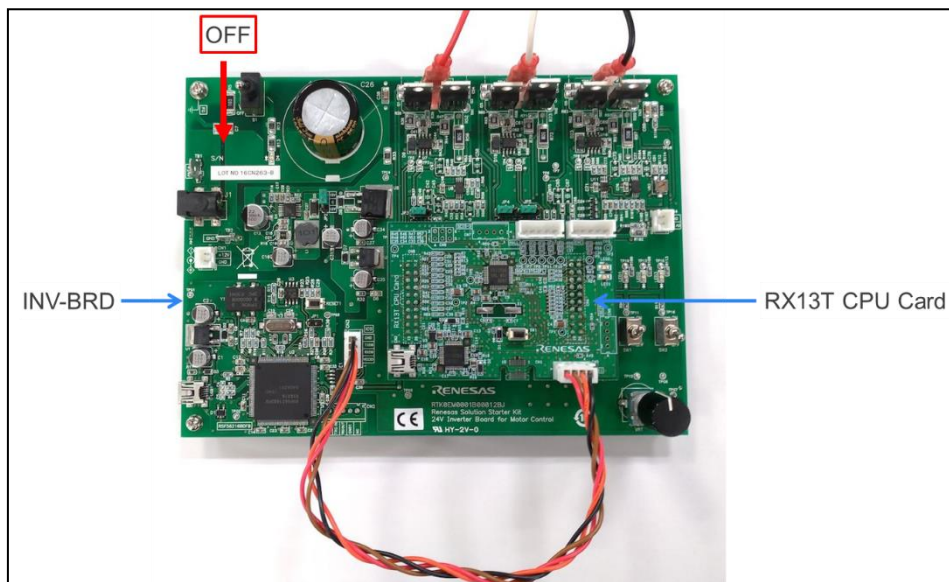

Figure 4-2 Cut off current supply

5. Functions

5.1 Power Supply

The product does not have a dedicated power supply connector. When connected to the INV-BRD it draws power via the connector. When not connected to the INV-BRD, it can draw power via the Emulator connector. The product is not allowed to draw power via the Emulator connector when it is connected to the INV-BRD.

5.2 On-Board Emulator

The product is equipped with an on-board emulator for RX13T flash programming. Connect your PC to the product with USB cable for flash programming. When you use the on-board emulator, configure the setting of IDE or Renesas Flash Programmer as follows;

Tool : E2Lite
 Interface : FINE
 Power Supply : None

5.3 Connecting the Inverter Board

The product connects to the INV-BRD via the inverter board connectors (CNA and CNB). Table 5-1 and Table 5-2 list the pin assignments of the inverter board connectors.

Table 5-1 Pin Assignments of Inverter Board Connector (CNA)

Pin No.	Pin Function	RX13T Connection Pins	Pin No.	Pin Function	RX13T Connection Pins
1	LED1#	PD6	2	LED2#	PD4
3	PFC_G1	PB3	4	VRL	PB2
5	FO#	PE2/POE10#	6	INVRES	P10
7	WN	P76/MTIOC4D	8	VN	P75/MTIOC4C
9	UN	P74/MTIOC3D	10	WP	P73/MTIOC4B
11	VP	P72/MTIOC4A	12	UP	P71/MTIOC3B
13	SW1#	PB5	14	SW2#	PB4
15	5V	VCC	16	5V	VCC
17	GND	VSS	18	GND	VSS
19	3.3V	—	20	3.3V	—

Table 5-2 Pin Assignments of Inverter Board Connector (CNB)

Pin No.	Pin Function	RX13T Connection Pins	Pin No.	Pin Function	RX13T Connection Pins
1	AVCC	AVCC	2	AVCC	AVCC
3	NC	NC	4	NC	NC
5	IU	AN000	6	IV	AN001
7	IW	AN002	8	VPN	AN006
9	TEMP	(AN005) *1	10	VU	AN003
11	VV	AN004	12	VW	AN005
13	VAC	(AN004) *1	14	IPFC	(AN003) *1
15	VR	AN007	16	RSVIN	P47
17	VCCIO	VCC	18	VCCIO	VCC
19	GND	VSS	20	GND	VSS

*1 Not connected in factory setting

5.4 Serial Communication

The product communicates with the UART via the serial communication connectors. There are three serial communication connectors: CN5, CN6, and CN7. Table 5-3 lists their pin assignments. Use CN5 when using a tool such as waveform display in conjunction with the INV-BRD.

Table 5-3 Pin Assignments of Serial Communication Connectors (CN5, CN6, CN7)

Connector No.	Pin No.	Pin Function	RX13T Connection Pins
CN5 (DNF)	1	5V	VCC
	2	TX for MCU	PD3/TXD1
	3	RX for MCU	PD5/RXD1
	4	GND	VSS
CN6 (DNF)	1	5V	VCC
	2	TX for MCU	PB6/TXD5
	3	RX for MCU	PB7/RXD5
	4	GND	VSS
CN7 (DNF)	1	5V	VCC
	2	TX for MCU	P23/TXD5
	3	RX for MCU	P24/RXD5
	4	GND	VSS

5.5 Hall Sensor Signal Input

The product is equipped with a Hall sensor signal input connector. Using this connector, you can input the Hall sensor signal from the motor supplied with the Motor RSSK directly to the product. The signals are pulled up to 5 V and passed through RC filters before being input to the RX13T. Table 5-4 lists the pin assignments of the Hall sensor signal input connector, and Table 5-5 lists connector information.

Table 5-4 Pin Assignments of Hall Sensor Signal Input Connector (CN4)

Pin No.	Pin Function	RX13T Connection Pins
1	5V	VCC
2	GND	VSS
3	HALL_U	P93/IRQ0
4	HALL_V	P94/IRQ1
5	HALL_W	PA2/IRQ4

Table 5-5 Hall Sensor Signal Input Connector Information

Part	Product No.	Manufacturer
Connector (CN5)	B5B-XH-A	J.S.T. Mfg. Co. Ltd.

5.6 Encoder Signal Input

The product is equipped with an encoder signal input connector. Using this connector, you can input the encoder signal to the RX13T. The signals are pulled up to 5 V and passed through RC filters before being input to the RX13T. Table 5-6 lists the pin assignments of the signal input connector, and Table 5-7 lists connector information.

Table 5-6 Pin Assignments of Encoder Signal Input Connector (CN3)

Pin No.	Pin Function	RX13T Connection Pins
1	5V	VCC
2	GND	VSS
3	ENC_A	PB1/MTCLKA
4	ENC_B	PB0/MTCLKB
5	ENC_Z	PA3/MTIOC1B

Table 5-7 Encoder Signal Input Connector Information

Part	Product No.	Manufacturer
Connector (CN3)	B5B-XH-A	J.S.T. Mfg. Co. Ltd.

5.7 Extension of Unused Pins

To facilitate general use of the product, the unused pins of the RX13T are extended through universal connector through holes in the board. Table 5-8 lists the pin assignments of the universal area through holes.

Table 5-8 Pin Assignments of Universal Area Through Holes (CN8)

Pin No.	RX13T Connection Pins
1	VSS
2	AVCC
3	P22
4	VCC
5	P70
6	VSS

5.8 Reset Circuit

The product is equipped with a reset circuit for resetting the microcontroller at power-on reset and external reset. To apply an external reset to the microcontroller, press the pushbutton (SW1).

5.9 LEDs

Two LEDs are mounted on the product for use in debugging programs and general system applications. Each turns on when the output on the corresponding port is low-level and turns off when the output is high-level. Table 5-9 lists the pin assignments corresponding to the LEDs.

Table 5-9 RX13T CPU Card LED Connection Pin Assignments

Corresponding RX13T Port	LED1	LED2
PD6	High-level output	Off
	Low-level output	On
PD4	High-level output	Off
	Low-level output	On

6. RX13T CPU Card details

6.1 RX13T Pin Assignments

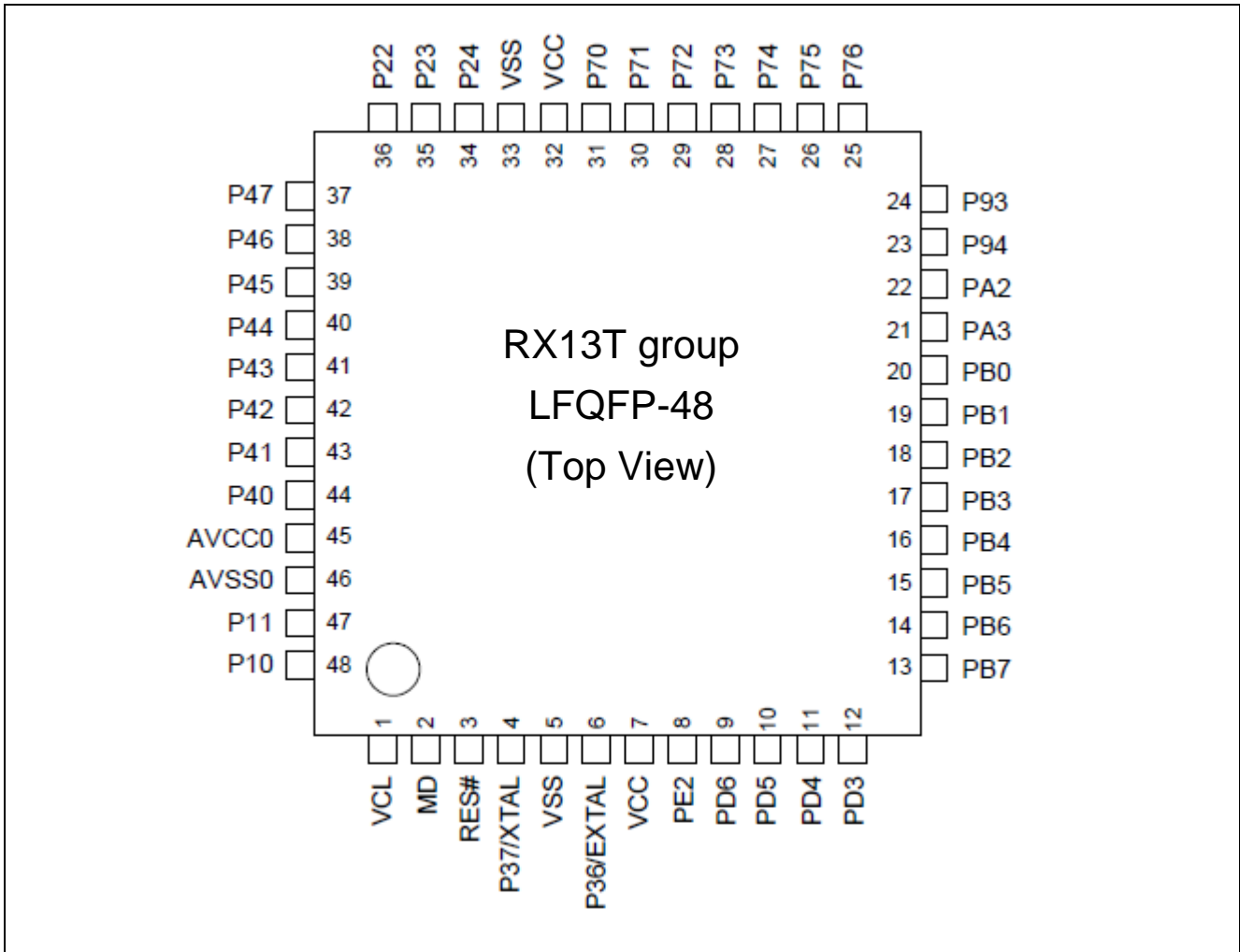

Figure 6-1 RX13T Pin Assignments

6.2 List of RX13T Pin Functions

Table 6-1 List of RX13T Pin Functions

Pin No.	RX13T Pin Functions	CPU Card connection	Function
1	VCL	capacitor	-
2	MD/FINED	CN2. 7	Emulator
3	RES#	CN2. 13	MCU reset
4	XTAL/P37	-	-
5	VSS	VSS	VSS
6	EXTAL/P36	-	-
7	VCC	VCC	VCC
8	PE2/POE10#/NMI/IRQ0	CNA. 5	FO#
9	PD6/MTIOC0D/CTS1#/RTS1#/SS1#/IRQ5/ADSTO	CNA. 1	LED1
10	PD5/MTIOC0C/RXD1/SMIS01/SSCL1/IRQ3	CN5. 3	SCI1 communication
11	PD4/MTIOC0B/SCK1/IRQ2	CNA. 2	LED2
12	PD3/MTIOC0A/TXD1/SMOS11/SSDA1	CN5. 2	SCI1 communication
13	PB7/MTIOC3C/MTCLKD/RXD1/SMIS01/SSCL1/RXD5/SMIS05/SSCL5/IRQ5	CN6. 3	SCI5-1 communication
14	PB6/MTIOC1B/MTIOC3A/TXD1/SMOS11/SSDA1/TXD5/SMOS15/SSDA5	CN6. 2	SCI5-1 communication
15	PB5/ADTRG0#	CNA. 13	SW1
16	PB4/POE8#	CNA. 14	SW2
17	PB3/MTIOC0A/CACREF/SCK5/SCK12	CNA. 3	PFC_G1
18	PB2/MTIOC0B/MTCLKC/ADSM0/TXD5/SMOS15/SSDA5/SDA0/	CNA. 4	VRL
19	PB1/MTIOC0C/MTIC5W/MTCLKA/RXD5/SMIS05/SSCL5/SCL0/IRQ2	CN3. 3	ENC_A
20	PB0/MTIOC0D/MTIOC2A/MTCLKB/TXD12/TXDX12/SIOX12/SMOS112/SSDA12	CN3. 4	ENC_B
21	PA3/MTIOC1B/MTIOC2A/CTS12#/RTS12#/SS12#	CN3. 5	ENC_Z
22	PA2/MTIOC1A/MTIOC2B/ CTS5#/RTS5#/SS5#/IRQ4	CN4. 5	HALL_W
23	P94/MTIOC2B/MTIC5U/MTCLKA/RXD12/RXDX12/SMIS012/SSCL12/ IRQ1	CN4. 4	HALL_V
24	P93/MTIOC1A/MTIC5V/ SCK5/SCK12/IRQ0/ADTRG0#	CN4. 3	HALL_U
25	P76/MTIOC4D	CNA. 7	WN
26	P75/MTIOC4C	CNA. 8	VN
27	P74/MTIOC3D	CNA. 9	UN
28	PE2/POE10#/NMI/IRQ0	CNA. 5	FO#
29	PD6/MTIOC0D/CTS1#/RTS1#/SS1#/IRQ5/ADSTO	CNA. 1	LED1
30	PD5/MTIOC0C/RXD1/SMIS01/SSCL1/IRQ3	CN5. 3	SCI1 communication
31	PD4/MTIOC0B/SCK1/IRQ2	CNA. 2	LED2
32	PD3/MTIOC0A/TXD1/SMOS11/SSDA1	CN5. 2	SCI1 communication
33	PB7/MTIOC3C/MTCLKD/RXD1/SMIS01/SSCL1/RXD5/SMIS05/SSCL5/IRQ5	CN6. 3	SCI5-1 communication
34	PB6/MTIOC1B/MTIOC3A/TXD1/SMOS11/SSDA1/TXD5/SMOS15/SSDA5	CN6. 2	SCI5-1 communication
35	PB5/ADTRG0#	CNA. 13	SW1
36	PB4/POE8#	CNA. 14	SW2
37	PB3/MTIOC0A/CACREF/SCK5/SCK12	CNA. 3	PFC_G1
38	PB2/MTIOC0B/MTCLKC/ADSM0/TXD5/SMOS15/SSDA5/SDA0/	CNA. 4	VRL
39	PB1/MTIOC0C/MTIC5W/MTCLKA/RXD5/SMIS05/SSCL5/SCL0/IRQ2	CN3. 3	ENC_A
40	PB0/MTIOC0D/MTIOC2A/MTCLKB/TXD12/TXDX12/SIOX12/SMOS112/SSDA12	CN3. 4	ENC_B
41	PA3/MTIOC1B/MTIOC2A/CTS12#/RTS12#/SS12#	CN3. 5	ENC_Z
42	PA2/MTIOC1A/MTIOC2B/ CTS5#/RTS5#/SS5#/IRQ4	CN4. 5	HALL_W
43	P94/MTIOC2B/MTIC5U/MTCLKA/RXD12/RXDX12/SMIS012/SSCL12/ IRQ1	CN4. 4	HALL_V
44	P93/MTIOC1A/MTIC5V/ SCK5/SCK12/IRQ0/ADTRG0#	CN4. 3	HALL_U
45	P76/MTIOC4D	CNA. 7	WN
46	P75/MTIOC4C	CNA. 8	VN
47	P74/MTIOC3D	CNA. 9	UN
48			

7. Caution Items

The product includes some unused pins that have not been processed. For information on accurate pin processing, refer to the hardware manual of the microcontroller.

Website and Support

Renesas Electronics Website

<http://www.renesas.com/>

Inquiries

<http://www.renesas.com/contact/>

All trademarks and registered trademarks are the property of their respective owners.

Revision History

Rev.	Date	Description	
		Page	Summary
1.00	Jul. 22, 2019	-	First edition issued