

# RZ/G2L RZ/G2LC RZ/G2UL RZ/G3S

## Getting Started with Flexible Software Package

---

### Introduction

This material describes how to use the Renesas Flexible Software Package (FSP) for writing applications for the RZ microprocessor series.

### Target Device

RZ/G2L RZ/G2LC RZ/G2UL RZ/G3S

## Contents

1. Introduction.....	4
1.1 Overview.....	4
1.2 Introduction to FSP.....	4
1.2.1 Purpose .....	4
1.2.2 e2 studio IDE.....	4
1.3 Limitations .....	4
1.3.1 Peripherals and pins assignment .....	4
1.3.2 RAM Initialization.....	4
2. Starting Development Introduction.....	5
2.1 e2 studio setup .....	5
2.1.1 What is e2 studio?.....	5
2.1.2 e2 studio Prerequisites.....	5
2.1.3 e2 studio installation for Windows PC.....	5
2.1.4 e2 studio installation for Linux PC .....	13
2.2 FSP setup.....	20
2.2.1 Installation of FSP using Package Installer.....	20
2.2.2 Installation of FSP Packs using Package Zip file.....	22
3. Set up an SMARC EVK .....	23
3.1 RZ/G2L SMARC EVK.....	23
3.1.1 Supported Debugger .....	23
3.1.2 Board Setup.....	23
3.2 RZ/G3S SMARC EVK .....	27
3.2.1 Supported Debugger .....	27
3.2.2 Board Setup.....	27
4. Tutorial: Your First RZ MPU Project - Blinky .....	33
4.1 Tutorial Blinky .....	33
4.2 What Does Blinky Do? .....	33
4.3 Create a New Project for Blinky .....	34
4.3.1 Details about the Blinky Configuration .....	38
4.3.2 Configuring the Blinky Clocks.....	38
4.3.3 Configuring the Blinky Pins .....	38
4.3.4 Configuring the Parameters for Blinky Components .....	38
4.3.5 Where is main()? .....	38
4.3.6 Blinky Example Code .....	38
4.4 Build the Blinky Project.....	39
4.5 Debug the Blinky Project.....	40
4.6 Debug prerequisites .....	40
4.7 Debug steps .....	40

4.8	Details about the Debug Process.....	41
4.9	Run the Blinky Project.....	41
5.	FSP application launch with e2 studio .....	42
5.1	Create a Project.....	42
5.1.1	What is a Project? .....	42
5.1.2	Creating a New Project .....	44
5.1.3	Duplication of Resources .....	48
5.2	Configuring a Project.....	49
5.2.1	Summary Tab.....	49
5.2.2	Configuring the BSP .....	49
5.2.3	Configuring Clocks .....	50
5.2.4	Configuring Pins .....	51
5.2.5	Configuring Interrupts from the Stacks Tab .....	52
5.2.6	Creating Interrupts from the Interrupts Tab.....	52
5.2.7	Viewing Event Links .....	53
5.2.8	Adding and Configuring HAL Drivers .....	53
5.3	Reviewing and Adding Components .....	54
5.4	Debugging the Project.....	55
5.5	Modifying Toolchain Settings .....	56
5.6	Importing an Existing Project into e2 studio .....	57
6.	Migration from previous version .....	60
6.1	How to update RZ/G2L, RZ/G2LC, RZ/G2UL project .....	60
6.2	How to update RZ/G3S project .....	62
6.2.1	Procedure to update the project for CM33 without FPU Core .....	62
6.2.2	Procedure to update the project for CM33 with FPU Core.....	66
	Revision History.....	70

## 1. Introduction

### 1.1 Overview

This application note describes how to use the Renesas Flexible Software Package (FSP) running on the Cortex®-M33 (hereinafter referred to as CM33) incorporated on RZ/G2L, RZ/G2LC, RZ/G2UL and RZ/G3S.

### 1.2 Introduction to FSP

#### 1.2.1 Purpose

The Renesas Flexible Software Package (FSP) is an optimized software package designed to provide easy to use, scalable, high quality software for embedded system design. The primary goal is to provide lightweight, efficient drivers that meet common use cases in embedded systems.

#### 1.2.2 e2 studio IDE

FSP provides a host of efficiency enhancing tools for developing projects targeting the Renesas RZ series of MPU devices. The e2 studio IDE provides a familiar development cockpit from which the key steps of project creation, module selection and configuration, code development, code generation, and debugging are all managed.

### 1.3 Limitations

#### 1.3.1 Peripherals and pins assignment

RZ/G2L, RZ/G2LC, RZ/G2UL and RZ/G3S has a multi-core configuration of Cortex-A55 (hereinafter referred to as CA55) and CM33. It is possible to use each peripheral and GPIO from each core. This package provides drivers for the peripheral, and it is expected that peripherals, channels and pins to be used in the package can be occupied by FSP.

#### 1.3.2 RAM Initialization

Initialization of DDR SDRAM is always carried out in CA55 bootstrap regardless of the selection of boot CPU, meanwhile Internal SRAM is initialized in the bootstrap of boot CPU.



## 2. Starting Development Introduction

### 2.1 e2 studio setup

#### 2.1.1 What is e2 studio?

Renesas e2 studio is a development tool encompassing code development, build, and debug. e2 studio is based on the open-source Eclipse IDE and the associated C/C++ Development Tooling (CDT).

When developing the software for RZ MPUs, e2 studio hosts the Renesas Flexible Software Package (FSP). FSP provides a wide range of time saving tools to simplify the selection, configuration, and management of modules and threads, to easily implement complex applications.

#### 2.1.2 e2 studio Prerequisites

##### 2.1.2.1 Obtaining an RZ MPU Kit

To develop applications with RZ/G FSP, start with Evaluation Board Kit for each RZ/G Series.

Start-up guide of RZ/G2L, RZ/G2LC, RZ/G2UL Evaluation Board Kit is available at [SMARC EVK of RZ/G2L, RZ/G2LC, RZ/G2UL, RZ/V2L, and RZ/Five Start-up Guide](#).

##### 2.1.2.2 PC Requirements

The following are the minimum PC requirements to use e2 studio:

- Windows 10 or Ubuntu 20.04 LTS Desktop(64-bit) with Intel i5 or i7, or AMD A10-7850K or FX
- Memory: 8-GB DDR3 or DDR4 DRAM (16-GB DDR4/2400-MHz RAM is preferred)
- Minimum 250-GB hard disk

##### 2.1.2.3 Licensing

FSP licensing includes full source code, limited to Renesas hardware only.

### 2.1.3 e2 studio installation for Windows PC

This chapter describes how to install the e2 studio IDE on Windows PC.

#### 2.1.3.1 Download

The latest e2 studio IDE installer package can be downloaded from Renesas website for free. Please check detailed information from: <https://www.renesas.com/e2studio>. Note that user has to login to the Renesas account (in MyRenesas page) for the software download.

#### 2.1.3.2 Installation of e2 studio IDE

1. Double-click on e2 studio installer to invoke the e2 studio installation wizard page. First, you need to select Install Type. In this material, it is expected that Custom Install is selected. Then, click [Next >] to continue.

Note: If e2 studio was installed in your PC, the option to modify, remove the existing version or install e2 studio to a different location will be displayed

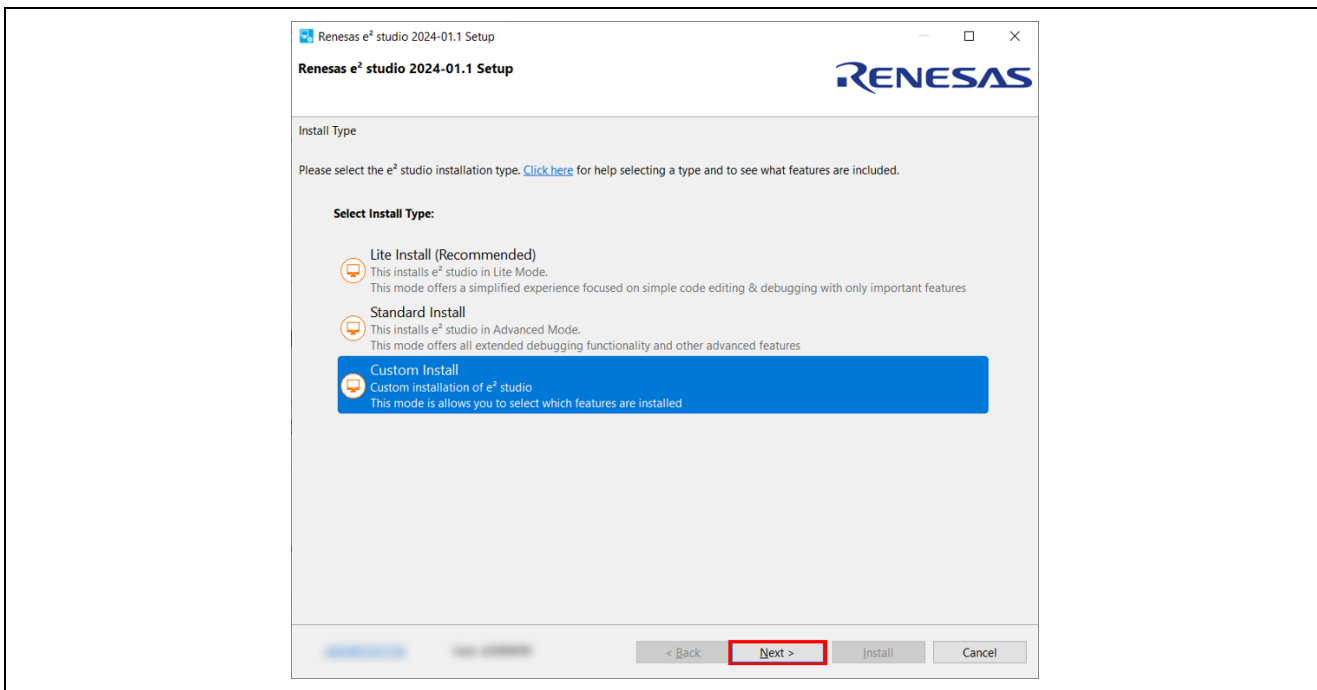

Figure 1: Installation of e2 studio – Install Type

2. Welcome page

User can change the install folder by clicking [Change...]. Click [Next] to continue.

- Notes: 1. If you would like to have multiple versions of e2 studio, please specify the new folder here.  
 2. Multi-Byte characters cannot be used for e2 studio installation folder name.

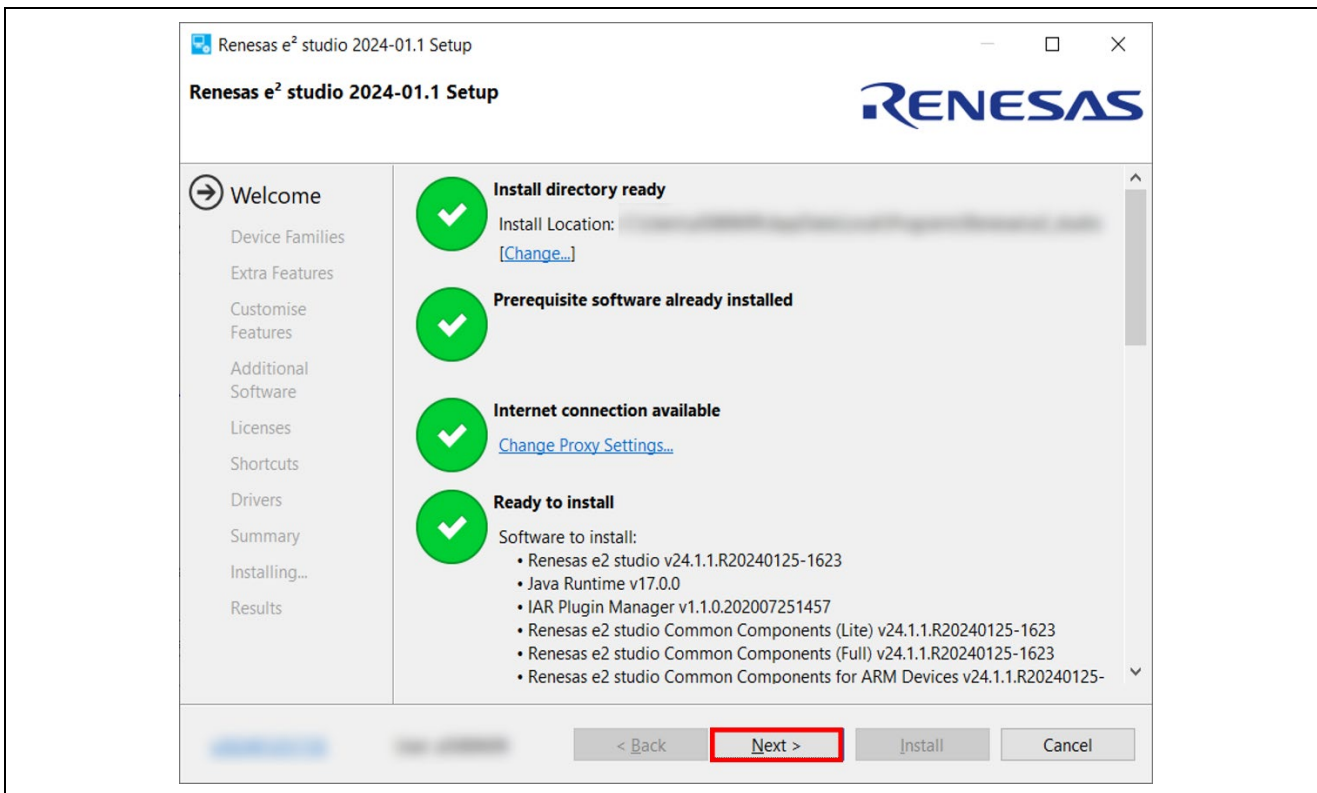

Figure 2: Installation of e2 studio – Welcome page

### 3. Device Families

Select Devices Families to install. Click the [Next >] button to continue.

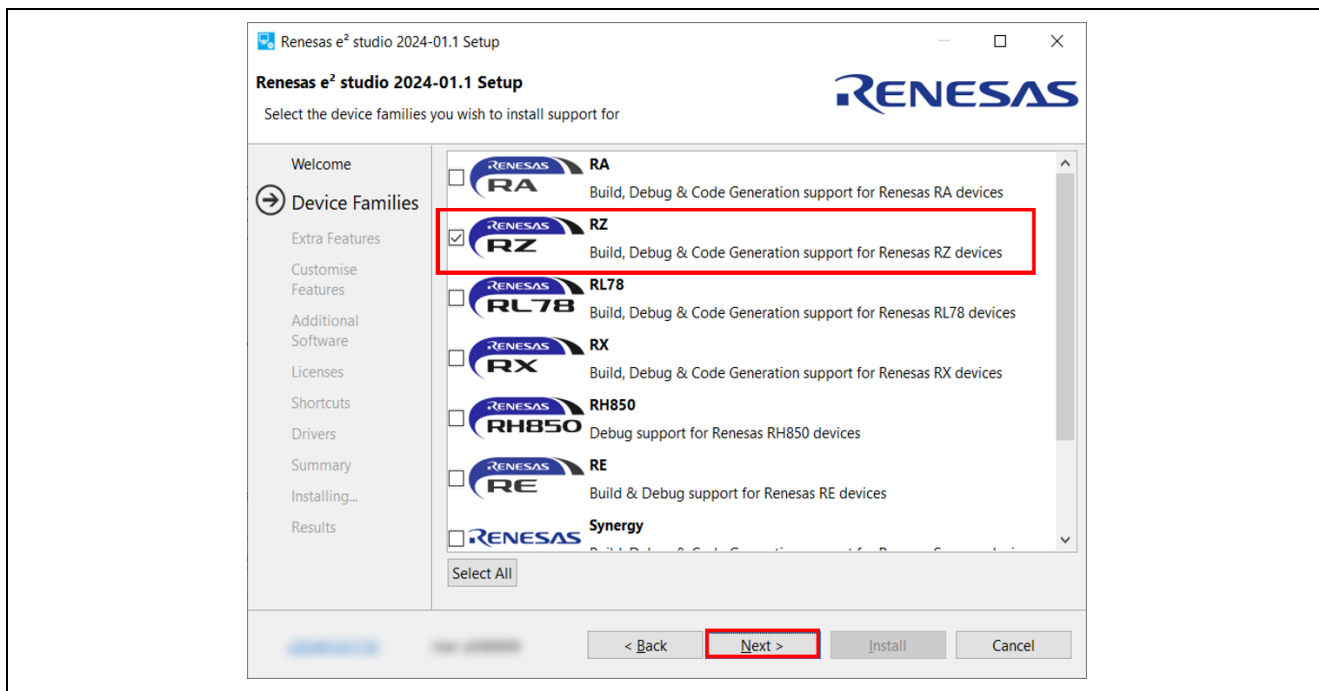

Figure 3: Installation of e2 studio – Device Families

### 4. Extra Features

Select Extra Features (e.g., Language packs, SVN & Git support...) to be installed. For non-English language users, please select Language packs at this step if needed. Then, click [Next >] to continue.

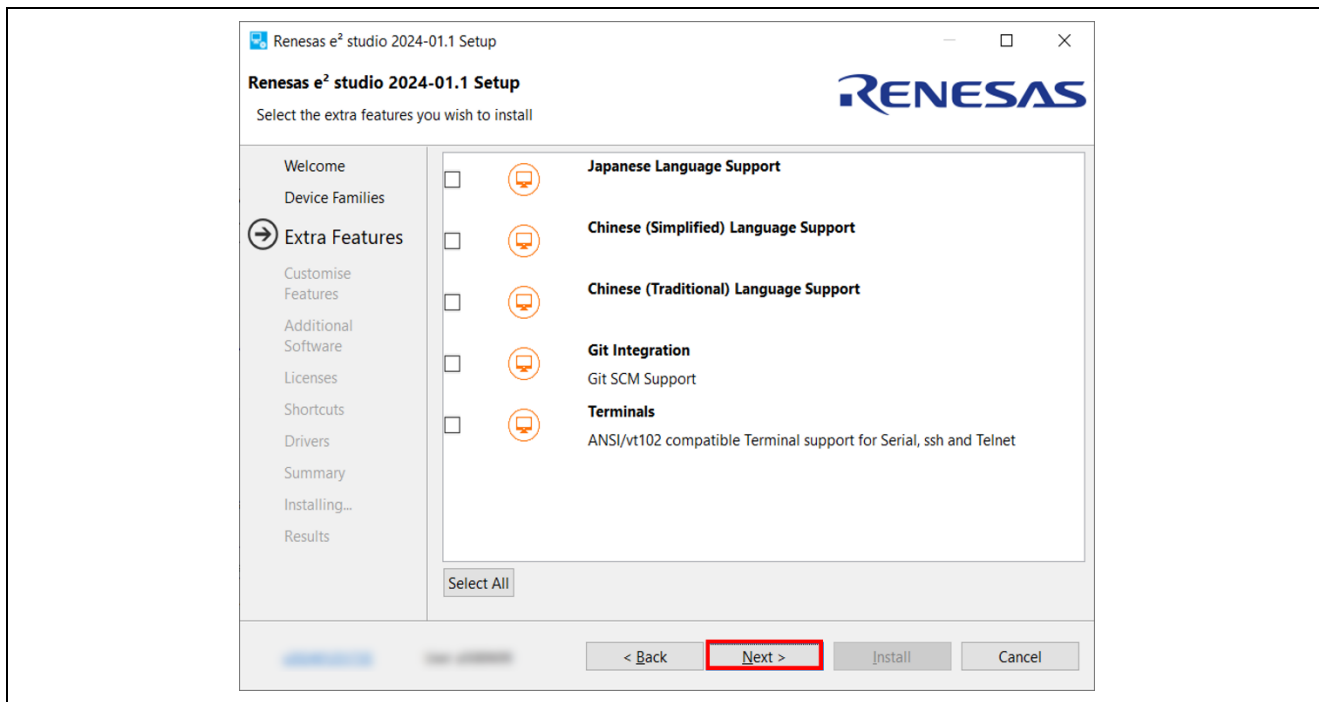

Figure 4: Installation of e2 studio – Extra Features

5. Customize Features

Select the components to install and click the [Next >] to continue. Be sure that Renesas FSP Smart Configurator Core and Renesas FSP Smart Configurator ARM are selected.

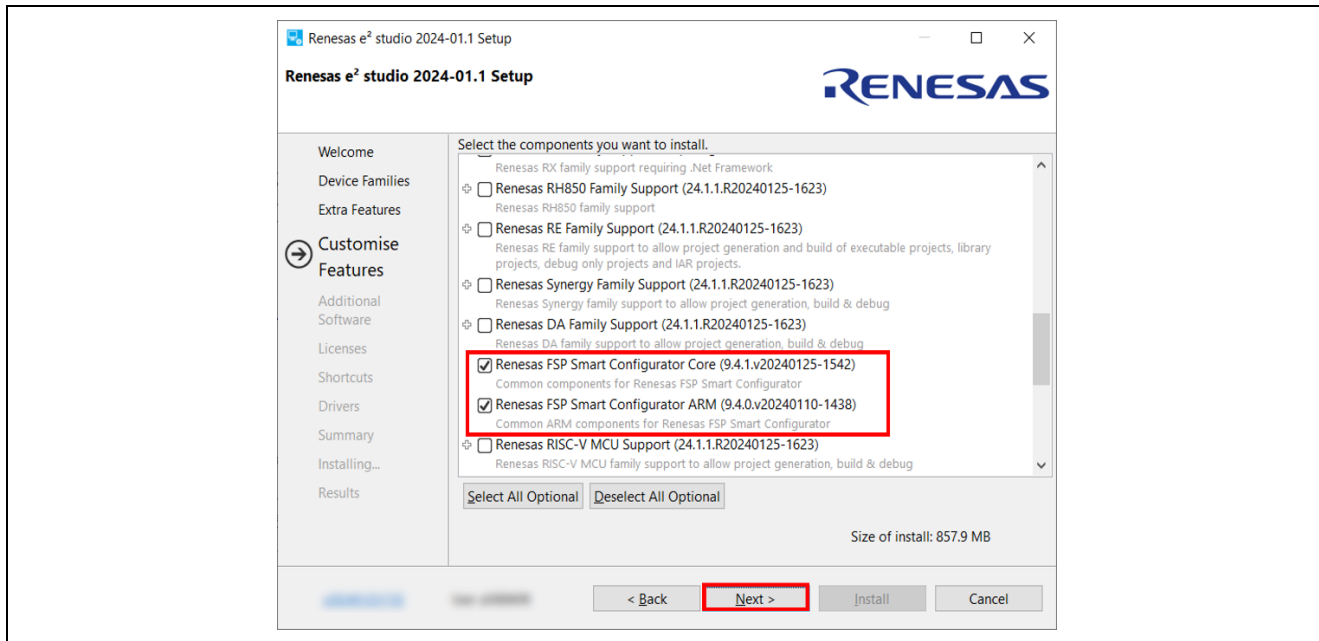

Figure 5: Installation of e2 studio – Customise Features

6. Additional Software

Select additional software (i.e., compilers, utilities, QE...) to be installed. Be sure to select the following item and click [Next >] to continue.

- GNU ARM Embedded 10.3 2021.10

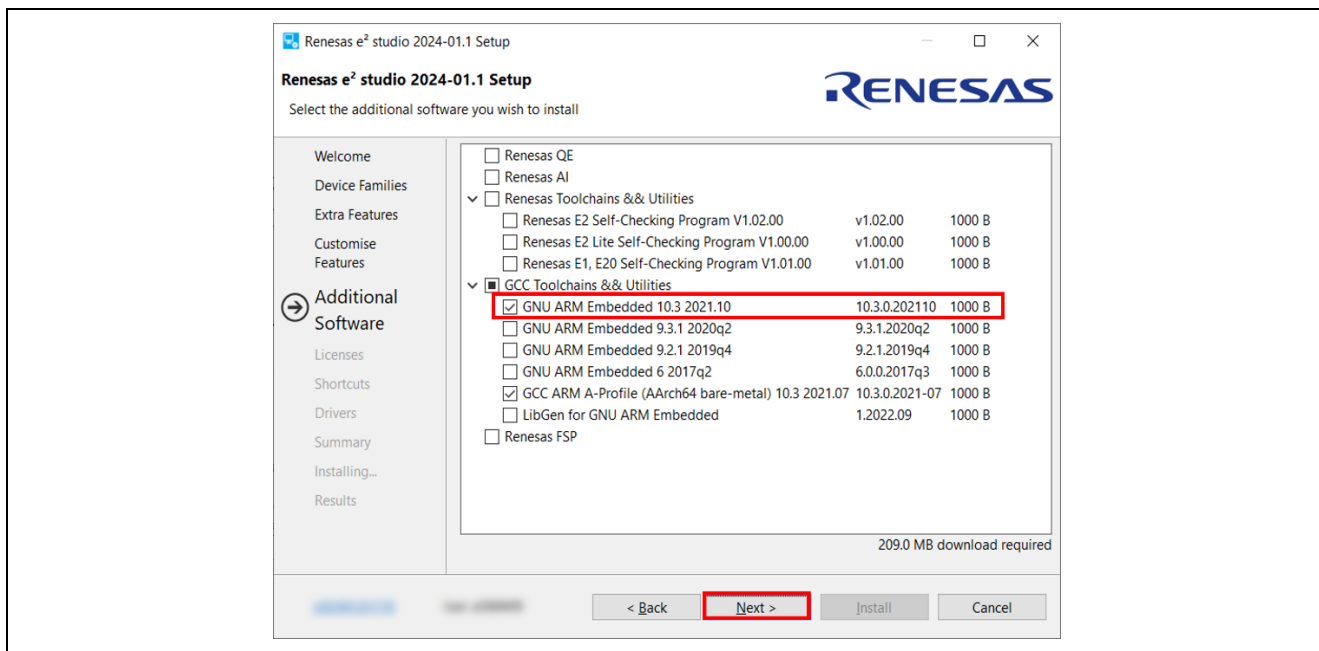

Figure 6: Installation of e2 studio – Additional Software

For more details on the installation of Additional Software, please see section 2.1.3.3.

## 7. Licenses

Read and accept the software license agreement. Click the [Next] button. Please note that user must accept the license agreement, otherwise installation cannot be continued.

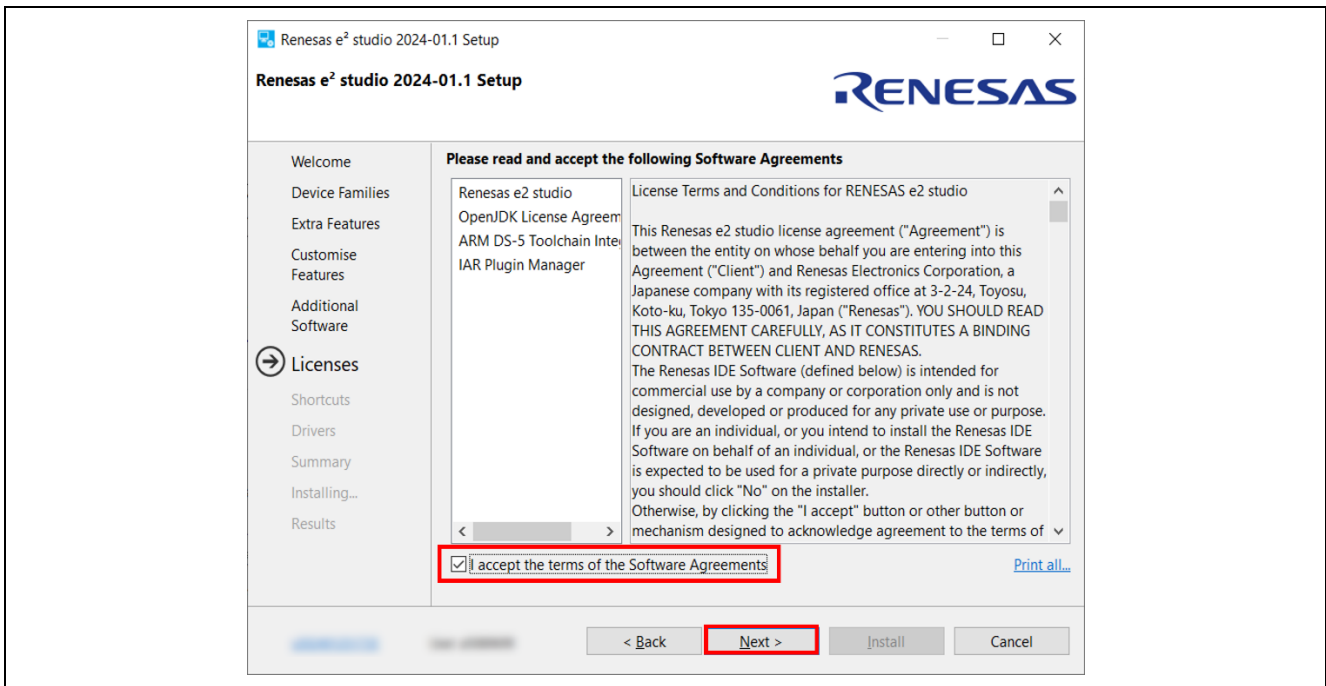

Figure 7: Installation of e2 studio – Licenses

## 8. Shortcuts

Select shortcut name for start menu and click [Next] button to continue.

Note: If e2 studio has already been installed in another location, it is recommended to rename the shortcut to distinguish from the other e2 studio(s).

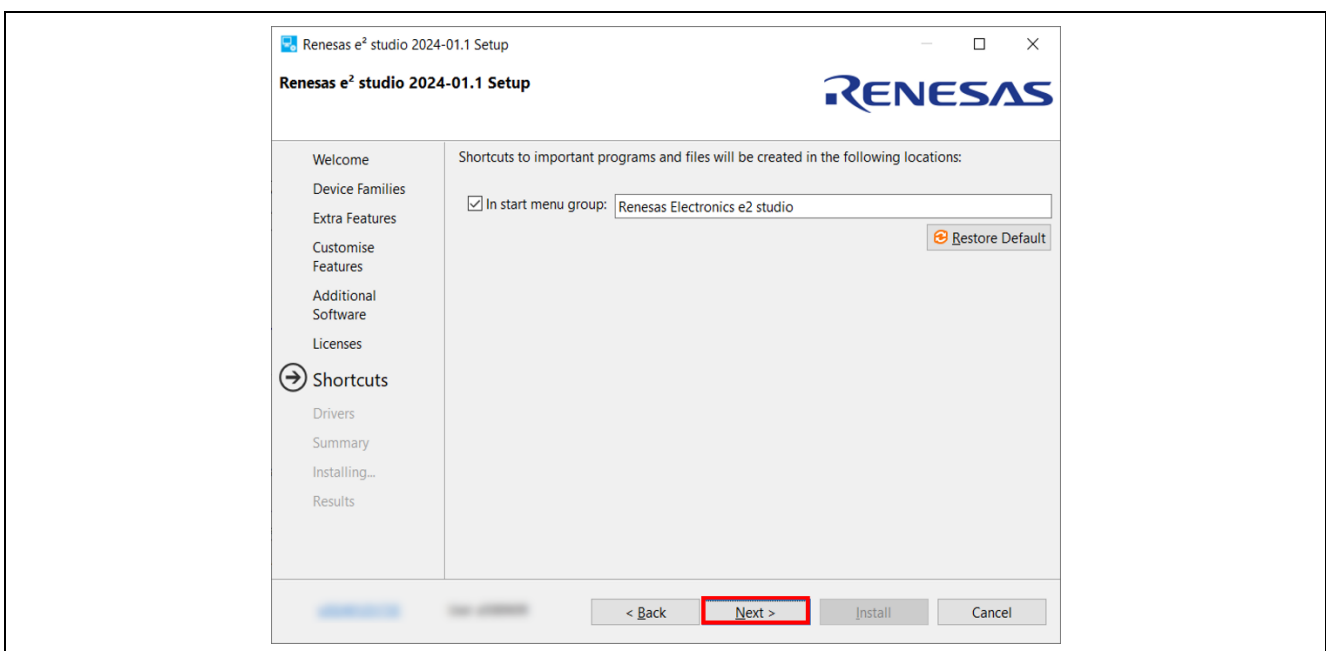

Figure 8: Installation of e2 studio – Shortcuts

9. Summary

Components list to be installed is shown. Please confirm the contents and click the [Install] button to install the Renesas e2 studio IDE.

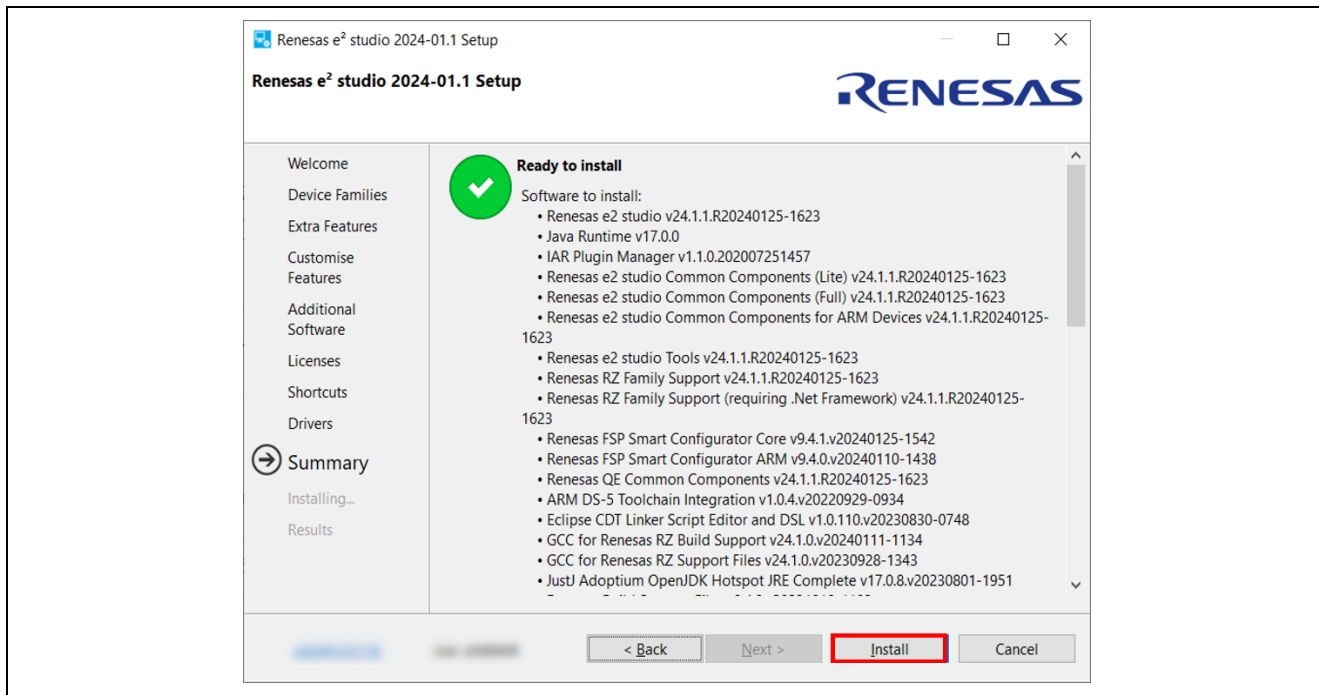

Figure 9: Installation of e2 studio – Summary

8. Installing...

The installation is performed. Depending on selected items of additional software, new dialog prompts may appear during the installation process. Please see section 2.1.3.3 for more detailed information.

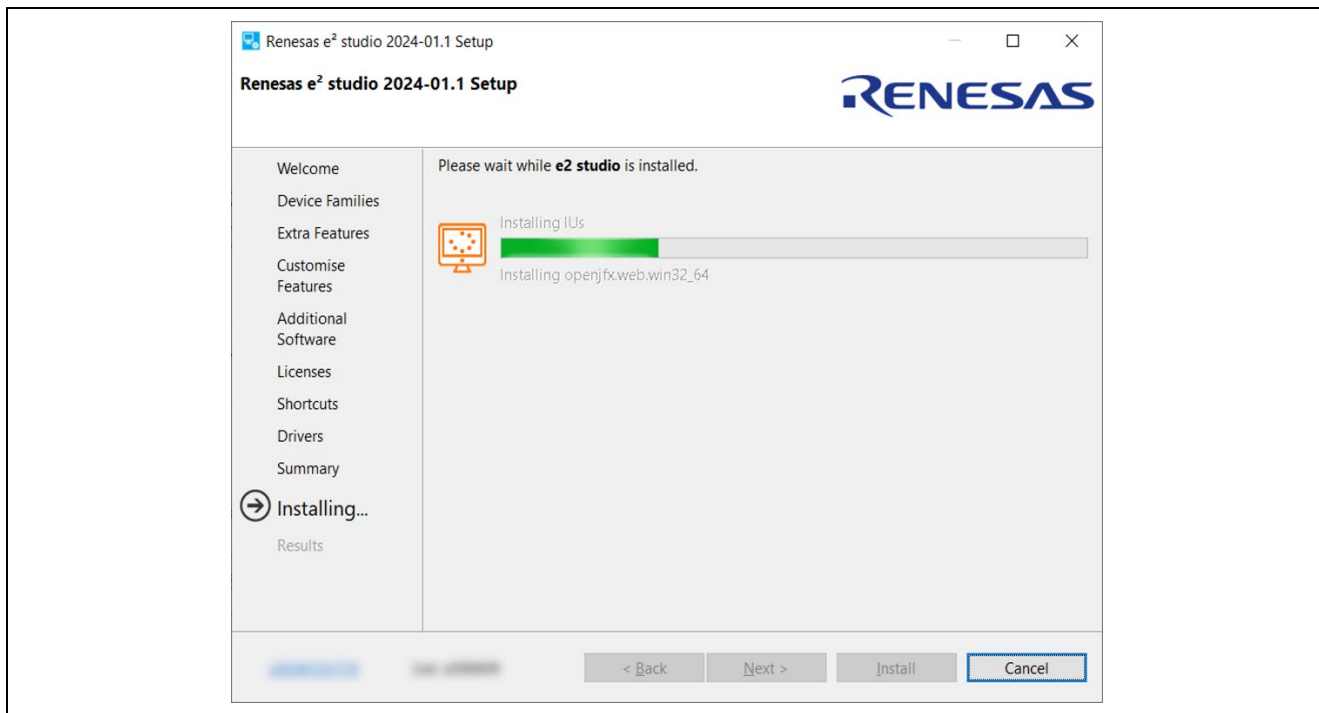

Figure 10: Installation of e2 studio – Installing...

## 9. Results

Click the **OK** button to complete the installation.

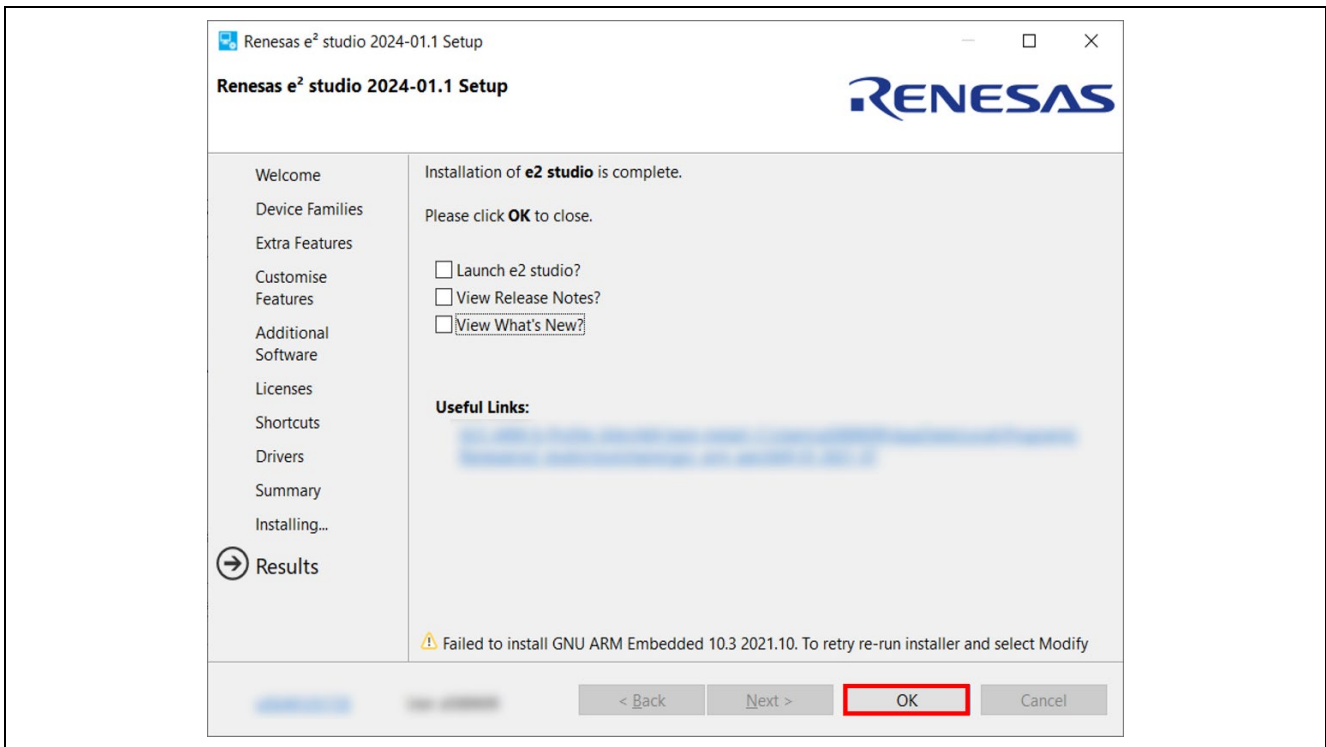

Figure 11: Summary Page

### 2.1.3.3 Installation of Additional Software

As mentioned in section 2.1.3.2, the additional software listed below is essential for RZ/G FSP.

GNU ARM Embedded 10.3 2021.10

In this section, the detailed procedure for installing these tools.

#### (1) GNU ARM Embedded Toolchain 10.3 2021.10

If it was selected in the Additional Software pane of e2 studio, you will see the installation wizard for the GNU ARM Embedded Toolchain during the installation process.



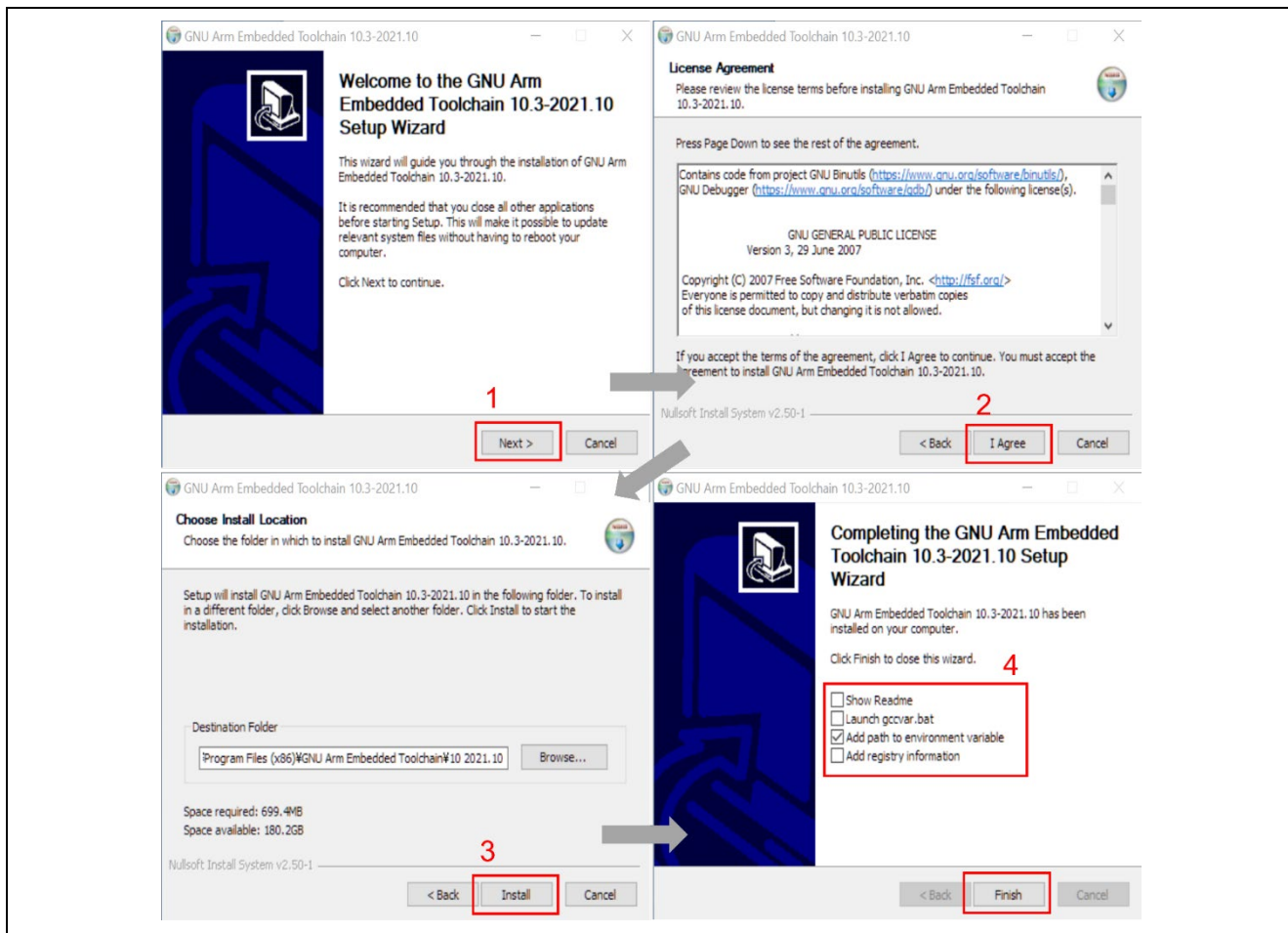

Figure 12: Installation of GNU ARM Embedded Toolchain



## 2.1.4 e2 studio installation for Linux PC

This chapter describes how to install the e2 studio IDE on Linux PC.

### 2.1.4.1 Prerequisite

Please download the development tool related stuff:

SEGGER J-Link driver

Please choose the version V7.94h or after and download Linux 64-bit DEB Installer at the URL below:

<https://www.segger.com/downloads/jlink/>

GNU ARM Embedded Toolchain

Please download gcc-arm-none-eabi-10.3-2021.10-x86\_64-linux.tar.bz2 in the Arm Developer site:

<https://developer.arm.com/open-source/gnu-toolchain/gnu-rm/downloads>

e2 studio IDE installer

e2 studio IDE installer package can be downloaded from Renesas website for free. Please check detailed information from: <https://www.renesas.com/e2studio>.

### 2.1.4.2 Installation

This section describes the procedure of each software installation. Filename, version number and the file path are just examples. Please replace those in accordance with your environment.

#### 1. SEGGER J-Link driver

Open a terminal window and enter commands stated below:

```
$ sudo dpkg -i JLink_Linux_V794h_x86_64.deb
```

If the previous install fails with unmet dependencies, retry it as follows:

```
$ sudo apt-get -f install
$ sudo dpkg -i JLink_Linux_V794h_x86_64.deb
```

#### 2. GNU ARM Embedded Toolchain

Enter commands below on terminal. Note that GNU ARM Embedded Toolchain is expected to be placed at **~/Downloads**.

```
$ sudo mkdir -p /opt
$ cd /opt
$ sudo tar jxvf ~/Downloads/gcc-arm-none-eabi-10.3-2021.10-x86_64-linux.tar.bz2
```

#### 3. Installation of e2 studio IDE

Invoke the commands below to run the e2 studio IDE Installer. Note that it is expected that the installer is placed at **~/Downloads**.

```
$ cd ~/Downloads
$ chmod 755 e2studio_installer-2024-01_1_linux_host.run
$ ./e2studio_installer-2024-01_1_linux_host.run
```

Then, the installation should be started. Please follow the following procedure:

- **Install Type**

User needs to select Install Type as shown below. In this material, it is expected that Custom Install is selected. Then, click [Next >] to continue.

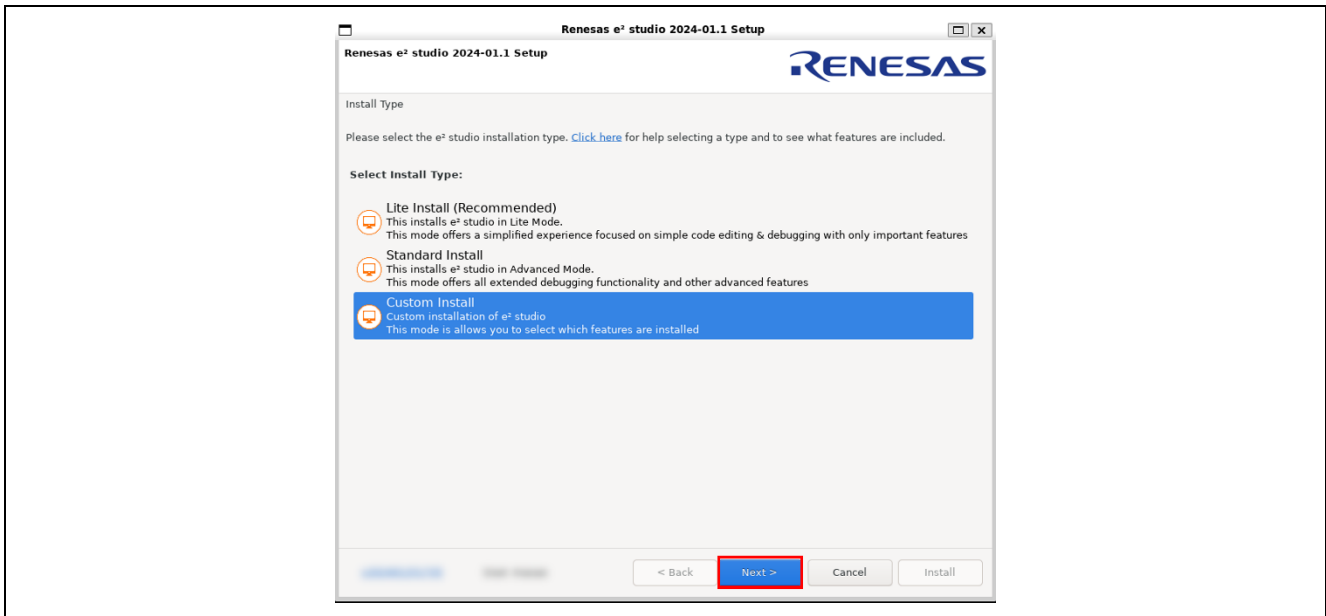

Figure 15: Selection of Install Type

- **Welcome**

User can change the install folder by clicking [Change...]. Click [Next >] to continue.

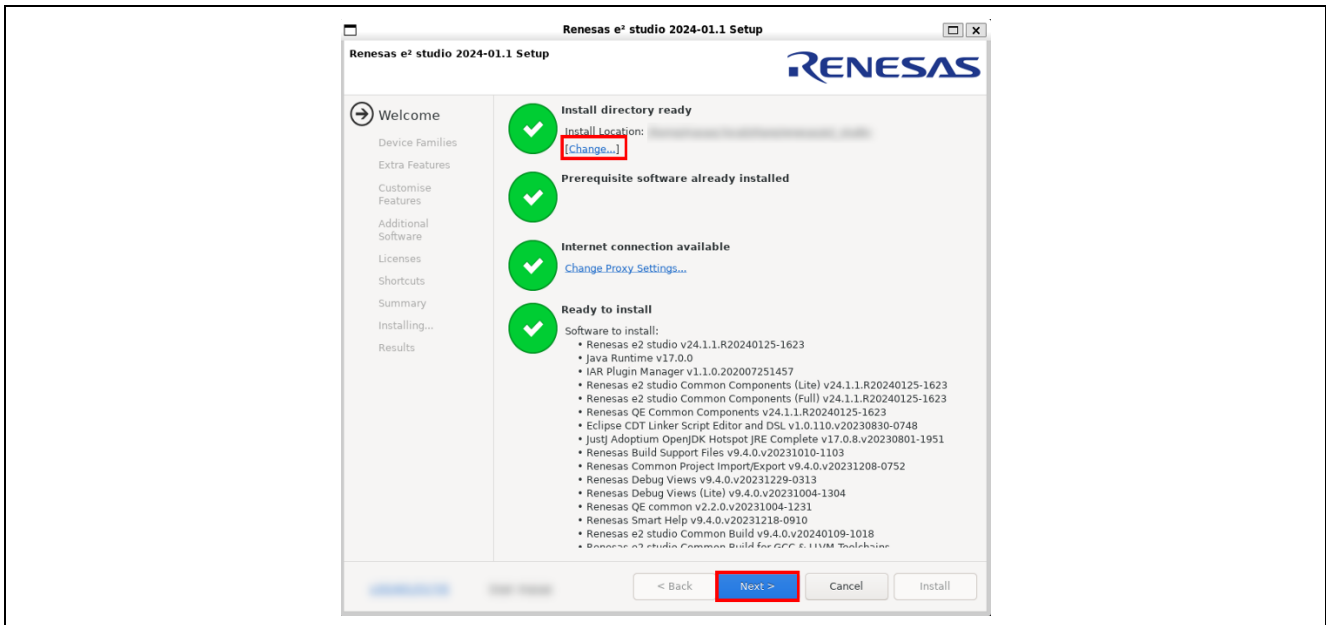
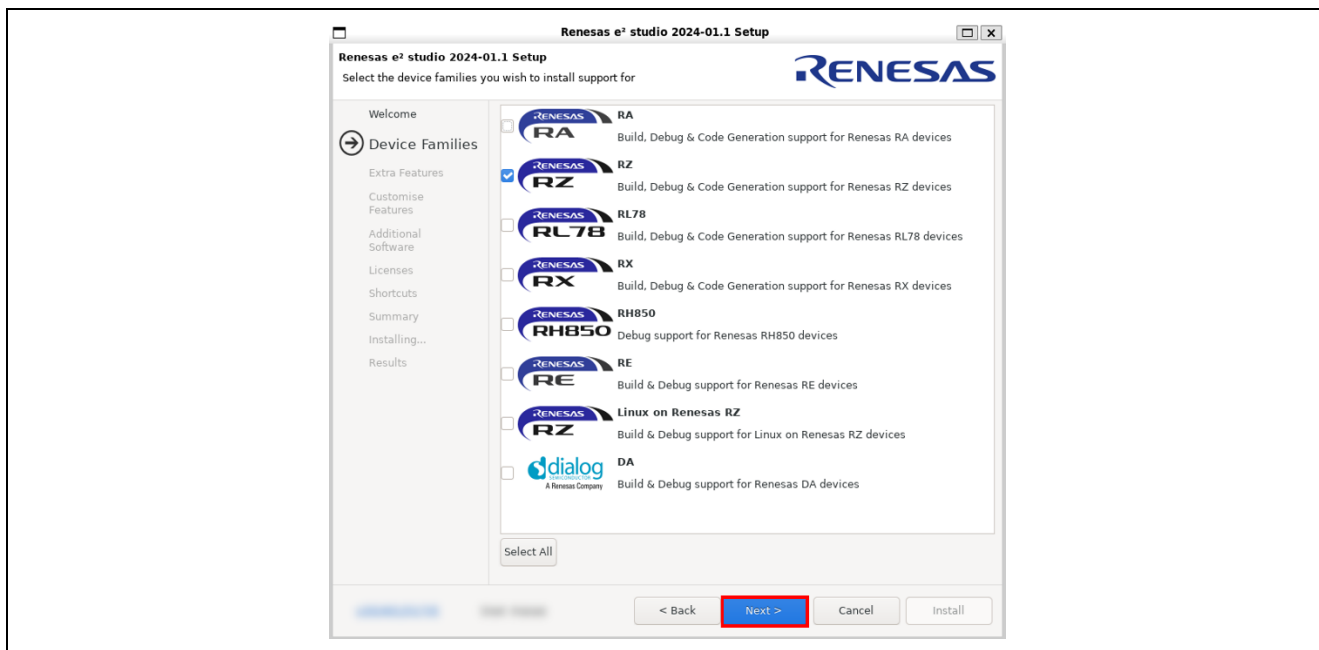

Figure 16: Installation of e2 studio – Welcome page

- Notes:
1. If you would like to have multiple versions of e2 studio, please specify another directory here.
  2. Multi-byte characters cannot be used for e2 studio installation directory name.

- **Device Families**

Select Devices Families to install. Click [Next >] to continue.



**Figure 17: Installation of e2 studio – Device Families**

- **Extra Features**

Select Extra Features (e.g., Language packs, SVN & Git support...) to be installed. For non-English language users, please select Language packs at this step if needed. Then, click [Next >] to continue.

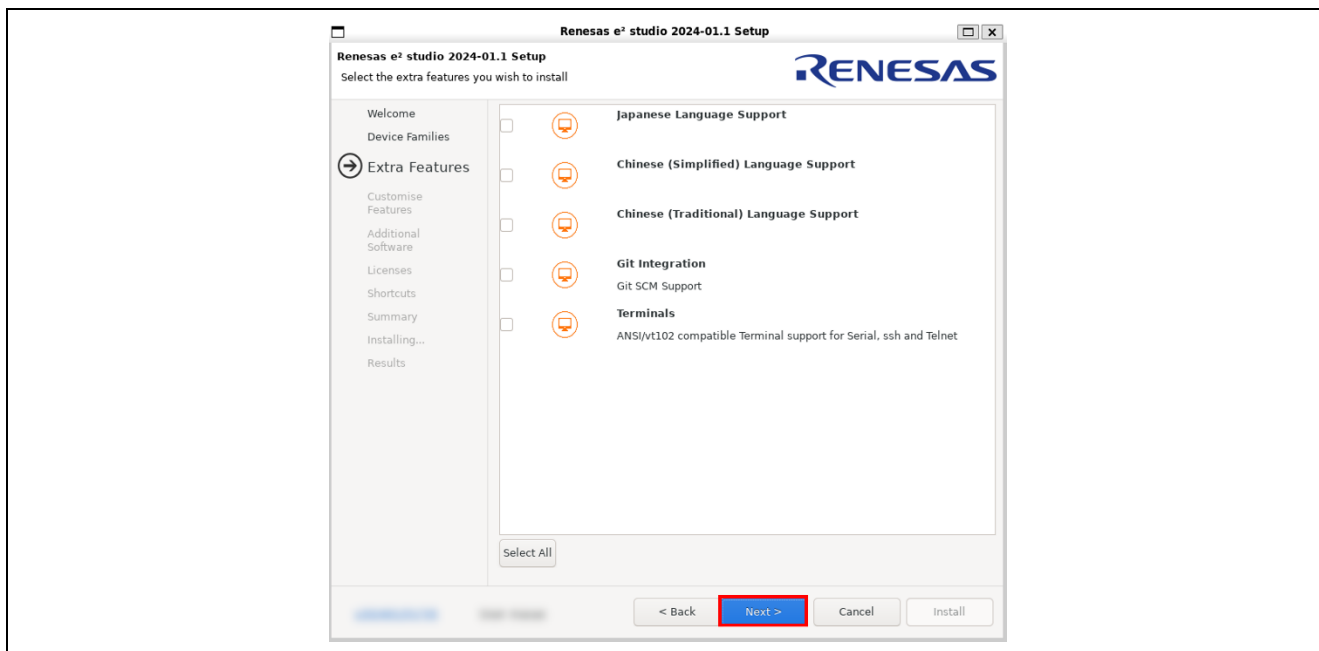

**Figure 18: Installation of e2 studio – Extra Features**

- **Customize Features**

Select the components to install and click the [Next >] to continue. Be sure that **Renesas FSP Smart Configurator Core** and **Renesas FSP Smart Configurator ARM** are selected.

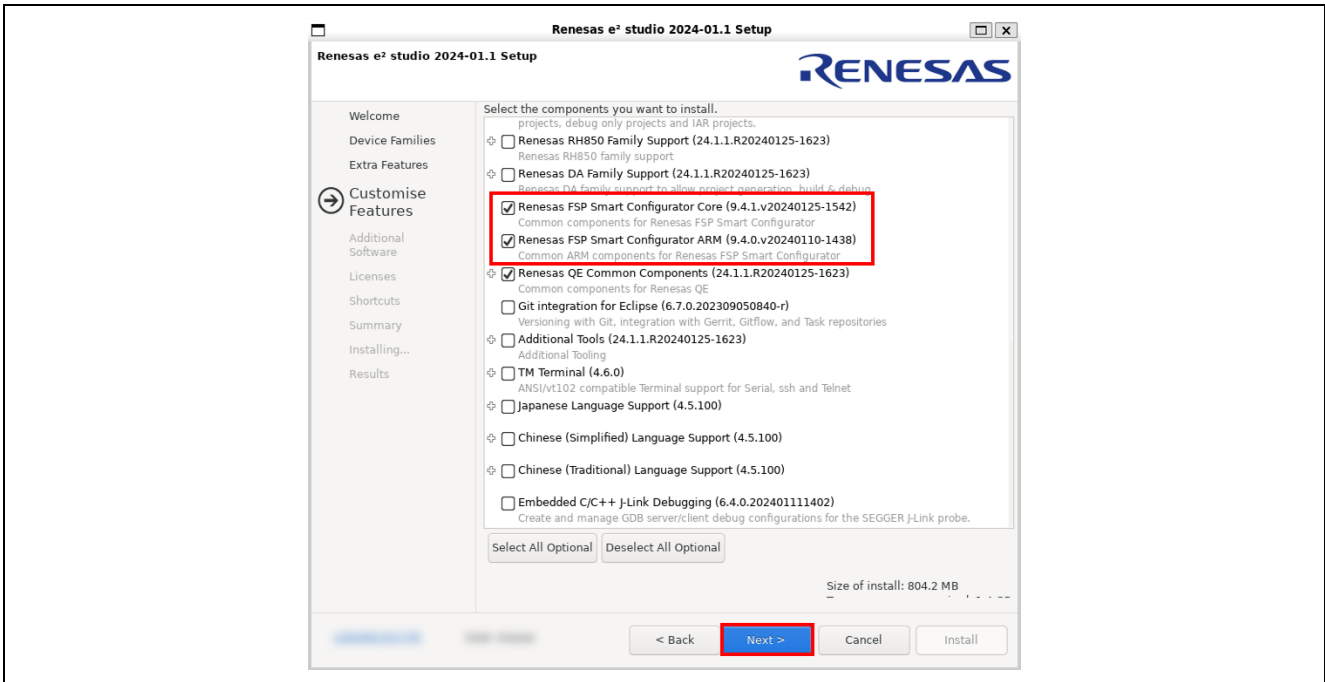

Figure 19: Installation of e2 studio – Customise Features

- **Additional Software**

Select the additional software (e.g., GCC Toolchains, Utilities and so on) to be installed and then, click [Next >] to continue. When following the procedure described in this material, there is no need to choose any software.

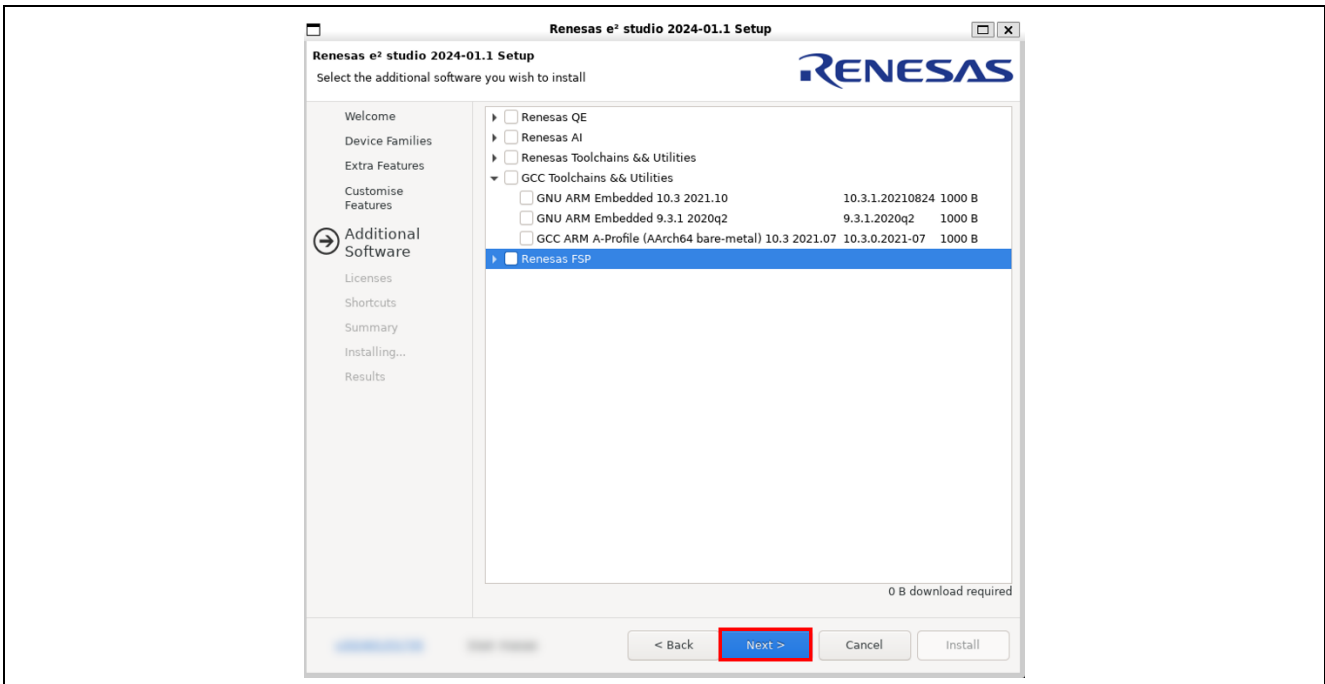

Figure 20: Installation of e2 studio – Customise Features

- **Licenses**

Read and accept the software license agreements listed below. Then, click [Next >] to continue. Note that the user must accept the license agreement, otherwise installation cannot be continued.

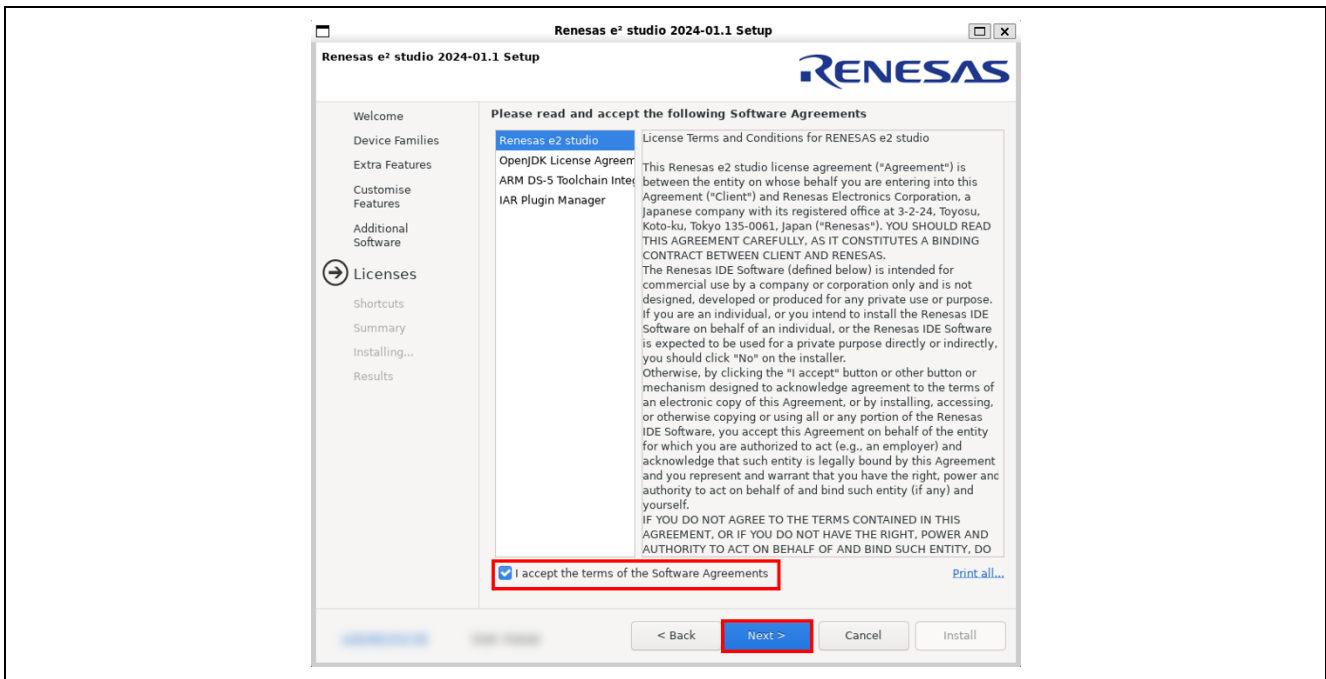

Figure 21: Installation of e2 studio – Licenses

- **Shortcuts**

If you would like to create the shortcut for e2 studio, check the **In the application launcher** as shown below and click [Next >] to continue.

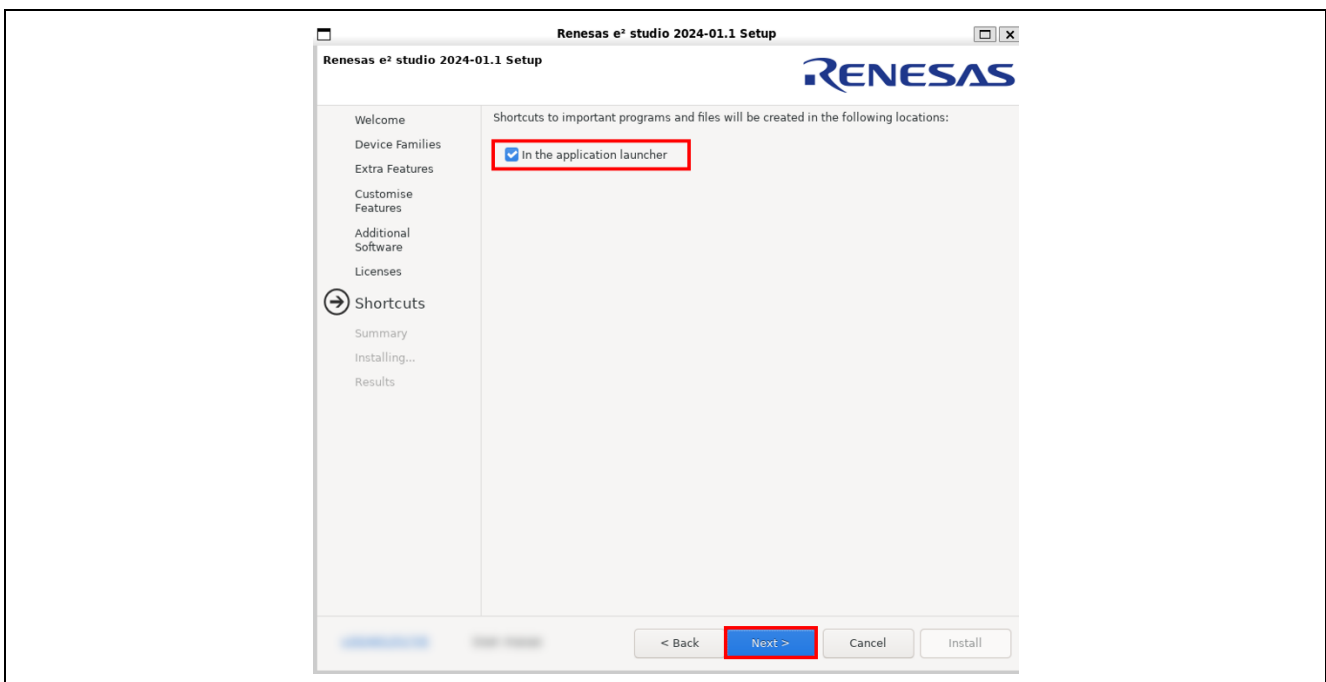

Figure 22: Installation of e2 studio – Shortcuts

- Summary

List of software to install is shown as follows. Click [Install] to start the installation.

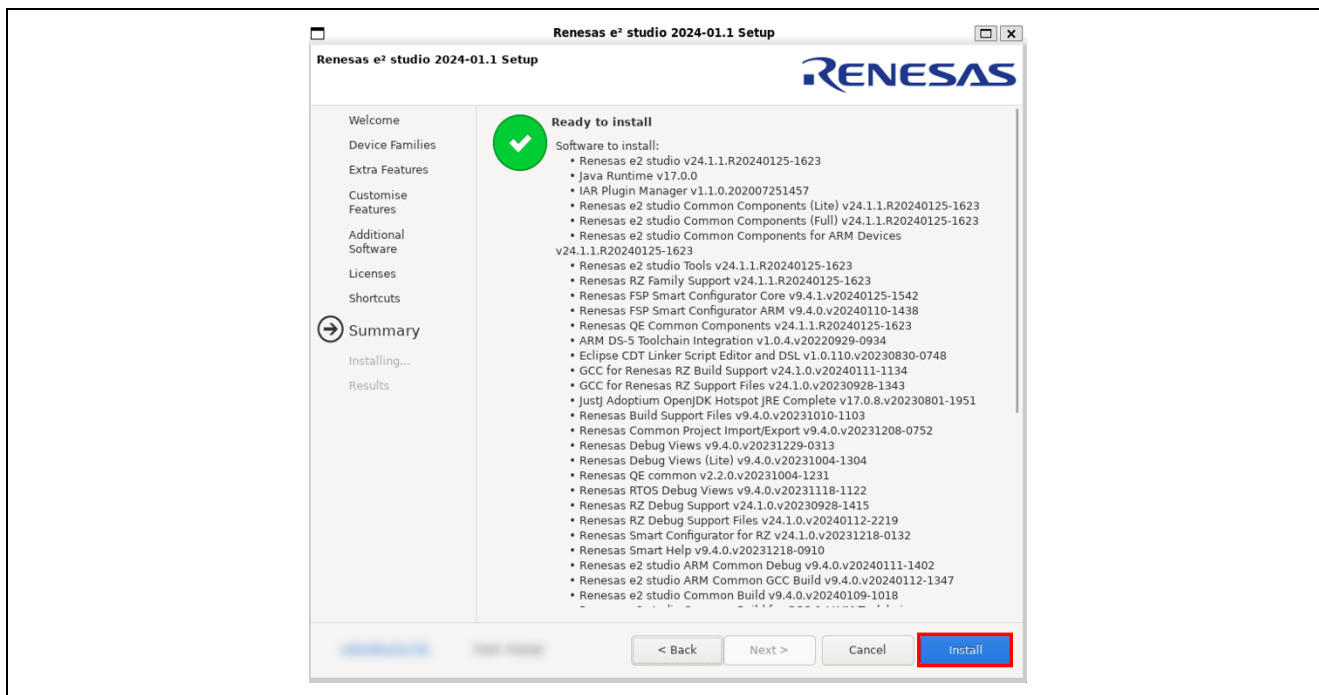

Figure 23: Installation of e2 studio – Summary

- Installing...

Installation should be performed as shown below.

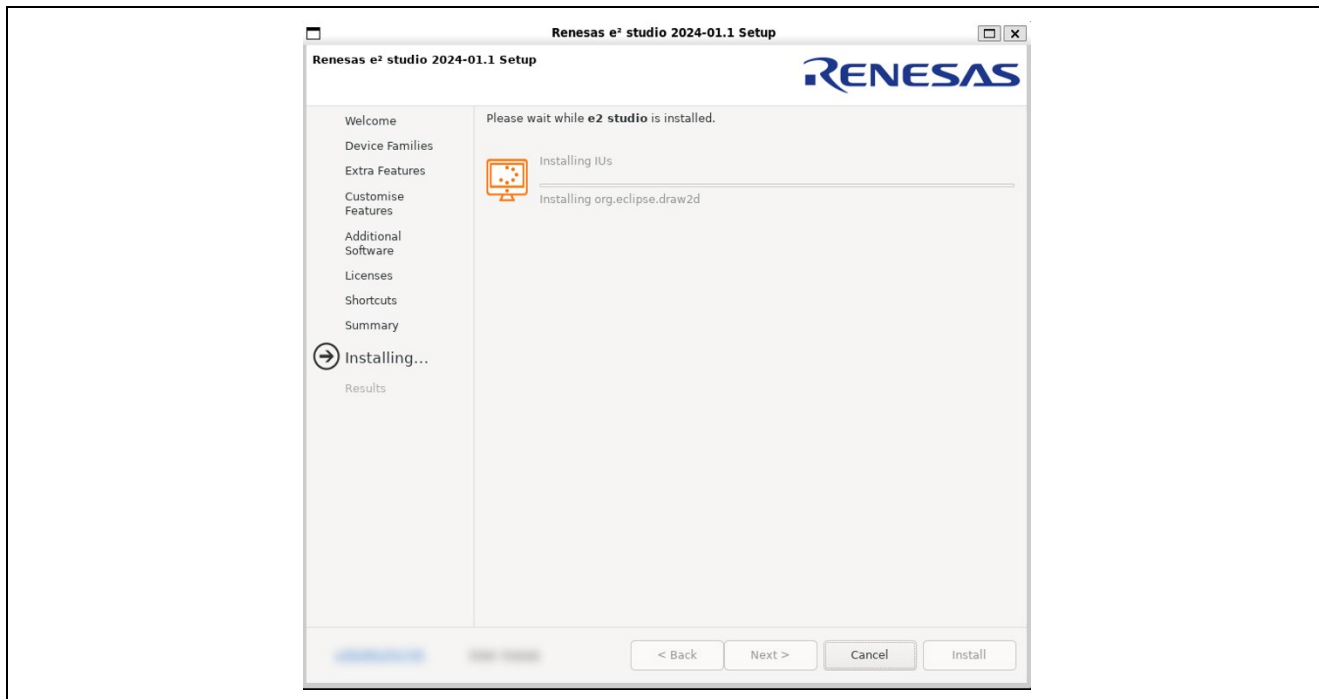

Figure 24: Installation of e2 studio – Installing...

- Results  
Click [OK] to complete the installation.

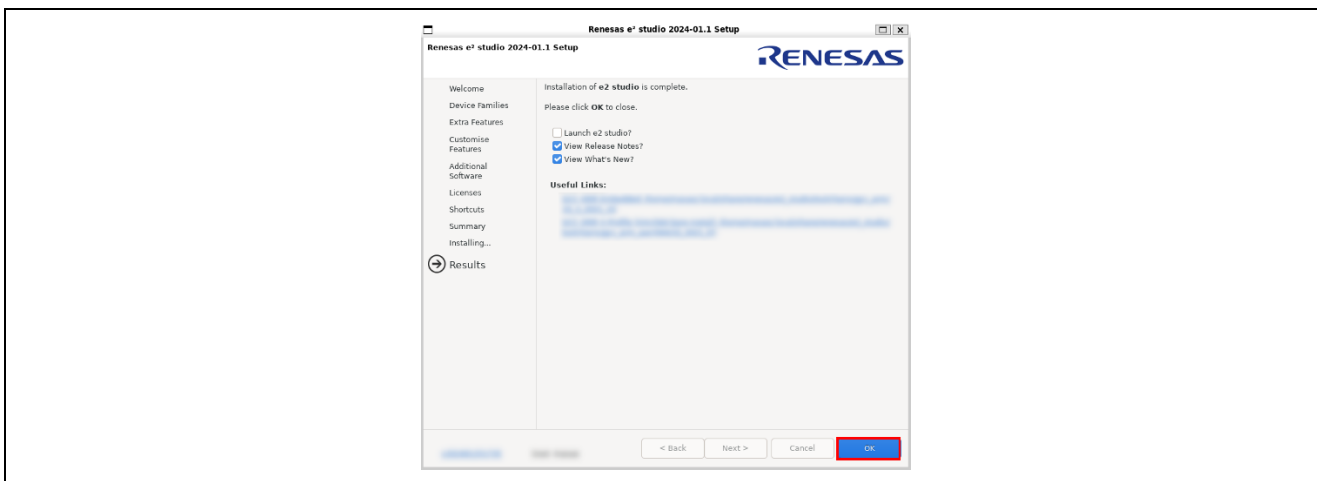

Figure 25: Installation of e2 studio – Results

### 2.1.4.3 Add GNU ARM Embedded Toolchain on e2 studio IDE

1. Launch e2 studio  
Specify the workspace path and launch the e2 studio.

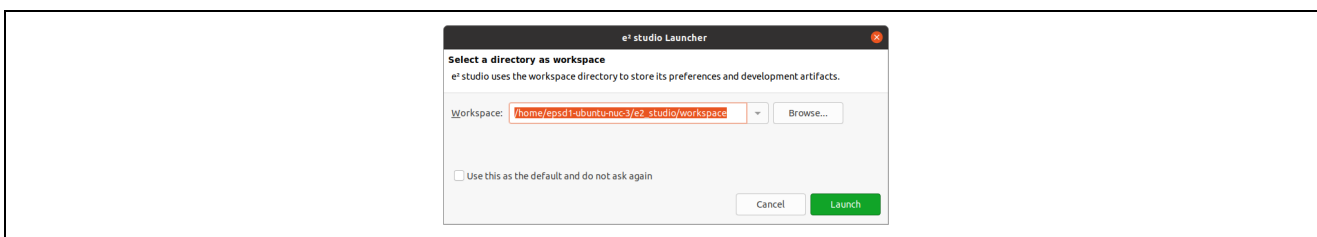

Figure 26: e2 studio Launcher

2. Add Renesas Toolchains  
Select [Help] -> [Add Renesas Toolchains] then you can see the [Preferences] window. After that Click [Add] button.

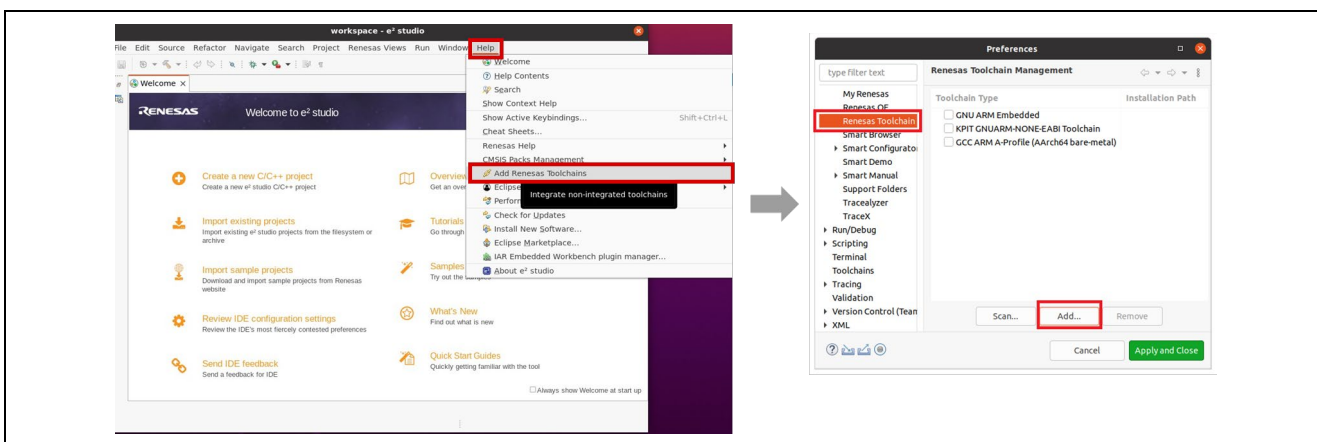

Figure 27: Add Renesas Toolchains

3. Add New Toolchain

Specify the path of the GNU ARM Embedded Toolchain. Click [OK]

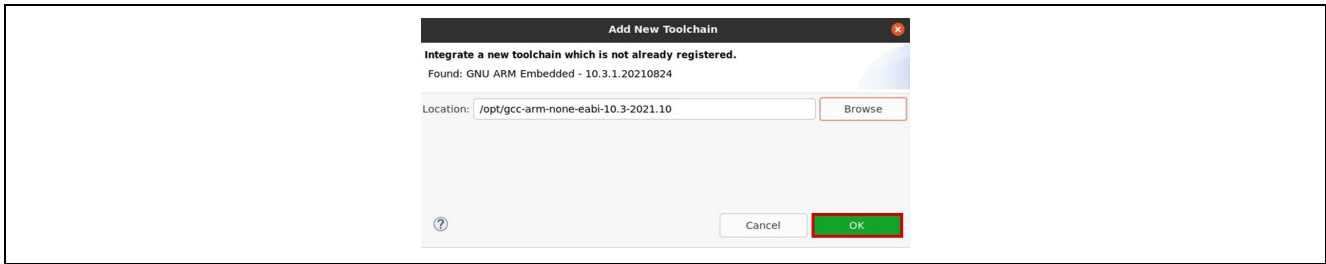

Figure 28: Add New Toolchain

4. Apply

Confirm that the GNU ARM Embedded is checked. Click [Apply and Close].

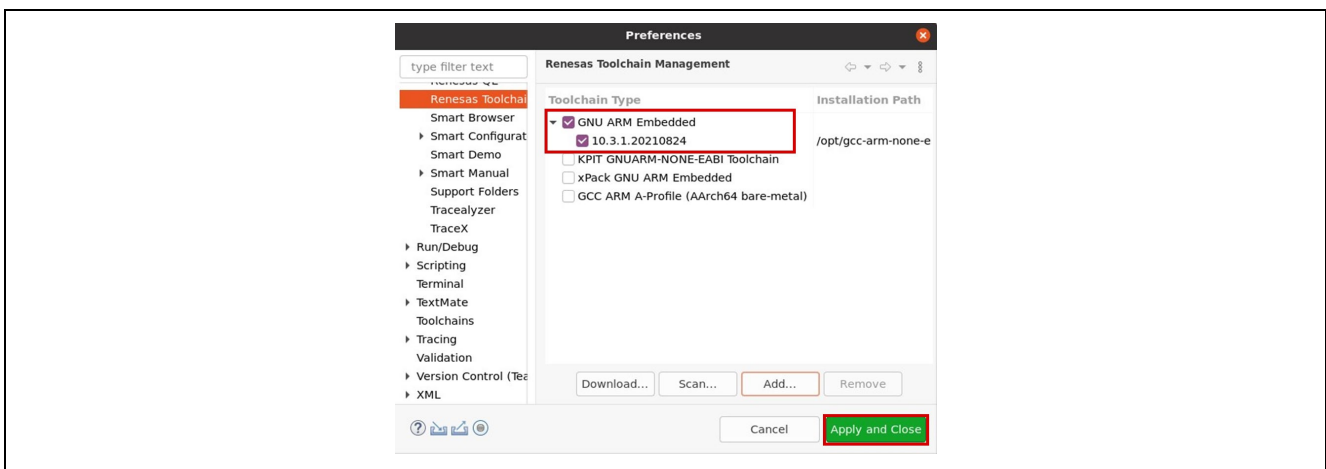

Figure 29: Apply New Toolchain

## 2.2 FSP setup

### 2.2.1 Installation of FSP using Package Installer

Package Installer **RZG\_FSP\_Packs\_v2.0.1.exe** is showcased at [here](#). This section describes the procedure for installation. Note that it's for Windows Host PC only.

1. Quit e2 studio.
2. Invoke **RZG\_FSP\_Packs\_v2.0.1.exe**.
3. Click [Next >] to start the installation.

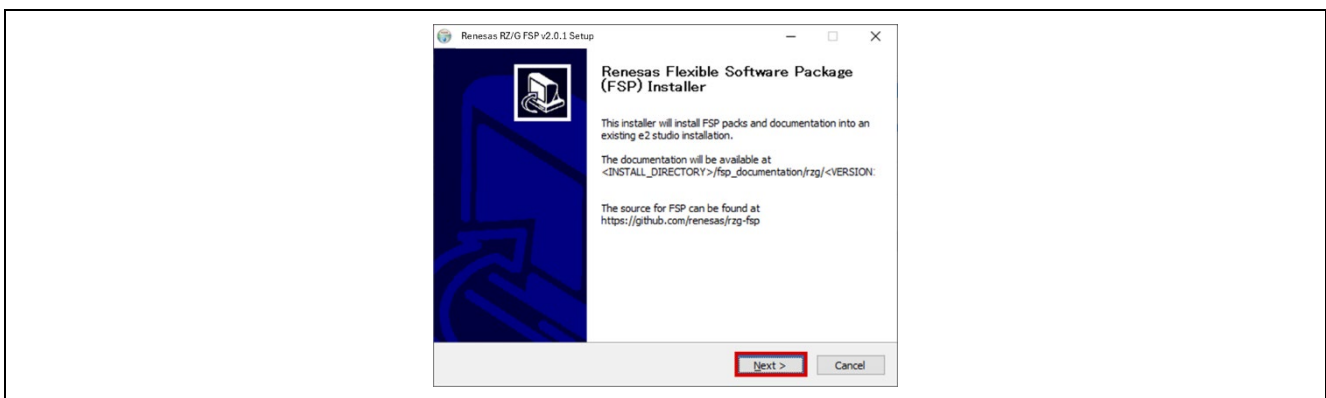

Figure 30: FSP Package Installer



4. See the license term and click [I Agree] if it's acceptable.

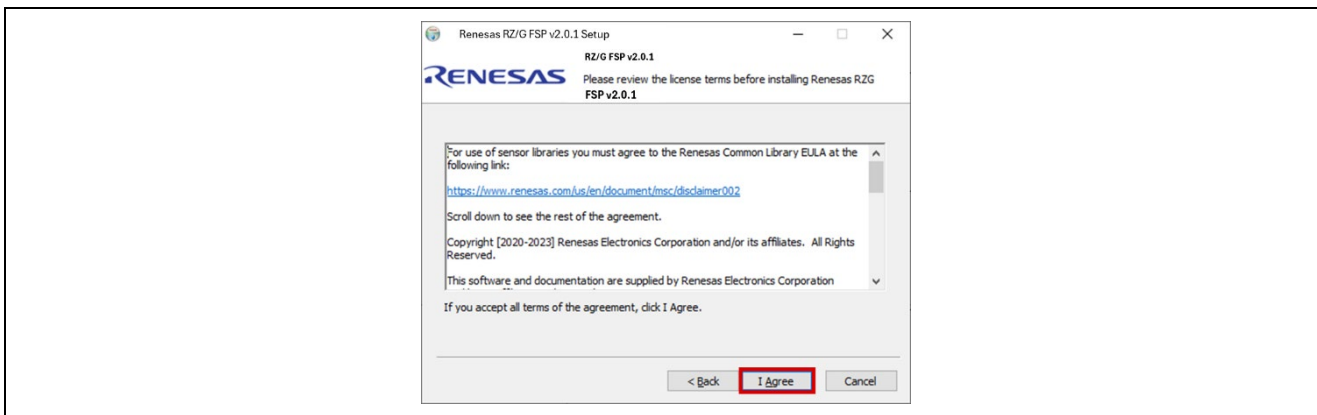

Figure 31: FSP License Term

5. Specify e2 studio installation folder (e.g., C:\Renesas\e2studio) and click [Install].

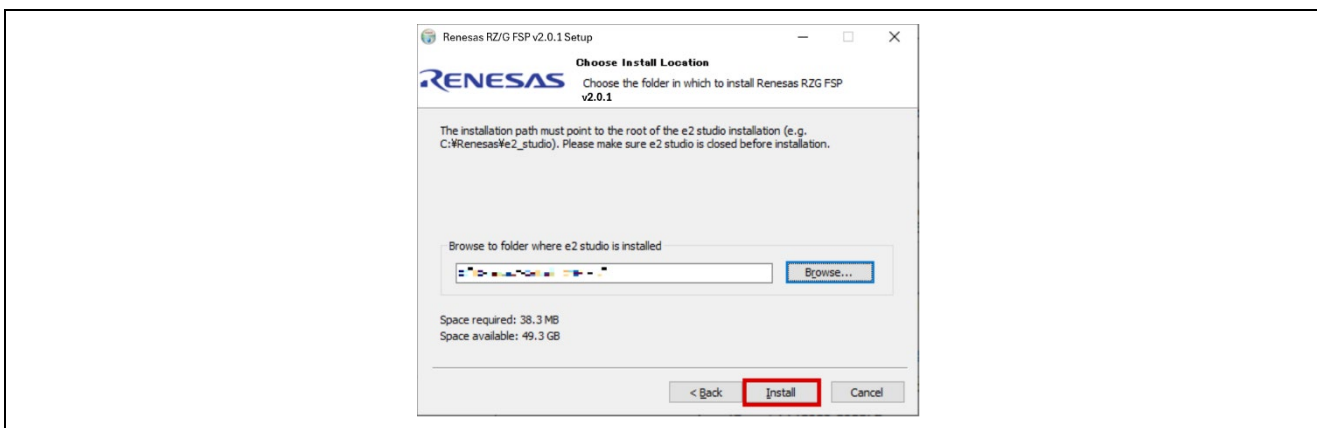

Figure 32: Browse to the folder where e2 studio is installed

6. Click [Finish] to complete the installation.

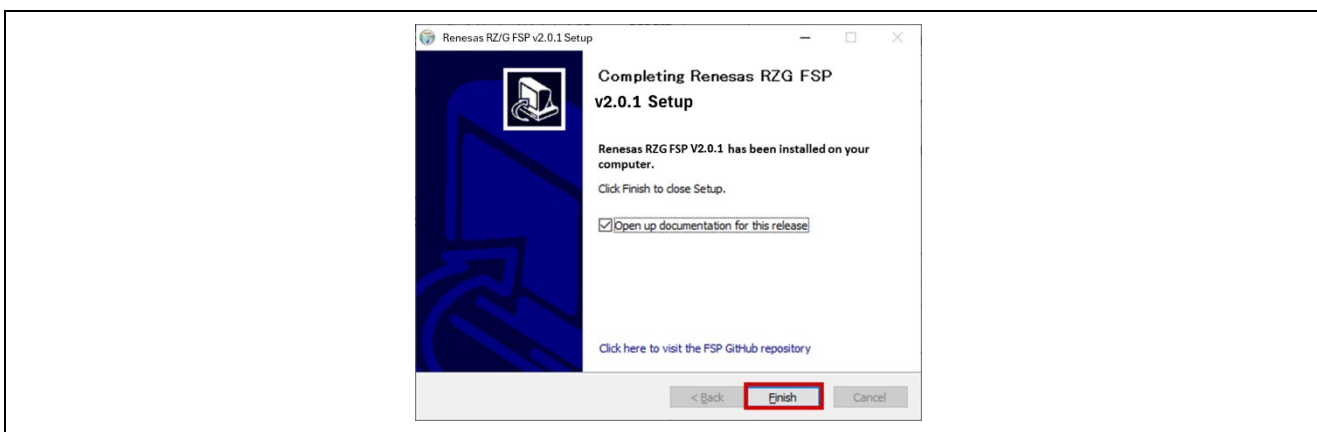

Figure 33: Completion of FSP Installation

If the box **Open up documentation for this release** is checked at that time, FSP documentation for the installed version of FSP should be opened.

### 2.2.2 Installation of FSP Packs using Package Zip file

No package installer is available for Linux Host PC. Thus, you need to install FSP with the zip file **RZG\_FSP\_Packs\_v2.0.1.zip**. This section describes the procedure for installation.

1. Download RZG\_FSP\_Packs\_v2.0.1.zip from [here](#).
2. Extract the zip file to e2 studio installation directory. If it's successfully extracted, **rz\_fsp/rzg/packs** should be placed at **<e2 studio installation directory>/Internal/projectgen**.

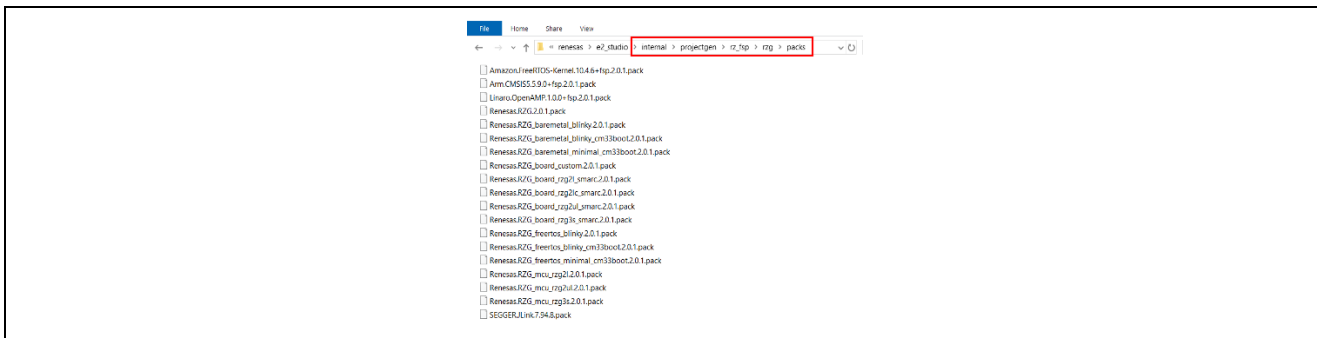

Figure 34: FSP Packs on e2studio installation directory

3. At the 1st invocation of e2 studio after the extraction, FSP should be automatically installed.
4. You can check if the installation is successfully done by the procedure below:
  - Click **Help > CMSIS Packs Management > Renesas RZ/G**

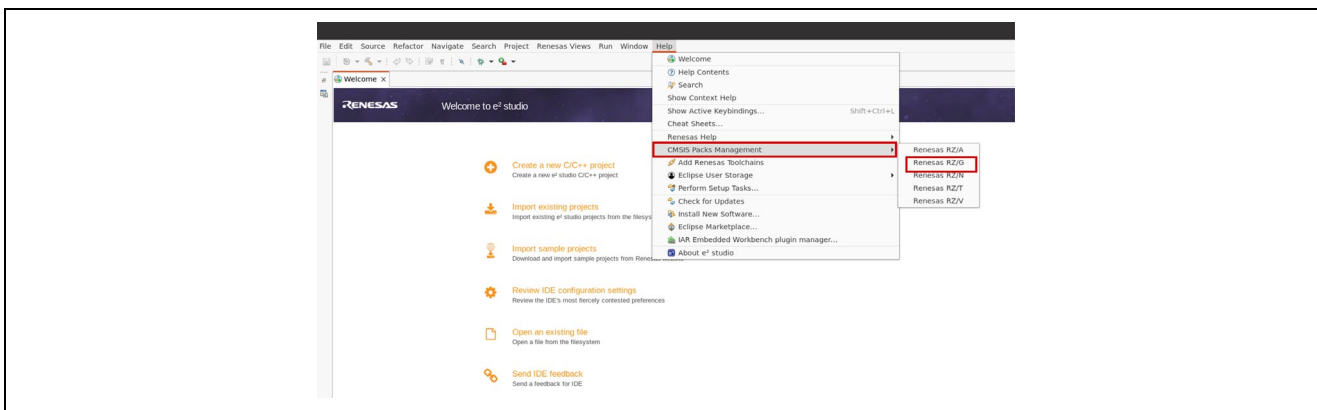

Figure 35: CMSIS Packs Management (1)

- If FSP is successfully installed, 2.0.1 should be listed under FSP as shown below:

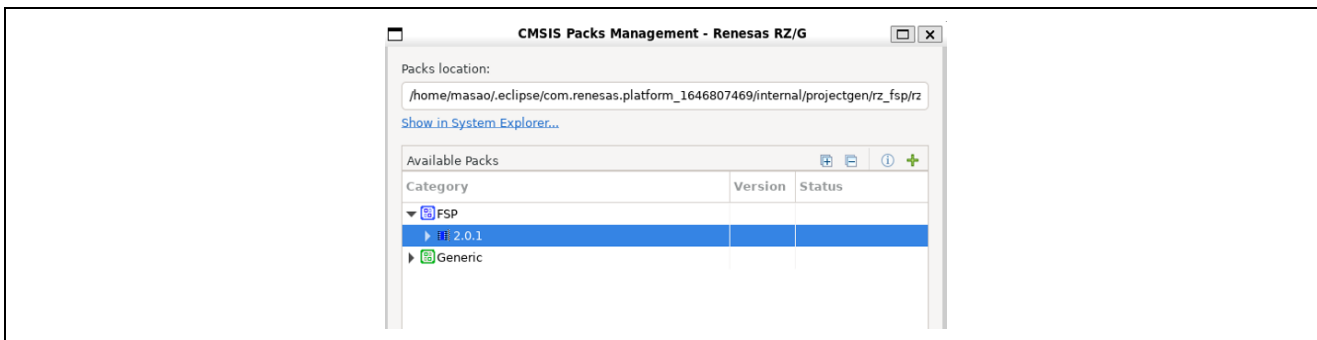

Figure 36: CMSIS Packs Management (2)

### 3. Set up an SMARC EVK

#### 3.1 RZ/G2L SMARC EVK

Below is an example of a typical system configuration.

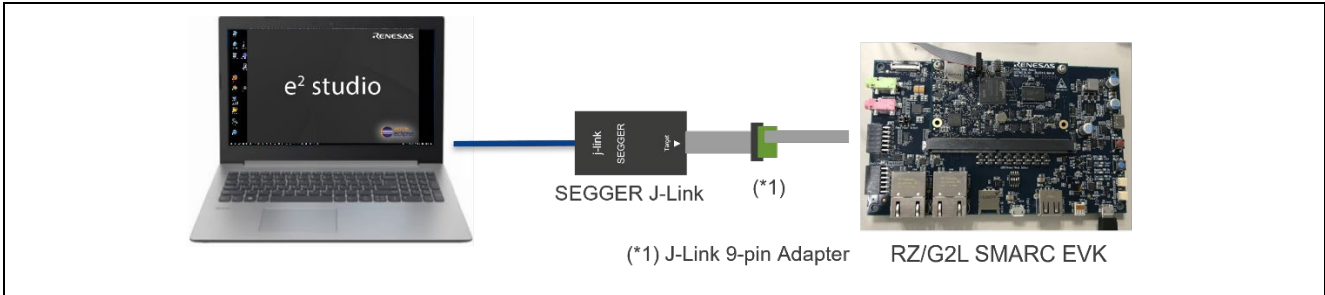

Figure 37: System Configuration Example – RZ/G2L SMARC EVK

#### 3.1.1 Supported Debugger

- SEGGER J-Link

For details on SEGGER J-Link, please see [J-Link Debug Probes by SEGGER – the Embedded Experts](#).

#### 3.1.2 Board Setup

##### 3.1.2.1 Boot MODE

To set the board to Boot mode 3(QSPI Boot (1.8V) Mode), set the SW11 as below.

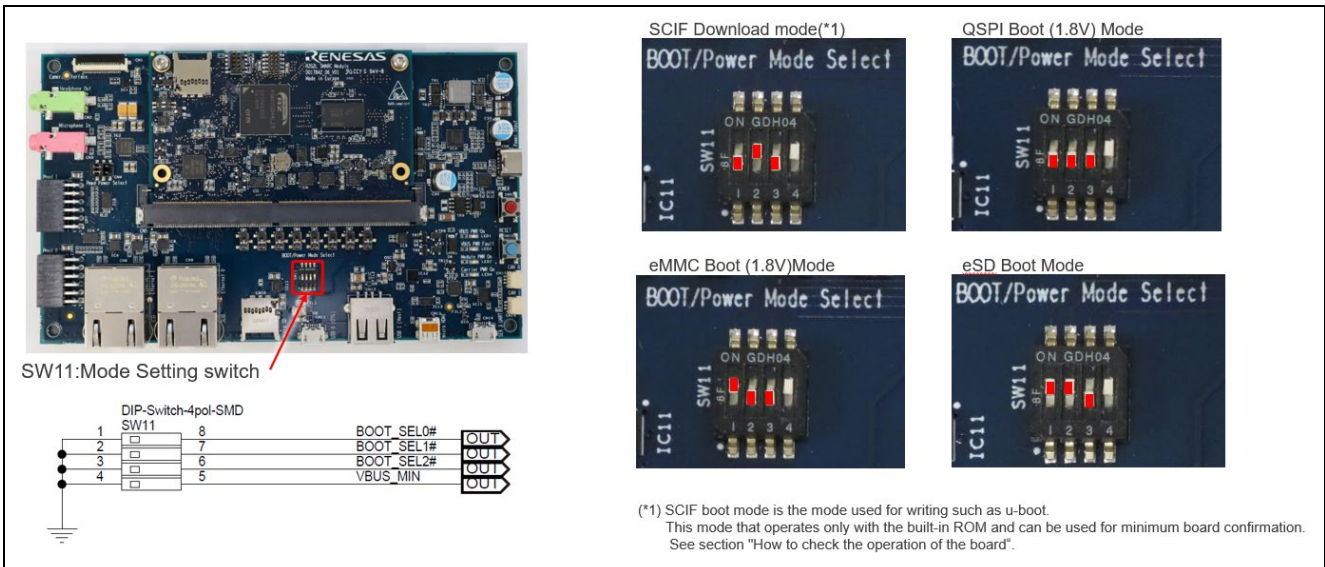

Figure 38: Boot MODE

### 3.1.2.2 JTAG connection

When connecting JTAG, you must set the DIP SW1 settings as follows:

CN2 : JTAG 10pin ARM standard connector

ARM Cortex Micro JTAG / SWD 0.05" pitch 10pin Ribbon Cable

CN1 is a connector for analog signal input. Please careful not to accidentally connect the JTAG cable.

SW1:JTAG debug setting switch

SW1-1	DEBUGEN	SW1-2	microSD/eMMC selection
OFF	JTAG debug mode	OFF	Select eMMC on SMARC Module
ON	Normal operation	ON	Select microSD slot on SMARC Module

The selection of microSD slot and eMMC on the SMARC module is exclusive.

Figure 39: JTAG connection

Please note that RZ/G2L SMARC EVK has CoreSight 10 connector and therefore, the following adapter must be needed to connect Segger J-Link.

<https://www.segger.com/products/debug-probes/j-link/accessories/adapters/9-pin-cortex-m-adapter/>

### 3.1.2.3 Debug Serial (console output)

Debug serial uses CN14. The baud rate is 115200bps.

CN14 : USB Type-microB Connector used as SCIF3

To PC

USB Type-microB cable

CN14:USB Type-microB Connector

Figure 40: Debug Serial (console output)



### 3.1.2.4 Power Supply

Here are the power supply related goods to be used in Renesas' development. Please prepare for the equivalent ones for your development.

- USB Type-C cable CB-CD23BK (manufactured by Aukey)
- USB PD Charger Anker PowerPort III 65W Pod (manufactured by Anker)

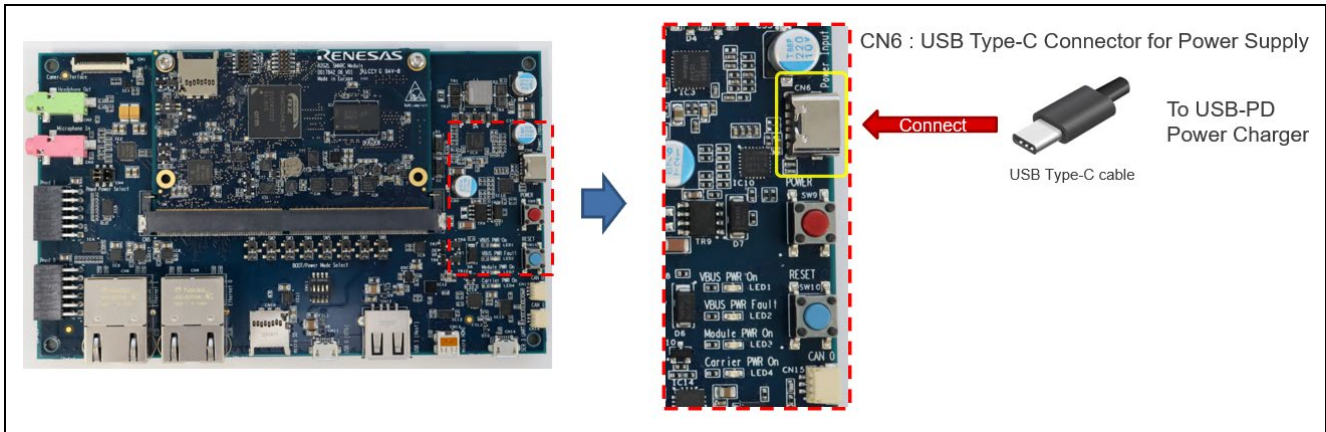

Figure 41: Power Supply

Connect USB-PD Power Charger to USB Type-C Connector. Then LED1(VBUS PWR On) and LED3 (Module PWR On) lights up. Press SW9 to turn on the power. Then LED4(Carrier PWR On) lights up.

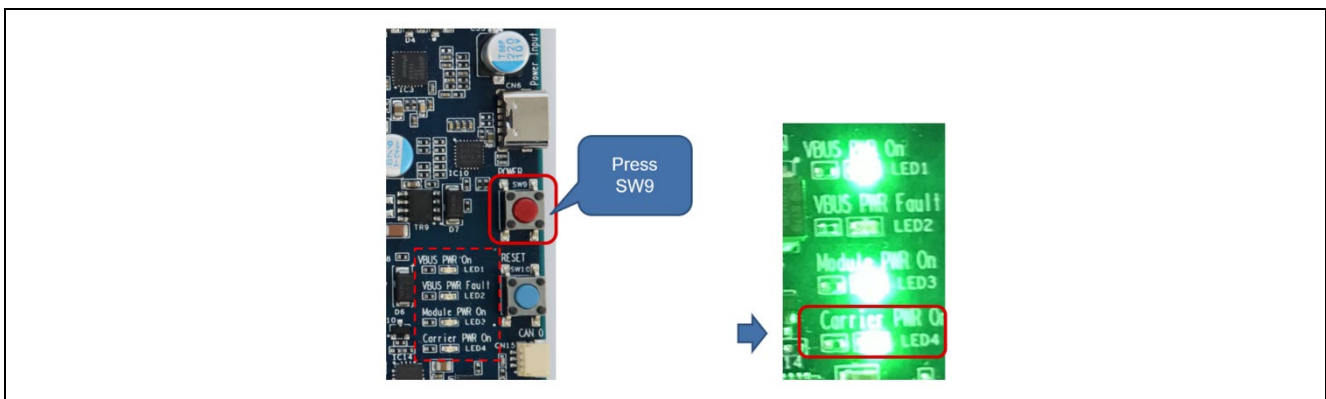

Figure 42: LED Status after Turning on EVK

### 3.1.2.5 How to check the operation of the board

First, check the board for problems. There are two ways to do this. Please check with either.

#### BOOT MODE: QSPI Boot (1.8V) Mode

If u-boot is written to the serial flash, When the power is turned on, the following will be output to the console (CN14).

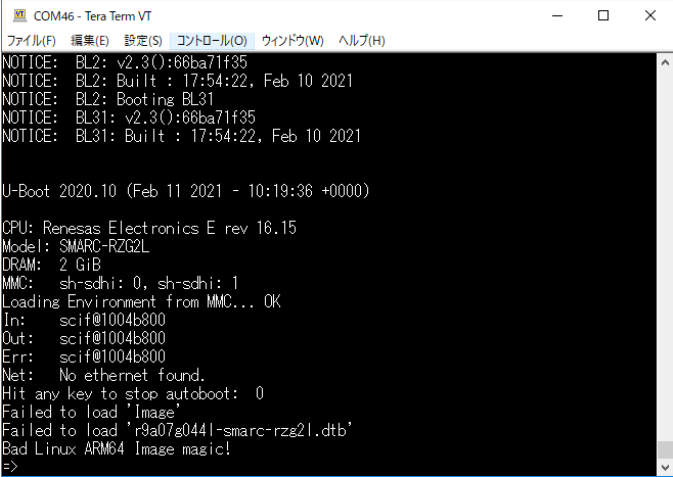

```
COM46 - Tera Term VT
ファイル(F) 編集(E) 設定(S) コントロール(O) ウィンドウ(W) ヘルプ(H)
NOTICE: BL2: v2.3(0):66ba71f35
NOTICE: BL2: Built : 17:54:22, Feb 10 2021
NOTICE: BL2: Booting BL31
NOTICE: BL31: v2.3(0):66ba71f35
NOTICE: BL31: Built : 17:54:22, Feb 10 2021

U-Boot 2020.10 (Feb 11 2021 - 10:19:36 +0000)

CPU: Renesas Electronics E rev 16.15
Model: SMARC-RZG2L
DRAM: 2 GiB
MMC: sh-sdhi: 0, sh-sdhi: 1
Loading Environment from MMC... OK
In:   scif@1004b800
Out:  scif@1004b800
Err:  scif@1004b800
Net:  No ethernet found.
Hit any key to stop autoboot:  0
Failed to load 'Image'
Failed to load 'r9a07g0441-smarc-rzg2l.dtb'
Bad Linux ARM64 Image magic!
=>
```

#### BOOT MODE: SCIF Download Mode

When the power is turned on, the following will be output to the console (CN14).

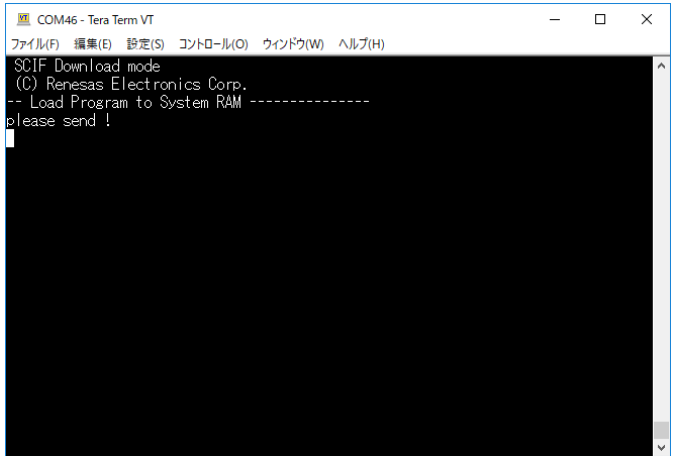

```
COM46 - Tera Term VT
ファイル(F) 編集(E) 設定(S) コントロール(O) ウィンドウ(W) ヘルプ(H)
SCIF Download mode
(C) Renesas Electronics Corp.
-- Load Program to System RAM -----
please send !
```

### 3.2 RZ/G3S SMARC EVK

Below is an example of a typical system configuration.

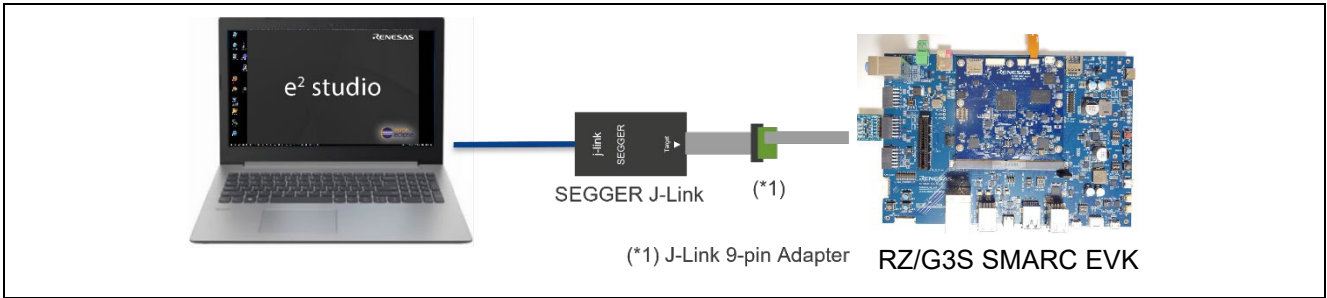

Figure 43: System Configuration Example – RZ/G3S SMARC EVK

#### 3.2.1 Supported Debugger

- SEGGER J-Link

For details on SEGGER J-Link, please see [J-Link Debug Probes by SEGGER – the Embedded Experts](#).

#### 3.2.2 Board Setup

##### 3.2.2.1 Boot MODE

Set the boot mode using the two DIP SWITCHES shown in the figure below.

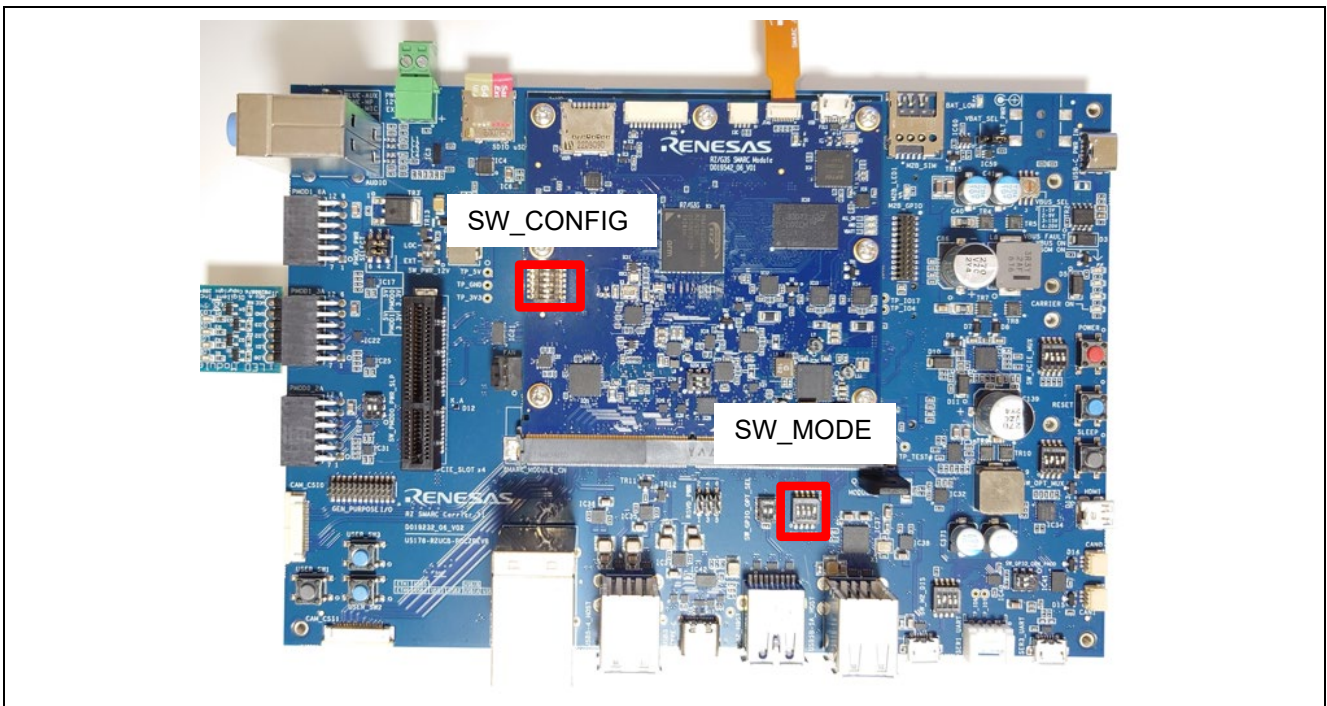

Figure 44: Boot MODE

In SW\_CONFIG, select the boot CPU with the following settings.

1	2	3	4	5	6
OFF	OFF	ON	OFF	OFF	ON: CM33 boot OFF: CA55 boot

In SW\_MODE, select the boot device with the following settings.

- Boot Mode 1: Booting from eMMC

<b>1</b>	<b>2</b>	<b>3</b>	<b>4</b>
ON	OFF	OFF	ON

- Boot Mode 2: Booting from serial flash memory

<b>1</b>	<b>2</b>	<b>3</b>	<b>4</b>
OFF	OFF	OFF	ON

- Boot Mode 3: Booting from the program downloaded through the serial communications with FIFO (SCIF)

<b>1</b>	<b>2</b>	<b>3</b>	<b>4</b>
OFF	ON	OFF	ON

### 3.2.2.2 JTAG connection

For JTAG connection, connect the included “SMARC JTAG ADAPTOR” to the board.

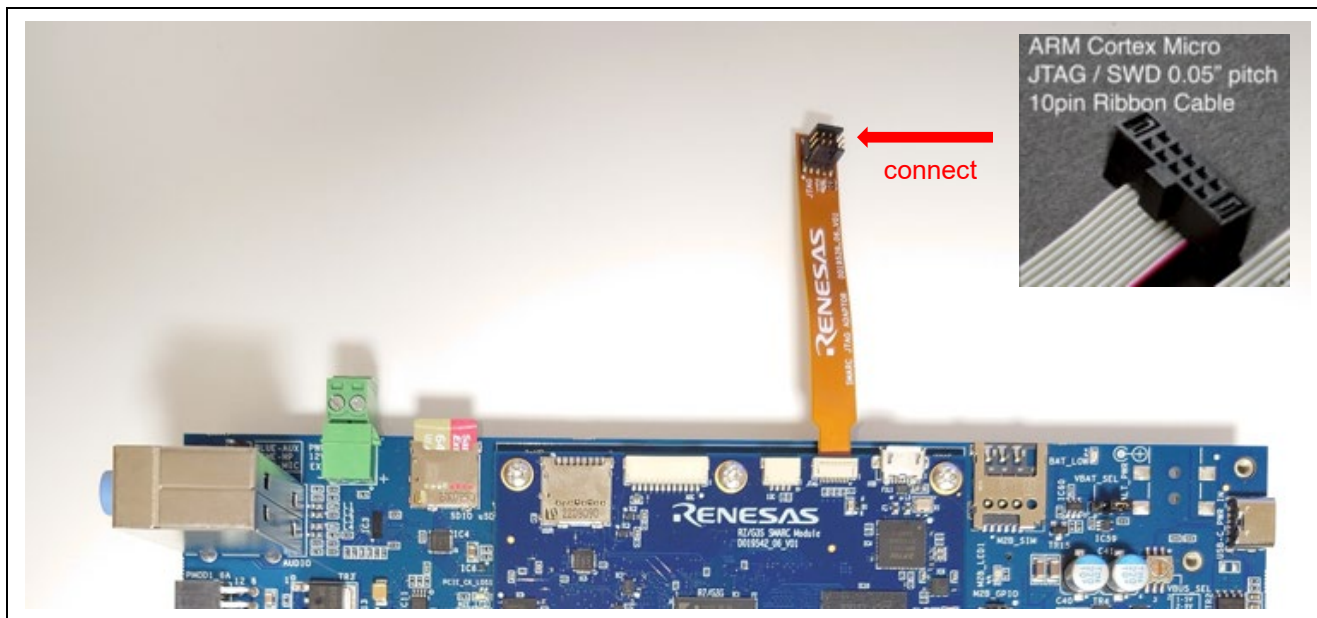

Figure 45: JTAG connection

Please note that RZ/G3S SMARC EVK has CoreSight 10 connector and therefore, the following adapter must be needed to connect Segger J-Link.

<https://www.segger.com/products/debug-probes/j-link/accessories/adapters/9-pin-cortex-m-adapter/>



### 3.2.2.3 Debug Serial (console output)

Debug serial uses SER3\_UART(SCIFA ch0). The baud rate is 115200bps.

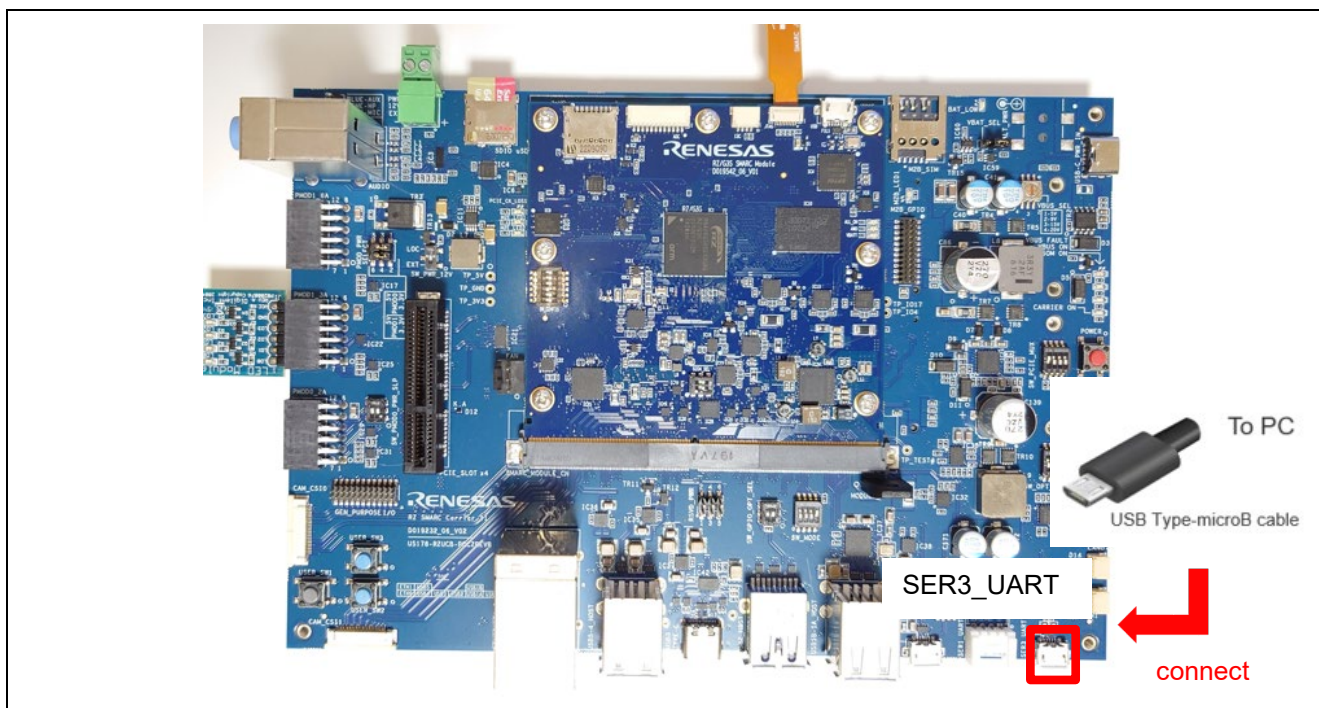

Figure 46: Debug Serial(console output)

### 3.2.2.4 Power Supply

Here are the power supply related goods to be used in Renesas' development. Please prepare for the equivalent ones for your development.

- USB Type-C cable CB-CD23BK (manufactured by Aukey)
- USB PD Charger Anker PowerPort III 65W Pod (manufactured by Anker)

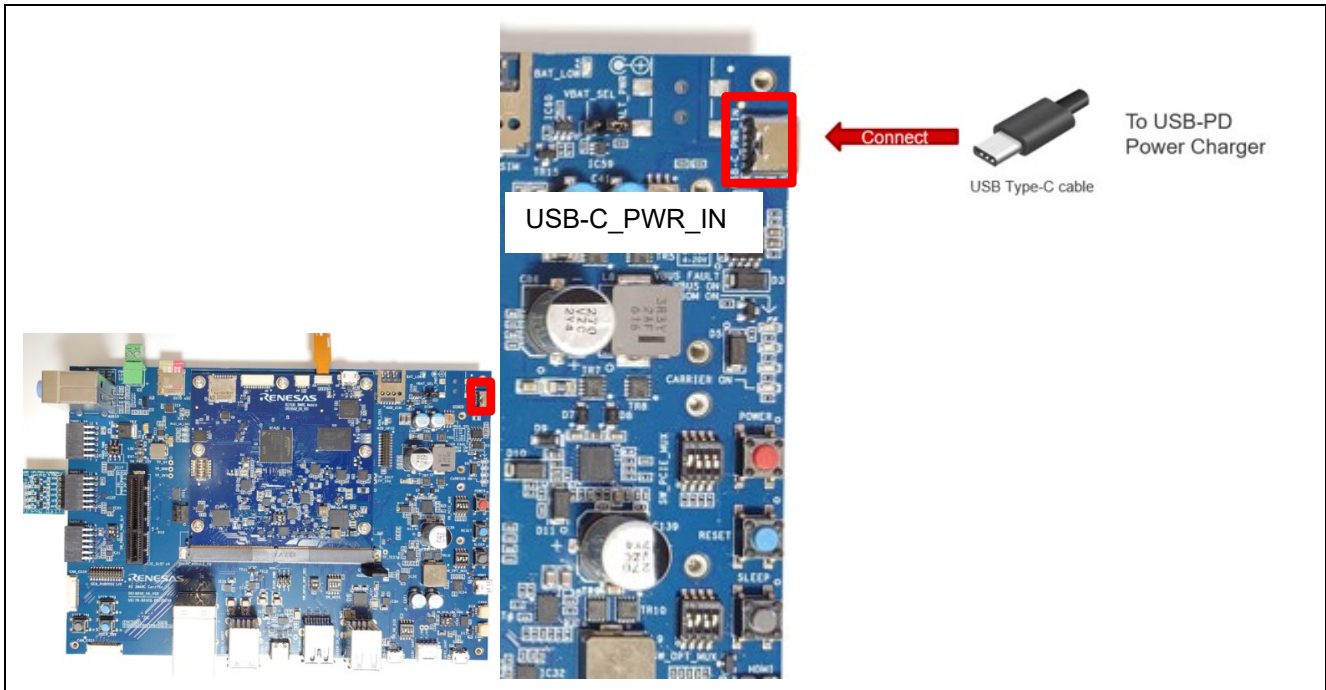

Figure 47: Power Supply

Connect USB-PD Power Charger to USB Type-C Connector. Then VBUS ON and SOM ON lights up. Press POWER to turn on the power. Then CARRIER ON lights up.

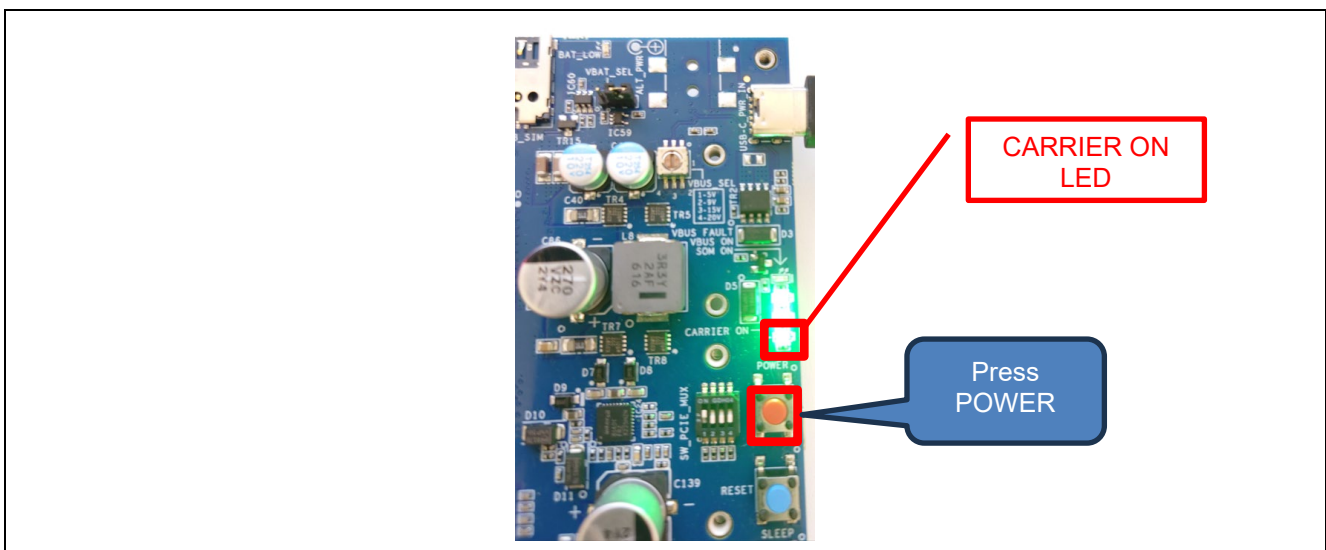

Figure 48: LED Status after Turning on EVK

### 3.2.2.5 How to check the operation of the board

First, check the board for problems. There are three ways to do this. Please check with any of them.

#### BOOT MODE1: Booting from eMMC

If u-boot is written to the eMMC, When the power is turned on, the following will be output to the console (SER3\_UART).

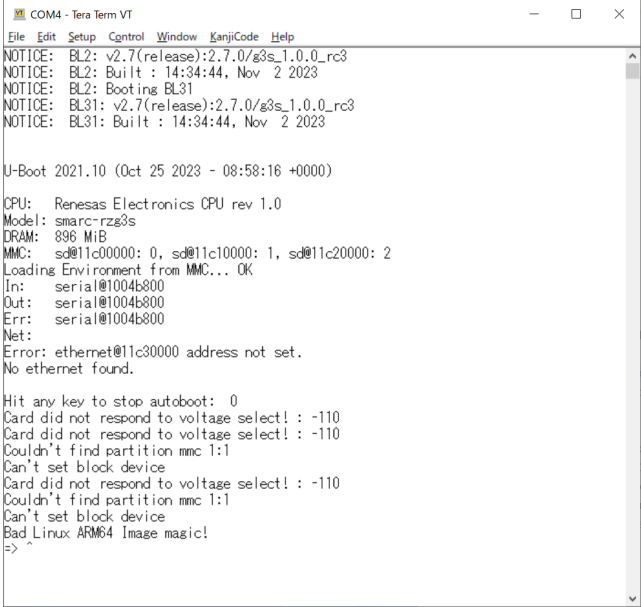

```
COM4 - Tera Term VT
File Edit Setup Control Window KanjiCode Help
NOTICE: BL2: v2.7(release):2.7.0/g3s_1.0.0_rc3
NOTICE: BL2: Built : 14:34:44, Nov 2 2023
NOTICE: BL2: Booting BL31
NOTICE: BL31: v2.7(release):2.7.0/g3s_1.0.0_rc3
NOTICE: BL31: Built : 14:34:44, Nov 2 2023

U-Boot 2021.10 (Oct 25 2023 - 08:58:16 +0000)

CPU:   Renesas Electronics CPU rev 1.0
Model: smarc-rzg3s
DRAM:  896 MiB
MMC:   sd@11c0000: 0, sd@11c10000: 1, sd@11c20000: 2
Loading Environment from MMC... OK
In:    serial@1004b800
Out:   serial@1004b800
Err:   serial@1004b800
Net:
Error: ethernet@11c30000 address not set.
No ethernet found.

Hit any key to stop autoboot:  0
Card did not respond to voltage select! : -110
Card did not respond to voltage select! : -110
Couldn't find partition mmc 1:1
Can't set block device
Card did not respond to voltage select! : -110
Couldn't find partition mmc 1:1
Can't set block device
Bad Linux ARMv4 Image magic!
->
```

#### BOOT MODE2: Booting from serial flash memory

If u-boot is written to the serial flash, When the power is turned on, the following will be output to the console (SER3\_UART).

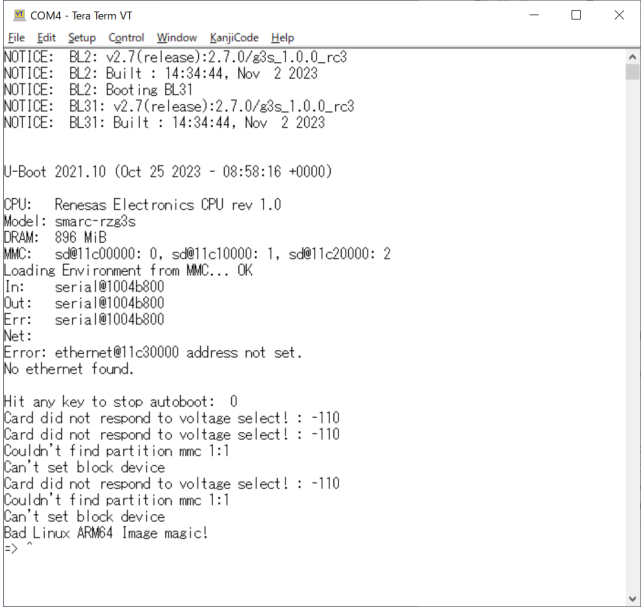

```
COM4 - Tera Term VT
File Edit Setup Control Window KanjiCode Help
NOTICE: BL2: v2.7(release):2.7.0/g3s_1.0.0_rc3
NOTICE: BL2: Built : 14:34:44, Nov 2 2023
NOTICE: BL2: Booting BL31
NOTICE: BL31: v2.7(release):2.7.0/g3s_1.0.0_rc3
NOTICE: BL31: Built : 14:34:44, Nov 2 2023

U-Boot 2021.10 (Oct 25 2023 - 08:58:16 +0000)

CPU:   Renesas Electronics CPU rev 1.0
Model: smarc-rzg3s
DRAM:  896 MiB
MMC:   sd@11c0000: 0, sd@11c10000: 1, sd@11c20000: 2
Loading Environment from MMC... OK
In:    serial@1004b800
Out:   serial@1004b800
Err:   serial@1004b800
Net:
Error: ethernet@11c30000 address not set.
No ethernet found.

Hit any key to stop autoboot:  0
Card did not respond to voltage select! : -110
Card did not respond to voltage select! : -110
Couldn't find partition mmc 1:1
Can't set block device
Card did not respond to voltage select! : -110
Couldn't find partition mmc 1:1
Can't set block device
Bad Linux ARMv4 Image magic!
->
```

BOOT MODE3: Booting from the program downloaded through the serial communications with FIFO (SCIF)

When the power is turned on, the following will be output to the console (SER3\_UART).

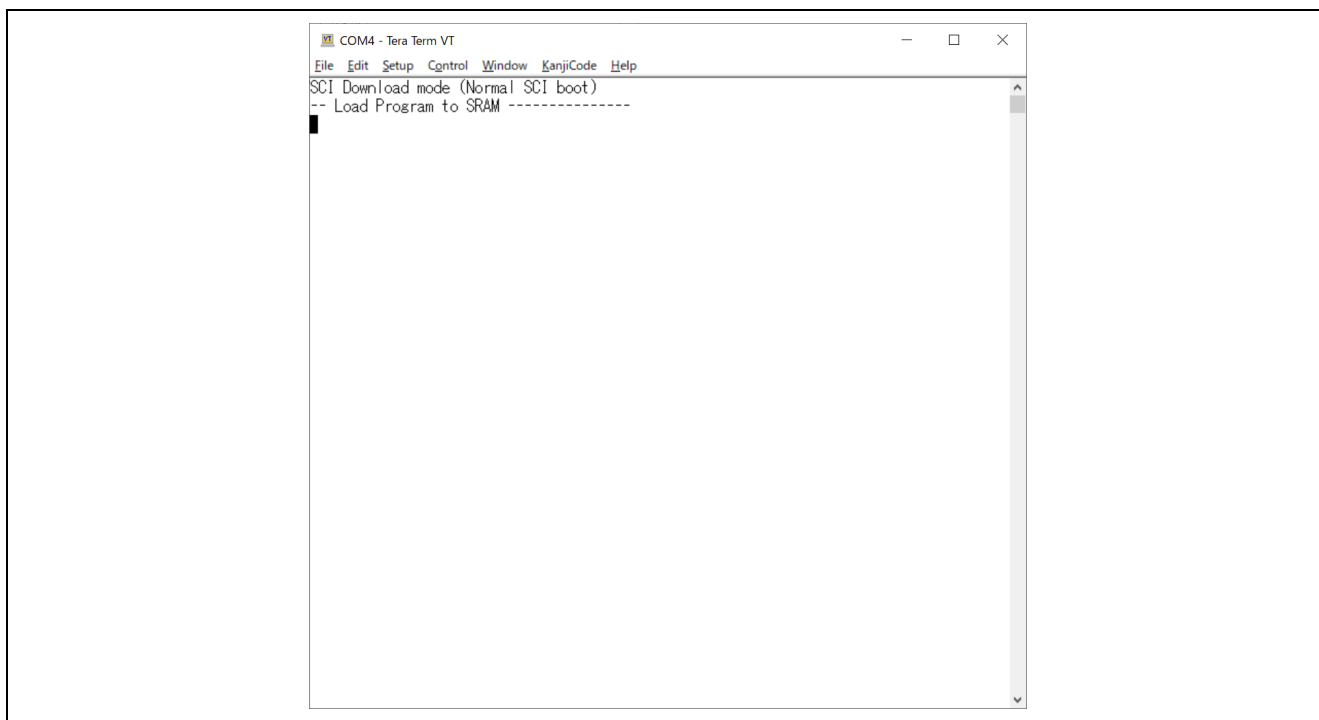

## 4. Tutorial: Your First RZ MPU Project - Blinky

### 4.1 Tutorial Blinky

The goal of this tutorial is to quickly get acquainted with the Flexible Platform by moving through the steps of creating a simple application using e2 studio and running that application on an RZ MPU board.

### 4.2 What Does Blinky Do?

The application used in this tutorial is Blinky, traditionally the first program run in a new embedded development environment.

Blinky is the "Hello World" of microprocessors. If the LED blinks you know that:

- The toolchain is setup correctly and builds a working executable image for your chip.
- The debugger has installed with working drivers and is properly connected to the board.
- The board is powered up and its jumper and switch settings are probably correct.
- The microprocessor is alive, the clocks are running, and the memory is initialized.
- Timer (GTM) interrupt is intentionally fired and GPIO is properly controlled.

Note: SRMAC EVK board does not have any LED.

Thus, Blinky sample application used in this tutorial is designed to use the Pmod module described below alternatively:

- Pmod LED (Four High-brightness LEDs): <https://reference.digilentinc.com/pmod/pmodled/start>

This module is not included on the SRMAC EVK board and so, please prepare it beforehand.

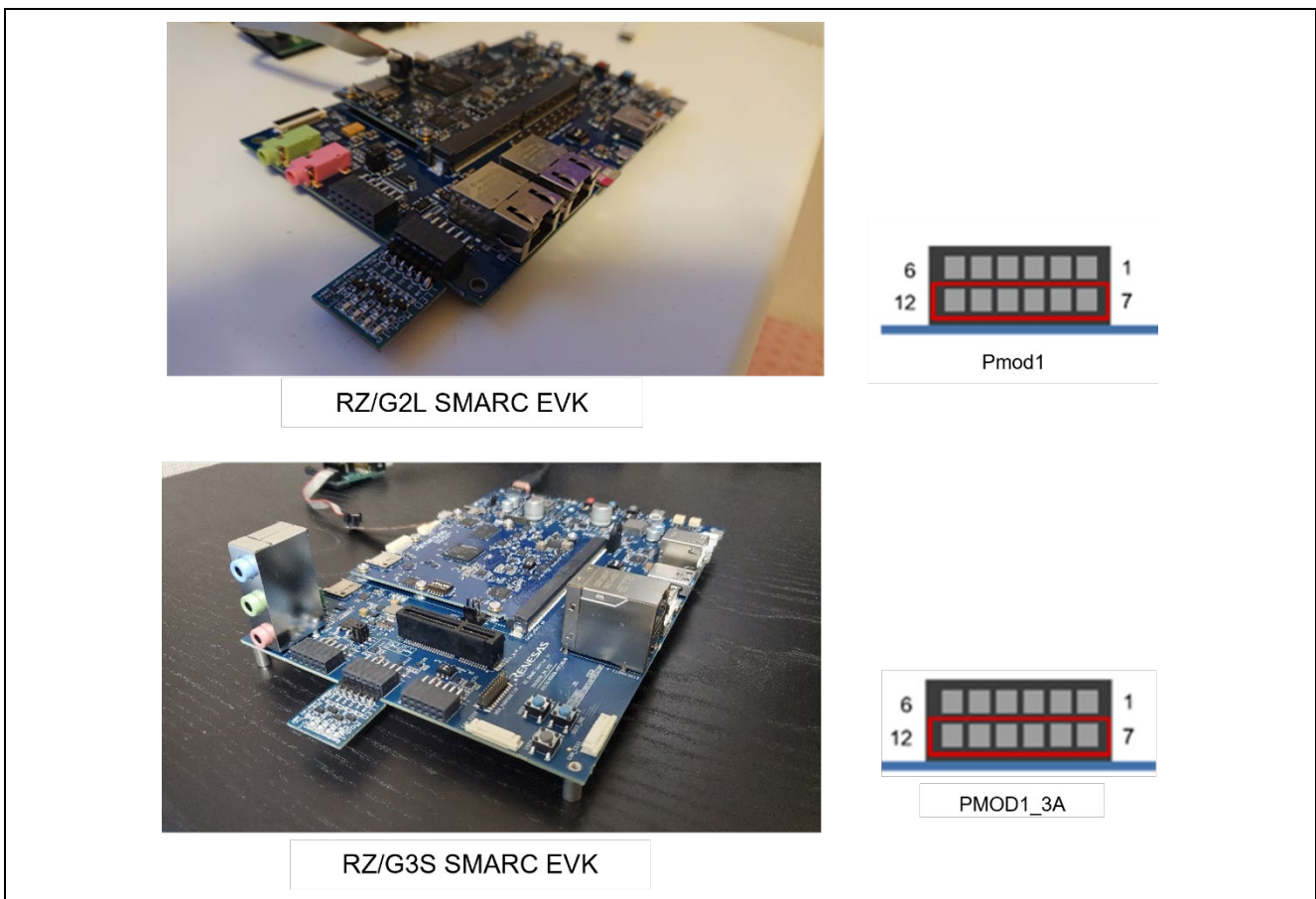

Figure 49: Connection Pmod LED module (410-076)

### 4.3 Create a New Project for Blinky

The creation and configuration of an RZ/G C/C++ FSP Project is the first step in the creation of an application. The base RZ/G pack includes a pre-written Blinky example application.

Follow these steps to create an RZ MPU project:

1. In e2 studio, click **File > New > C/C++ Project**.

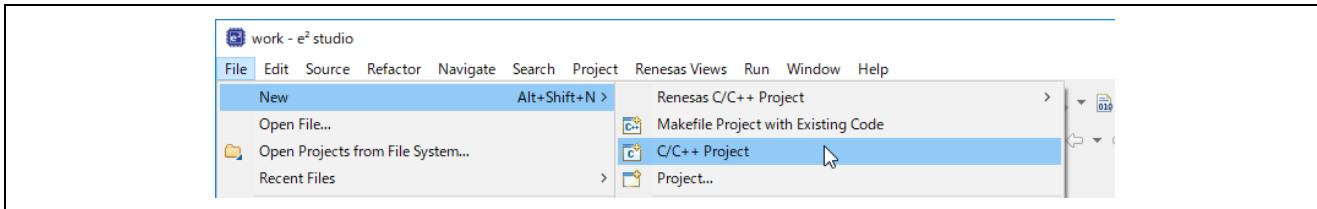

Figure 50: New C/C++ Project

2. Select [Renesas RZ] > [Renesas RZ/G C/C++ FSP Project] and Click Next.

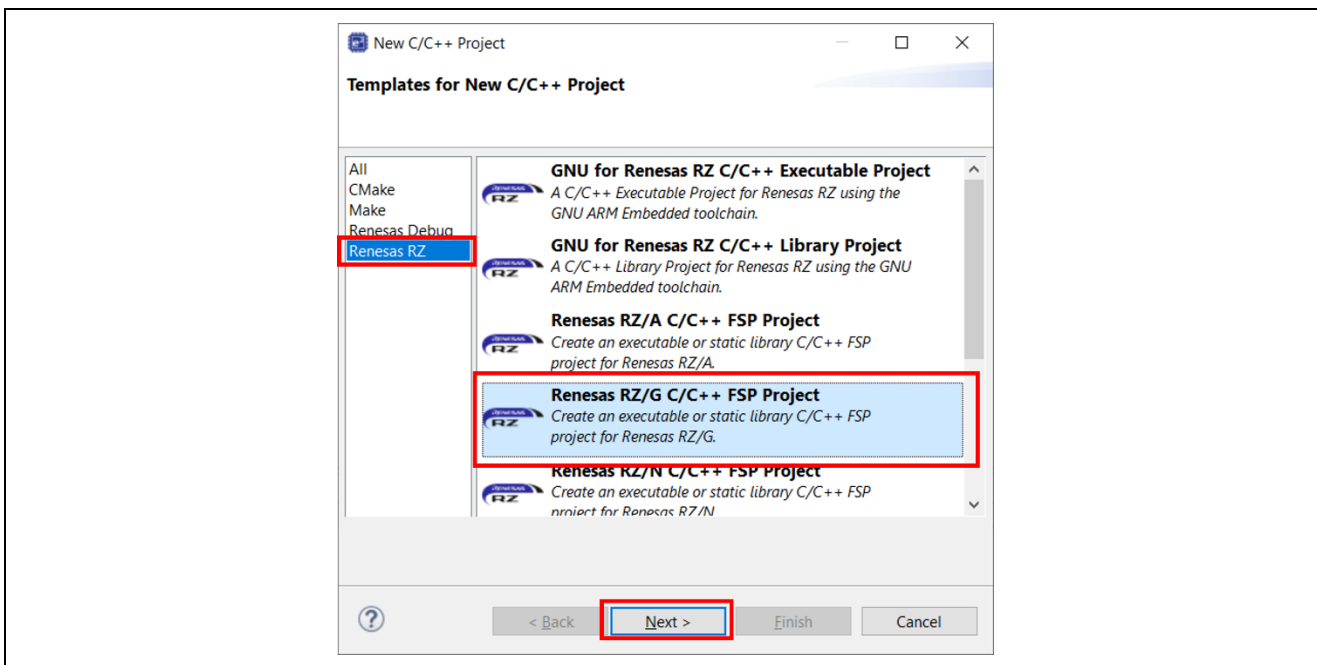

Figure 51: Renesas RZ/G C/C++ FSP Project

3. Assign a name to this new project. Blinky is a good name to use for this tutorial.
4. Click **Next**. The **Project Configuration** window shows your selection.



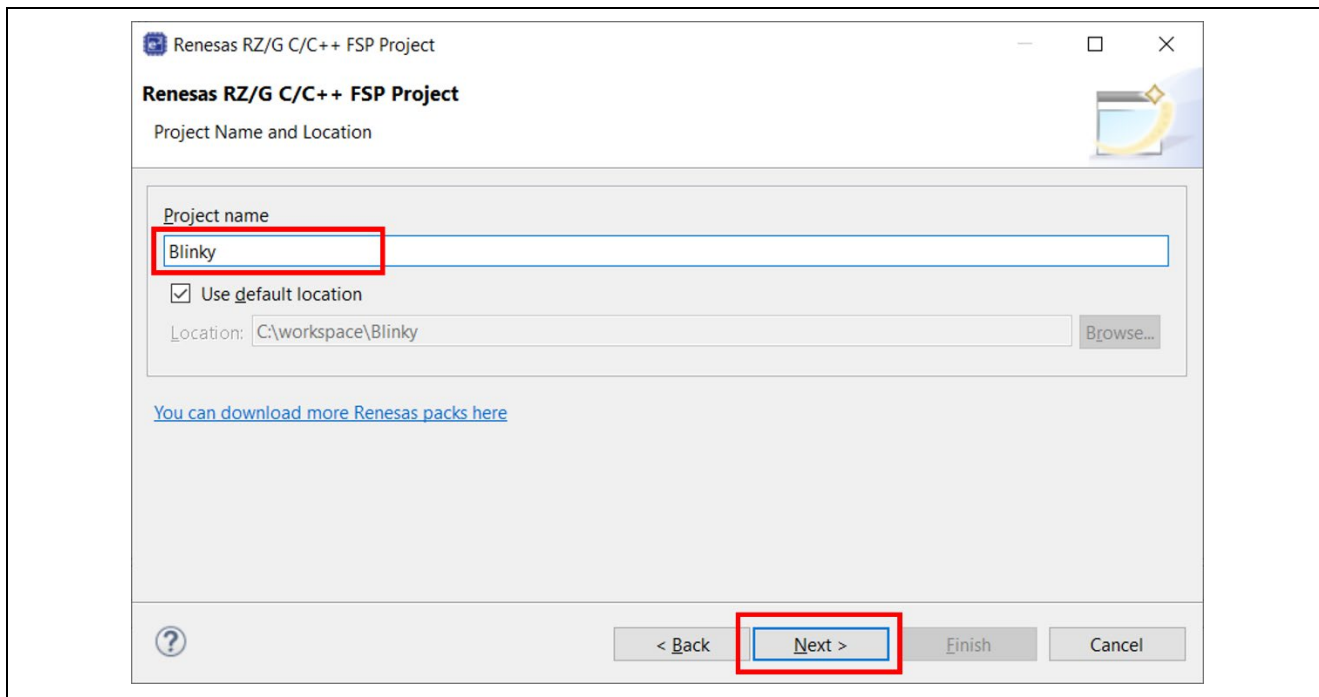

Figure 52 : e2 studio Project Configuration window (part 1)

5. Select the board support package by selecting the name of your board from the Device Selection drop-down list. Select **GNU ARM Embedded** in Toolchains and version is **10.3.1.20210824** and Click **Next**.

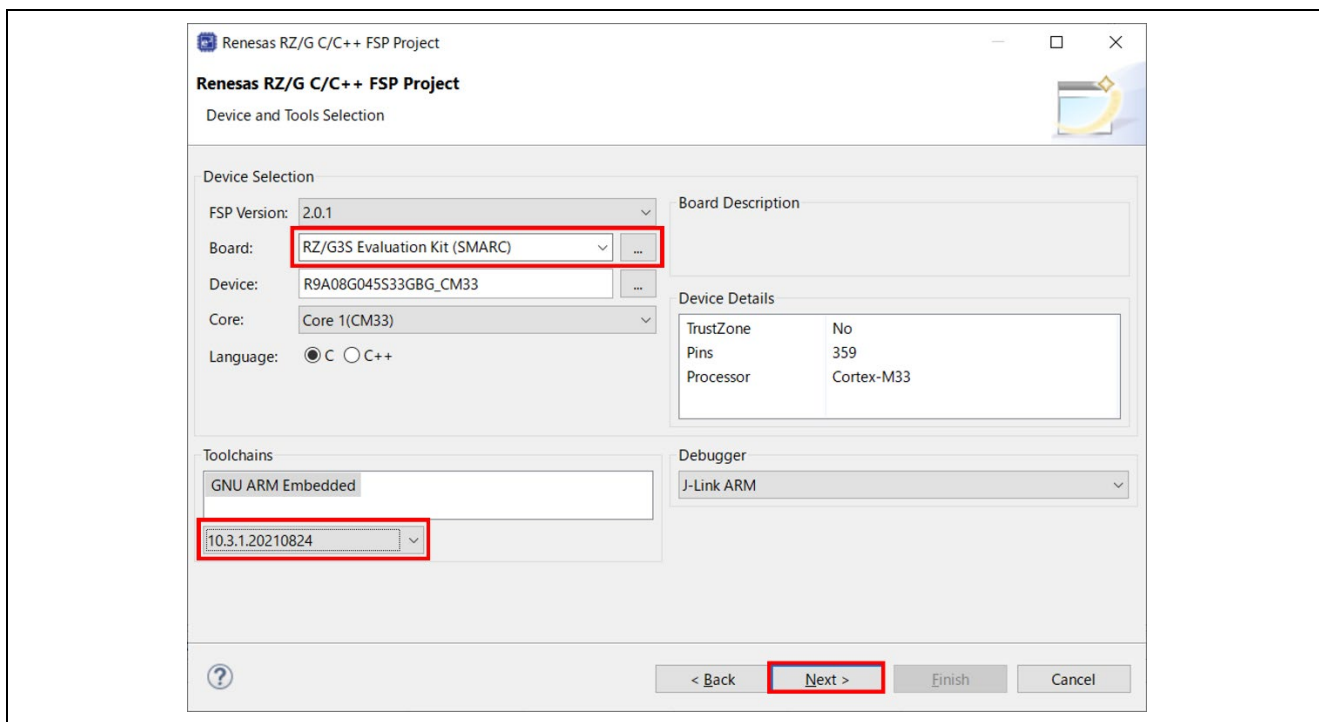

Figure 53 : e2 studio Project Configuration window (part 2)

6. Select the **build artifact** and **RTOS**. Be sure that **Secure** must be chosen at the **Sub-core start state** on the current version. Otherwise, the created project can't be built successfully.

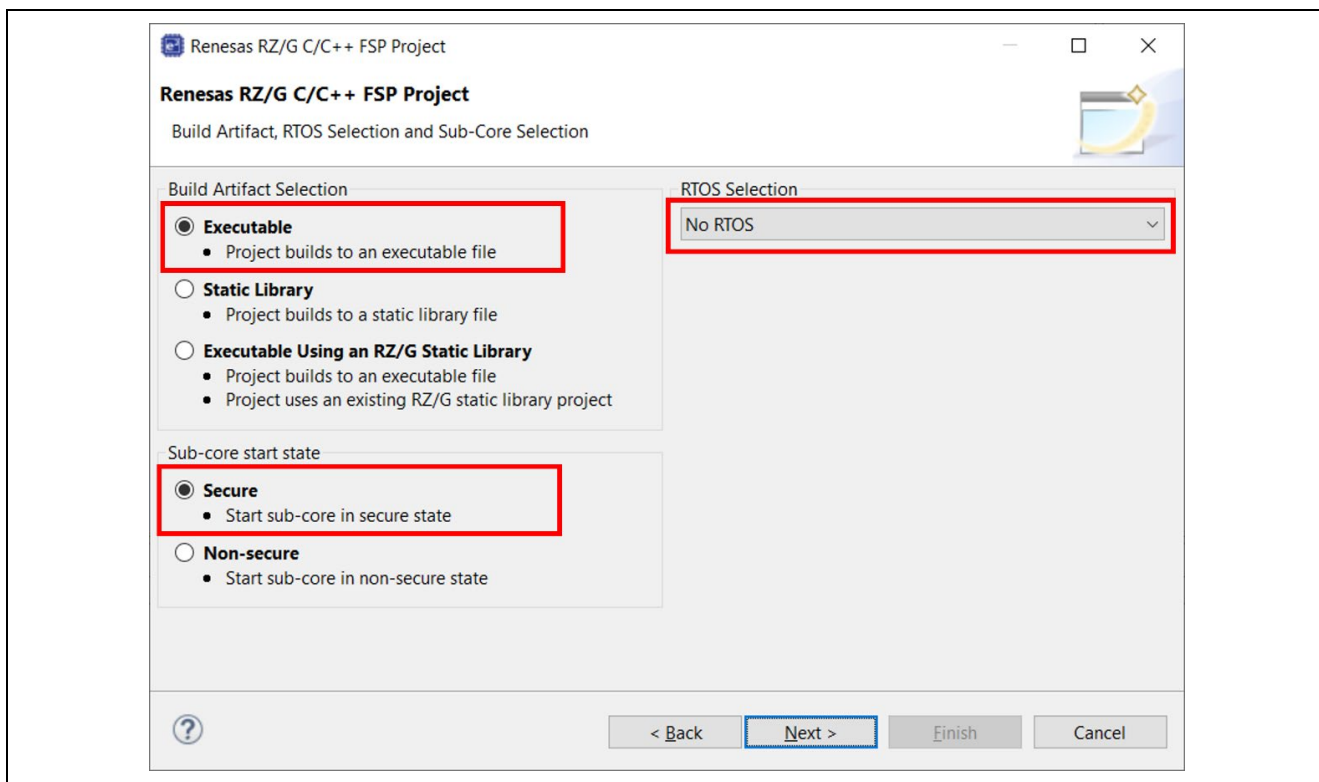

Figure 54 : e2 studio Project Configuration window (part 3)

7. Select the **Blinky** template for your board and click **Finish**.

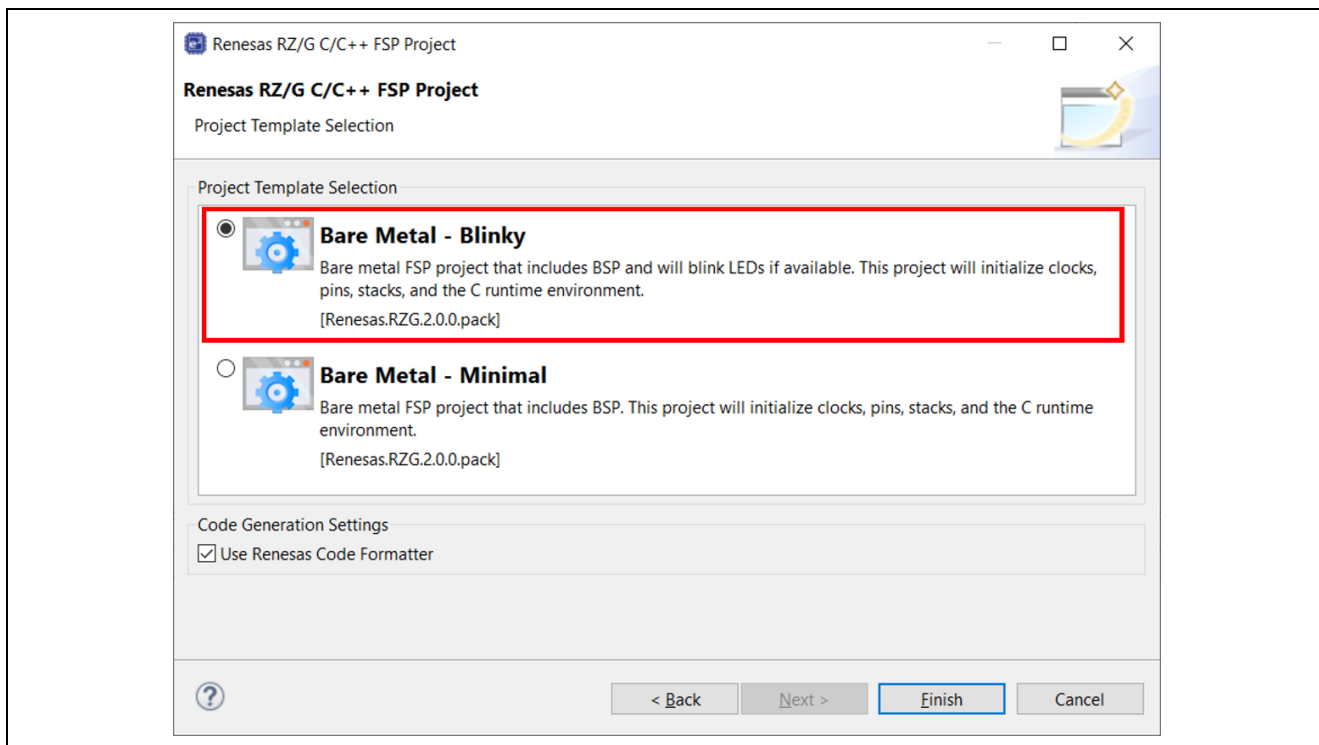
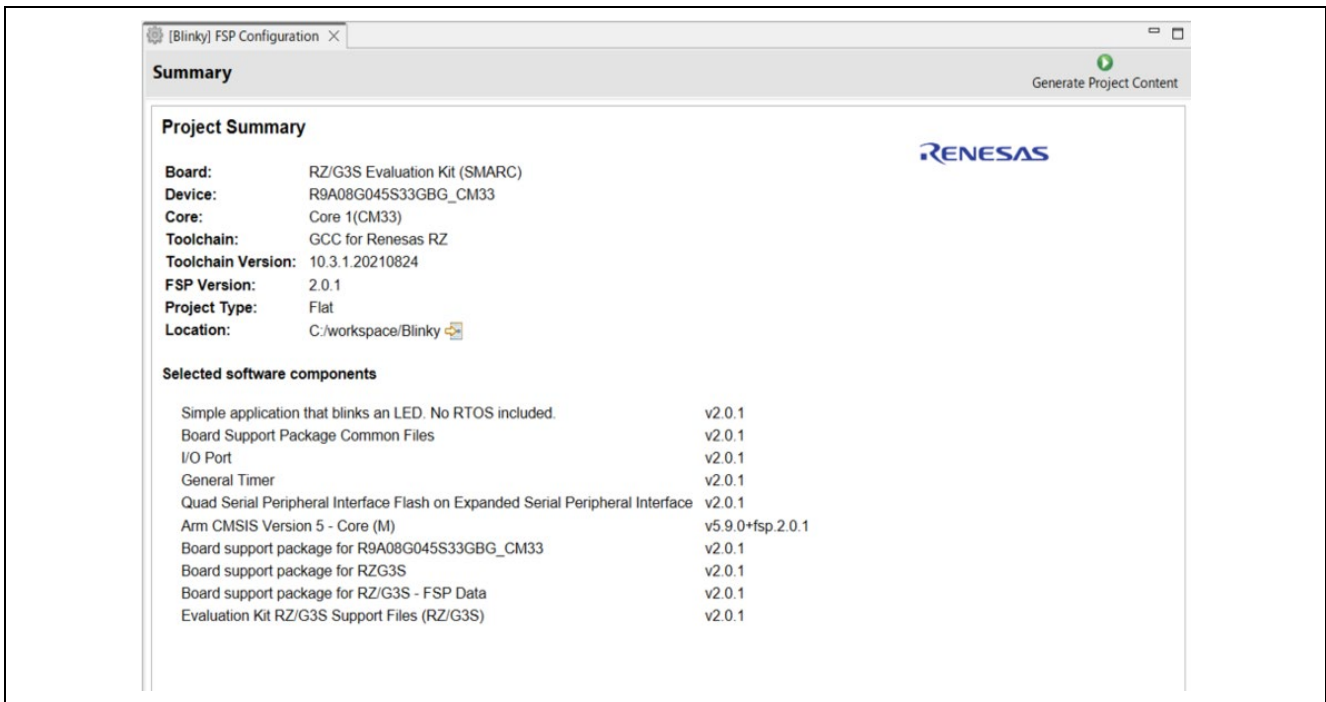

Figure 55 : e2 studio Project Configuration window (part 4)



Once the project has been created, the name of the project will show up in the **Project Explorer** window of e2 studio. Now click the **Generate Project Content** button in the top right corner of the **Project Configuration** window to generate your board specific files.



**Figure 56 : e2 studio Project Configuration tab**

Your new project is now created, configured, and ready to build.

### 4.3.1 Details about the Blinky Configuration

The Generate Project Content button creates configuration header files, copies source files from templates, and generally configures the project based on the state of the Project Configuration screen.

For example, if you check a box next to a module in the Components tab and click the Generate Project Content button, all the files necessary for the inclusion of that module into the project will be copied or created. If that same check box is then unchecked those files will be deleted.

### 4.3.2 Configuring the Blinky Clocks

By selecting the Blinky template, the clocks are configured by e2 studio for the Blinky application. The clock configuration tab (see 5.2.3 Configuring Clocks) shows the Blinky clock configuration. The Blinky clock configuration is stored in the BSP clock configuration file.

### 4.3.3 Configuring the Blinky Pins

By selecting the Blinky template, the GPIO pins used to toggle the LED1 are configured by e2 studio for the Blinky application. The pin configuration tab shows the pin configuration for the Blinky application (see 5.2.4. Configuring Pins). The Blinky pin configuration is stored in the BSP configuration file.

### 4.3.4 Configuring the Parameters for Blinky Components

The Blinky project automatically selects the following HAL components in the Components tab:

- r\_gtm
- r\_ioport

To see the configuration parameters for any of the components, check the Properties tab in the HAL window for the respective driver (see 5.2.8. Adding and Configuring HAL Drivers).

### 4.3.5 Where is main()?

The main function is located in <project>/rzg\_gen/main.c. It is one of the files that are generated during the project creation stage and only contains a call to hal\_entry(). For more information on generated files, see Adding and Configuring HAL Drivers.

### 4.3.6 Blinky Example Code

The blinky application is stored in the hal\_entry.c file. This file is generated by e2 studio when you select the Blinky Project template and is located in the project's src/ folder.

The application performs the following steps:

1. Get the LED information for the selected board by bsp\_leds\_t structure.
2. Set the configuration of Timer (GTM) and the callback function that is called when interrupt is fired.
3. Define the output level HIGH for the GPIO pins controlling the LEDs for the selected board.
4. Toggle the LEDs by writing to the GPIO pin with "R\_BSP\_PinWrite((bsp\_io\_port\_pin\_t) pin, pin\_level)" in callback function of GTM that is called with the specified interval.

## 4.4 Build the Blinky Project

Highlight the new project in the Project Explorer window by clicking on it and build it.

There are three ways to build a project:

1. Click on Project in the menu bar and select Build Project.
2. Click on the hammer icon.
3. Right-click on the project and select Build Project.

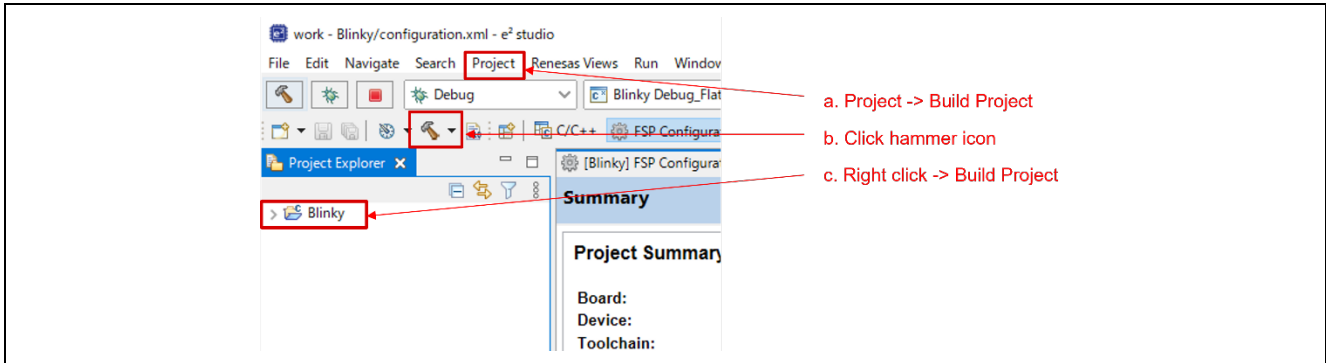

Figure 57 : e2 studio Project Explorer window

Once the build is complete, a message is displayed in the build Console window that displays the final image file name and section sizes in that image.

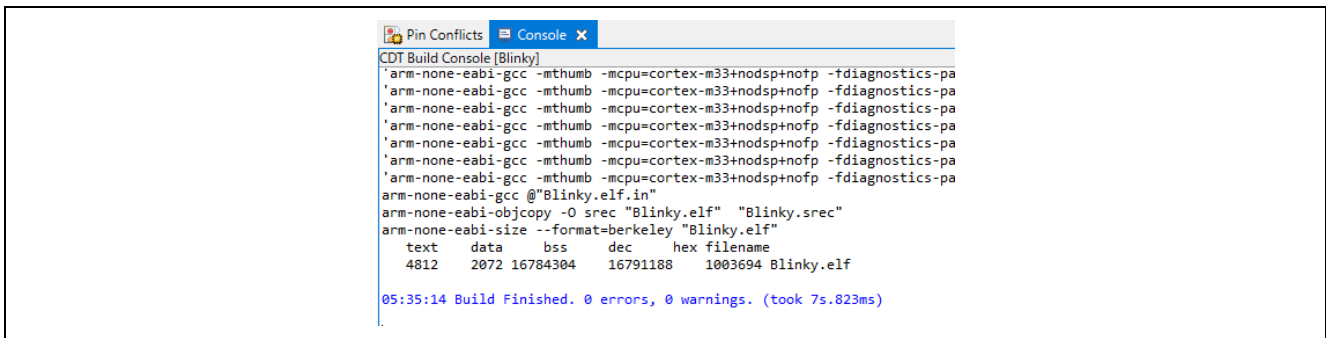

Figure 58 : e2 studio Project Build console

## 4.5 Debug the Blinky Project

### 4.6 Debug prerequisites

To debug the project on a board, you need

- The board to be connected to e2 studio
- The debugger to be configured to talk to the board
- The application to be programmed to the microprocessor

Applications run from the internal ram or external ram of your microprocessor. To run or debug the application, the application must first be programmed to ram by JTAG debugger. SMARC EVK board has a JTAG header and requires an external JTAG debugger to the header.

### 4.7 Debug steps

To debug the Blinky application, follow these steps:

1. Configure the debugger for your project by clicking **Run > Debugger Configurations ...**

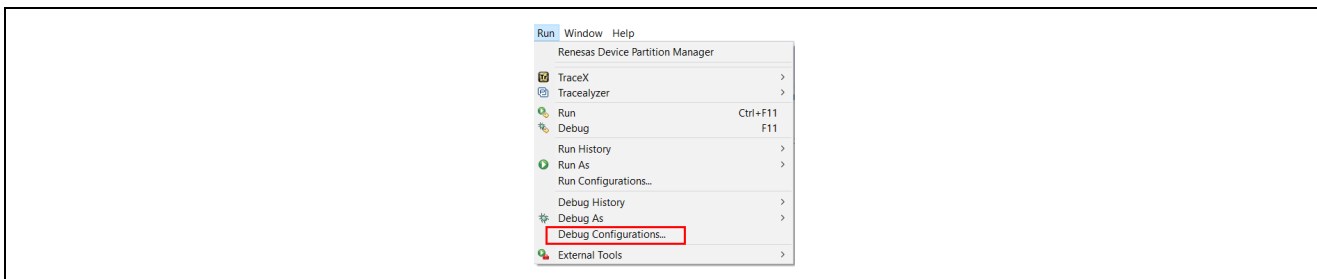

Figure 59 : e2 studio Debug icon

or by selecting the drop-down menu next to the bug icon and selecting **Debugger Configurations ...**

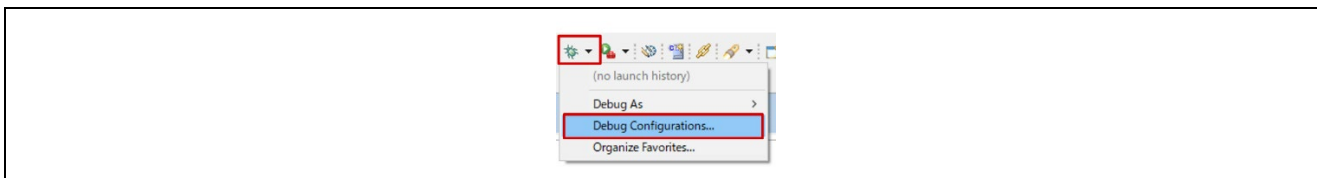

Figure 60 : e2 studio Debugger Configurations selection option

2. Select your debugger configuration in the window. If it is not visible, then it must be created by clicking New icon in the top left corner of the window. Once selected, the **Debug Configuration** window displays the **Debug configuration** for your **Blinky** project.

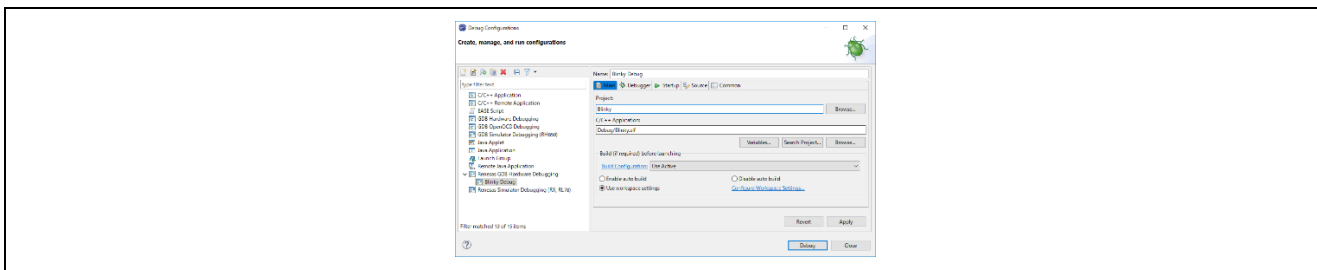

Figure 61 : e2 studio Debugger Configurations window with Blinky project (1)

3. Select the debug configuration for the generated project and select the **Debugger** tab.
4. Click **Debug** to begin debugging the application.
5. Extracting **RZ Debug**.

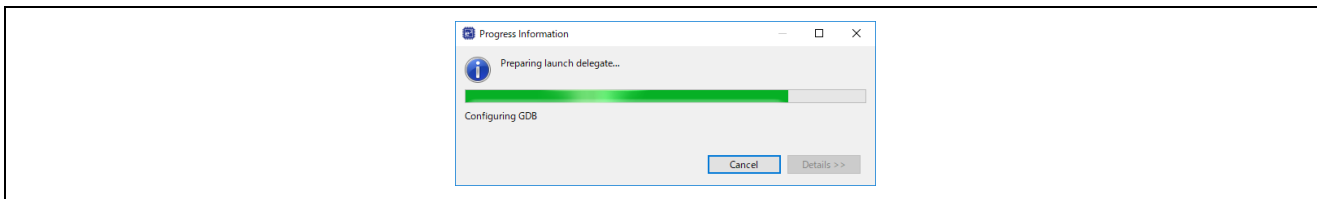

Figure 62 : e2 studio Debugger Configurations window with Blinky project (2)

## 4.8 Details about the Debug Process

In debug mode, e2 studio executes the following tasks:

1. Downloading the application image to the microprocessor and programming the image to the internal and/or external memory.
2. Setting a breakpoint at main().
3. Setting the stack pointer register to the stack.
4. Loading the program counter register with the address of the reset vector.
5. Displaying the startup code where the program counter points to.

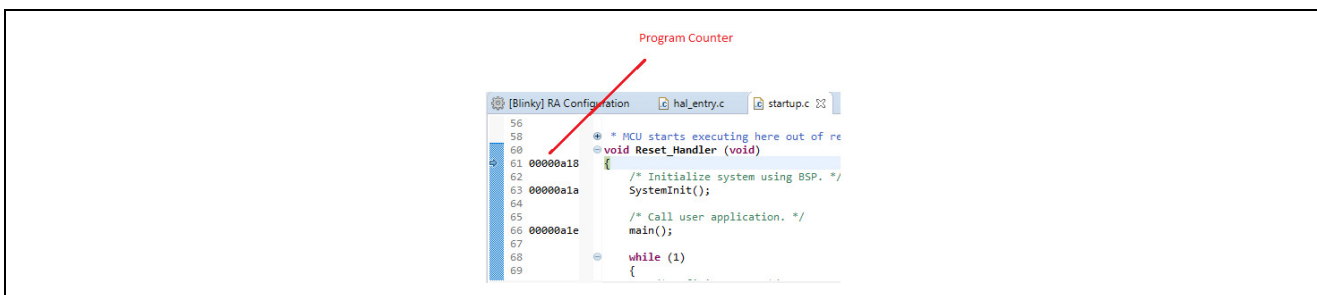

Figure 63 : e2 studio Debugger memory window

## 4.9 Run the Blinky Project

While in Debug mode, click **Run > Resume** or click on the **Play** icon twice.

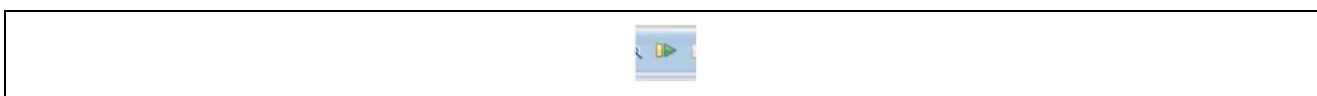

Figure 64 : e2 studio Debugger Play icon

The LED on the Pmod LED should now be blinking.

## 5. FSP application launch with e2 studio

### 5.1 Create a Project

#### 5.1.1 What is a Project?

In e2 studio, all FSP applications are organized in RZ MPU projects. Setting up an RZ MPU project involves:

1. [Create a Project](#)
2. [Configuring a Project](#)

These steps are described in detail in the next two sections. When you have existing projects already, after you launch e2 studio and select a workspace, all projects previously saved in the selected workspace are loaded and displayed in the **Project Explorer** window. Each project has an associated configuration file named `configuration.xml`, which is located in the project's root directory.

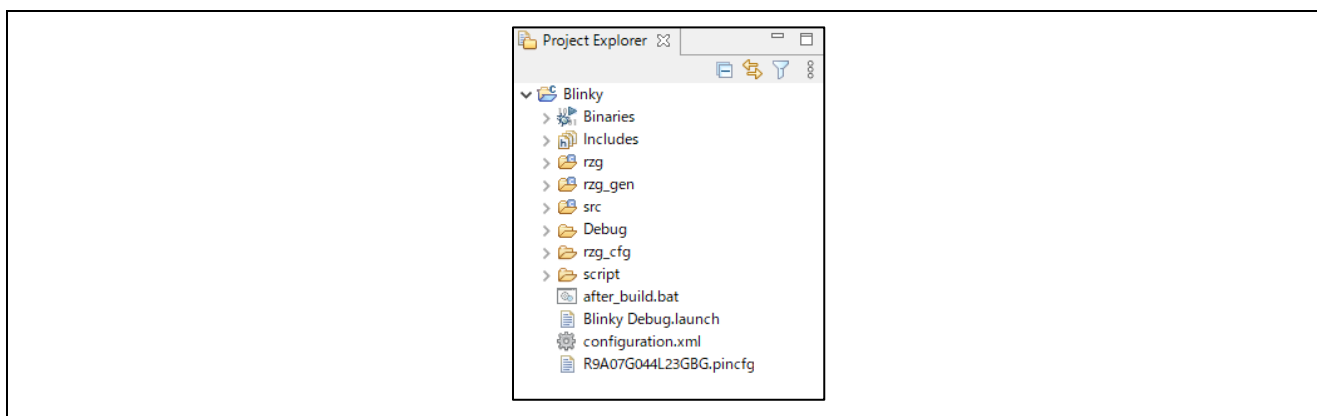

Figure 65 : e2 studio Project Configuration file

Double-click on the `configuration.xml` file to open the RZ MPU Project Editor. To edit the project configuration, make sure that the **FSP Configuration** perspective is selected in the upper right-hand corner of the e2 studio window. Once selected, you can use the editor to view or modify the configuration settings associated with this project.



Figure 66 : e2 studio FSP Configuration Perspective

Note: Whenever the RZ project configuration (that is, the `configuration.xml` file) is saved, a verbose RZ Project Report file (`rzg_cfg.txt`) with all the project settings is generated. The format allows differences to be easily viewed using a text comparison tool. The generated file is located in the project root directory.

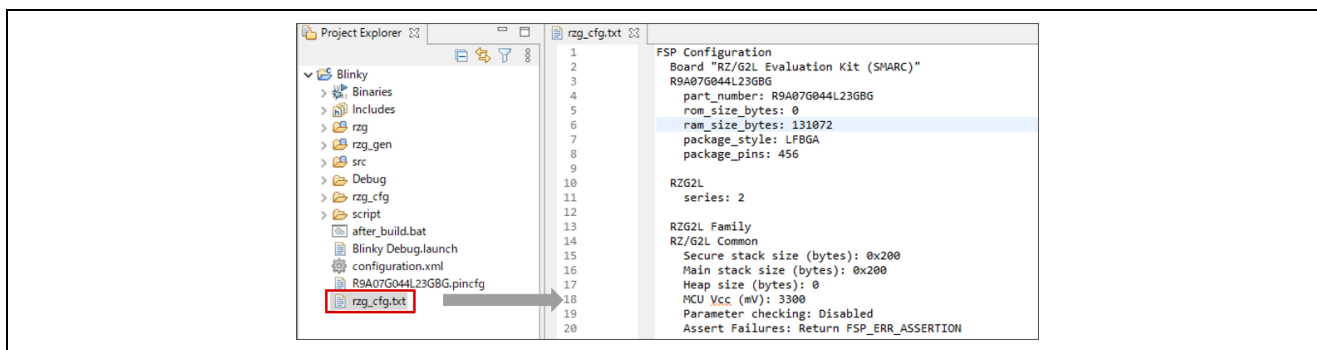

Figure 67 : RZ Project Report

The RZ Project Editor has several tabs. The configuration steps and options for individual tabs are discussed in the following sections.

Note: The tabs available in the RZ Project Editor depend on the e2 studio version and the layout may vary slightly, however the functionality should be easy to follow.

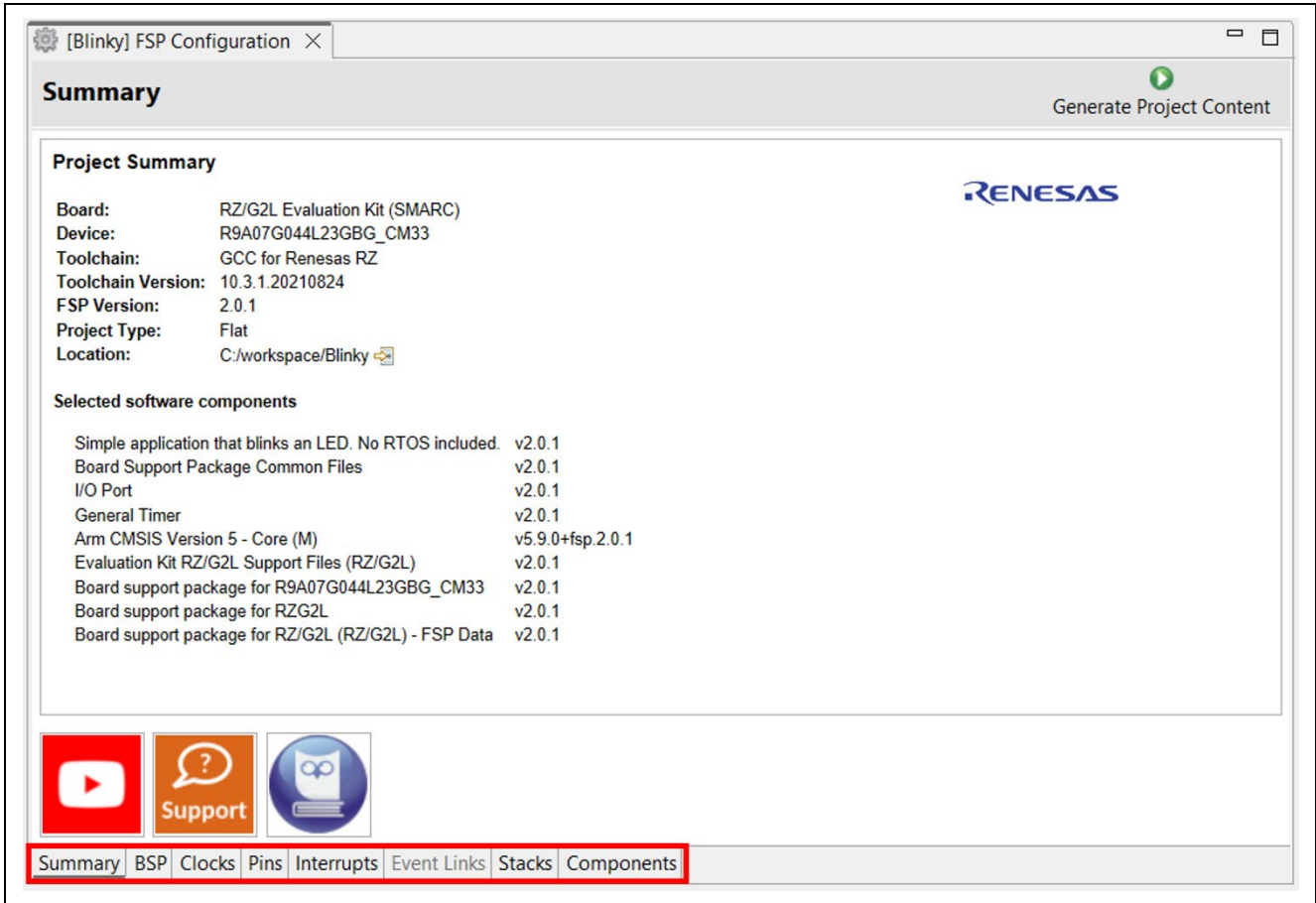

Figure 68 : RZ Project Editor tabs



### 5.1.2 Creating a New Project

For RZ MPU applications, generate a new project using the following steps:

1. Click on File > New > C/C++ Project.

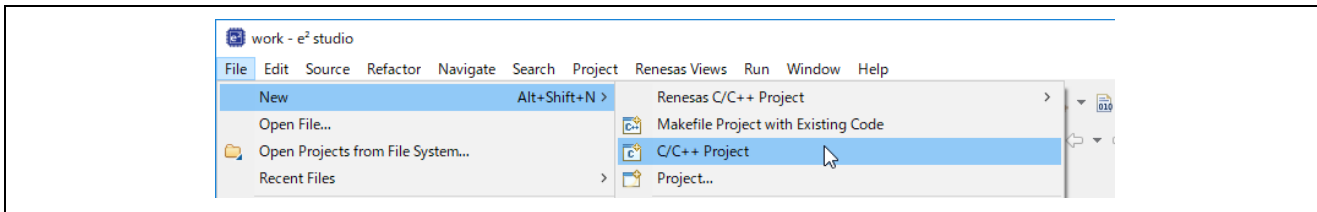

Figure 69 : New RZ MPU Project

2. Then click on the **Renesas RZ/G C/C++ FSP Project** template for the type of project you are creating.

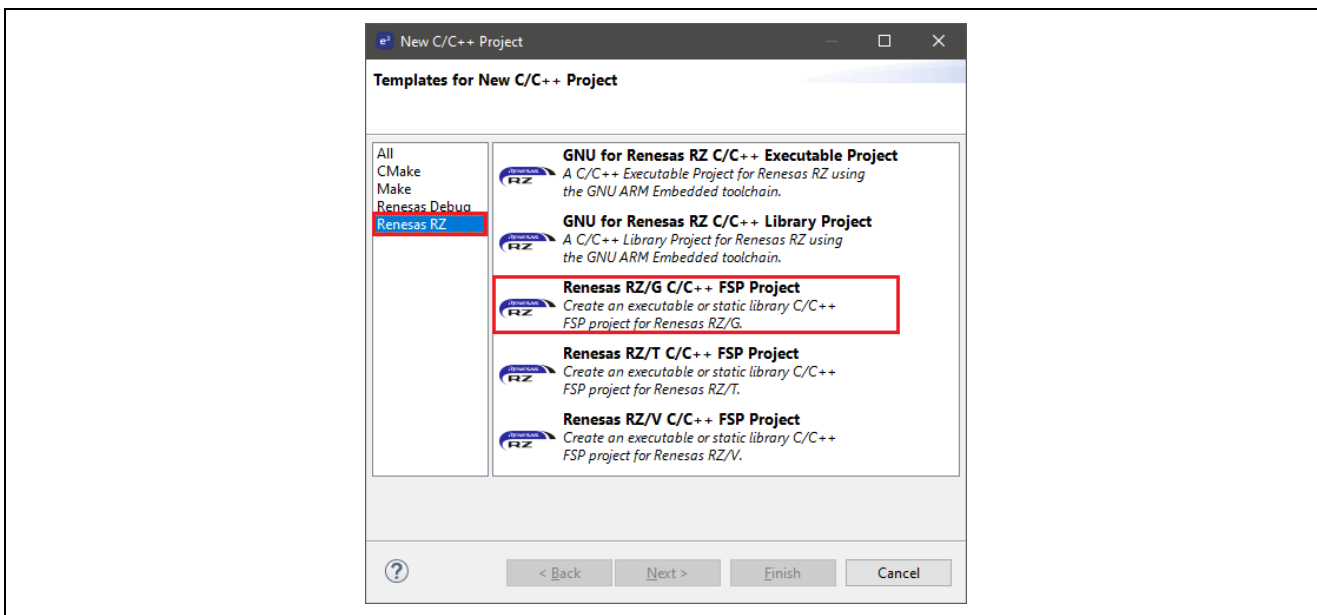

Figure 70 : New Project Templates

3. Select a project name and location.

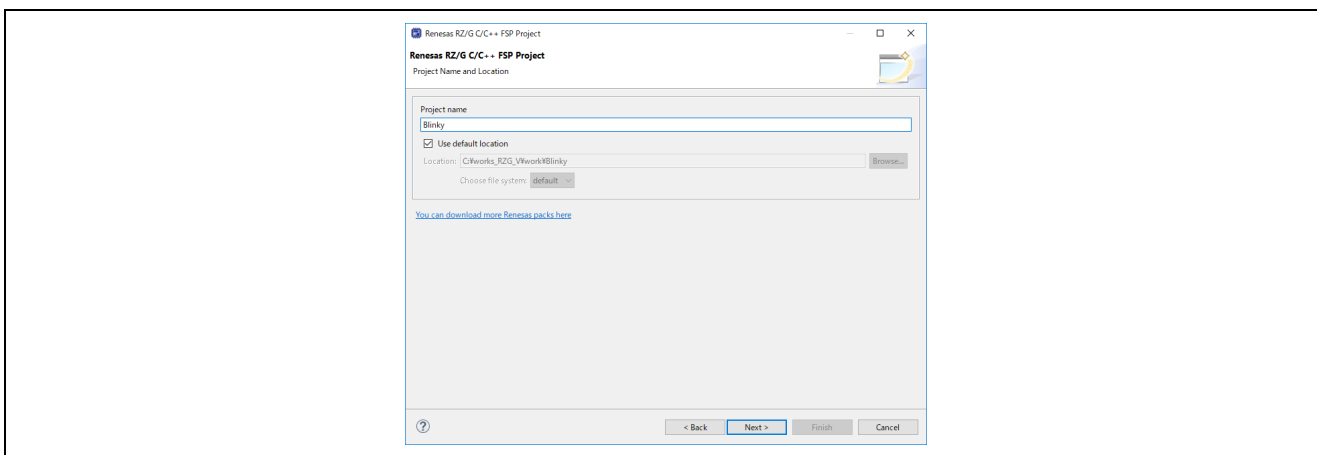

Figure 71 : RZ MPU Project Generator (Screen 1)

4. Click Next.

### 5.1.2.1 Selecting a Board and Toolchain

In the Project Configuration window select the hardware and software environment:

1. Select the **FSP version**.
2. Select the **Board** for your application. You can select an existing RZ MPU Evaluation Kit or select **Custom User Board** for any of the RZ MPU devices with your own BSP definition.
3. Select the **Device**. The **Device** is automatically populated based on the **Board** selection. Only change the **Device** when using the **Custom User Board (Any Device)** board selection.
4. Select the **Core**. You can select Core 1(CM33) or Core 2(CM33\_FPU) if you selected RZ/G3S for the **Device**.
5. To add threads, select **RTOS**, or **No RTOS** if an RTOS is not being used.
6. The **Toolchain** selection defaults to **GNU Arm Embedded**.
7. Select the **Toolchain version**. This should default to the installed toolchain version.
8. Select the **Debugger**. The J-Link Arm Debugger is preselected.
9. Click **Next**.

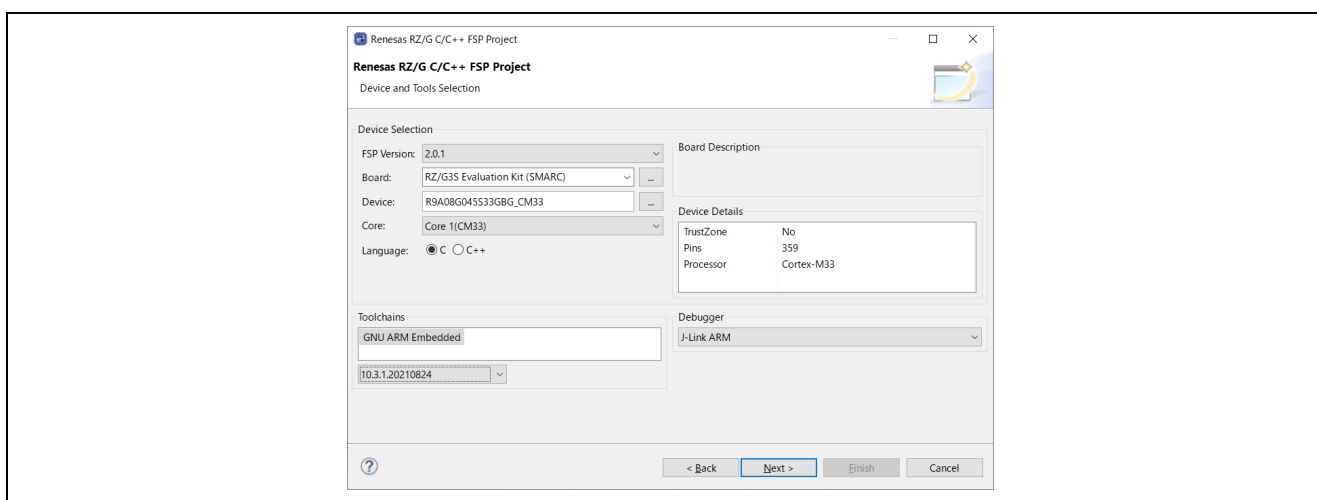

Figure 72 : RZ MPU Project Generator (Screen 2-1)

If Core 2(CM33\_FPU) is selected in procedure 4, you need to select the preceding project. To select the preceding project when creating the Core 2(CM33\_FPU) project, it is required to prepare Core 1(CM33) before Core 2(CM33\_FPU) project creation.

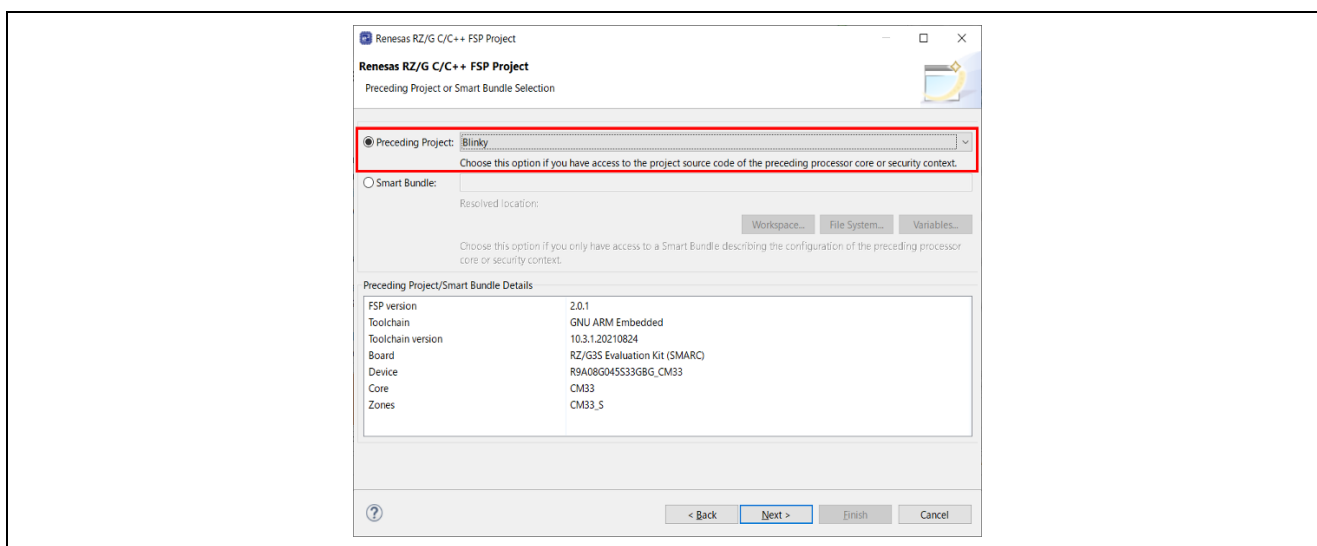

Figure 73 : RZ MPU Project Generator (Screen 2-2)

### 5.1.2.2 Selecting a Project Template

In the next window, select the build artifact, **Sub-core start state** and **RTOS**. Be sure that you select **Secure** as **Sub-core start state** in the current version.

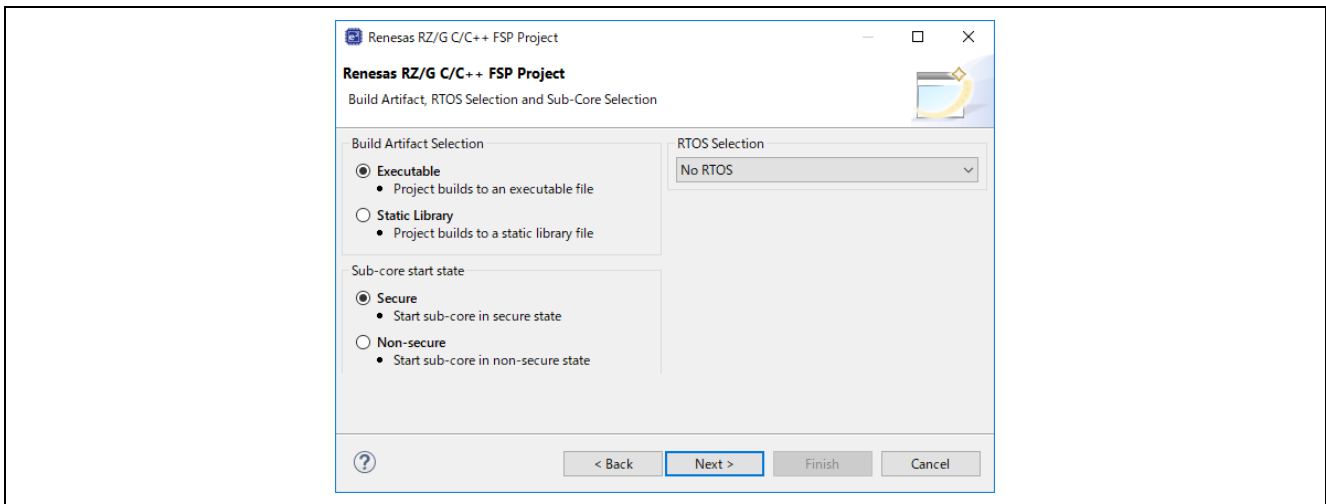

Figure 74 : RZ MPU Project Generator (Screen 3)

In the next window, select a project template from the list of available templates. By default, this screen shows the templates that are included in your current RZ/G MPU Pack. Once you have selected the appropriate template, click **Finish**.

Note: If you want to develop your own application, select the basic template for your board, **Bare Metal - Minimal** or **FreeRTOS - Minimal**.

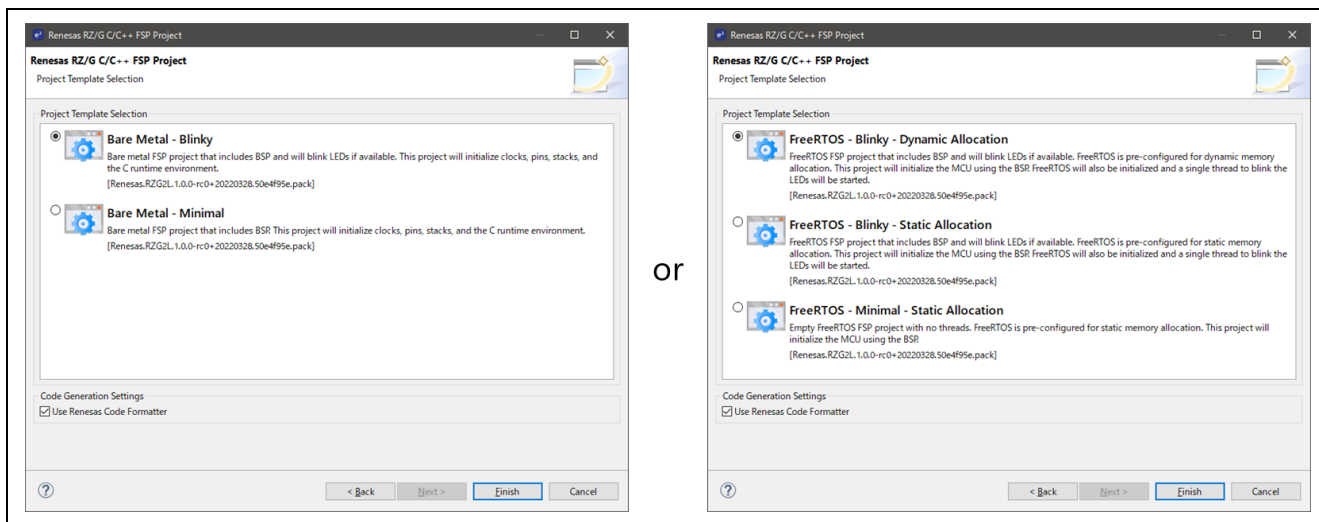

Figure 75 : RZ MPU Project Generator (Screen 4)

When the project is created, e2 studio displays a summary of the current project configuration in the RZ MPU Project Editor.

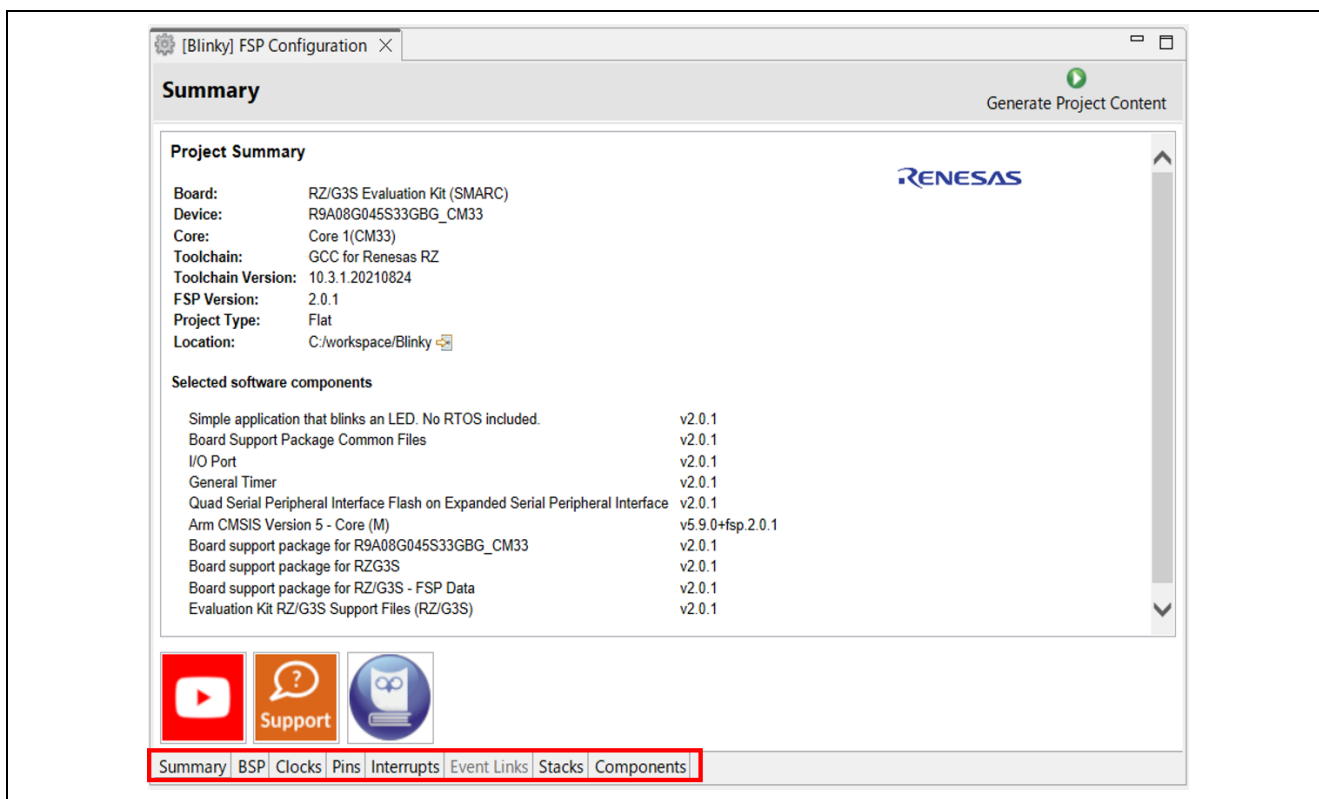

Figure 76 : RZ MPU Project Editor and available editor tabs

On the bottom of the RZ MPU Project Editor view, you can find the tabs for configuring multiple aspects of your project:

- With the **Summary** tab, you can see all they key characteristics of the project: board, device, toolchain, and more.
- With the **BSP** tab, you can change board specific parameters from the initial project selection.
- With the **Clocks** tab, you can refer to the MPU clock settings for your project. In the case of CM33 cold boot, you can configure the MPU clock settings for your project.
- With the **Pins** tab, you can configure the electrical characteristics and functions of each port pin.
- With the **Interrupts** tab, you can add new user events/interrupts.
- With the **Stacks** tab, you can add and configure FSP modules. For each module selected in this tab, the **Properties** window provides access to the configuration parameters, interrupt selections.
- The **Components** tab provides an overview of the selected modules. Although you can also add drivers for specific FSP releases and application sample code here, this tab is normally only used for reference.

The functions and use of each of the supported tabs is explained in detail in the next section. Please note that RZ/G MPU Pack doesn't support **Event Links** tab and so, that tab is grayed out as shown above.

### 5.1.3 Duplication of Resources

In the case of RZ/G3S Core 2(CM33\_FPU) project, duplicate resources are indicated as red character in **Stacks** tab when using resources that are used in the linked Core 1(CM33) project.

The following image is the example that both of Core 1(CM33) and Core 2(CM33\_FPU) projects are created with Blinky template. The duplication of `r_gtm` is indicated in **Stacks** tab. To avoid this duplication, please change the channel resource in **Properties** of `r_gtm`.

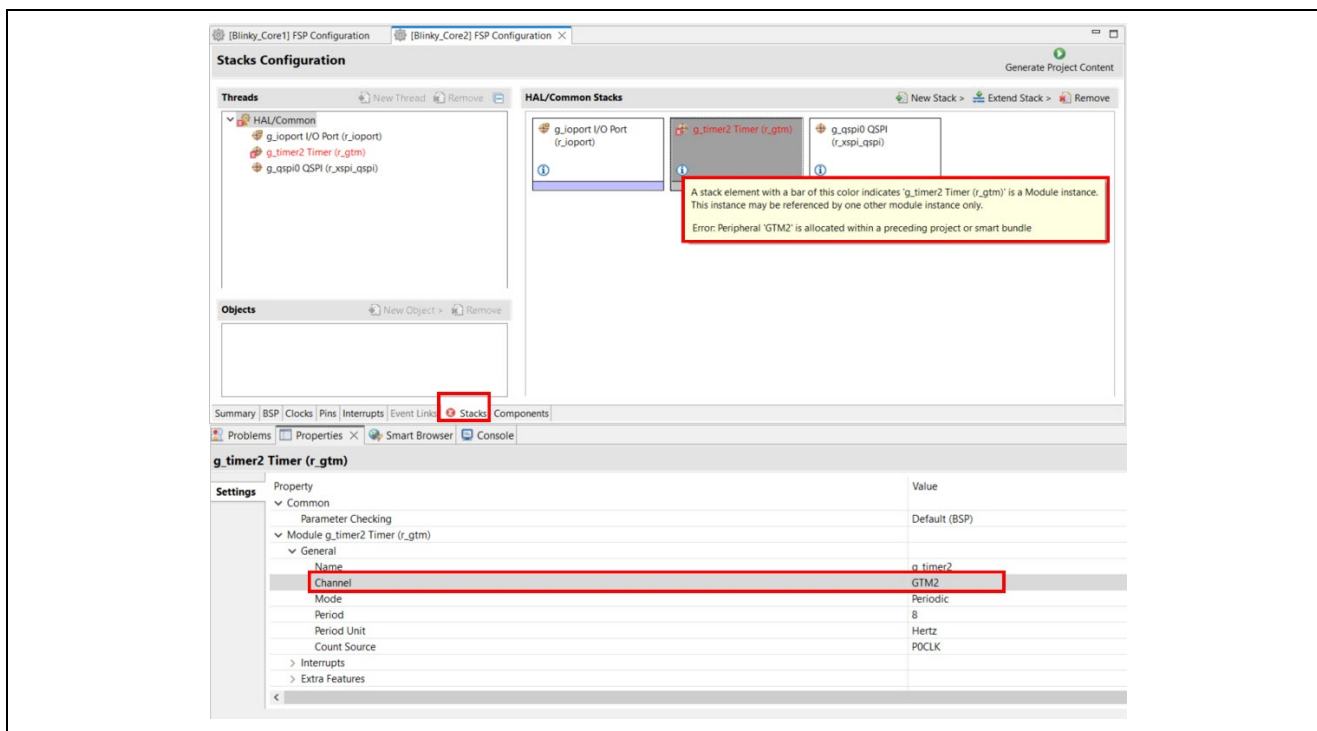

Figure 77 : Duplication of resource between Core 1(CM33) and Core 2(CM33\_FPU) projects

## 5.2 Configuring a Project

Each of the configurable elements in an FSP project can be edited using the appropriate tab in the RZ Configuration editor window. Importantly, the initial configuration of the MPU after reset and before any user code is executed is set by the configuration settings in the **BSP** tab. When you select a project template during project creation, e2 studio configures default values that are appropriate for the associated board. You can change those default values as needed. The following sections detail the process of configuring each of the project elements for each of the associated tabs.

### 5.2.1 Summary Tab

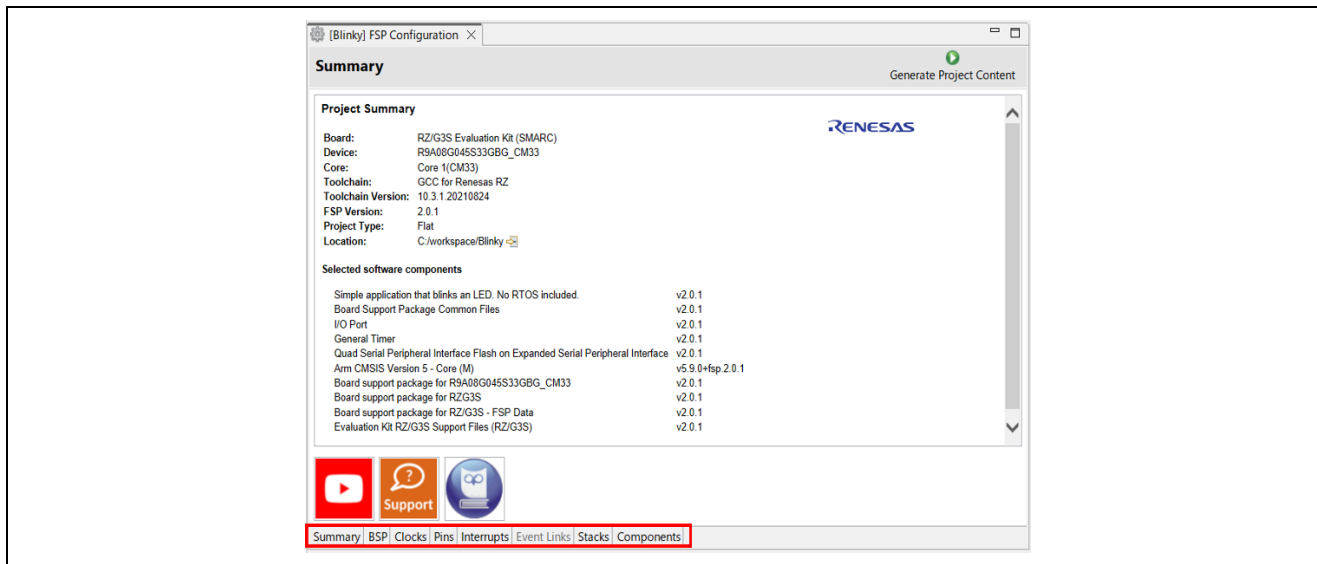

Figure 78 : Configuration Summary tab

The **Summary** tab, seen in the above figure, identifies all the key elements and components of a project. It shows the target board, the device, toolchain and FSP version. Additionally, it provides a list of all the selected software components and modules used by the project. This is a more convenient summary view when compared to the **Components** tab.

### 5.2.2 Configuring the BSP

The **BSP** tab shows the currently selected board (if any) and device. The Properties view is located in the lower left of the Project Configurations view as shown below.

Note: If the Properties view is not visible, click **Window > Show View > Properties** in the top menu bar.

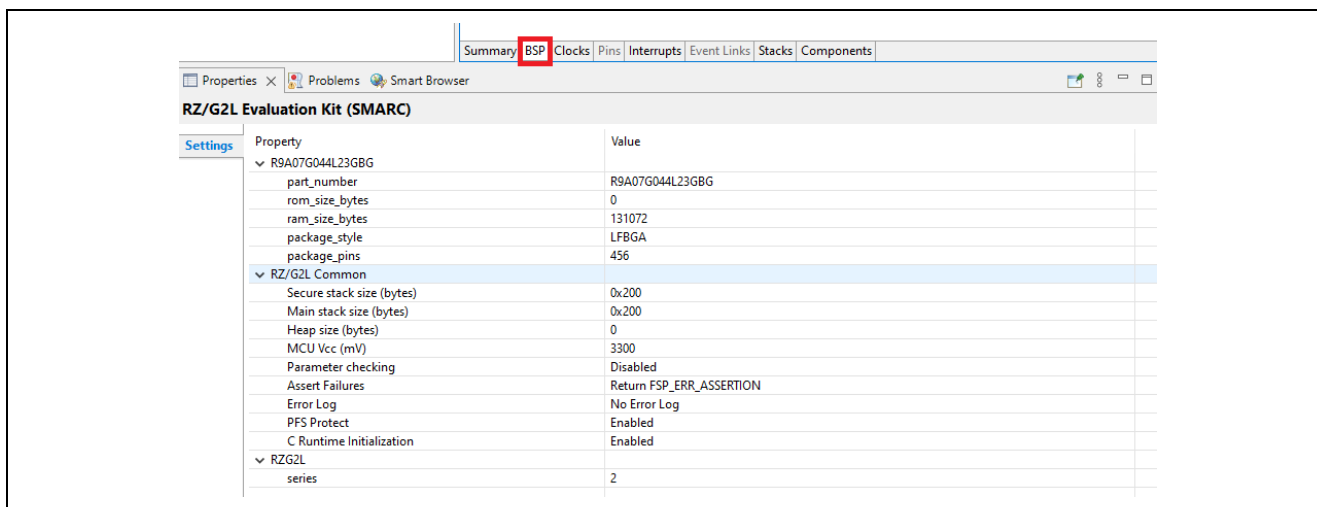

Figure 79 : Configuration BSP tab

The **Properties** view shows the configurable options available for the BSP. These can be changed as required. The BSP is the FSP layer above the MPU hardware. e2 studio checks the entry fields to flag invalid entries. For example, only valid numeric values can be entered for the stack size.

When you click the **Generate Project Content** button, the BSP configuration contents are written to `rzg_cfg/fsp_cfg/bsp/bsp_cfg.h`. This file is created if it does not already exist.

Warning: Do not edit this file as it is overwritten whenever the Generate Project Content button is clicked.

### 5.2.3 Configuring Clocks

The **Clocks** tab presents a graphical view of the MPU's clock tree, and each HAL driver uses the settings for dedicated numerical calculation. For example, `scif_uart` driver calculates the communication rate from the settings in Clocks tab. Please note that the clock configuration is carried out on the main core (CA55) in advance when CM33 work as sub core. Thus, clocks configuration here must align with the settings on CA55.

In the case of CM33 cold boot, BSP will configure each clock setting in start-up process according to content of **Clocks** tab. If a clock setting is invalid, the offending clock value is highlighted in red. It is still possible to generate code with this setting, but correct operation cannot be guaranteed. In the figure below, the xSPI clock SPI0CLK has been changed so the resulting clock frequency is 400 MHz instead of the required less than 267 MHz. This parameter is colored red.

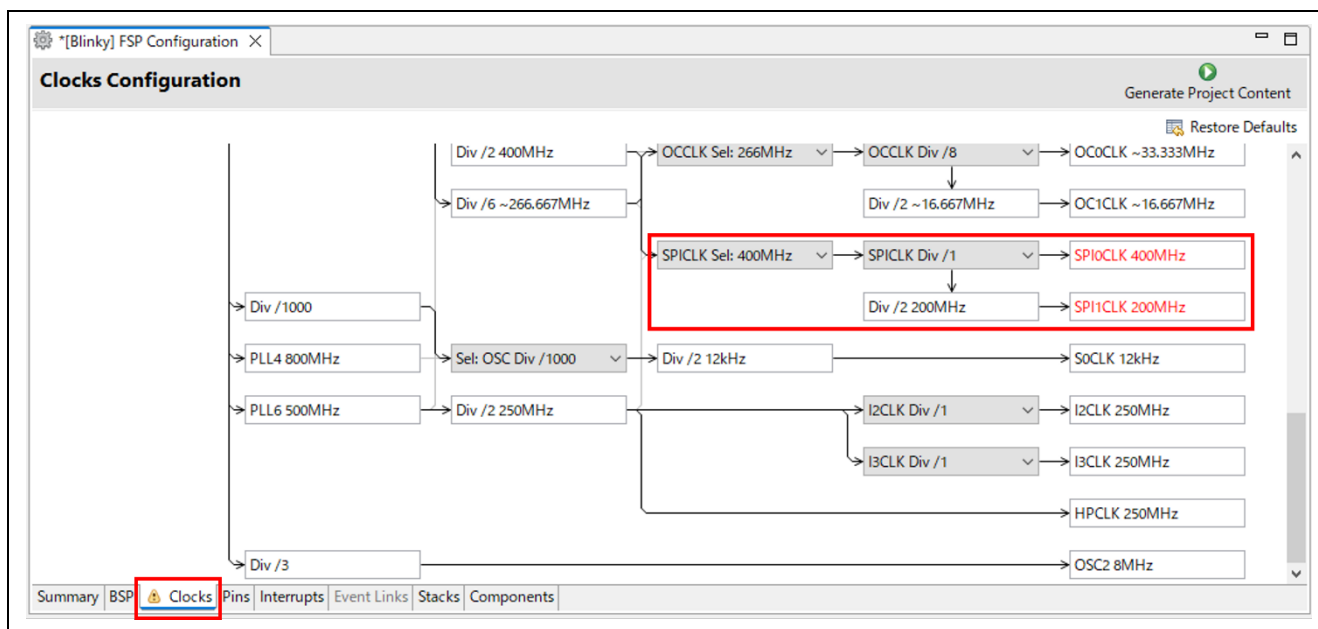

Figure 80 : Configuration Clocks tab

When you click the **Generate Project Content** button, the clock configuration contents are written to `rzg_gen/bsp_clock_cfg.h`. This file will be created if it does not already exist.

Warning: Do not edit this file as it is overwritten whenever the **Generate Project Content** button is clicked.



### 5.2.4 Configuring Pins

The pins tab provides flexible configuration of the MPU's pins. As many pins can provide multiple functions, they can be configured on a peripheral basis. For example, selecting a serial channel via the SCIF peripheral offers multiple options for the location of the receive and transmit pins for that module and channel. The location and function of the pins are shown in the **FSP Visualization** view. For more information on the function and color coding of the pins, please check the Legend in the **FSP Visualization** view.

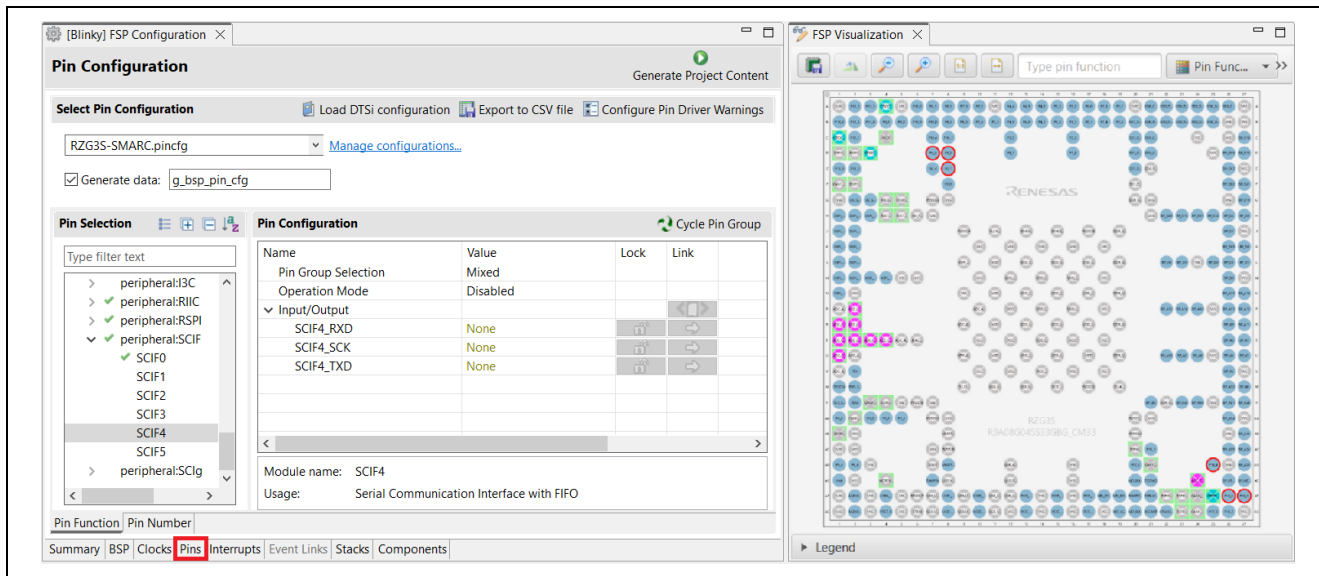

Figure 81 : Pin Configuration

The pin configurator includes built-in conflict checker. So, if the same pin is allocated to another peripheral or I/O function, the pin will be shown as red in the **FSP Visualization** view and with white cross in a red square in the **Pin Selection** pane and **Pin Configuration** pane in the main **Pins** tab.

In the example shown below, port P13\_1 is already used by the GPT, and the attempt to connect to this pin to the Serial Communication Interface with FIFO (SCIF) results in dangling connection error. To fix this error, select another port from the pin drop-down list or disable the GPT.

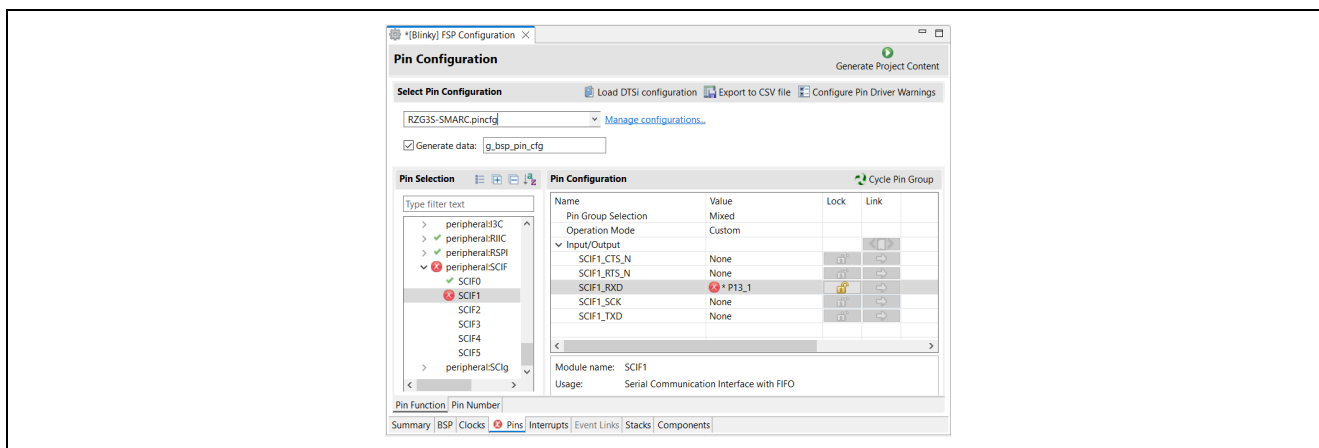

Figure 82 : e2 studio Pin Configurator

When you click the **Generate Project Content** button, the pin configuration contents are written to: `rzg_gen\pin_data.c`. This file will be created if it does not already exist.

**Warning:** Do not edit this file as it is overwritten whenever the **Generate Project Content** button is clicked.

In the case of versions earlier than RZ/G FSP v2.0.0, It does not support **Pins** tab and If user would like to use I/O port, I/O Port setting should be applied to “src/pin\_data.c” manually. For details on I/O Port setting and how to apply the setting of “src/pin\_data.c” to **Pins** tab, please refer to [Setting GPIO with Flexible Software Package](#).

### 5.2.5 Configuring Interrupts from the Stacks Tab

You can use the **Properties** view in the **Stacks** tab to enable interrupts by setting the interrupt priority. Select the driver in the **Stacks** pane to view and edit its properties.

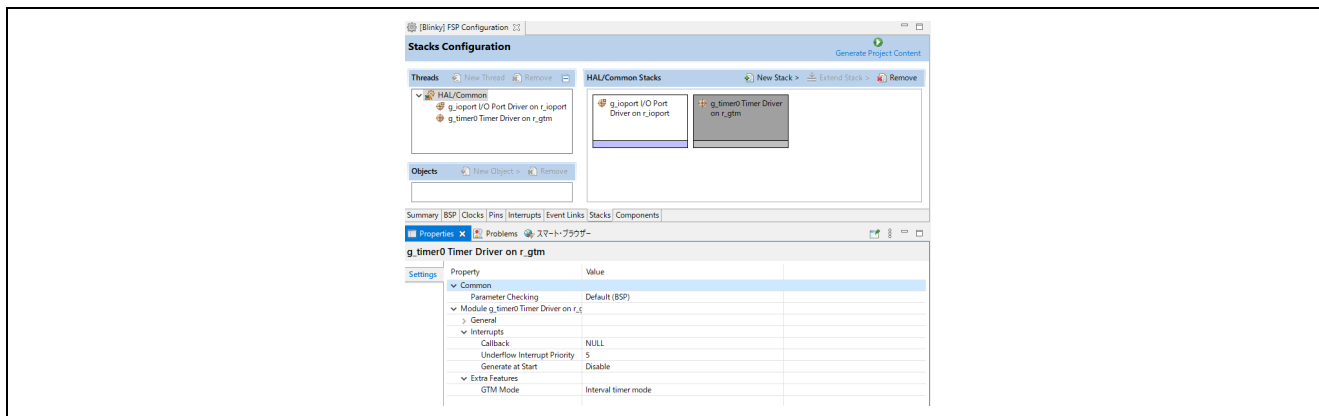

Figure 83 : Configuring Interrupts in the Stacks tab

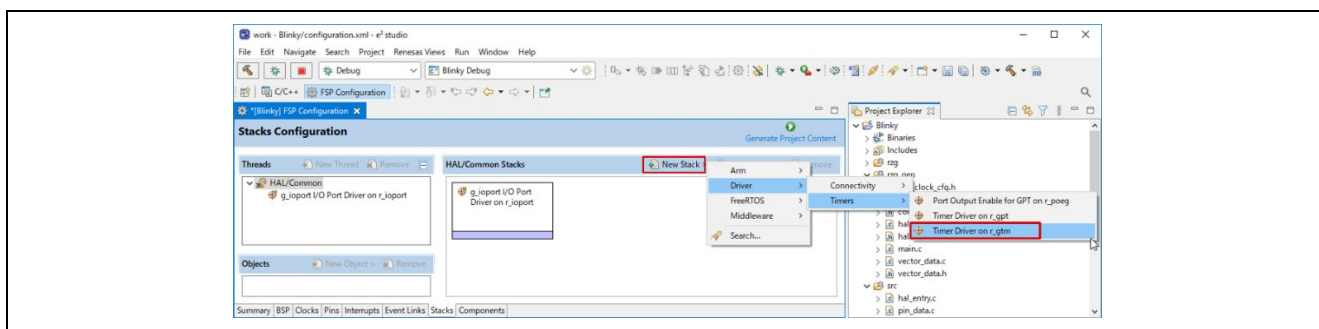

Figure 84: Add new stack Timer (GTM)

### 5.2.6 Creating Interrupts from the Interrupts Tab

On the **Interrupts** tab, the interrupts of the driver which user selected in the **Stacks** tab are registered.

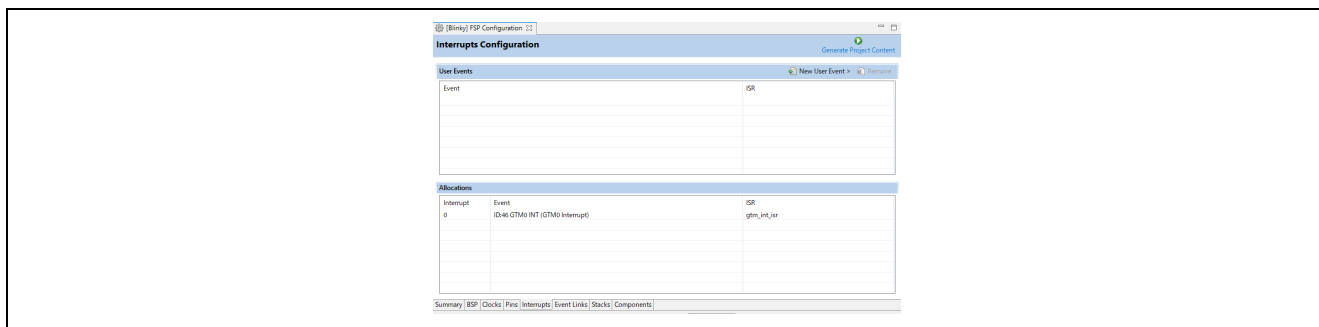

Figure 85 : Configuring interrupt in Interrupt Tab

Also, on the Interrupts tab, the user can add user's own peripheral interrupts. This can be achieved by adding a new event via the **New User Event** button.

### 5.2.7 Viewing Event Links

RZ/G FSP does not support **Event Links** tab, and it is grayed out.

### 5.2.8 Adding and Configuring HAL Drivers

For applications that run outside or without the RTOS, you can add additional HAL drivers to your application using the HAL/Common thread. To add drivers, follow these steps:

1. Click on the HAL/Common icon in the **Stacks** pane. The Modules pane changes to **HAL/Common Stacks**.
2. Click **New Stack** to see a drop-down list of HAL level drivers available in the FSP.
3. Select a driver from the menu **New Stack > Driver**.

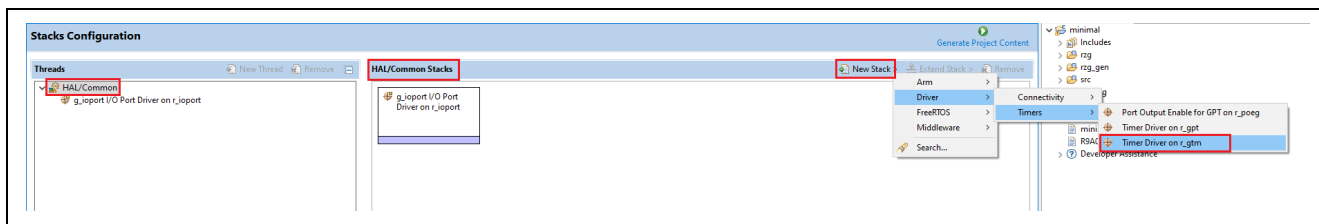

Figure 86 : e2 studio Project configurator - Adding drivers

4. Select the driver module in the **HAL/Common Modules** pane and configure the driver properties in the **Properties** view.

e2 studio adds the following files when you click the **Generate Project Content** button:

- The selected driver module and its files to the rzg/fsp directory
- The main() function and configuration structures and header files for your application as shown in the table below.

File	Contents	Overwritten by Generate Project Content?
rzg_gen/main.c	Contains main() calling generated and user code. When called, the BSP has already initialized the MPU.	Yes
rzg_gen/hal_data.c	Configuration structures for HAL Driver only modules.	Yes
rzg_gen/hal_data.h	Header file for HAL driver only modules.	Yes
src/hal_entry.c	User entry point for HAL Driver only code. Add your code here.	No

The configuration header files for all included modules are created or overwritten in this folder:  
rzg\_cfg/fsp\_cfg

### 5.3 Reviewing and Adding Components

The **Components** tab enables the individual modules required by the application to be included or excluded. Modules common to all RZ/G MPU projects are preselected. All modules that are necessary for the modules selected in the **Stacks** tab are included automatically. You can include or exclude additional modules by ticking the box next to the required component.

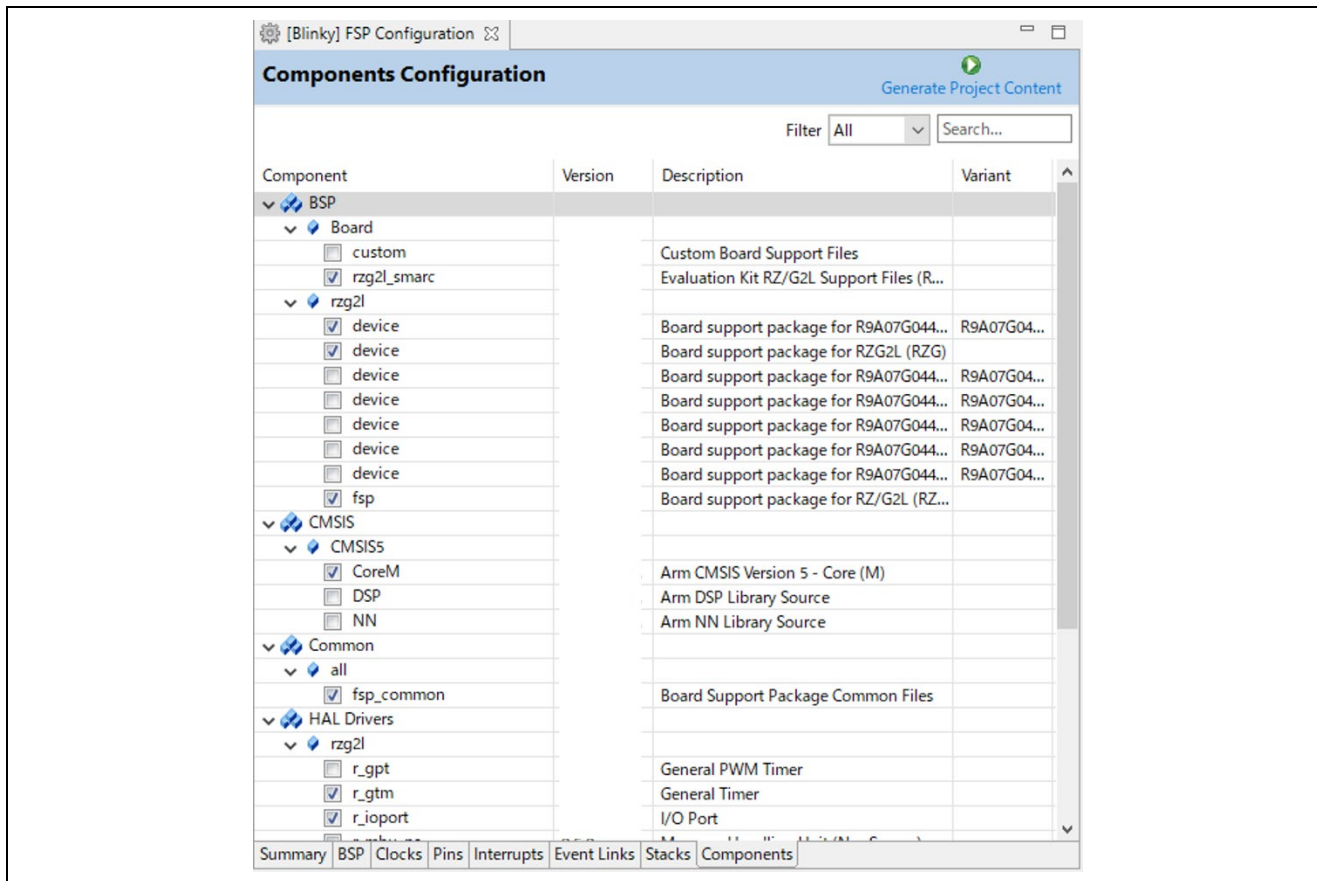

Figure 87 : Components Tab

Clicking the **Generate Project Content** button copies the .c and .h files for each selected component into the following folders:

- rzg/fsp/inc/api
- rzg/fsp/inc/instances
- rzg/fsp/src/bsp
- rzg/fsp/src/<Driver\_Name>

e2 studio also creates configuration files in the rzg\_cfg/fsp\_cfg folder with configuration options set in the **Stacks** tab.

### 5.4 Debugging the Project

Once your project builds without errors, you can use the Debugger to download your application to the board and execute it.

To debug an application, follow these steps:

1. On the drop-down list next to the debug icon, select **Debug Configurations**.

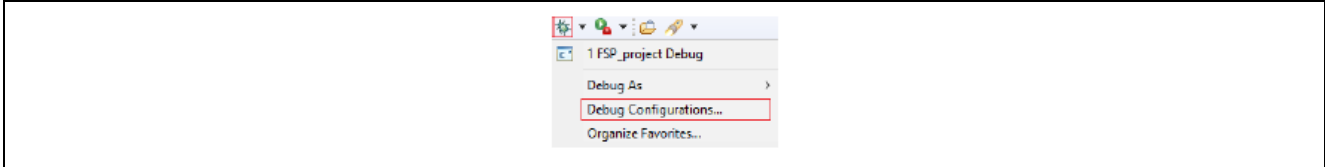

2. In the **Debug Configurations** view, click on your project listed as **MyProject Debug**.

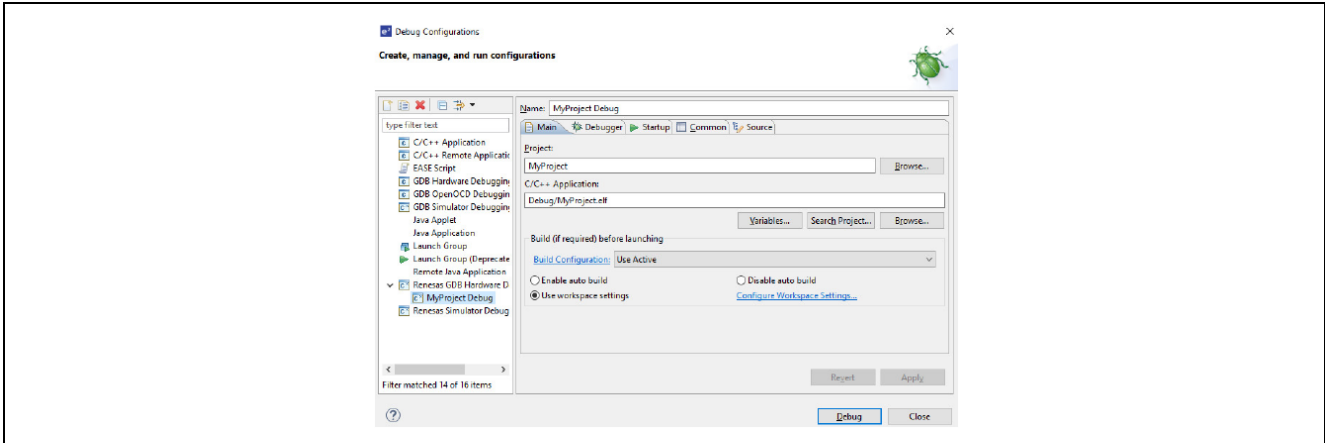

3. Secure and Non-secure Vector Address are configured in the **Connection Settings** tab of the **Debugger** tab. The settings in below image are for setting the address of Secure and Non-secure Vector Offset mapped in Blinky project. Please note that these addresses vary in accordance with linker settings.

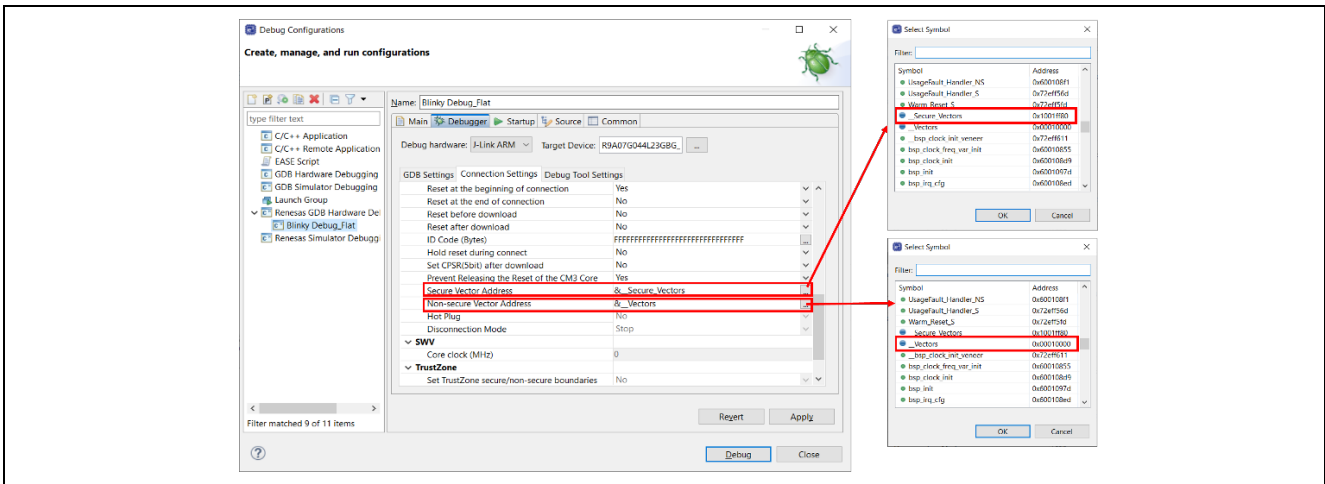

4. Connect the board to your PC via a standalone Segger J-Link debugger and click **Debug**.

Note: For details on using J-Link and connecting the board to the PC, see 3.1.2.2.JTAG connection.

## 5.5 Modifying Toolchain Settings

There are instances where it may be necessary to make changes to the toolchain being used (for example, to change optimization level of the compiler or add a library to the linker). Such modifications can be made within e2 studio through the menu **Project > Properties > Settings** when the project is selected. The following screenshot shows the settings dialog for the GNU Arm toolchain. This dialog will look slightly different depending upon the toolchain being used.

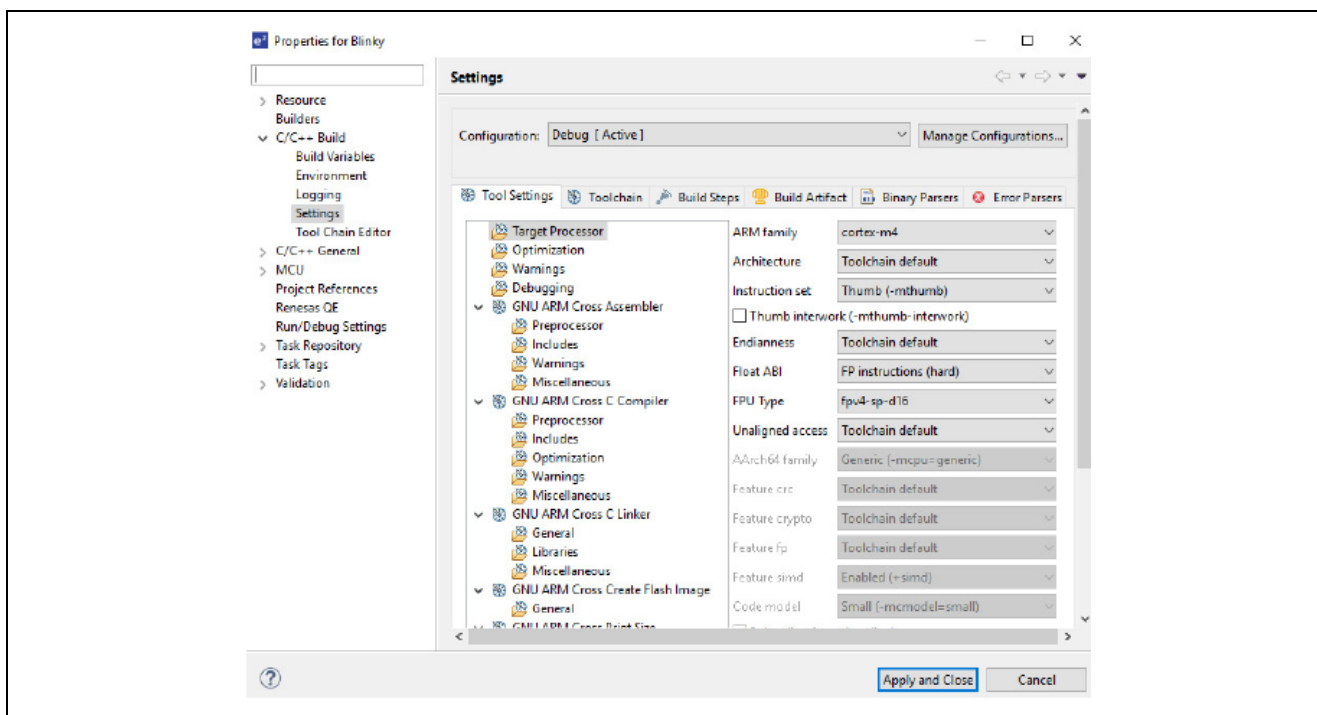

**Figure 88 : e2 studio Project toolchain settings**

The scope for the settings is project scope which means that the settings are valid only for the project being modified.

The settings for the linker which control the location of the various memory sections are contained in a script file specific for the device being used. This script file is included in the project when it is created and is found in the created project. (for example, script/fsp.ld).

## 5.6 Importing an Existing Project into e2 studio

1. Start by opening e2 studio.
2. Open an existing Workspace to import the project and skip to step d. If the workspace does not exist, proceed with the following steps:

- a. At the end of e2 studio startup, you will see the Workspace Launcher Dialog box as shown in the following figure.

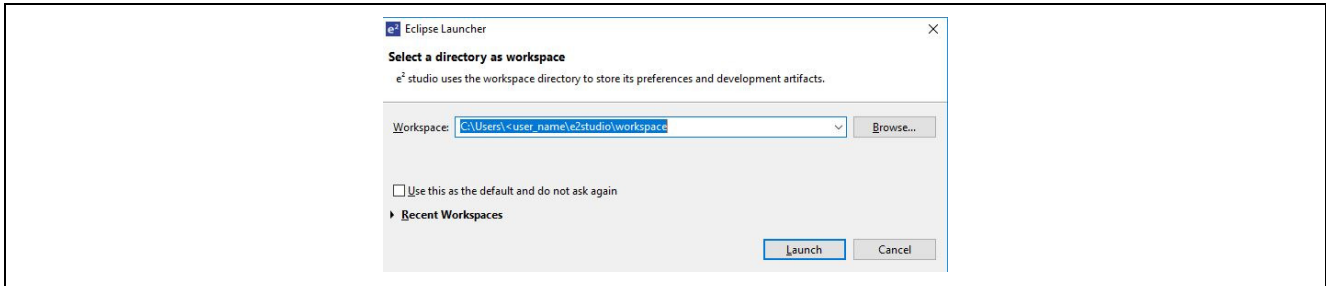

Figure 89 : Workspace Launcher dialog

- b. Enter a new workspace name in the Workspace Launcher Dialog as shown in the following figure. e2 studio creates a new workspace with this name.

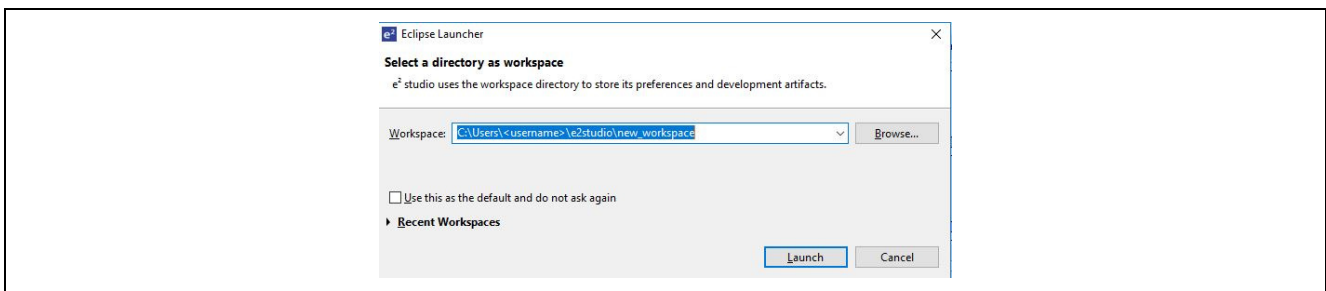

Figure 90 : Workspace Launcher dialog - Select Workspace

- c. Click **Launch**.
- d. When the workspace is opened, you may see the Welcome Window. Click on the **Workbench** arrow button to proceed past the Welcome Screen as seen in the following figure.

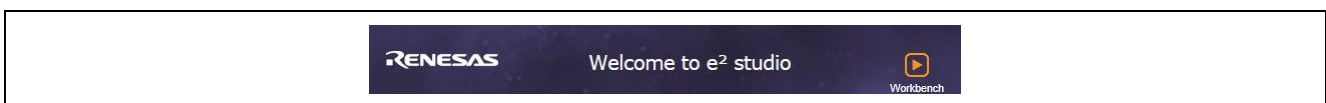

Figure 91 : Workbench arrow button

3. You are now in the workspace that you want to import the project into. Click the **File** menu in the menu bar, as shown in the following figure.

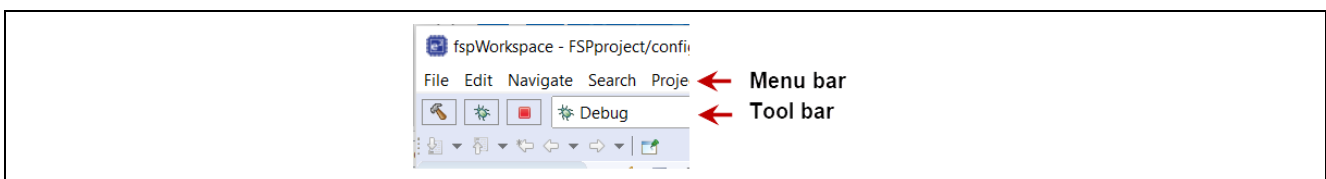
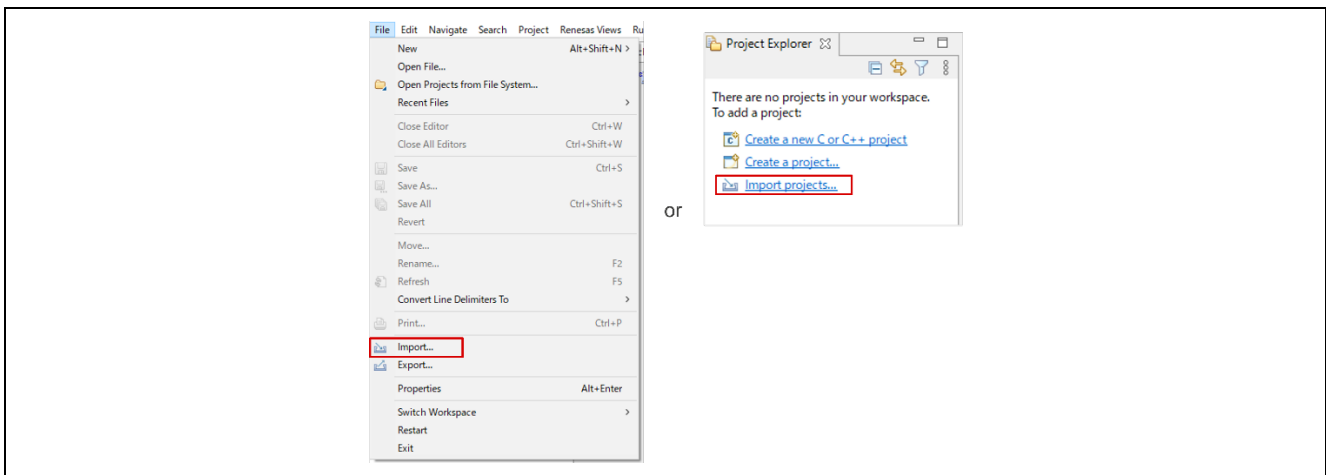

Figure 92 : Menu and tool bar



- Click **Import** on the **File** menu or “Import project” on Project Explorer, as shown in the following figure.



**Figure 93 : File drop-down menu**

- In the **Import** dialog box, as shown in the following figure, choose the **General** option, then **Existing Projects into Workspace**, to import the project into the current workspace.

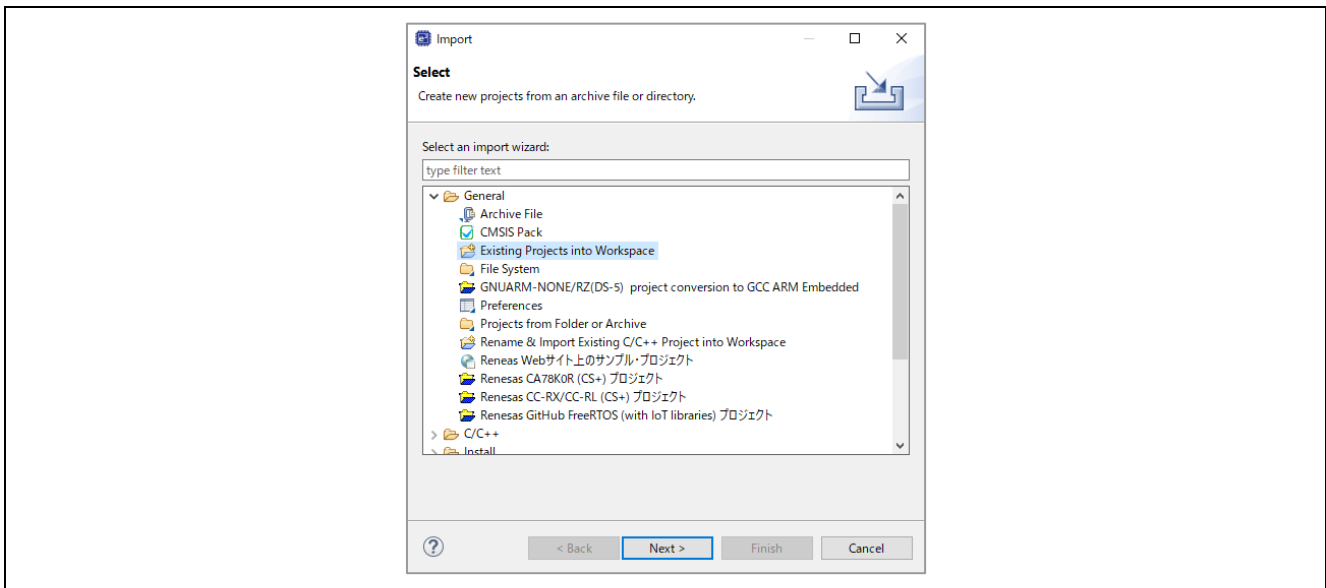

**Figure 94 : Project Import dialog with "Existing Projects into Workspace" option selected**

6. Click **Next**.
7. To import the project, use either **Select archive file** or **Select root directory**.
  - a. Click **Select root directory** file as shown in the following figure.

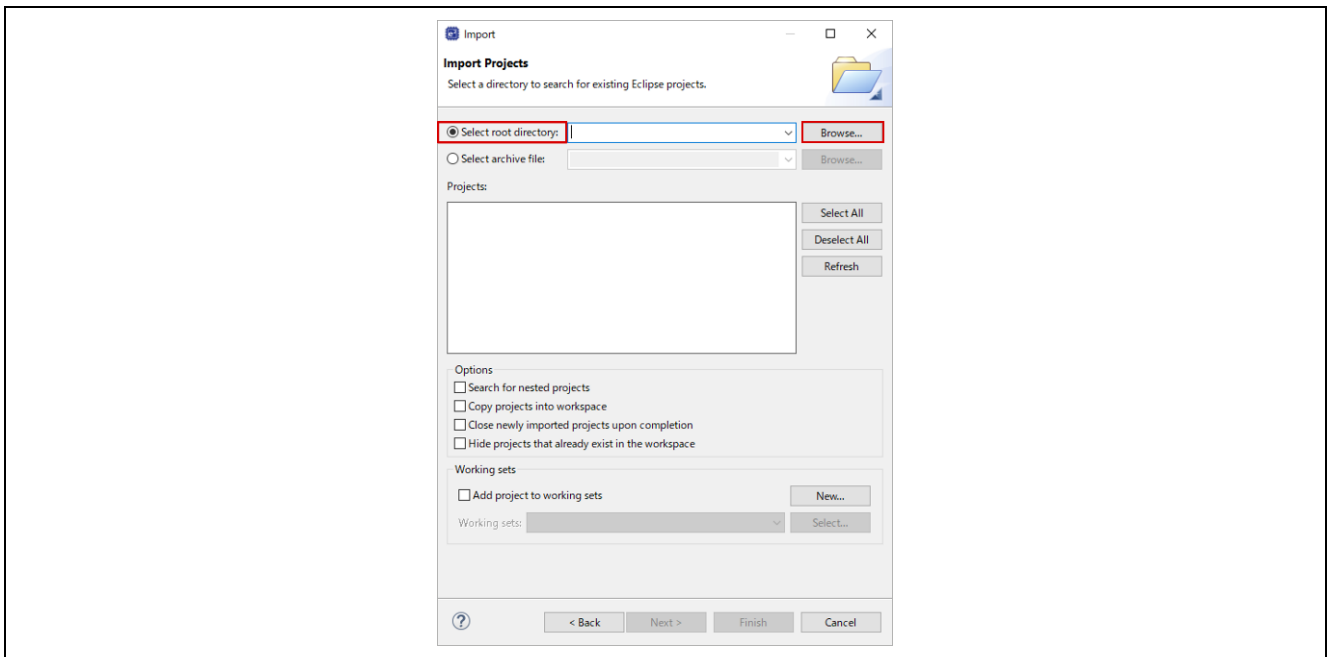

**Figure 95 : Import Existing Project dialog 1 - Select root directory**

- b. Click **Browse**.
- c. For **Select root directory**, browse to the project folder that you want to import.
- d. Select the file for import.
- e. Click **Open**.
- f. Select the project to import from the list of **Projects**, as shown in the following figure.

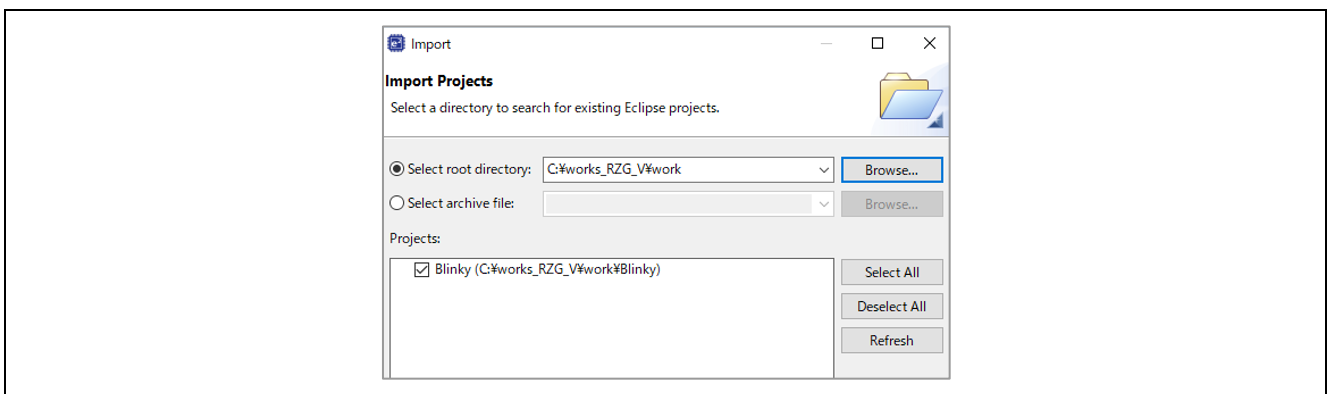

**Figure 96 : Import Existing Project dialog 2**

8. Click **Finish** to import the project.

## 6. Migration from previous version

When updating the FSP used in project from v2.0.0 to FSP v2.0.1, please follow the procedure described in this chapter.

As a preparation, please install the latest version of FSP pack in advance by following the procedure in section 2.2.

### 6.1 How to update RZ/G2L, RZ/G2LC, RZ/G2UL project

1. Display the BSP tab of Smart Configurator for the target project.

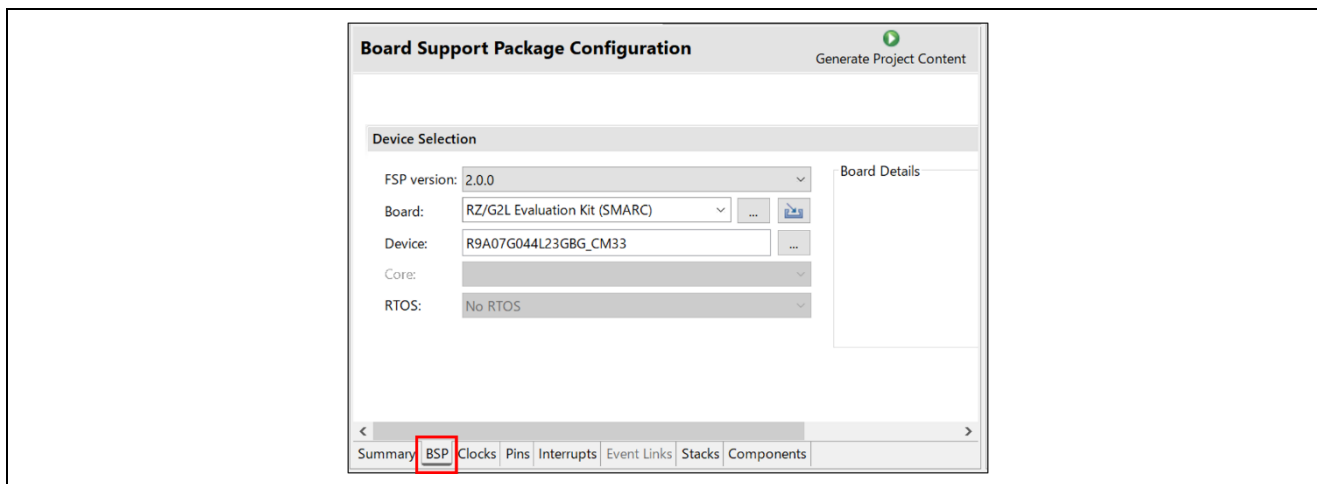

Figure 97 : BSP tab of Smart Configurator

2. Select the version you want to change from the drop-down list in the **FSP version** field.

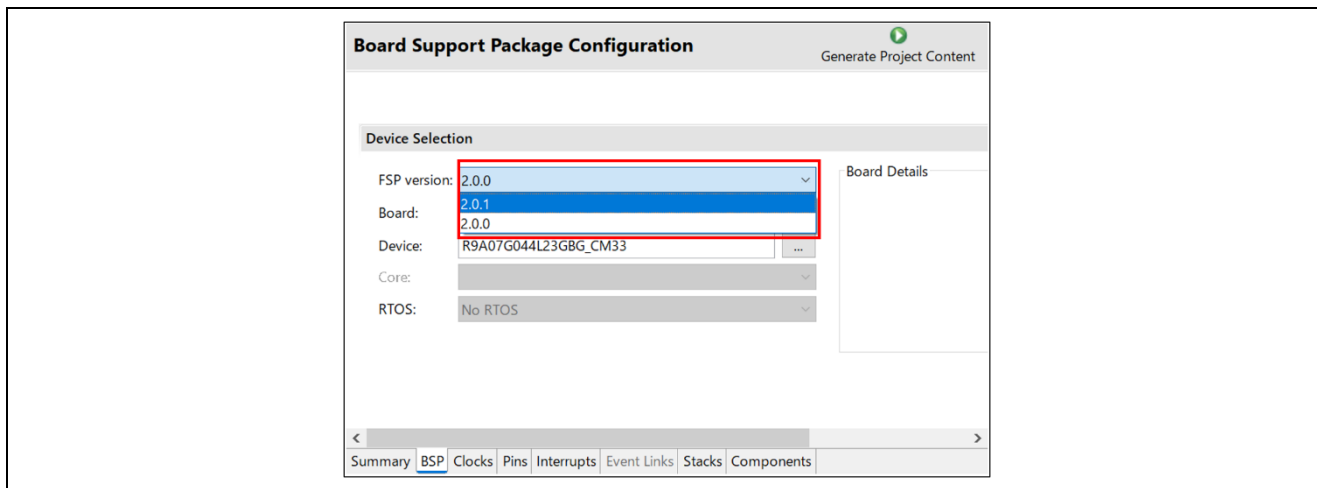
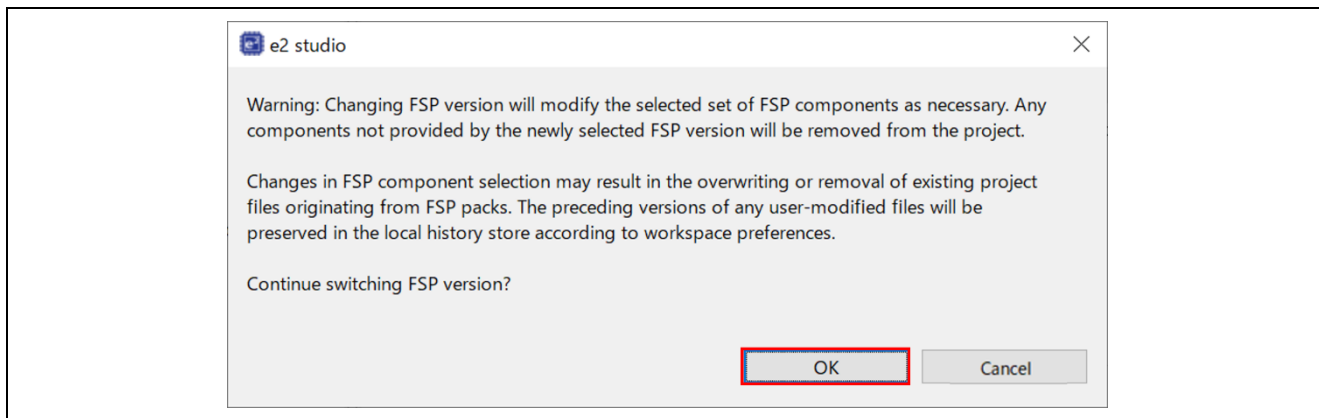

Figure 98 : Version selection

3. The following confirmation dialog will be displayed. Then select **OK**.



**Figure 99 : Confirmation dialog**

4. Press the Save button to save the FSP configuration update.

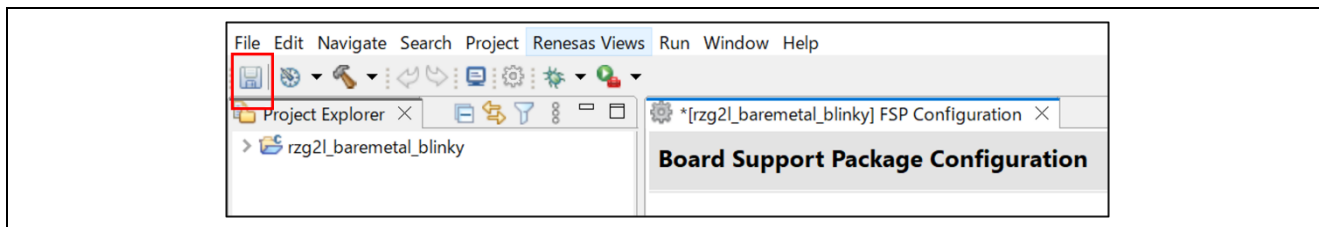

**Figure 100 : Save the FSP configuration**

5. Press the **Generate Project Content** button to generate the code for the selected version.

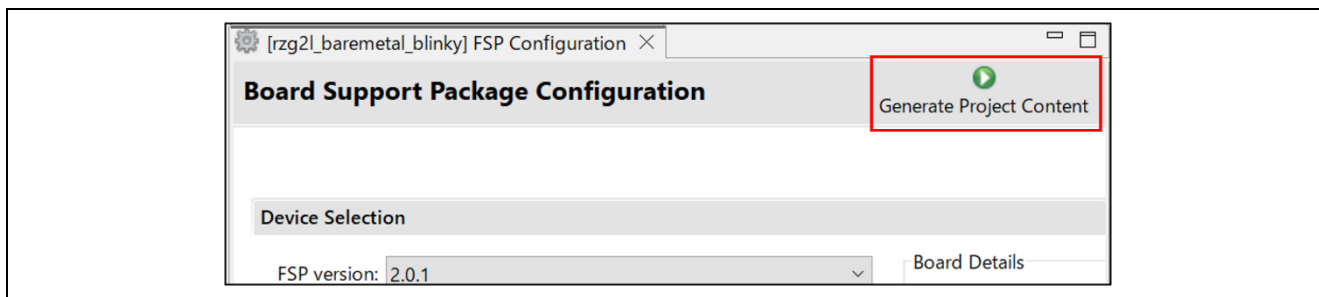

**Figure 101 : Project Generation**

6. Finally, build the project and update the executable.

## 6.2 How to update RZ/G3S project

The procedure differs depending on the target core. Please refer to the procedure depending on the core targeted by the project you are modifying.

### 6.2.1 Procedure to update the project for CM33 without FPU Core

This section describes procedure to update the version of a project created in the following conditions:

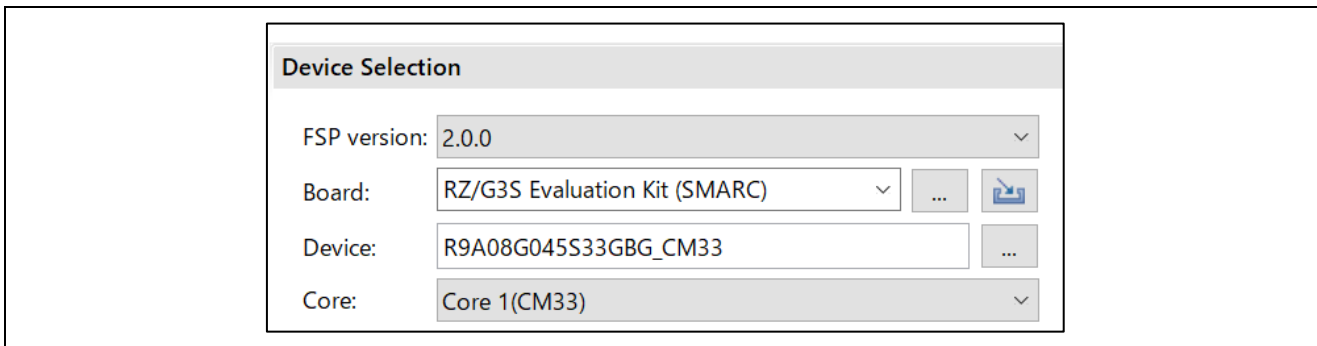

Figure 102 : Condition of target project on BSP tab

1. Open Smart Configurator **BSP** tab and change **FSP version** to latest.

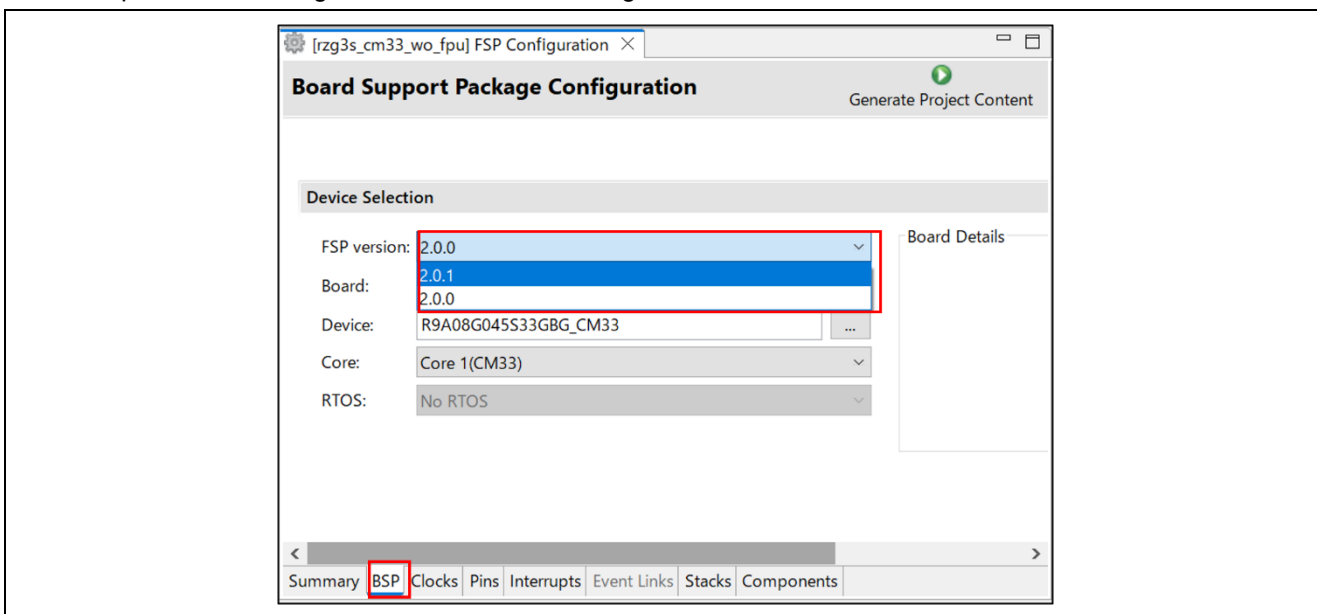

Figure 103 : Version selection

2. The following confirmation dialog will be displayed. Then select **OK**.

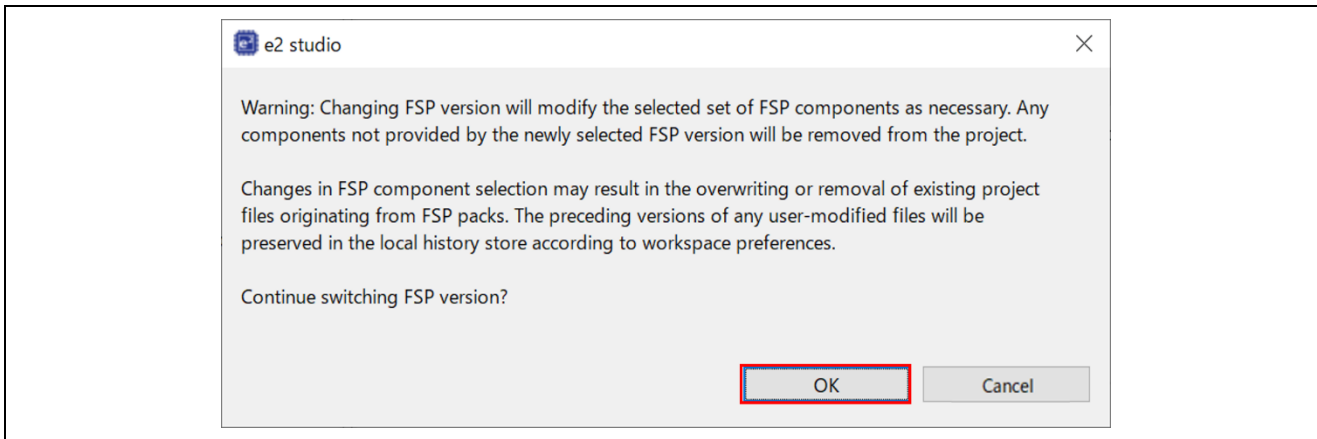

Figure 104 : Confirmation dialog

3. Select **Custom User Board (Any Device)** on the **Board** combo.

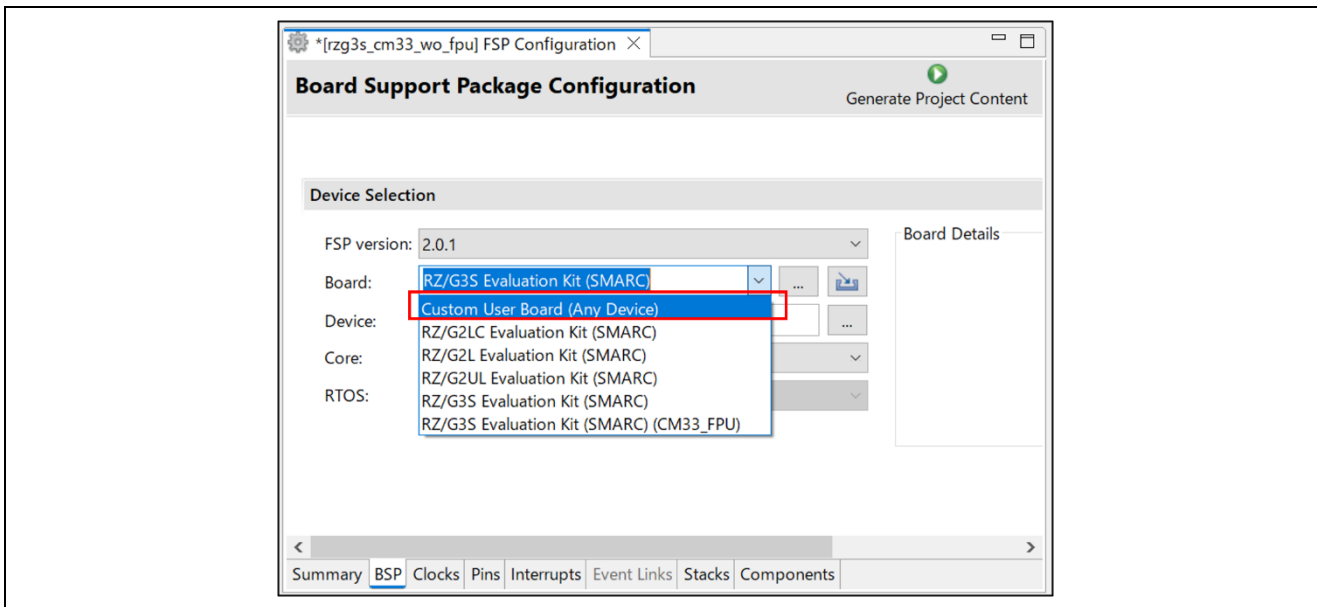

Figure 105 : Board selection

4. The following confirmation dialog will be displayed. Then select **Save and Continue**.

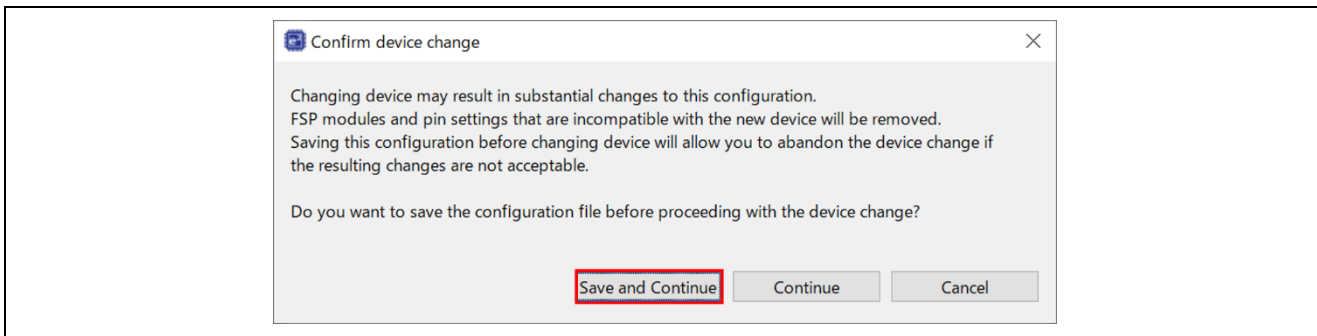

Figure 106 : Confirmation dialog

5. Select **RZ/G3S Evaluation Kit (SMARC)** on the **Board** combo.

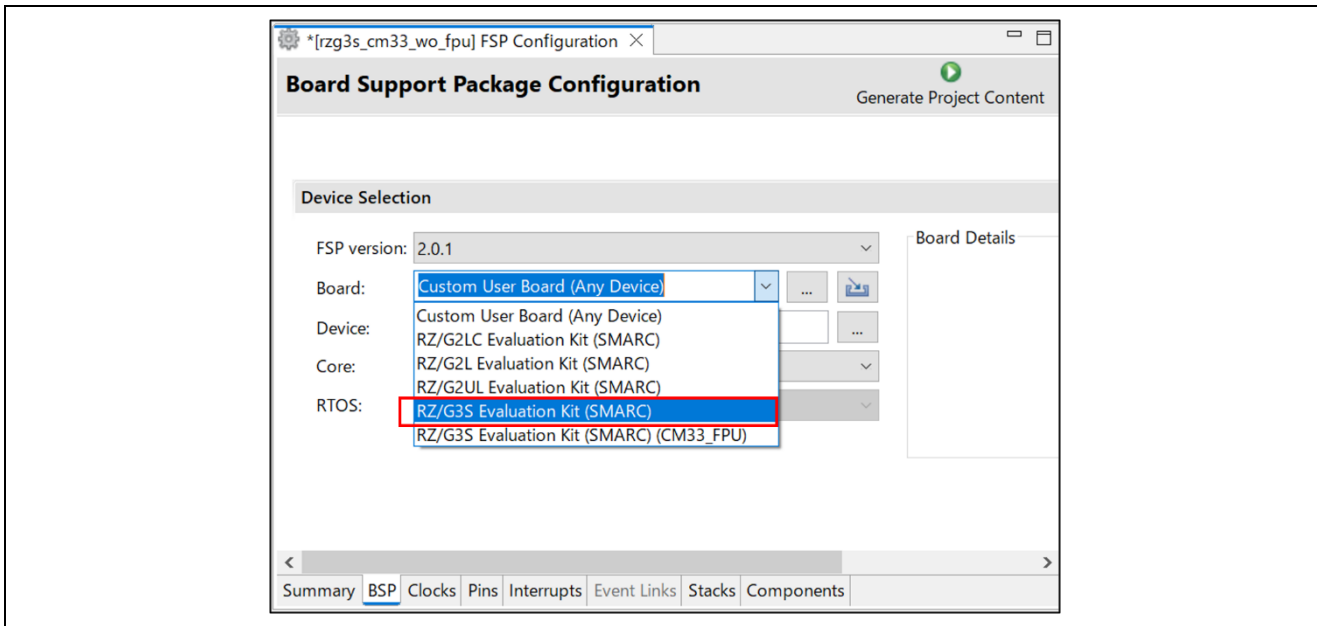

Figure 107 : Board reselection

6. The following confirmation dialog will be displayed. Then select **Save and Continue**.

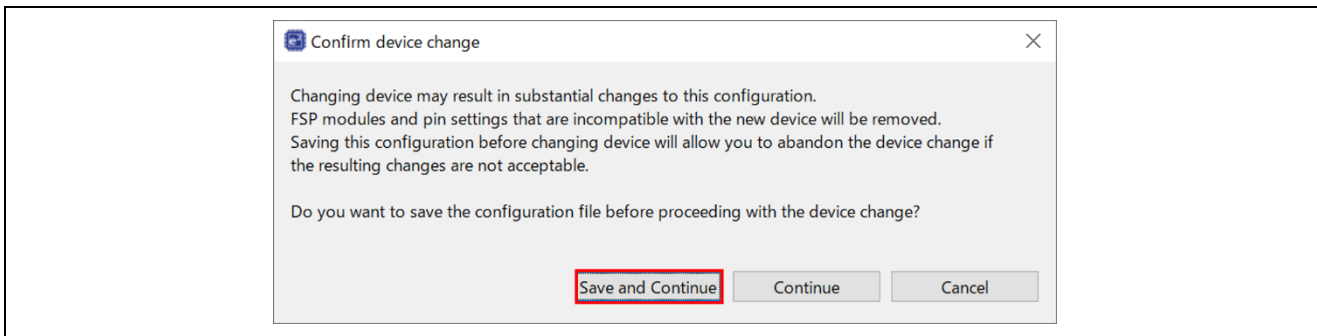

Figure 108 : Confirmation dialog

7. Select **Core 2(CM33\_FPU)** and save.

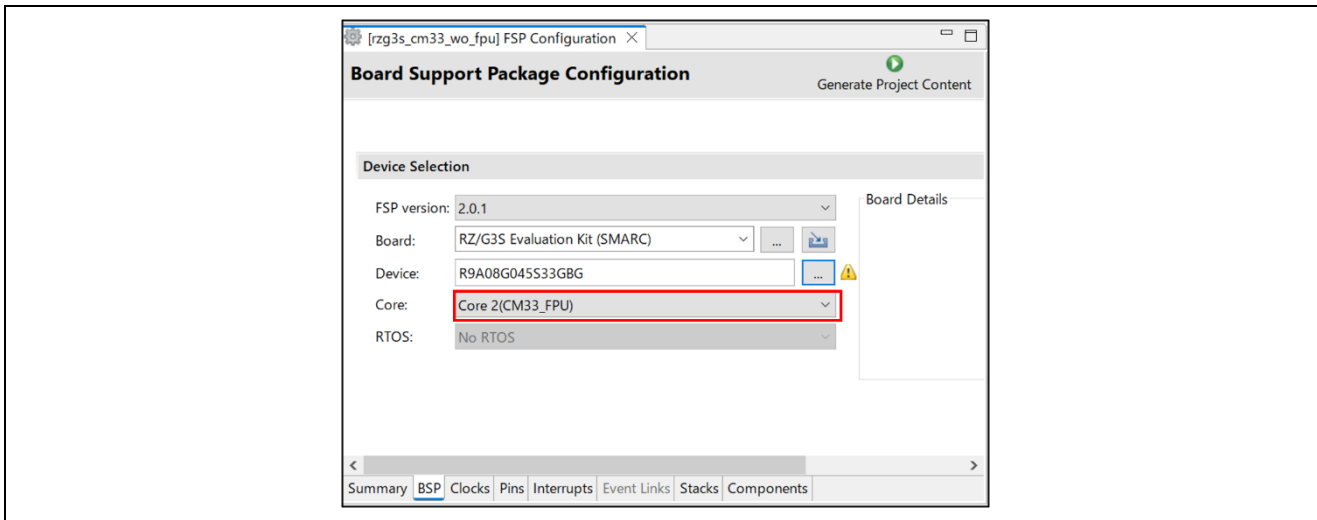

Figure 109 : Core selection (1/2)



8. Select **Core 1(CM33)** and save.

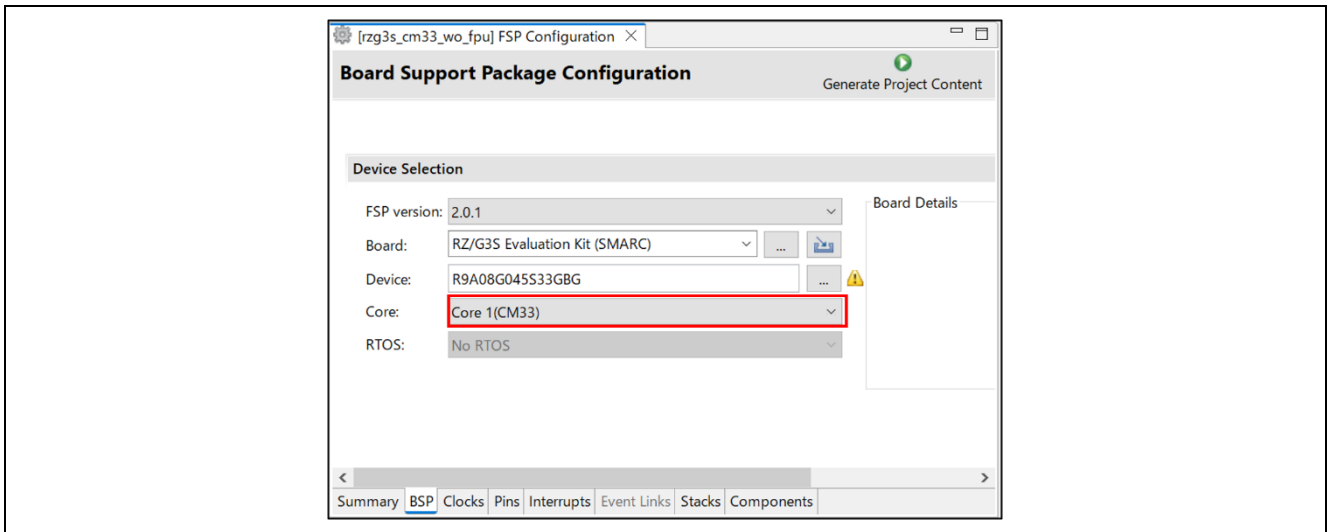

Figure 110 : Core selection (2/2)

9. Press the **Generate Project Content** button.

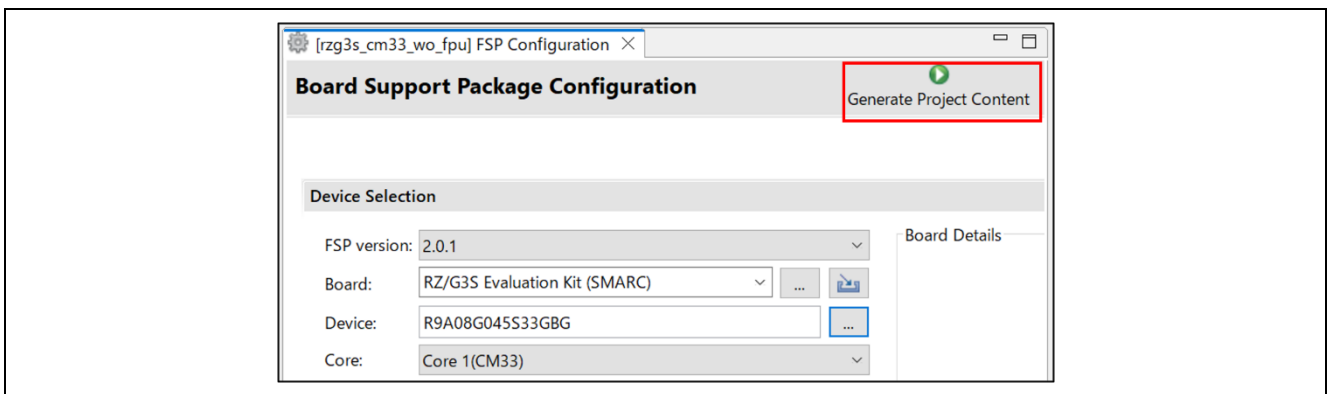

Figure 111 : Project Generation

10. Build the project

Note: The exclamation mark to the right of the device combo disappears once you switch to a display other than the BSP tab.

### 6.2.2 Procedure to update the project for CM33 with FPU Core

This section provides procedure to update the version of a project created in the following conditions:

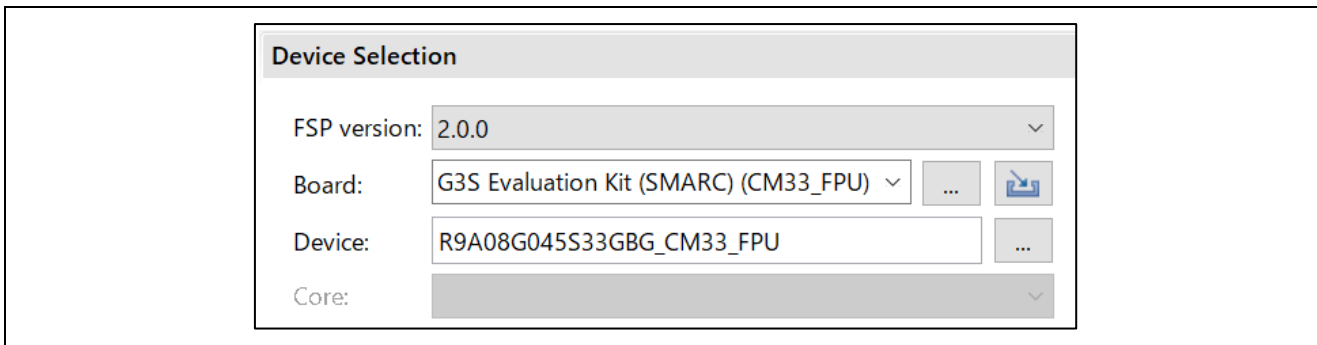

Figure 112 : Condition of target project on BSP tab

1. Open Smart Configurator **BSP** tab and change **FSP version** to latest.

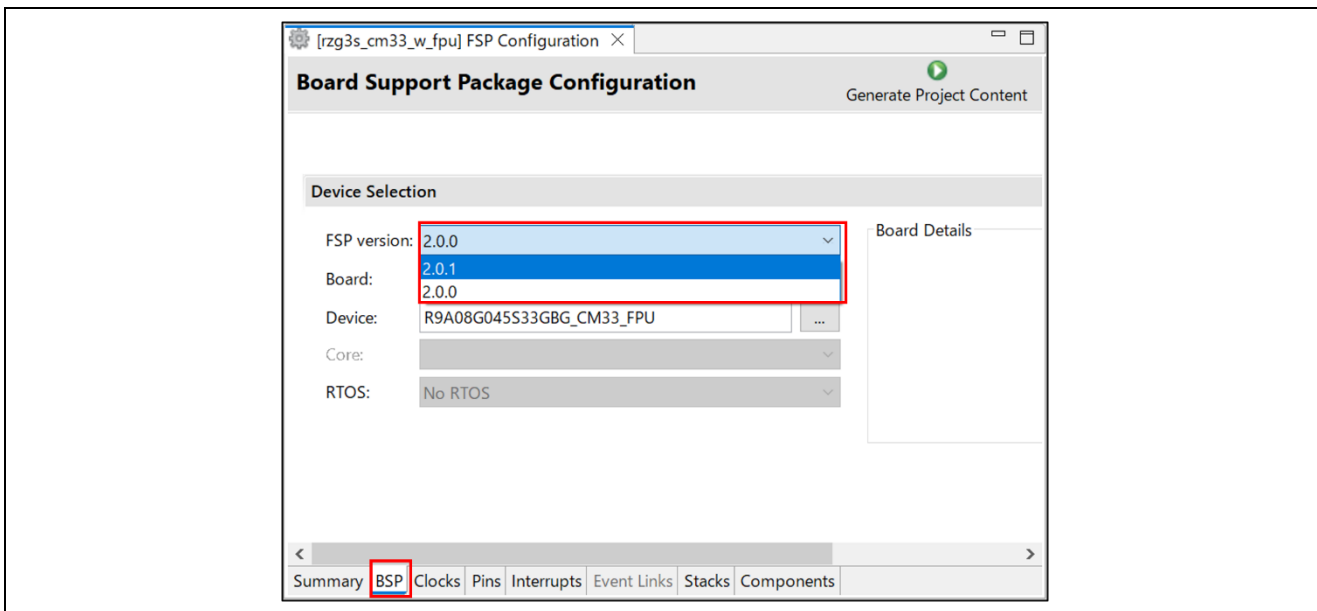

Figure 113 : Version selection

2. The following confirmation dialog will be displayed. Then select **OK**.

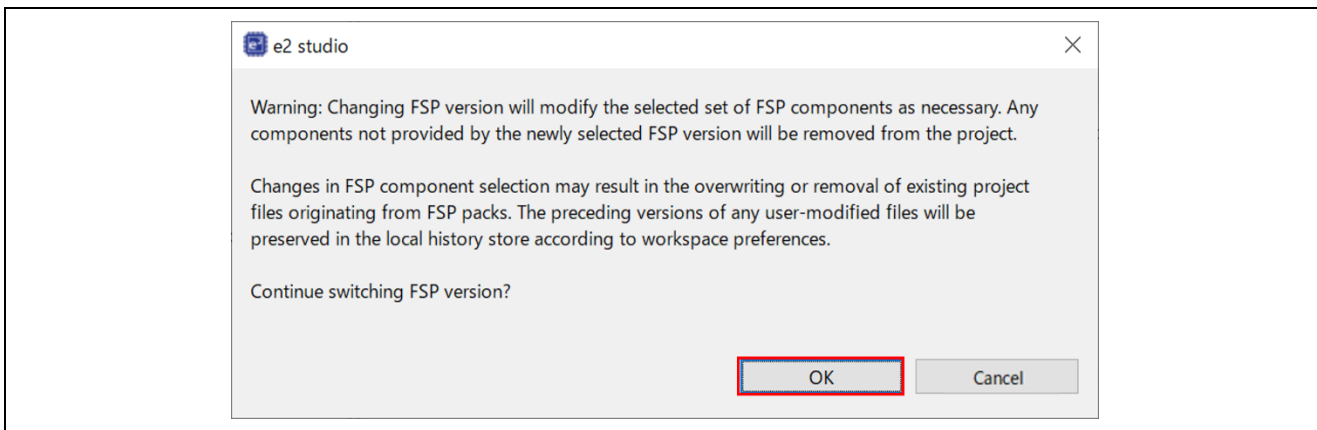
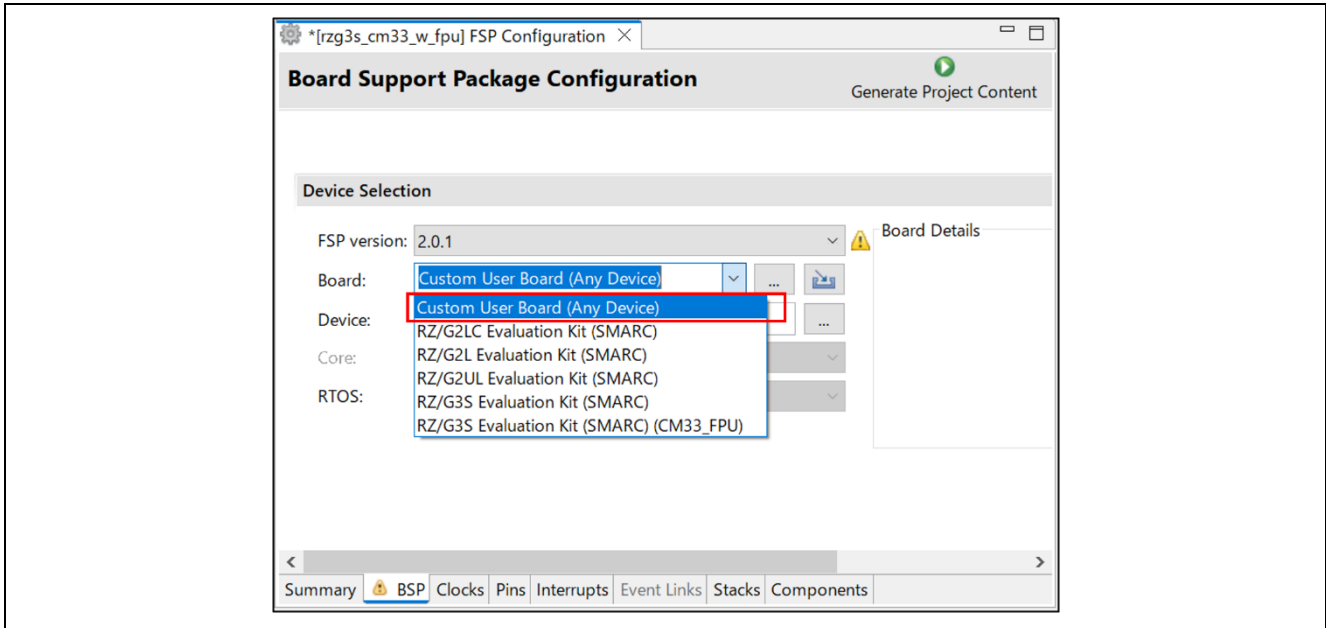

Figure 114 : Confirmation dialog

3. Select **Custom User Board (Any Device)** on the **Board** combo.



**Figure 115 : Board selection**

4. The following confirmation dialog will be displayed. Then select **Save and Continue**.

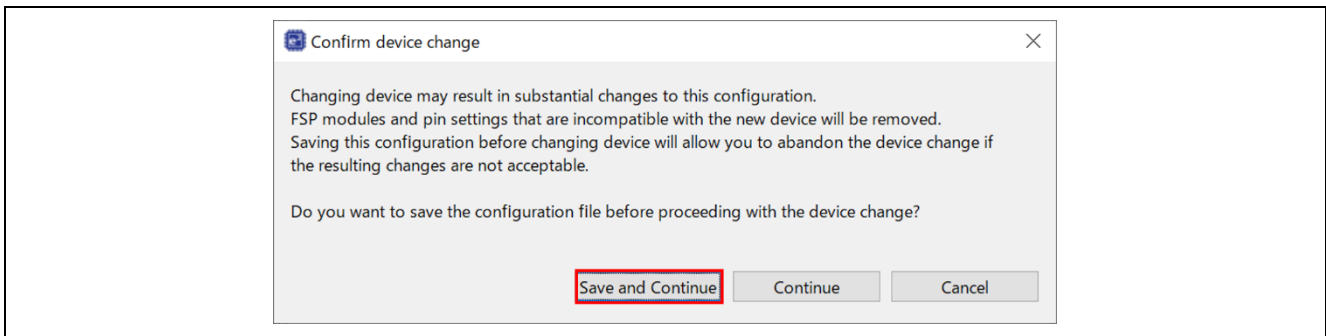

**Figure 116 : Confirmation dialog**

5. Select **RZ/G3S Evaluation Kit (SMARC)** on the **Board** combo.

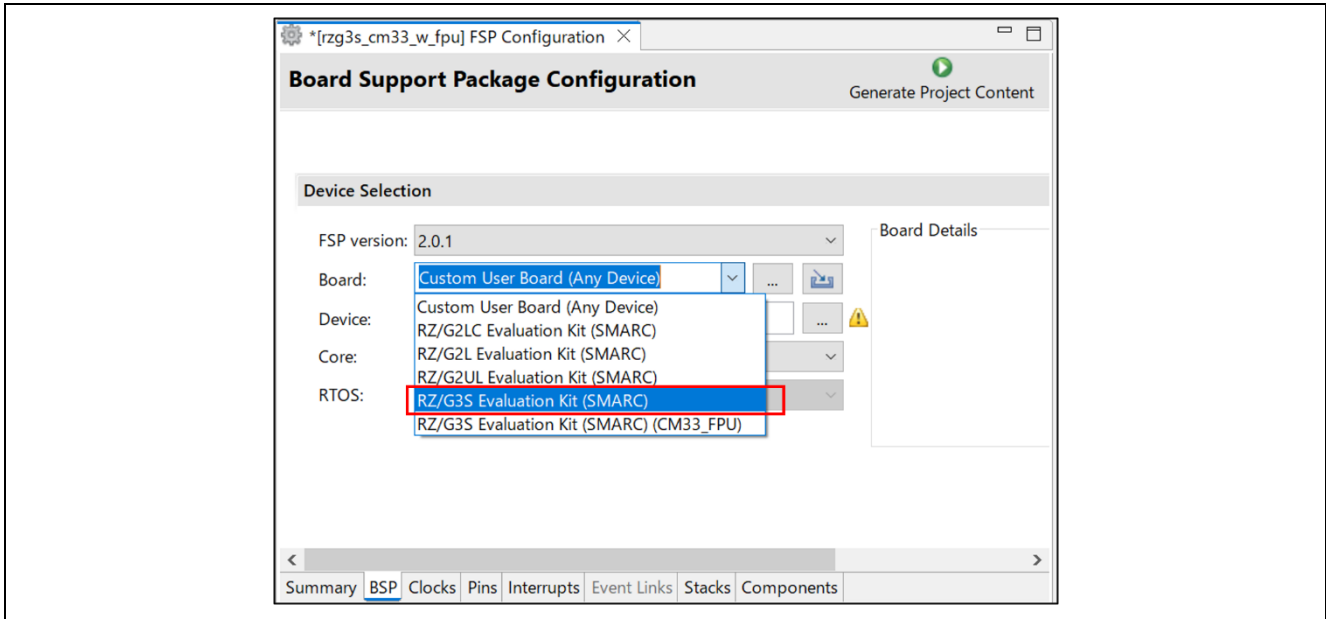

**Figure 117 : Board reselection**

6. The following confirmation dialog will be displayed. Then select **Save and Continue**.

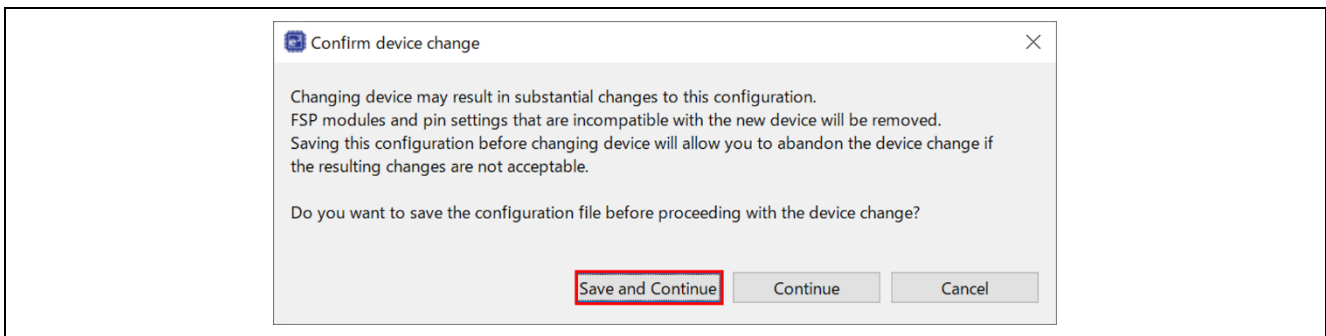

**Figure 118 : Confirmation dialog**

7. Select **Core 2(CM33\_FPU)** and save.

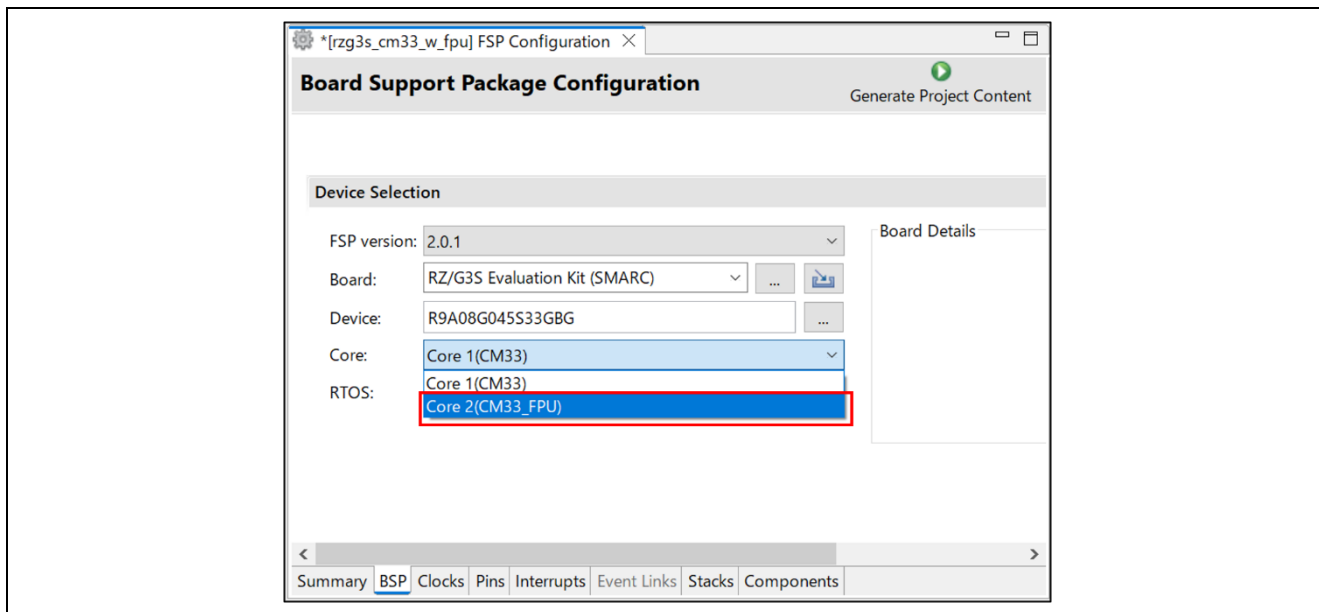

Figure 119 : Core selection

8. Press the **Generate Project Content** button.

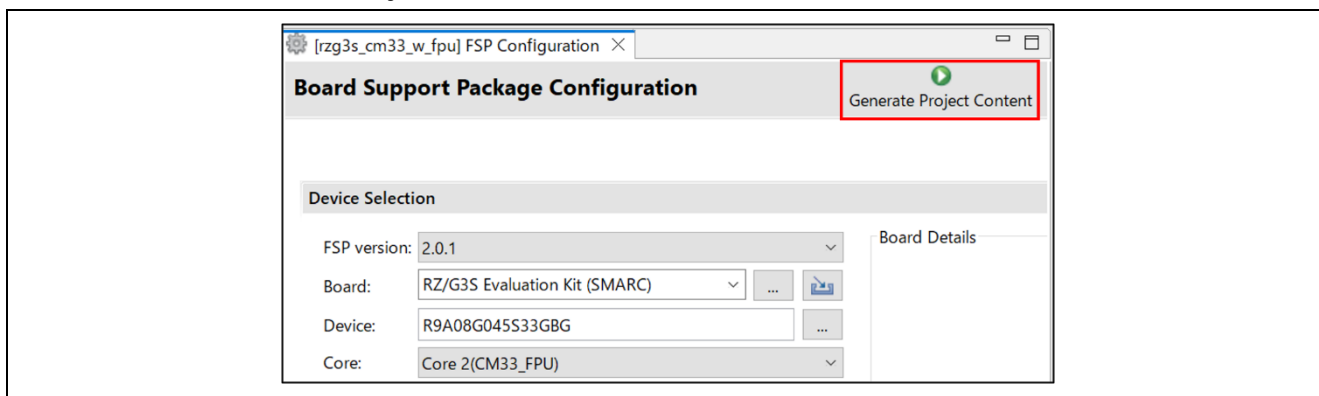

Figure 120 : Project Generation

9. Build the project

Note: The exclamation mark to the right of the device combo disappears once you switch to a display other than the BSP tab.

**Revision History**

Rev.	Date	Description	
		Page	Summary
2.01	Feb.13.2.24	6 to 11, 13 to 22,	Updated the description and figure based on the latest development environment.
		45	Updated the description of project creation.
		48	Added the section of how to avoid resource duplication description in the case of RZ/G3S project creation.
		60 to 69	Added the section of how migrate the project which using previous FSP version to latest FSP version.
2.00	Jan.9.24	1	Added RZ/G3S to the target device.
		5	Updated the description of the RAM initialization section.
		6 to 11	Updated the description and figure based on the latest development environment.
		12 to 22	Updated the development setup for Linux Host PC and FSP installation.
		26 to 32	Added description and figure for RZ/G3S SMARC EVK.
		33 to 36	Updated the description and figure based on the latest development environment.
		40	Removed the steps to configure Secure Vector and Non-secure Vector from the Debug step.
		46 to 51	Added description about the Pins and Clocks tabs.
		55	Updated the instructions for configuring Secure Vector and Non-secure Vector.
1.20	Nov.30.22	13	Updated version information of SEGGER J-Link driver and Libgen Update for GNU ARM Embedded Toolchains.
		20, 24	Updated installation procedure for FSP packs.
		55	Updated the method of specifying Secure Vector Address and Non-secure Vector Address.
1.10	Apr.27.22	5 to 53	Updated the description and figure based on the latest development environment.
1.01	Dec.3.21	14 to 22	Added a section of e2 studio installation for Linux PC.
1.00	Jul.30.21	-	First Edition issued.

## General Precautions in the Handling of Microprocessing Unit and Microcontroller Unit Products

The following usage notes are applicable to all Microprocessing unit and Microcontroller unit products from Renesas. For detailed usage notes on the products covered by this document, refer to the relevant sections of the document as well as any technical updates that have been issued for the products.

### 1. Precaution against Electrostatic Discharge (ESD)

A strong electrical field, when exposed to a CMOS device, can cause destruction of the gate oxide and ultimately degrade the device operation. Steps must be taken to stop the generation of static electricity as much as possible, and quickly dissipate it when it occurs. Environmental control must be adequate. When it is dry, a humidifier should be used. This is recommended to avoid using insulators that can easily build up static electricity.

Semiconductor devices must be stored and transported in an anti-static container, static shielding bag or conductive material. All test and measurement tools including work benches and floors must be grounded. The operator must also be grounded using a wrist strap. Semiconductor devices must not be touched with bare hands. Similar precautions must be taken for printed circuit boards with mounted semiconductor devices.

### 2. Processing at power-on

The state of the product is undefined at the time when power is supplied. The states of internal circuits in the LSI are indeterminate and the states of register settings and pins are undefined at the time when power is supplied. In a finished product where the reset signal is applied to the external reset pin, the states of pins are not guaranteed from the time when power is supplied until the reset process is completed. In a similar way, the states of pins in a product that is reset by an on-chip power-on reset function are not guaranteed from the time when power is supplied until the power reaches the level at which resetting is specified.

### 3. Input of signal during power-off state

Do not input signals or an I/O pull-up power supply while the device is powered off. The current injection that results from input of such a signal or I/O pull-up power supply may cause malfunction and the abnormal current that passes in the device at this time may cause degradation of internal elements. Follow the guideline for input signal during power-off state as described in your product documentation.

### 4. Handling of unused pins

Handle unused pins in accordance with the directions given under handling of unused pins in the manual. The input pins of CMOS products are generally in the high-impedance state. In operation with an unused pin in the open-circuit state, extra electromagnetic noise is induced in the vicinity of the LSI, an associated shoot-through current flows internally, and malfunctions occur due to the false recognition of the pin state as an input signal become possible.

### 5. Clock signals

After applying a reset, only release the reset line after the operating clock signal becomes stable. When switching the clock signal during program execution, wait until the target clock signal is stabilized. When the clock signal is generated with an external resonator or from an external oscillator during a reset, ensure that the reset line is only released after full stabilization of the clock signal. Additionally, when switching to a clock signal produced with an external resonator or by an external oscillator while program execution is in progress, wait until the target clock signal is stable.

### 6. Voltage application waveform at input pin

Waveform distortion due to input noise or a reflected wave may cause malfunction. If the input of the CMOS device stays in the area between  $V_{IL}$  (Max.) and  $V_{IH}$  (Min.) due to noise, for example, the device may malfunction. Take care to prevent chattering noise from entering the device when the input level is fixed, and also in the transition period when the input level passes through the area between  $V_{IL}$  (Max.) and  $V_{IH}$  (Min.).

### 7. Prohibition of access to reserved addresses

Access to reserved addresses is prohibited. The reserved addresses are provided for possible future expansion of functions. Do not access these addresses as the correct operation of the LSI is not guaranteed.

### 8. Differences between products

Before changing from one product to another, for example to a product with a different part number, confirm that the change will not lead to problems. The characteristics of a microprocessing unit or microcontroller unit products in the same group but having a different part number might differ in terms of internal memory capacity, layout pattern, and other factors, which can affect the ranges of electrical characteristics, such as characteristic values, operating margins, immunity to noise, and amount of radiated noise. When changing to a product with a different part number, implement a system-evaluation test for the given product.



## Notice

1. Descriptions of circuits, software and other related information in this document are provided only to illustrate the operation of semiconductor products and application examples. You are fully responsible for the incorporation or any other use of the circuits, software, and information in the design of your product or system. Renesas Electronics disclaims any and all liability for any losses and damages incurred by you or third parties arising from the use of these circuits, software, or information.
2. Renesas Electronics hereby expressly disclaims any warranties against and liability for infringement or any other claims involving patents, copyrights, or other intellectual property rights of third parties, by or arising from the use of Renesas Electronics products or technical information described in this document, including but not limited to, the product data, drawings, charts, programs, algorithms, and application examples.
3. No license, express, implied or otherwise, is granted hereby under any patents, copyrights or other intellectual property rights of Renesas Electronics or others.
4. You shall be responsible for determining what licenses are required from any third parties, and obtaining such licenses for the lawful import, export, manufacture, sales, utilization, distribution or other disposal of any products incorporating Renesas Electronics products, if required.
5. You shall not alter, modify, copy, or reverse engineer any Renesas Electronics product, whether in whole or in part. Renesas Electronics disclaims any and all liability for any losses or damages incurred by you or third parties arising from such alteration, modification, copying or reverse engineering.
6. Renesas Electronics products are classified according to the following two quality grades: "Standard" and "High Quality". The intended applications for each Renesas Electronics product depends on the product's quality grade, as indicated below.
  - "Standard": Computers; office equipment; communications equipment; test and measurement equipment; audio and visual equipment; home electronic appliances; machine tools; personal electronic equipment; industrial robots; etc.
  - "High Quality": Transportation equipment (automobiles, trains, ships, etc.); traffic control (traffic lights); large-scale communication equipment; key financial terminal systems; safety control equipment; etc.Unless expressly designated as a high reliability product or a product for harsh environments in a Renesas Electronics data sheet or other Renesas Electronics document, Renesas Electronics products are not intended or authorized for use in products or systems that may pose a direct threat to human life or bodily injury (artificial life support devices or systems; surgical implantations; etc.), or may cause serious property damage (space system; undersea repeaters; nuclear power control systems; aircraft control systems; key plant systems; military equipment; etc.). Renesas Electronics disclaims any and all liability for any damages or losses incurred by you or any third parties arising from the use of any Renesas Electronics product that is inconsistent with any Renesas Electronics data sheet, user's manual or other Renesas Electronics document.
7. No semiconductor product is absolutely secure. Notwithstanding any security measures or features that may be implemented in Renesas Electronics hardware or software products, Renesas Electronics shall have absolutely no liability arising out of any vulnerability or security breach, including but not limited to any unauthorized access to or use of a Renesas Electronics product or a system that uses a Renesas Electronics product. RENESAS ELECTRONICS DOES NOT WARRANT OR GUARANTEE THAT RENESAS ELECTRONICS PRODUCTS, OR ANY SYSTEMS CREATED USING RENESAS ELECTRONICS PRODUCTS WILL BE INVULNERABLE OR FREE FROM CORRUPTION, ATTACK, VIRUSES, INTERFERENCE, HACKING, DATA LOSS OR THEFT, OR OTHER SECURITY INTRUSION ("Vulnerability Issues"). RENESAS ELECTRONICS DISCLAIMS ANY AND ALL RESPONSIBILITY OR LIABILITY ARISING FROM OR RELATED TO ANY VULNERABILITY ISSUES. FURTHERMORE, TO THE EXTENT PERMITTED BY APPLICABLE LAW, RENESAS ELECTRONICS DISCLAIMS ANY AND ALL WARRANTIES, EXPRESS OR IMPLIED, WITH RESPECT TO THIS DOCUMENT AND ANY RELATED OR ACCOMPANYING SOFTWARE OR HARDWARE, INCLUDING BUT NOT LIMITED TO THE IMPLIED WARRANTIES OF MERCHANTABILITY, OR FITNESS FOR A PARTICULAR PURPOSE.
8. When using Renesas Electronics products, refer to the latest product information (data sheets, user's manuals, application notes, "General Notes for Handling and Using Semiconductor Devices" in the reliability handbook, etc.), and ensure that usage conditions are within the ranges specified by Renesas Electronics with respect to maximum ratings, operating power supply voltage range, heat dissipation characteristics, installation, etc. Renesas Electronics disclaims any and all liability for any malfunctions, failure or accident arising out of the use of Renesas Electronics products outside of such specified ranges.
9. Although Renesas Electronics endeavors to improve the quality and reliability of Renesas Electronics products, semiconductor products have specific characteristics, such as the occurrence of failure at a certain rate and malfunctions under certain use conditions. Unless designated as a high reliability product or a product for harsh environments in a Renesas Electronics data sheet or other Renesas Electronics document, Renesas Electronics products are not subject to radiation resistance design. You are responsible for implementing safety measures to guard against the possibility of bodily injury, injury or damage caused by fire, and/or danger to the public in the event of a failure or malfunction of Renesas Electronics products, such as safety design for hardware and software, including but not limited to redundancy, fire control and malfunction prevention, appropriate treatment for aging degradation or any other appropriate measures. Because the evaluation of microcomputer software alone is very difficult and impractical, you are responsible for evaluating the safety of the final products or systems manufactured by you.
10. Please contact a Renesas Electronics sales office for details as to environmental matters such as the environmental compatibility of each Renesas Electronics product. You are responsible for carefully and sufficiently investigating applicable laws and regulations that regulate the inclusion or use of controlled substances, including without limitation, the EU RoHS Directive, and using Renesas Electronics products in compliance with all these applicable laws and regulations. Renesas Electronics disclaims any and all liability for damages or losses occurring as a result of your noncompliance with applicable laws and regulations.
11. Renesas Electronics products and technologies shall not be used for or incorporated into any products or systems whose manufacture, use, or sale is prohibited under any applicable domestic or foreign laws or regulations. You shall comply with any applicable export control laws and regulations promulgated and administered by the governments of any countries asserting jurisdiction over the parties or transactions.
12. It is the responsibility of the buyer or distributor of Renesas Electronics products, or any other party who distributes, disposes of, or otherwise sells or transfers the product to a third party, to notify such third party in advance of the contents and conditions set forth in this document.
13. This document shall not be reprinted, reproduced or duplicated in any form, in whole or in part, without prior written consent of Renesas Electronics.
14. Please contact a Renesas Electronics sales office if you have any questions regarding the information contained in this document or Renesas Electronics products.

(Note1) "Renesas Electronics" as used in this document means Renesas Electronics Corporation and also includes its directly or indirectly controlled subsidiaries.

(Note2) "Renesas Electronics product(s)" means any product developed or manufactured by or for Renesas Electronics.

(Rev.5.0-1 October 2020)

## Corporate Headquarters

TOYOSU FORESIA, 3-2-24 Toyosu,  
Koto-ku, Tokyo 135-0061, Japan  
[www.renesas.com](http://www.renesas.com)

## Trademarks

Renesas and the Renesas logo are trademarks of Renesas Electronics Corporation. All trademarks and registered trademarks are the property of their respective owners.

## Contact information

For further information on a product, technology, the most up-to-date version of a document, or your nearest sales office, please visit:  
[www.renesas.com/contact/](http://www.renesas.com/contact/).