

Photocouplers / Optocouplers

Insulation Distances

Abstract

Our photocouplers use a double structure consisting of an inner resin with high optical transmittance between the light-emitting diode (LED) and the photo-diode, and an outer resin with high light shading effect on the outside.

As a result, both stable operation not influenced by external light and high sensitivity (small minimum operating input current) are achieved.

Contents

1. Overview	2
2. 16-pin DIP (Dual Inline Package)	4
3. 8-pin DIP (Dual Inline Package)	5
4. 4-pin DIP (Dual Inline Package)	6
4.1 Normal, Surface mount (L)	6
4.2 Long Clearance Distance (L1), Long Clearance Distance Surface Mount (L2)	7
5. 6-pin SDIP (Shrink Dual Inline Package)	8
6. 8-pin SDIP (Shrink Dual Inline Package)	9
7. 16-pin SSOP (Shrink Small Outline Package)	10
8. 12-pin SSOP (Shrink Small Outline Package)	11
9. 8-pin SSOP (Shrink Small Outline Package)	12
10. 5-pin LSSO5 (Long Creepage Shrink Small Outline Package)	13
11. 5-pin SOP (Small Outline Package)	14
12. 4-pin SOP (Small Outline Package)	15
13. 4-pin LSSOP (Long Creepage Shrink Small Outline Package)	16
14. 4-pin SSOP (Shrink Small Outline Package)	17
15. 4-pin Mini Flat-lead	18
16. Revision History	19

1. Overview

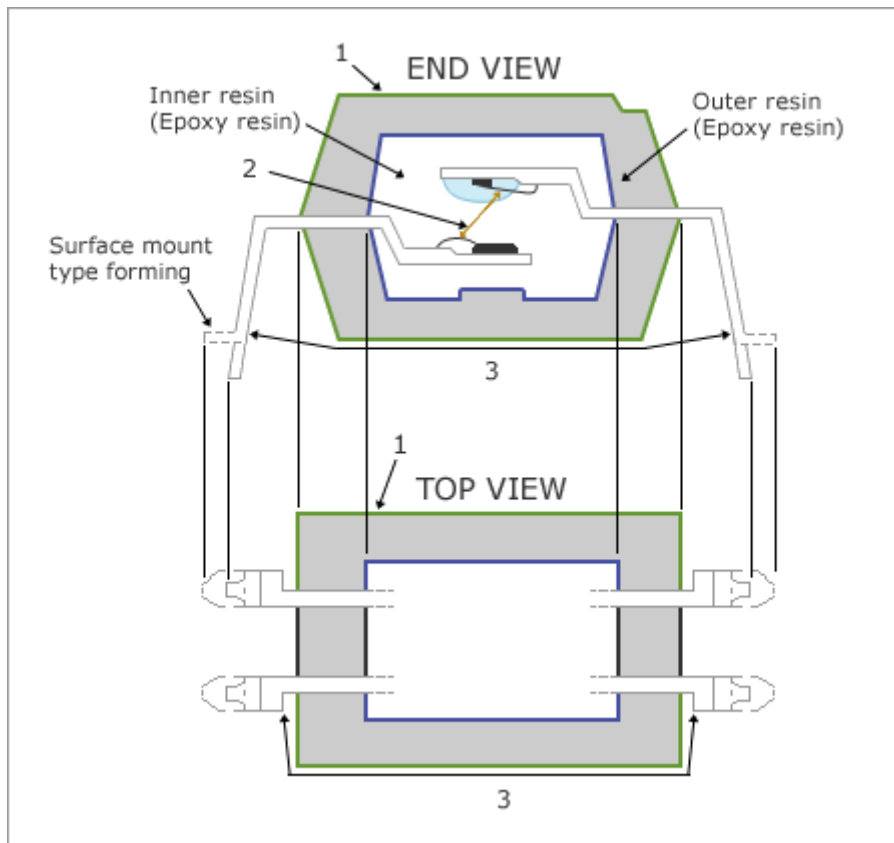

No. / Name	Description
1. Creepage Distance	Shortest distance between the light emitting side pin and the light receiving side pin, along the package surface (green line in the figure above).
2. Insulator Thickness	Shortest distance between the light emitting side and the light receiving side insulated with resin
3. Clearance (Air distance)	Space outside the resin that is the shortest distance between the light emitting side pin and the light receiving side pin. Depending on the pin shape, this distance may be the same as the outer creepage distance.

Insulation Distances Application Note

Package Name	Width of Molded Body between Pin Lines (mm)	Length (mm)	Height (mm)	Mass (g)
16-pin DIP	6.5	19.8	3.6	1.02
8-pin DIP	6.5	9.25	3.6	0.55
4-pin DIP	6.5	4.6	3.6	0.26
6-pin SDIP	6.8	4.58	3.7	0.35
8-pin SDIP	6.8	5.85	3.7	0.35
16-pin SSOP	4.4	10.3	2	0.2
12-pin SSOP	4.4	5.6	2.5	0.14
8-pin SSOP	3.95	5.21	3.27	0.14
5-pin LSSO5	7.5	2.5	2.1	0.075
5-pin SOP	4.4	4	2.1	0.08
4-pin SOP	4.4	4	2.1	0.08
4-pin LSSOP	7.5	2.5	2.1	0.075
4-pin SSOP	4.4	2.7	2	0.05
4-pin mini flat-lead	4.6	2.5	2.1	0.05

Caution: The values in the table differ slightly depending on the lead forming type.

2. 16-pin DIP (Dual Inline Package)

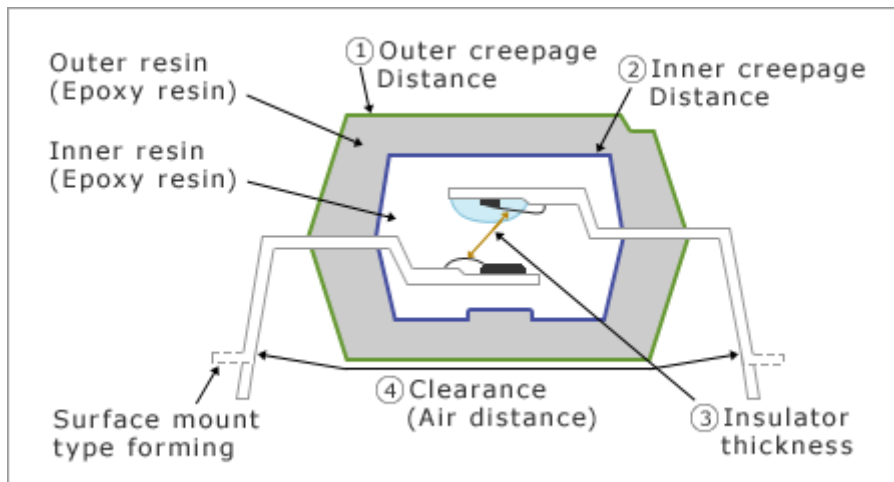

Product Name	Insulation Voltage (kVr.m.s.)	1 - Outer Creepage Distance (mm)	2 - Inner Creepage Distance (mm)	3 - Insulator Thickness (mm)	4 - Clearance (mm)
PS2501-4, PS2501L-4	5.0	7.0	3.5	0.3	7.0
PS2502-4, PS2502L-4	5.0	7.0	3.5	0.3	7.0
PS2505-4, PS2505L-4	5.0	7.0	3.5	0.3	7.0

3. 8-pin DIP (Dual Inline Package)

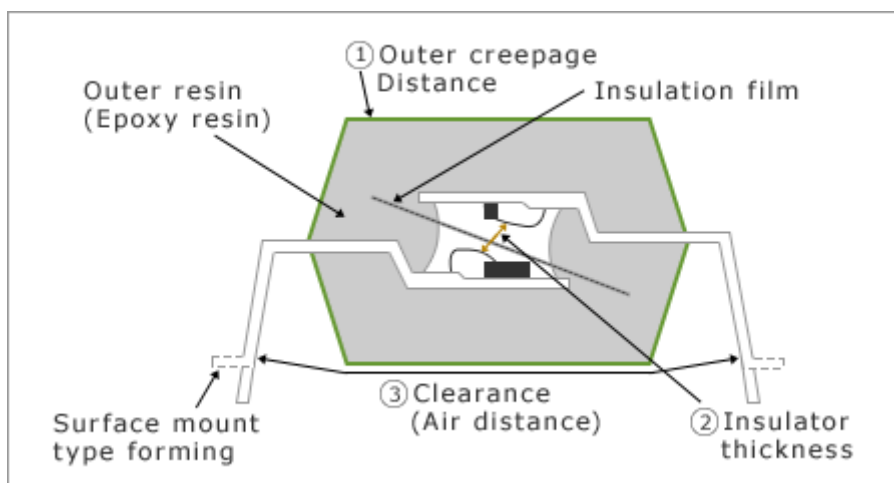

Product Name	Insulation Voltage (kVr.m.s.)	1 - Outer Creepage Distance (mm)	2 - Insulator Thickness (mm)	3 - Clearance (mm)
PS8501, PS8501L3	5.0	7.0	0.4	7.0
PS8501L1, PS8501L2	5.0	8.0	0.4	8.0
PS8502, PS8502L3	5.0	7.0	0.4	7.0
PS8502L1, PS8502L2	5.0	8.0	0.4	8.0
PS9505, PS9505L3	5.0	7.0	0.4	7.0
PS9505L1, PS9505L2	5.0	8.0	0.4	8.0
PS9513, PS9513L3	5.0	7.0	0.4	7.0
PS9513L1, PS9513L2	5.0	8.0	0.4	8.0
PS9587, PS9587L3	5.0	7.0	0.4	7.0
PS9587L1, PS9587L2	5.0	8.0	0.4	8.0

4. 4-pin DIP (Dual Inline Package)

4.1 Normal, Surface mount (L)

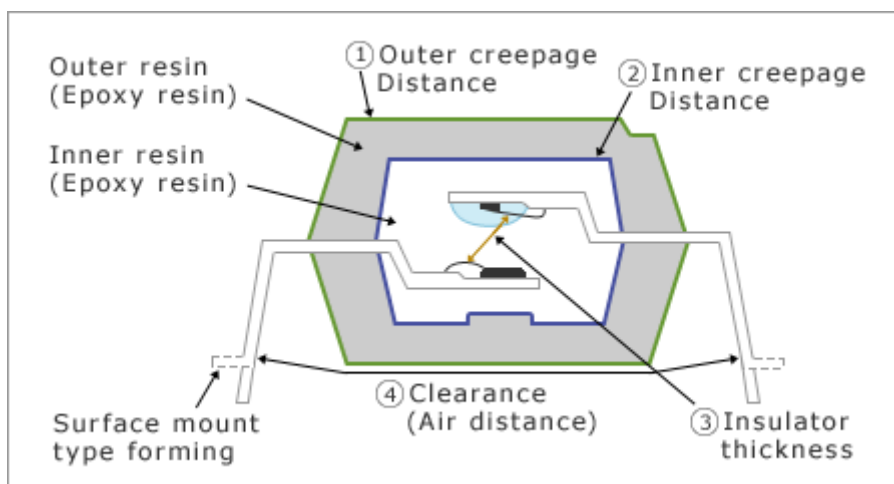

Product Name	Insulation Voltage (kVr.m.s.)	1 - Outer Creepage Distance (mm)	2 - Inner Creepage Distance (mm)	3 - Insulator Thickness (mm)	4 - Clearance (mm)
PS2501-1, PS2501L-1	5.0	7.0	3.5	0.3	7.0
PS2501A-1, PS2501AL-1	5.0	7.0	3.5	0.3	7.0
PS2502-1, PS2502L-1	5.0	7.0	3.5	0.3	7.0
PS2503-1, PS2503L-1	5.0	7.0	3.5	0.3	7.0
PS2505-1, PS2505L-1	5.0	7.0	3.5	0.3	7.0
PS2506-1, PS2506L-1	5.0	7.0	3.5	0.3	7.0
PS2513-1, PS2513L-1	5.0	7.0	3.5	0.3	7.0
PS2514-1, PS2514L-1	5.0	7.0	3.5	0.3	7.0
PS2533-1, PS2533L-1	5.0	7.0	3.5	0.3	7.0
PS2535-1, PS2535L-1	5.0	7.0	3.5	0.3	7.0
PS2561-1, PS2561L-1	5.0	7.0	3.5	0.3	7.0
PS2561A-1, PS2561AL-1	5.0	7.0	3.5	0.3	7.0
PS2561B-1, PS2561BL-1	5.0	7.0	3.5	0.3	7.0
PS2561D-1, PS2561DL-1	5.0	7.0	3.5	0.3	7.0

Insulation Distances Application Note

Product Name	Insulation Voltage (kVr.m.s.)	1 - Outer Creepage Distance (mm)	2 - Inner Creepage Distance (mm)	3 - Insulator Thickness (mm)	4 - Clearance (mm)
PS2561F-1, PS2561FL-1	5.0	7.0	3.5	0.3	7.0
PS2562-1, PS2562L-1	5.0	7.0	3.5	0.3	7.0
PS2565-1, PS2565L-1	5.0	7.0	3.5	0.3	7.0

4.2 Long Clearance Distance (L1), Long Clearance Distance Surface Mount (L2)

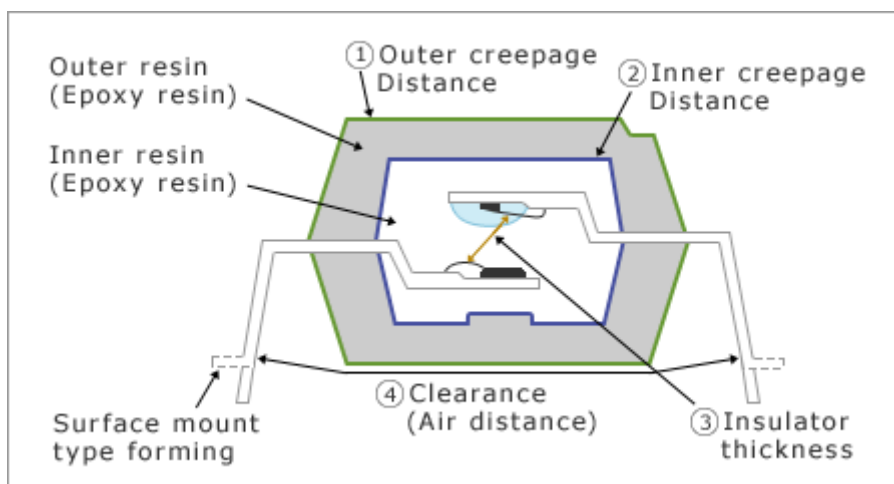

Product Name	Insulation Voltage (kVr.m.s.)	1 - Outer Creepage Distance (mm)	2 - Inner Creepage Distance (mm)	3 - Insulator Thickness (mm)	4 - Clearance (mm)
PS2561L1-1, PS2561L2-1	5.0	7.0	4.0	0.4	7.0
PS2561AL1-1, PS2561AL2-1	5.0	7.0	4.0	0.4	7.0
PS2561BL1-1, PS2561BL2-1	5.0	7.0	4.0	0.4	7.0
PS2561DL1-1, PS2561DL2-1	5.0	8.0	4.0	0.4	8.0
PS2562L1-1, PS2562L2-1	5.0	7.0	4.0	0.4	7.0
PS2565L1-1, PS2565L2-1	5.0	7.0	4.0	0.4	7.0
PS2581L1, PS2581L2	5.0	8.0	4.0	0.4	8.0
PS2581AL1, PS2581AL2	5.0	8.0	4.0	0.4	8.0

5. 6-pin SDIP (Shrink Dual Inline Package)

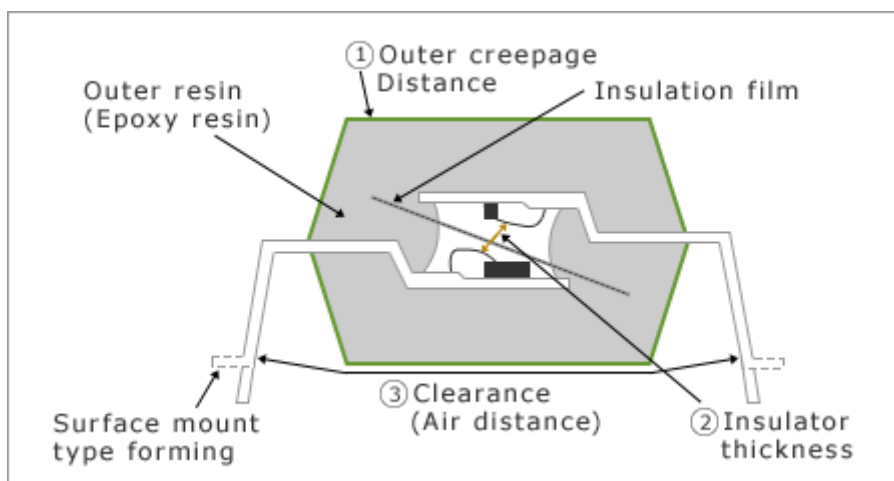

Product Name	Insulation Voltage (kVr.m.s.)	1 - Outer Creepage Distance (mm)	2 - Insulator Thickness (mm)	3 - Clearance (mm)
PS8302L	5.0	7.0	0.4	7.0
PS8302L2	5.0	8.0	0.4	8.0
PS9303L	5.0	7.0	0.4	7.0
PS9303L2	5.0	8.0	0.4	8.0
PS9306L	5.0	7.0	0.4	7.0
PS9306L2	5.0	8.0	0.4	8.0
PS9307L	5.0	7.0	0.4	7.0
PS9307L2	5.0	8.0	0.4	8.0
PS9308L	5.0	7.0	0.4	7.0
PS9308L2	5.0	8.0	0.4	8.0
PS9313L	5.0	7.0	0.4	7.0
PS9313L2	5.0	8.0	0.4	8.0
PS9317L	5.0	7.0	0.4	7.0
PS9317L2	5.0	8.0	0.4	8.0
PS9324L	5.0	7.0	0.4	7.0
PS9324L2	5.0	8.0	0.4	8.0
PS9331L	5.0	7.0	0.4	7.0
PS9331L2	5.0	8.0	0.4	8.0
PS9351L	5.0	7.0	0.4	7.0
PS9351L2	5.0	8.0	0.4	8.0

6. 8-pin SDIP (Shrink Dual Inline Package)

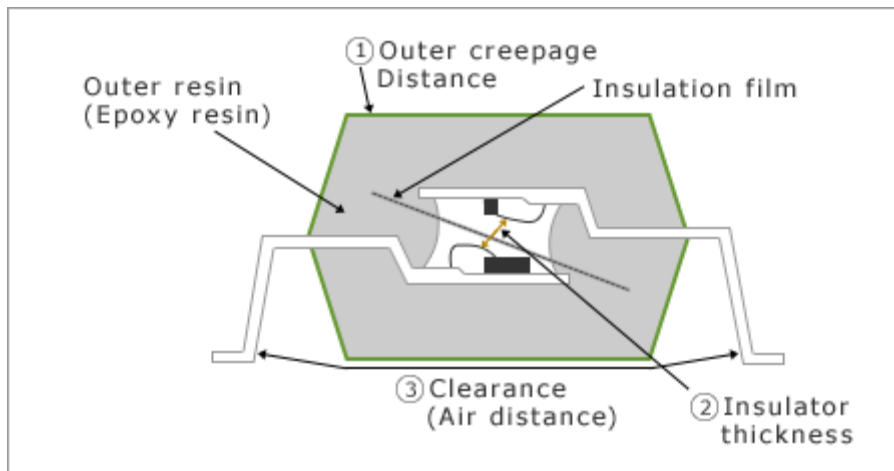

Product Name	Insulation Voltage (kVr.m.s.)	1 - Outer Creepage Distance (mm)	2 - Insulator Thickness (mm)	3 - Clearance (mm)
PS9305L	5.0	8.0	0.4	7.0
PS9305L2	5.0	8.0	0.4	8.0
PS9332L	5.0	7.0	0.4	7.0
PS9332L2	5.0	8.0	0.4	8.0

7. 16-pin SSOP (Shrink Small Outline Package)

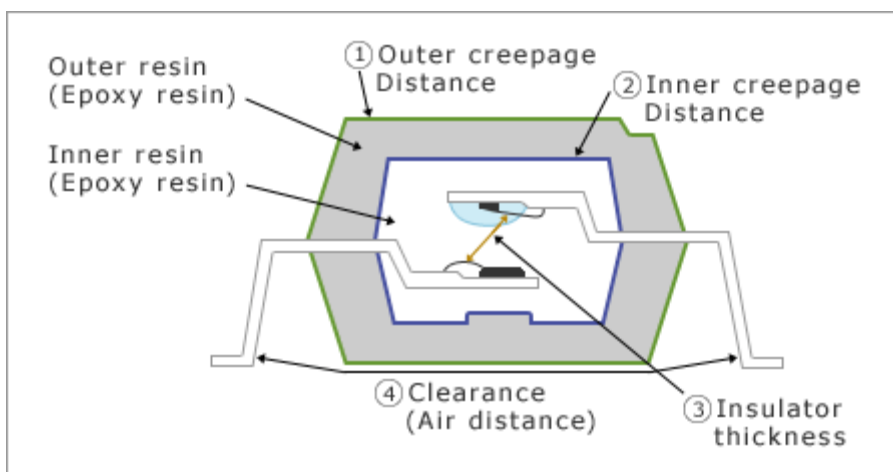

Product Name	Insulation Voltage (kVr.m.s.)	1 - Outer Creepage Distance (mm)	2 - Inner Creepage Distance (mm)	3 - Insulator Thickness (mm)	4 - Clearance (mm)
PS2801C-4	2.5	4.5	2.5	0.1	4.5
PS2802-4	2.5	4.5	2.5	0.1	4.5
PS2805C-4	2.5	4.5	2.5	0.1	4.5
PS2811-4	2.5	4.5	2.5	0.1	4.5
PS2815-4	2.5	4.5	2.5	0.1	4.5
PS2833-4	2.5	4.5	2.5	0.1	4.5

8. 12-pin SSOP (Shrink Small Outline Package)

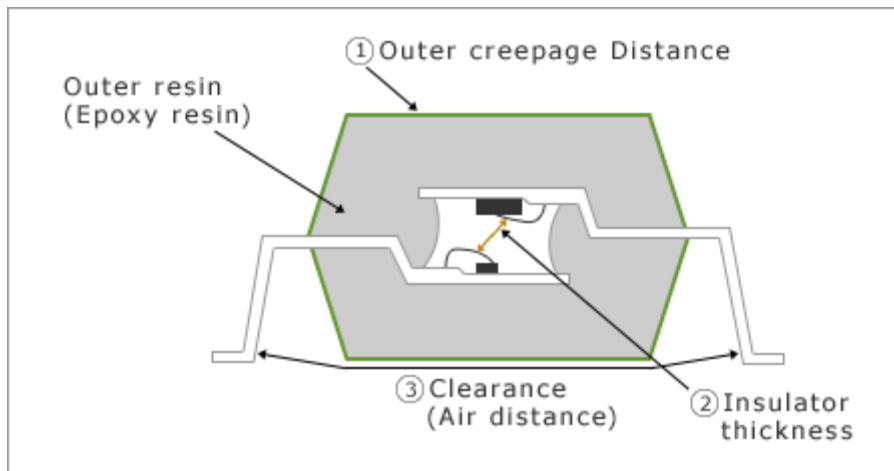

Product Name	Insulation Voltage (kVr.m.s.)	1 - Outer Creepage Distance (mm)	2 - Insulator Thickness (mm)	3 - Clearance (mm)
PS2841-4A	1.5	4.0	0.4	4.0
PS2841-4B	1.5	4.0	0.4	4.0
PS2845-4A	1.5	4.0	0.4	4.0

9. 8-pin SSOP (Shrink Small Outline Package)

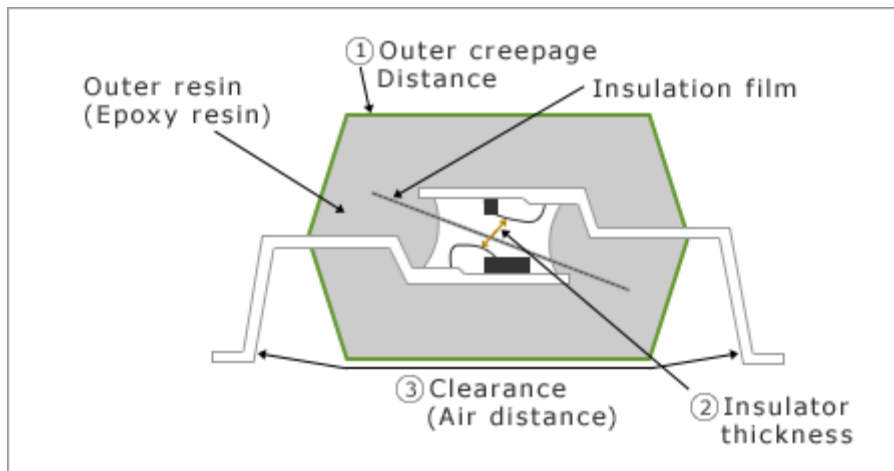

Product Name	Insulation Voltage (kVr.m.s.)	1 - Outer Creepage Distance (mm)	2 - Insulator Thickness (mm)	3 - Clearance (mm)
PS8802-1, PS8802-2	2.5	4.0	0.2	4.0
PS8821-1, PS8821-2	2.5	4.0	0.2	4.0
PS9817A-1, PS9817A-2	2.5	4.0	0.2	4.0
PS9821-1, PS9821-2	2.5	4.0	0.2	4.0
PS9822-1, PS9822-2	2.5	4.0	0.2	4.0
PS9851-1, PS9851-2	2.5	4.0	0.2	4.0

10. 5-pin LSSO5 (Long Creepage Shrink Small Outline Package)

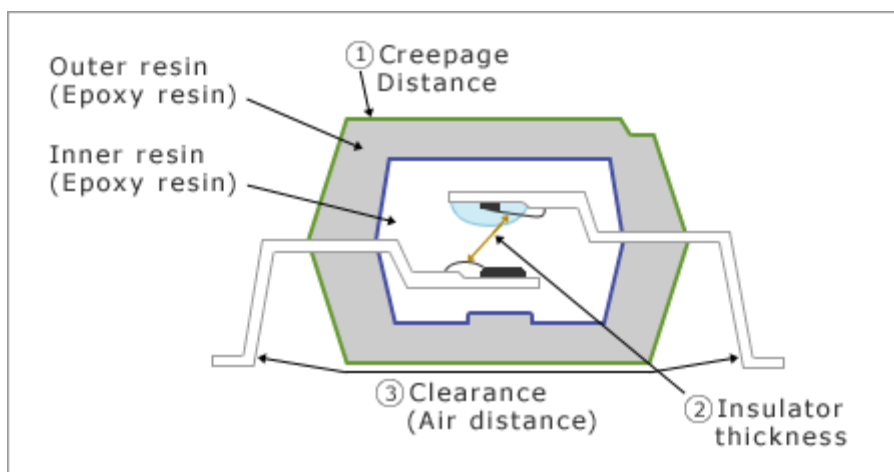

Product Name	Insulation Voltage (kVr.m.s.)	1 - Outer Creepage Distance (mm)	2 - Insulator Thickness (mm)	3 - Clearance (mm)
RV1S9213A	5.0	8.2	0.15	8.2
RV1S9260A	5.0	8.2	0.15	8.2

11. 5-pin SOP (Small Outline Package)

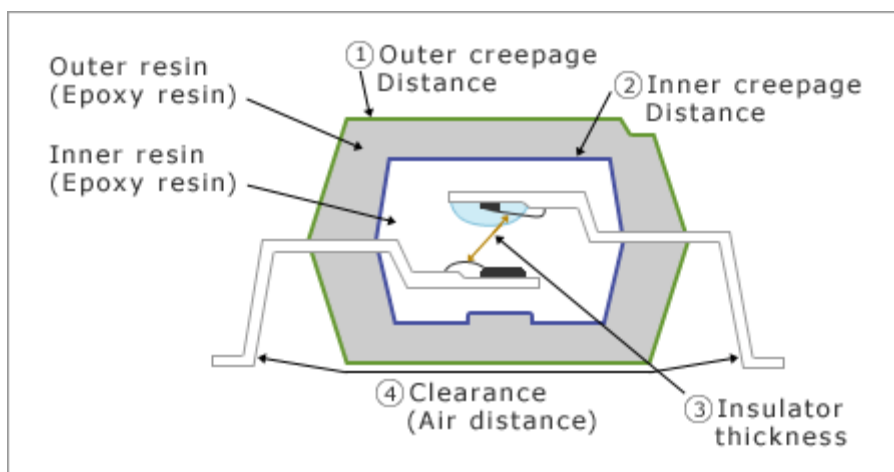

Product Name	Insulation Voltage (kVr.m.s.)	1 - Outer Creepage Distance (mm)	2 - Inner Creepage Distance (mm)	3 - Insulator Thickness (mm)	4 - Clearance (mm)
PS8101	3.75	4.2	2.5	0.2	4.2
PS9113	3.75	4.2	2.5	0.2	4.2
PS9117A	3.75	4.2	2.5	0.2	4.2
PS9121	3.75	4.2	2.5	0.2	4.2
PS9122	3.75	4.2	2.5	0.2	4.2
PS9123	3.75	4.2	2.5	0.2	4.2
PS9124	3.75	4.2	2.5	0.2	4.2
PS9151	3.75	4.2	2.5	0.2	4.2

12. 4-pin SOP (Small Outline Package)

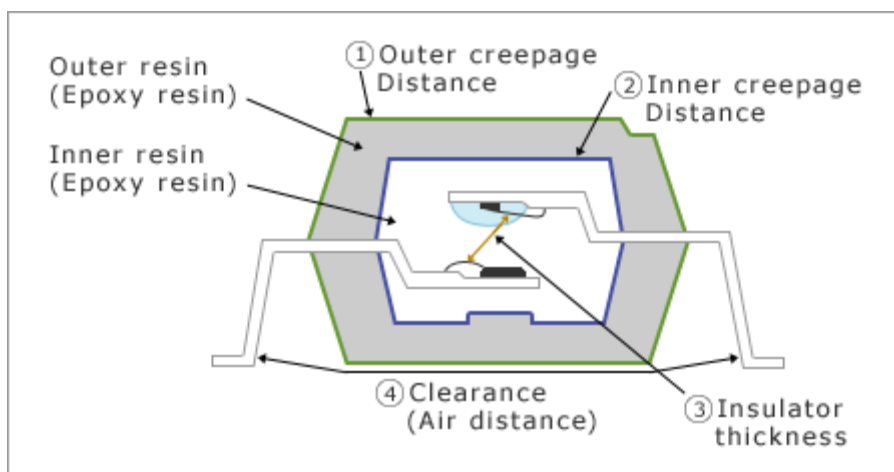

Product Name	Insulation Voltage (kVr.m.s.)	1 - Outer Creepage Distance (mm)	2 - Inner Creepage Distance (mm)	3 - Insulator Thickness (mm)	4 - Clearance (mm)
PS2381-1	5.0	8.0	-	0.4	8.0
PS2701A-1	3.75	5.0	2.5	0.3	5.0
PS2702-1	3.75	5.0	2.5	0.3	5.0
PS2703-1	3.75	5.0	2.5	0.3	5.0
PS2705A-1	3.75	5.0	2.5	0.3	5.0
PS2711-1	3.75	5.0	2.5	0.3	5.0
PS2715-1	3.75	5.0	2.5	0.3	5.0
PS2733-1	2.5	5.0	2.5	0.3	5.0
PS2761B-1	3.75	5.0	-	0.4	5.0

13. 4-pin LSSOP (Long Creepage Shrink Small Outline Package)

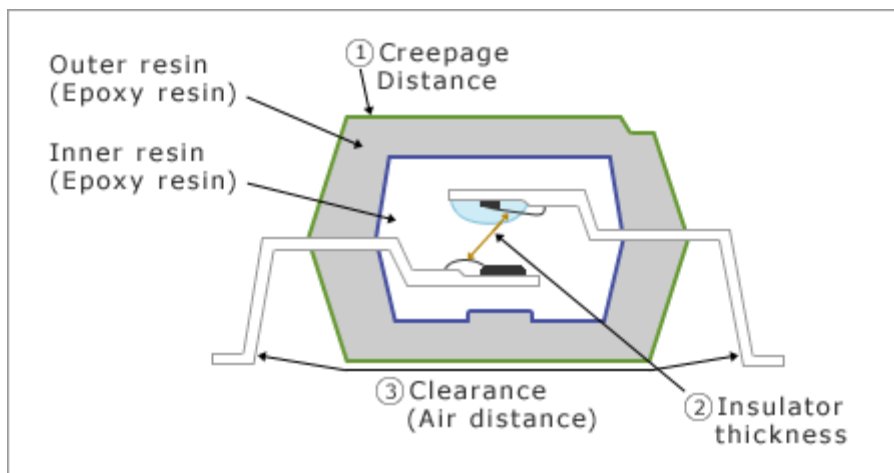

Product Name	Insulation Voltage (kVr.m.s.)	1 - Outer Creepage Distance (mm)	2 - Insulator Thickness (mm)	3 - Clearance (mm)
RV1S2211A	5.0	8.2	0.15	8.2
RV1S2281A	5.0	8.2	0.15	8.2
RV1S2285A	5.0	8.2	0.15	8.2

14. 4-pin SSOP (Shrink Small Outline Package)

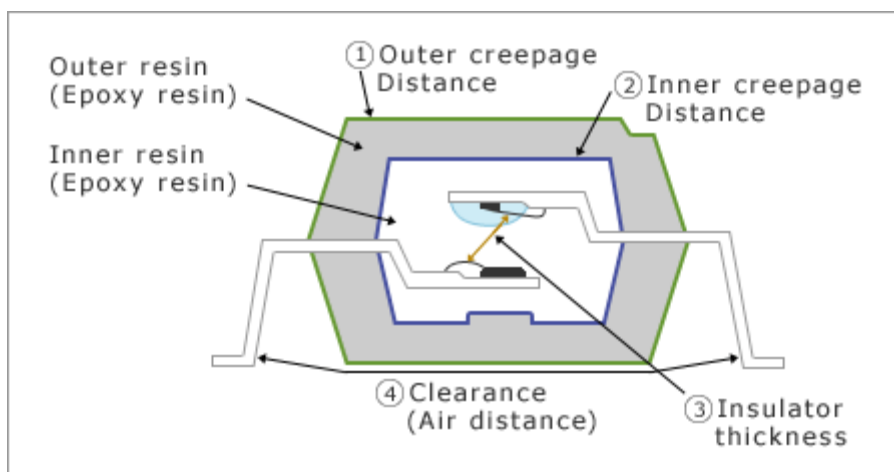

Product Name	Insulation Voltage (kVr.m.s.)	1 - Outer Creepage Distance (mm)	2 - Inner Creepage Distance (mm)	3 - Insulator Thickness (mm)	4 - Clearance (mm)
PS2801C-1	2.5	4.5	2.5	0.1	4.5
PS2802-1	2.5	4.5	2.5	0.1	4.5
PS2805C-1	2.5	4.5	2.5	0.1	4.5
PS2811-1	2.5	4.5	2.5	0.1	4.5
PS2815-1	2.5	4.5	2.5	0.1	4.5
PS2833-1	2.5	4.5	2.5	0.1	4.5
PS2861B-1	3.75	5.0	-	0.4	5.0

15. 4-pin Mini Flat-lead

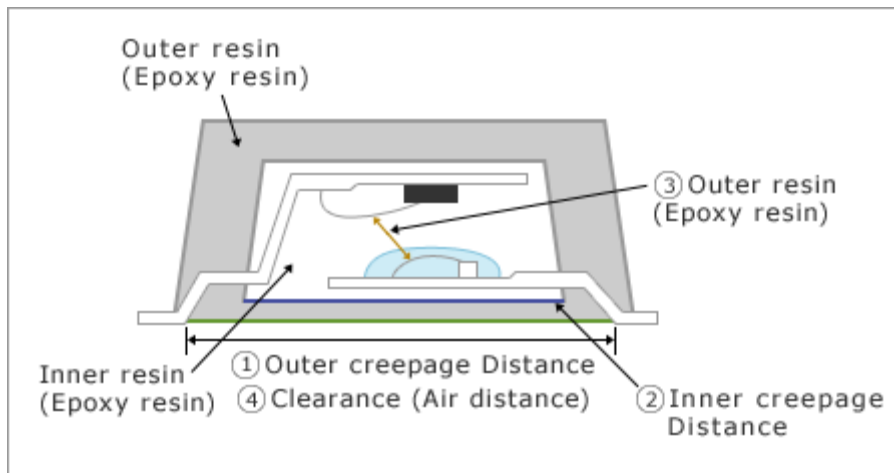

Product Name	Insulation Voltage (kVr.m.s.)	1 - Outer Creepage Distance (mm)	2 - Inner Creepage Distance (mm)	3 - Insulator Thickness (mm)	4 - Clearance (mm)
PS2911-1	2.5	4.0	2.5	0.4	4.0
PS2913-1	2.5	4.0	2.5	0.4	4.0
PS2915-1	2.5	4.0	2.5	0.4	4.0
PS2933-1	2.5	4.0	2.5	0.4	4.0

16. Revision History

Revision	Date	Description
1.0	Oct.20.20	Initial release.

IMPORTANT NOTICE AND DISCLAIMER

RENESAS ELECTRONICS CORPORATION AND ITS SUBSIDIARIES (“RENESAS”) PROVIDES TECHNICAL SPECIFICATIONS AND RELIABILITY DATA (INCLUDING DATASHEETS), DESIGN RESOURCES (INCLUDING REFERENCE DESIGNS), APPLICATION OR OTHER DESIGN ADVICE, WEB TOOLS, SAFETY INFORMATION, AND OTHER RESOURCES “AS IS” AND WITH ALL FAULTS, AND DISCLAIMS ALL WARRANTIES, EXPRESS OR IMPLIED, INCLUDING, WITHOUT LIMITATION, ANY IMPLIED WARRANTIES OF MERCHANTABILITY, FITNESS FOR A PARTICULAR PURPOSE, OR NON-INFRINGEMENT OF THIRD PARTY INTELLECTUAL PROPERTY RIGHTS.

These resources are intended for developers skilled in the art designing with Renesas products. You are solely responsible for (1) selecting the appropriate products for your application, (2) designing, validating, and testing your application, and (3) ensuring your application meets applicable standards, and any other safety, security, or other requirements. These resources are subject to change without notice. Renesas grants you permission to use these resources only for development of an application that uses Renesas products. Other reproduction or use of these resources is strictly prohibited. No license is granted to any other Renesas intellectual property or to any third party intellectual property. Renesas disclaims responsibility for, and you will fully indemnify Renesas and its representatives against, any claims, damages, costs, losses, or liabilities arising out of your use of these resources. Renesas' products are provided only subject to Renesas' Terms and Conditions of Sale or other applicable terms agreed to in writing. No use of any Renesas resources expands or otherwise alters any applicable warranties or warranty disclaimers for these products.

(Rev.1.0 Mar 2020)

Corporate Headquarters

TOYOSU FORESIA, 3-2-24 Toyosu,
Koto-ku, Tokyo 135-0061, Japan
www.renesas.com

Contact Information

For further information on a product, technology, the most up-to-date version of a document, or your nearest sales office, please visit:
www.renesas.com/contact/

Trademarks

Renesas and the Renesas logo are trademarks of Renesas Electronics Corporation. All trademarks and registered trademarks are the property of their respective owners.