

Introduction

Most audio equipment testing is done on a stimulus-response basis. A signal of known characteristics is fed to the input of the Device Under Test (DUT) and the output of the DUT is measured. The performance of the DUT is determined by degradation of the output signal from the known input signal. Often, sets of measurements are made as the stimulus is swept or stepped across the audio frequency spectrum or across an amplitude range, and the desired performance information is determined by the relationship between the corresponding set of output measurements.

The most common stimulus for audio testing is a sine wave. The sine wave is unique since it is the only signal to have all its energy concentrated at a single point in the frequency spectrum, referred to as the fundamental frequency. It is therefore relatively simple to analyze test results from single sine wave testing. Multiple sine waves (usually two) are used for intermodulation distortion testing, and large numbers of multiple sine waves are used for some new testing

techniques. White noise, pink noise, square waves, and impulses may also be used as stimulus for certain types of audio testing. It is also possible to make certain measurements using program material such as music or voice as stimulus.

All three of the Intersil XDCPs used in this noise report were subjected to the testing criteria outlined in the above two paragraphs.

Table of Contents

Signal to Noise Ratio	2
Total Harmonic Distortion- THD+N,& Dual Tone Tests	4
Frequency Response	8
Multi-Channel Crosstalk & Level Matching	10
Measurement Results Summary	11
Additional Test Results	12
Appendix	14

Test Setup Using the Audio Precision System 2

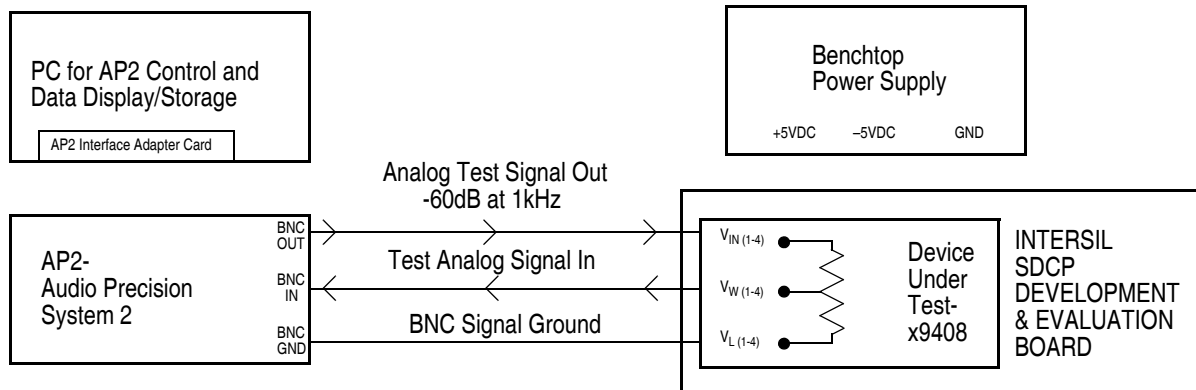

FIGURE 1. AUDIO MEASUREMENT TEST SETUP

Signal to Noise Ratio (SNR)

Signal to Noise Ratio (SNR) is the ratio of the normal operating level of the device compared with the device's noise floor. SNR can be thought of as the effective dynamic signal range of most types of analog audio devices.

The Signal to Noise Ratios (SNR) of the X9408, X9241A, X9C102 parts are all exceptional. All three parts exceeded 119dB SNR in the audio frequency spectrum (20Hz to 20kHz). (See graphs for all three parts and all measurements at the end of this document). The higher the SNR values the quieter the system will be, consequently, low-level detail will become audible. Dropping the noise floor by 10dB on the low end has the same effect as if the level control were turned up by the same amount. The SNR plots are found on the following graphs.

Applications for these parts include filters, analog signal processing, linear level control, and in any application where audio frequency analog signals are present and signal integrity and low noise is important.

SNR is determined by injecting a 0dB, 1kHz sine wave (generated by the AP2*) into the input of the Device Under Test (DUT). The signal is processed by the DUT and it's output signal is then fed back into the analyzer section of the AP2. The AP2 is then adjusted to set up a 0dB reference for this signal. The output of the AP2 is enabled again but this time the 1kHz sine wave is removed. The output of the DUT is analyzed by the AP2 again and the ratio between this baseline noise level with no input signal and the original 0dB level set in the first measurement is the SNR.

*AP2-Audio Precision System 2

A 1kHz Sine Wave at -60 dB Signal Plotted From 20Hz to 20kHz

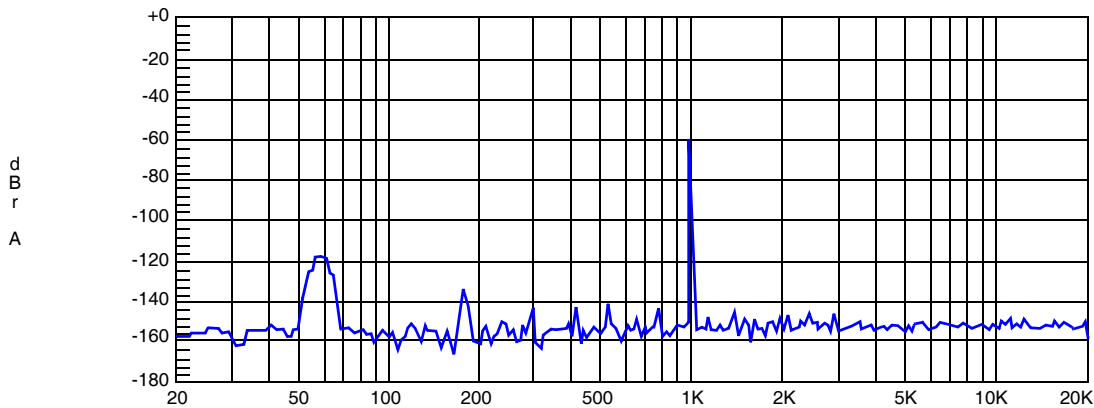

Color	Line Style	Thick	Data	Axis
Blue	Solid	1	Fft. Ch. 1 Ampl	Left

SNR Reads 116 dB on the AP2 Meter
XDCP9408 set at step 63 on chan 1
Global Specialties power supply #1310

Audio Precision Intersil X9408 SNR CHAN 0

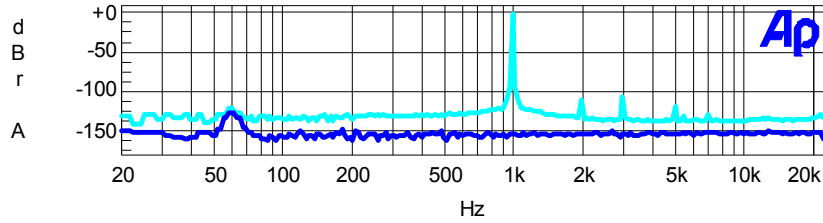

Color	Line Style	Thick	Data	Axis
Cyan	Solid	3	Fft.Ch.1 Ampl	Left
Blue	Solid	3	Fft.Ch.1 Ampl	Left

X9408w(10K ohms) SNR=120dB on Chan 0
1kHz@0dB Set Ref (from 1.4vp@0dB)
Step 63(Full On)

AUDIO PRECISION INTERSIL X9241A SNR CHANNEL 0

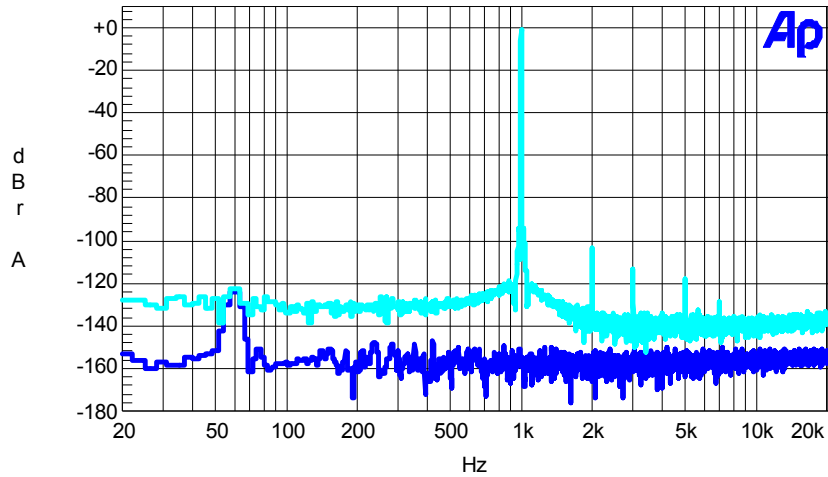

Color	Line Style	Thick	Data	Axis
Blue	Solid	3	Fft.Ch.1 Ampl	Left
Cyan	Solid	3	Fft.Ch.1 Ampl	Left

X9241y(2k ohms) SNR=119 dB on Chan 0
1kHz@0dB Set Ref (from 1.4vp@0dB)
Step 63(Full On)
MBPWR

AUDIO PRECISION INTERSIL X9C102 SNR

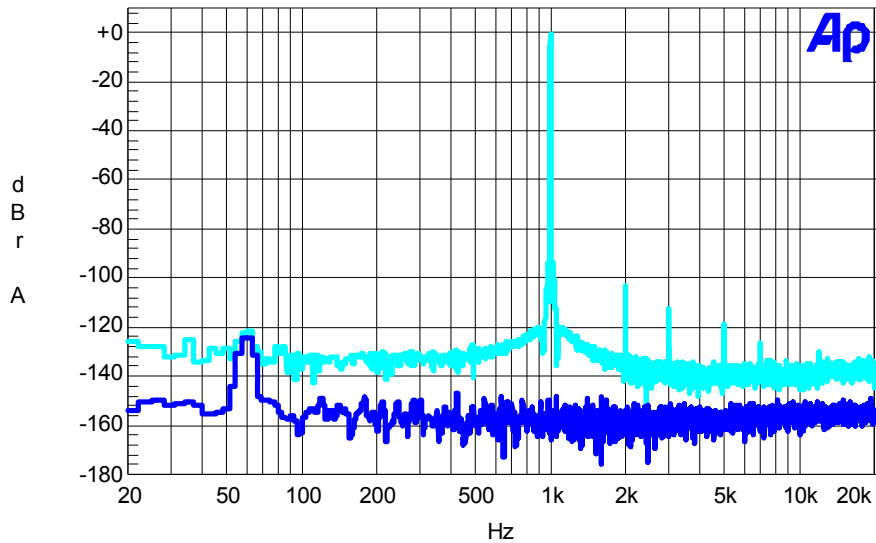

Color	Line Style	Thick	Data	Axis
Cyan	Solid	3	Fft.Ch.1 Ampl	Left
Blue	Solid	3	Fft.Ch.1 Ampl	Left

X9C102(1K ohms) SNR= 119dB 1kHz@0dB Set Ref (from 1.4vp@0dB) Step 99(Full On) MBPWR
--

Total Harmonic Distortion- THD+N, & Dual Tone Tests

The THD+N (Total Harmonic Distortion + Noise) level for all three parts is below -100dB which is exceptional for this class of parts. (See graphs for all three parts and all measurements at the end of this document). The dual tone type of tests are less common than the THD+N tests but are valuable in revealing problems with intermodulation distortion. In the parts that were measured with two lone tests at various frequencies generated no harmonics greater that -105dB.

In particular these two specifications define a parts audio frequency performance quality and assure a circuit designer that all three will work well as analog signal attenuators without adding extra harmonics. The results of these tests clearly show that all three of the Intersil parts exhibit excellent low level harmonic tendencies. Applications for these parts include filters, analog signal processing, linear level control, and in any application where audio frequency analog signals are present and need to be easily controlled and where signal integrity is important.

Total Harmonic Distortion + Noise (THD+N): Measured by attenuating the fundamental signal (1kHz @ 0dB) with a

narrow-band notch filter, then measuring the remaining signals which consist of harmonics of various orders, wide-band noise, and possibly interfering signals. THD causes audio signals to become smeared and less clear/focused. It can also raise baseline noise levels which masks out low level audio information. Creating extra signals and adding them back into the final output is always a BAD Thing.

Two Tone Harmonic Test: Where two 0dB signals at two different frequencies are fed into the DUT and the output is then measured by the AP2 across the entire audio frequency range (from 20Hz to 20kHz). Any harmonics (extra signals at even or odd multiples of the original two signals and multiples of their differences as well) created from the injection of these two signals into the DUT are displayed on a log frequency vs. amplitude graph. This test is useful in revealing any higher audio frequency anomalies which can be created by bad layout, non-linear responses, stray capacitance, and other circuit abnormalities. The audibility of this type of distortion is another form of THD. Plots of THD+N arc are found on this and the following 3 pages.

AUDIO PRECISION INTERSIL X9408 THD+N CHAN 0

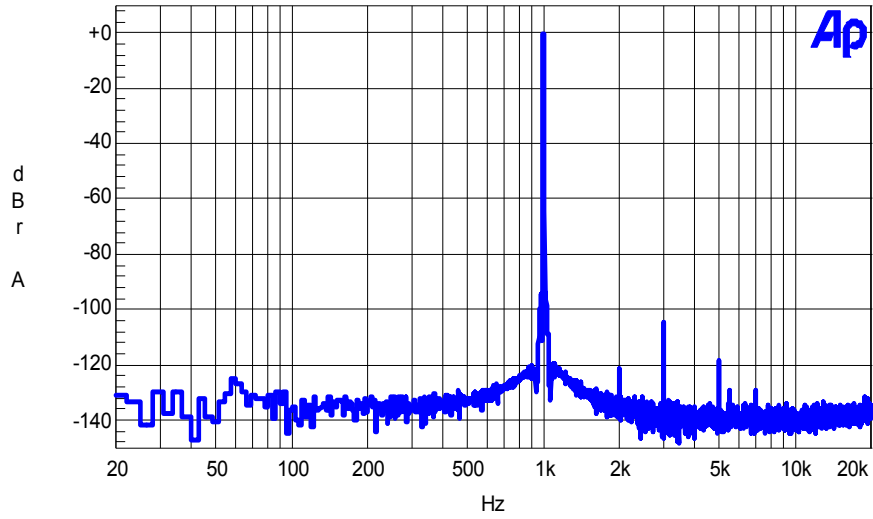

Color	Line Style	Thick	Data	Axis
Blue	Solid	3	Fft.Ch.1 Ampl	Left

X9408w(10K ohms) CHAN 0
THD+N = 106dB
1kHz@ 1.4vp-0dB
Step 63(last step) - AP2 Z @ 100K
MBPWR

AUDIO PRECISION INTERSIL X9241A THD+N CHAN 0

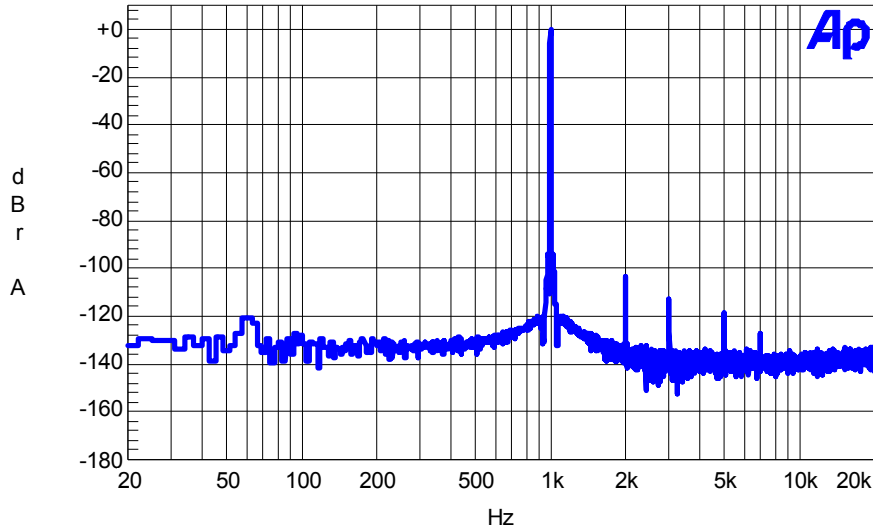

Color	Line Style	Thick	Data	Axis
Blue	Solid	3	Fft.Ch.1 Ampl	Left

X9241y(2K ohms) THD+N @ 1kHz @ 0dB=101dB
Channel 0 Set @ Step 63
AP2 100k Input Z, 5000 pts.
MBPWR

AUDIO PRECISION INTERSIL X9C102 THD+N

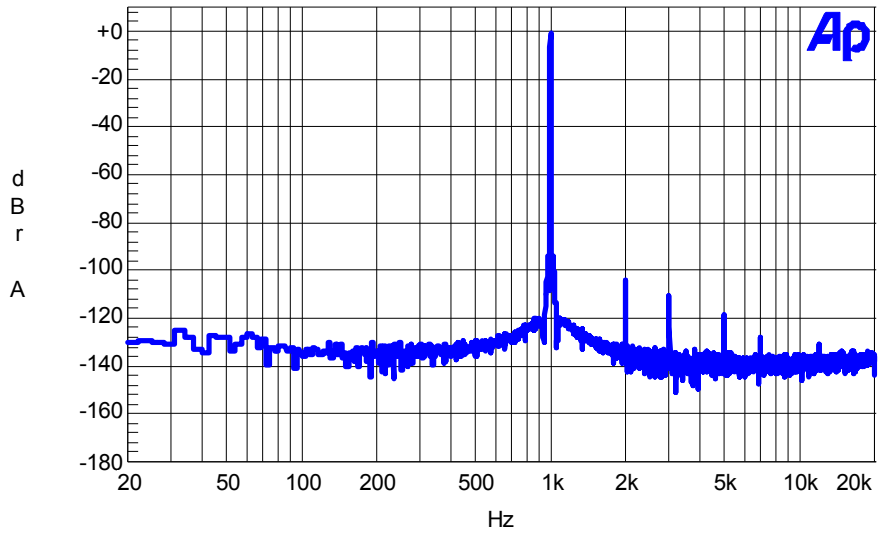

Color	Line Style	Thick	Data	Axis
Blue	Solid	3	Ft.Ch.1 Ampl	Left

X9C102(1K ohms) THD+N = -102dB
1kHz@0dB (from 1.4vp@0dB)
Step 99
MBPwr

AUDIO PRECISION INTERSIL X9408 DUAL TONE IMD TEST
18-19kHz CHAN 0

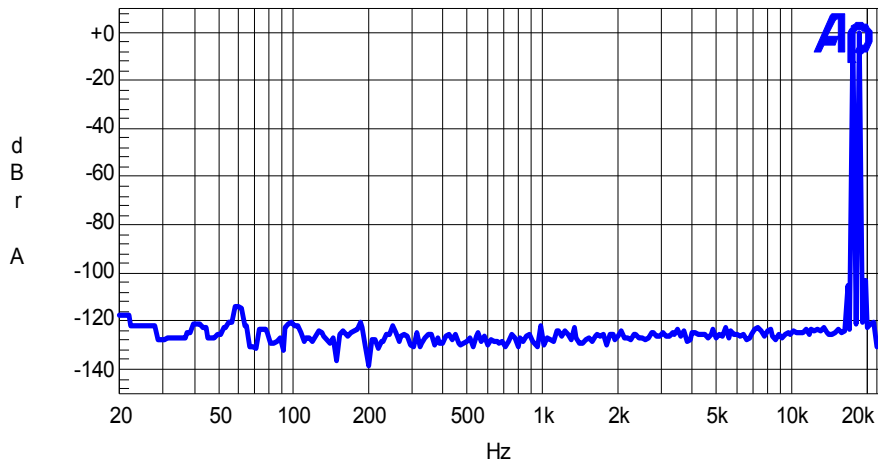

Color	Line Style	Thick	Data	Axis
Blue	Solid	3	Ft.Ch.1 Ampl	Left

X9408w(10K ohms) DUAL TONE TEST
CHAN 0
18.19kHz@0dB (from 1.4vp@0dB)
AP2 Input Z = 100k ohms
Step 63

AUDIO PRECISION INTERSIL X9241A DUAL TONE IMD TEST CHAN 0

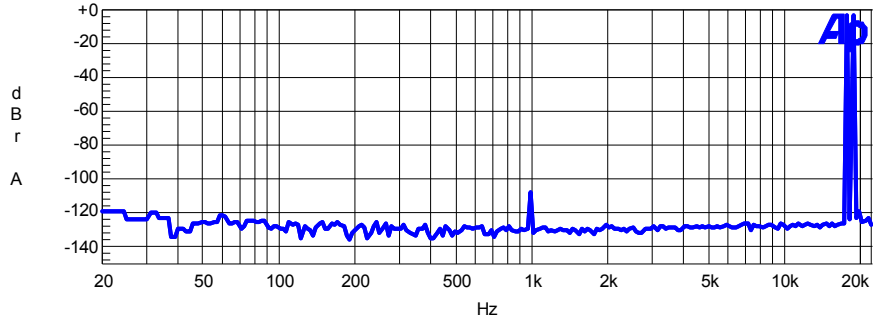

Color	Line Style	Thick	Data	Axis
Blue	Solid	3	Fft.Ch.1 Ampl	Left
Blue	Solid	3	Fft.Ch.1 Ampl	Left

X9241y(2K ohms) Two Tone Test
18_19kHz @ 0dB
channel 0, Step 63
MBPWR

AUDIO PRECISION INTERSIL X9C102 DUAL TONE IMD TEST

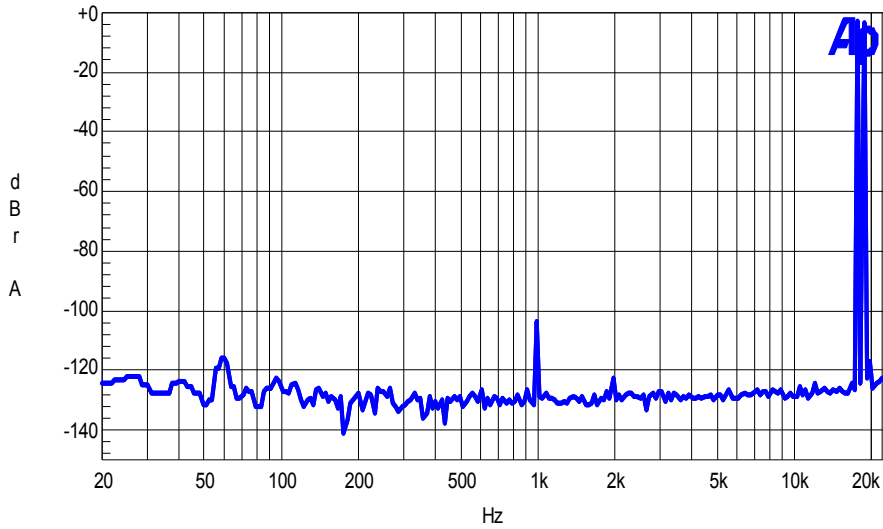

Color	Line Style	Thick	Data	Axis
Blue	Solid	3	Fft.Ch.1 Ampl	Left
Blue	Solid	3	Fft.Ch.1 Ampl	Left

X9C102(1K ohms) Two Tone Test
18_19kHz @ 0dB
Step 99
MBPWR

FREQUENCY RESPONSE

The upper frequency response limit of an analog system is usually determined by the point at which the input signal is reduced by the DUT (the circuit or part being tested) on it's output by a factor of -3dB . This standard of -3dB down corresponds to $1/2$ power or 0.707 times the voltage of the input signal. All the Intersil parts tested (using the Audio Precision System 2) were flat to 200kHz , which is the upper measurement frequency limit of the AP2 (10 times the

bandwidth of a standard 20kHz audio signal). The AP2 plots of the frequency response, of the three parts being tested, are found in the following 2 pages.

These three parts therefore have no frequency based limitations in the audio frequency range which make them suitable for any application that requires signal level attenuation such as low frequency square wave generators, data loggers, vibration analyzers, noise cancellation equipment, environmental controls, etc.

AUDIO PRECISION INTERSIL X9408 CHAN 0 FREQUENCY RESPONSE

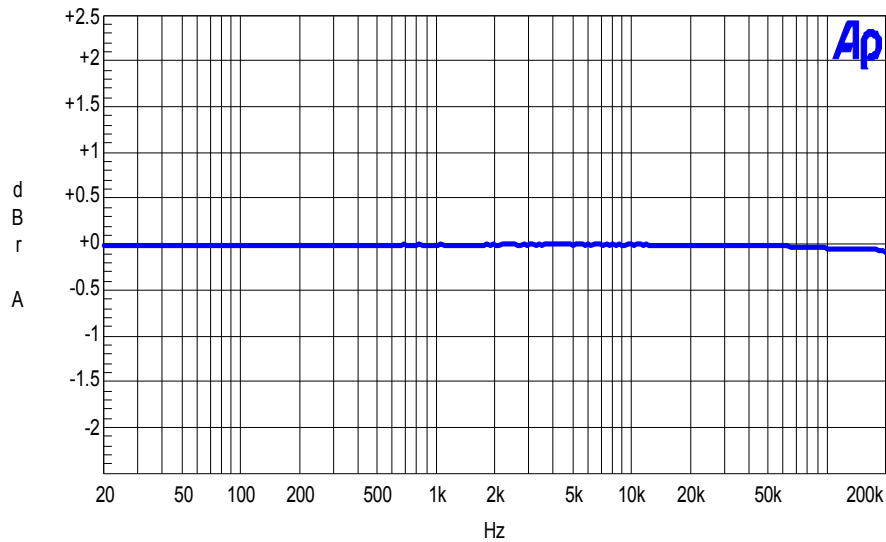

Color	Line Style	Thick	Data	Axis
Blue	Solid	3	Anlr.Level A	Left

X9408W(10K ohm) Frequency Response
 1.4vp 20Hz to 200 kHz on chan 0
 AP2 Input Z = 100k ohms
 MBPWR

AUDIO PRECISION INTERSIL X9241A CHAN 0 FREQUENCY RESPONSE

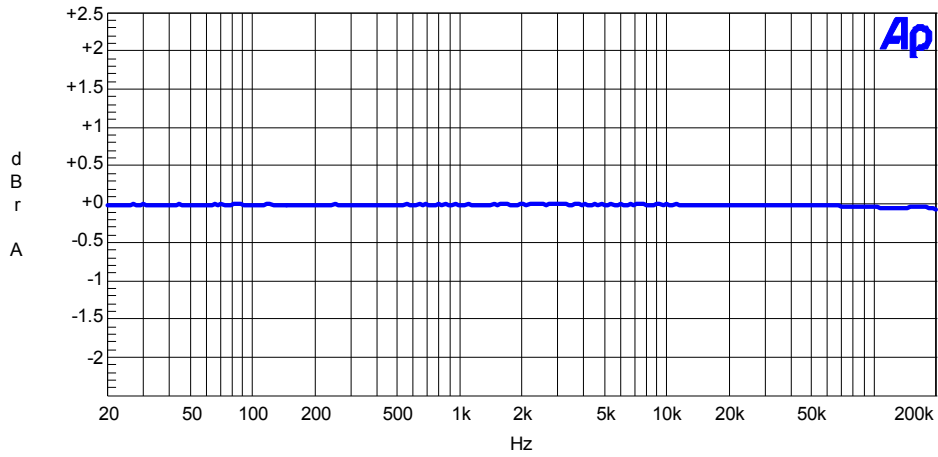

Color	Line Style	Thick	Data	Axis
Blue	Solid	3	Anlr.Level A	Left

X241y(2K ohms) Frequency Response
1.4vp 20Hz to 200 kHz on chan 0
AP2 Input Z = 100k ohms
MBPWR

AUDIO PRECISION INTERSIL X9C102 FREQUENCY RESPONSE

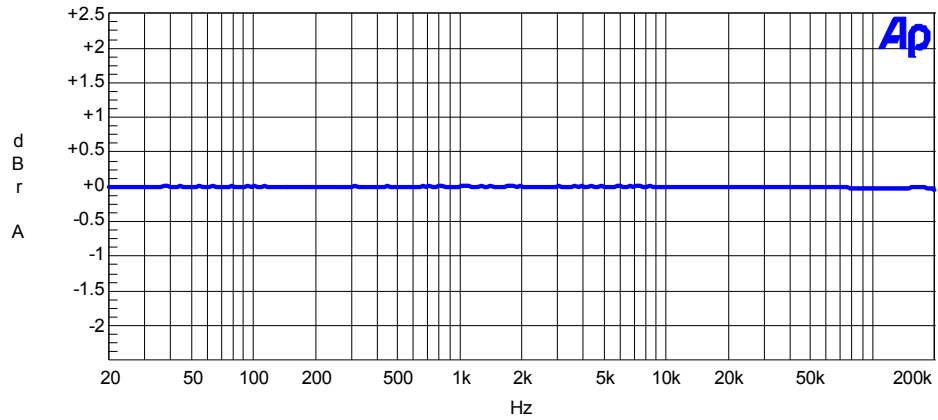

Color	Line Style	Thick	Data	Axis
Blue	Solid	3	Anlr.Level A	Left

X9C102(1K ohms) FREQUENCY RESPONSE
0 dB -- 1.4VP 20Hz TO 200kHz
STEP 99
MBPWR

Multi-Channel Crosstalk & Level Matching

On multi-channel parts like the X9241A and X9408 any interaction between channels where the signal on one channel leaks into the other is undesirable and referred to as crosstalk. To measure crosstalk a 0dB 1kHz signal is inserted into one channel and the other adjacent channel/channels are left floating with no signal present. The floating channels are then measured for any signal content that leaked over from the channel being driven with a signal. The level of the signals measured on the floating channels referenced to the 0dB, 1kHz signal channel is the "Separation" specification number expressed in negative dB. The more negative the number the better the circuit.

Both of the Intersil parts tested measured very well for crosstalk. The crosstalk numbers expressed in negative dB were over minus -116dB on channels that were at opposite ends of the chip and over -85dB on directly adjacent channels. In audio applications any noise or separation number over -120dB is considered excellent. Every 6dB equals 1 bit in the

digital representation of an analog audio signal so a number of -120dB corresponds to a 20 bit resolution which is present limit of high-end audio signals.

Where as a high negative number for crosstalk is a very good thing the opposite is true for level matching between channels on multi-channel parts. In this test the same test signal is fed into all the channels of the OUT at the same time. Then each of the individual channel output signals are measured to insure the output signal level of all of the channels match to within a certain dB level (usually 0.5 to 0.05dB in consumer audio equipment). Both of the multi-channel Intersil parts (X9408 & X9241A) were exceptional for this measurement.

The X9408 measured slightly better than the X9241A but the difference was so small as to be rendered meaningless. The X9408 worst case channel match between two of the four channels was .09dB and for the X9241A it was 0.1dB. Most of the channels actually matched within 0.01dB!

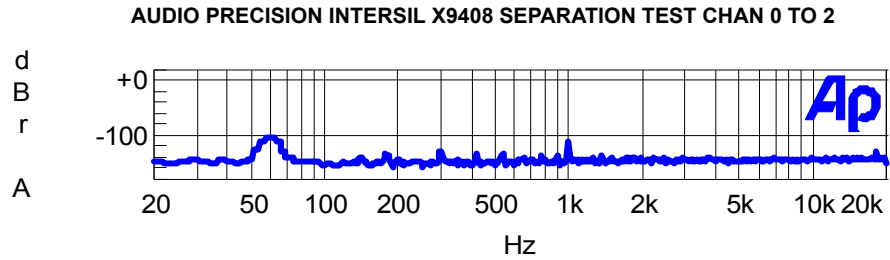

Color	Line Style	Thick	Data	Axis
Blue	Solid	3	Fft.Ch.1 Ampl	Left

X9408w(10K ohms) Chan 0 to 2 SEP = -110dB
 1kHz @ 0dB on 1st chan measuring wiper of 2sd channel. RL gr
 MBPWR

AUDIO PRECISION INTERSIL X9241A CROSSTALK CHAN 0 TO 2

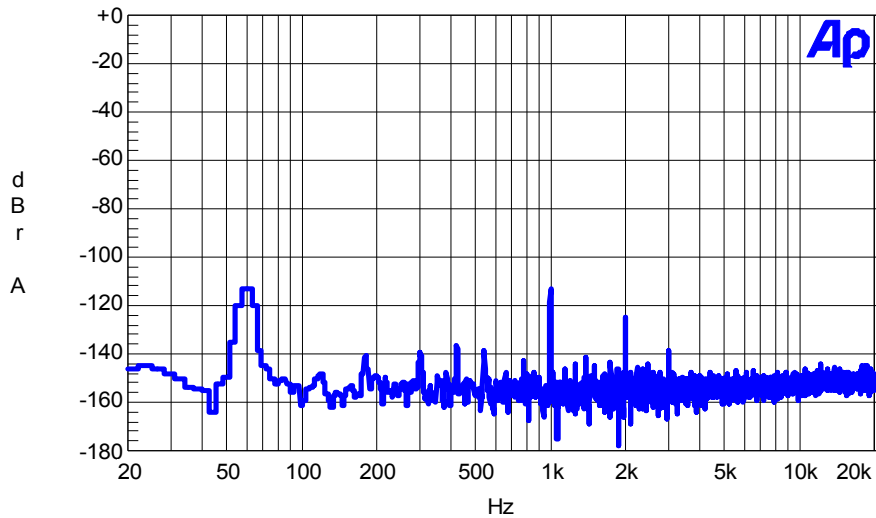

Color	Line Style	Thick	Data	Axis
Blue	Solid	3	Fft.Ch.1 Ampl	Left

X9241y(2k ohms) Chan 0 to 2 SEP = -112dB
1kHz @ 0dB on 1st chan measuring wiper of 2sd channel
RL grounded on all Channels.
AP2@100k_MBPWR

Measurement Results Summary

X9408

- 1. Signal to Noise Ratio (SNR): -120dB (AP2 Calc.)
- 2. Total Harmonic Distortion + Noise (THD+N): -106dB (AP2 Calc.)
- 3. Frequency Response 20Hz to 20kHz: ± .05dB
- 4. Two Tone Harmonic Test (18 + 19kHz): -122/-119dB at 1kHz
- 5. Listen for Zipper noise (Must be below audibility): PASSED
- 6. Channel Separation Range: -110/-85dB

X9241A

- 1. Signal to Noise Ratio (SNR): -119dB (AP2 Calc.)
- 2. Total Harmonic Distortion + Noise (THD+N): -102dB (AP2 Calc.)
- 3. Frequency Response 20Hz to 20kHz: ± .05dB
- 4. Two Tone Harmonic Test (18 + 19kHz): -108/-99 dB at 1kHz
- 5. Listen for Zipper noise (Must be below audibility): PASSED
- 6. Channel Separation: -116/-106dB

X9C102

- 1. Signal to Noise Ratio (SNR): -119dB (AP2 Calc.)
- 2. Total Harmonic Distortion + Noise (THD+N): -103dB (AP2 Calc.)
- 3. Frequency Response 20 Hz to 20kHz: ± .05dB
- 4. Two Tone harmonic Test (18 + 19kHz): -103dB at 1kHz
- 5. Listen for Zipper noise (Must be below audibility): PASSED

X9408w Test Results & Observations

The X9408 was the best Intersil part when evaluated for Frequency Response, Noise (SNR and THD+N) and Channel Separation. Below are comments on each of the measurements taken and the effect of each on the audio performance of the part. It should be noted that none of these measurements were weighted.

Frequency Response

The X9408 exhibited excellent frequency response all the way to the limit of the AP2, 200kHz. The response to 20kHz (the normal audio frequency measurement range limit) is outstanding, $\pm .005\text{dB}$. Ten times bandwidth to -3dB is a good rule of thumb when designing high quality audio circuits and the X9408 exceeded that requirement being only $\pm 0.05\text{dB}$ down at 200kHz!

THD+N

The THD+N for the four channels on the X9408 with a 1kHz 0 dB reference signal was between 106 and 107dB for all four channels! As you look at the X9408w graph on page 3, notice that there is only one harmonic at 3kHz above -120dB. This level of performance makes this part suitable for all types of consumer audio applications.

SNR

The SNR on the four channels of the X9408 ranged from 118dB to 120dB. In the SNR graphs it can be seen that the dominant noise in the test setup was at 60Hz. If you notch out that signal then the SNR for the four channels falls below 150dB! In either case this spec is more than sufficient for any consumer audio application including high end equipment that uses up to 20 bits of resolution.

Two Tone Test

Two 0 dB signals at different frequencies are fed into the DUT and the output is measured by the AP2 from 20Hz to 20kHz. Any harmonics created from the injection of these two signals into the DUT are displayed on a log frequency vs. amplitude graph. The graphs of the four channels show the harmonics created in this test were very low level, on the order of -110dB!

Crosstalk Noise (i.e. Channel Separation)

The level of channel separation on the X9408 depends on which channels are considered. Adjacent channels have less separation (worse number) than channels at opposite ends of the part. The worst measurement was between channels 2 and 3, -85dB, and the best was between channels 2 and 0, -110dB. With proper spacing and layout -110dB is achievable now and is acceptable for nearly all consumer audio.

Level Switching Noise Listening Test

The X9408 was inserted as a volume control (attenuator to ground) into the signal path of a very high end preamp that directly fed a set of ultra sensitive headphones (Grado). No level switching noise was detected by the listener at all levels.

Channel Matching

A series of measurements were made with all four channels at different steps (volume levels, see graphs). The worst case measurement at the lowest level setting of -36dB was $\pm .09\text{dB}$ for all four channels to each other and the other five level settings were better than 0.02dB! This was better than the other multi-channel part in the test, the X9241A, by a wide margin. This is also as good as any multi-channel volume control on the market today.

Conclusions

The X9408 exhibits excellent audio frequency performance. In any application where a linear taper level control along with low noise and low harmonic distortion are required, the X9408 is a top notch performer.

X9241A Test Results & Observations

The X9241A was the second best Intersil part when evaluated for Frequency Response, Noise (SNR and THD+N) and Channel Separation. Below are comments on each of the measurements taken and the effect of each on the audio performance of the part. It should be noted that none of these measurements were weighted.

Frequency Response

The X9241A exhibited excellent frequency response all the way to the limit of the AP2, 200kHz. The response to 20kHz (the normal audio frequency measurement range limit) is outstanding, $\pm .005\text{dB}$. Ten times bandwidth to -3dB is a good rule of thumb when designing high quality audio circuits and the X9241A exceeded that requirement being only $\pm 0.05\text{dB}$ down at 200kHz!

THD+N

The THD+N for the four channels on the X9241A with a 1kHz 0dB reference signal was between 101 and 102dB for all four channels! As you look at the X9241A graph on page 4, notice that there is only one harmonic at 3kHz above -120dB. This level of performance makes this part suitable for all types of consumer audio applications.

SNR

The SNR measured -119dB on four channels of the X9241A. In the SNR graphs it can be seen that the dominant noise in the test setup was at 60Hz. If you notch out that signal then the SNR for the four channels falls below 150dB! In either case this spec is more than sufficient for any consumer audio application including high end equipment that uses up to 20 bits of resolution.

Two Tone Test

Two 0dB signals at different frequencies are fed into the DUT and the output is measured by the AP2 from 20Hz to 20kHz. Any harmonics created from the injection of these two signals into the DUT are displayed on a log frequency vs. amplitude graph. The graphs of the four channels show the harmonics created in this test were very low level, on the order of -110dB!

Crosstalk Noise (i.e. Channel Separation)

The level of channel separation on the X9241A depends on which channels are considered. Adjacent channels have less separation (worse number) than channels at opposite ends of the part. The worst measurement was between channels 2 and 3, -106dB (-21dB better than the X9408), and the best was between channels 2 and 0, -116dB (-6dB better than X9408). With proper spacing and layout -116dB is achievable now and is acceptable for nearly all consumer audio.

Level Switching Noise Listening Test

The X9241A was inserted as a volume control (attenuator to ground) into the signal path of a very high end preamp that directly fed a set of ultra sensitive headphones (Grado). No level switching noise was detected by the listener at all levels.

Channel Matching

A series of measurements were made with all four channels at different steps (volume levels, see graphs). The worst case measurement was ± 0.1 dB for all four channels to each other and the best case was 0.02dB! This is also as good as any multi-channel volume control on the market today.

Conclusions

The X9241A exhibits excellent audio frequency performance. In any application where a linear taper level control along with low noise and low harmonic distortion are required, the X9241A is a top notch performer.

X9C102 Test Results & Observations

The X9C102 measurements are discussed below with comments on each of the measurements taken and the effect of each on the audio performance of the part. It should be noted that none of these measurements were weighted.

Frequency Response

The X9C102 exhibited excellent frequency response all the way to the limit of the AP2, 200kHz. The response to 20kHz (the normal audio frequency measurement range limit) is outstanding, ± 0.005 dB. Ten times bandwidth to -3dB is a good rule of thumb when designing high quality audio circuits and the X9C102 exceeded that requirement being only ± 0.05 dB down at 200kHz!

THD+N

The THD+N for X9C102 with a 1kHz 0dB reference signal was between 103dB. As you look at the X9C102 graph on page 5, notice that there is only one harmonic at 3kHz above -120dB. This level of performance makes this part suitable for all types of consumer audio applications.

SNR

The SNR measured -119dB on the X9C102. In the SNR graphs it can be seen that the dominant noise in the test setup was at 60Hz. This spec is more than sufficient for any consumer audio application including high end equipment that uses up to 20 bits of resolution.

Two Tone Test

Two 0 dB signals at different frequencies are fed into the DUT and the output is measured by the AP2 from 20Hz to 20kHz. Any harmonics created from the injection of these two signals into the DUT are displayed on a log frequency vs. amplitude graph. The graphs show the harmonics created in this test were very low level, on the order of -103dB!

Level Switching Noise Listening Test

The X9C102 was inserted as a volume control (attenuator to ground) into the signal path of a very high end preamp that directly fed a set of ultra sensitive headphones (Grado). No level switching noise was detected by the listener at all levels.

Conclusions

The X9C102 exhibits excellent audio frequency performance. In any application where a linear taper level control along with low noise and low harmonic distortion are required, the X9C102 is a top notch performer.

Appendix

AUDIO PRECISION INTERSIL X9408 4 CHANNEL LEVEL MATCHING
AT SIX DIFFERENT LEVEL SETTINGS

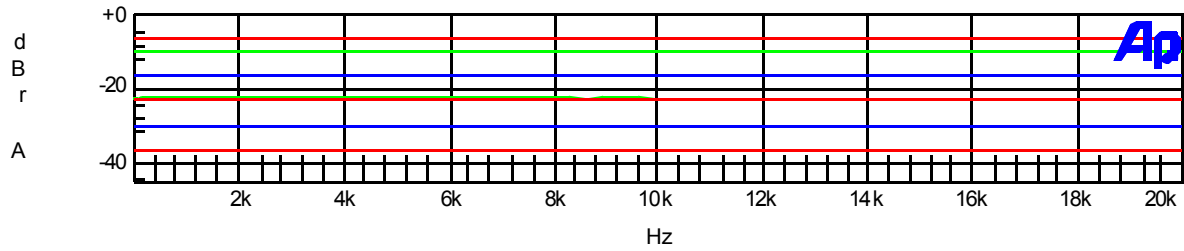

Color	Line Style	Thick	Data	Axis
Cyan	Solid	1	Anlr.LevelA	Left
Green	Solid	1	Anlr.LevelA	Left
Yellow	Solid	1	Anlr.LevelA	Left

X9408 Frequency Response ALL 4 CHANS
STEP 31 = -6dB, STEP20=-10dB, STEP 10=-16dB, STEP5=-22dB, STEP 2=-30dB, STEP 1=-38dB.
LAST STEP PURPLE =3, BLUE=2, CYAN=1, GREEN=0
Spread @ -6dB = ±.02dB, @ -10dB = ±.015dB, @ -16dB = ±.01dB,
@ -22dB = ±.01dB, @ -30dB = ±.012dB, @ -36dB = ±.09dB,
1.4vp20Hz to 200kHz on chan 0
AP2 Input Z = 100kΩ, MB PWR

AUDIO PRECISION INTERSIL X9241A ALL CHAN FREQUENCY RESPONSE

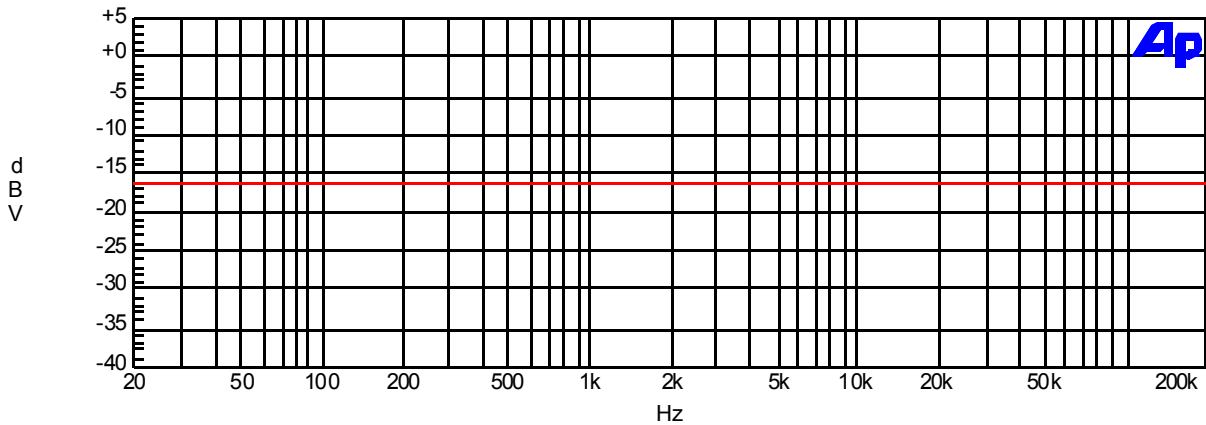

Color	Line Style	Thick	Data	Axis
Cyan	Solid	3	Anlr.LevelA	Left
Green	Solid	3	Anlr.LevelA	Left
Yellow	Solid	3	Anlr.LevelA	Left

X241y(2kΩ) Frequency Response ALL 4 CHANNELS TOGETHER - STEP 10
0=CYAN, 1=GREEN, 2=YELLOW, 3=RED
1.4vp20Hz to 200kHz on chan 3
AP2 Input Z = 100kΩ,
MB PWR

Appendix

AUDIO PRECISION INTERSIL X9241A ALL CHANS FREQUENCY RESPONSE

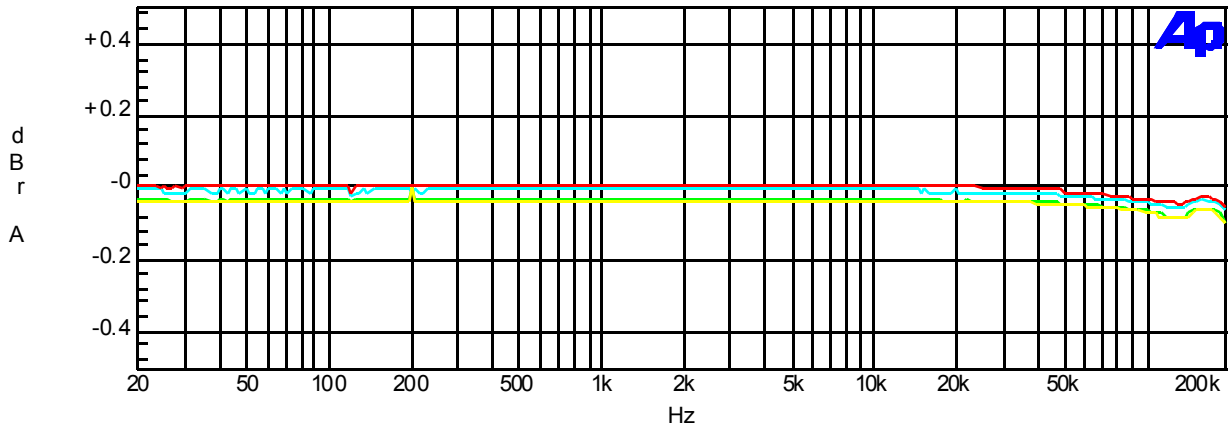

Color	Line Style	Thick	Data	Axis
Cyan	Solid	3	Anlr.LevelA	Left
Green	Solid	3	Anlr.LevelA	Left
Yellow	Solid	3	Anlr.LevelA	Left

X241y(2kΩ) Frequency Response ALL 4 CHANNELS TOGETHER
 0=CYAN, 1=GREEN, 2=YELLOW, 3=RED
 1.4vp20Hz to 200kHz on chan 3 @ step 63
 AP2 Input Z = 100kΩ,
 MB PWR

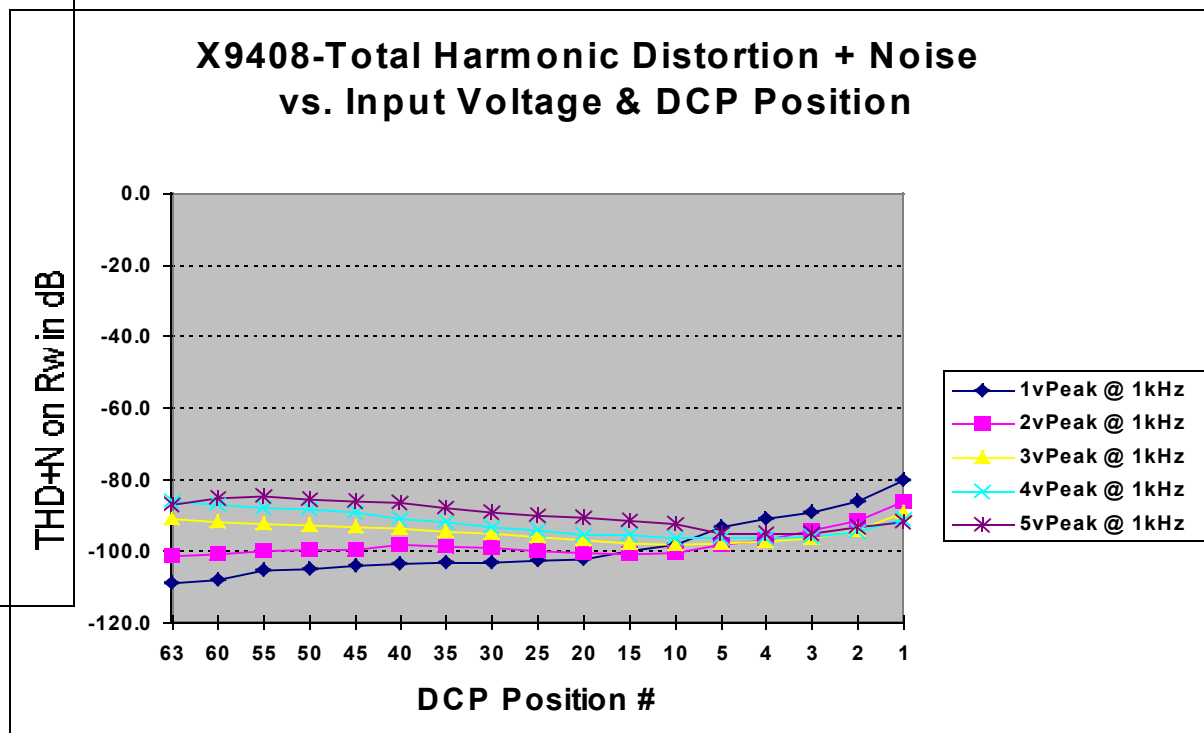

For more information please refer to datasheets X9408, X9421 and X9C102/103/104/503 at www.intersil.com

Notice

1. Descriptions of circuits, software and other related information in this document are provided only to illustrate the operation of semiconductor products and application examples. You are fully responsible for the incorporation or any other use of the circuits, software, and information in the design of your product or system. Renesas Electronics disclaims any and all liability for any losses and damages incurred by you or third parties arising from the use of these circuits, software, or information.
2. Renesas Electronics hereby expressly disclaims any warranties against and liability for infringement or any other claims involving patents, copyrights, or other intellectual property rights of third parties, by or arising from the use of Renesas Electronics products or technical information described in this document, including but not limited to, the product data, drawings, charts, programs, algorithms, and application examples.
3. No license, express, implied or otherwise, is granted hereby under any patents, copyrights or other intellectual property rights of Renesas Electronics or others.
4. You shall not alter, modify, copy, or reverse engineer any Renesas Electronics product, whether in whole or in part. Renesas Electronics disclaims any and all liability for any losses or damages incurred by you or third parties arising from such alteration, modification, copying or reverse engineering.
5. Renesas Electronics products are classified according to the following two quality grades: "Standard" and "High Quality". The intended applications for each Renesas Electronics product depends on the product's quality grade, as indicated below.
"Standard": Computers; office equipment; communications equipment; test and measurement equipment; audio and visual equipment; home electronic appliances; machine tools; personal electronic equipment; industrial robots; etc.
"High Quality": Transportation equipment (automobiles, trains, ships, etc.); traffic control (traffic lights); large-scale communication equipment; key financial terminal systems; safety control equipment; etc.
Unless expressly designated as a high reliability product or a product for harsh environments in a Renesas Electronics data sheet or other Renesas Electronics document, Renesas Electronics products are not intended or authorized for use in products or systems that may pose a direct threat to human life or bodily injury (artificial life support devices or systems; surgical implantations; etc.), or may cause serious property damage (space system; undersea repeaters; nuclear power control systems; aircraft control systems; key plant systems; military equipment; etc.). Renesas Electronics disclaims any and all liability for any damages or losses incurred by you or any third parties arising from the use of any Renesas Electronics product that is inconsistent with any Renesas Electronics data sheet, user's manual or other Renesas Electronics document.
6. When using Renesas Electronics products, refer to the latest product information (data sheets, user's manuals, application notes, "General Notes for Handling and Using Semiconductor Devices" in the reliability handbook, etc.), and ensure that usage conditions are within the ranges specified by Renesas Electronics with respect to maximum ratings, operating power supply voltage range, heat dissipation characteristics, installation, etc. Renesas Electronics disclaims any and all liability for any malfunctions, failure or accident arising out of the use of Renesas Electronics products outside of such specified ranges.
7. Although Renesas Electronics endeavors to improve the quality and reliability of Renesas Electronics products, semiconductor products have specific characteristics, such as the occurrence of failure at a certain rate and malfunctions under certain use conditions. Unless designated as a high reliability product or a product for harsh environments in a Renesas Electronics data sheet or other Renesas Electronics document, Renesas Electronics products are not subject to radiation resistance design. You are responsible for implementing safety measures to guard against the possibility of bodily injury, injury or damage caused by fire, and/or danger to the public in the event of a failure or malfunction of Renesas Electronics products, such as safety design for hardware and software, including but not limited to redundancy, fire control and malfunction prevention, appropriate treatment for aging degradation or any other appropriate measures. Because the evaluation of microcomputer software alone is very difficult and impractical, you are responsible for evaluating the safety of the final products or systems manufactured by you.
8. Please contact a Renesas Electronics sales office for details as to environmental matters such as the environmental compatibility of each Renesas Electronics product. You are responsible for carefully and sufficiently investigating applicable laws and regulations that regulate the inclusion or use of controlled substances, including without limitation, the EU RoHS Directive, and using Renesas Electronics products in compliance with all these applicable laws and regulations. Renesas Electronics disclaims any and all liability for damages or losses occurring as a result of your noncompliance with applicable laws and regulations.
9. Renesas Electronics products and technologies shall not be used for or incorporated into any products or systems whose manufacture, use, or sale is prohibited under any applicable domestic or foreign laws or regulations. You shall comply with any applicable export control laws and regulations promulgated and administered by the governments of any countries asserting jurisdiction over the parties or transactions.
10. It is the responsibility of the buyer or distributor of Renesas Electronics products, or any other party who distributes, disposes of, or otherwise sells or transfers the product to a third party, to notify such third party in advance of the contents and conditions set forth in this document.
11. This document shall not be reprinted, reproduced or duplicated in any form, in whole or in part, without prior written consent of Renesas Electronics.
12. Please contact a Renesas Electronics sales office if you have any questions regarding the information contained in this document or Renesas Electronics products.
(Note 1) "Renesas Electronics" as used in this document means Renesas Electronics Corporation and also includes its directly or indirectly controlled subsidiaries.
(Note 2) "Renesas Electronics product(s)" means any product developed or manufactured by or for Renesas Electronics.

(Rev.4.0-1 November 2017)



SALES OFFICES

Renesas Electronics Corporation

<http://www.renesas.com>

Refer to "<http://www.renesas.com/>" for the latest and detailed information.

Renesas Electronics America Inc.

1001 Murphy Ranch Road, Milpitas, CA 95035, U.S.A.
Tel: +1-408-432-8888, Fax: +1-408-434-5351

Renesas Electronics Canada Limited

9251 Yonge Street, Suite 8309 Richmond Hill, Ontario Canada L4C 9T3
Tel: +1-905-237-2004

Renesas Electronics Europe Limited

Dukes Meadow, Millboard Road, Bourne End, Buckinghamshire, SL8 5FH, U.K
Tel: +44-1628-651-700, Fax: +44-1628-651-804

Renesas Electronics Europe GmbH

Arcadiastrasse 10, 40472 Düsseldorf, Germany
Tel: +49-211-6503-0, Fax: +49-211-6503-1327

Renesas Electronics (China) Co., Ltd.

Room 1709 Quantum Plaza, No.27 ZhichunLu, Haidian District, Beijing, 100191 P. R. China
Tel: +86-10-8235-1155, Fax: +86-10-8235-7679

Renesas Electronics (Shanghai) Co., Ltd.

Unit 301, Tower A, Central Towers, 555 Langao Road, Putuo District, Shanghai, 200333 P. R. China
Tel: +86-21-2226-0888, Fax: +86-21-2226-0999

Renesas Electronics Hong Kong Limited

Unit 1601-1611, 16/F., Tower 2, Grand Century Place, 193 Prince Edward Road West, Mongkok, Kowloon, Hong Kong
Tel: +852-2265-6688, Fax: +852 2886-9022

Renesas Electronics Taiwan Co., Ltd.

13F, No. 363, Fu Shing North Road, Taipei 10543, Taiwan
Tel: +886-2-8175-9600, Fax: +886 2-8175-9670

Renesas Electronics Singapore Pte. Ltd.

80 Bendemeer Road, Unit #06-02 Hyflux Innovation Centre, Singapore 339949
Tel: +65-6213-0200, Fax: +65-6213-0300

Renesas Electronics Malaysia Sdn.Bhd.

Unit 1207, Block B, Menara Amcorp, Amcorp Trade Centre, No. 18, Jln Persiaran Barat, 46050 Petaling Jaya, Selangor Darul Ehsan, Malaysia
Tel: +60-3-7955-9390, Fax: +60-3-7955-9510

Renesas Electronics India Pvt. Ltd.

No.777C, 100 Feet Road, HAL 2nd Stage, Indiranagar, Bangalore 560 038, India
Tel: +91-80-67208700, Fax: +91-80-67208777

Renesas Electronics Korea Co., Ltd.

17F, KAMCO Yangjae Tower, 262, Gangnam-daero, Gangnam-gu, Seoul, 06265 Korea
Tel: +82-2-558-3737, Fax: +82-2-558-5338