RX Family

R01AN4764EC0100

Rev.1.00

CTSU 2D Gesture Solution Demo Set Hardware

Apr. 22, 2019

Introduction

The RX130 Group is equipped with a hardware (Capacitive Touch Sensor Unit; CTSU) that senses the contact of the human body by measuring the capacitance generated between the touch electrode and the human body (hand, etc.). This document explains a 2D Gesture Solution Demo set based on the RX130 Group MCU.

Target Device

RX130 Group

Contents

1. Overview	3
2. External Appearance	3
3. Specifications	3
3.1 Hardware Specifications.....	3
3.2 Peripheral Functions.....	4
3.3 Pin Definitions.....	4
4. Schematic of 2D Gesture Solution Demo Set	6
5. PCB Layout of 2D Gesture Solution Demo Set	7
6. Part List of 2D Gesture Solution Demo Set	9
Website and Support	10
Revision History	11
General Precautions in the Handling of Microprocessing Unit and Microcontroller Unit Products....	1
Notice	1

1. Overview

The 2D Gesture Solution Demo set is a demonstration kit that detects 2D gesture input by the CTSU of RX130 Group MCU.

This demo set serves as a sample application such as the control panel of the range hood. It shows the demo of the hand hovering and left/right sweeping gesture input on 2 electrodes.

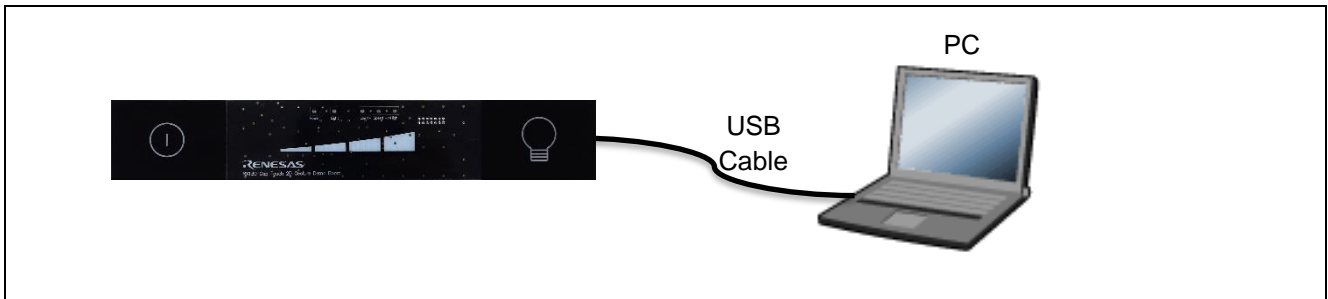

Figure1.1 Demo Set Connection

2. External Appearance

Figure 2.1 and Figure 2.2 show the external appearance of the 2D Gesture Solution Demo set.

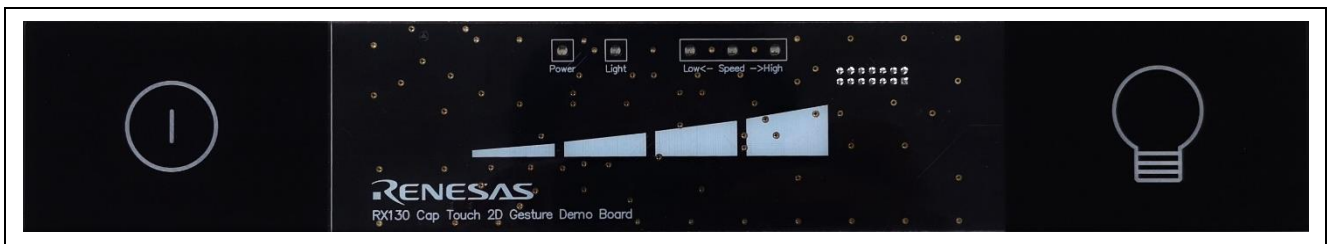

Figure2.1 External Appearance (Front View)

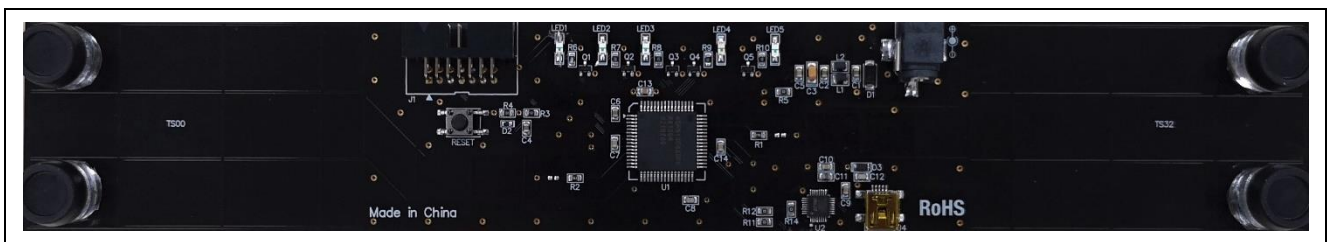

Figure2.2 External Appearance (Back View)

3. Specifications

3.1 Hardware Specifications

The hardware specifications are shown in Table 3.1.

Table 3.1 Hardware Specifications of 2D Gesture Solution Demo Set

Item	Description
Power supply	DC jack (J2) 5V Φ 5.5mm , center plus, option
	USB bus powered (VBUS): 5V
Current drain	Max: 30 mA
Dimensions	300 x 50 x 20 mm
Microcontroller	R5F1308ADFK (ROM: 512 KB, RAM: 48 KB, 64LQFP)
Debugging interface	E1 connector (J1)
Display	5 LED lights (power:1 light:1 speed:3)
Touch Electrodes	2 Gesture detection electrodes: left, right (self-capacitance method)
USB serial conversion interface	Connector: USB mini-B
	IC: FTDI's FT232RQ

3.2 Peripheral Functions

The peripheral functions of the 2D Gesture Solution Demo set are shown in Table 3.2.

Table 3.2 Peripheral Functions of 2D Gesture Solution Demo Set

Peripheral Function	Usage
CTSU	Capacitive touch key function
TAU00	Touch API system interval time controls for the registers of CTSU settings This timer also controls the operation interval time of the demo function
UART6	For the connection between Workbench6 and monitor tool
5 I/O ports	LED light control

3.3 Pin Definitions

The MCU pin definitions of the 2D Gesture Solution Demo set are shown in Table 3.3.

Table 3.3 MCU Pin Definitions of 2D Gesture Solution Demo Set

Pin No.	Pin Name	Pin No.	Pin Name	Pin No.	Pin Name
1	Unused pin	23	Unused pin	45	TS32
2	VCL	24	Unused pin	46	Unused pin
3	MD/fined	25	Unused pin	47	Unused pin
4	Unused pin	26	Unused pin	48	Unused pin
5	Unused pin	27	Unused pin	49	Unused pin
6	RESET	28	Unused pin	50	Unused pin
7	Unused pin	29	Unused pin	51	Unused pin
8	Vss	30	TSCAP	52	Unused pin
9	Unused pin	31	Unused pin	53	LED5
10	Vcc	32	Unused pin	54	LED4
11	Unused pin	33	Unused pin	55	LED3
12	TS00	34	Unused pin	56	LED2
13	Unused pin	35	Unused pin	57	LED1
14	Unused pin	36	Unused pin	58	Unused pin
15	Unused pin	37	TXD6	59	Unused pin
16	Unused pin	38	Vcc	60	Unused pin
17	Unused pin	39	RXD6	61	Unused pin
18	Unused pin	40	Vss	62	Vcc
19	Unused pin	41	Unused pin	63	Unused pin
20	Unused pin	42	Unused pin	64	Vss
21	Unused pin	43	Unused pin		
22	Unused pin	44	Unused pin		

4. Schematic of 2D Gesture Solution Demo Set

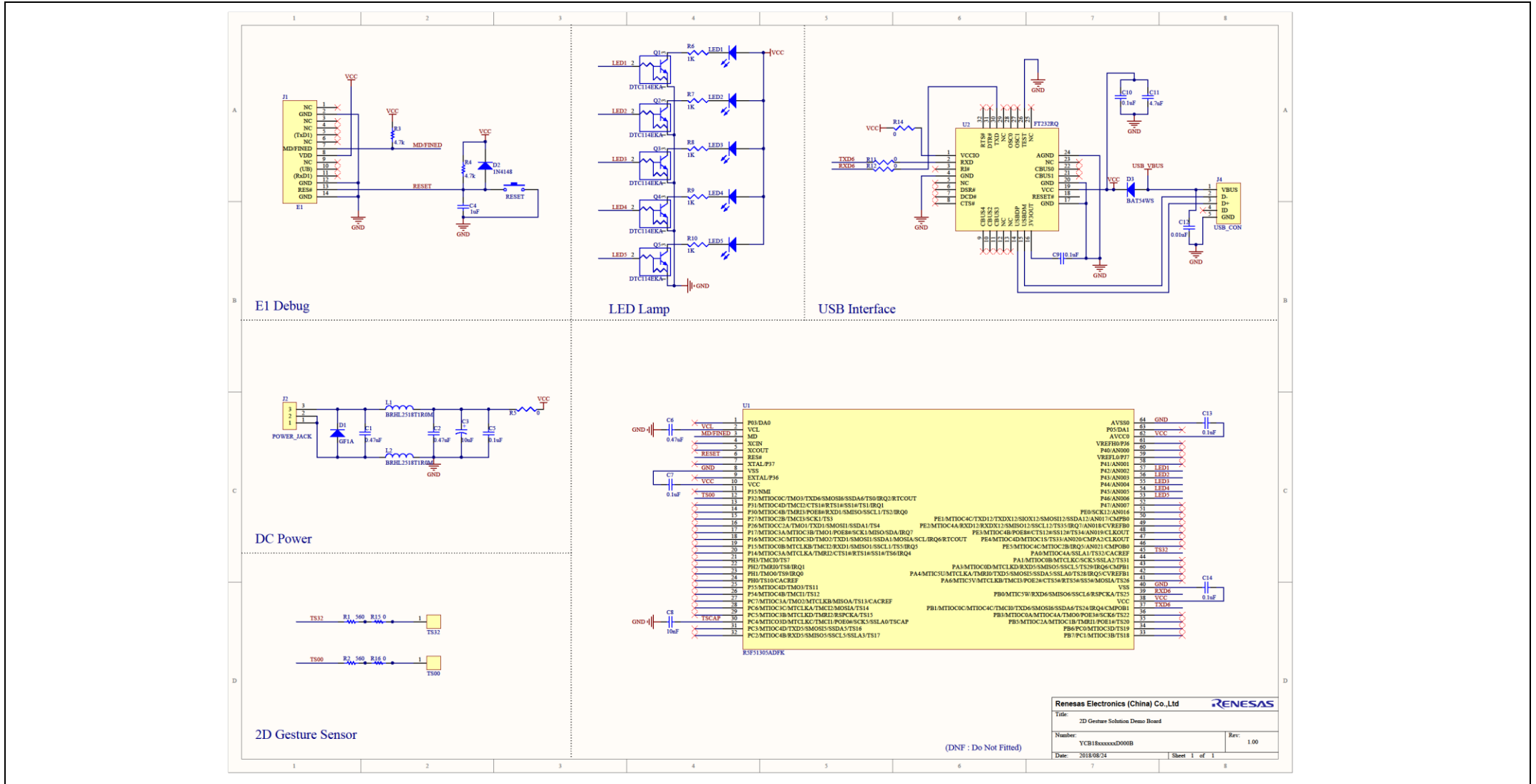

Figure 4.1 Schematic of 2D Gesture Solution Demo Set

5. PCB Layout of 2D Gesture Solution Demo Set

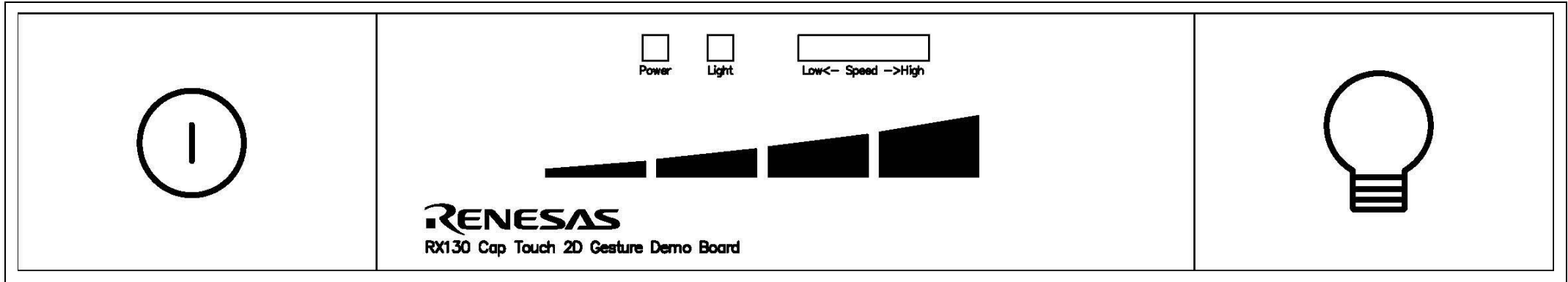

Figure 5.1 Top Overlay Silkscreen (Top View)

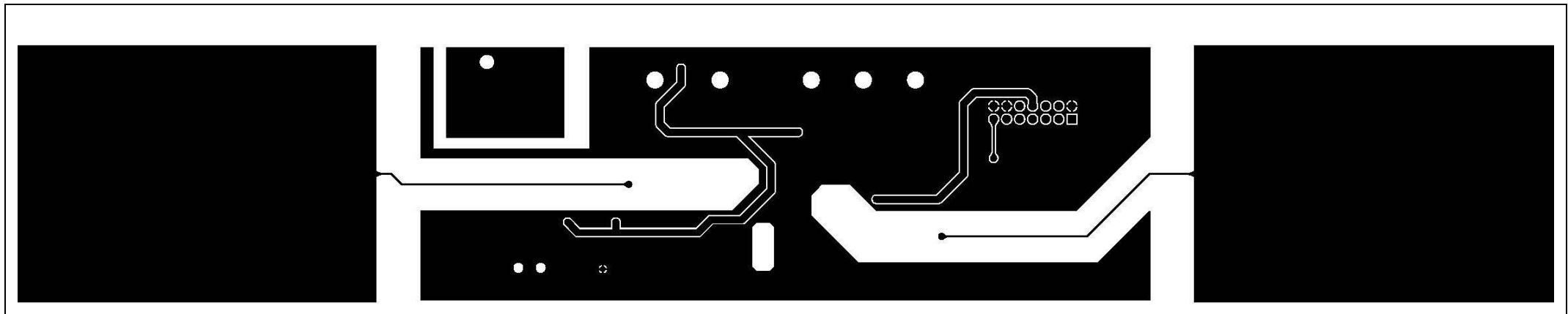

Figure 5.2 Top Layer Pattern (Top View)

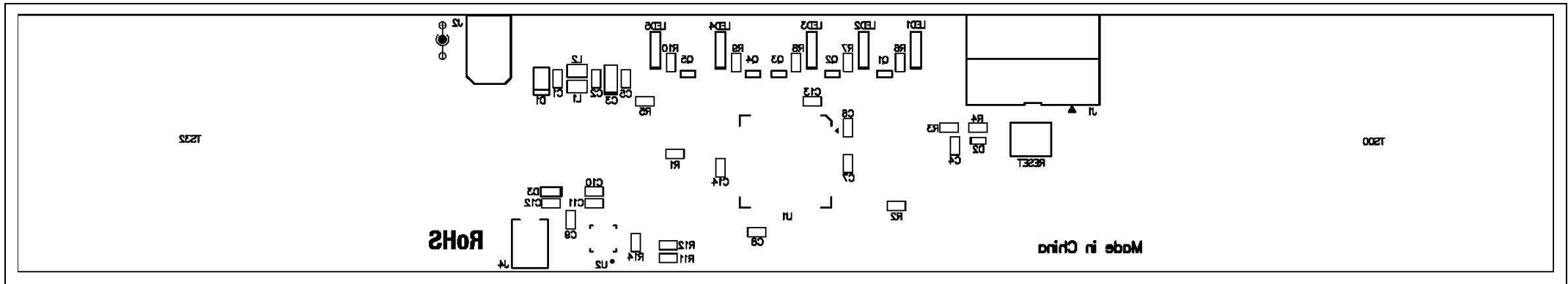

Figure 5.3 Bottom Overlay Silkscreen (Top View)

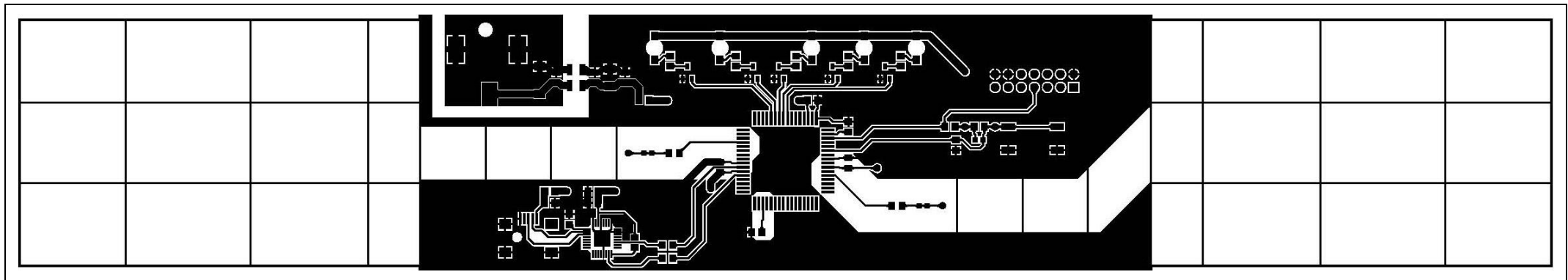

Figure 5.4 Bottom Layer Pattern (Top View)

6. Part List of 2D Gesture Solution Demo Set

No.	Designator	Part No.	Number	Footprint	Comment
1	U1	R5F51305ADFK	1	LQFP64_0.8_14X14	MCU
2	U2	FT232RQ	1	QFN32	IC USB FS SERIAL UART 32-QFN
3	C8, C12	C0805C103K4RACTU	2	0805	CAP CER 10nF 16V X7R 0805
4	C5, C7, C9, C10, C13, C14	C0805C104Z4VACTU	6	0805	CAP CER 0.1UF 16V Y5V 0805
5	C1, C2, C6	C0805C474K4RACTU	3	0805	CAP CER 0.47UF 16V X7R 0805
6	C4	C0805C105K4PACTU	1	0805	CAP CER 1UF 16V X5R 0805
7	C11	C0805C475K4RACTU	1	0805	CAP CER 4.7UF 16V X7R 0805
8	C3	T491A106K016AT	1	1206	CAP TANT 10UF 16V 10% 1206
9	D1	GF1A	1	GF1A	DIODE GEN PURP 50V 1A SMA
10	D2	1N4148WT-7	1	0603	DIODE GEN PURP 80V 125MA SOD523
11	D3	BAT54WS-HE3-18	1	0805	DIODE SCHOTTKY 30V 200MA SOD323
12	J1	IDC-14 pin	1	E1	CONN HEADER P/A 14POS 2.54MM (for E1)
13	J2	RASM722PTR13X	1	POWER	CONN PWR JACK 2.1X5.5MM SOLDER
14	J4	Mini-USB	1	USB_SMT	Mini USB Plug
15	L1, L2	BRHL2518T1R0M	2	2518	FIXED IND 1UH 1.4A 71.5 MOHM SMD
16	LED1, LED2, LED3, LED4, LED5	LTST-C230KGKT	5	1206	LED GREEN CLEAR CHIP SMD
17	Q1, Q2, Q3, Q4, Q5	DTC114EKA	5	SOT-23-3	TRANS PREBIAS NPN 200MW SMT3
18	RESET	RS-014R05B1-SMA10 RT	1	6X6mm	SWITCH TACTILE SPST-NO 0.05A 12V
19	R5, R11, R12, R14	CRCW08050000Z0EA	4	0805	RES SMD 0.0 OHM JUMPER 1/8W 0805
20	R1, R2	CRCW0805560RJNEA	2	0805	RES SMD 560 OHM 5% 1/8W 0805
21	R6, R7, R8, R9, R10	CRCW08051K00FKEA	5	0805	RES SMD 1K OHM 1% 1/8W 0805
22	R3, R4	CRCW08054K70FKEA	2	0805	RES SMD 4.7K OHM 1% 1/8W 0805

Website and Support

Renesas Electronics Website

<http://www.renesas.com/>

Inquiries

<http://www.renesas.com/contact/>

Revision History

Rev.	Date	Description	
		Page	Summary
1.00	Apr. 22, 2019	—	First edition issued

General Precautions in the Handling of Microprocessing Unit and Microcontroller Unit Products

The following usage notes are applicable to all Microprocessing unit and Microcontroller unit products from Renesas. For detailed usage notes on the products covered by this document, refer to the relevant sections of the document as well as any technical updates that have been issued for the products.

1. Precaution against Electrostatic Discharge (ESD)

A strong electrical field, when exposed to a CMOS device, can cause destruction of the gate oxide and ultimately degrade the device operation. Steps must be taken to stop the generation of static electricity as much as possible, and quickly dissipate it when it occurs. Environmental control must be adequate. When it is dry, a humidifier should be used. This is recommended to avoid using insulators that can easily build up static electricity. Semiconductor devices must be stored and transported in an anti-static container, static shielding bag or conductive material. All test and measurement tools including work benches and floors must be grounded. The operator must also be grounded using a wrist strap. Semiconductor devices must not be touched with bare hands. Similar precautions must be taken for printed circuit boards with mounted semiconductor devices.

2. Processing at power-on

The state of the product is undefined at the time when power is supplied. The states of internal circuits in the LSI are indeterminate and the states of register settings and pins are undefined at the time when power is supplied. In a finished product where the reset signal is applied to the external reset pin, the states of pins are not guaranteed from the time when power is supplied until the reset process is completed. In a similar way, the states of pins in a product that is reset by an on-chip power-on reset function are not guaranteed from the time when power is supplied until the power reaches the level at which resetting is specified.

3. Input of signal during power-off state

Do not input signals or an I/O pull-up power supply while the device is powered off. The current injection that results from input of such a signal or I/O pull-up power supply may cause malfunction and the abnormal current that passes in the device at this time may cause degradation of internal elements. Follow the guideline for input signal during power-off state as described in your product documentation.

4. Handling of unused pins

Handle unused pins in accordance with the directions given under handling of unused pins in the manual. The input pins of CMOS products are generally in the high-impedance state. In operation with an unused pin in the open-circuit state, extra electromagnetic noise is induced in the vicinity of the LSI, an associated shoot-through current flows internally, and malfunctions occur due to the false recognition of the pin state as an input signal become possible.

5. Clock signals

After applying a reset, only release the reset line after the operating clock signal becomes stable. When switching the clock signal during program execution, wait until the target clock signal is stabilized. When the clock signal is generated with an external resonator or from an external oscillator during a reset, ensure that the reset line is only released after full stabilization of the clock signal. Additionally, when switching to a clock signal produced with an external resonator or by an external oscillator while program execution is in progress, wait until the target clock signal is stable.

6. Voltage application waveform at input pin

Waveform distortion due to input noise or a reflected wave may cause malfunction. If the input of the CMOS device stays in the area between VIL (Max.) and VIH (Min.) due to noise, for example, the device may malfunction. Take care to prevent chattering noise from entering the device when the input level is fixed, and also in the transition period when the input level passes through the area between VIL (Max.) and VIH (Min.).

7. Prohibition of access to reserved addresses

Access to reserved addresses is prohibited. The reserved addresses are provided for possible future expansion of functions. Do not access these addresses as the correct operation of the LSI is not guaranteed.

8. Differences between products

Before changing from one product to another, for example to a product with a different part number, confirm that the change will not lead to problems. The characteristics of a microprocessing unit or microcontroller unit products in the same group but having a different part number might differ in terms of internal memory capacity, layout pattern, and other factors, which can affect the ranges of electrical characteristics, such as characteristic values, operating margins, immunity to noise, and amount of radiated noise. When changing to a product with a different part number, implement a system-evaluation test for the given product.

Notice

1. Descriptions of circuits, software and other related information in this document are provided only to illustrate the operation of semiconductor products and application examples. You are fully responsible for the incorporation or any other use of the circuits, software, and information in the design of your product or system. Renesas Electronics disclaims any and all liability for any losses and damages incurred by you or third parties arising from the use of these circuits, software, or information.
 2. Renesas Electronics hereby expressly disclaims any warranties against and liability for infringement or any other claims involving patents, copyrights, or other intellectual property rights of third parties, by or arising from the use of Renesas Electronics products or technical information described in this document, including but not limited to, the product data, drawings, charts, programs, algorithms, and application examples.
 3. No license, express, implied or otherwise, is granted hereby under any patents, copyrights or other intellectual property rights of Renesas Electronics or others.
 4. You shall not alter, modify, copy, or reverse engineer any Renesas Electronics product, whether in whole or in part. Renesas Electronics disclaims any and all liability for any losses or damages incurred by you or third parties arising from such alteration, modification, copying or reverse engineering.
 5. Renesas Electronics products are classified according to the following two quality grades: "Standard" and "High Quality". The intended applications for each Renesas Electronics product depends on the product's quality grade, as indicated below.
 - "Standard": Computers; office equipment; communications equipment; test and measurement equipment; audio and visual equipment; home electronic appliances; machine tools; personal electronic equipment; industrial robots; etc.
 - "High Quality": Transportation equipment (automobiles, trains, ships, etc.); traffic control (traffic lights); large-scale communication equipment; key financial terminal systems; safety control equipment; etc.
- Unless expressly designated as a high reliability product or a product for harsh environments in a Renesas Electronics data sheet or other Renesas Electronics document, Renesas Electronics products are not intended or authorized for use in products or systems that may pose a direct threat to human life or bodily injury (artificial life support devices or systems; surgical implantations; etc.), or may cause serious property damage (space system; undersea repeaters; nuclear power control systems; aircraft control systems; key plant systems; military equipment; etc.). Renesas Electronics disclaims any and all liability for any damages or losses incurred by you or any third parties arising from the use of any Renesas Electronics product that is inconsistent with any Renesas Electronics data sheet, user's manual or other Renesas Electronics document.
6. When using Renesas Electronics products, refer to the latest product information (data sheets, user's manuals, application notes, "General Notes for Handling and Using Semiconductor Devices" in the reliability handbook, etc.), and ensure that usage conditions are within the ranges specified by Renesas Electronics with respect to maximum ratings, operating power supply voltage range, heat dissipation characteristics, installation, etc. Renesas Electronics disclaims any and all liability for any malfunctions, failure or accident arising out of the use of Renesas Electronics products outside of such specified ranges.
 7. Although Renesas Electronics endeavors to improve the quality and reliability of Renesas Electronics products, semiconductor products have specific characteristics, such as the occurrence of failure at a certain rate and malfunctions under certain use conditions. Unless designated as a high reliability product or a product for harsh environments in a Renesas Electronics data sheet or other Renesas Electronics document, Renesas Electronics products are not subject to radiation resistance design. You are responsible for implementing safety measures to guard against the possibility of bodily injury, injury or damage caused by fire, and/or danger to the public in the event of a failure or malfunction of Renesas Electronics products, such as safety design for hardware and software, including but not limited to redundancy, fire control and malfunction prevention, appropriate treatment for aging degradation or any other appropriate measures. Because the evaluation of microcomputer software alone is very difficult and impractical, you are responsible for evaluating the safety of the final products or systems manufactured by you.
 8. Please contact a Renesas Electronics sales office for details as to environmental matters such as the environmental compatibility of each Renesas Electronics product. You are responsible for carefully and sufficiently investigating applicable laws and regulations that regulate the inclusion or use of controlled substances, including without limitation, the EU RoHS Directive, and using Renesas Electronics products in compliance with all these applicable laws and regulations. Renesas Electronics disclaims any and all liability for damages or losses occurring as a result of your noncompliance with applicable laws and regulations.
 9. Renesas Electronics products and technologies shall not be used for or incorporated into any products or systems whose manufacture, use, or sale is prohibited under any applicable domestic or foreign laws or regulations. You shall comply with any applicable export control laws and regulations promulgated and administered by the governments of any countries asserting jurisdiction over the parties or transactions.
 10. It is the responsibility of the buyer or distributor of Renesas Electronics products, or any other party who distributes, disposes of, or otherwise sells or transfers the product to a third party, to notify such third party in advance of the contents and conditions set forth in this document.
 11. This document shall not be reprinted, reproduced or duplicated in any form, in whole or in part, without prior written consent of Renesas Electronics.
 12. Please contact a Renesas Electronics sales office if you have any questions regarding the information contained in this document or Renesas Electronics products.

(Note1) "Renesas Electronics" as used in this document means Renesas Electronics Corporation and also includes its directly or indirectly controlled subsidiaries.

(Note2) "Renesas Electronics product(s)" means any product developed or manufactured by or for Renesas Electronics.

(Rev.4.0-1 November 2017)

Corporate Headquarters

TOYOSU FORESIA, 3-2-24 Toyosu,
Koto-ku, Tokyo 135-0061, Japan
www.renesas.com

Trademarks

Renesas and the Renesas logo are trademarks of Renesas Electronics Corporation. All trademarks and registered trademarks are the property of their respective owners.

Contact information

For further information on a product, technology, the most up-to-date version of a document, or your nearest sales office, please visit:
www.renesas.com/contact/.