

e² studio 7.3.0

R20UT4471EE0100

Rev.1.00

Release Note

Jan 14th, 2019

Introduction

This document outlines the device support, new features added in 7.3.0, fixed issues and open issues in e² studio 7.3.0.

Contents

1. Product Information	2
1.1 Supported Operating Systems	2
1.2 Supported Toolchains	2
2. Device Support	3
2.1 Project Generator Support	3
2.2 Code Generator & Smart Configurator Support	9
3. Smart Manual Support	12
4. What is new in 7.3.0?	13
5. What is new in 7.2.0?	21
6. What is new in 7.1.0?	22
7. What is new in 7.0.0?	32
8. Useful workarounds and information for 7.3.0.....	45
9. Open Issues in 7.3.0.....	55
10. Appendix.....	56
10.1 Website and Support	56

1. Product Information

1.1 Supported Operating Systems

These operating systems are officially supported by e² studio:

- Windows 7 32-bit
- Windows 7 64-bit
- Windows 8.1 32-bit
- Windows 8.1 64-bit
- Windows 10 32-bit
- Windows 10 64-bit

1.2 Supported Toolchains

The following toolchains are supported in e² studio 7.3.0.

	Renesas	GNU Arm Embedded (*2)	Renesas GCC/ GNURZ/ARM (*3)	IAR (*4)	Green Hills (*5)
RL78	Yes (CC-RL)	No	Yes	Yes	No
RX	Yes (CC-RX)	No	Yes	Yes	No
RH850	No	No	No	Yes	Yes
RZ/ARM	No	No (*1)	Yes	Yes	No
Synergy/ARM	No	Yes	No	Yes	No

Note:

*1: Project converter is available to convert from GNUARM RZ/none to GNU ARM Embedded toolchain.

*2: The GCC toolchains for RZ Family and Renesas Synergy™ are distributed via Arm Developer at <https://developer.arm.com/open-source/gnu-toolchain/gnu-rm> or Launchpad.net at: <https://launchpad.net/gcc-arm-embedded>. They are also available using the “Additional components” page in the e² studio installer.

*3: Legacy GNUARM toolchains are available from <https://gcc-renesas.com/>. In addition, the latest RX and RL78 Renesas GCC toolchains are available from this website.

*4: The IAR toolchain plugins are available via the “Help”->” IAR Embedded Workbench plugin manager” menu in e² studio. These Eclipse plugins are provided by IAR and are not supported by Renesas.

*5: The Green Hills toolchain plugins are available within the e² studio product. These plugins are provided by Green Hills and are not supported by Renesas.

2. Device Support

2.1 Project Generator Support

Note: The Renesas SH device family is no longer supported in e² studio.

Family	Group	Devices
EC-1	EC-1	R9A06G043
	C1H	R7F701260, R7F701270,(Debug Support Only)
	C1M	R7F701263, R7F701271,(Debug Support Only)
	D1L1	R7F701401, R7F701421,(Debug Support Only)
	D1L2	R7F701422, R7F701402 (Debug Support Only)
	D1M1	R7F701404, R7F701405,(Debug Support Only)
	-	R7F701442, R7F701462,(Debug Support Only)
	D1M2	R7F701408, R7F701410, R7F701428, R7F701430,(Debug Support Only)
	E1L	R7F701201, R7F701205,(Debug Support Only)
	E1M-S	R7F701202, R7F701204,(Debug Support Only)
	E1M-S2	R7F701215, R7F701216,(Debug Support Only)
	-	R7F701Z05, R7F701Z06, R7F701Z07,(Debug Support Only)
	F1H	R7F701501, R7F701502, R7F701503, R7F701506, R7F701507, R7F701508, R7F701511, R7F701512, R7F701513,(Debug Support Only), R7F701521, R7F701522, R7F701524, R7F701525,(Debug Support Only)
	F1K	R7F701542, R7F701543, R7F701546, R7F701547, R7F701557, R7F701560, R7F701561, R7F701562, R7F701563, R7F701566, R7F701567, R7F701577, R7F701580, R7F701581, R7F701582, R7F701583, R7F701586, R7F701587, R7F701597, R7F701602, R7F701603, R7F701610, R7F701611, R7F701612, R7F701613, R7F701620, R7F701621, R7F701622, R7F701623,(Debug Support Only)
	RH850	F1KH
F1KM		R7F701644, R7F701645, R7F701646, R7F701647, R7F701648, R7F701649, R7F701650, R7F701651, R7F701684, R7F701685, R7F701686, R7F701687, R7F701688, R7F701689, R7F701690, R7F701691, R7F701692, R7F701693, R7F701694, R7F701695,(Debug Support Only)
F1L		R7F701002xAFF, R7F701003xAFF, R7F701006xAFF, R7F701007xAFF, R7F701008xAFF, R7F701009xAFF, R7F701010xAFF, R7F701011xAFF, R7F701012xAFF, R7F701013xAFF, R7F701014xAFF, R7F701015xAFF, R7F701016xAFF, R7F701017xAFF, R7F701018xAFF, R7F701019xAFF, R7F701020xAFF, R7F701021xAFF, R7F701022xAFF, R7F701023xAFF, R7F701024xAFF, R7F701025xAFF, R7F701026xAFF, R7F701027xAFF, R7F701028xAFF, R7F701029xAFF, R7F701030xAFF, R7F701032xAFF, R7F701033xAFF, R7F701034xAFF, R7F701040, R7F701041, R7F701042, R7F701043, R7F701044, R7F701045, R7F701046, R7F701047, R7F701048, R7F701049, R7F701050, R7F701051, R7F701052, R7F701053, R7F701054, R7F701055, R7F701056, R7F701057,(Debug Support Only)
F1M		R7F701544, R7F701545, R7F701548, R7F701549, R7F701552, R7F701553, R7F701564, R7F701565, R7F701568, R7F701569, R7F701572, R7F701573,(Debug Support Only)

P1H-C	R7F701370AEEBG, R7F701371EABG, R7F701372EABG, R7F701396EABG,(Debug Support Only)
P1L-C	R7F701388, R7F701389, R7F701390, R7F701391,(Debug Support Only)
P1M	R7F701304, R7F701305, R7F701310, R7F701311, R7F701312, R7F701313, R7F701314, R7F701315, R7F701318, R7F701319, R7F701320, R7F701321, R7F701322, R7F701323,(Debug Support Only)
P1M-C	R7F701373xABG, R7F701374xAFF, R7F701397xABG,(Debug Support Only)
P1M-E	R7F701375, R7F701376, R7F701377, R7F701378, R7F701379, R7F701380, R7F701381, R7F701382, R7F701383, R7F701384, R7F701385, R7F701386,(Debug Support Only)
-	R7F701060xAFF, R7F701062xAFF, R7F701064xAFF, R7F701065xAFF, R7F701067xAFF, R7F701069xAFF, R7F701071xAFF,(Debug Support Only)
D1A	R5F10CGB, R5F10CGC, R5F10CGD, R5F10CLD, R5F10CMD, R5F10CME, R5F10DGC, R5F10DGD, R5F10DGE, R5F10DLD, R5F10DLE, R5F10DMD, R5F10DME, R5F10DMF, R5F10DMG, R5F10DMJ, R5F10DPE, R5F10DPF, R5F10DPG, R5F10DPJ, R5F10DPK, R5F10DPL, R5F10DSJ, R5F10DSK, R5F10DSL, R5F10TPJ
F12	R5F10968, R5F1096A, R5F1096B, R5F1096C, R5F1096D, R5F1096E, R5F109AA, R5F109AB, R5F109AC, R5F109AD, R5F109AE, R5F109BA, R5F109BB, R5F109BC, R5F109BD, R5F109BE, R5F109GA, R5F109GB, R5F109GC, R5F109GD, R5F109GE, R5F109LA, R5F109LB, R5F109LC, R5F109LD, R5F109LE
F13	R5F10A6A, R5F10A6C, R5F10A6D, R5F10A6E, R5F10AAA, R5F10AAC, R5F10AAD, R5F10AAE, R5F10ABA, R5F10ABC, R5F10ABD, R5F10ABE, R5F10AGA, R5F10AGC, R5F10AGD, R5F10AGE, R5F10AGF, R5F10AGG, R5F10ALC, R5F10ALD, R5F10ALE, R5F10ALF, R5F10ALG, R5F10AME, R5F10AMF, R5F10AMG, R5F10BAC, R5F10BAD, R5F10BAE, R5F10BAF, R5F10BAG, R5F10BBC, R5F10BBD, R5F10BBE, R5F10BBF, R5F10BBG, R5F10BGC, R5F10BGD, R5F10BGE, R5F10BGF, R5F10BGG, R5F10BLC, R5F10BLD, R5F10BLE, R5F10BLF, R5F10BLG, R5F10BME, R5F10BMF, R5F10BMG
RL78	R5F10PAD, R5F10PAE, R5F10PBD, R5F10PBE, R5F10PGD, R5F10PGE, R5F10PGF, R5F10PGG, R5F10PGH, R5F10PGJ, R5F10PLE, R5F10PLF, R5F10PLG, R5F10PLH, R5F10PLJ, R5F10PME, R5F10PMF, R5F10PMG, R5F10PMH, R5F10PMJ, R5F10PPE, R5F10PPF, R5F10PPG, R5F10PPH, R5F10PPJ
F15	R5F113GK, R5F113GL, R5F113LK, R5F113LL, R5F113MK, R5F113ML, R5F113PG, R5F113PH, R5F113PJ, R5F113PK, R5F113PL, R5F113TG, R5F113TH, R5F113TJ, R5F113TK, R5F113TL
F1A	R5F114GC, R5F114GD, R5F114GE, R5F114GF, R5F114GG
F1E	R5F11KLE, R5F11LLG
G10	R5F10Y14, R5F10Y16, R5F10Y17, R5F10Y44, R5F10Y46, R5F10Y47
G11	R5F1051A, R5F1054A, R5F1056A, R5F1057A, R5F1058A
G12	R5F10266, R5F10267, R5F10268, R5F10269, R5F1026A, R5F10277, R5F10278, R5F10279, R5F1027A, R5F102A7, R5F102A8, R5F102A9, R5F102AA, R5F10366, R5F10367, R5F10368, R5F10369, R5F1036A, R5F10377, R5F10378, R5F10379, R5F1037A, R5F103A7, R5F103A8, R5F103A9, R5F103AA

G13	R5F1006A, R5F1006C, R5F1006D, R5F1006E, R5F1007A, R5F1007C, R5F1007D, R5F1007E, R5F1008A, R5F1008C, R5F1008D, R5F1008E, R5F100AA, R5F100AC, R5F100AD, R5F100AE, R5F100AF, R5F100AG, R5F100BA, R5F100BC, R5F100BD, R5F100BE, R5F100BF, R5F100BG, R5F100CA, R5F100CC, R5F100CD, R5F100CE, R5F100CF, R5F100CG, R5F100EA, R5F100EC, R5F100ED, R5F100EE, R5F100EF, R5F100EG, R5F100EH, R5F100FA, R5F100FC, R5F100FD, R5F100FE, R5F100FF, R5F100FG, R5F100FH, R5F100FJ, R5F100FK, R5F100FL, R5F100GA, R5F100GC, R5F100GD, R5F100GE, R5F100GF, R5F100GG, R5F100GH, R5F100GJ, R5F100GK, R5F100GL, R5F100JC, R5F100JD, R5F100JE, R5F100JF, R5F100JG, R5F100JH, R5F100JJ, R5F100JK, R5F100JL, R5F100LC, R5F100LD, R5F100LE, R5F100LF, R5F100LG, R5F100LH, R5F100LJ, R5F100LK, R5F100LL, R5F100MF, R5F100MG, R5F100MH, R5F100MJ, R5F100MK, R5F100ML, R5F100PF, R5F100PG, R5F100PH, R5F100PJ, R5F100PK, R5F100PL, R5F100SH, R5F100SJ, R5F100SK, R5F100SL, R5F1016A, R5F1016C, R5F1016D, R5F1016E, R5F1017A, R5F1017C, R5F1017D, R5F1017E, R5F1018A, R5F1018C, R5F1018D, R5F1018E, R5F101AA, R5F101AC, R5F101AD, R5F101AE, R5F101AF, R5F101AG, R5F101BA, R5F101BC, R5F101BD, R5F101BE, R5F101BF, R5F101BG, R5F101CA, R5F101CC, R5F101CD, R5F101CE, R5F101CF, R5F101CG, R5F101EA, R5F101EC, R5F101ED, R5F101EE, R5F101EF, R5F101EG, R5F101EH, R5F101FA, R5F101FC, R5F101FD, R5F101FE, R5F101FF, R5F101FG, R5F101FH, R5F101FJ, R5F101FK, R5F101FL, R5F101GA, R5F101GC, R5F101GD, R5F101GE, R5F101GF, R5F101GG, R5F101GH, R5F101GJ, R5F101GK, R5F101GL, R5F101JC, R5F101JD, R5F101JE, R5F101JF, R5F101JG, R5F101JH, R5F101JJ, R5F101JK, R5F101JL, R5F101LC, R5F101LD, R5F101LE, R5F101LF, R5F101LG, R5F101LH, R5F101LJ, R5F101LK, R5F101LL, R5F101MF, R5F101MG, R5F101MH, R5F101MJ, R5F101MK, R5F101ML, R5F101PF, R5F101PG, R5F101PH, R5F101PJ, R5F101PK, R5F101PL, R5F101SH, R5F101SJ, R5F101SK, R5F101SL
G14	R5F104AA, R5F104AC, R5F104AD, R5F104AE, R5F104AF, R5F104AG, R5F104BA, R5F104BC, R5F104BD, R5F104BE, R5F104BF, R5F104BG, R5F104CA, R5F104CC, R5F104CD, R5F104CE, R5F104CF, R5F104CG, R5F104EA, R5F104EC, R5F104ED, R5F104EE, R5F104EF, R5F104EG, R5F104EH, R5F104FA, R5F104FC, R5F104FD, R5F104FE, R5F104FF, R5F104FG, R5F104FH, R5F104FJ, R5F104GA, R5F104GC, R5F104GD, R5F104GE, R5F104GF, R5F104GG, R5F104GH, R5F104GJ, R5F104GK, R5F104GL, R5F104JC, R5F104JD, R5F104JE, R5F104JF, R5F104JG, R5F104JH, R5F104JJ, R5F104LC, R5F104LD, R5F104LE, R5F104LF, R5F104LG, R5F104LH, R5F104LJ, R5F104LK, R5F104LL, R5F104MF, R5F104MG, R5F104MH, R5F104MJ, R5F104MK, R5F104ML, R5F104PF, R5F104PG, R5F104PH, R5F104PJ, R5F104PK, R5F104PL
G1A	R5F10E8A, R5F10E8C, R5F10E8D, R5F10E8E, R5F10E8A, R5F10E8C, R5F10EBD, R5F10EBE, R5F10EGA, R5F10EGC, R5F10EGD, R5F10EGE, R5F10ELC, R5F10ELD, R5F10ELE
G1C	R5F10JBC, R5F10JGC, R5F10KBC, R5F10KGC
G1D	R5F11AGG, R5F11AGH, R5F11AGJ
G1E	R5F10FLC, R5F10FLD, R5F10FLE, R5F10FMC, R5F10FMD, R5F10FME
G1F	R5F11B7C, R5F11B7E, R5F11BBC, R5F11BBE, R5F11BCC, R5F11BCE, R5F11BGC, R5F11BGE, R5F11BLC, R5F11BLE

	G1G	R5F11EA8, R5F11EAA, R5F11EB8, R5F11EBA, R5F11EF8, R5F11EFA
	G1H	R5F11FLJ, R5F11FLK, R5F11FLL
	H1D	R5F11NGF, R5F11NGG, R5F11NLF, R5F11NLG, R5F11NME, R5F11NMF, R5F11NMG, R5F11PLF, R5F11PLG, R5F11RMG
	I1A	R5F1076C, R5F107AC, R5F107AE, R5F107DE
	I1B	R5F10MME, R5F10MMG, R5F10MPE, R5F10MPG
	I1C	R5F10NLE, R5F10NLG, R5F10NME, R5F10NMG, R5F10NMJ, R5F10NPG, R5F10NPJ
	I1D	R5F11768, R5F1176A, R5F11778, R5F1177A, R5F117A8, R5F117AA, R5F117AC, R5F117BA, R5F117BC, R5F117GA, R5F117GC
	I1E	R5F11CBC, R5F11CCC
	L12	R5F10RB8, R5F10RBA, R5F10RBC, R5F10RF8, R5F10RFA, R5F10RFC, R5F10RG8, R5F10RGA, R5F10RGC, R5F10RJ8, R5F10RJA, R5F10RJC, R5F10RLA, R5F10RLC
	L13	R5F10WLA, R5F10WLC, R5F10WLD, R5F10WLE, R5F10WLF, R5F10WLG, R5F10WMA, R5F10WMC, R5F10WMD, R5F10WME, R5F10WMF, R5F10WMG
	L1A	R5F11MMD, R5F11MME, R5F11MMF, R5F11MPE, R5F11MPF, R5F11MPG
	L1C	R5F110ME, R5F110MF, R5F110MG, R5F110MH, R5F110MJ, R5F110NE, R5F110NF, R5F110NG, R5F110NH, R5F110NJ, R5F110PE, R5F110PF, R5F110PG, R5F110PH, R5F110PJ, R5F111ME, R5F111MF, R5F111MG, R5F111MH, R5F111MJ, R5F111NE, R5F111NF, R5F111NG, R5F111NH, R5F111NJ, R5F111PE, R5F111PF, R5F111PG, R5F111PH, R5F111PJ
	110	R5F51101, R5F51103, R5F51104, R5F51105, R5F5110H, R5F5110J
	111	R5F51111, R5F51113, R5F51114, R5F51115, R5F51116, R5F51117, R5F51118, R5F5111J
	113	R5F51135, R5F51136, R5F51137, R5F51138
	130	R5F51303, R5F51305, R5F51305B, R5F51306, R5F51306B, R5F51307, R5F51308
	210	R5F52103, R5F52104, R5F52105, R5F52106, R5F52107, R5F52108, R5F5210A, R5F5210B
	21A	R5F521A6, R5F521A7, R5F521A8
	220	R5F52201, R5F52203, R5F52205, R5F52206
RX	230	R5F52305, R5F52306
	231	R5F52315, R5F52316, R5F52317, R5F52318
	23T	R5F523T3, R5F523T5
	24T	R5F524T8, R5F524TA, R5F524TB, R5F524TC, R5F524TE
	24U	R5F524UB, R5F524UC, R5F524UE
	610	R5F56104, R5F56106, R5F56107, R5F56108
	621	R5F56216, R5F56217, R5F56218
	62G	R5F562G7, R5F562GA
	62N	R5F562N7, R5F562N8
	62T	R5F562T6, R5F562T7, R5F562TA
	630	R5F56307, R5F56308, R5F5630A, R5F5630B, R5F5630D, R5F5630E

		R5F56316, R5F56317, R5F56318, R5F5631A, R5F5631B, R5F5631D, R5F5631E, R5F5631F, R5F5631G, R5F5631J, R5F5631K, R5F5631M, R5F5631MF, R5F5631N, R5F5631P, R5F5631PF, R5F5631W, R5F5631Y, R5S56310
	634	R5F5634B, R5F5634B_5V, R5F5634D, R5F5634D_5V, R5F5634E, R5F5634E_5V
	63N	R5F563NA, R5F563NB, R5F563ND, R5F563NE, R5F563NF, R5F563NK, R5F563NW, R5F563NY
	63T	R5F563T4, R5F563T5, R5F563T6, R5F563TB, R5F563TB_5V, R5F563TC, R5F563TC_5V, R5F563TE, R5F563TE_5V
	64M	R5F564MF, R5F564MG, R5F564MJ, R5F564ML
	651	R5F56514, R5F56517, R5F56519, R5F5651C, R5F5651C_DUAL, R5F5651E, R5F5651E_DUAL R5F56519DMB, R5F5651EDMB, R5F5651EDMB_DUAL,(Debug Support Only)
	65N	R5F565N4, R5F565N7, R5F565N9, R5F565NC, R5F565NC_DUAL, R5F565NE, R5F565NE_DUAL R5F565N9DMB, R5F565NEDMB, R5F565NEDMB_DUAL,(Debug Support Only)
	66T	R5F566TA, R5F566TE
	71M	R5F571MF, R5F571MG, R5F571MJ, R5F571ML
	A1	R7S721000, R7S721000_DualSPI, R7S721001, R7S721001_DualSPI, R7S721010, R7S721010_DualSPI, R7S721011, R7S721011_DualSPI, R7S721020, R7S721020_DualSPI, R7S721021, R7S721021_DualSPI, R7S721030, R7S721030_DualSPI, R7S721031, R7S721031_DualSPI, R7S721034, R7S721034_DualSPI
	A2	R7S921040, R7S921041, R7S921042, R7S921043, R7S921045, R7S921046, R7S921047, R7S921048, R7S921051, R7S921052, R7S921053, R7S921056, R7S921057, R7S921058
	G1C	R8A77470
	G1E	R8A77450 R8A77450_Core1,(Debug Support Only)
RZ	G1H	R8A77420
	G1M	R8A77430 R8A77430_Core1,(Debug Support Only)
	G1N	R8A77440
	T1	R7S910001, R7S910002, R7S910006, R7S910007, R7S910011, R7S910013, R7S910015, R7S910015_M3, R7S910016, R7S910016_M3, R7S910017, R7S910017_M3, R7S910018, R7S910018_M3, R7S910025, R7S910026, R7S910027, R7S910028, R7S910035, R7S910036, R7S910101, R7S910102, R7S910106, R7S910107, R7S910111, R7S910113, R7S910115, R7S910115_M3, R7S910116, R7S910116_M3, R7S910117, R7S910117_M3, R7S910118, R7S910118_M3, R7S910125, R7S910126, R7S910127, R7S910128, R7S910135, R7S910136
Synergy	S1JA	R7FS1JA783A01CFM, R7FS1JA783A01CNE, R7FS1JA783A01CNF, R7FS1JA782A01CBT, R7FS1JA783A01CFJ

S124	R7FS124762A01CLM, R7FS124763A01CFL, R7FS124763A01CFM, R7FS124772A01CLM, R7FS124773A01CFL, R7FS124773A01CFM, R7FS124773A01CNB, R7FS124773A01CNE, R7FS124773A01CNF
S128	R7FS128782A01CLM, R7FS128783A01CFJ, R7FS128783A01CFL, R7FS128783A01CFM, R7FS128783A01CNE, R7FS128783A01CNG
S3A1	R7FS3A17C2A01CLK, R7FS3A17C3A01CFB, R7FS3A17C2A01CBJ, R7FS3A17C2A01CLJ, R7FS3A17C3A01CFM, R7FS3A17C3A01CFP, R7FS3A17C3A01CNB
S3A3	R7FS3A37A2A01CLK, R7FS3A37A3A01CFB, R7FS3A37A2A01CBJ, R7FS3A37A2A01CLJ, R7FS3A37A3A01CFP, R7FS3A37A3A01CFM, R7FS3A37A3A01CNB
S3A6	R7FS3A6782A01CLJ, R7FS3A6783A01CFL, R7FS3A6783A01CFM, R7FS3A6783A01CFP, R7FS3A6783A01CNB, R7FS3A6783A01CNE, R7FS3A6783A01CNF
S3A7	R7FS3A77C2A01CLK, R7FS3A77C3A01CFB, R7FS3A77C2A01CBJ, R7FS3A77C3A01CFP, R7FS3A77C2A01CLJ, R7FS3A77C3A01CFM, R7FS3A77C2A01CNB, R7FS3A77C3A01CNB
S5D5	R7FS5D57A2A01CLK, R7FS5D57A3A01CFB, R7FS5D57A3A01CFP, R7FS5D57C2A01CLK, R7FS5D57C3A01CFB, R7FS5D57C3A01CFP
S5D9	R7FS5D97C2A01CBG, R7FS5D97C3A01CFC, R7FS5D97C2A01CLK, R7FS5D97C3A01CFB, R7FS5D97C3A01CFP, R7FS5D97E2A01CBG, R7FS5D97E3A01CFC, R7FS5D97E2A01CLK, R7FS5D97E3A01CFB, R7FS5D97E3A01CFP
S7G2	R7FS7G27H2A01CBD, R7FS7G27G2A01CBD, R7FS7G27H2A01CBG, R7FS7G27G2A01CBG, R7FS7G27H2A01CFC, R7FS7G27H3A01CFC, R7FS7G27G2A01CFC, R7FS7G27G3A01CFC, R7FS7G27H2A01CLK, R7FS7G27G2A01CLK, R7FS7G27H3A01CFB, R7FS7G27G3A01CFB, R7FS7G27G3A01CFP

2.2 Code Generator & Smart Configurator Support

CPU	Family	Devices
RL78	D1A	R5F10CGB, R5F10CGC, R5F10CGD, R5F10CLD, R5F10CMD, R5F10CME, R5F10DGC, R5F10DGD, R5F10DGE, R5F10DLD, R5F10DLE, R5F10DMD, R5F10DME, R5F10DMF, R5F10DMG, R5F10DMJ, R5F10DPE, R5F10DPF, R5F10DPG, R5F10DPJ, R5F10TPJ
	F12	R5F10968, R5F1096A, R5F1096B, R5F1096C, R5F1096D, R5F1096E, R5F109AA, R5F109AB, R5F109AC, R5F109AD, R5F109AE, R5F109BA, R5F109BB, R5F109BC, R5F109BD, R5F109BE, R5F109GA, R5F109GB, R5F109GC, R5F109GD, R5F109GE, R5F109LA, R5F109LB, R5F109LC, R5F109LD, R5F109LE
	F13	R5F10A6A, R5F10A6C, R5F10A6D, R5F10A6E, R5F10AAA, R5F10AAC, R5F10AAD, R5F10AAE, R5F10ABA, R5F10ABC, R5F10ABD, R5F10ABE, R5F10AGA, R5F10AGC, R5F10AGD, R5F10AGE, R5F10AGF, R5F10AGG, R5F10ALC, R5F10ALD, R5F10ALE, R5F10ALF, R5F10ALG, R5F10AME, R5F10AMF, R5F10AMG, R5F10BAC, R5F10BAD, R5F10BAE, R5F10BAF, R5F10BAG, R5F10BBC, R5F10BBD, R5F10BBE, R5F10BBF, R5F10BBG, R5F10BGC, R5F10BGD, R5F10BGE, R5F10BGF, R5F10BGG, R5F10BLC, R5F10BLD, R5F10BLE, R5F10BLF, R5F10BLG, R5F10BME, R5F10BMF, R5F10BMG
	F14	R5F10PAD, R5F10PAE, R5F10PBD, R5F10PBE, R5F10PGD, R5F10PGE, R5F10PGF, R5F10PGG, R5F10PGH, R5F10PGJ, R5F10PLE, R5F10PLF, R5F10PLG, R5F10PLH, R5F10PLJ, R5F10PME, R5F10PMF, R5F10PMG, R5F10PMH, R5F10PMJ, R5F10PPE, R5F10PPF, R5F10PPG, R5F10PPH, R5F10PPJ
	F15	R5F113GK, R5F113GL, R5F113LK, R5F113LL, R5F113MK, R5F113ML, R5F113PG, R5F113PH, R5F113PJ, R5F113PK, R5F113PL, R5F113TG, R5F113TH, R5F113TJ, R5F113TK, R5F113TL
	F1E	R5F11KLE, R5F11LLG
	G10	R5F10Y14, R5F10Y16, R5F10Y17, R5F10Y44, R5F10Y46, R5F10Y47
	G11	R5F1051A, R5F1054A, R5F1056A, R5F1057A, R5F1058A
	G12	R5F10266, R5F10267, R5F10268, R5F10269, R5F1026A, R5F10277, R5F10278, R5F10279, R5F1027A, R5F102A7, R5F102A8, R5F102A9, R5F102AA, R5F10366, R5F10367, R5F10368, R5F10369, R5F1036A, R5F10377, R5F10378, R5F10379, R5F1037A, R5F103A7, R5F103A8, R5F103A9, R5F103AA

G13	R5F1006A, R5F1006C, R5F1006D, R5F1006E, R5F1007A, R5F1007C, R5F1007D, R5F1007E, R5F1008A, R5F1008C, R5F1008D, R5F1008E, R5F100AA, R5F100AC, R5F100AD, R5F100AE, R5F100AF, R5F100AG, R5F100BA, R5F100BC, R5F100BD, R5F100BE, R5F100BF, R5F100BG, R5F100CA, R5F100CC, R5F100CD, R5F100CE, R5F100CF, R5F100CG, R5F100EA, R5F100EC, R5F100ED, R5F100EE, R5F100EF, R5F100EG, R5F100EH, R5F100FA, R5F100FC, R5F100FD, R5F100FE, R5F100FF, R5F100FG, R5F100FH, R5F100FJ, R5F100FK, R5F100FL, R5F100GA, R5F100GC, R5F100GD, R5F100GE, R5F100GF, R5F100GG, R5F100GH, R5F100GJ, R5F100GK, R5F100GL, R5F100JC, R5F100JD, R5F100JE, R5F100JF, R5F100JG, R5F100JH, R5F100JJ, R5F100JK, R5F100JL, R5F100LC, R5F100LD, R5F100LE, R5F100LF, R5F100LG, R5F100LH, R5F100LJ, R5F100LK, R5F100LL, R5F100MF, R5F100MG, R5F100MH, R5F100MJ, R5F100MK, R5F100ML, R5F100PF, R5F100PG, R5F100PH, R5F100PJ, R5F100PK, R5F100PL, R5F100SH, R5F100SJ, R5F100SK, R5F100SL, R5F1016A, R5F1016C, R5F1016D, R5F1016E, R5F1017A, R5F1017C, R5F1017D, R5F1017E, R5F1018A, R5F1018C, R5F1018D, R5F1018E, R5F101AA, R5F101AC, R5F101AD, R5F101AE, R5F101AF, R5F101AG, R5F101BA, R5F101BC, R5F101BD, R5F101BE, R5F101BF, R5F101BG, R5F101CA, R5F101CC, R5F101CD, R5F101CE, R5F101CF, R5F101CG, R5F101EA, R5F101EC, R5F101ED, R5F101EE, R5F101EF, R5F101EG, R5F101EH, R5F101FA, R5F101FC, R5F101FD, R5F101FE, R5F101FF, R5F101FG, R5F101FH, R5F101FJ, R5F101FK, R5F101FL, R5F101GA, R5F101GC, R5F101GD, R5F101GE, R5F101GF, R5F101GG, R5F101GH, R5F101GJ, R5F101GK, R5F101GL, R5F101JC, R5F101JD, R5F101JE, R5F101JF, R5F101JG, R5F101JH, R5F101JJ, R5F101JK, R5F101JL, R5F101LC, R5F101LD, R5F101LE, R5F101LF, R5F101LG, R5F101LH, R5F101LJ, R5F101LK, R5F101LL, R5F101MF, R5F101MG, R5F101MH, R5F101MJ, R5F101MK, R5F101ML, R5F101PF, R5F101PG, R5F101PH, R5F101PJ, R5F101PK, R5F101PL, R5F101SH, R5F101SJ, R5F101SK, R5F101SL
G14	R5F104AA, R5F104AC, R5F104AD, R5F104AE, R5F104AF, R5F104AG, R5F104BA, R5F104BC, R5F104BD, R5F104BE, R5F104BF, R5F104BG, R5F104CA, R5F104CC, R5F104CD, R5F104CE, R5F104CF, R5F104CG, R5F104EA, R5F104EC, R5F104ED, R5F104EE, R5F104EF, R5F104EG, R5F104EH, R5F104FA, R5F104FC, R5F104FD, R5F104FE, R5F104FF, R5F104FG, R5F104FH, R5F104FJ, R5F104GA, R5F104GC, R5F104GD, R5F104GE, R5F104GF, R5F104GG, R5F104GH, R5F104GJ, R5F104GK, R5F104GL, R5F104JC, R5F104JD, R5F104JE, R5F104JF, R5F104JG, R5F104JH, R5F104JJ, R5F104LC, R5F104LD, R5F104LE, R5F104LF, R5F104LG, R5F104LH, R5F104LJ, R5F104LK, R5F104LL, R5F104MF, R5F104MG, R5F104MH, R5F104MJ, R5F104MK, R5F104ML, R5F104PF, R5F104PG, R5F104PH, R5F104PJ, R5F104PK, R5F104PL
G1A	R5F10E8A, R5F10E8C, R5F10E8D, R5F10E8E, R5F10E8A, R5F10EBC, R5F10EBD, R5F10EBE, R5F10EGA, R5F10EGC, R5F10EGD, R5F10EGE, R5F10ELC, R5F10ELD, R5F10ELE
G1C	R5F10JBC, R5F10JGC, R5F10KBC, R5F10KGC
G1D	R5F11AGG, R5F11AGH, R5F11AGJ
G1E	R5F10FLC, R5F10FLD, R5F10FLE, R5F10FMC, R5F10FMD, R5F10FME
G1F	R5F11B7C, R5F11B7E, R5F11BBC, R5F11BBE, R5F11BCC, R5F11BCE, R5F11BGC, R5F11BGE, R5F11BLC, R5F11BLE
G1G	R5F11EA8, R5F11EAA, R5F11EB8, R5F11EBA, R5F11EF8, R5F11EFA
G1H	R5F11FLJ, R5F11FLK, R5F11FLL
H1D	R5F11NGF, R5F11NGG, R5F11NLF, R5F11NLG, R5F11NME, R5F11NMF, R5F11NMG, R5F11PLF, R5F11PLG, R5F11RMG
I1A	R5F1076C, R5F107AC, R5F107AE, R5F107DE

	I1B	R5F10MME, R5F10MMG, R5F10MPE, R5F10MPG
	I1C	R5F10NLE, R5F10NLG, R5F10NME, R5F10NMG, R5F10NMJ, R5F10NPJ
	I1D	R5F11768, R5F1176A, R5F11778, R5F1177A, R5F117A8, R5F117AA, R5F117AC, R5F117BA, R5F117BC, R5F117GA, R5F117GC
	I1E	R5F11CBC, R5F11CCC
	L12	R5F10RB8, R5F10RBA, R5F10RBC, R5F10RF8, R5F10RFA, R5F10RFC, R5F10RG8, R5F10RGA, R5F10RGC, R5F10RJ8, R5F10RJA, R5F10RJC, R5F10RLA, R5F10RLC
	L13	R5F10WLA, R5F10WLC, R5F10WLD, R5F10WLE, R5F10WLF, R5F10WLG, R5F10WMA, R5F10WMC, R5F10WMD, R5F10WME, R5F10WMF, R5F10WMG
	L1A	R5F11MMD, R5F11MME, R5F11MMF, R5F11MPE, R5F11MPF, R5F11MPG
	L1C	R5F110ME, R5F110MF, R5F110MG, R5F110MH, R5F110MJ, R5F110PE, R5F110PF, R5F110PG, R5F110PH, R5F110PJ, R5F111ME, R5F111MF, R5F111MG, R5F111MH, R5F111MJ, R5F111PE, R5F111PF, R5F111PG, R5F111PH, R5F111PJ
	110	R5F51101, R5F51103, R5F51104, R5F51105, R5F5110H, R5F5110J
	111	R5F51111, R5F51113, R5F51114, R5F51115, R5F51116, R5F51117, R5F51118, R5F5111J
	113	R5F51135, R5F51136, R5F51137, R5F51138
	130	R5F51303, R5F51305
	230	R5F52305, R5F52306
	231	R5F52315, R5F52316, R5F52317, R5F52318
RX	23T	R5F523T3, R5F523T5
	24T	R5F524T8, R5F524TA, R5F524TB, R5F524TC, R5F524TE
	24U	R5F524UB, R5F524UC, R5F524UE
	64M	R5F564MF, R5F564MG, R5F564MJ, R5F564ML
	651	R5F56514, R5F56517, R5F56519
	65N	R5F565N4, R5F565N7, R5F565N9
	66T	R5F566TA, R5F566TE
	71M	R5F571MF, R5F571MG, R5F571MJ, R5F571ML
RZ	T1	R7S910001, R7S910002, R7S910006, R7S910007, R7S910011, R7S910013, R7S910015, R7S910016, R7S910017, R7S910018, R7S910025, R7S910026, R7S910027, R7S910028, R7S910035, R7S910036, R7S910101, R7S910102, R7S910106, R7S910107, R7S910111, R7S910113, R7S910115, R7S910116, R7S910117, R7S910118, R7S910125, R7S910126, R7S910127, R7S910128, R7S910135, R7S910136

3. Smart Manual Support

Smart manual support is delivered independently of e² studio releases when available. The following devices are available as of January 2019:

- RX62G
- RX62T
- RX63N
- RX63T
- RX64M
- RX71M
- RX110
- RX111
- RX113
- RX210
- RX220
- RX631
- RX651
- RX65N
- RX24U
- RX24T
- RX66T
- RL78/L12
- RL78/L13
- RL78/G14
- RL78/G13
- RL78/G12
- RL78/G11
- RL78/G10
- RL78/G1F
- RZ/A2M

4. What is new in 7.3.0?

Component	Device	Description
Smart Configurator	RZ	<p>The download and import RZ/A2M peripheral drivers and middleware to e2 studio project is now supported in the Smart Configurator for RZ/A2M.</p> <p>The middleware and driver included in the RZ/A2M Software Core Package can be downloaded and imported easily using Smart Configurator.</p> <p>For details, refer to the help topic “Smart Configurator for RZ/A2M” linked from [Help]->[Help Contents] menu in e2 studio.</p>

The Memory Usage view has been updated to include the device memories of selected project’s device.

Memory areas of device are shown on the view with their corresponding information bar and sections which belong to each memory area.

The color of each section corresponds to the memory group classification.

The color of each group is shown on Group Size region pane of the view.

For details, refer to Device Memory Usage part in the Memory Usage help.

Memory Usage plugin

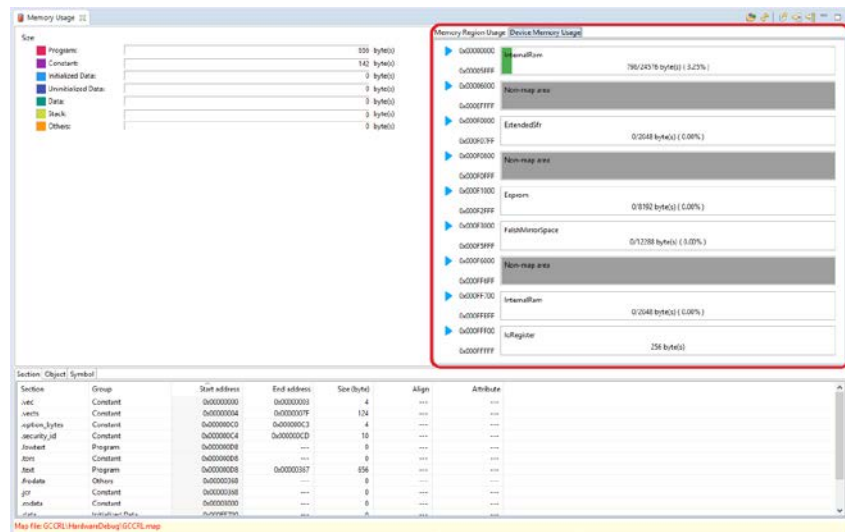

New devices added for RH850:

Device Support
RH850

- R7F701442, R7F701462
- RH850/E1M-S2
- R7F701215, R7F701216

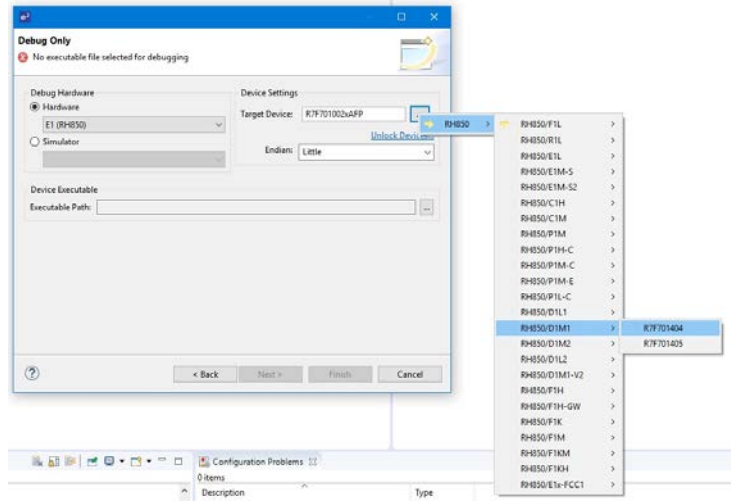

The "Raw" registers format has been added to the Registers view "Number Format" menu item. This new selection can be used to show the raw value of the floating-point registers.

CDT

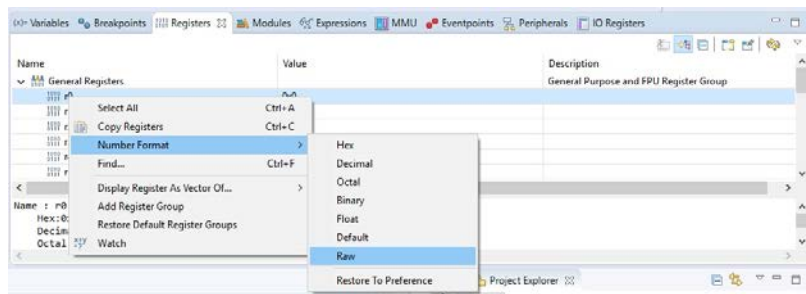

The Page Table display in the MMU view has been improved to display not only value but also value's meaning.

The view now also displays more information:

MMU View

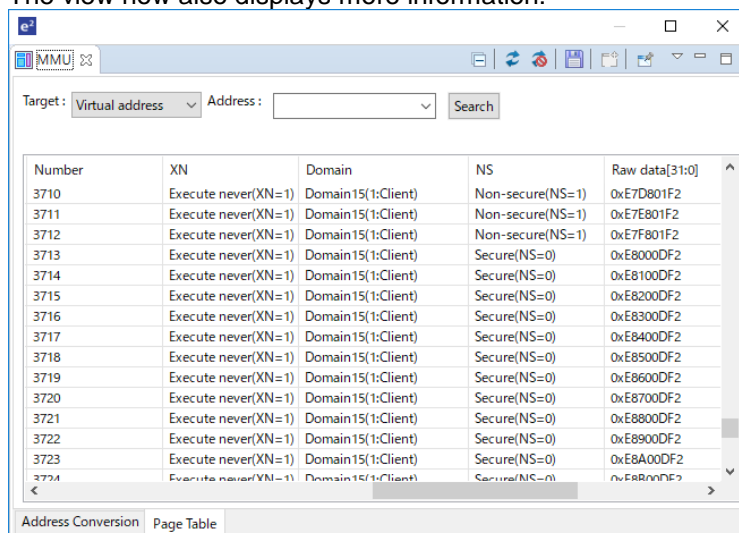

Improve point is following table.

Column Name	Improvement
Domain	Add corresponding DACR register's value's meaning.
S,NS,XN,NG,AP[2:0]	Add value's meaning.
Raw data[31:0]	Add this column for page table entry 32bit descriptor's raw data.

The MMU view has been updated to allow the customization of saved MMU settings.

MMU View

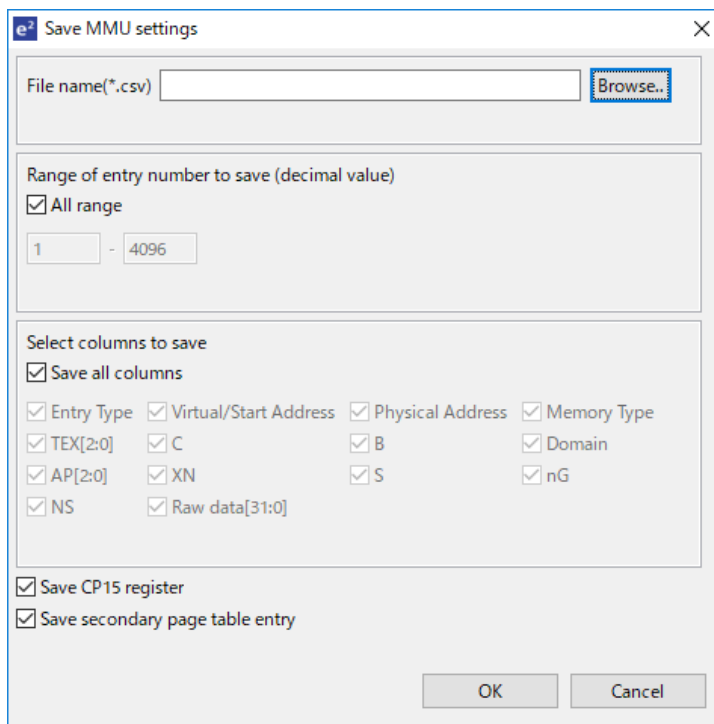

Setting items are as follows:

- What range of entries to save.
- What page table's columns to save.
- Whether we save the CP15 register or not.
- Whether we save secondary page table entries.

Debugging RX,
Project
Generation
CCRX

e2 studio 7.3 has improved I/O library support to work with both the RX hardware and simulator debugger configurations.

Improvement points:

- + Changed "Use I/O library" label to "Use Renesas Debug Virtual Console" label

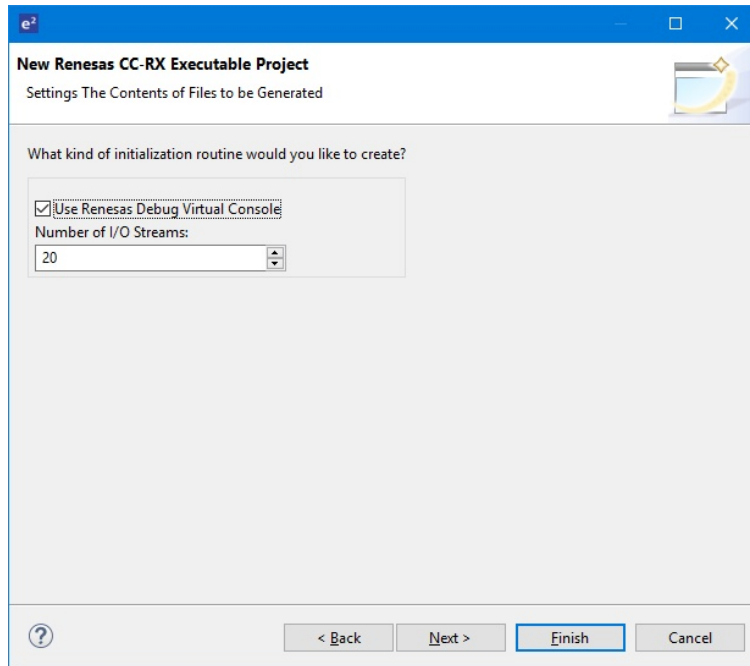

- + Corrected resetprg.c file for C/C++ projects
- + Excluded "lowlvl.src" and "lowsrc.c" on Release configuration
- + Specified "-define=DEBUG_CONSOLE" on HardwareDebug and Debug configuration

These changes will enable the Renesas debug Virtual Console to be used more effectively within e2 studio for all RX debugger configurations.

Download and import sample projects of FIT modules to the e2 studio project workspace is now supported in the Smart Configurator.

Software component configuration

Smart Configurator

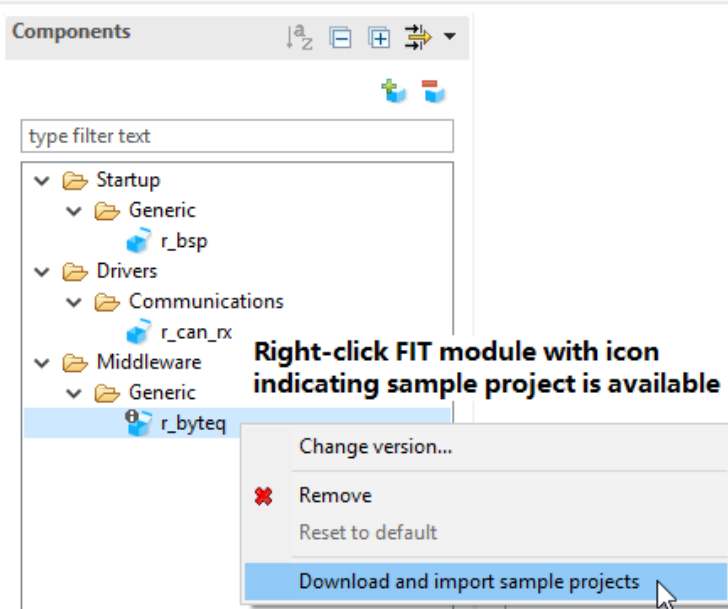

Changing the version of r_bsp and FIT modules that have been added to the Smart Configurator project is now also supported in Smart Configurator.

Software component configuration

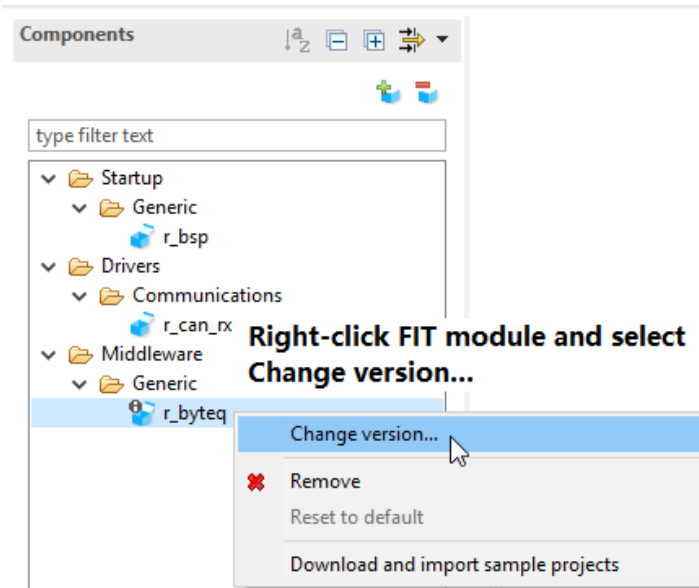

Libhover

Currently the libhover functionality for Smart Manual Software only invokes for calls through function pointer struct members (e.g. typical Synergy API function calls) and is only activated if the code looks like a function call.

Activates: `g_sf_i2c_device0.p_api->open()`

Does not activate: `g_sf_i2c_device0.p_api->open`

This has been improved to now activate on non-dereferenced function prototypes.

GDB server

Information of some modules relating to debugger is now displayed in gdbserver console at launching stage, includes:

- Version of firmware files and FPGA
- Emulator type, revision and voltage
Available now for RX, RL78 and RH850.

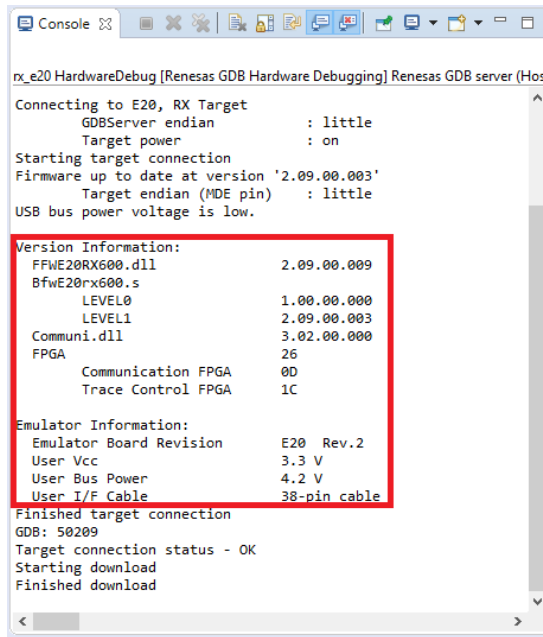

Debug Console plugin

The Debug Console view can have the pin button set to “on”, this brings the console to the front if there are standard input/output changes in the console.

For details, refer to "RenesasDebug Virtual Console operations" section in "Renesas Debug Virtual Console" help.



Smart Configurator

The Smart Configurator has been updated to support RX23T, RX24T, RX24U group devices.

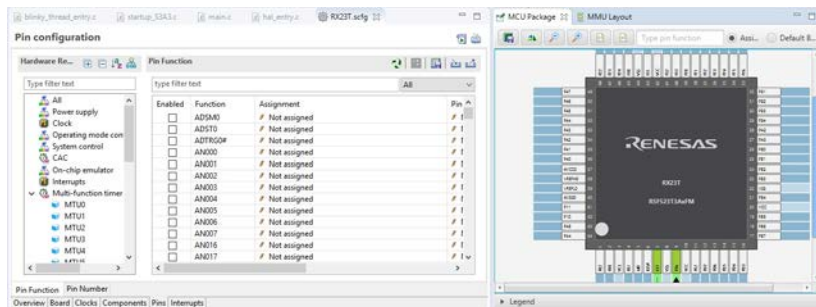

Smart Browser

You can select the message categories that you want to receive the notification. If the checkbox of a category is unchecked, you will not receive new message of that category.

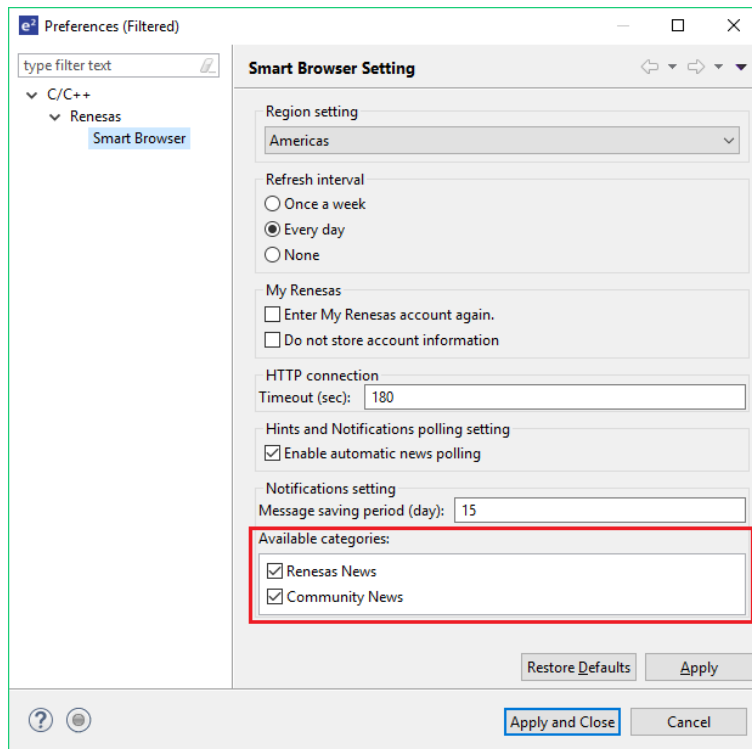

When using multicore debug, it is now possible to filter the breakpoint for core automatically. This is achieved by the following toolbar button on the Breakpoints view.

Application

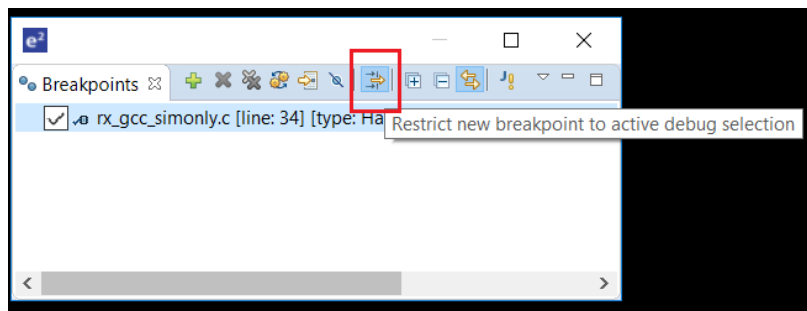

After pressing this button, it will lock the breakpoints to only be sent to the active debugger session.

Debug Configuration

A GUI has implemented for editing the IO Register settings.

It has been made more convenient, so you can modify within the user interface directly.

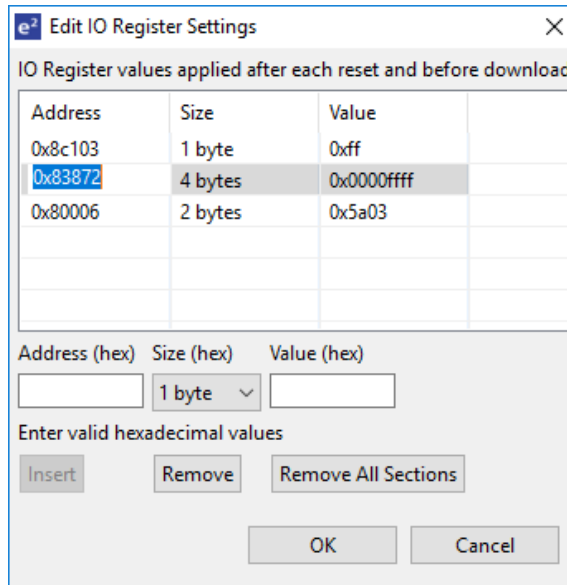

FreeRTOS project is supported for specific RX devices.

If user does not download FreeRTOS package into local PC yet, the e2 studio project generator can download the FreeRTOS package from the Renesas website in the same way as FIT module downloads.

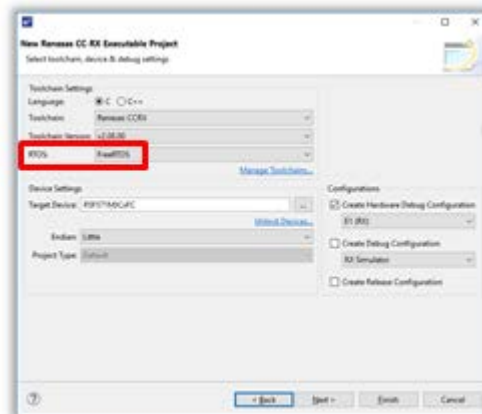

Smart Configurator RX

Smart Configurator also supports FreeRTOS kernel configuration.

You can the configure FreeRTOS kernel within the user interface and then the Smart Configurator can generate the FreeRTOS kernel settings header file automatically.

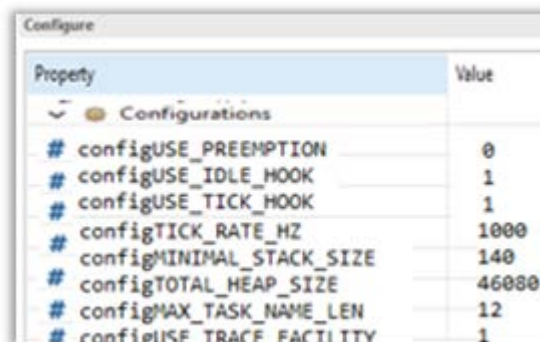

5. What is new in 7.2.0?

Component	Device	Description
RX Device Support	RX	Support has been added for the RX66T device. This includes support for the Smart Configurator.

6. What is new in 7.1.0?

Component	Device	Description
RZ/A2	RZ	The RZ/A2 device family is now supported in e2 studio.

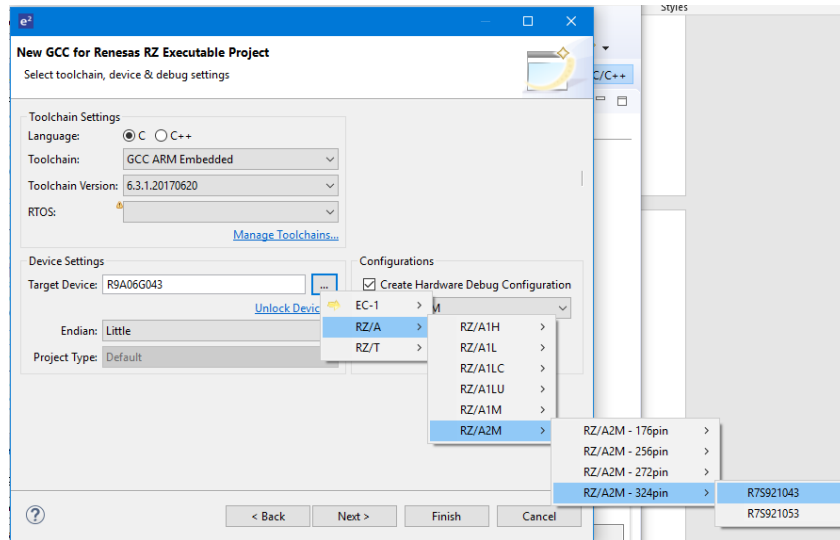

RZ/A2 Smart Configurator Support	RZ	<p>The Smart Configurator now supports RZ/A2M group devices. Peripheral drives for RZ/A2M can be configured by the following functions.</p> <p>Basic Driver Settings: The drivers for clocks, pins and memory management unit (MMU) that are a basic part of embedded software for RZ/A2M group devices can be configured within the Smart Configurator.</p> <p>The settings are configured using a dedicated user interface and the configuration when generated is reflected in your project's source code.</p>
----------------------------------	----	---

Clock Configuration Panel

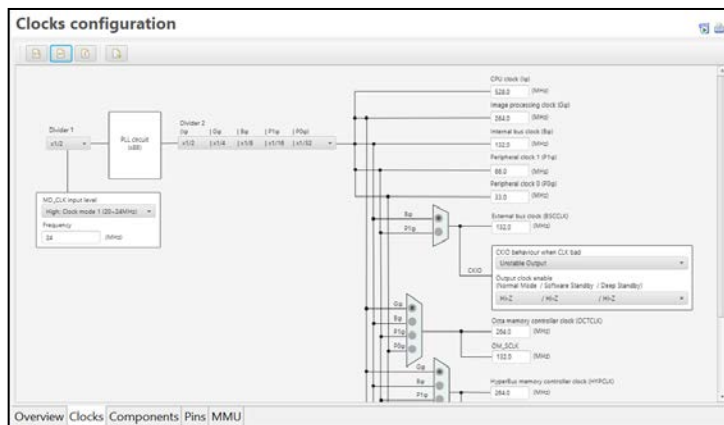

Pin Configuration Panel

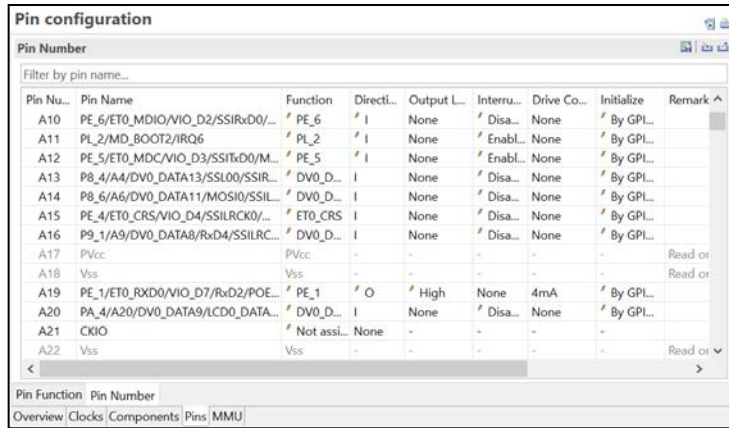

MMU Configuration Panel

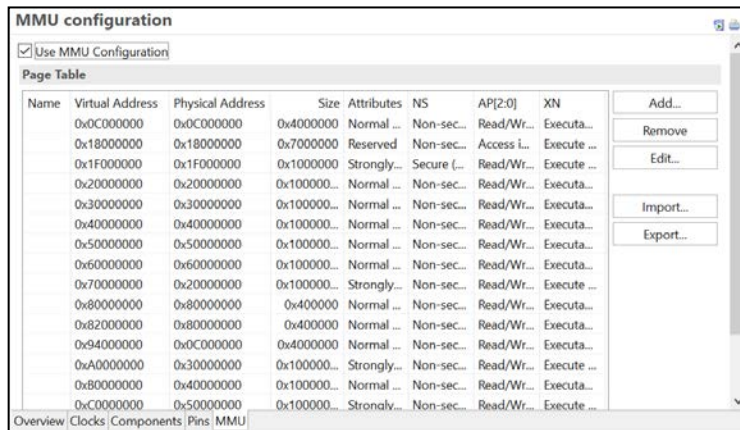

Software Component Settings: The drivers for peripheral functions that are used in sample programs can be configured on the smart configurator.

The available configuration depends on each specific driver and the configuration when generated is reflected in your project's source code.

Software Component Configuration Panel (Example: SCIFA driver)

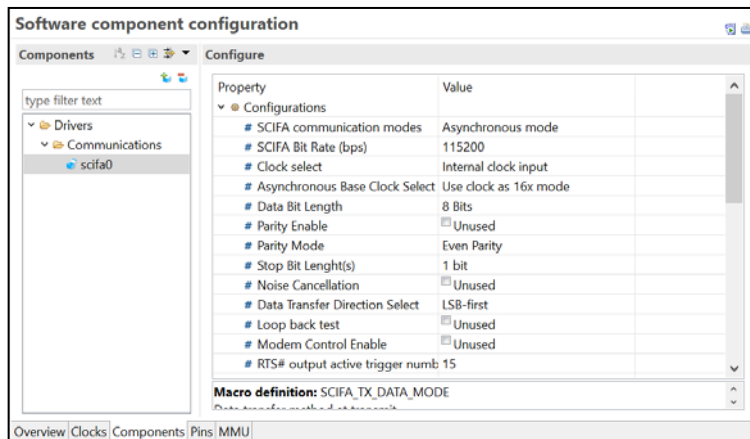

RZ/A1 and RZ/A2 both support a memory management unit (MMU) which needs special debugging support. When using MMU, it is necessary to prepare a page table in the memory in addition to setting the MMU register.

The page table for MMU of RZ/A1 and RZ/A2 is composed of a combination of a primary table and a secondary table. In each page table entry, it is necessary to make the following setting.

- Physical address corresponding to the virtual address
- Enable/disable of data cache and cache operation (write back, write through, etc)
- Specification of memory type (normal memory, device memory, strong reorder memory)
- Access permission (permission to read / write in privileged mode / non-privileged mode)

To support this feature of the RZ/A1 and RZ/A2 devices a new plugin has been added to e2 studio named the MMU view.

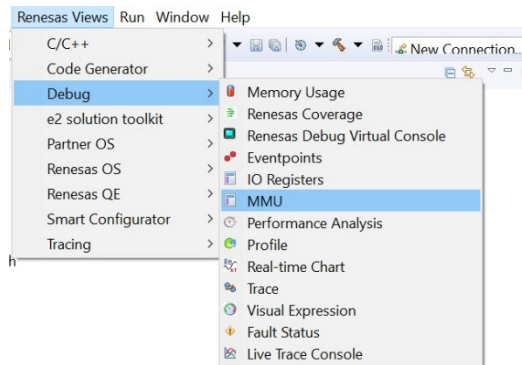

The view is accessible from the [Renesas Views->Debug->MMU] menu item.

The image shows a screenshot of the MMU view interface. At the top, there is a dropdown menu set to 'From physical to virtual' and an 'Address' field containing '0x400'. Below this is a 'Conversion result' line with a list of addresses. The main part of the screenshot is a table with the following columns: Number, Entry Type, Virtual/Start Address, Physical Address, Memory Type, TEX[2:0], C, B, Domain, AP[2:0], XN, S, nG, and NS. The table contains several rows of data, including entries for 'Small Page' and 'Page Table' with various addresses and settings.

Number	Entry Type	Virtual/Start Address	Physical Address	Memory Type	TEX[2:0]	C	B	Domain	AP[2:0]	XN	S	nG	NS
921_1	Small Page	0x99800000	0x00000000	Strongly Order	000	0	0	-	000	0	0	0	-
931	Page Table	0x20037000	-	-	-	-	-	0	-	-	-	-	0
931_1	Small Page	0x2A200000	0x00000000	Strongly Order	000	0	0	-	000	0	0	0	-
941	Page Table	0x20038000	-	-	-	-	-	0	-	-	-	-	0
941_1	Small Page	0x3AC00000	0x00000000	Strongly Order	000	0	0	-	000	0	0	0	-
951	Page Table	0x20039000	-	-	-	-	-	0	-	-	-	-	0
951_1	Small Page	0x3B500000	0x00000000	Strongly Order	000	0	0	-	000	0	0	0	-
961	Page Table	0x2003A000	-	-	-	-	-	0	-	-	-	-	0
961_1	Small Page	0x2C000000	0x00000000	Strongly Order	000	0	0	-	000	0	0	0	-
971	Page Table	0x2003B000	-	-	-	-	-	0	-	-	-	-	0
971_1	Small Page	0x3CA00000	0x00000000	Strongly Order	000	0	0	-	000	0	0	0	-
981	Page Table	0x20037000	-	-	-	-	-	0	-	-	-	-	0
981_1	Small Page	0x3D400000	0x00000000	Strongly Order	000	0	0	-	000	0	0	0	-
991	Page Table	0x20038000	-	-	-	-	-	0	-	-	-	-	0
991_1	Small Page	0x3DF00000	0x00000000	Strongly Order	000	0	0	-	000	0	0	0	-
1001	Page Table	0x20039000	-	-	-	-	-	0	-	-	-	-	0
1001_1	Small Page	0x3E800000	0x00000000	Strongly Order	000	0	0	-	000	0	0	0	-
1007	Section	0x3E800000	0x00000000	Strongly Order	000	0	0	0	000	0	0	0	0
2031	Section	0x7EE00000	0x00000000	Strongly Order	000	0	0	0	000	0	0	0	0
3055	Section	0xBEE00000	0x00000000	Strongly Order	000	0	0	0	000	0	0	0	0

This view is intended to allow easy confirmation of the MMU IOR setting value. It also offers functionality to convert from logical addresses to physical addresses.

Run Break
Timer All

A new feature has been added to the e2 studio that enables you to understand the last execution performance.

This offers a fast way to automatically see the last execution performance timing in the e2 studio status bar.

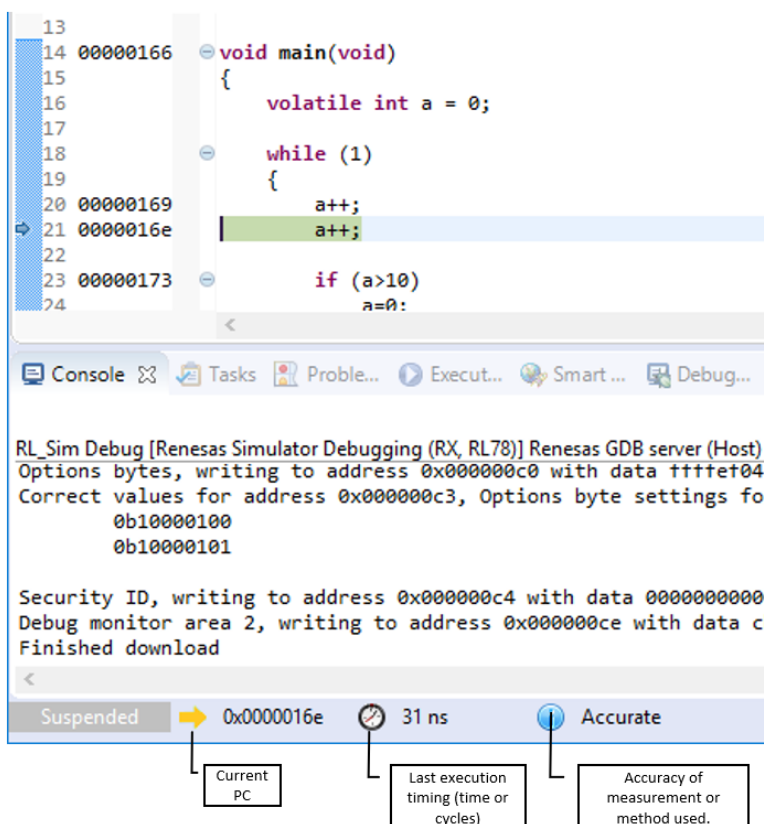

The view shows the current program counter (PC), the last execution timing either in time or CPU cycles and the accuracy or measurement method used.

Most devices and emulator combinations are supported to differing levels. Please see the table below:

Device	Debugger	Support
RX	Simulator	Not supported
	E1/E20/E2/E2 LITE	Emulator is used to read the total time measurement counter (Hardware support)
	EZ/J-Link	System Time
RH850	E1	Debug Clock (CPU clock is used if the Debug Clock is 0)
Synergy S1 Series (Cortex M0/M0+)	J-Link	System Time
Synergy S3, S5, S7 Series	J-Link	Data Watchpoint and Trace Unit – Cycle Count and

		number of overflows calculated using the System Time
RZ	J-Link	Performance Monitoring Unit – Cycle Count and number of overflows calculated using the System Time
RL78	Simulator	Accessing the simulated hardware timer resources.
	E1/E20/E2/E2 LITE	Emulator is used to access the timer resources of hardware.

Device Migration

All

A new device migration feature has been added to e2 studio. This enables an easier method for you to transition from one device to another.

The migration is possible from one device to another within the same series. For example, you can migrate from a RX62N to a RX65N. You cannot migrate from one device family to another. E.g. RX to RZ.

The Change Device feature is available on the project pop-up and the Project menu item via the “Change Device” menu item.

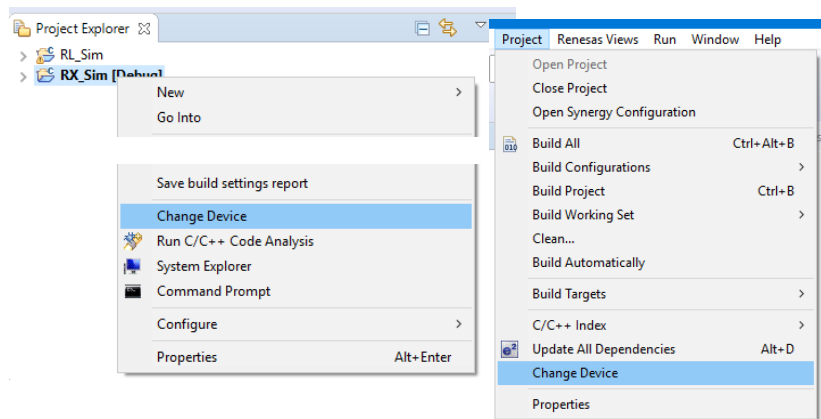

Once selected a wizard is displayed leading the user through the migration process. The first page allows you to choose the new device.

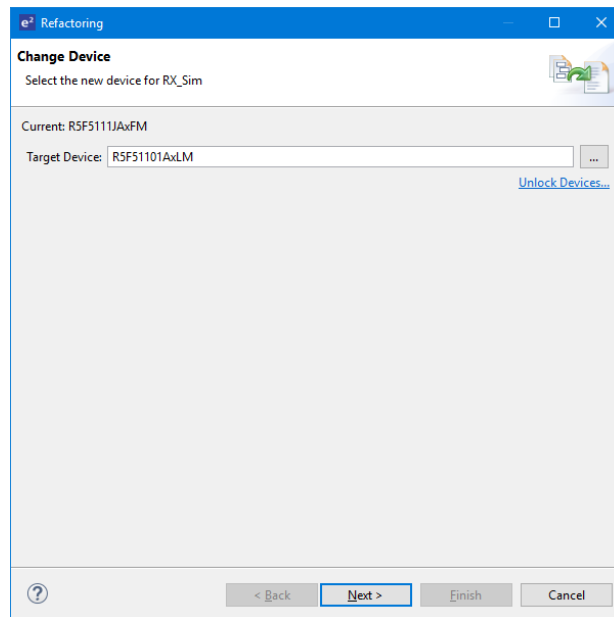

Any possible problems will be displayed on the next page of the wizard. In most circumstances the wizard will report no errors.

Note, once has been completed it cannot be undone so please ensure you have backed up your files before invoking this operation.

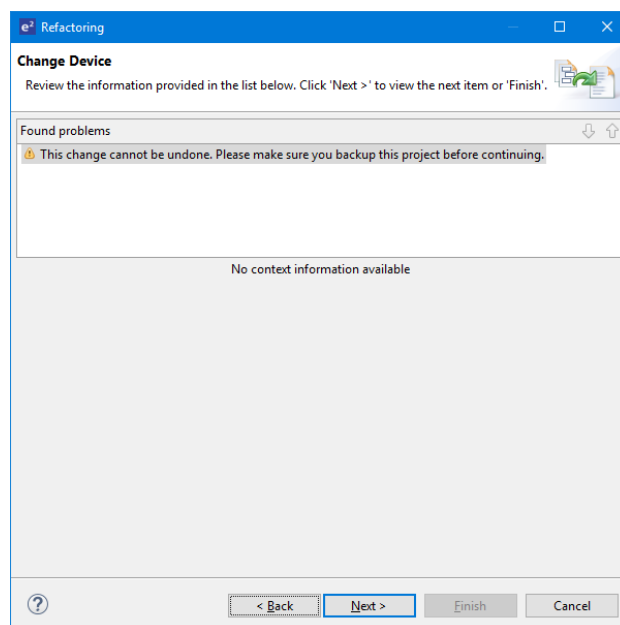

The next step of the wizard allows you to choose exactly what is being migrated. It gives fine control over migrating the debugger launch configuration, build settings and project files.

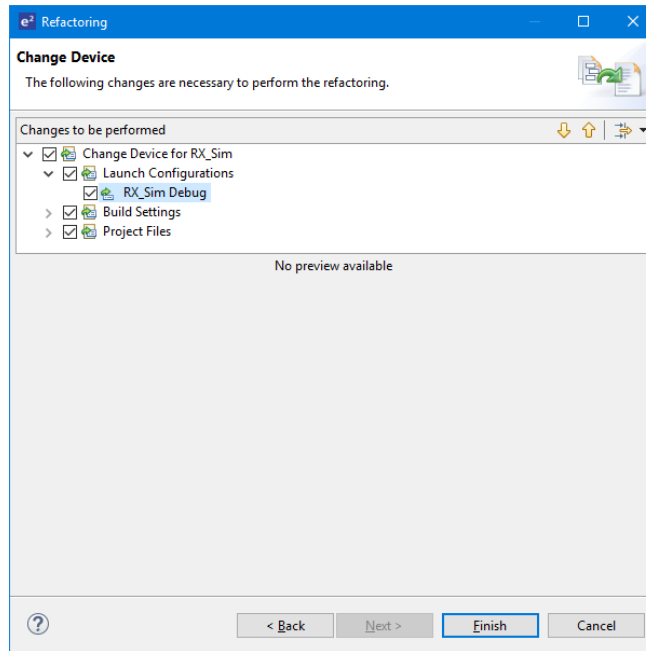

Expanding the project files item shows which files are going to be generated and the differences from those in the project already. A difference tool shows the textual differences for source files when they are selected.

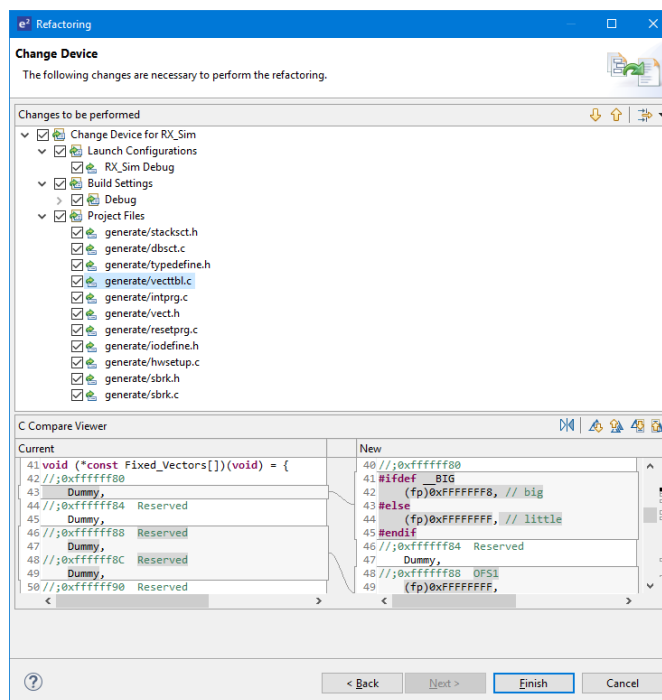

Toolchain management

All

Some look and feel improvements have been made to the newly detected toolchains dialog. In particular there is now a Select all and Deselect all button.

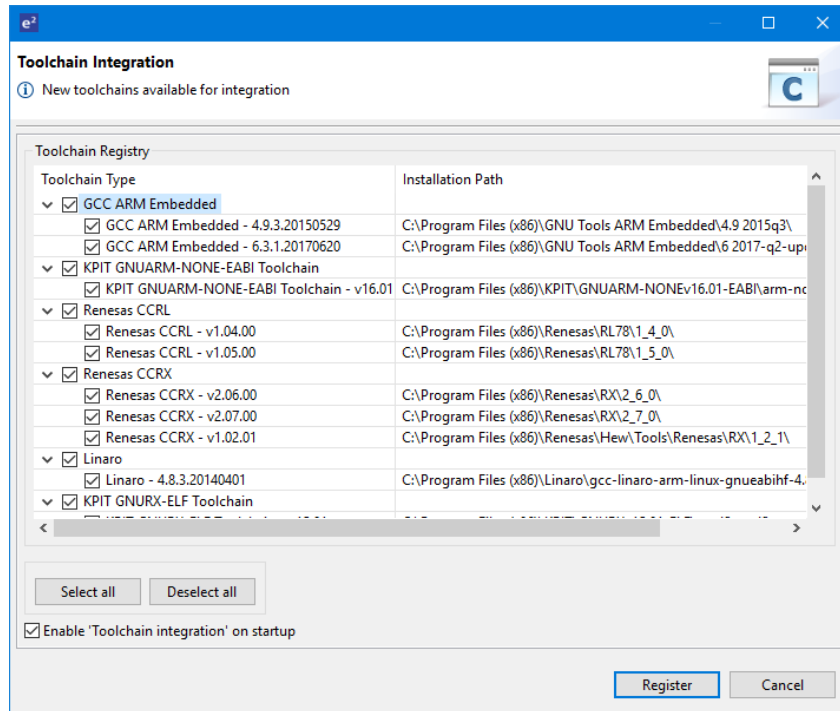

In addition, the Renesas Toolchain Management dialog has also been updated. The “Installation Path” can now be copied to the clipboard.

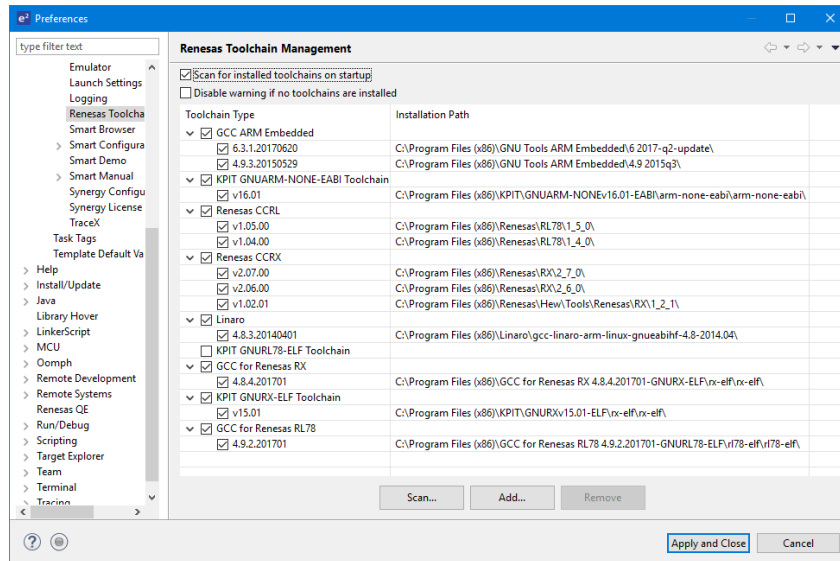

Smart Manual RX, RL

A new feature has been added to the smart manual view so that it will display the register help automatically when hovering over a register definition.

By default, this option is not switched on. It is switched on via the toolbar button on the Smart Manual view.

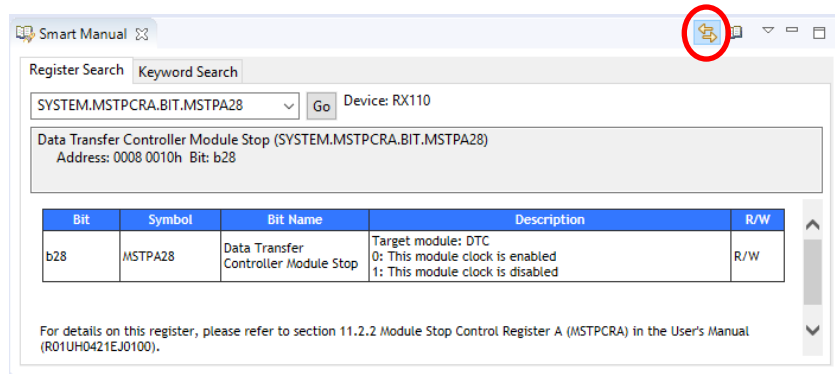

When switched on if you hover over a register definition in the editor the view automatically switches to show the same information.

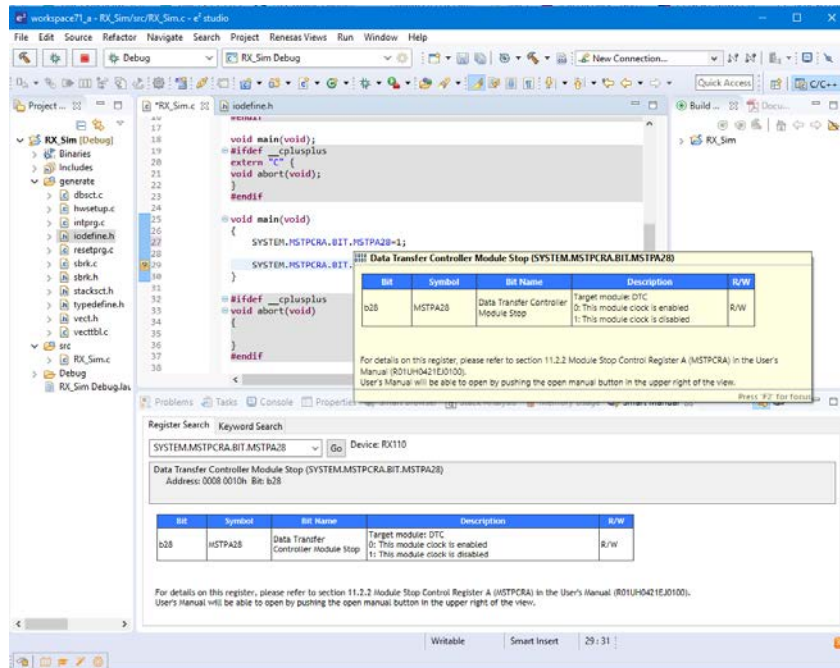

RL78 Simulator RL78
Trace break
reason

When using the RL78 Simulator and the trace capture is stopped the reason for the break is not show in the trace window.

This has now been updated to show the break reason in the status column.

Synergy Editor Synergy

The Synergy editor has been improved to also allow you to build software stacks from a driver to framework level.

Originally the specification was designed so that you would choose the upper level interface and then the tooling builds the software stack down to the driver level.

In some cases, it may make sense to build software frameworks from the driver layer up to framework layer. This is available from the "Extend Stack >" functionality when a module is selected.

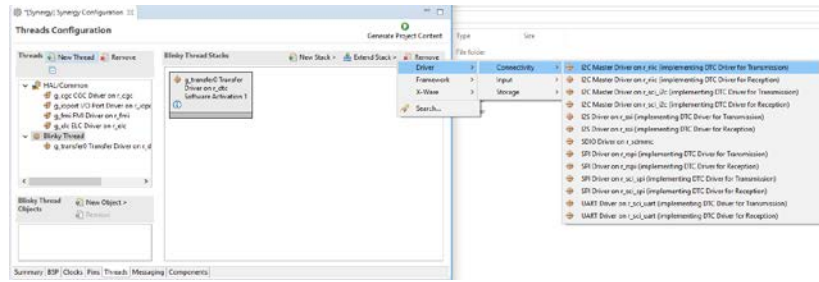

Synergy Project Exporter

An improvement to the Synergy Project Exporter has been made to ensure you do not accidentally include build directories and temporary data by default when exporting Synergy projects.

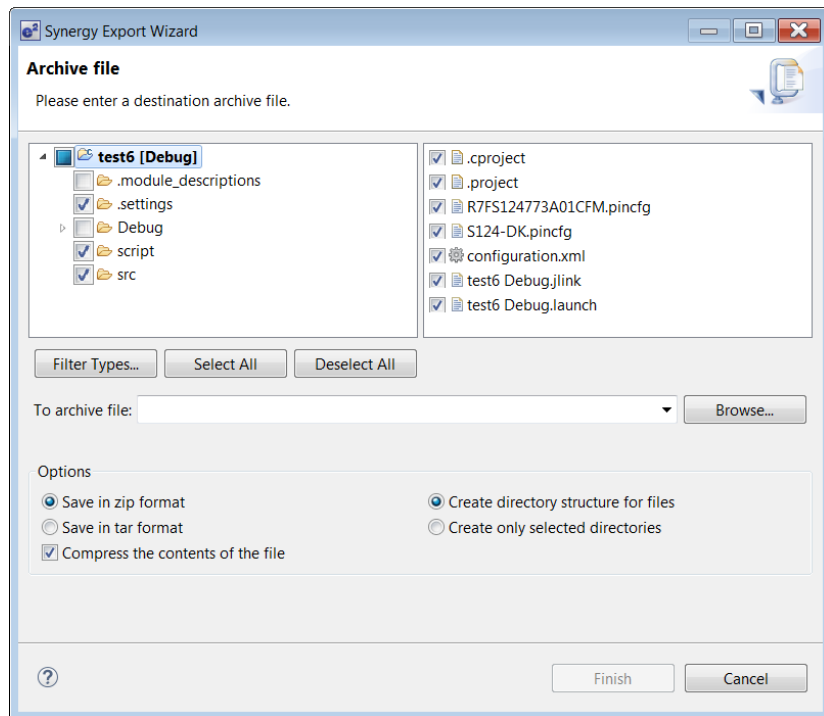

Customer include file paths

All A new feature has been added by e² studio to support the faster additional of multiple include paths.

This dialog has been modified to include the “Add subdirectories” option. Then when the user browses to a directory or enters a path using Eclipse placeholders it scans the subsequent sub-directories and adds these to the build settings.

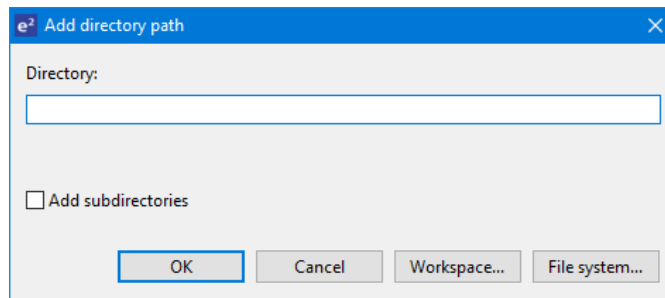

7. What is new in 7.0.0?

Component	Device	Description
Synergy Headless Build	Renesas Synergy	When using e2 studio to do a headless build with Synergy it can be difficult to setup a brand-new workspace and configure the licence file location.

This has been improved to use a command line parameter on the e2 studio command line.

```
-vmargs -Dcom.renesas.synergyLicenseFile="<absolute path to licence file>"
```

Debugger	All	Breakpoint error handling has been improved in this version of e2 studio. The reason for breakpoints not being set is more clearly shown in the source window.
----------	-----	--

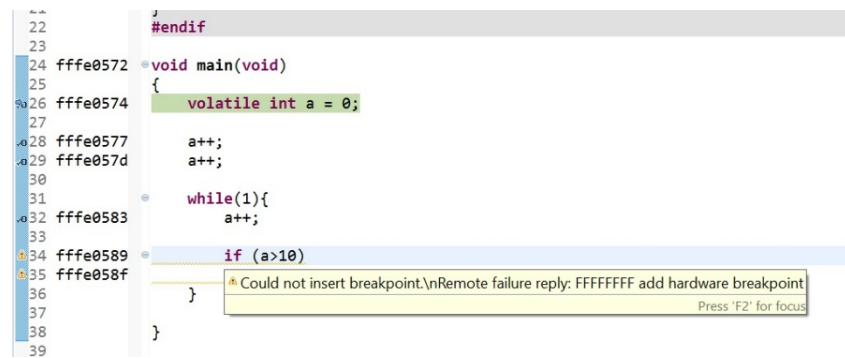

Hovering over the breakpoints which are not set will clearly show the reason for the failure.

If breakpoints fail on the launch of the debugger then the launch is aborted. An error is displayed and you can now see the exact reason for failure. If you then remove the breakpoint causing the problem and re-launch it should work.

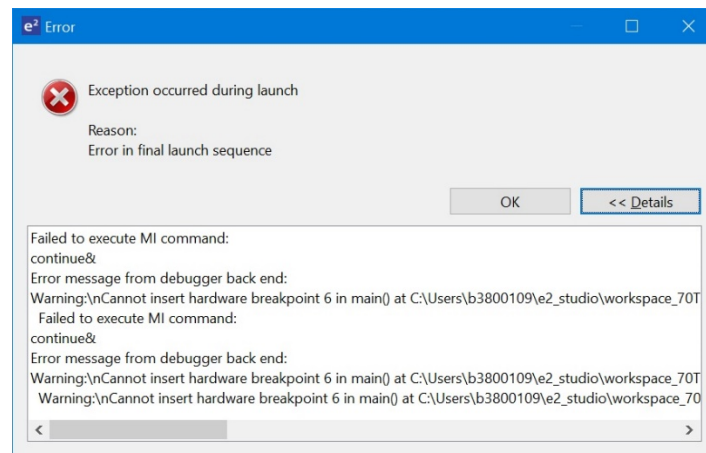

Synergy Editor

Renesas Synergy

The threads page user interface has been updated to navigate your threads and Synergy software stacks more effectively.

Previously thread selection was a flat list which only allowed each thread to be selecting. In this case all software stacks were shown in the graphical area.

Now the threads are shown as a tree meaning you can still select the entire content of a thread or choose an individual software stack. When choosing an individual software stack only that software stack is shown in the graphical view.

In the example below the user has selected the thread and 3 software stacks are shown.

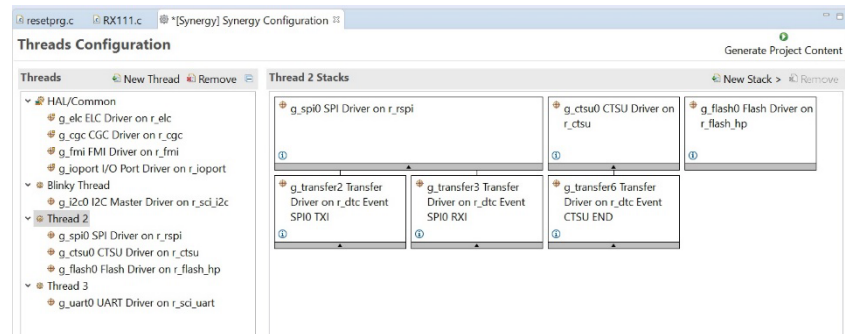

In the example below the user has selected the exact software stack and in this case only that one is shown.

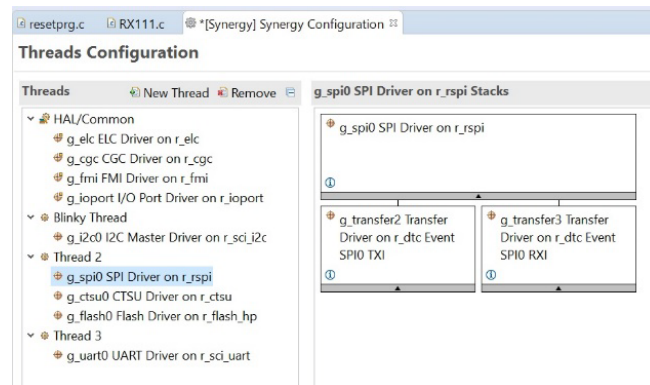

Debugger

All

In older versions of e² studio when debugging multiple debug connections, you needed to set the port numbers for GDB and ADM manually for the second debug connection.

This was not user friendly, so a new setting was added to automatically select available ports.

This can be seen for all devices on the debug configuration page.

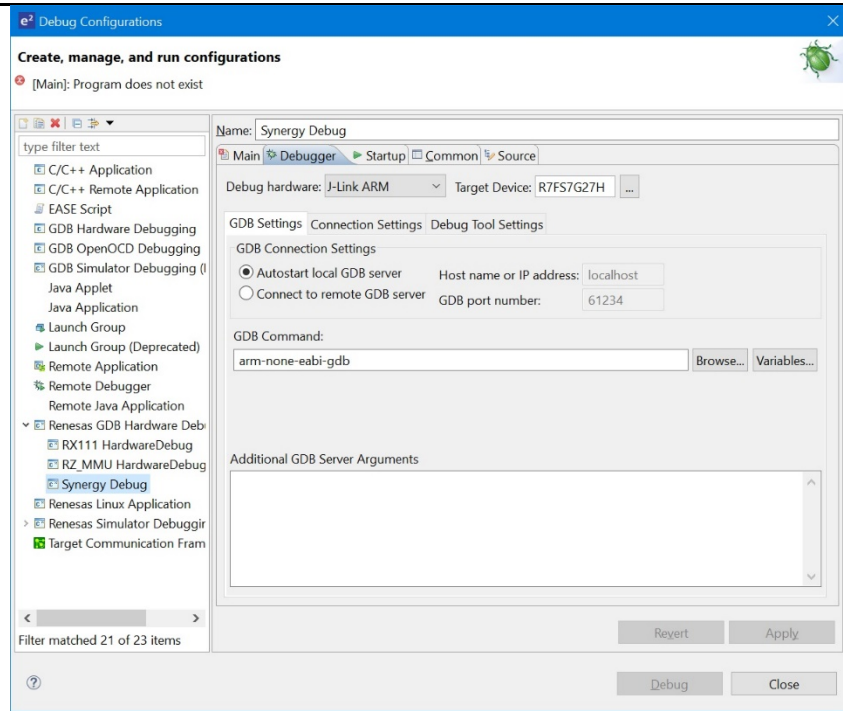

The “Autostart local GDB server” is the option to use for automatic port configuration.

If you need to attach to an existing already running GDB server use the “Connect to remote GDB server” and enter the first port number which was output to the console when the GDB server connects.

Trace All

The Trace plugin and debugger have been improved to now offer Trace capture pause and re-start.

When the debugger is running you can now press the pause button on the Trace view. When this button is pressed the trace is shown within the trace view for the captured data up to the point trace was paused.

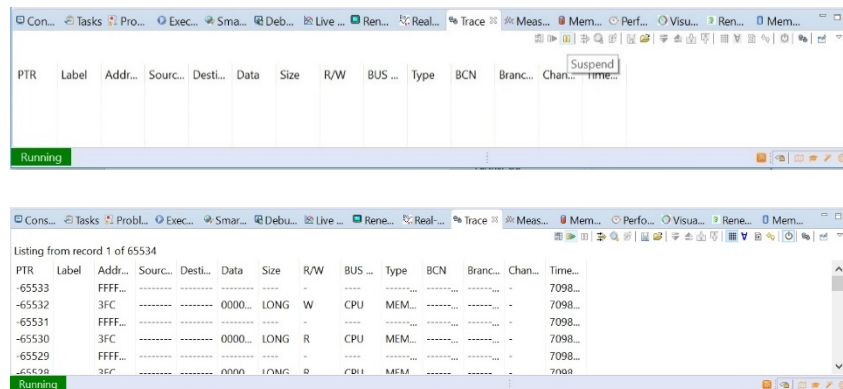

Pressing the resume button then re-starts trace capture.

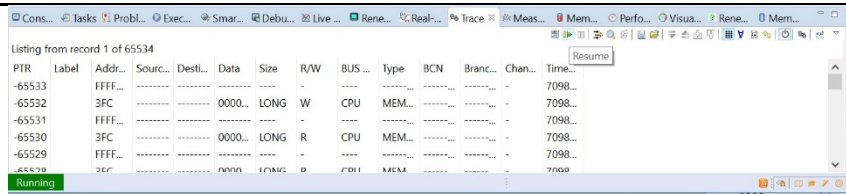

Smart Manual

RL78

In previous versions of e2 studio occasionally the Smart Manual link to hardware manual was displayed in the wrong location. The expected behaviour is to jump to the SFR register definition location in the manual.

In some cases, for the RL78 device family the location was incorrect.

Occasional behaviour in old versions of e2 studio:

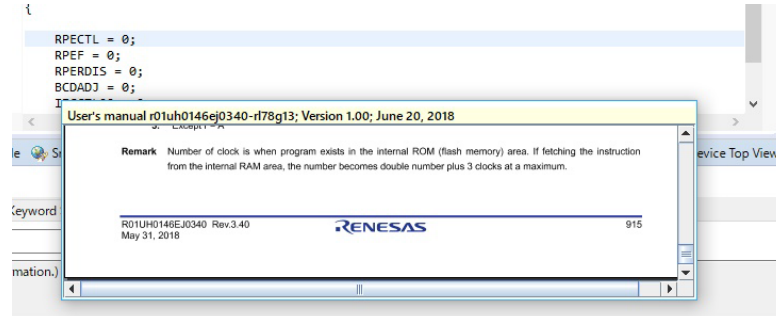

Corrected behaviour in latest version of e2 studio:

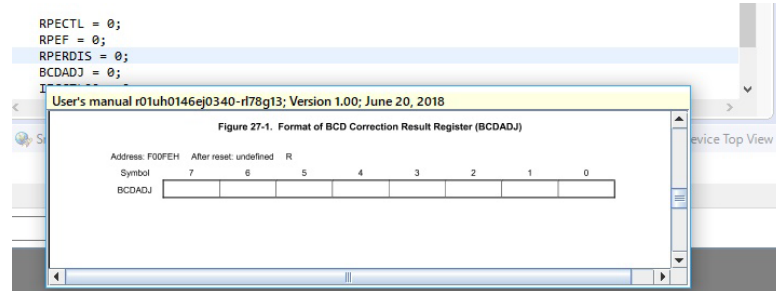

Synergy Application Project Generator for using SSP Library

Synergy

A new project type has been added for Synergy to assist you in generating an application project setup for using an existing Synergy Software Platform (SSP) library.

It is available here:

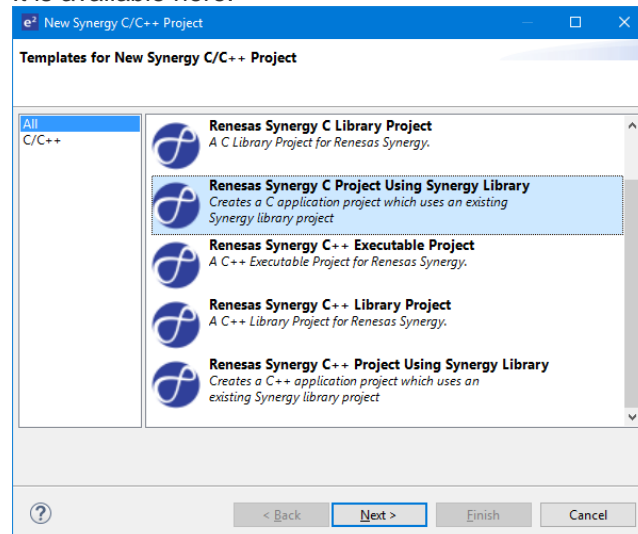

The library must exist in the workspace you are using. These libraries will then appear within the wizard for selection.

When selected the include paths that are required for setup are automatically displayed:

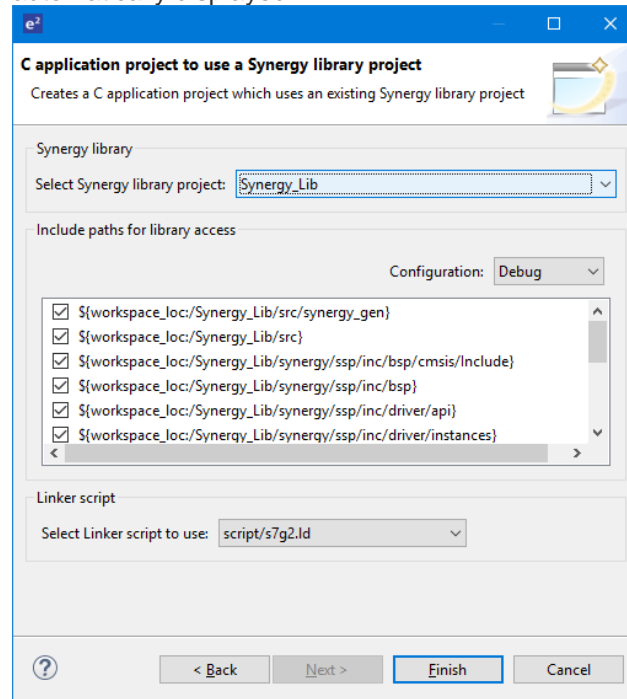

When Finish is clicked then the project is created with the build setting all ready to use the Synergy library.

RZ/A Linux Target Debug RZ

Linux target OS debugging is now supported. This is achievable with Ethernet and Serial connections to the target board.

This project type is available from the RZ Linux C/C++ project type. See below:

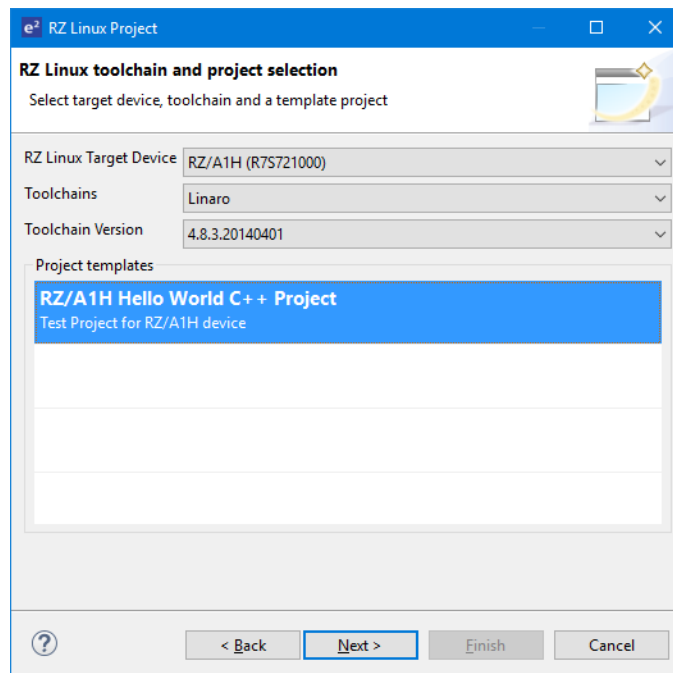
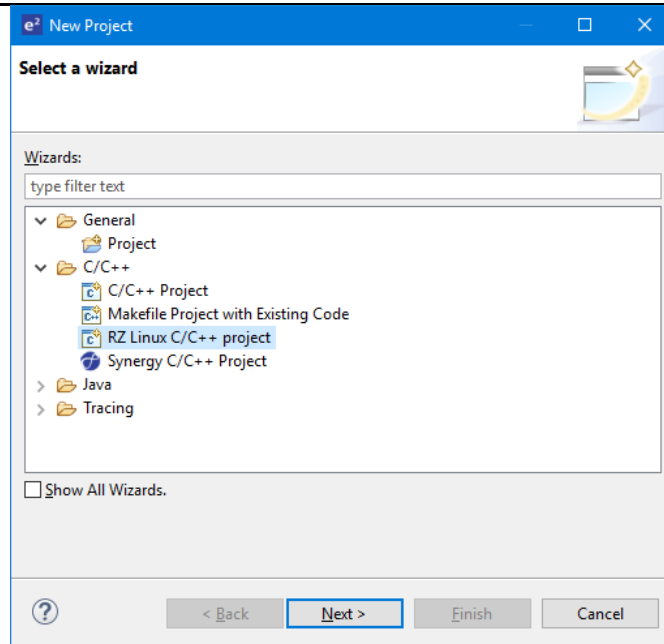

Ensure Synergy pin structures are available as enum in properties window

Synergy

Pin configurations setup in the Synergy pin view are now made available in the properties window.

The generated data file name as listed in the pins view is made available In the Power Profile pin configuration properties page. See below:

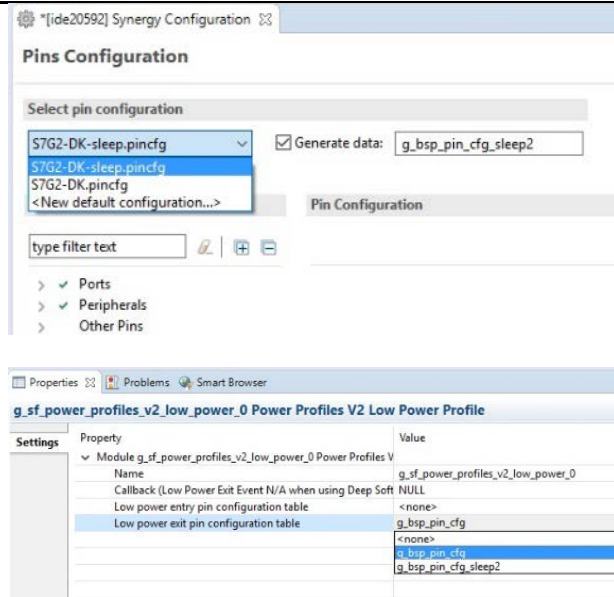

RZ/G Segger RZ
J-Link
Debugging

The RZ debugger has been updated to also allow connection to the RZ/G device family via J-link.

The RZ/G devices are available for selection in the “Renesas GDB Hardware Debugging” debug configuration category.

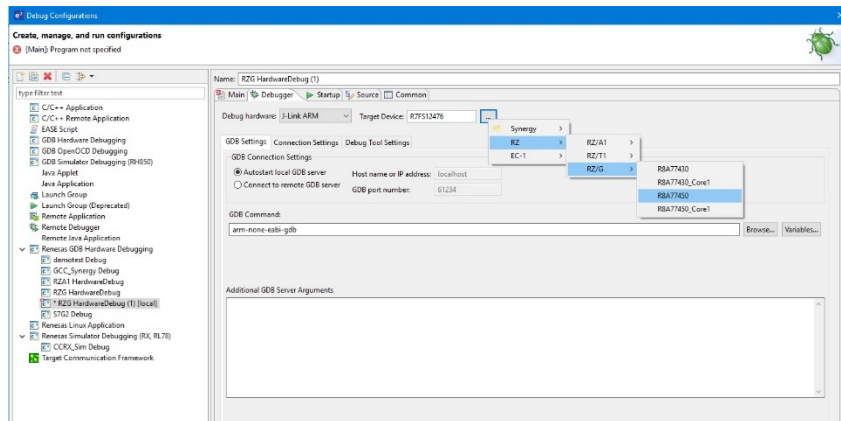

E2 Emulator
Debugging
RX,
RL78,
RH850

E2 emulator support has been added for the RZ, RL78 and RH850 device families. Debugging function is the same as the E1 Emulator.

CCRL
Compiler
RL78

The CCRL V1.07 compiler for RL78 is now supported.

Eclipse
Platform &
CDT

This version of e² studio is based on Eclipse Oxygen.3 and CDT 9.4. This release note does not describe the Eclipse framework and CDT plugin issues and fixes. You can find the detailed information on the sites below:

For information on the Neon release see here:
<https://projects.eclipse.org/releases/oxygen>

CDT:
Please see New and Noteworthy for CDT here:

<https://wiki.eclipse.org/CDT/User/NewIn93>
<https://wiki.eclipse.org/CDT/User/NewIn94>

The Eclipse bug tracker is here:
<https://bugs.eclipse.org/bugs/>

Memory Usage View	Synergy and RZ	When supported by updated device support files in e2 studio or the Synergy Software Platform (SSP) the Memory Usage View now supports the graphical view to show usage in the ROM and RAM memory areas.
Simulator RL78 Advanced Debugging	RL78	The RL78 Simulator support has been enhanced to support Profile, Trace and Coverage views.
GNU ARM Eclipse Plugins	Synergy and RZ	The GNU ARM Eclipse plugins have been updated to a newer revision. The version included is Version: 2.6.1.201806250952 This plug-in is part of the GNU MCU Eclipse project. For more details, visit < http://gnu-mcu-eclipse.github.io >
Synergy Software Platform Network Install	Synergy	A new feature has been added which makes it much easier to install SSP in a shared network location and point your e2 studio installation at that rather than using a local install folder for the SSP pack files. This can be achieved by opening the file <e2studio>/eclipse/e2studio.ini in a text editor and adding the following line at the end of the file: -Dcom.renesas.synergyPacksFolder=\\myServer\myPath\to\packs On start-up e2 studio will read the installed packs from this location rather than the packs folder underneath the application folder.
Synergy Editor	Synergy	The Synergy editor has a new feature to restore the BSP properties back to default values. This can be seen in the image below:

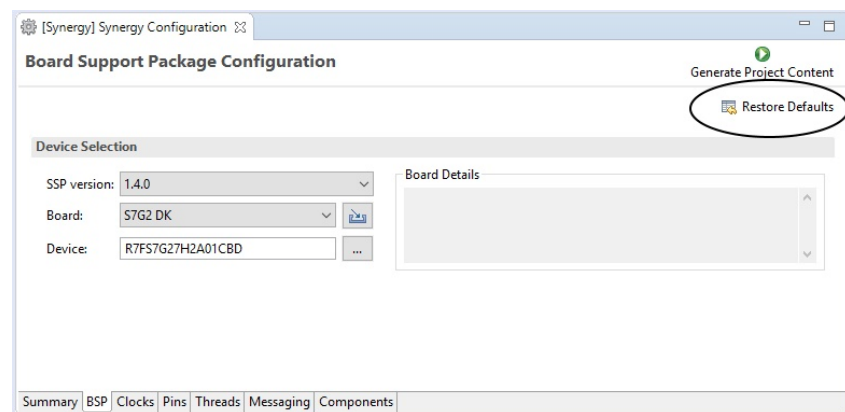

Synergy Editor	Synergy	In previous versions of e2 studio the files which hold the configuration data values for the Synergy modules were copied to the project directory in the folder .moduledescriptions. This allowed you to still use the project when the required SSP pack was not installed. However, it also increased the project directory size. From this version of e2 studio the .moduledescriptions are now stored once at an application level. If you import and existing project into the latest e2 studio it will continue to use the .moduledescriptions in your
----------------	---------	--

project. If for some reason this is not available or you create a new project the editor will use the application stored .moduledescriptions.

Trace RX, RL78, RH850

When using the trace view a new feature has been added to break the execution when the trace buffer is full. This feature is available for:

- RX (E1, E20, E2, E2 LITE, EZ, Simulator)
- RL78 (IECUBE, Simulator)
- RH850 (E1)

The feature is available from the trace view within the Trace Acquisition dialog:

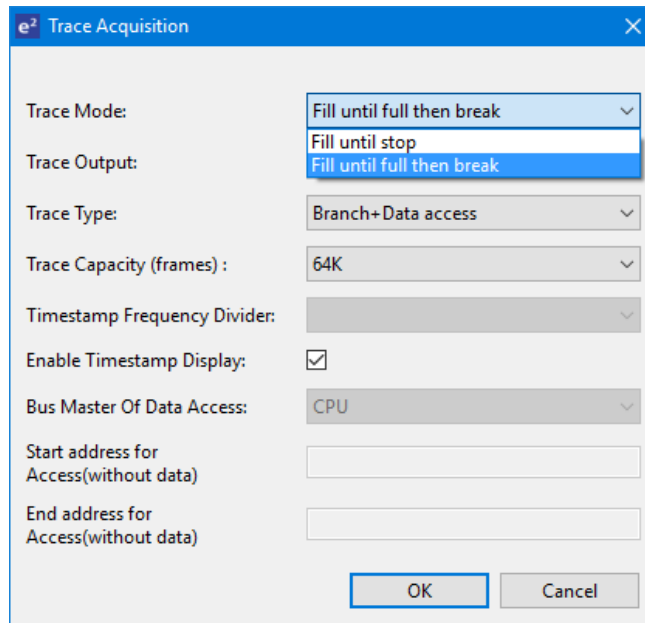

Trace RL78, RH850

The find trace feature has been enhanced to fully utilise the features in the RL78 and RH850 debugger.

This functionality is available from the trace view:

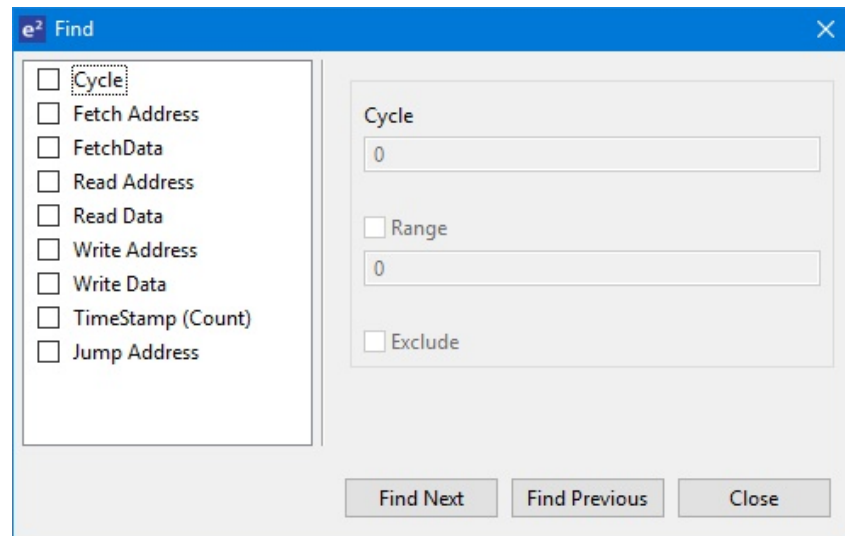

Segger J-Link Support RX

The Segger J-Link debug configuration for RX device support has been improved to allow automatic connection or specific emulator connection.

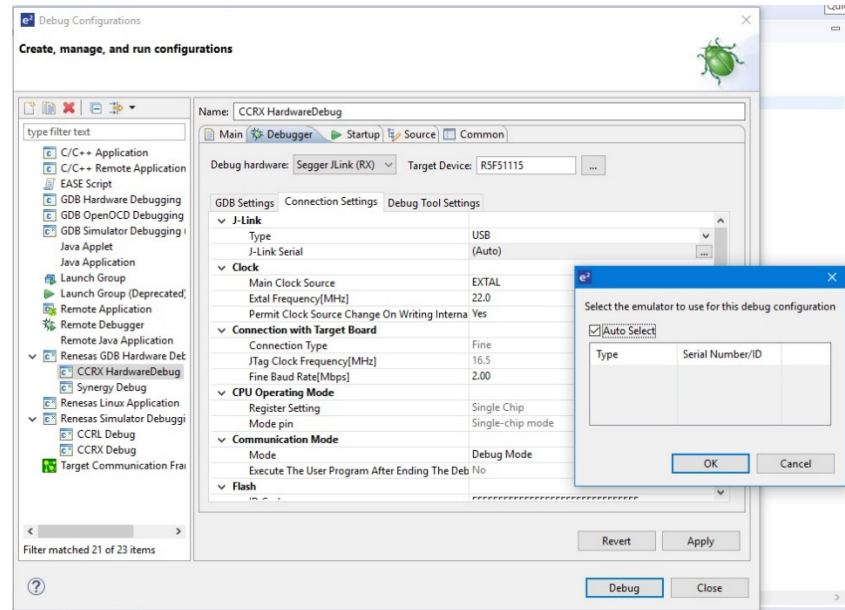

Synergy Editor – Threads Tab Synergy

To improve usability the add new Synergy module functionality on the threads page has been improved. There has been a new “Search...” menu added to the “New Stack” menu hierarchy. See below:

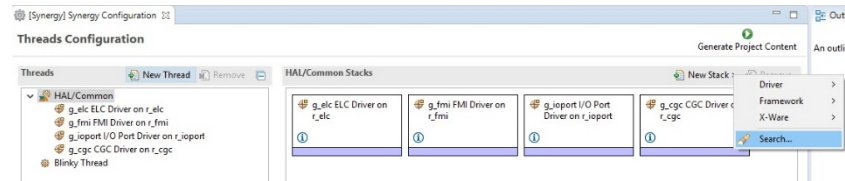

Clicking this menu item then opens a dialog allowing you to search and filter on the available SSP modules. In the example below, we have entered SPI and this is the result:

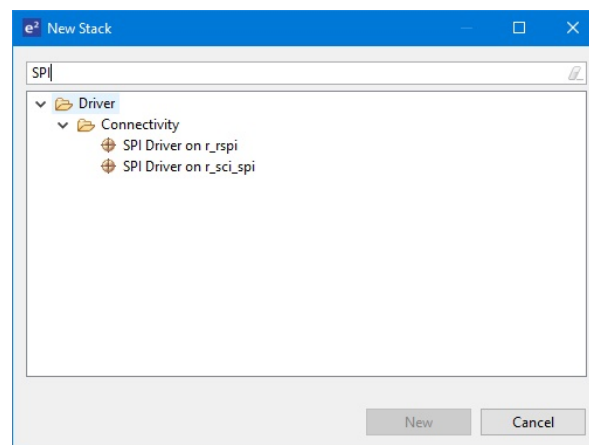

In addition to this functionality a search of software stacks already created has also been implemented. This can be accessed by using the CTRL+F shortcut or [Edit->Find] menu when the Threads tab is focused. A dialog is shown with your configured stacks.

Then when you type a search condition the matching parts of the software stack are shown. Selecting the correct module and pressing the “Select” button then automatically highlights the module in the Threads Page.

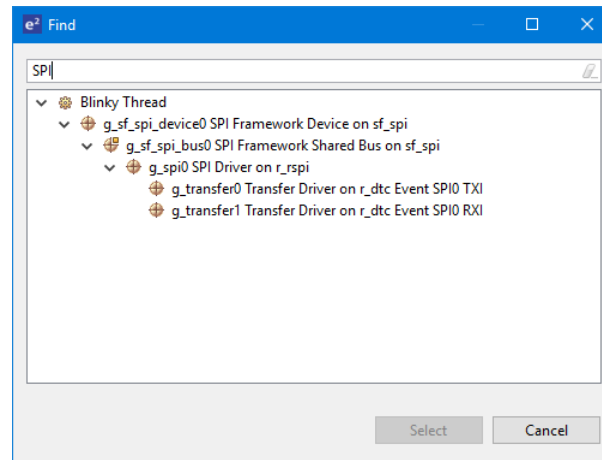

Synergy Debugger Synergy

When the Synergy debugger reaches an interrupt in older versions of e2 studio the call stack within the debug view was not populated with as much information as possible.

In the latest version the call stack is more complete allowing the user to see a more complete call stack in the interrupt use case.

Debug Console All

In previous versions of e2 studio some users have struggled to find the debug console functionality. This provides support for customers to use this as a virtual serial input/output channel for RX. It is also used for semi hosting support for ARM.

Previously the view was embedded within the console view of e2 studio. Now the view has been moved underneath the [Renesas Views->Debug] menu item:

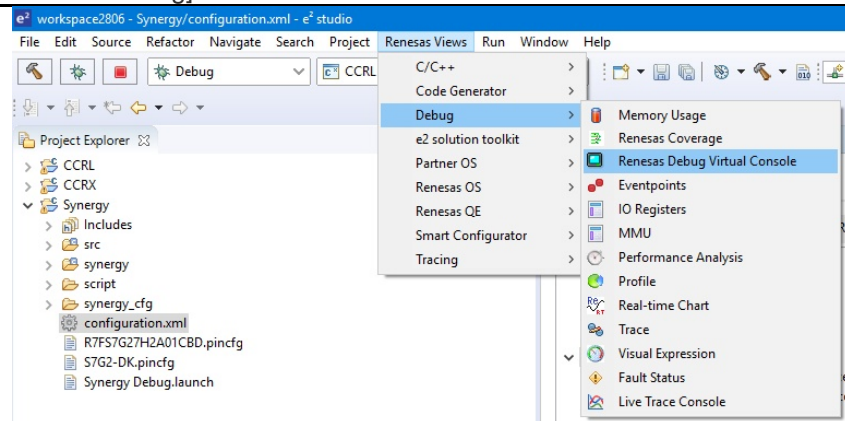

All other functionality is the same but more customers should be able to discover the view and its functionality.

Build Settings Report All

The Build Settings Report has been improved to include all options and order the options in the same way as the user interface. This should enable checking the options against the report to be much easier.

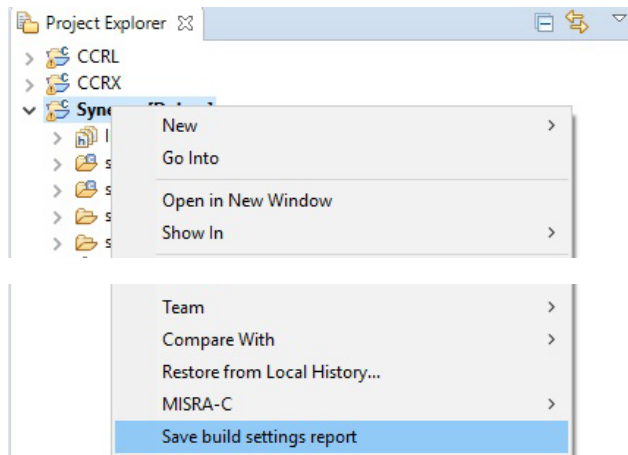

Synergy Editor

Synergy

A link to the import CMSIS component has been added to the BSP tab of the Synergy editor. This is to improve accessibility of the import CMSIS component functionality when wanting to add a custom board to the IDE.

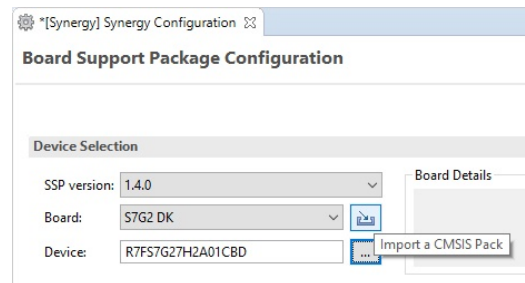

Partner OS Improvement	All	<p>Numerous improvements have been made to the Partner OS plugin:</p> <ul style="list-style-type: none"> • Added ability to set thresholds and this data to then be saved and restored for future debug sessions. • When stacks reach threshold or overflow, popup messages will be displayed to notify user about the stacks reaching their thresholds. • Added context menu and toolbars for setting thresholds • Added sort feature to the stack graph column within the stack tab.
Smart Configurator	RX	<ul style="list-style-type: none"> • Smart Configurator has been updated to support RX110, RX111 and RX113. • In previous versions of e² studio, BSP version mismatch occurred when user downloads the newly updated FIT modules from website. From this version, Smart Configurator will be able to update BSP to the latest version. So, user can use the newly updated FIT modules with the correct BSP dependencies at ease. • Importing and exporting board information has been supported. Clock and pins can be configured for specific board by importing board description file. Board description files for Renesas Starter Kit can be downloaded using Smart Configurator. Clock and pin settings modified using Smart Configurator can also be exported as user board description file.
Partner OS Improvement	All	<p>Numerous improvements have been made to the Partner OS plugin:</p> <ul style="list-style-type: none"> • Added ability to set thresholds and this data to then be saved and restored for future debug sessions. • When stacks reach threshold or overflow, popup messages will be displayed to notify user about the stacks reaching their thresholds. • Added context menu and toolbars for setting thresholds • Added sort feature to the stack graph column within the stack tab.

8. Useful workarounds and information for 7.3.0

Please visit the Renesas FAQ for e² studio for the latest up to date information:

[Online FAQ link.](#)

ID	Component	Workaround or information
	Application	When using the check for updates feature within e ² studio and updating from 7.0.x to 7.1.x the initial restart after the update fails. An error message is displayed. Subsequent launches of e ² studio work without issue. This is caused by the update to Java.
	SH support	The Renesas SH device family is no longer supported in e ² studio. If you need to use the SH device support, please use e ² studio 5.4 or earlier.
	Importing old projects into 6.x	All projects being migrated into the latest e ² studio from e ² studio 5.4 and earlier versions will need to be migrated to the new builder plugins. The new builder plugins have different user interface pages and different option IDs.

Upon opening an older workspace, the following dialog would be displayed:

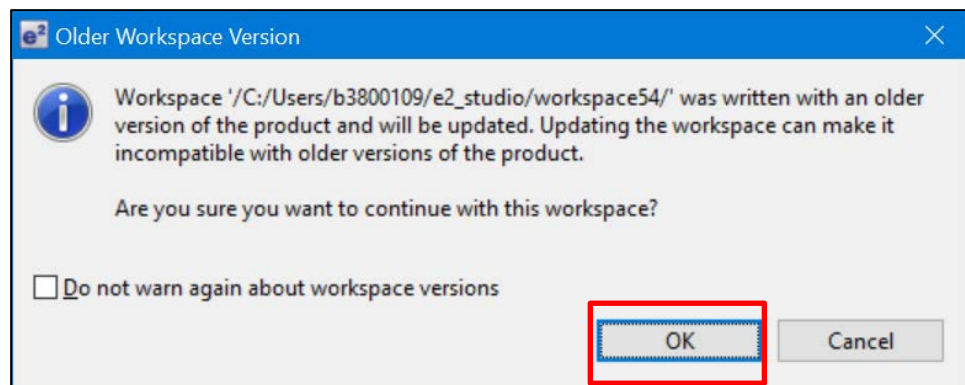

Clicking OK will update the workspace to the newer e² studio.

Importing an existing project to the workspace or opening a workspace with old projects will automatically start the legacy project upgrade procedure.

If for some reason this process does not start it is also possible to launch the “Upgrade Legacy of e² studio Projects...” from the project context menu.

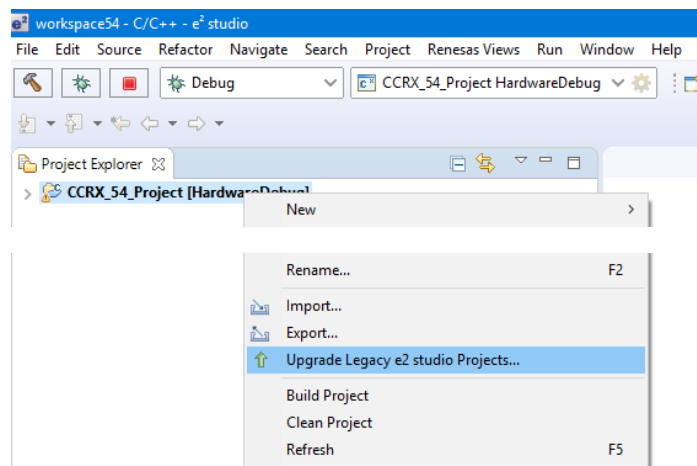

The automatic system pops up a message bubble in the bottom left of the e² studio application window.

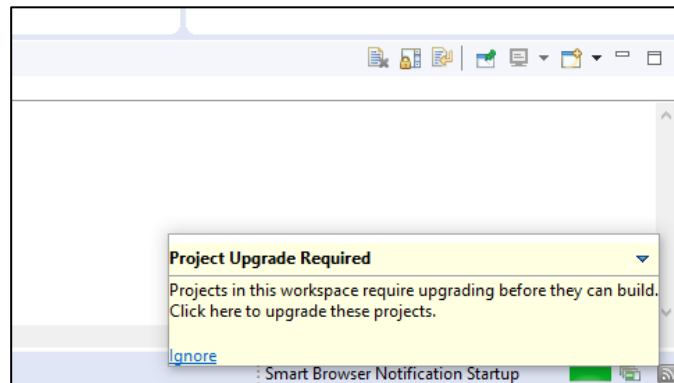

After selecting the menu item or clicking the bubble the following dialog will be shown:

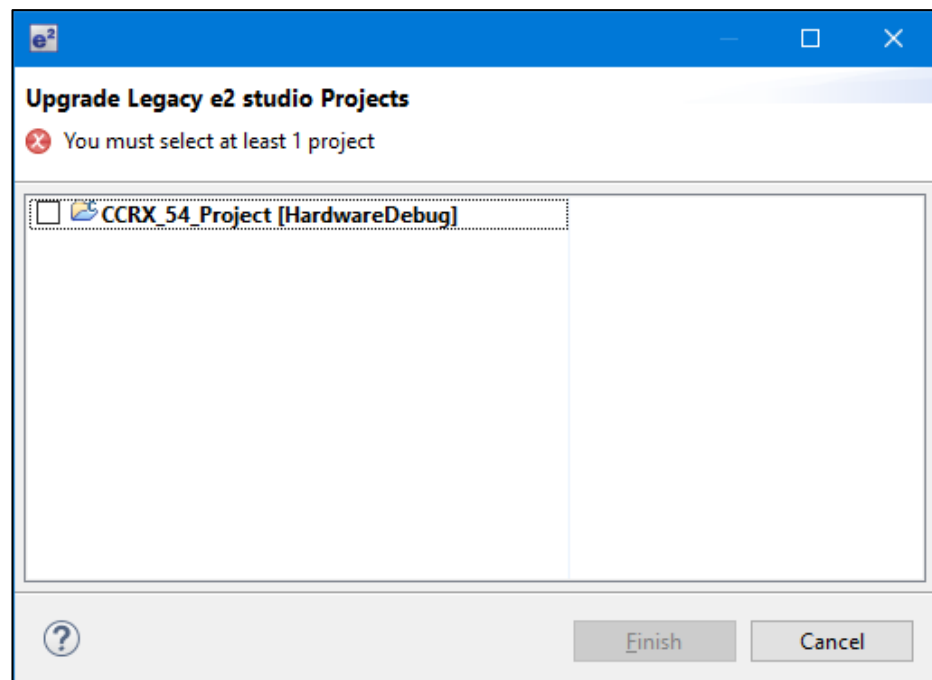

To upgrade the project, click the corresponding check box and then click Finish. Note, this will update the project to the latest build plugins and options. Before doing this, you should ensure your project is backed up as this operation is not reversible.

It is possible to upgrade multiple projects in a single operation.

For the GCC toolchains for RX, RL and GNUARM-NONE have been made to the build options which mean we cannot guarantee the same binary output after upgrade. Please consider this before upgrading.

Another consideration for migration is that debug configurations when opened in 6.0 will also need to be migrated. The following message will be displayed.

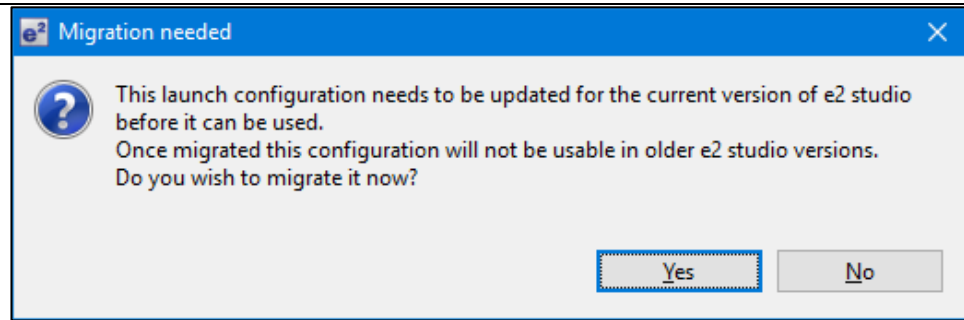

Please ensure that your projects are backed up or in revision control before migration allowing you to return to older versions if required.

Toolchain Management

Before e² studio 6.0 the toolchain management facility automatically upgraded or downgraded the imported project to the latest tools installed on the host machine.

This no longer happens in the latest e² studio. Instead the toolchain remains the same and user operation is the only way to change the toolchain version.

This operation is now available within the build settings on the toolchain tab. An example of CCRX is shown below:

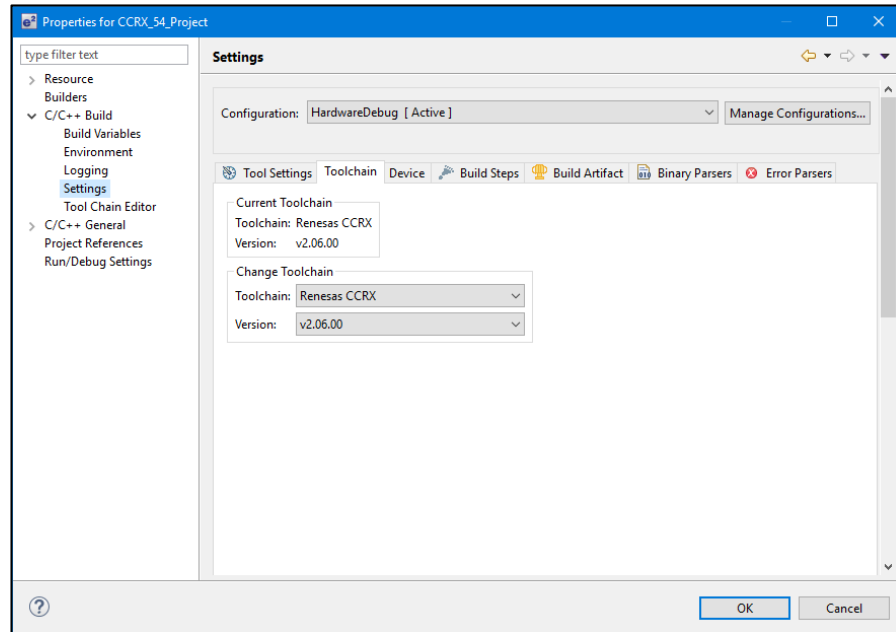

If the particular toolchain version does not exist and build is performed, then an error message is displayed and the build will fail.

RZ Toolchain

The now legacy KPIT GNU ARM-NONE toolchain is still supported within the e² studio product but now using the gnuarmeclipse plugins.

In addition RZ within e² studio now supports the GNU ARM Launchpad toolchain. Available from <https://launchpad.net/gcc-arm-embedded>.

One drawback of this toolchain is that it does not have a standard library builder provided in the same manner as the legacy KPIT ARM-NONE toolchain. To use this feature for ARM Launchpad and gain access to the more efficient optlib libraries a further download is required.

This can be downloaded within the e² studio installer or directly from here: <https://gcc-renesas.com/rz/rz-download-toolchains/>

Once integrated it is possible to integrate the library generator from the toolchain tab of the build settings page.

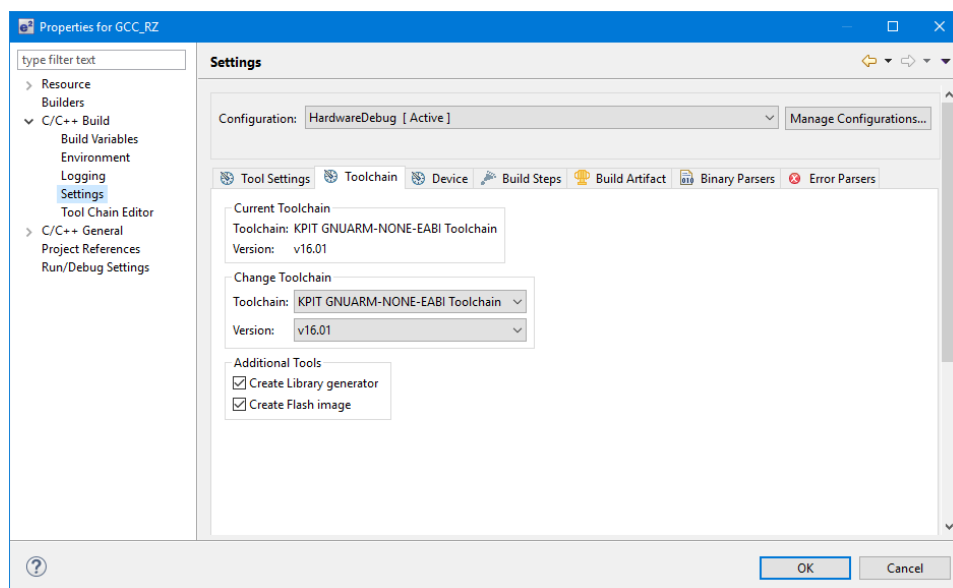

See “Create Library generator” option. Once checked the library generator (libgen) is added to the available tool settings.

QE compatibility

If QE for TCP/IP V1.0.0 is used, please update it to V1.0.1. Other QE series can be used with e² studio 6.0.

What is QE?

<https://www.renesas.com/qe>

Details of QE for TCP/IP

<https://www.renesas.com/qe-tcpip>

5954 Application

If you experience the error message “org.eclipse.swt.SWTErrror: No more handles” this can be caused by certain multi-monitor software and the Eclipse framework.

If this error occurs there are 2 workarounds:

1. Use a single monitor display.
2. Uninstall the multiple monitor software from your graphics chipset vendor and revert to the standard Windows multi-monitor feature.

6981 RL78 Debugging

When debugging IAR C source file with an OCD emulator (E1), the Monitor program area (0x00002-0x00003) is used.

So this area must be excluded from usable address space. Please add '-HFF' in the linker option.

- Open Property.
- Select [C/C++ build]-[Settings] at left side.
- Select 'IAR RL78 Xlink linker' at right side, add '-HFF' at the textbox 'command'.

Not doing this will cause problems with connection and download when using interrupts.

NA	Application	<p>If you are experiencing slow building of projects within e² studio there are some possibilities to improve.</p> <p>The system environment will attempt to find the make.exe tool via the system environment. If you ensure the directory make resides in is at the start of the path variable it will find it more quickly. Especially important if there are network drives in the path.</p> <p>In the project properties, C/C++ Build tab, behavior tab you can switch on parallel build. This will take advantage of the multi-cores on your host machine if it has them.</p>
NA	RZ GCC	<p>In 3.0 the KPIT GCC RZ toolchain was supported at version 14.01. This version is no longer supported within e² studio.</p> <p>KPIT modified the name of their ARM toolchain to be ARM-none-eabi to follow standard ARM naming convention like other GCC toolchain vendors.</p> <p>The ARM-none toolchain is available at versions 14.01, 14.02 and 16.01 from the www.gcc-renesas.com website. The binaries in the 14.01 version are identical to those used in the 14.01 RZ toolchain.</p> <p>Once the toolchain is installed your projects will be imported and ported to ensure there is as little disruption as possible due to this change.</p>
NA	KPIT GCC	<p>The KPIT toolchains are now no longer supported by the www.kpitgnutools.com website. Support is now available from the www.gcc-renesas.com website.</p> <p>In addition, there are two new releases for the GNU toolchains for RX and RL78. These are now named Renesas GCC for RX and Renesas GCC for RL78.</p> <p>Both integrate into e² studio and can be selected from the project wizard.</p>
2010	HEW Importer	<p>Symptoms: Project fails to build after importing a legacy project from HEW</p> <p>Conditions: If a long filename or path is used, and the HEW project importer is used, the project may fail to build.</p> <p>Workaround: Move the original HEW project to a shallow directory structure (i.e.) C:\Workspace and import from there. Also, ensure that the HEW project is relocated before importing into e² studio.</p>
1922	Application	<p>Symptoms: Project fails to build in first instance after archive project import (not from HEW)</p> <p>Conditions: If an archived project is imported, it may fail to build the first time, due to a residual .d file.</p> <p>Workaround: Clean and Build a second time.</p>
2762	CODAN	<p>When using assembly code within a C source file, CODAN errors can be observed in the editor. Even though the project builds successfully, or even after rebuild index.</p> <p>Indexer buffer can be insufficient to process whole project. Please try giving larger values for the following configurations.</p> <p>Open preferences dialog through "Window"->" Preferences" menu. In "C/C++" -> "Indexer" tree, you will indexer configuration as shown below:</p>

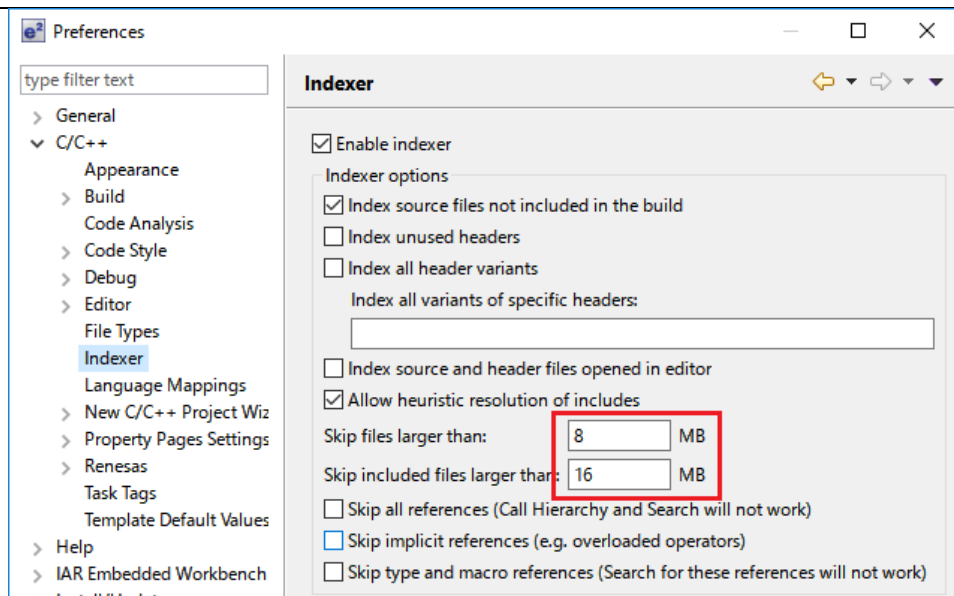

Put larger values for each red-framed variables, then rebuild project or rebuild index.

2728	GDB	<p>Step into does not always work when using the CC-RX 1.02.01 toolchain.</p> <p>To ensure this behaves correctly you will need to use CC-RX 2.00.00 or greater as this issue with the debug information is corrected in this release.</p>
NA	Eventpoints	<p>If eventpoints do not always work just after they are set, you can use the "Apply to Target" toolbar button in the Eventpoint view to send the Eventpoints to the target manually. This will always ensure the debugger target has all the required eventpoint updates before execution starts.</p>
5772	IAR Plugins	<p>The IAR Plugin Manager is included in e² studio and provides support for RX, RL78, RH850 and RZ (ARM).</p> <p>This tool, simplifies installation and configuration of IAR toolchain plugins. You can access this through Help -> IAR Embedded Workbench plugin manager.</p>
6184	RL78/CC-RL debugging	<p>When the load module for RL78/G10 which created at CC-RL is debugged in E1, please specify the following option:</p> <p>[Linker] -> [Device] -> "Set enable/disable on-chip debug by link option"</p>
7217	Application	<p>The restore default settings does not restore all the options set during project generation. Instead, it sets the defaults to the base settings for the device family in use.</p>
7524	RZ/T1 Debugging	<p>In a RZ/T1 RAM-based project, the "Reload" function does not work.</p> <p>Reloading or re-downloading during debugging resets the device and the RAM content is erased.</p> <p>To continue the debugging, disconnect and connect the debugger again.</p>
	Use spaces as tabs	<p>Eclipse and CDT both have settings for use spaces as tabs. The option on the Editor preferences page conflicts with the CDT formatter settings.</p> <p>To change the use spaces as tabs option in e² studio please use this page:</p>

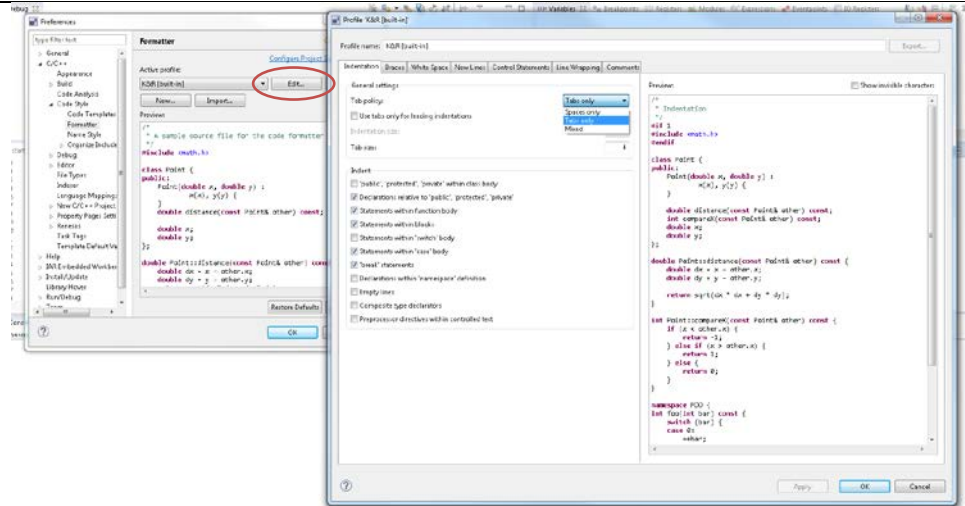

<p>Installer problems</p>	<p>In some situations, the AVG virus checker appears to interfere with the e2 studio installation process. If you experience such a problem, please temporarily disable the AVG tool and try the installation again.</p>
<p>Antivirus</p>	<p>In some situations, the Norton anti-virus tool can interfere with the building of Renesas Synergy projects. If possible, please disable the antivirus program when building Renesas Synergy projects on systems with Norton Antivirus installed.</p>
<p>Green Hills RH850 Projects</p>	<p>When debugging the RH850 object built with the Green Hills compiler in e2 studio, specify the following option for the compiler option.</p> <p style="padding-left: 40px;">-gtws</p> <p>The GUI setting menu is as follows.</p> <p>[GHS C Compiler for V800 Standalone]-[Debugging Option]</p> <p style="padding-left: 40px;">"Generate Target-Walkable Stack" -> On</p> <p>If this option is not specified, Step Over and Step Return may not work properly.</p>
<p>17052 Debugging</p>	<p>When debugging using a project with duplicate filenames that are in different source folders problems can be seen with breakpoint setting.</p> <p>When a breakpoint is set at a source line in this file it will also stop at the same source line in the other same named file when execution passes through.</p>
<p>18505 RZ debugging</p>	<p>When debugging with RZ/T1 in certain situations you may experience problems stepping:</p> <p>If the following conditions are met:</p> <ol style="list-style-type: none"> 1. Code is located close to address 0x0 2. There is very little library code included into the project 3. There are unused functions in the program <p>The possibility arises that the code cannot be debugged. This due to --gc-sections linker option which removes the unused functions but not the related debug information.</p> <p>There are several solutions to this problem:</p> <ol style="list-style-type: none"> a. disable --gc-sections until those functions are used b. remove the unused functions
<p>RZ GCC Build</p>	<p>In the latest e2 studio the RZ import functionality has been improved. However, there are still possibilities of older projects causing problems when imported into e2 studio.</p>

		<p>In older versions of the RZ build plugins the FPU option was not being handled correctly. When setting the “Soft” Floating point ABI the command line was still receiving <code>-mfpu=vfpv3</code> incorrectly. This can now cause problems with older start-up code in older RZ projects.</p> <p>After import if you see an error relating to this please add <code>-mfpu=vfpv3</code> to the “Other Assembler Flags” page of the Assembler tool.</p> <p>In addition, when migrating some RZ/A1 projects you may experience import problems unless you build the project in 5.4 first.</p>
	RZ DS-5 Project Import	<p>When a DS-5 project is imported into e² studio the environment variables for Path and TCInstall are copied from the DS-5 environment.</p> <p>This is not correct. The way to correct this problem is to delete both paths and replace them with correct values to your toolchain. If you are unsure how to correct this please create a new project and copy the values from this to the converted project.</p>
	RX & RL78 GCC Project Import	<p>When importing a KPIT RL78/RX Library C/C++ project from e² studio 5.4 or before the build artifact settings are not correct.</p> <p>The output prefix should be set to “lib” but is in fact empty.</p>
	RZ/G debug	<p>In the case of debugging Linux application for RZ/G, the following error messages are shown in GDB server console when pushing [Step in] button or [Step Over] button.</p> <p>These messages can be ignored because the Step debugging should work properly even with these messages.</p> <p>Examples of error messages: PassthroughTargetCommunication::sendResponse error 42 46 PassthroughTargetCommunication::sendResponse error 10 15 PassthroughTargetCommunication::sendResponse error 42 46</p>
21863	RX & RL Debugging	<p>In previous releases there were some problems with stepping in some situations when using the CCRX and CCRL toolchains.</p> <p>A fix has been made to the debug object converter. To see this improvement please clean and rebuild the project. The debug information will then be updated, and the stepping will be more correct and reliable.</p>
	Code Generator registration	<p>When using multiple installations of e² studio on your machine you may find that subsequent installations do not work correctly with the code generator.</p> <p>The effect is that the code generator cannot be created or added to projects. Existing projects can be used by the code generator views appear empty.</p> <p>If this is the case, then the code generator must be manually registered. To do this execute the following tool:</p> <p>e.g. C:\Renesas\e2_studip\eclipse\plugins\com.renesas.cg_2.11.0.v20180601-1047\CodeGenerator\Tools\register COM.bat</p>
25702	ARM Project Import	<p>When importing an e2 studio KPIT GNUARM-NONE project from 5.4 into the latest version some options can be lost that are specified on single files. (local options not project based options)</p> <p>If you experience this the only workaround is to reapply these settings to the resources which have lost the settings.</p>

25479	CCRX to GCC Convertor	When importing a CCRX 6.3 e2 studio project into the latest e2 studio the project cannot be converted when the source project only has one build configuration.
25312	ARM Semi hosting and GCC 7.x	<p>The default created GCC project in e2 studio for RZ and Synergy will not work with semi-hosting when using a GCC 7.x toolchain. This is due to semi-hosting being revised to v2, , presented in this document: https://developer.arm.com/docs/100863/latest/introduction.</p> <p>Launchpad toolchains v7.2 or newer, provide an upgraded semihosting v2 implemented in syscalls.c, which is provided by the newlib libraries. When the function initialise_monitor_handles() tries to identify features, a new mechanism introduced in semihosting v2, it will cause the debugger to provide incorrect answer, prompting semihosting to close stdout, stdin handlers and stalling the processor.</p> <p>1. use syscalls replacement code provided in the eclipse plugin, which is guaranteed to work. We can achieve this by copying to project sources "_syscalls.c" and "semihosting.h" from <EclipseInstallFolder>\eclipse\plugins\ilg.gnuarmeclipse.templates.core<PluginVersion>\templates\common\system. Additionally, in project properties, Compiler settings the language standard must be changed to gnu99, as well as an additional define must be added OS_USE_SEMIHOSTING. Finally removing from linker flags -specs=rdimon.specs will allow the project to compile and semihosting work as intended.</p> <p>2. Identify the library used in your project and replace it with an older library. This can be achieved by first building the project with GCC 5.4 a quick search in the. map file for initialise_monitor_handles, will reveal the location of the folder that contains the libraries involved. Then repeat the same steps for GCC 7.2 compiler. Finally replace the entire folder with the folder from the older compiler, reverting the semihosting implementation to V1.</p>
25278	Synergy debugging	<p>When loading Symbols from multiple .elf files compiled using the IAR toolchain, the user will need to add ".text" before place in FLASH_region command inside the .icf Script.</p> <p>e.g.</p> <pre data-bbox="467 1570 1362 1854">".text": place in FLASH_region { block LOCK_LOOKUP, ro, ro section .rodata, block QSPI_NON_RETENTIVE_INIT_BLOCK, block RAM_INIT_CODE, block USB_DEV_DESC_BLK };</pre>
25273	RZ Device Migration	When changing the device from a RZ/A1 and attempting to swap to a RZ/T1 the device migration is not successful.

		<p>The source code is not migrated successfully and the build fails.</p> <p>This is due to the different start-up code structure between these devices.</p> <p>In this case please create a new project and copy the required source to the newly created project.</p>
25195	RZ/A2M Smart Configurator	<p>When creating a project of RZ / A2M, the following Warning is displayed in the Problems view for the src / renesas / configuration folder.</p> <p>"Invalid project path: Include path not found"</p> <p>[Workaround]</p> <p>Delete the specification of this folder with the compile option include path setting.</p>
25018	Synergy RTOS debugging	<p>When debugging a project with many threads (e.g. 150 threads) while having the RTOS Resource View open, e2 studio might hang and become unresponsive.</p> <p>A workaround for this is to make the RTOS Resource View small and expand it once the Debug Tree View has finished updating.</p> <p>Alternatively, you can disable the debug view OS support within the debug configuration.</p>
24883	R2/A2M	<p>RZ / A2M project generated by e2 studio does not support GCC ARM 7.x. Please use GCC ARM 6.3.</p>

9. Open Issues in 7.3.0

Open issues in the e² studio 7.3 product will be kept up to date [here](#):

Please visit to see the latest open issue list.

10. Appendix

10.1 Website and Support

Renesas Electronics Website

<http://www.renesas.com/>

Inquiries

<http://www.renesas.com/contact/>

All trademarks and registered trademarks are the property of their respective owners.

Notice

1. Descriptions of circuits, software and other related information in this document are provided only to illustrate the operation of semiconductor products and application examples. You are fully responsible for the incorporation or any other use of the circuits, software, and information in the design of your product or system. Renesas Electronics disclaims any and all liability for any losses and damages incurred by you or third parties arising from the use of these circuits, software, or information.
2. Renesas Electronics hereby expressly disclaims any warranties against and liability for infringement or any other claims involving patents, copyrights, or other intellectual property rights of third parties, by or arising from the use of Renesas Electronics products or technical information described in this document, including but not limited to, the product data, drawings, charts, programs, algorithms, and application examples.
3. No license, express, implied or otherwise, is granted hereby under any patents, copyrights or other intellectual property rights of Renesas Electronics or others.
4. You shall not alter, modify, copy, or reverse engineer any Renesas Electronics product, whether in whole or in part. Renesas Electronics disclaims any and all liability for any losses or damages incurred by you or third parties arising from such alteration, modification, copying or reverse engineering.
5. Renesas Electronics products are classified according to the following two quality grades: "Standard" and "High Quality". The intended applications for each Renesas Electronics product depends on the product's quality grade, as indicated below.
"Standard": Computers; office equipment; communications equipment; test and measurement equipment; audio and visual equipment; home electronic appliances; machine tools; personal electronic equipment; industrial robots; etc.
"High Quality": Transportation equipment (automobiles, trains, ships, etc.); traffic control (traffic lights); large-scale communication equipment; key financial terminal systems; safety control equipment; etc.
Unless expressly designated as a high reliability product or a product for harsh environments in a Renesas Electronics data sheet or other Renesas Electronics document, Renesas Electronics products are not intended or authorized for use in products or systems that may pose a direct threat to human life or bodily injury (artificial life support devices or systems; surgical implantations; etc.), or may cause serious property damage (space system; undersea repeaters; nuclear power control systems; aircraft control systems; key plant systems; military equipment; etc.). Renesas Electronics disclaims any and all liability for any damages or losses incurred by you or any third parties arising from the use of any Renesas Electronics product that is inconsistent with any Renesas Electronics data sheet, user's manual or other Renesas Electronics document.
6. When using Renesas Electronics products, refer to the latest product information (data sheets, user's manuals, application notes, "General Notes for Handling and Using Semiconductor Devices" in the reliability handbook, etc.), and ensure that usage conditions are within the ranges specified by Renesas Electronics with respect to maximum ratings, operating power supply voltage range, heat dissipation characteristics, installation, etc. Renesas Electronics disclaims any and all liability for any malfunctions, failure or accident arising out of the use of Renesas Electronics products outside of such specified ranges.
7. Although Renesas Electronics endeavors to improve the quality and reliability of Renesas Electronics products, semiconductor products have specific characteristics, such as the occurrence of failure at a certain rate and malfunctions under certain use conditions. Unless designated as a high reliability product or a product for harsh environments in a Renesas Electronics data sheet or other Renesas Electronics document, Renesas Electronics products are not subject to radiation resistance design. You are responsible for implementing safety measures to guard against the possibility of bodily injury, injury or damage caused by fire, and/or danger to the public in the event of a failure or malfunction of Renesas Electronics products, such as safety design for hardware and software, including but not limited to redundancy, fire control and malfunction prevention, appropriate treatment for aging degradation or any other appropriate measures. Because the evaluation of microcomputer software alone is very difficult and impractical, you are responsible for evaluating the safety of the final products or systems manufactured by you.
8. Please contact a Renesas Electronics sales office for details as to environmental matters such as the environmental compatibility of each Renesas Electronics product. You are responsible for carefully and sufficiently investigating applicable laws and regulations that regulate the inclusion or use of controlled substances, including without limitation, the EU RoHS Directive, and using Renesas Electronics products in compliance with all these applicable laws and regulations. Renesas Electronics disclaims any and all liability for damages or losses occurring as a result of your noncompliance with applicable laws and regulations.
9. Renesas Electronics products and technologies shall not be used for or incorporated into any products or systems whose manufacture, use, or sale is prohibited under any applicable domestic or foreign laws or regulations. You shall comply with any applicable export control laws and regulations promulgated and administered by the governments of any countries asserting jurisdiction over the parties or transactions.
10. It is the responsibility of the buyer or distributor of Renesas Electronics products, or any other party who distributes, disposes of, or otherwise sells or transfers the product to a third party, to notify such third party in advance of the contents and conditions set forth in this document.
11. This document shall not be reprinted, reproduced or duplicated in any form, in whole or in part, without prior written consent of Renesas Electronics.
12. Please contact a Renesas Electronics sales office if you have any questions regarding the information contained in this document or Renesas Electronics products.

(Note 1) "Renesas Electronics" as used in this document means Renesas Electronics Corporation and also includes its directly or indirectly controlled subsidiaries.

(Note 2) "Renesas Electronics product(s)" means any product developed or manufactured by or for Renesas Electronics.



SALES OFFICES

Renesas Electronics Corporation

<http://www.renesas.com>

Refer to "<http://www.renesas.com/>" for the latest and detailed information.

Renesas Electronics Corporation
TOYOSU FORESIA, 3-2-24 Toyosu, Koto-ku, Tokyo 135-0061, Japan

Renesas Electronics America Inc.
1001 Murphy Ranch Road, Milpitas, CA 95035, U.S.A.
Tel: +1-408-432-8888, Fax: +1-408-434-5351

Renesas Electronics Canada Limited
9251 Yonge Street, Suite 8309 Richmond Hill, Ontario Canada L4C 9T3
Tel: +1-905-237-2004

Renesas Electronics Europe Limited
Dukes Meadow, Millboard Road, Bourne End, Buckinghamshire, SL8 5FH, U.K.
Tel: +44-1628-651-700

Renesas Electronics Europe GmbH
Arcadiastrasse 10, 40472 Düsseldorf, Germany
Tel: +49-211-6503-0, Fax: +49-211-6503-1327

Renesas Electronics (China) Co., Ltd.
Room 1709 Quantum Plaza, No.27 ZhichunLu, Haidian District, Beijing, 100191 P. R. China
Tel: +86-10-8235-1155, Fax: +86-10-8235-7679

Renesas Electronics (Shanghai) Co., Ltd.
Unit 301, Tower A, Central Towers, 555 Langao Road, Putuo District, Shanghai, 200333 P. R. China
Tel: +86-21-2226-0888, Fax: +86-21-2226-0999

Renesas Electronics Hong Kong Limited
Unit 1601-1611, 16/F., Tower 2, Grand Century Place, 193 Prince Edward Road West, Mongkok, Kowloon, Hong Kong
Tel: +852-2265-6688, Fax: +852 2886-9022

Renesas Electronics Taiwan Co., Ltd.
13F, No. 363, Fu Shing North Road, Taipei 10543, Taiwan
Tel: +886-2-8175-9600, Fax: +886 2-8175-9670

Renesas Electronics Singapore Pte. Ltd.
80 Bendemeer Road, Unit #06-02 Hyflux Innovation Centre, Singapore 339949
Tel: +65-6213-0200, Fax: +65-6213-0300

Renesas Electronics Malaysia Sdn.Bhd.
Unit 1207, Block B, Menara Amcorp, Amcorp Trade Centre, No. 18, Jln Persiaran Barat, 46050 Petaling Jaya, Selangor Darul Ehsan, Malaysia
Tel: +60-3-7955-9390, Fax: +60-3-7955-9510

Renesas Electronics India Pvt. Ltd.
No.77C, 100 Feet Road, HAL 2nd Stage, Indiranagar, Bangalore 560 038, India
Tel: +91-80-67208700, Fax: +91-80-67208777

Renesas Electronics Korea Co., Ltd.
17F, KAMCO Yangjae Tower, 262, Gangnam-daero, Gangnam-gu, Seoul, 06265 Korea
Tel: +82-2-558-3737, Fax: +82-2-558-5338