

ISL71090SEH

Single Event Effects (SEE)

AN1848
Rev 0.00
July 17, 2015

Introduction

The intense proton and heavy ion environment encountered in space applications can cause a variety of single event effects in electronic circuitry, including Single Event Upset (SEU), Single Event Transient (SET), Single Event Functional Interrupt (SEFI) and Single Event Burnout (SEB). SEE can lead to system-level performance issues including disruption, degradation and destruction. For predictable and reliable space system operation, individual electronic components should be characterized to determine their SEE response. This report discusses the results of SEE testing performed on the [ISL71090SEH](#) product family of precision references.

Product Description

The ISL71090SEH is an ultra low noise, high DC accuracy precision voltage reference product family with a wide input range of 4V to 30V. Four voltage variants are available, 1.25V (ISL71090SEH12), 2.5V (ISL71090SEH25), 5.0V (ISL71090SEH50) and 7.5V (ISL71090SEH75). The ISL71090SEH uses Intersil's PR40 Advanced Bipolar technology to achieve sub 2 μ V_{p,p} noise at 0.1Hz and achieve 0.15% accuracy over-temperature and total ionizing dose radiation. Implementation in an advanced bonded wafer SOI process using deep trench isolation results in fully isolated structures and latch-up free performance, whether electrically or single event (SEL) caused.

Product Documentation

For more information about the ISL71090SEH, refer to the documentation shown below.

- [ISL71090SEH12](#), [ISL71090SEH25](#), [ISL71090SEH50](#), [ISL71090SEH75](#) Datasheets
- SMD: [5962-13211](#)
- [AN1847](#) - "ISL71090SEHxx User Guide"
- [AN1849](#) - "Total Dose Testing of the ISL71090SEH Precision Voltage Reference"

SEE Test Objectives

The ISL71090SEH was tested to determine its susceptibility to SEB and to characterize its SET behavior over various linear energy transfer (LET) ion levels.

SEE Test Facility

Testing was performed at the Texas A&M University (TAMU) Cyclotron Institute heavy ion facility. This facility is coupled to a K500 super-conducting cyclotron, which is capable of generating a wide range of test particles with the various energy, flux and fluence levels needed for advanced radiation testing.

SEE Test Setup

SEE testing is carried out with the sample in an active configuration. A schematic of the ISL71090SEH SEE test fixture is shown in [Figure 1 on page 2](#). The test circuit is configured to accept an input voltage from 4V to 30V and generate the nominal output voltage. The output current of the reference was adjusted using fixed load resistors on test board. The output capacitor, C₄, and the compensation capacitor C₂ were varied for some tests between 0.1 μ F to 10 μ F and 1nF to 10nF respectively.

Four ISL71090SEH test fixtures were mounted to a test jig, which could be moved with respect to the ion beam. The parts were assembled in dual in-line packages with the metal lid removed for beam exposure. Using 20-foot coaxial cables, the test jig was connected to a switch box in the control room, which contained all of the monitoring equipment. The switch box allowed any one of the four test circuits to be controlled and monitored remotely. Later testing utilized a board with four units mounted to allow them to be irradiated and monitored simultaneously.

Digital multimeters were used to monitor input voltage (V_{IN}), output voltage (V_{OUT}) and input current (I_{IN}). LeCroy waveRunner 4-channel digital oscilloscopes were used to set the trigger levels and to monitor, capture and store key signal waveforms. [Table 1](#) shows the scope configurations used during the testing.

TABLE 1. OSCILLOSCOPE CONFIGURATIONS

SCOPE	CHANNEL 1	TRIGGER SIGNAL	TRIGGER LEVEL
1	V _{OUT}	V _{OUT}	$\Delta V = \pm 20\text{mV}$
2	V _{OUT}	V _{OUT}	$\Delta V = \pm 75\text{mV}$

SEB Testing

For the SEB tests, conditions were selected to maximize the electrical and thermal stresses on the device under test (DUT), thus insuring worst-case conditions. The input voltage (V_{IN}) was initially set to 35V and then increased in 1V increments. The capacitors were set to $C_{OUT} = 0.1\mu\text{F}$ and $C_{COMP} = 1\text{nF}$. SEB testing was conducted with the ISL71090SEH25, hence the output voltage (V_{OUT}) was 2.5V. Output current (I_{OUT}) was set to 20mA which is the maximum recommended current rating for load regulation of the device. Case temperature was maintained at +125°C by controlling the current flowing into a resistive heater bonded to the underside of the DUT. This ensured that the junction temperature of the DUT exceeded +125°C, which is the maximum junction temperature anticipated for high reliability applications. Four DUTs were irradiated with Au ions at a normal

incident angle, resulting in an effective LET of $86.4\text{MeV} \cdot \text{cm}^2/\text{mg}$. Table 2 summarizes the results of SEB testing. The chart shows sample size and passing results for an input voltage level of 37V on each device.

The failure criterion for destructive SEE was an increase in operating input current (I_{IN}) greater than 5% measured at 20mA output current. I_{IN} is defined as the total current drawn by the device. Failed devices were not further irradiated.

From a design perspective, all the products in the ISL71090SEH product family are exactly the same in silicon. The output voltage, even though they are different values, are produced the same way and trimmed through a resistor ladder network. All the parts are built in the same process and are functionally equivalent. Therefore, all ISL71090SEH25 SEB results are applicable to the complete product family.

TABLE 2. ISL71090SEH SEB TEST RESULTS. SAMPLES WERE TESTED WITH INCREASING INPUT VOLTAGE (V_{IN}) UNTIL FAILURE.

TEMPERATURE (°C)	LET	SUPPLY CURRENT PRE-EXPOSURE (mA)	SUPPLY CURRENT POST- EXPOSURE (mA)	LATCH EVENTS	CUMULATIVE FLUENCE (PARTICLES/cm ²)	DEVICE ID	SEB/L
+125	86.3	21.364	21.365	0	2.00E+06	1	PASS
+125	86.3	21.379	21.376	0	2.00E+06	2	PASS
+125	86.3	21.359	21.358	0	2.00E+06	3	PASS
+125	86.3	21.356	21.354	0	2.00E+06	4	PASS
Total Events				0			
Overall Fluence					8.00E+06		
Total Units						4	

NOTE: The chart shows sample size and pass results for the input voltage level of 37V as well as the total effective fluence for each level.

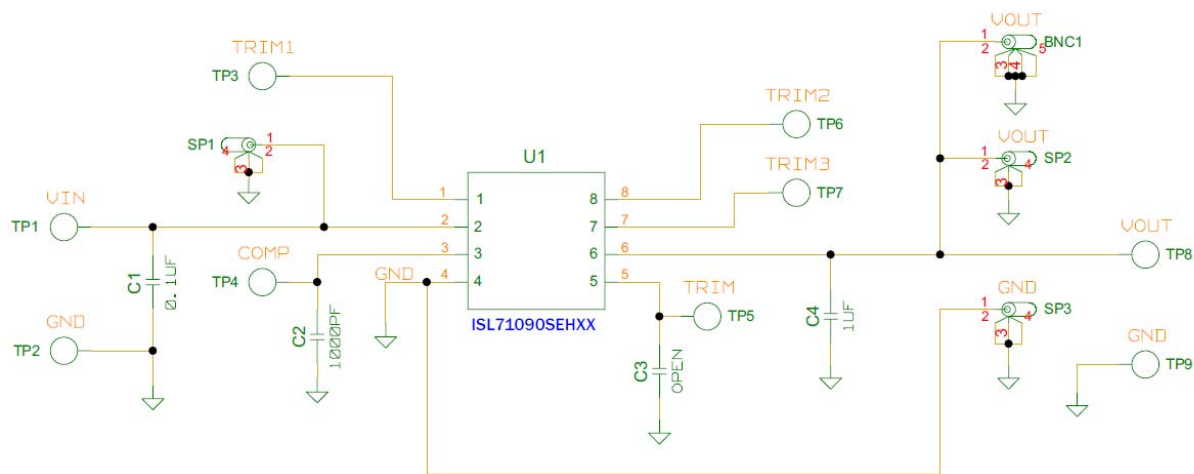

FIGURE 1. SCHEMATIC OF THE ISL71090SEH SEE TEST CIRCUIT

SET Testing of ISL71090SEH25, 2.5V Output Samples

The first set of SET testing of the ISL71090SEH family was done on four samples of the ISL71090SEH25, which were irradiated at room temperature across a range of LET from $2.7\text{MeV} \cdot \text{cm}^2/\text{mg}$ to $86.4\text{MeV} \cdot \text{cm}^2/\text{mg}$ to observe SET performance. Samples were separately tested to V_{IN} of 4V and 30V. The parts were configured with $0.1\mu\text{F}$ output capacitor, 1nF compensation capacitor and 20mA load current to set up the worst conditions for negative going transients. [Table 3](#) shows the SET summary giving the cross section for each input voltage and LET level. [Figure 2](#) is the LET threshold plot produced from the SET summary table.

[Figures 3](#) through [12](#) represent output waveform responses of the DUTs at the respective bias conditions and LET levels. The plots are composites of all the transients captured on the scope. This information is useful in quantifying the excursion of the output voltage as a result of SEE induced transients.

The worst case SET appeared for the case of $\text{LET} = 56$ and $V_{IN} = 4\text{V}$ with about 340mV in negative SET. The second worst case appeared for $\text{LET} = 86$ and $V_{IN} = 4\text{V}$ at about 325mV . The longest recovery times were about $50\mu\text{s}$.

TABLE 3. SET SUMMARY OF FULLY FUNCTIONAL ISL71090SEH25 SAMPLES AT 4.0V AND 30V INPUT VOLTAGE., $C_{OUT} = 0.1\mu\text{F}$, $C_{COMP} = 1\text{nF}$ AND $I_{OUT} = 20\text{mA}$. TRIGGER LEVEL FOR THE OUTPUT VOLTAGE SET TO $\pm 20\text{mV}$.

SUPPLY VOLTAGE (V)	ION/ANGLE	EFF LET ($\text{MeV} \cdot \text{cm}^2/\text{mg}$)	FLUENCE PER RUN (PARTICLES/ cm^2)	NUMBER OF RUNS	TOTAL SET	EVENTS CS (cm^2)
4	Ne/0	2.7	$2.00\text{E}+06$	4	40	$5.00\text{E}-06$
30	Ne/0	2.7	$2.00\text{E}+06$	4	6	$7.50\text{E}-07$
4	Ar/0	8.5	$2.00\text{E}+06$	4	256	$3.20\text{E}-05$
30	Ar/0	8.5	$2.00\text{E}+06$	4	365	$4.56\text{E}-05$
4	Kr/0	28	$2.00\text{E}+06$	4	439	$5.49\text{E}-05$
30	Kr/0	28	$2.00\text{E}+06$	4	754	$9.43\text{E}-05$
4	Kr/60	56	$2.00\text{E}+06$	2	365	$9.13\text{E}-05$
30	Kr/60	56	$2.00\text{E}+06$	2	590	$1.48\text{E}-04$
4	Au/0	86.3	$2.00\text{E}+06$	4	609	$7.61\text{E}-05$
30	Au/0	86.3	$2.00\text{E}+06$	4	944	$1.18\text{E}-04$

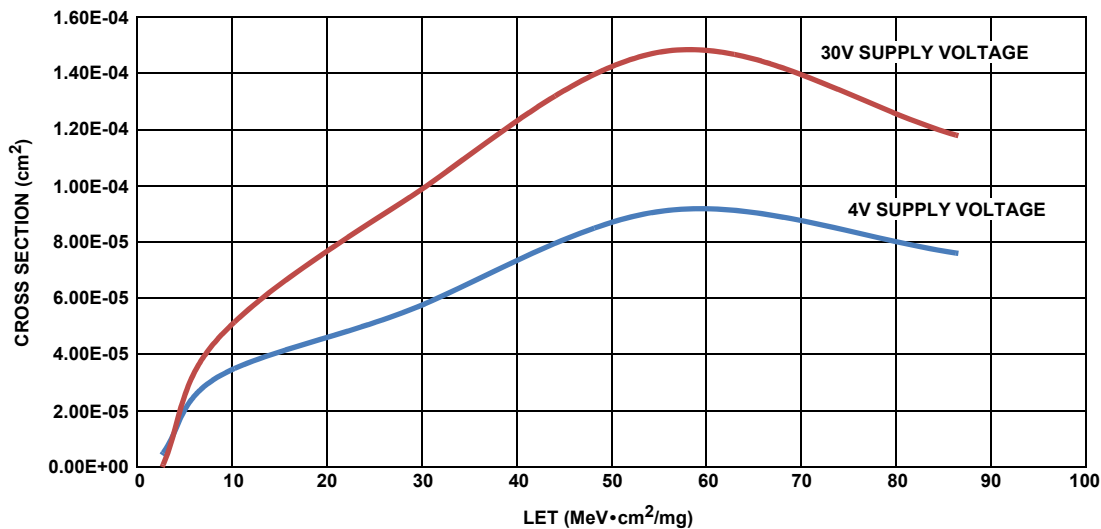

FIGURE 2. ISL71090SEH25 LET THRESHOLD PLOT FOR $\pm 20\text{mV}$ TRIGGER WINDOW WITH $C_{OUT} = 0.1\mu\text{F}$, $C_{COMP} = 1\text{nF}$ AND $I_{OUT} = 20\text{mA}$

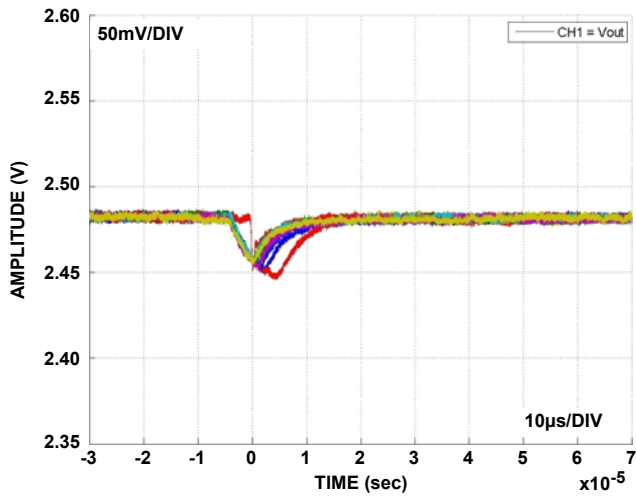

FIGURE 3. COMPOSITE SET PLOT FOR ISL71090SEH25 AT LET 2.7
 $V_{IN} = 4V, I_{OUT} = 20mA, C_{OUT} = 0.1\mu F, C_{COMP} = 1nF$

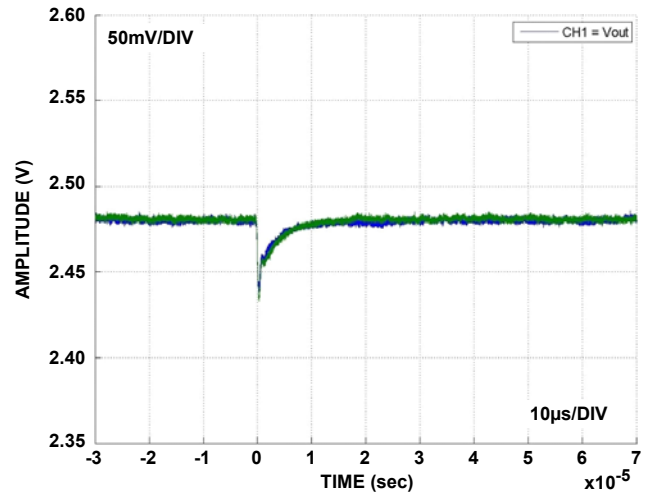

FIGURE 4. COMPOSITE SET PLOT FOR ISL71090SEH25 AT LET 2.7
 $V_{IN} = 30V, I_{OUT} = 20mA, C_{OUT} = 0.1\mu F, C_{COMP} = 1nF$

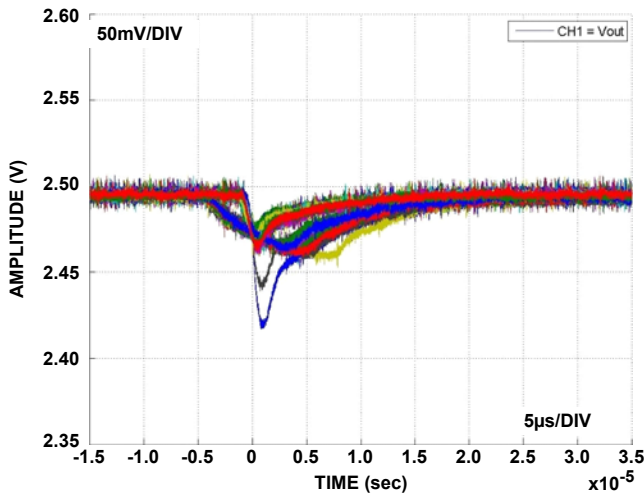

FIGURE 5. COMPOSITE SET PLOT FOR ISL71090SEH25 AT LET 8.5
 $V_{IN} = 4V, I_{OUT} = 20mA, C_{OUT} = 0.1\mu F, C_{COMP} = 1nF$

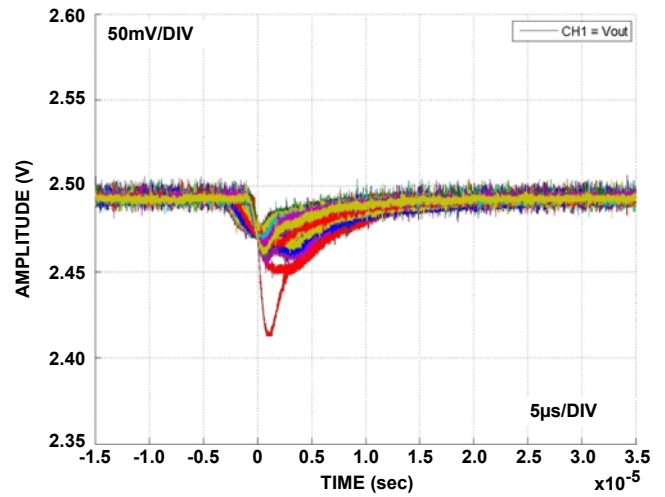

FIGURE 6. COMPOSITE SET PLOT FOR ISL71090SEH25 AT LET 8.5
 $V_{IN} = 30V, I_{OUT} = 20mA, C_{OUT} = 0.1\mu F, C_{COMP} = 1nF$

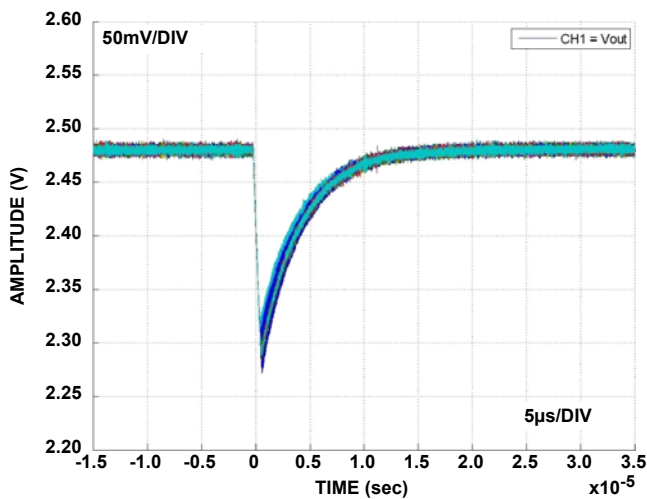

FIGURE 7. COMPOSITE SET PLOT FOR ISL71090SEH25 AT LET 28
 $V_{IN} = 4V, I_{OUT} = 20mA, C_{OUT} = 0.1\mu F, C_{COMP} = 1nF$

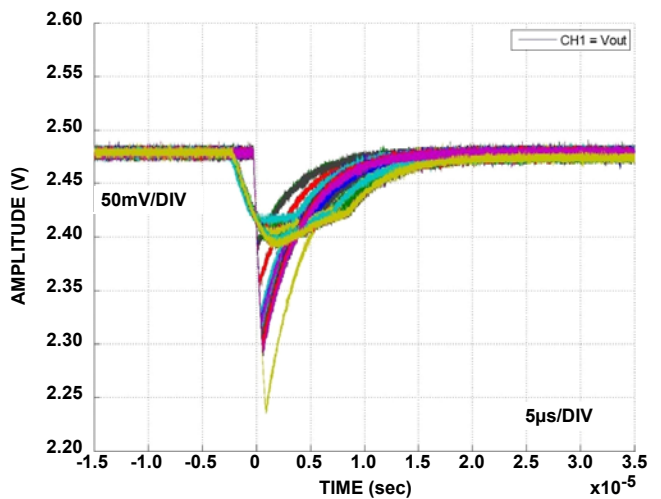

FIGURE 8. COMPOSITE SET PLOT FOR ISL71090SEH25 AT LET 28
 $V_{IN} = 30V, I_{OUT} = 20mA, C_{OUT} = 0.1\mu F, C_{COMP} = 1nF$

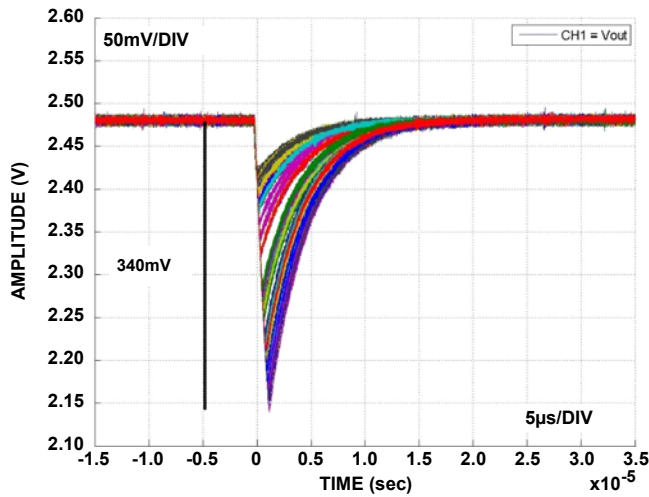

FIGURE 9. COMPOSITE SET PLOT FOR ISL71090SEH25 AT LET 56
 $V_{IN} = 4V, I_{OUT} = 20mA, C_{OUT} = 0.1\mu F, C_{COMP} = 1nF$

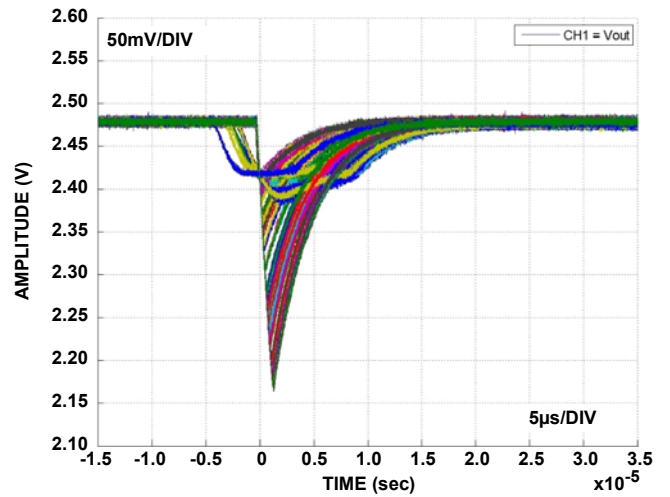

FIGURE 10. COMPOSITE SET PLOT FOR ISL71090SEH25 AT LET 56
 $V_{IN} = 30V, I_{OUT} = 20mA, C_{OUT} = 0.1\mu F, C_{COMP} = 1nF$

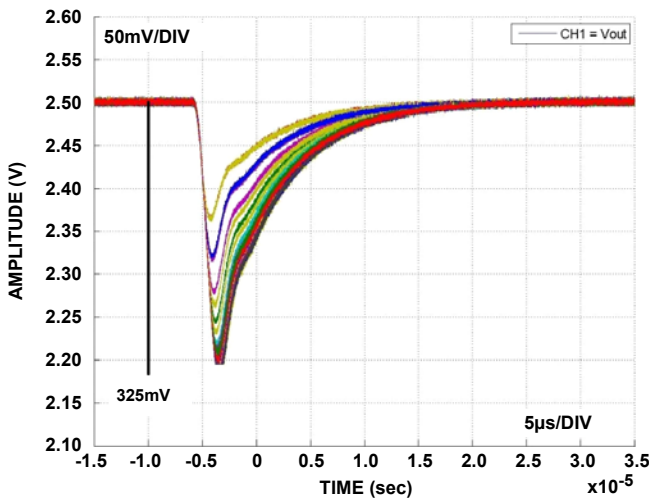

FIGURE 11. COMPOSITE SET PLOT FOR ISL71090SEH25 AT LET 86
 $V_{IN} = 4V, I_{OUT} = 20mA, C_{OUT} = 0.1\mu F, C_{COMP} = 1nF$.
 THE SCOPE CAPTURE WAS TRUNCATED AT 2.2V

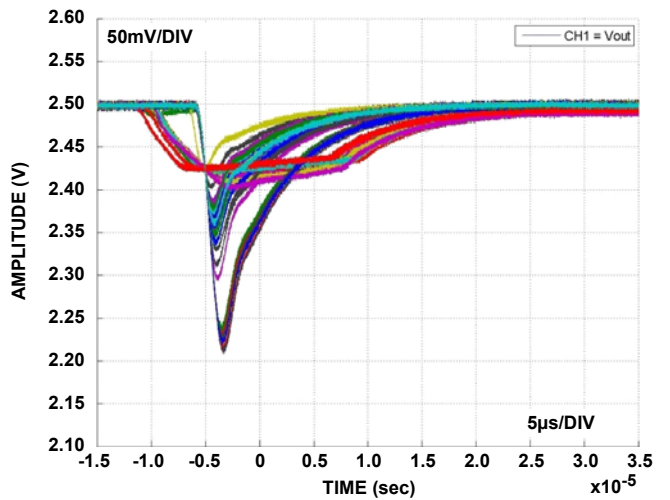

FIGURE 12. COMPOSITE SET PLOT FOR ISL71090SEH25 AT LET 86
 $V_{IN} = 30V, I_{OUT} = 20mA, C_{OUT} = 0.1\mu F, C_{COMP} = 1nF$

SET Testing of ISL71090SEH12, 1.25V Output Samples

Two samples of the ISL71090SEH12 were irradiated at room temperature at LET 58 to observe SET performance. Samples were separately tested to V_{IN} of 4V and 30V. Table 4 shows the SET summary for this initial testing.

Figures 13 and 14 are composite plots of all the transients captured on the scope in this SET test condition for the ISL71090SEH12. Again these two parts were operated with $C_{OUT} = 0.1\mu F$, $C_{COMP} = 1nF$, and $I_{OUT} = 20mA$.

TABLE 4. SET SUMMARY OF FULLY FUNCTIONAL ISL71090SEH12 SAMPLES AT 4.0V AND 30V INPUT VOLTAGE. TRIGGER LEVEL FOR THE OUTPUT VOLTAGE SET TO $\pm 20mV$.

SUPPLY VOLTAGE (V)	ION/ANGLE	EFF LET (MeVcm ² /mg)	FLUENCE PER RUN (PARTICLES/cm ²)	NUMBER OF RUNS	TOTAL SET	EVENTS CS (cm ²)
4	Pr/0	58	2.00E+06	2	150	7.5E-05
30	Pr/0	58	2.00E+06	2	256	1.28E-04

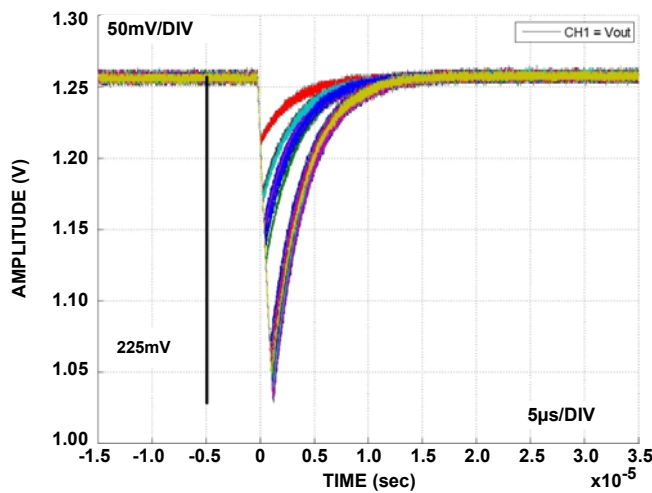

FIGURE 13. COMPOSITE SET PLOT FOR ISL71090SEH12 AT LET 58
 $V_{IN} = 4V$, $I_{OUT} = 20mA$, $C_{OUT} = 0.1\mu F$, $C_{COMP} = 1nF$

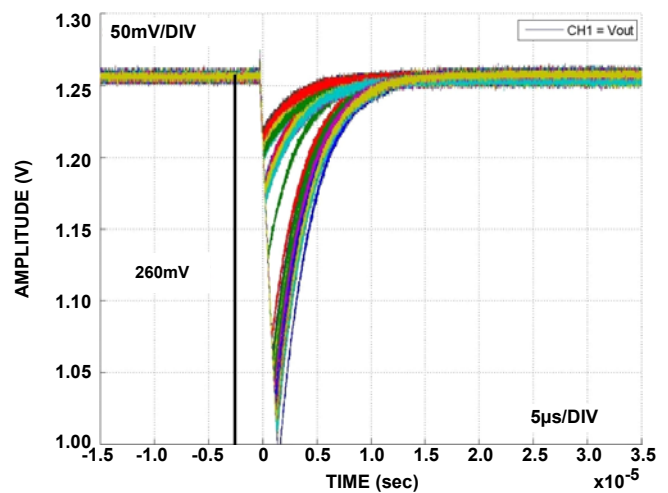

FIGURE 14. COMPOSITE SET PLOT FOR ISL71090SEH12 AT LET 58
 $V_{IN} = 30V$, $I_{OUT} = 20mA$, $C_{OUT} = 0.1\mu F$, $C_{COMP} = 1nF$.
 THE SCOPE CAPTURE WAS TRUNCATED AT 1.0V

SET Testing of ISL71090SEH75, 7.5V Output Samples

Four samples of the 7.5V part, ISL71090SEH75, were run for SET with $I_{OUT} = 20\text{mA}$, $C_{OUT} = 0.1\mu\text{F}$, $V_{IN} = 9.2\text{V}$ and 30V , at $LET = 8.5, 28, \text{ and } 56 \text{ MeV}\cdot\text{cm}^2/\text{mg}$. The summary of the testing is below. [Table 5](#) provides the SET count versus LET

summary and [Figure 15](#) shows a plot of the SET cross section (events/fluence). The first two parts had $C_{OUT} = 0.1\mu\text{F}$ and $C_{COMP} = 1\text{nF}$ (datasheet recommendation). Composite SET plots for one of these two parts are shown in [Figures 16](#) and [17](#).

TABLE 5. SET SUMMARY OF FULLY FUNCTIONAL ISL71090SEH75 SAMPLES AT 9.2V AND 30V INPUT VOLTAGE. TRIGGER LEVEL FOR THE OUTPUT VOLTAGE SET TO $\pm 75\text{mV}$.

SUPPLY VOLTAGE (V)	LET (MeV·cm ² /mg)	FLUENCE (PARTICLES/cm ²)	EVENTS ($\pm 75\text{mV}$)	σ (cm ²)
9.2	8.5	8.00E+06	342	4.28E-05
30	8.5	8.00E+06	430	5.38E-05
9.2	28	8.00E+06	866	1.08E-04
30	28	8.00E+06	1186	1.48E-04
9.2	56	8.00E+06	827	1.03E-04
30	56	8.00E+06	1359	1.70E-04

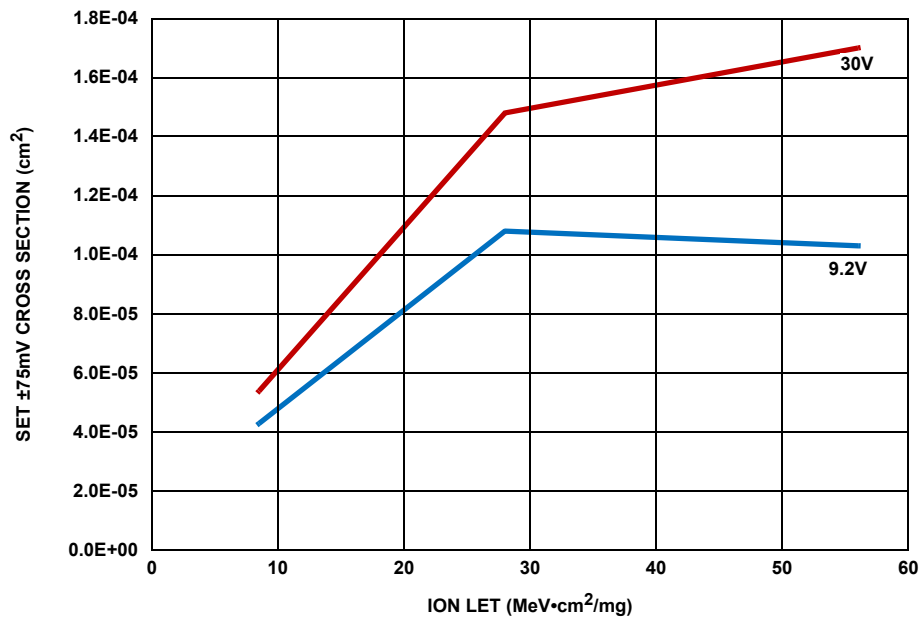

FIGURE 15. ISL71090SEH75 LET THRESHOLD PLOT FOR $\pm 75\text{mV}$ TRIGGER WINDOW WITH $C_{OUT} = 0.1\mu\text{F}$ AND $I_{OUT} = 20\text{mA}$

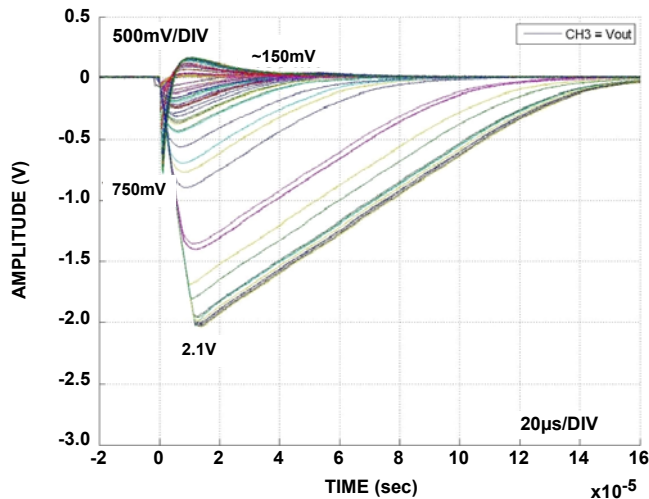

FIGURE 16. COMPOSITE SET PLOT FOR ISL71090SEH75 AT LET 56
 $V_{IN} = 9.2V$, $C_{OUT} = 0.1\mu F$, $C_{COMP} = 1nF$

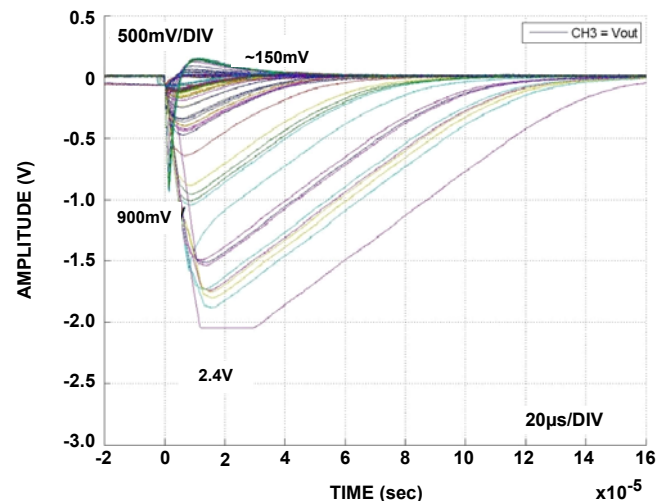

FIGURE 17. COMPOSITE SET PLOT FOR ISL71090SEH75 AT LET 56
 $V_{IN} = 30V$, $C_{OUT} = 0.1\mu F$, $C_{COMP} = 1nF$

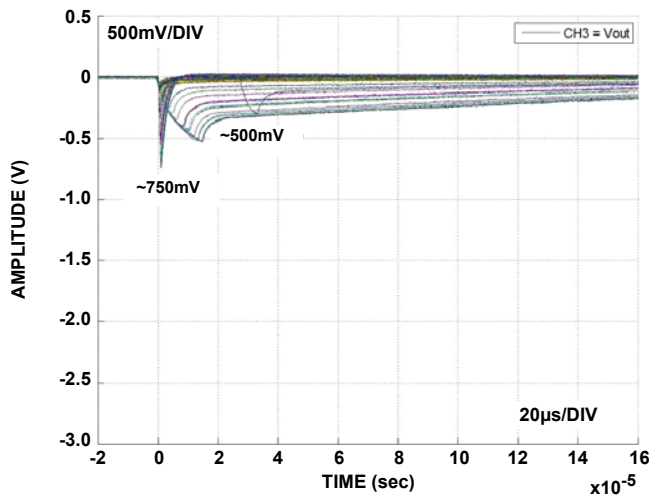

FIGURE 18. COMPOSITE SET PLOT FOR ISL71090SEH75 AT LET 56
 $V_{IN} = 9.2V$, $C_{OUT} = 0.1\mu F$, $C_{COMP} = 10nF$

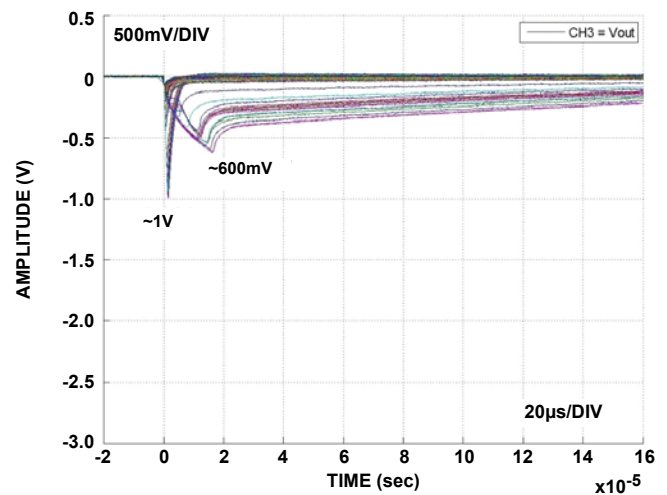

FIGURE 19. COMPOSITE SET PLOT FOR ISL71090SEH75 AT LET 56
 $V_{IN} = 30V$, $C_{OUT} = 0.1\mu F$, $C_{COMP} = 10nF$

The SET displayed above exhibit two forms. The first is a very rapid drop in voltage to close to -1V from regulation and followed by a rapid recovery and substantial overshoot (100mV to 150mV). The type exhibits a slower and prolonged drop in output voltage with terminal values -2.5V from regulation. Recovery from the second form is slower but does not show a pronounced overshoot.

Two more ISL71090SEH75 parts were then tested with $C_{COMP} = 10nF$ but still with $C_{OUT} = 0.1\mu F$. The results from one of these parts are shown in [Figures 18](#) and [19](#).

The higher value of C_{COMP} significantly reduced the SET. The long slow SET was reduced from ~2.5V to ~600mV and the sharp SET was essentially unchanged with a magnitude of about 1V but without the recovery overshoot. So, from an SET mitigation perspective, the bandwidth limiting of the larger C_{COMP} is preferable.

The SET resulting from ions (Ar) with $LET = 8.5MeV \cdot cm^2/mg$ are shown in [Figures 20](#) and [21](#). Even at this low LET the part exhibited SET of 400mV magnitude.

Four more ISL71090SEH75 parts were run for SET testing to explore the impact of capacitor selection as described in [Table 6 on page 9](#).

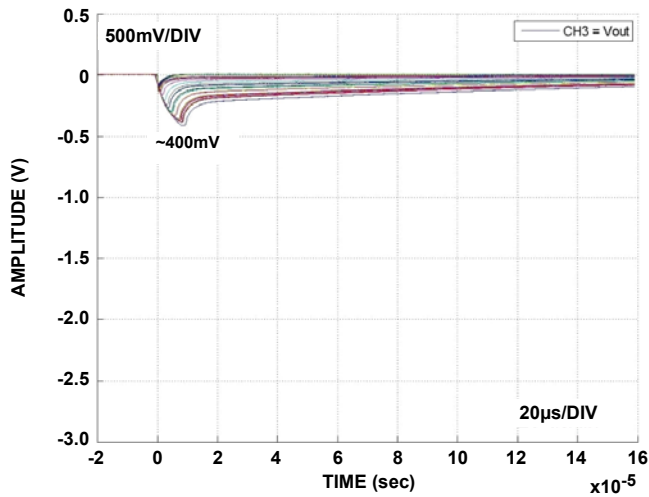

FIGURE 20. COMPOSITE SET PLOT FOR ISL71090SEH75 AT LET 8.5
 $V_{IN} = 9.2V$, $C_{OUT} = 0.1\mu F$, $C_{COMP} = 10nF$

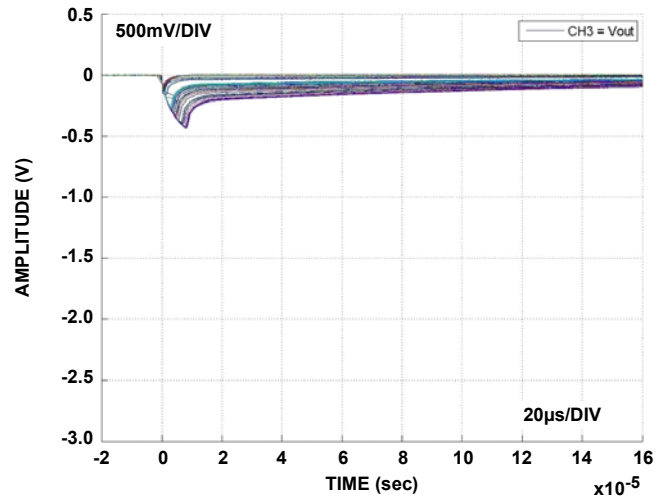

FIGURE 21. COMPOSITE SET PLOT FOR ISL71090SEH75 AT LET 8.5
 $V_{IN} = 30V$, $C_{OUT} = 0.1\mu F$, $C_{COMP} = 10nF$

TABLE 6. SUMMARY OF CONDITIONS FOR SECOND ROUND OF SET RUNS ON THE ISL71090SEH75

RUN	LET (MeV • cm ² /mg)	IOUT (mA)	VIN (V)	SET COUNTS (±20mV), 4E+06 ION/CM ²			
				C _{OUT} = 1µF C _{COMP} = 1nF		C _{OUT} = 10µF C _{COMP} = 10nF	
				DUT 1	DUT 2	DUT 3	DUT 4
311	28	-10	9.2	832	87	210	55
312			30	1074	115	312	71
313		20	9.2	869	231	224	72
314			30	1193 ^(Figure 22)	238	304 ^(Figure 24)	97
211	8.5	-10	9.2	221	52	60	40
212			30	317	69	93	50
213		20	9.2	265	67	55	60
214			30	314	83	91	72
111	2.7	-10	9.2	154	28	21	22
112			30	133	6	2	2
113		20	9.2	147	12	20	25
114			30	120 ^(Figure 23)	17	16	27

NOTE: Bold entries with superscripts are shown as composite plot figures.

Figure 22 shows a composite of large negative going SET for DUT1 run 314. The worst of these SET bottom out at about -1.4V deviation. These are about 175 μ s at return to cross nominal before overshooting about 100mV. Certainly not all of the SET are this severe, but a good number are. Even at LET of 2.7MeV \cdot cm²/mg (DUT1 run 114) Figure 23 shows a few SET to

-600mV. Clearly the part is sensitive to lower LET ions. Comparing Figures 22 and 24 shows the impact of going to larger capacitors (C_{OUT} from 1 μ F to 10 μ F and C_{COMP} from 1nF to 10nF). The change reduces worst SET for LET 27 deviations from -1.4V to 0.18V, though the recovery time is considerably stretched out.

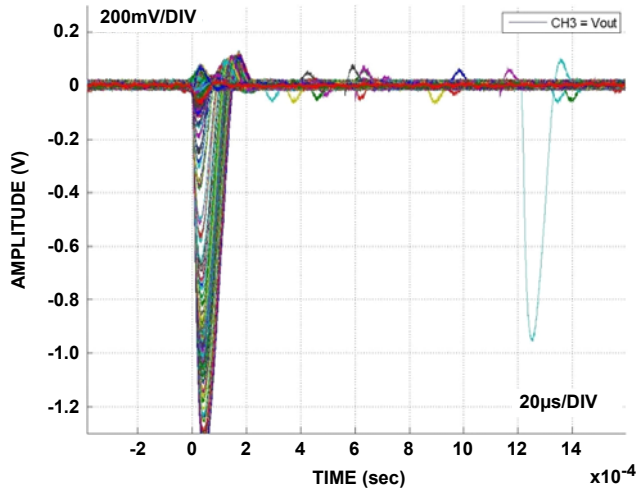

FIGURE 22. COMPOSITE SET PLOT FOR ISL71090SEH75 AT LET 28
 $V_{IN} = 30V$, $I_{OUT} = 20mA$, $C_{OUT} = 1\mu F$, $C_{COMP} = 1nF$

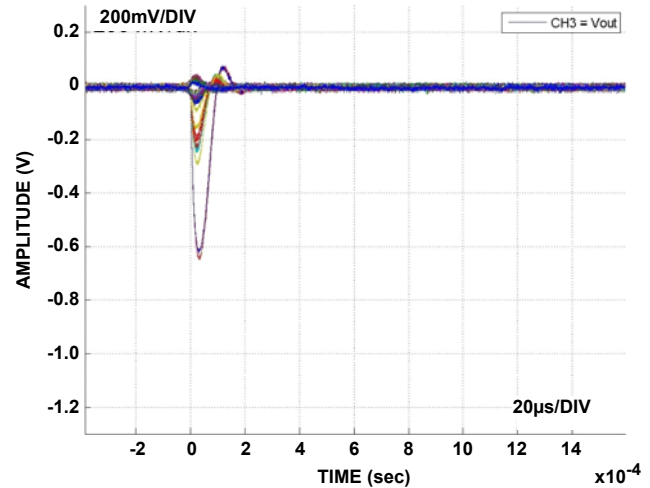

FIGURE 23. COMPOSITE SET PLOT FOR ISL71090SEH75 AT LET 2.7
 $V_{IN} = 30V$, $I_{OUT} = 20mA$, $C_{OUT} = 1\mu F$, $C_{COMP} = 1nF$

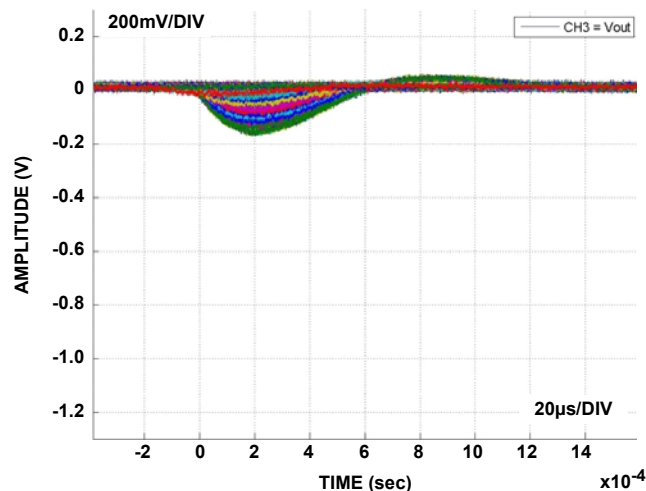

FIGURE 24. COMPOSITE SET PLOT FOR ISL71090SEH75 AT LET 28, $V_{IN} = 30V$, $I_{OUT} = 20mA$, $C_{OUT} = 10\mu F$, $C_{COMP} = 10nF$

SET Testing of ISL71090SEH50, 5.0V Output Samples

Four samples of the 5.0V part, ISL71090SEH50, were run for SET with $I_{OUT} = 20\text{mA}$, $C_{OUT} = 0.1\mu\text{F}$, $C_{COMP} = 10\text{nF}$, $V_{IN} = 7\text{V}$ and 30V , at LET = 8.5, 28 and $56\text{MeV}\cdot\text{cm}^2/\text{mg}$. The C_{COMP} was set to 10nF as it was determined to be better at suppressing SET on the 7.5V device. [Table 7](#) summarizes the SET event counts versus

LET and bias conditions. [Figure 25](#) provides plots of the SET cross section versus LET. The composite SET plots for one device in each of these six irradiation runs appear in [Figures 26](#) through [31](#).

TABLE 7. SET SUMMARY OF FULLY FUNCTIONAL ISL71090SEH50 SAMPLES AT 7V AND 30V INPUT VOLTAGE. TRIGGER LEVEL FOR THE OUTPUT VOLTAGE SET TO $\pm 50\text{mV}$.

SUPPLY VOLTAGE (V)	LET ($\text{MeV}\cdot\text{cm}^2/\text{mg}$)	FLUENCE (PARTICLES/ cm^2)	EVENTS ($\pm 50\text{mV}$)	σ (cm^2)
7	8.5	$8.00\text{E}+06$	375	$4.69\text{E}-05$
30	8.5	$8.00\text{E}+06$	442	$5.53\text{E}-05$
7	28	$8.00\text{E}+06$	743	$9.29\text{E}-05$
30	28	$8.00\text{E}+06$	1073	$1.34\text{E}-04$
7	56	$8.00\text{E}+06$	950	$1.19\text{E}-04$
30	56	$8.00\text{E}+06$	1308	$1.64\text{E}-04$

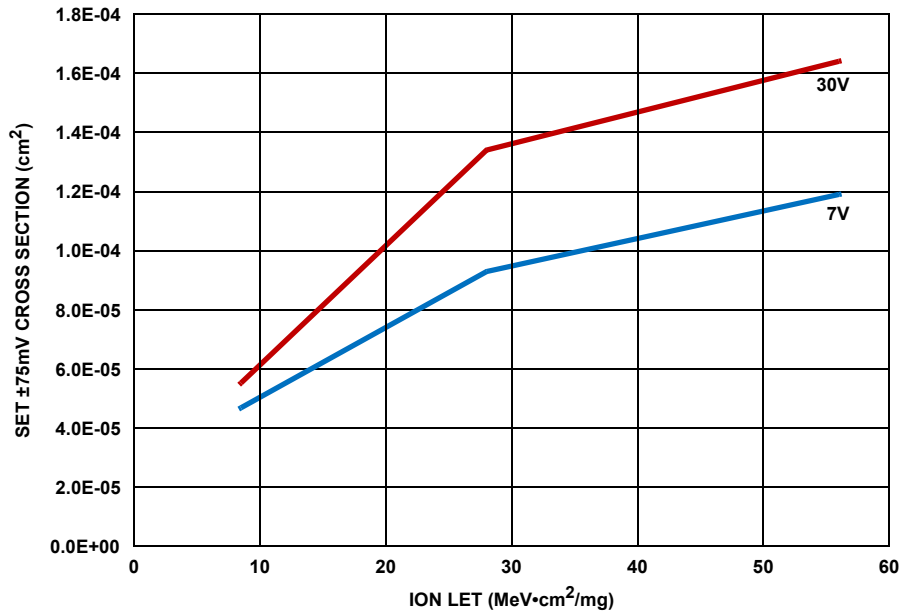

FIGURE 25. ISL71090SEH50 LET THRESHOLD PLOT FOR $\pm 50\text{mV}$ TRIGGER WINDOW WITH $C_{OUT} = 0.1\mu\text{F}$ AND $I_{OUT} = 20\text{mA}$

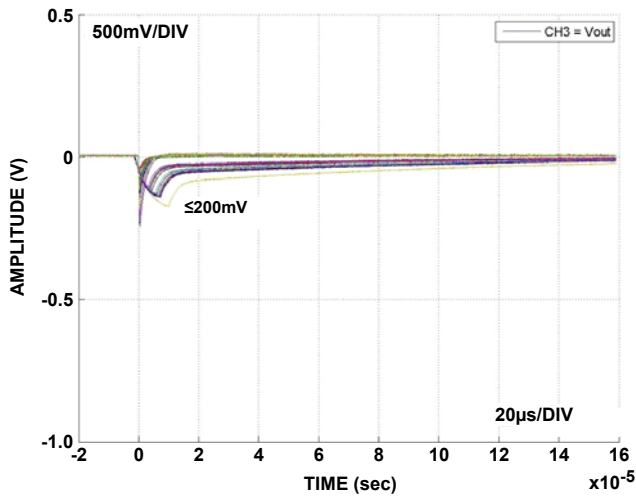

FIGURE 26. COMPOSITE SET PLOT FOR ISL71090SEH50 AT LET 8.5
 $V_{IN} = 7V, I_{OUT} = 20\text{mA}, C_{OUT} = 0.1\mu\text{F}, C_{COMP} = 10\text{nF}$

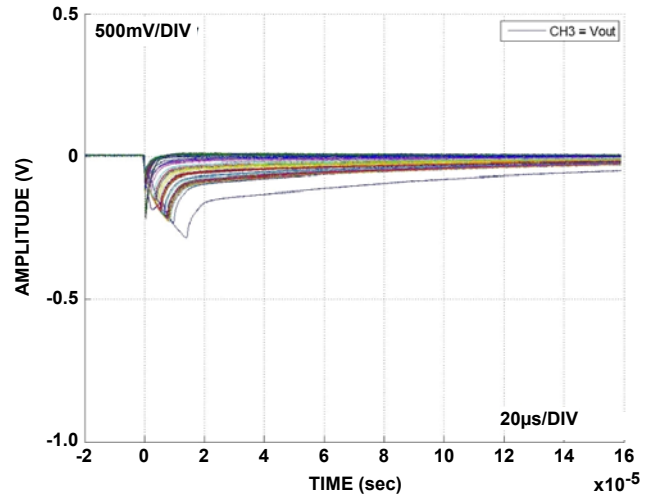

FIGURE 27. COMPOSITE SET PLOT FOR ISL71090SEH50 AT LET 8.5
 $V_{IN} = 30V, I_{OUT} = 20\text{mA}, C_{OUT} = 0.1\mu\text{F}, C_{COMP} = 10\text{nF}$

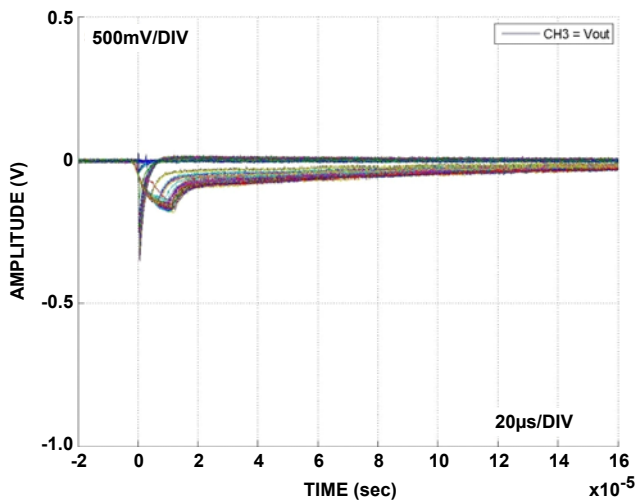

FIGURE 28. COMPOSITE SET PLOT FOR ISL71090SEH50 AT LET 28
 $V_{IN} = 7V, I_{OUT} = 20\text{mA}, C_{OUT} = 0.1\mu\text{F}, C_{COMP} = 10\text{nF}$

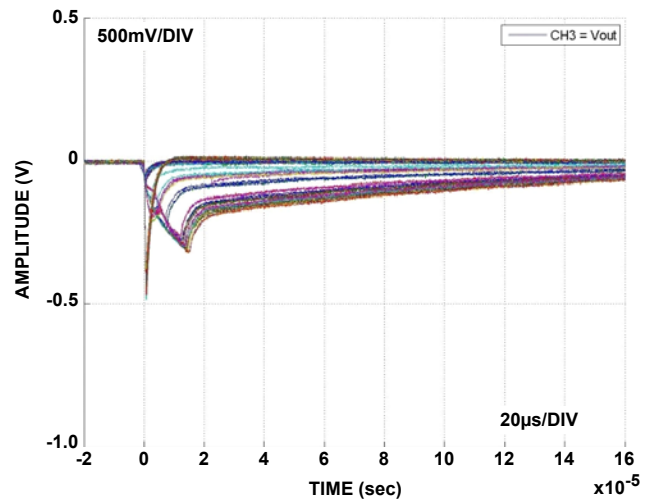

FIGURE 29. COMPOSITE SET PLOT FOR ISL71090SEH50 AT LET 28
 $V_{IN} = 30V, I_{OUT} = 20\text{mA}, C_{OUT} = 0.1\mu\text{F}, C_{COMP} = 10\text{nF}$

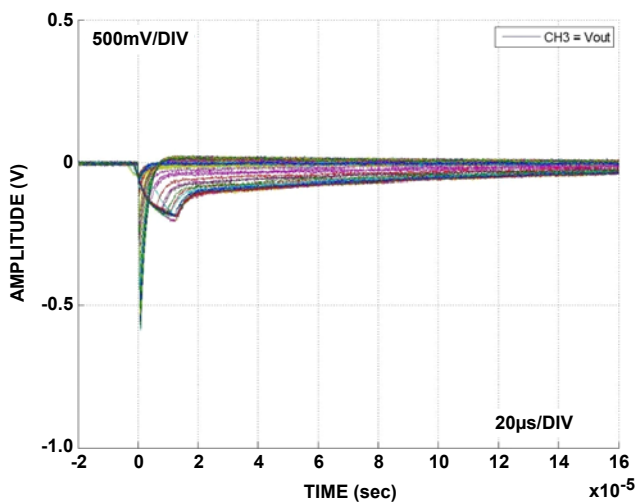

FIGURE 30. COMPOSITE SET PLOT FOR ISL71090SEH50 AT LET 56
 $V_{IN} = 7V, I_{OUT} = 20\text{mA}, C_{OUT} = 0.1\mu\text{F}, C_{COMP} = 10\text{nF}$

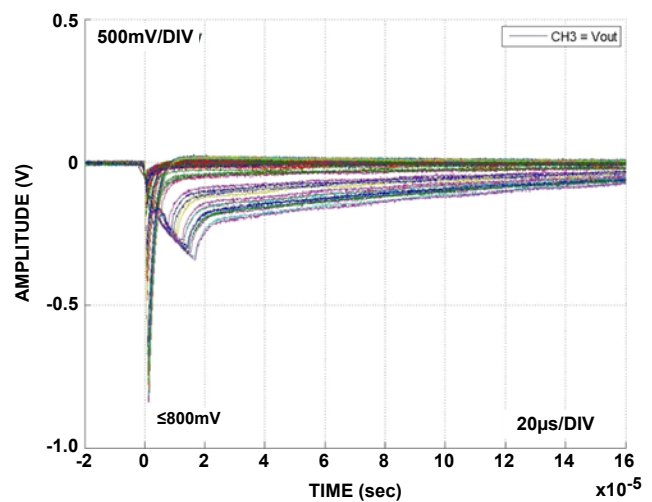

FIGURE 31. COMPOSITE SET PLOT FOR ISL71090SEH50 AT LET 56
 $V_{IN} = 30V, I_{OUT} = 20\text{mA}, C_{OUT} = 0.1\mu\text{F}, C_{COMP} = 10\text{nF}$

The SET exhibited by the ISL71090SEH50 fall into two basic categories; fast negative spike and slow negative ramp and recovery similar to the 7.5V reference. The fast spikes can be as large as 800mV for LET 56 and $V_{IN} = 30V$. Under the same conditions the slow (20 μ s) negative ramp can reach 300mV. The disturbances can take significantly over 160 μ s to recover. Even at LET = 8.5MeV \cdot cm²/mg (Figures 23 and 24), there are SET of approximately 200mV.

More SET testing of the ISL71090SEH50 took place to look at the impact of higher C_{OUT} values. The summary of the testing done and the resulting oscilloscope captures is presented in Table 8.

Significant SET were captured on DUT1 ($C_{OUT} = 1\mu F$, $C_{COMP} = 1nF$). Figure 32 on page 14 displays a composite plot for LET = 28MeV \cdot cm²/mg and $V_{IN} = 30V$ that range from -550mV to +70mV and a characteristic under damped response. The captures stopped at 150 μ s before the output had recovered fully. It is interesting that the initiating SET appears as a fast fall on the output, but the output follows a slow linear loop response recovery.

Figure 33 on page 14 shows that a change to $C_{OUT} = 10\mu F$ and $C_{COMP} = 10nF$ almost eliminate the SET resulting from LET = 28MeV \cdot cm²/mg at $V_{IN} = 30V$, the same conditions as in Figure 32. Comparison shows the significant reduction in the SET deviation although a long settling time is still evident.

Figure 34 on page 14 shows that leaving C_{OUT} at 1 μF but increasing C_{COMP} to 10nF provides significant improvement over the case in Figure 32 ($C_{OUT} = 1\mu F$, $C_{COMP} = 1nF$) but not as much as with $C_{OUT} = 10\mu F$.

Finally, reducing the LET to 2.7MeV \cdot cm²/mg for DUT1 ($C_{OUT} = 1\mu F$, $C_{COMP} = 1nF$) provides moderate suppression of the SET magnitudes as shown in Figure 35 on page 14. The worst case SET deviations are only about 200mV or one third of those seen at LET 28 in Figure 32. Clearly the change in capacitance is much more effective at limiting the SET deviation than the reduction in LET.

TABLE 8. SUMMARY OF QUAD TESTING OF ISL71090SEH50 PARTS BOLD ENTRIES WITH SUPERSCRIPTS ARE SHOWN AS COMPOSITE PLOT FIGURES

RUN	LET (MeV \cdot cm ² /mg)	IOUT (mA)	VIN (V)	SET COUNTS ($\pm 20mV$), 4E+06 ION/cm ²			
				$C_{OUT} = 1\mu F$ $C_{COMP} = 1nF$	$C_{OUT} = 1\mu F$ $C_{COMP} = 10nF$	$C_{OUT} = 10\mu F$ $C_{COMP} = 10nF$	
				DUT 1	DUT 2	DUT 3	DUT 4
301	28	-10	7	689	60	53	61
302			30	1022	85	84	34
303		20	7	707	218	121	45
304			30	879 (Figure 32)	224 (Figure 34)	117 (Figure 33)	87
201	8.5	-10	7	203	30	2	0
202			30	237	18	2	0
203		20	7	195	43	2	1
204			30	247	59	45	35
101	2.7	-10	7	141	16	0	0
102			30	139	0	0	0
103		20	7	122	2	0	0
104			30	129 (Figure 35)	9	0	3

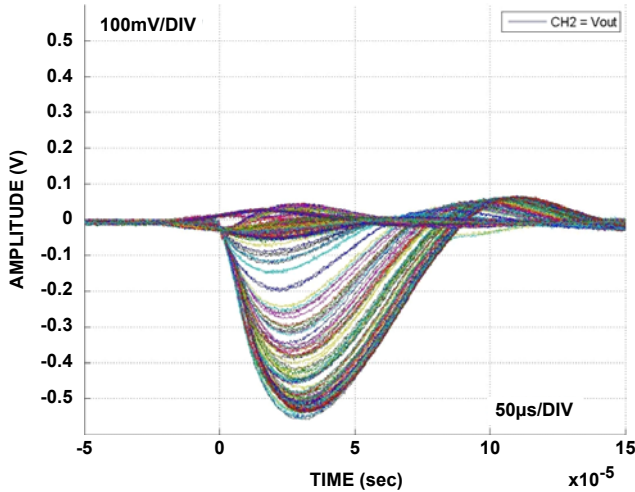

FIGURE 32. COMPOSITE SET PLOT FOR ISL71090SEH75 AT LET 28
 $V_{IN} = 30V, I_{OUT} = 20mA, C_{OUT} = 1\mu F, C_{COMP} = 1nF$

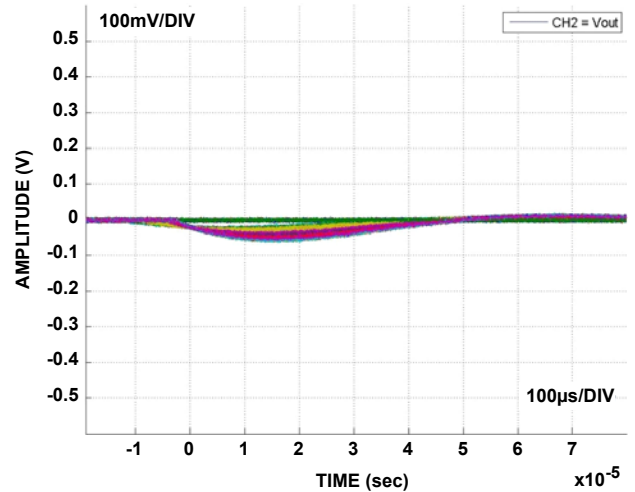

FIGURE 33. COMPOSITE SET PLOT FOR ISL71090SEH75 AT LET 28
 $V_{IN} = 30V, I_{OUT} = 20mA, C_{OUT} = 10\mu F, C_{COMP} = 10nF$

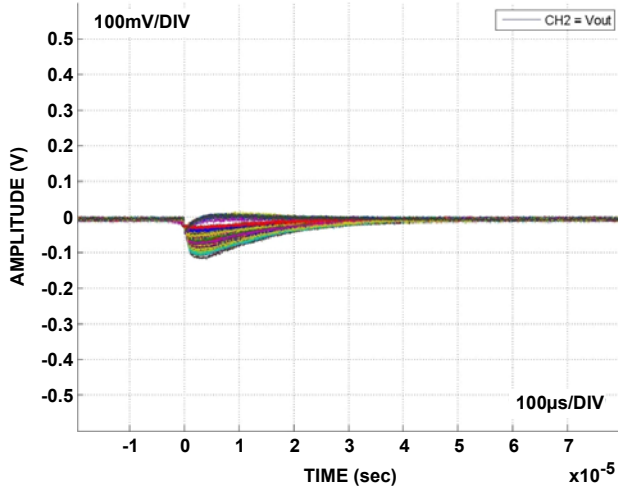

FIGURE 34. COMPOSITE SET PLOT FOR ISL71090SEH75 AT LET 28
 $V_{IN} = 30V, I_{OUT} = 20mA, C_{OUT} = 1\mu F, C_{COMP} = 10nF$

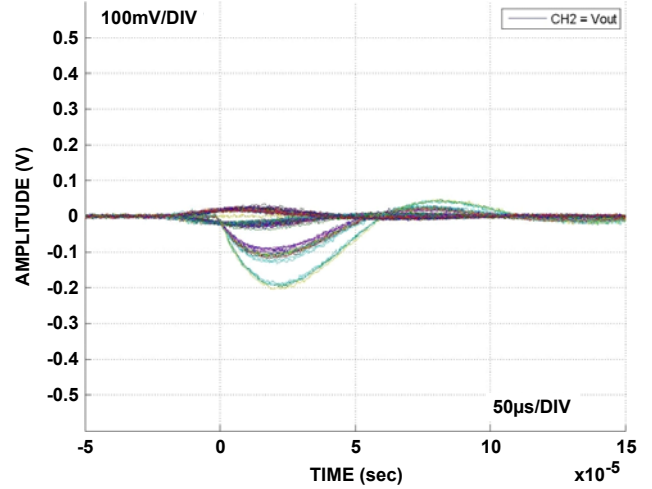

FIGURE 35. COMPOSITE SET PLOT FOR ISL71090SEH75 AT LET 2.7
 $V_{IN} = 30V, I_{OUT} = 20mA, C_{OUT} = 1\mu F, C_{COMP} = 1nF$

Role of C_{OUT} in SET of ISL71090SEHxx

After running the various types with $C_{OUT} = 0.1\mu\text{F}$, it was decided to go back and look at the results with larger C_{OUT} to see if the SET magnitudes reduced. Toward that end, two parts of the ISL71090SEH25 were tested at LET 86 with $C_{OUT} = 1.0\mu\text{F}$ and $10.0\mu\text{F}$. Composite plots of the SET appear in [Figures 36](#) and [37](#).

The reduction of I_{OUT} (20mA to 10mA) and the increase of C_{OUT} ($0.1\mu\text{F}$ to $1\mu\text{F}$) took the negative SET at LET 86 from over 325mV ([Figure 11](#)) down to roughly 108mV, but pushed the recovery time to beyond $50\mu\text{s}$. The 10x increase in capacitance did not realize a 10x reduction in the SET, even with the 2x reduction in I_{OUT} . Only a reduction of SET by about 3x was achieved with both the reduction in I_{OUT} and the increase in C_{OUT} .

A further reduction in SET was sought with a further increase in C_{OUT} to $10\mu\text{F}$. This was accompanied with an increase in the

compensation capacitor from 1nF to 10nF. The resulting composite plot of SET is in [Figures 36](#) and [37](#).

Increasing C_{OUT} to $10\mu\text{F}$ further reduced the negative SET at LET of 86 to about 30mV but also prolonged the recovery time. Clearly the size of C_{OUT} serves to mitigate the SET magnitudes, but not in proportion to capacitance value. The 10x increase from $1\mu\text{F}$ to $10\mu\text{F}$ only reduced the SET by about 3x (for the same I_{OUT}). To be sure, the smallest SET was found to be with the largest C_{OUT} , but the capacitance benefit was about equal to the square root of the capacitance ratio; a 10x reduction in SET was realized in going from $0.1\mu\text{F}$ to $10\mu\text{F}$.

Later tests on the 5.0V and 7.5V versions of the references demonstrated clear SET suppression at lower LET (28, 8.5 and $2.7\text{MeV} \cdot \text{cm}^2/\text{mg}$) with the larger capacitance values. Even in this most favorable of conditions, a very few SET of 20mV were noted for LET of $2.7\text{MeV} \cdot \text{cm}^2/\text{mg}$.

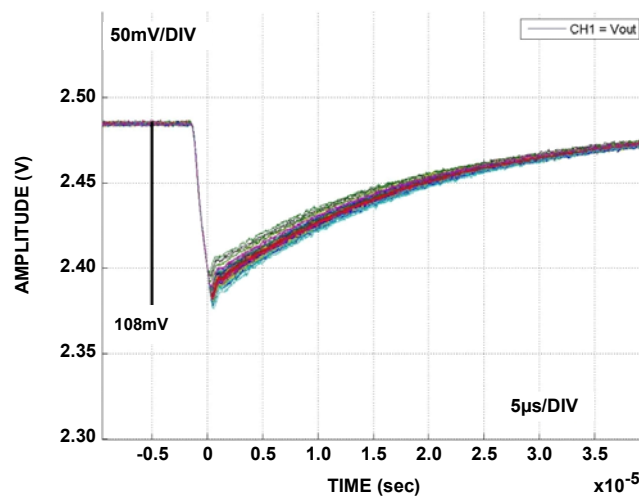

FIGURE 36. COMPOSITE SET PLOT FOR ISL71090SEH25 AT LET 86, $V_{IN} = 4\text{V}$, $I_{OUT} = 10\text{mA}$, $C_{OUT} = 1\mu\text{F}$, $C_{COMP} = 1\text{nF}$

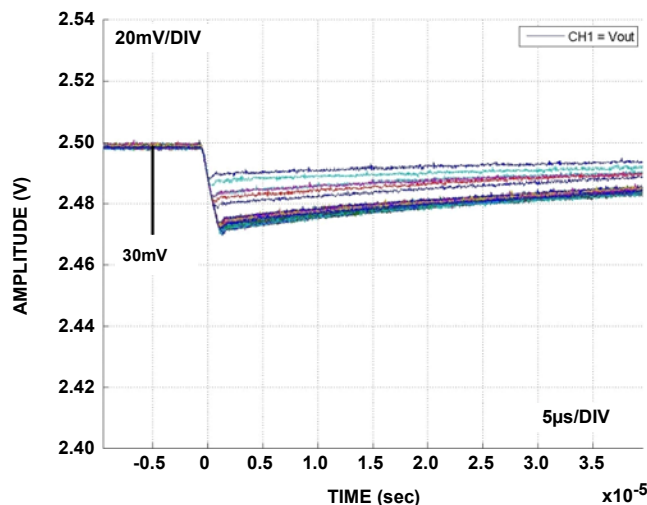

FIGURE 37. COMPOSITE SET PLOT FOR ISL71090SEH25 AT LET 86, $V_{IN} = 4\text{V}$, $I_{OUT} = 20\text{mA}$, $C_{OUT} = 10\mu\text{F}$, $C_{COMP} = 10\text{nF}$

Conclusion

SEE testing of the ISL71090SEH precision reference product family has demonstrated that the devices are not susceptible to single event damage (SEB) at an LET of $86.3\text{MeV} \cdot \text{cm}^2/\text{mg}$ with an input voltage of 37V and a load current of 20mA. This represents conditions that are over 20% above the recommended input voltage of 30V and 100% of the load regulation drive capability of the IC (20mA).

SET testing demonstrated that all transients can be confined to be predominately negative if C_{COMP} is selected to be large (10nF). This was demonstrated in the testing of the 7.5V version with C_{COMP} both 1nF ([Figures 16](#) and [17](#)) and 10nF ([Figures 18](#) and [19](#)). In addition, a larger C_{OUT} (10 μ F) suppresses SET magnitude ([Figures 32](#) and [33](#)). In both cases the extra capacitance limits the SET magnitude, but the SET disturbance duration is stretched out, so capacitor selection represents a compromise between SET magnitude and duration. For maximum SET magnitude suppression the capacitors should be $C_{\text{OUT}} = 10\mu\text{F}$ and $C_{\text{COMP}} = 10\text{nF}$. It should be noted that even at $\text{LET} = 2.7\text{MeV} \cdot \text{cm}^2/\text{mg}$ the 2.5V part showed a nominal cross section of $1.2\text{E-}05\text{ cm}^2$ for SET more than 20mV. At $\text{LET} = 2.7\text{MeV} \cdot \text{cm}^2/\text{mg}$ the 5.0V part showed a nominally larger cross section of $3.2\text{E-}05\text{ cm}^2$ for SET more than 20mV. This is to be expected as the 20mV criteria is a smaller fractional perturbation on the higher nominal output. It should also be noted that SET magnitude scales with the output voltage, so that the 7.5V reference exhibits the largest SET.

Based on this testing, the selection of $C_{\text{OUT}} = 10\mu\text{F}$ and $C_{\text{COMP}} = 10\text{nF}$ seems best from an SET suppression perspective. However, this has bandwidth implications and does not eliminate all SET even at low LET (less than or equal to $2.7\text{MeV} \cdot \text{cm}^2/\text{mg}$). The user is encouraged to carefully consider the selection and implications of the capacitance values.

Notice

1. Descriptions of circuits, software and other related information in this document are provided only to illustrate the operation of semiconductor products and application examples. You are fully responsible for the incorporation or any other use of the circuits, software, and information in the design of your product or system. Renesas Electronics disclaims any and all liability for any losses and damages incurred by you or third parties arising from the use of these circuits, software, or information.
2. Renesas Electronics hereby expressly disclaims any warranties against and liability for infringement or any other claims involving patents, copyrights, or other intellectual property rights of third parties, by or arising from the use of Renesas Electronics products or technical information described in this document, including but not limited to, the product data, drawings, charts, programs, algorithms, and application examples.
3. No license, express, implied or otherwise, is granted hereby under any patents, copyrights or other intellectual property rights of Renesas Electronics or others.
4. You shall not alter, modify, copy, or reverse engineer any Renesas Electronics product, whether in whole or in part. Renesas Electronics disclaims any and all liability for any losses or damages incurred by you or third parties arising from such alteration, modification, copying or reverse engineering.
5. Renesas Electronics products are classified according to the following two quality grades: "Standard" and "High Quality". The intended applications for each Renesas Electronics product depends on the product's quality grade, as indicated below.
"Standard": Computers; office equipment; communications equipment; test and measurement equipment; audio and visual equipment; home electronic appliances; machine tools; personal electronic equipment; industrial robots; etc.
"High Quality": Transportation equipment (automobiles, trains, ships, etc.); traffic control (traffic lights); large-scale communication equipment; key financial terminal systems; safety control equipment; etc.
Unless expressly designated as a high reliability product or a product for harsh environments in a Renesas Electronics data sheet or other Renesas Electronics document, Renesas Electronics products are not intended or authorized for use in products or systems that may pose a direct threat to human life or bodily injury (artificial life support devices or systems; surgical implantations; etc.), or may cause serious property damage (space system; undersea repeaters; nuclear power control systems; aircraft control systems; key plant systems; military equipment; etc.). Renesas Electronics disclaims any and all liability for any damages or losses incurred by you or any third parties arising from the use of any Renesas Electronics product that is inconsistent with any Renesas Electronics data sheet, user's manual or other Renesas Electronics document.
6. When using Renesas Electronics products, refer to the latest product information (data sheets, user's manuals, application notes, "General Notes for Handling and Using Semiconductor Devices" in the reliability handbook, etc.), and ensure that usage conditions are within the ranges specified by Renesas Electronics with respect to maximum ratings, operating power supply voltage range, heat dissipation characteristics, installation, etc. Renesas Electronics disclaims any and all liability for any malfunctions, failure or accident arising out of the use of Renesas Electronics products outside of such specified ranges.
7. Although Renesas Electronics endeavors to improve the quality and reliability of Renesas Electronics products, semiconductor products have specific characteristics, such as the occurrence of failure at a certain rate and malfunctions under certain use conditions. Unless designated as a high reliability product or a product for harsh environments in a Renesas Electronics data sheet or other Renesas Electronics document, Renesas Electronics products are not subject to radiation resistance design. You are responsible for implementing safety measures to guard against the possibility of bodily injury, injury or damage caused by fire, and/or danger to the public in the event of a failure or malfunction of Renesas Electronics products, such as safety design for hardware and software, including but not limited to redundancy, fire control and malfunction prevention, appropriate treatment for aging degradation or any other appropriate measures. Because the evaluation of microcomputer software alone is very difficult and impractical, you are responsible for evaluating the safety of the final products or systems manufactured by you.
8. Please contact a Renesas Electronics sales office for details as to environmental matters such as the environmental compatibility of each Renesas Electronics product. You are responsible for carefully and sufficiently investigating applicable laws and regulations that regulate the inclusion or use of controlled substances, including without limitation, the EU RoHS Directive, and using Renesas Electronics products in compliance with all these applicable laws and regulations. Renesas Electronics disclaims any and all liability for damages or losses occurring as a result of your noncompliance with applicable laws and regulations.
9. Renesas Electronics products and technologies shall not be used for or incorporated into any products or systems whose manufacture, use, or sale is prohibited under any applicable domestic or foreign laws or regulations. You shall comply with any applicable export control laws and regulations promulgated and administered by the governments of any countries asserting jurisdiction over the parties or transactions.
10. It is the responsibility of the buyer or distributor of Renesas Electronics products, or any other party who distributes, disposes of, or otherwise sells or transfers the product to a third party, to notify such third party in advance of the contents and conditions set forth in this document.
11. This document shall not be reprinted, reproduced or duplicated in any form, in whole or in part, without prior written consent of Renesas Electronics.
12. Please contact a Renesas Electronics sales office if you have any questions regarding the information contained in this document or Renesas Electronics products.
(Note 1) "Renesas Electronics" as used in this document means Renesas Electronics Corporation and also includes its directly or indirectly controlled subsidiaries.
(Note 2) "Renesas Electronics product(s)" means any product developed or manufactured by or for Renesas Electronics.

(Rev.4.0-1 November 2017)



SALES OFFICES

Renesas Electronics Corporation

<http://www.renesas.com>

Refer to "<http://www.renesas.com/>" for the latest and detailed information.

Renesas Electronics America Inc.
1001 Murphy Ranch Road, Milpitas, CA 95035, U.S.A.
Tel: +1-408-432-8888, Fax: +1-408-434-5351

Renesas Electronics Canada Limited
9251 Yonge Street, Suite 8309 Richmond Hill, Ontario Canada L4C 9T3
Tel: +1-905-237-2004

Renesas Electronics Europe Limited
Dukes Meadow, Millboard Road, Bourne End, Buckinghamshire, SL8 5FH, U.K
Tel: +44-1628-651-700, Fax: +44-1628-651-804

Renesas Electronics Europe GmbH
Arcadiastrasse 10, 40472 Düsseldorf, Germany
Tel: +49-211-6503-0, Fax: +49-211-6503-1327

Renesas Electronics (China) Co., Ltd.
Room 1709 Quantum Plaza, No.27 ZhichunLu, Haidian District, Beijing, 100191 P. R. China
Tel: +86-10-8235-1155, Fax: +86-10-8235-7679

Renesas Electronics (Shanghai) Co., Ltd.
Unit 301, Tower A, Central Towers, 555 Langao Road, Putuo District, Shanghai, 200333 P. R. China
Tel: +86-21-2226-0888, Fax: +86-21-2226-0999

Renesas Electronics Hong Kong Limited
Unit 1601-1611, 16/F., Tower 2, Grand Century Place, 193 Prince Edward Road West, Mongkok, Kowloon, Hong Kong
Tel: +852-2265-6688, Fax: +852-2886-9022

Renesas Electronics Taiwan Co., Ltd.
13F, No. 363, Fu Shing North Road, Taipei 10543, Taiwan
Tel: +886-2-8175-9600, Fax: +886-2-8175-9670

Renesas Electronics Singapore Pte. Ltd.
80 Bendemeer Road, Unit #06-02 Hyflux Innovation Centre, Singapore 339949
Tel: +65-6213-0200, Fax: +65-6213-0300

Renesas Electronics Malaysia Sdn.Bhd.
Unit 1207, Block B, Menara Amcorp, Amcorp Trade Centre, No. 18, Jln Persiaran Barat, 46050 Petaling Jaya, Selangor Darul Ehsan, Malaysia
Tel: +60-3-7955-9390, Fax: +60-3-7955-9510

Renesas Electronics India Pvt. Ltd.
No.777C, 100 Feet Road, HAL 2nd Stage, Indiranagar, Bangalore 560 038, India
Tel: +91-80-67208700, Fax: +91-80-67208777

Renesas Electronics Korea Co., Ltd.
17F, KAMCO Yangjae Tower, 262, Gangnam-daero, Gangnam-gu, Seoul, 06265 Korea
Tel: +82-2-558-3737, Fax: +82-2-558-5338