

Introduction

The intense, heavy ion environment encountered in space applications can cause a variety of effects in electronic circuitry, including single event transient (SET), single event latchup (SEL) and single event burnout (SEB). These single event effects (SEE) can lead to system-level performance issues including degradation, disruption and destruction. For predictable and reliable space system operation, individual electronic components should be characterized to determine their SEE response. This report discusses the results of SEE testing performed on the HS-117RH Adjustable Voltage Regulator.

Product Description

The HS-117RH is a monolithic, linear voltage regulator fabricated using the Intersil Corporation dielectrically isolated (DI), radiation-hardened silicon gate (RSG) process. This process is optimized for power management functions and features complementary high-voltage MOS and bipolar devices as well as various passive components. The HS-117RH is hardened to a total ionizing dose of 300krads(Si).

Functionally, the HS-117RH is an adjustable, series-pass, positive voltage regulator that is equivalent to commercial 117 types. It is designed to provide a regulated output voltage from 1.25V to 37V at an output current ranging from 5mA to 1.25A.

SEE Test Objectives

The HS-117RH was tested for SEE to verify its immunity to SEL/SEB and to characterize its SET performance under various bias and load conditions.

SEE Test Procedure

Testing was conducted at the Texas A&M University Cyclotron Institute heavy ion facility. This facility is coupled to a K500 super-conducting cyclotron and is capable of generating a wide range of test particles with the various energy, fluence and flux levels needed for advanced radiation testing.

Diagram 1 shows the HS-117RH SEE test fixture schematic. The fixture enables adjustment of input voltage, output voltage, output load and output capacitance. R2 was adjusted to set the output voltage at precisely 5V for all tests. Closing SW1 parallels a 22uF capacitor with the fixed 22uF output capacitor. Closing SW2 increases the output load from 6.25mA to approximately 500mA. An oscilloscope was connected to VIN/VOUT in order to record the input/output waveforms, and a counter was connected to VOUT to record the number of transients. All input/output capacitors were wet tantalum (CLR) types.

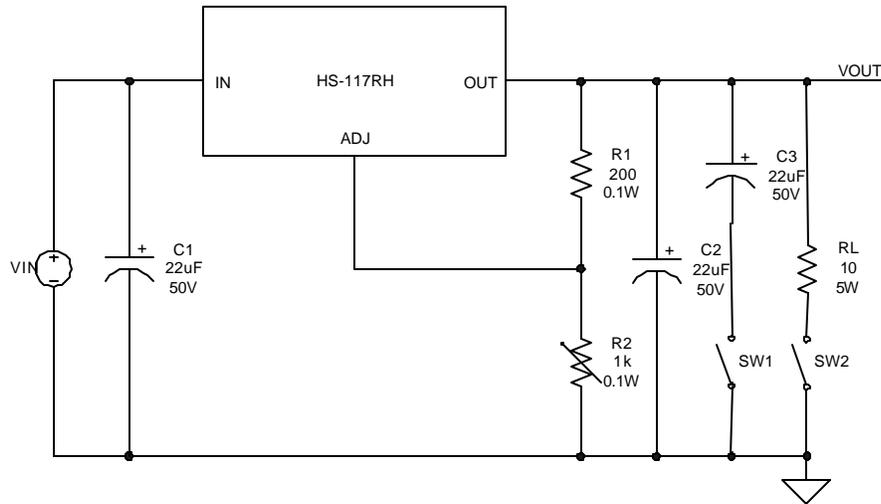

Diagram 1: HS-117RH SEE Test Fixture Schematic

Table 1 shows the characteristics of the various beams used for SEE testing.

Beam Type	Incident Angle (°)	LET (MeV/mg/cm ²)	Fluence (p/cm ²)	Flux (p/cm ² /s)
Gold	0	87.4	1x10 ⁷	Various
Krypton	0	36	1x10 ⁷	Various
Argon	0	15	1x10 ⁷	Various

Table 1: Beam Type and Characteristics

Table 2 shows the test number, the beam type, the test conditions and the transient count recorded for each of the SEE tests. A transient was defined to be a change in output voltage that exceeded 2% of the nominal output voltage. With the output set to 5V, a transient corresponded to a 100mV increase in the output voltage.

Test Number	Beam Type	Test Conditions	Transient Count
1	Gold	Vin=40V; Vout=5V; Iout=6.25mA; Cout=22uF	31271
2	Gold	Vin=40V; Vout=5V; Iout=6.25mA; Cout=44uF	25971
3	Gold	Vin=10V; Vout=5V; Iout=6.25mA; Cout=22uF	13559
4	Gold	Vin=10V; Vout=5V; Iout=6.25mA; Cout=44uF	10804
5	Gold	Vin=10V; Vout=5V; Iout=500mA; Cout=22uF	10367
6	Gold	Vin=10V; Vout=5V; Iout=500mA; Cout=44uF	9709
7	Gold	Vin=9V; Vout=5V; Iout=6.25mA; Cout=22uF	10494
8	Gold	Vin=9V; Vout=5V; Iout=6.25mA; Cout=44uF	8483
9	Gold	Vin=9V; Vout=5V; Iout=500mA; Cout=22uF	8380
10	Gold	Vin=9V; Vout=5V; Iout=500mA; Cout=44uF	6471
11	Gold	Vin=8V; Vout=5V; Iout=6.25mA; Cout=22uF	2031

12	Gold	Vin=8V; Vout=5V; Iout=6.25mA; Cout=44uF	1844
13	Gold	Vin=8V; Vout=5V; Iout=500mA; Cout=22uF	5489
14	Gold	Vin=8V; Vout=5V; Iout=500mA; Cout=44uF	3987
15	Krypton	Vin=10V; Vout=5V; Iout=6.25mA; Cout=22uF	2414
16	Krypton	Vin=10V; Vout=5V; Iout=6.25mA; Cout=44uF	1482
17	Krypton	Vin=10V; Vout=5V; Iout=500mA; Cout=22uF	5123
18	Krypton	Vin=10V; Vout=5V; Iout=500mA; Cout=44uF	2464
19	Krypton	Vin=9V; Vout=5V; Iout=6.25mA; Cout=22uF	1089
20	Krypton	Vin=9V; Vout=5V; Iout=6.25mA; Cout=44uF	384
21	Krypton	Vin=9V; Vout=5V; Iout=500mA; Cout=22uF	3799
22	Krypton	Vin=9V; Vout=5V; Iout=500mA; Cout=44uF	1179
23	Krypton	Vin=8V; Vout=5V; Iout=6.25mA; Cout=22uF	233
24	Krypton	Vin=8V; Vout=5V; Iout=6.25mA; Cout=44uF	211
25	Krypton	Vin=8V; Vout=5V; Iout=500mA; Cout=22uF	2715
26	Krypton	Vin=8V; Vout=5V; Iout=500mA; Cout=44uF	269
27	Argon	Vin=10V; Vout=5V; Iout=6.25mA; Cout=22uF	1
28	Argon	Vin=10V; Vout=5V; Iout=6.25mA; Cout=44uF	0
29	Argon	Vin=10V; Vout=5V; Iout=500mA; Cout=22uF	510
30	Argon	Vin=10V; Vout=5V; Iout=500mA; Cout=44uF	89
31	Argon	Vin=9V; Vout=5V; Iout=6.25mA; Cout=22uF	0
32	Argon	Vin=9V; Vout=5V; Iout=6.25mA; Cout=44uF	0
33	Argon	Vin=9V; Vout=5V; Iout=500mA; Cout=22uF	225
34	Argon	Vin=9V; Vout=5V; Iout=500mA; Cout=44uF	0
35	Argon	Vin=8V; Vout=5V; Iout=6.25mA; Cout=22uF	0
36	Argon	Vin=8V; Vout=5V; Iout=6.25mA; Cout=44uF	0
37	Argon	Vin=8V; Vout=5V; Iout=500mA; Cout=22uF	174
38	Argon	Vin=8V; Vout=5V; Iout=500mA; Cout=44uF	0

Table 2: SEE Tests

SEL/SEB Testing

The goal of SEL/SEB testing was to apply the highest energy particles to the regulator under worst-case bias conditions to maximize the chance of latchup or burnout. Consequently, gold ions with a Linear Energy Transfer (LET) of 87.4MeV/mg/cm² and a fluence of 1x10⁷ p/cm² were used. Test #1 (Vin=40V; Vout=5V; Iout=6.25mA; Cout=22uF) provided the most transients (31,271) for a cross section of 3.1x10⁻³cm². Worst-case positive output excursions were observed to exceed 7V and worst-case negative output excursions dropped the output to 4.3V. Duration of all transients was less than 1us. Test #2 (Vin=40V; Vout=5V; Iout=6.25mA; Cout=44uF) added an additional 22uF output capacitor, which reduced the transient count to 25,971 and the cross section to 2.6x10⁻³cm². This was expected since additional capacitance lowers the output impedance and requires more energy to generate output transients. But it was interesting to note that while output capacitance was doubled, the number of upsets fell by only 17%. Worst-case positive

output excursions still exceeded 7V and worst-case negative output excursions dropped the output to 4.35V. Duration of all transients was also less than 1 μ s. Figures 1-2, corresponding to tests #1-2, show the input/output waveforms of the regulator during SEL/SEB testing. No evidence of latchup or burnout was observed. The upper trace is output voltage (channel 3) and the lower trace is input voltage (channel 1).

SET Testing

The goal of SET testing was to characterize the performance of the regulator under real-world bias and load conditions when subjected to the beams shown in Table 1. In particular, the effect of input voltage, output capacitance and output load on the number and magnitude of transients was desired.

A total of 12 tests were conducted using each of the ion species. Input voltage was varied from 10V to 8V in 1V increments, output load was varied from 6.25mA to 500mA and output capacitance was varied from 22 μ F to 44 μ F.

Gold Ion SET Testing

Transient counts ranged from 13559 for test #3 ($V_{in}=10V$; $V_{out}=5V$; $I_{out}=6.25mA$; $C_{out}=22\mu F$) to 1844 for test #12 ($V_{in}=8V$; $V_{out}=5V$; $I_{out}=6.25mA$; $C_{out}=44\mu F$). Positive excursions of the output voltage ranged from about 800mV for test #3 ($V_{in}=10V$; $V_{out}=5V$; $I_{out}=6.25mA$; $C_{out}=22\mu F$) to about 200mV for test #14 ($V_{in}=8V$; $V_{out}=5V$; $I_{out}=500mA$; $C_{out}=44\mu F$). Negative excursions of the output voltage ranged from about 350mV for test #3 ($V_{in}=10V$; $V_{out}=5V$; $I_{out}=6.25mA$; $C_{out}=22\mu F$) to about 100mV for test #14 ($V_{in}=8V$; $V_{out}=5V$; $I_{out}=500mA$; $C_{out}=44\mu F$).

Certain trends were noted as input voltage, output capacitance and output load were varied. First, with output capacitance and output load fixed, reducing the input voltage from 10V to 8V dramatically lowered the total transient count in all test cases. This was expected since the highly energetic particles induce charge in the DI island containing the series-pass transistor, tending to turn it on. Since the series-pass transistor connects input to output, if the input voltage is smaller in magnitude, less is available to be conducted to the output. Second, with input voltage and output load fixed, doubling the output capacitance from 22 μ F to 44 μ F reduced the total transient count in all test cases, but the reduction was considerably smaller than that observed for lowering the input voltage. This also was expected since doubling the output capacitance lowers the output impedance and thus requires more energy to produce an output transient. Finally, with input voltage and output capacitance fixed, increasing the load from 6.25mA to 500mA reduced the total transient count in all but two of the test cases. The reduction in transient count on a percentage basis was between that observed with lowering the input voltage and doubling the output capacitance. Again, this was the expected effect since increasing the load, like doubling the output capacitance, lowers the output impedance. Consequently, more energy is required to perturb the output. The instances where increasing the load resulted in increased transient counts occurred from test #11 ($V_{in}=8V$; $V_{out}=5V$; $I_{out}=6.25mA$; $C_{out}=22\mu F$) to test #13 ($V_{in}=8V$; $V_{out}=5V$; $I_{out}=500mA$; $C_{out}=22\mu F$) and from test #12 ($V_{in}=8V$; $V_{out}=5V$;

$I_{out}=6.25\text{mA}$; $C_{out}=44\mu\text{F}$) to test #14 ($V_{in}=8\text{V}$; $V_{out}=5\text{V}$; $I_{out}=500\text{mA}$; $C_{out}=44\mu\text{F}$). One possible explanation is that the regulator is less stable under these conditions, which causes the output to ring and generate a higher transient count.

Decreasing the input voltage and doubling the output capacitance both reduced the magnitude of the output transients, but the changes on a percentage basis were considerably less than that observed with the transient count. Except for tests with $V_{in}=10\text{V}$, maximum output excursions looked quite similar and ranged between 4.8V and 5.4V.

Figures 3-14 correspond to tests #3-14 and show the input/output waveforms of the regulator during gold ion SET testing. The upper trace is output voltage (channel 3) and the lower trace is input voltage (channel 1) for all figures. Since transients in excess of the 100mV threshold were recorded for all tests using gold ions, testing was continued using lower energy krypton ions with an LET of 36MeV/mg/cm^2 .

Krypton Ion SET Testing

Transient counts ranged from 5123 for test #17 ($V_{in}=10\text{V}$; $V_{out}=5\text{V}$; $I_{out}=500\text{mA}$; $C_{out}=22\mu\text{F}$) to 211 for test #24 ($V_{in}=8\text{V}$; $V_{out}=5\text{V}$; $I_{out}=6.25\text{mA}$; $C_{out}=44\mu\text{F}$). Excursions of the output voltage looked quite similar for many of the tests. Positive excursions were no more than about 300mV and negative excursions were within approximately 100mV.

Similar trends were noted regarding the effects of input voltage and output capacitance on the transient count. In all cases, lowering the input voltage substantially reduced the transient count for a given output capacitance and output load. Similarly, doubling the output capacitance reduced the transient count for a given input voltage and output load. However, unlike gold ion testing where increasing the load for a fixed input voltage and output capacitance reduced the transient count in most cases, the transient count increased in every case during krypton ion testing. This was not expected, since increasing the output capacitance lowers the output impedance, which should make it more difficult to produce transients.

Figures 15-26 correspond to tests #15-26 and show the input/output waveforms of the regulator during krypton ion SET testing. The upper trace is output voltage (channel 3) and the lower trace is input voltage (channel 1) for all figures. Since transients in excess of the 100mV threshold were recorded for all tests using krypton ions, testing was continued using lower energy argon ions with an LET of 15MeV/mg/cm^2 .

Argon Ion SET Testing

Transient counts ranged from 510 for test #29 ($V_{in}=10\text{V}$; $V_{out}=5\text{V}$; $I_{out}=500\text{mA}$; $C_{out}=22\mu\text{F}$) to 0 for tests #28 ($V_{in}=10\text{V}$; $V_{out}=5\text{V}$; $I_{out}=6.25\text{mA}$; $C_{out}=44\mu\text{F}$), #31 ($V_{in}=9\text{V}$; $V_{out}=5\text{V}$; $I_{out}=6.25\text{mA}$; $C_{out}=22\mu\text{F}$), #32 ($V_{in}=9\text{V}$; $V_{out}=5\text{V}$; $I_{out}=6.25\text{mA}$; $C_{out}=44\mu\text{F}$), #34 ($V_{in}=9\text{V}$; $V_{out}=5\text{V}$; $I_{out}=500\text{mA}$; $C_{out}=44\mu\text{F}$), #35 ($V_{in}=8\text{V}$; $V_{out}=5\text{V}$; $I_{out}=6.25\text{mA}$; $C_{out}=22\mu\text{F}$), #36 ($V_{in}=8\text{V}$; $V_{out}=5\text{V}$; $I_{out}=6.25\text{mA}$; $C_{out}=44\mu\text{F}$) and #38 ($V_{in}=8\text{V}$; $V_{out}=5\text{V}$;

$I_{out}=500\text{mA}$; $C_{out}=44\mu\text{F}$). Excursions of the output voltage looked quite similar for many of the tests. Positive excursions were no more than about 300mV and negative excursions were within approximately 100mV.

Common trends were noted regarding the effects of input voltage and output capacitance on the transient count. In all cases, lowering the input voltage substantially reduced the transient count or kept it constant at 0, independent of output capacitance and output load. Similarly, doubling the output capacitance reduced the transient count or kept it constant at 0, independent of input voltage and output load. However, unlike gold ion testing where increasing the load for a given input voltage and output capacitance reduced the transient count in most cases, the transient count increased in every case during argon ion testing. This was not expected, since increasing the output capacitance lowers the output impedance, which should make it more difficult to produce transients.

Figures 27-38 correspond to tests #27-38 and show the input/output waveforms of the regulator during argon ion SET testing. The upper trace is output voltage (channel 3) and the lower trace is input voltage (channel 1) for all figures. Since several test cases were found where transients did not exceed the 100mV threshold, SET testing was concluded.

Conclusions

The Intersil HS-117RH adjustable voltage regulator was tested for SEE under various bias and load conditions using a variety of heavy ions. As expected, the regulator was shown to be SEL/SEB immune when exposed to gold ions at an LET of $87.4\text{MeV}/\text{mg}/\text{cm}^2$ under worst-case bias conditions. Transients in excess of 100mV were observed during all tests using gold ions at an LET of $87.4\text{MeV}/\text{mg}/\text{cm}^2$ and krypton ions at an LET of $36\text{MeV}/\text{mg}/\text{cm}^2$. With argon ions at an LET of $15\text{MeV}/\text{mg}/\text{cm}^2$, no transients greater than 100mV were observed as long as input voltage was maintained at 9V or less and output capacitance was at least 44uF. Regardless of the ion type used, transient count was shown to either drop or remain constant at 0 as input voltage decreased or output capacitance increased. The relationship of output load to transient count was mixed, generally decreasing during gold ion testing and increasing during krypton and argon ion testing.

If larger output transients can be tolerated, the HS-117RH can be used in the presence of higher energy krypton ($\text{LET}=36\text{MeV}/\text{mg}/\text{cm}^2$) and gold ($\text{LET}=87.4\text{MeV}/\text{mg}/\text{cm}^2$) ions. Based on the figures, no transients in excess of 300mV were observed during krypton ion testing. No transients in excess of 400mV were observed during gold ion testing as long as input voltage was 9V or less.

Appendix

Figures 1-38 that follow correspond to tests #1-38 and show the input/output waveforms of the regulator during SEE testing. The upper trace is output voltage (channel 3) and the lower trace is input voltage (channel 1) for all figures. Ground for both waveforms is indicated by the arrow on the left-hand side of each figure.

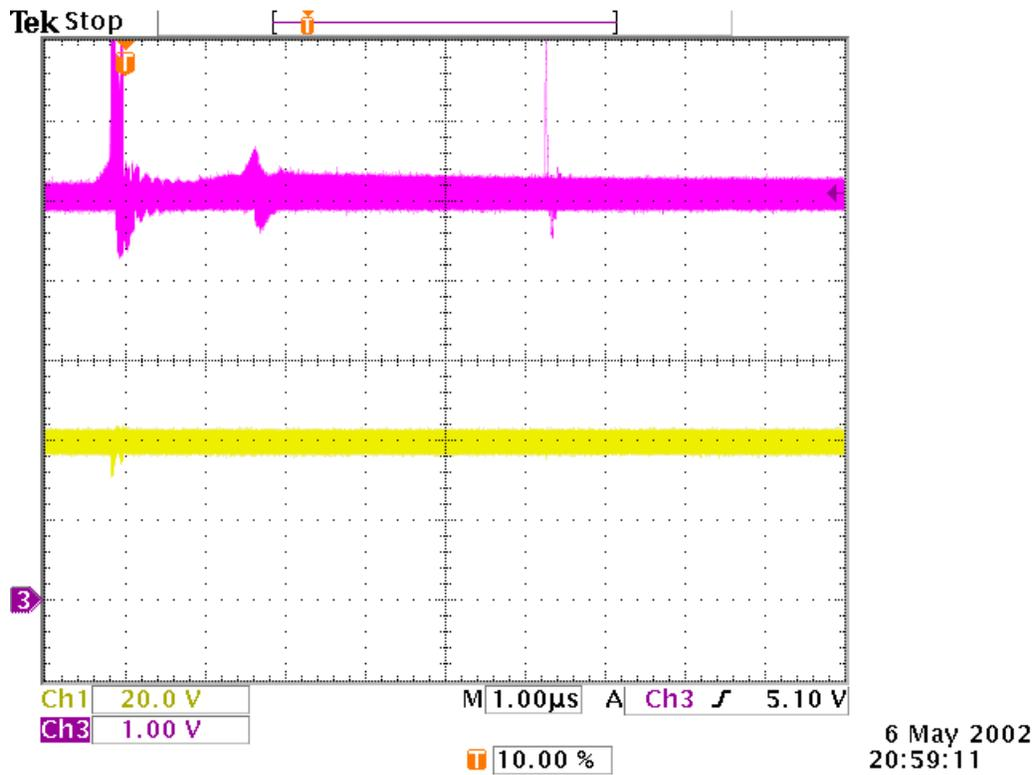

Figure 1: Test #1 Results ($V_{in}=40V$; $V_{out}=5V$; $I_{out}=6.25mA$; $C_{out}=22\mu F$)

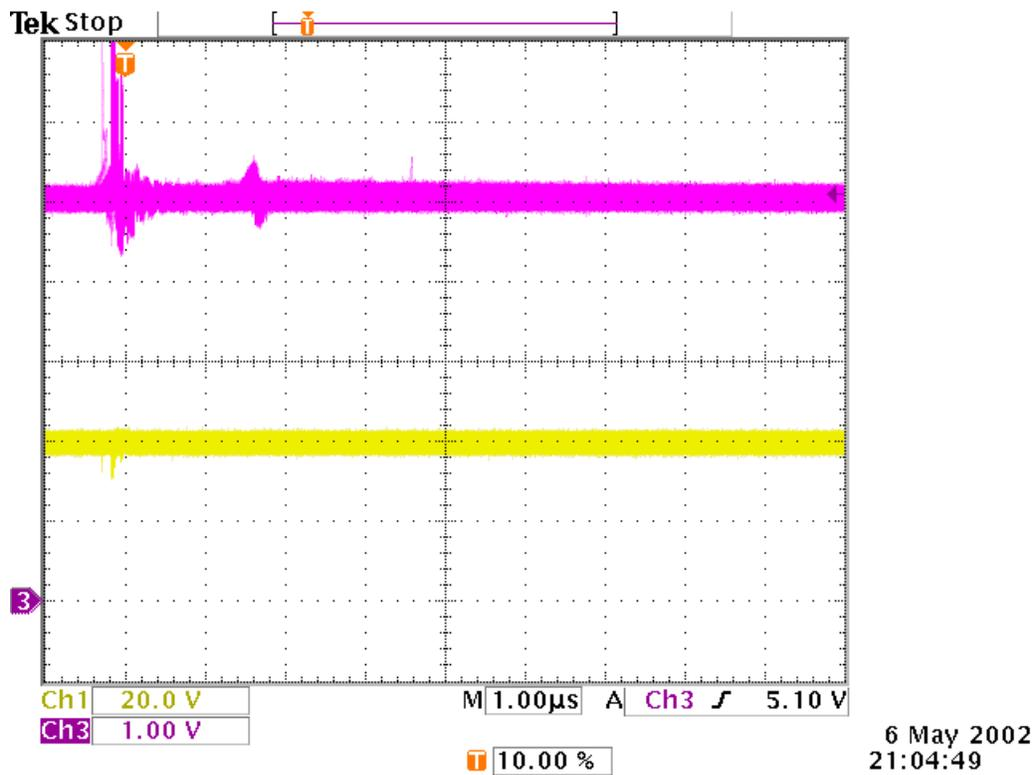

Figure 2: Test #2 Results ($V_{in}=40V$; $V_{out}=5V$; $I_{out}=6.25mA$; $C_{out}=44\mu F$)

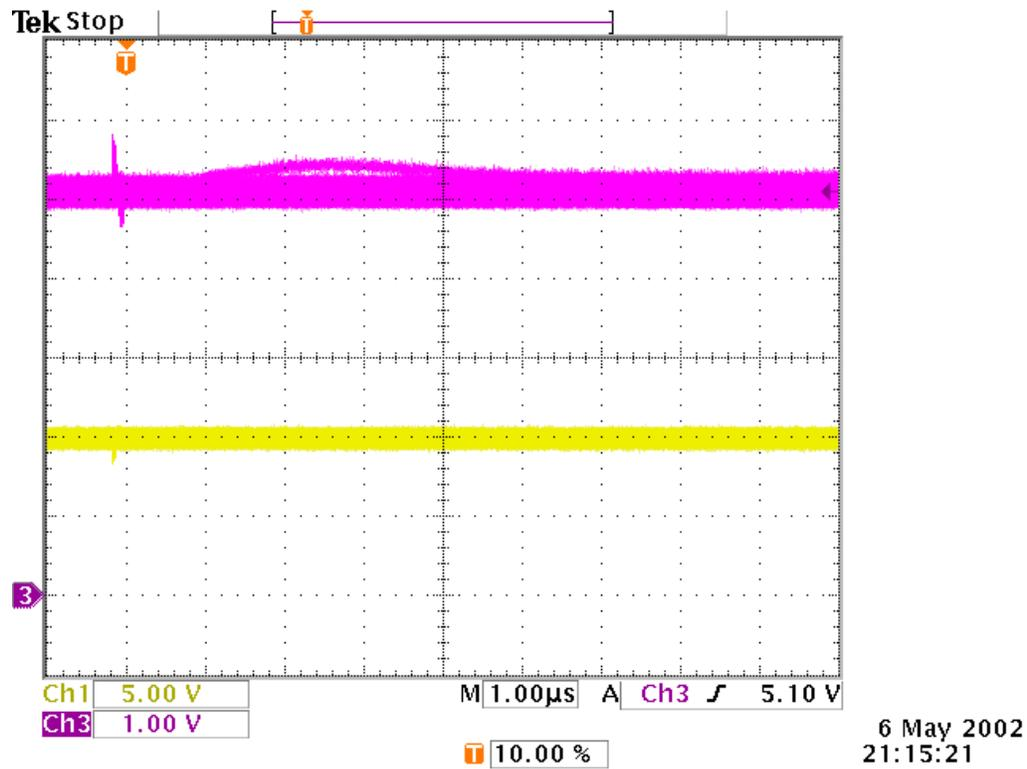

Figure 3: Test #3 Results ($V_{in}=10V$; $V_{out}=5V$; $I_{out}=6.25mA$; $C_{out}=22\mu F$)

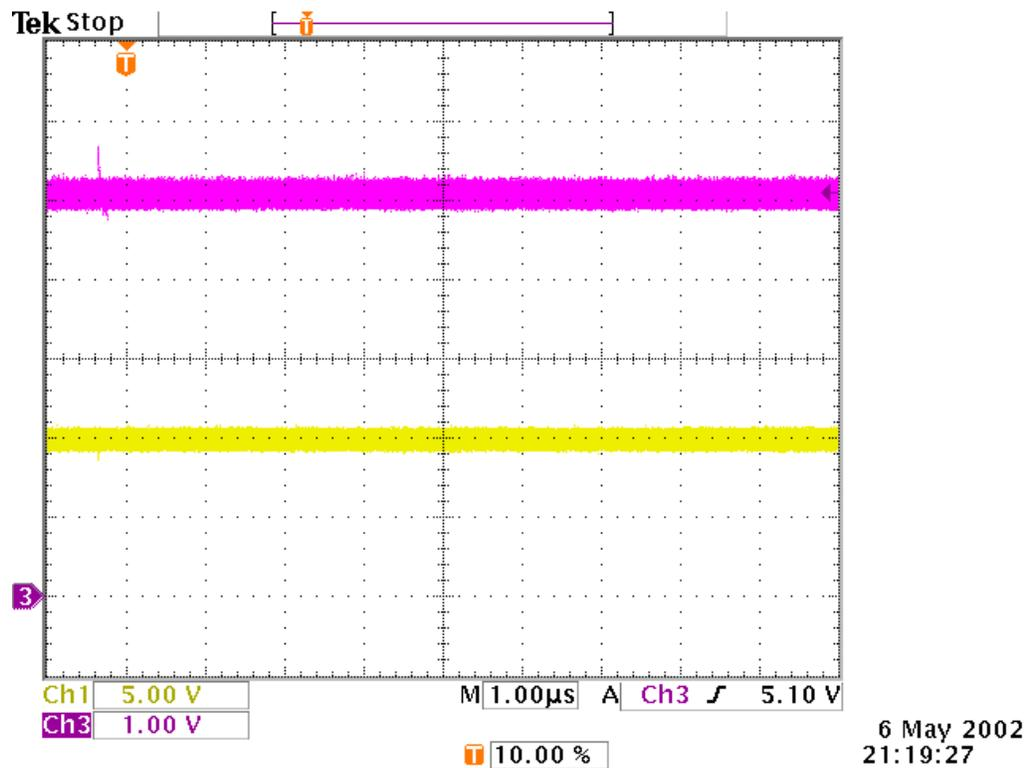

Figure 4: Test #4 Results ($V_{in}=10V$; $V_{out}=5V$; $I_{out}=6.25mA$; $C_{out}=44\mu F$)

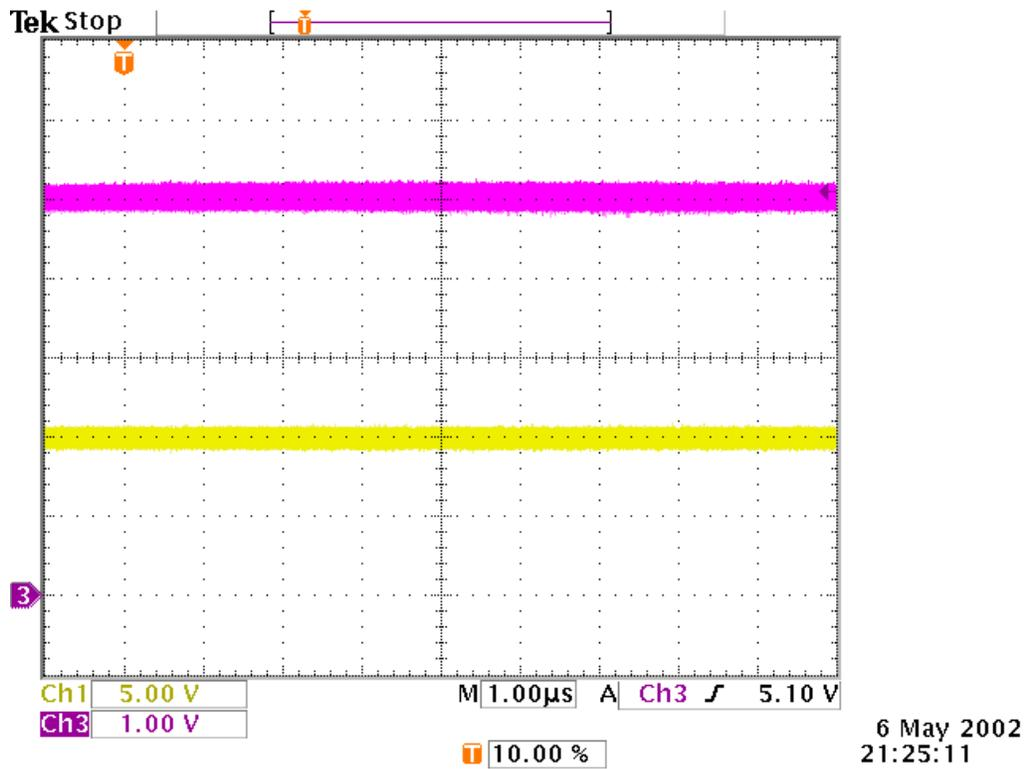

Figure 5: Test #5 Results ($V_{in}=10V$; $V_{out}=5V$; $I_{out}=500mA$; $C_{out}=22\mu F$)

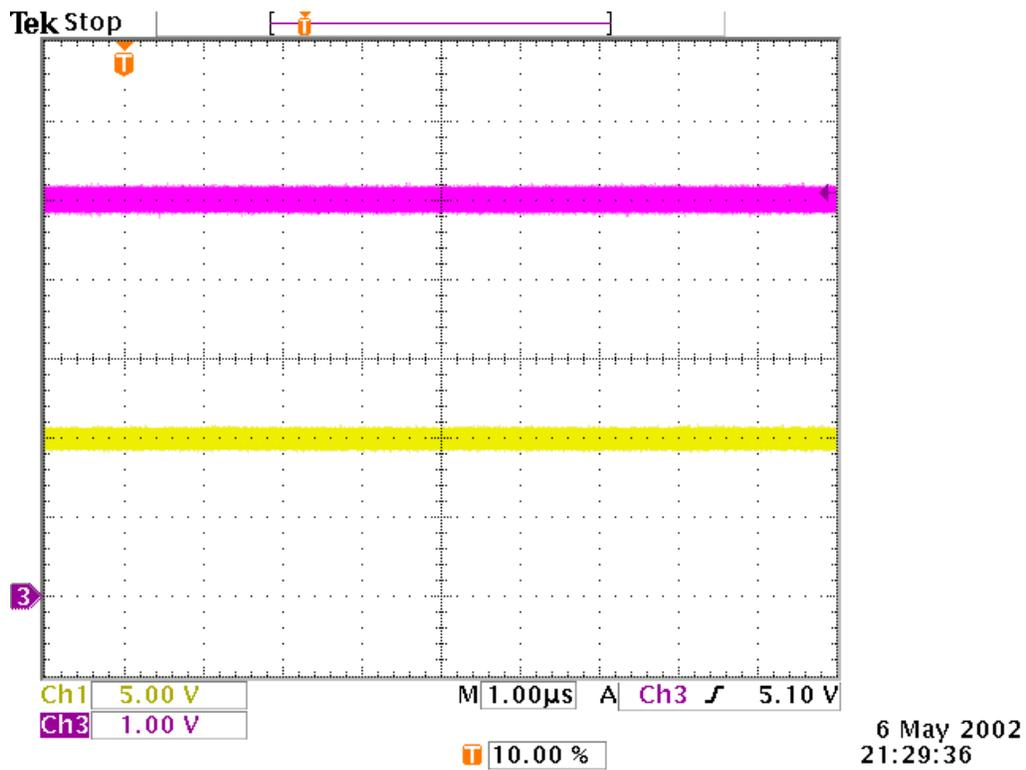

Figure 6: Test #6 Results ($V_{in}=10V$; $V_{out}=5V$; $I_{out}=500mA$; $C_{out}=44\mu F$)

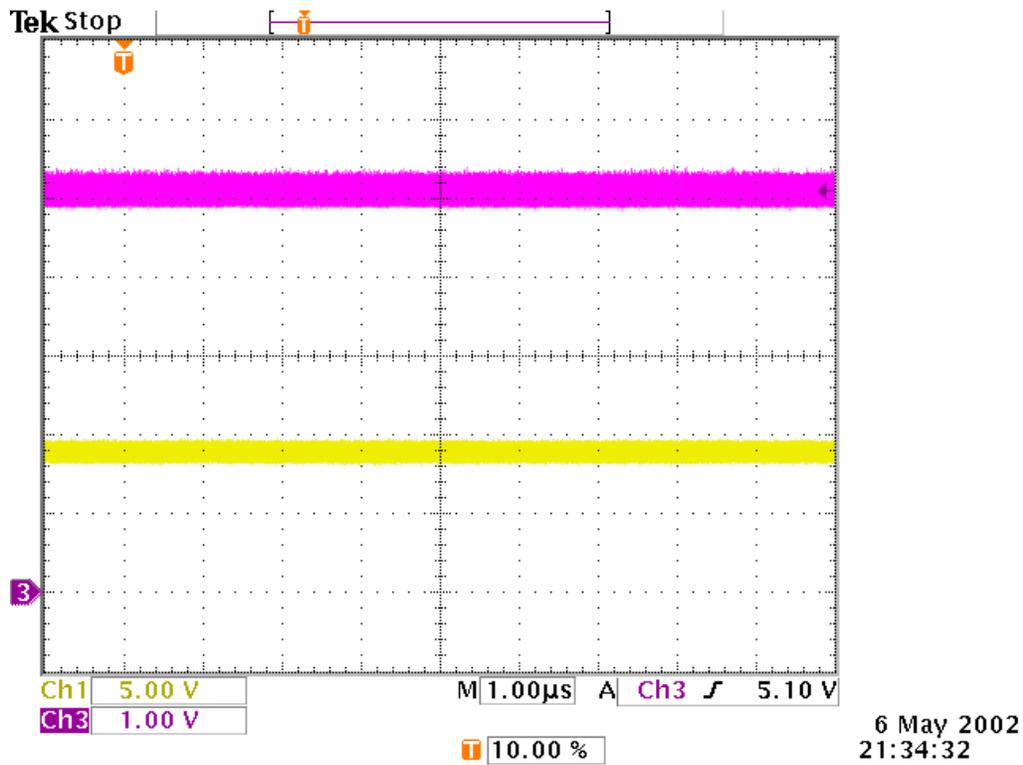

Figure 7: Test #7 Results ($V_{in}=9V$; $V_{out}=5V$; $I_{out}=6.25mA$; $C_{out}=22\mu F$)

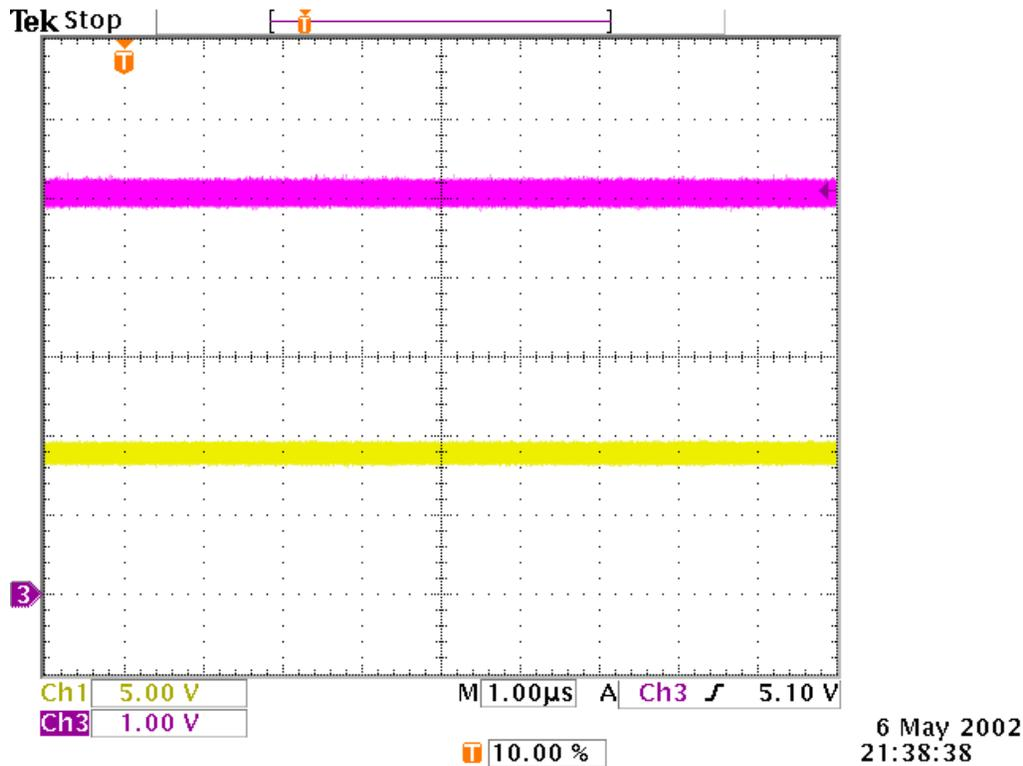

Figure 8: Test #8 Results ($V_{in}=9V$; $V_{out}=5V$; $I_{out}=6.25mA$; $C_{out}=44\mu F$)

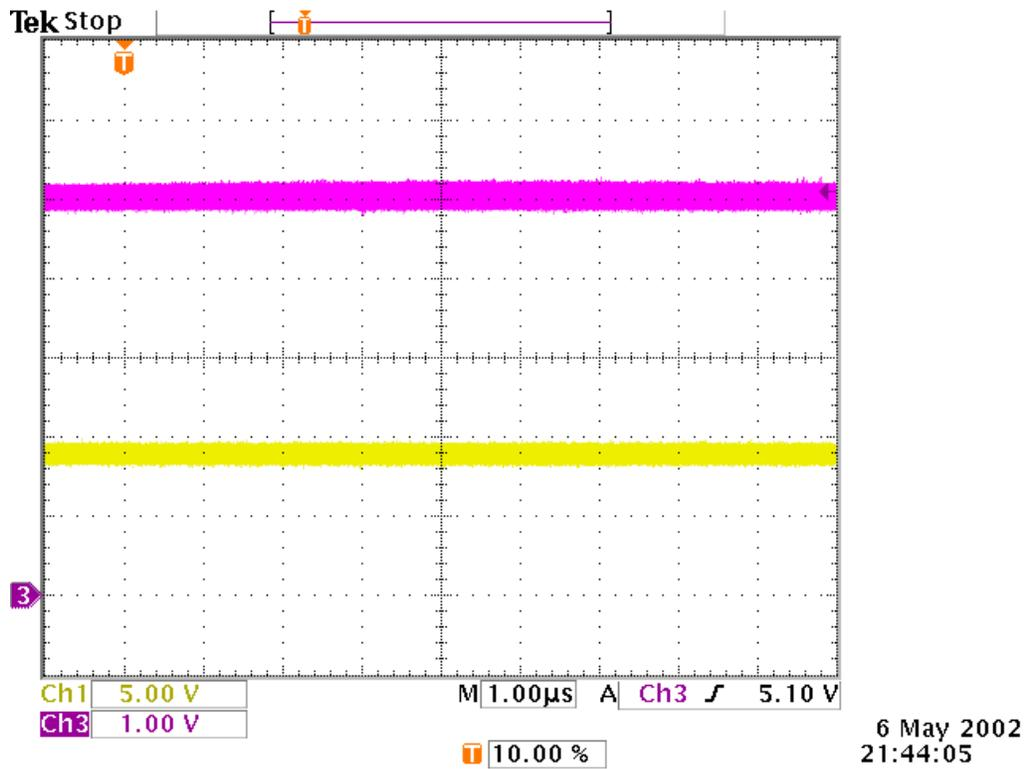

Figure 9: Test #9 Results ($V_{in}=9V$; $V_{out}=5V$; $I_{out}=500mA$; $C_{out}=22\mu F$)

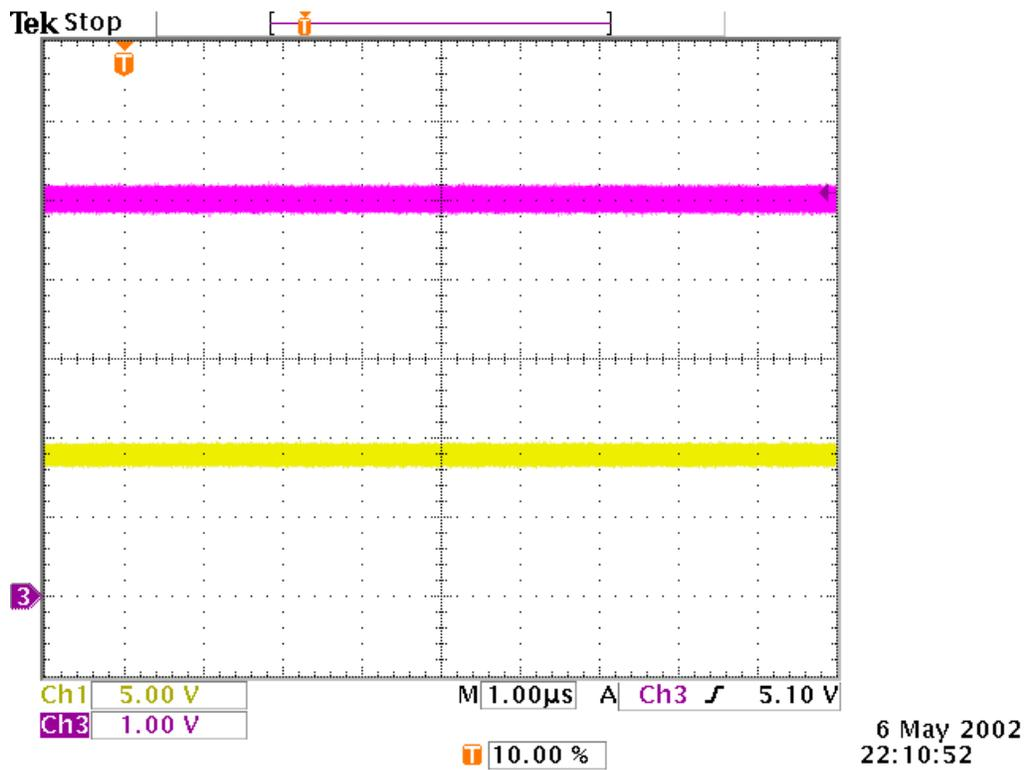

Figure 10: Test #10 Results ($V_{in}=9V$; $V_{out}=5V$; $I_{out}=500mA$; $C_{out}=44\mu F$)

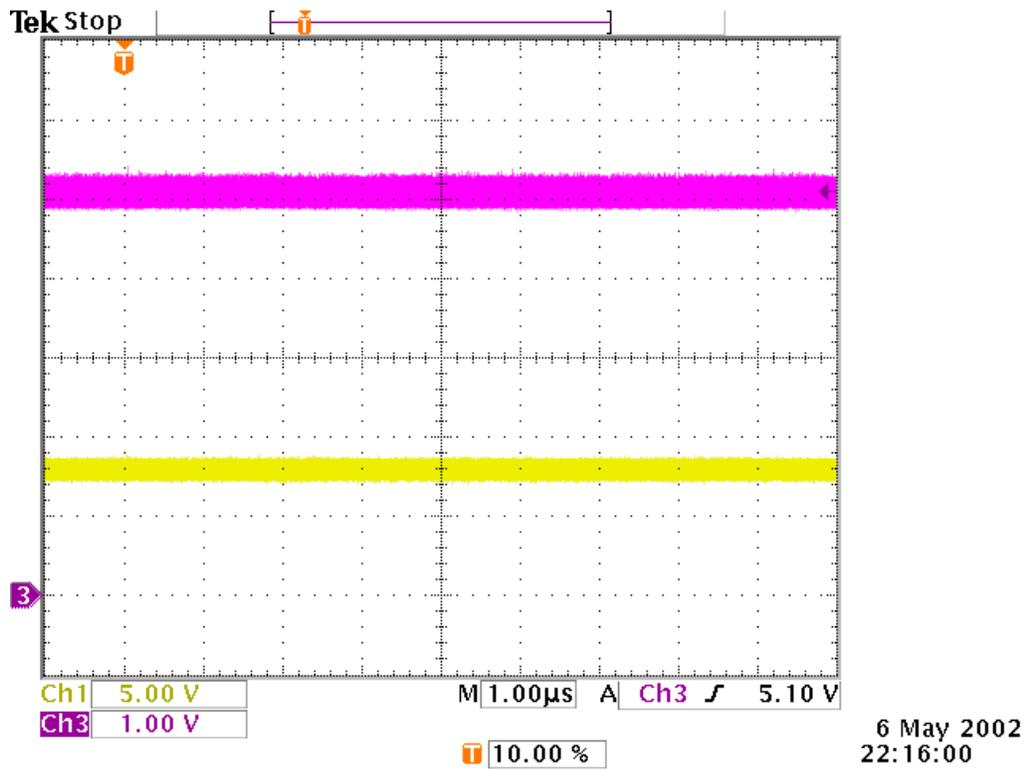

Figure 11: Test #11 Results ($V_{in}=8V$; $V_{out}=5V$; $I_{out}=6.25mA$; $C_{out}=22\mu F$)

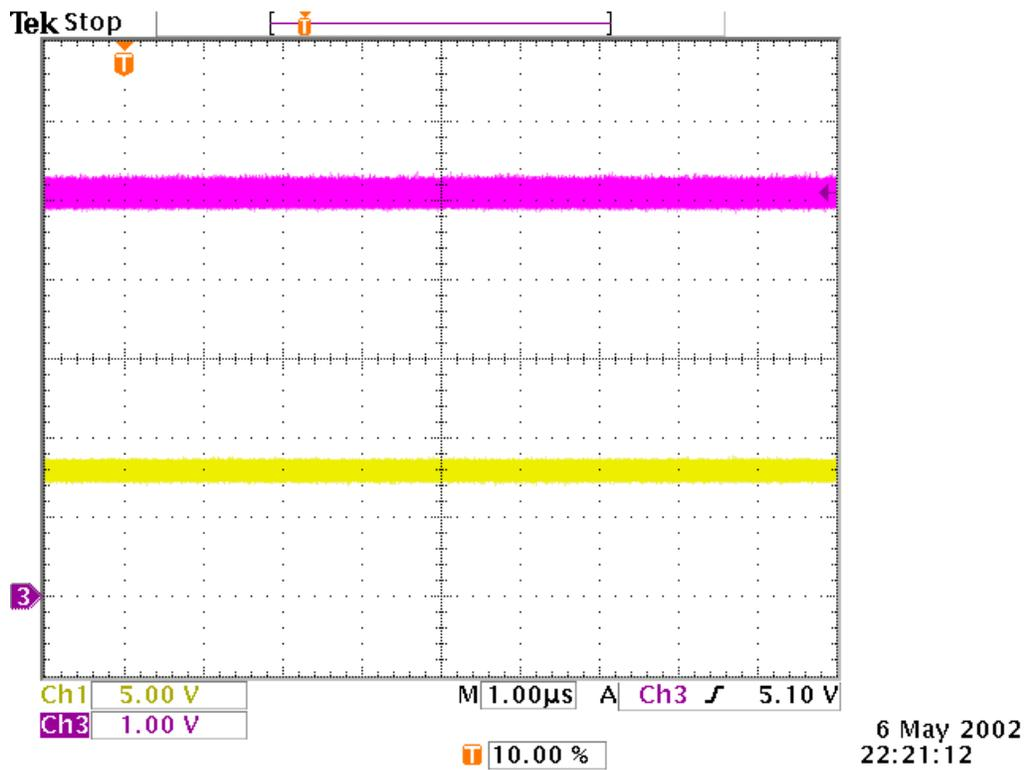

Figure 12: Test #12 Results ($V_{in}=8V$; $V_{out}=5V$; $I_{out}=6.25mA$; $C_{out}=44\mu F$)

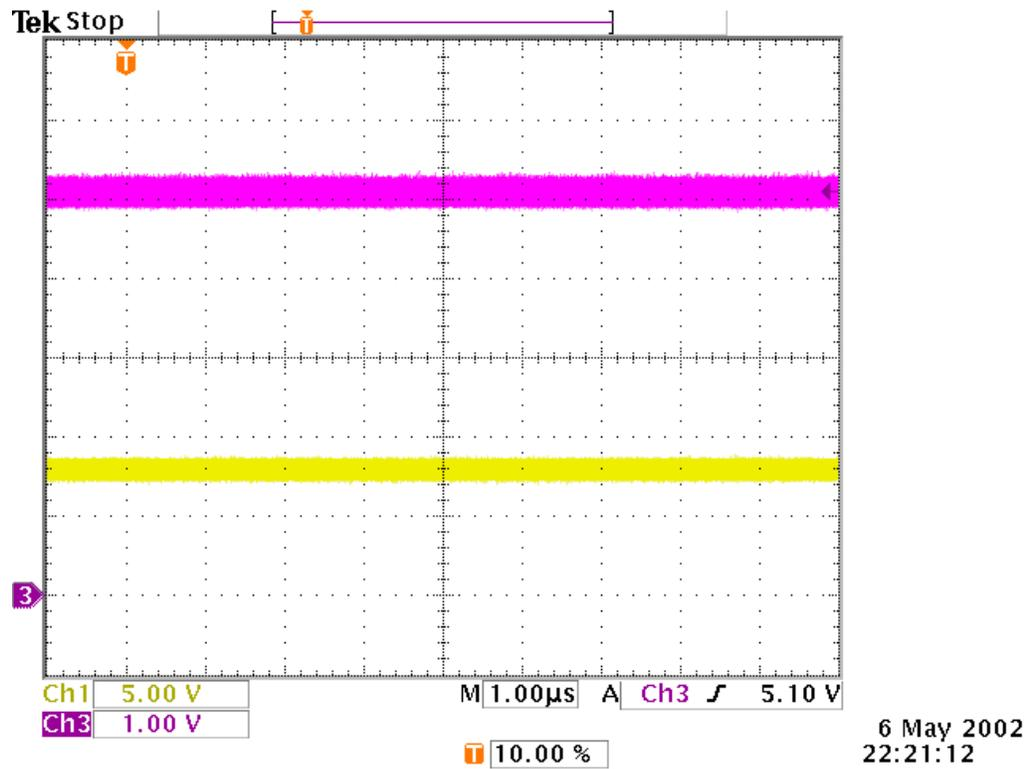

Figure 13: Test #13 Results ($V_{in}=8V$; $V_{out}=5V$; $I_{out}=500mA$; $C_{out}=22\mu F$)

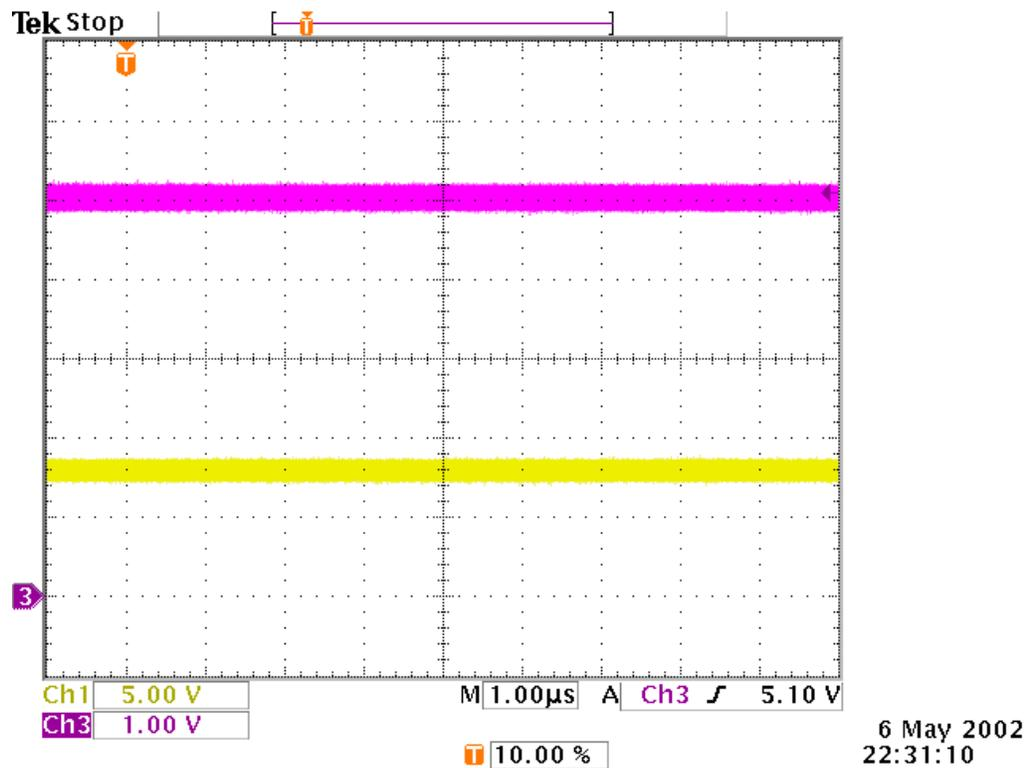

Figure 14: Test #14 Results ($V_{in}=8V$; $V_{out}=5V$; $I_{out}=500mA$; $C_{out}=44\mu F$)

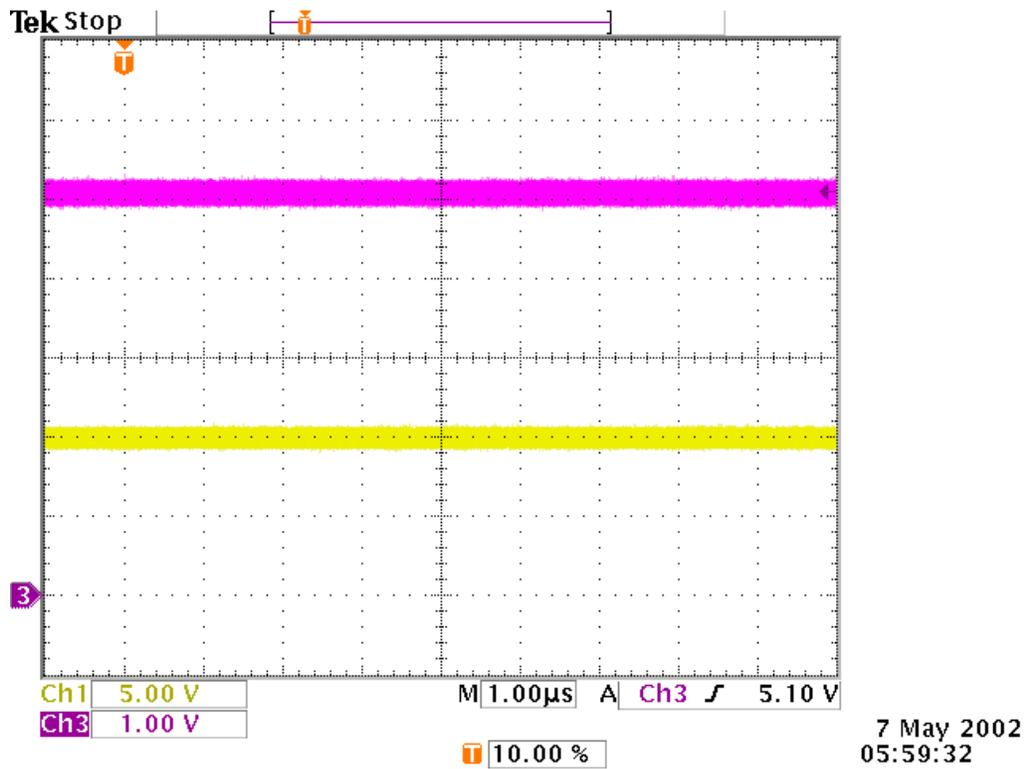

Figure 15: Test #15 Results ($V_{in}=10V$; $V_{out}=5V$; $I_{out}=6.25mA$; $C_{out}=22\mu F$)

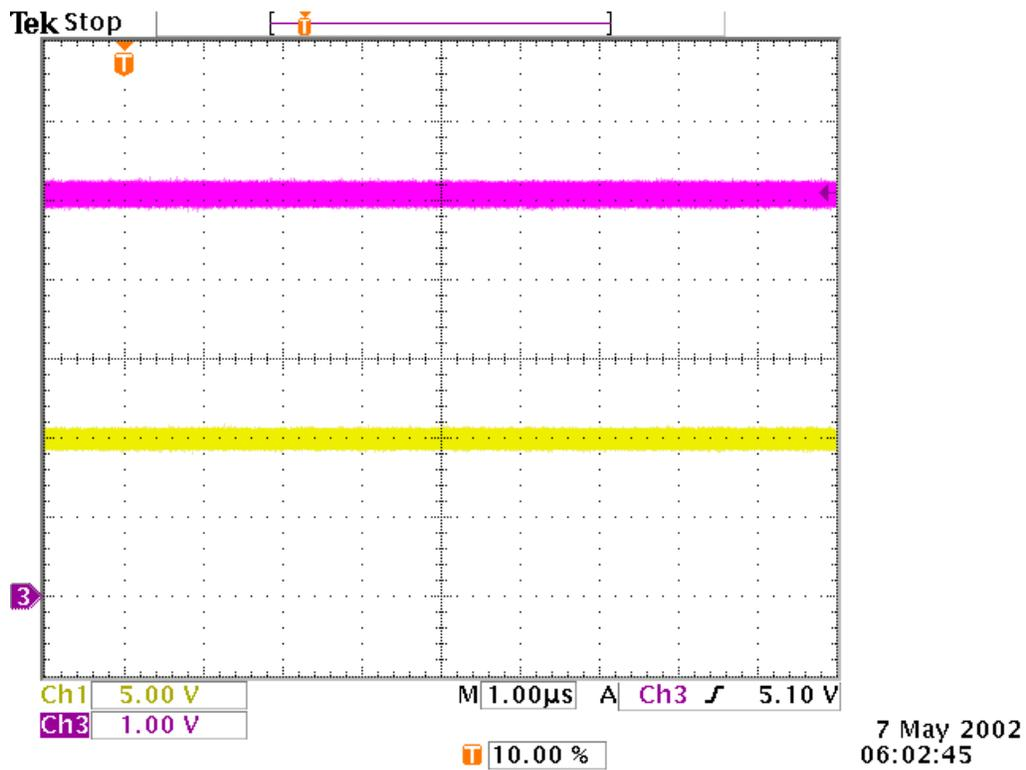

Figure 16: Test #16 Results ($V_{in}=10V$; $V_{out}=5V$; $I_{out}=6.25mA$; $C_{out}=44\mu F$)

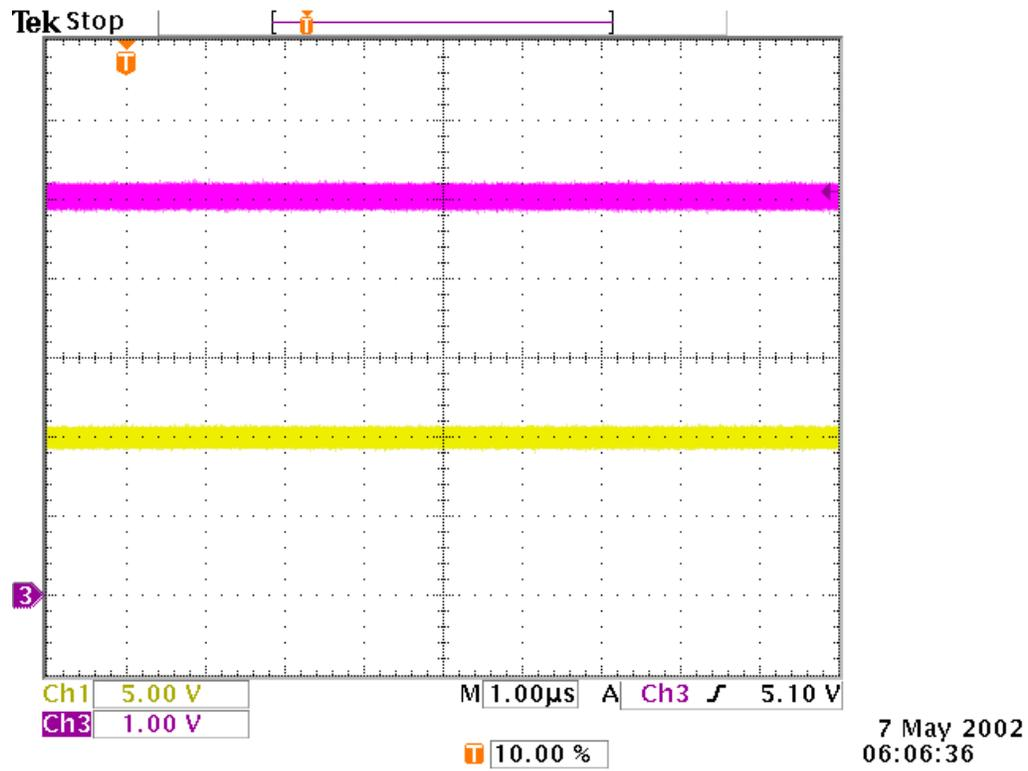

Figure 17: Test #17 Results ($V_{in}=10V$; $V_{out}=5V$; $I_{out}=500mA$; $C_{out}=22\mu F$)

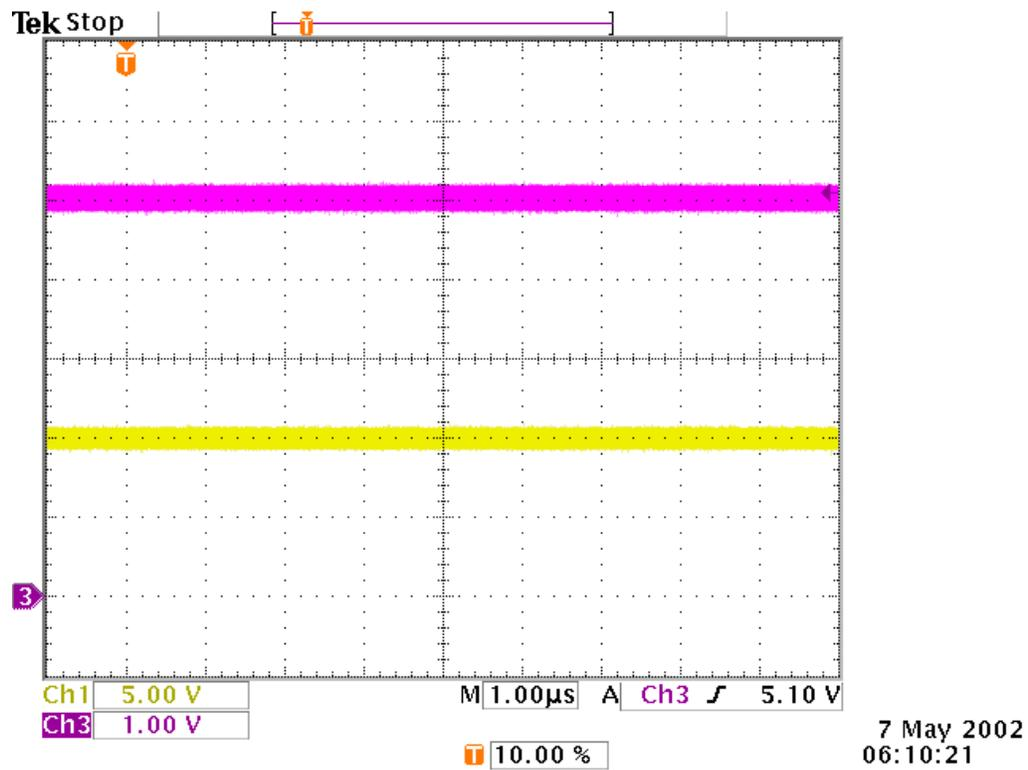

Figure 18: Test #18 Results ($V_{in}=10V$; $V_{out}=5V$; $I_{out}=500mA$; $C_{out}=44\mu F$)

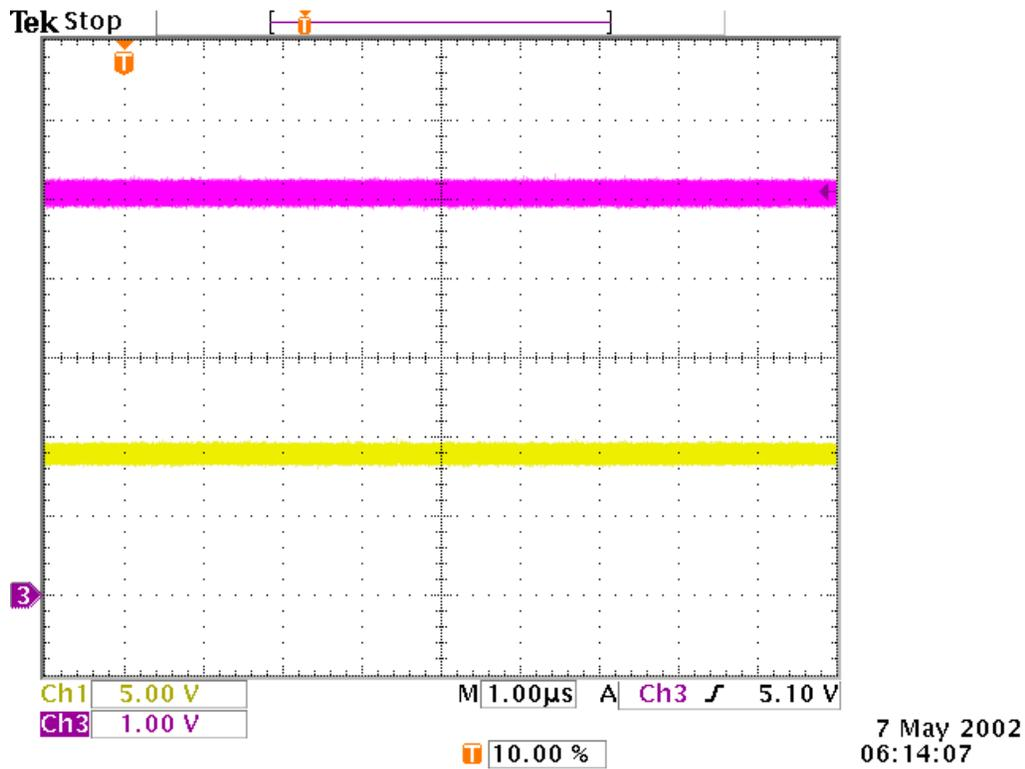

Figure 19: Test #19 Results ($V_{in}=9V$; $V_{out}=5V$; $I_{out}=6.25mA$; $C_{out}=22\mu F$)

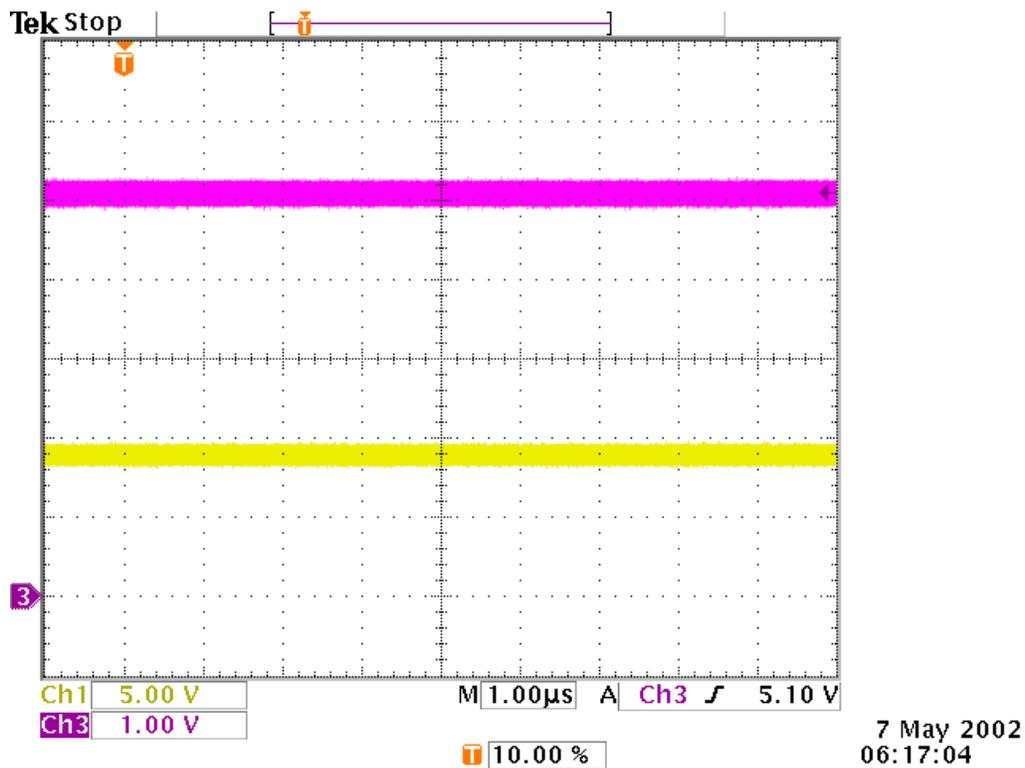

Figure 20: Test #20 Results ($V_{in}=9V$; $V_{out}=5V$; $I_{out}=6.25mA$; $C_{out}=44\mu F$)

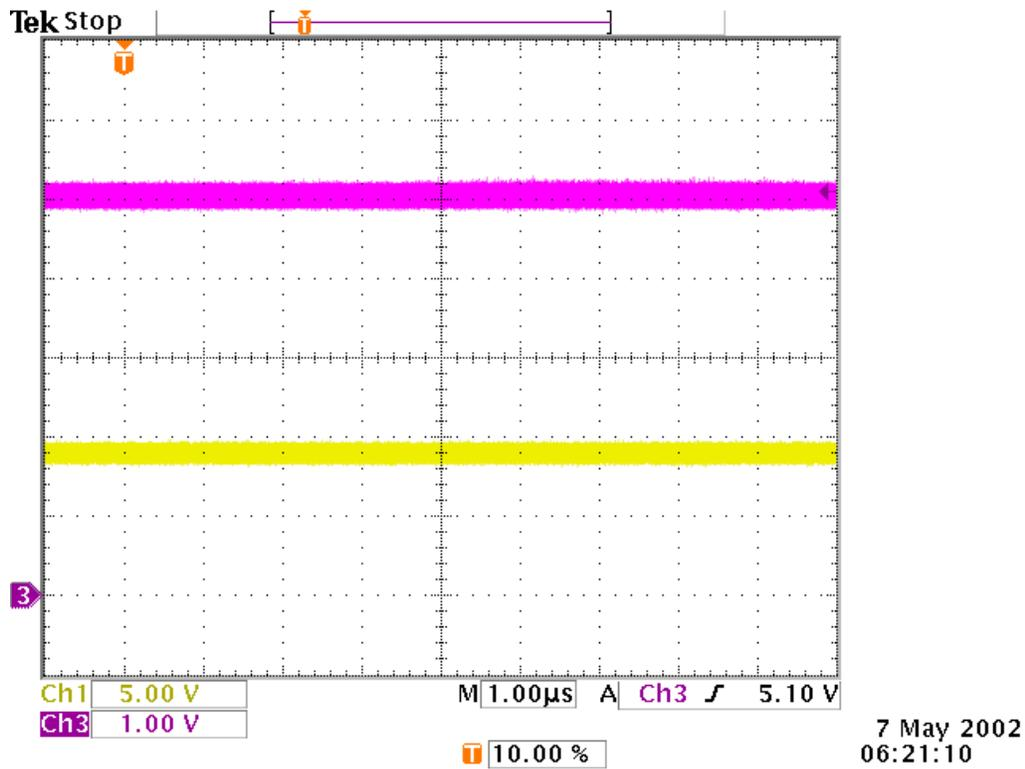

Figure 21: Test #21 Results ($V_{in}=9V$; $V_{out}=5V$; $I_{out}=500mA$; $C_{out}=22\mu F$)

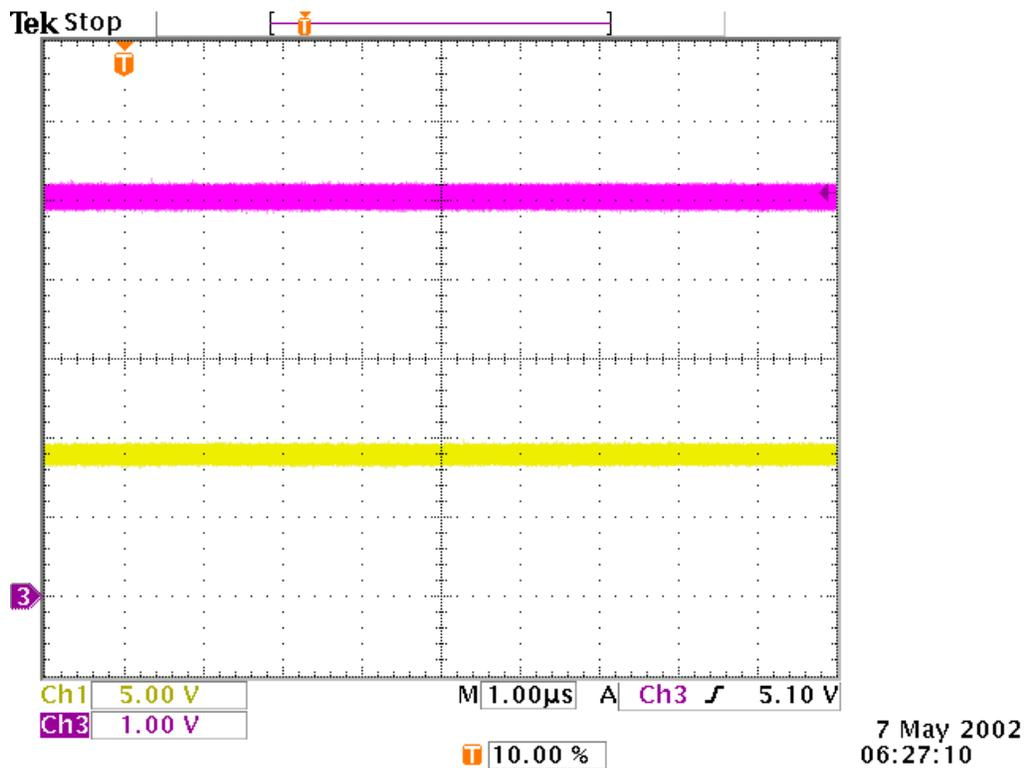

Figure 22: Test #22 Results ($V_{in}=9V$; $V_{out}=5V$; $I_{out}=500mA$; $C_{out}=44\mu F$)

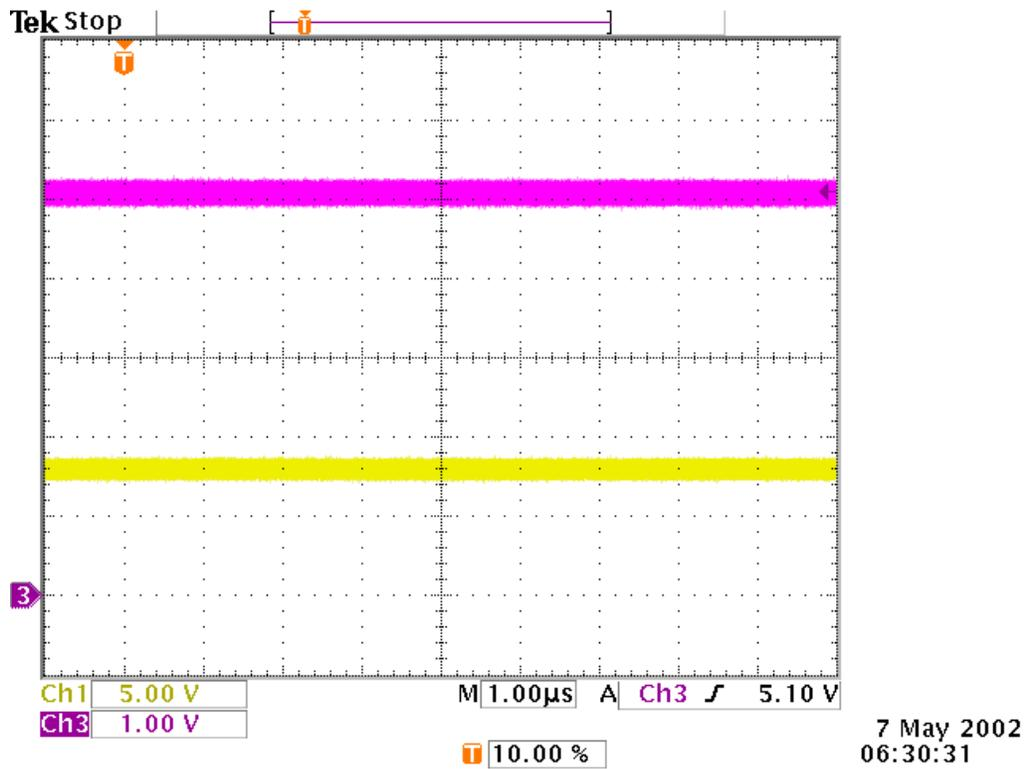

Figure 23: Test #23 Results ($V_{in}=8V$; $V_{out}=5V$; $I_{out}=6.25mA$; $C_{out}=22\mu F$)

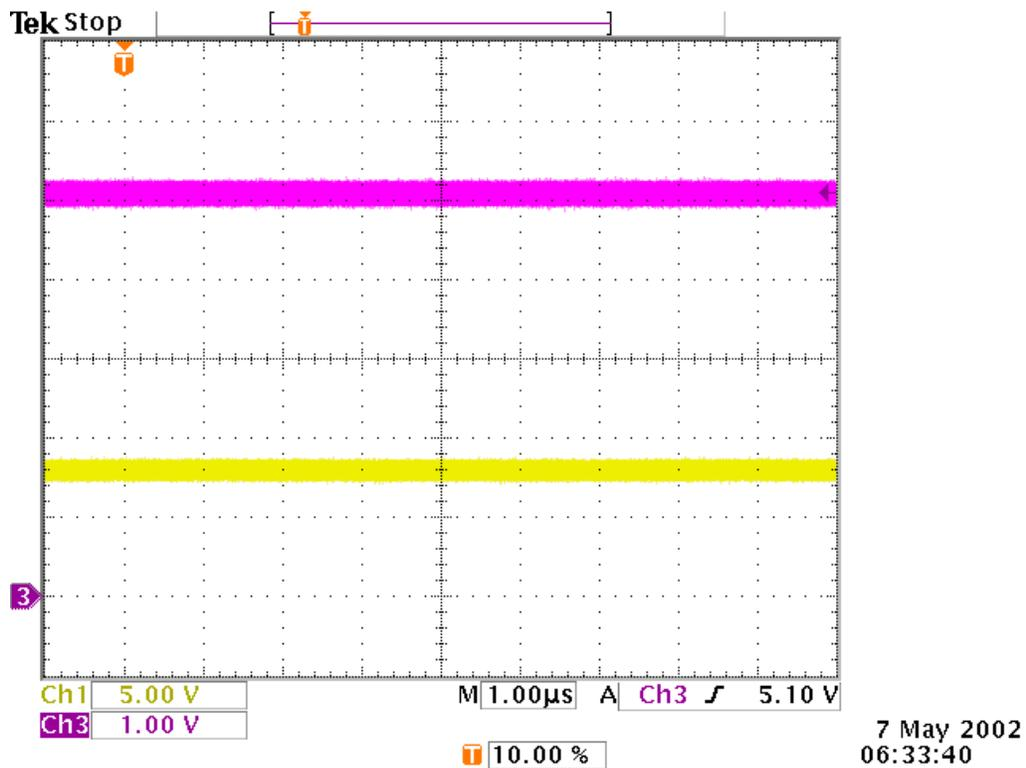

Figure 24: Test #24 Results ($V_{in}=8V$; $V_{out}=5V$; $I_{out}=6.25mA$; $C_{out}=44\mu F$)

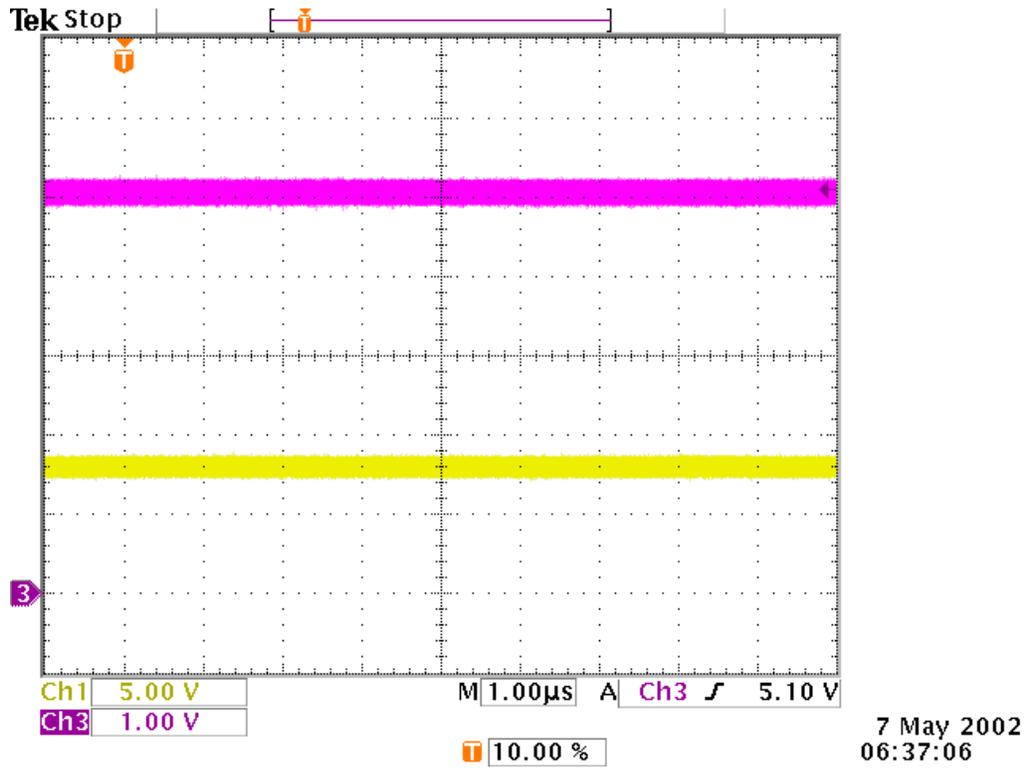

Figure 25: Test #25 Results ($V_{in}=8V$; $V_{out}=5V$; $I_{out}=500mA$; $C_{out}=22\mu F$)

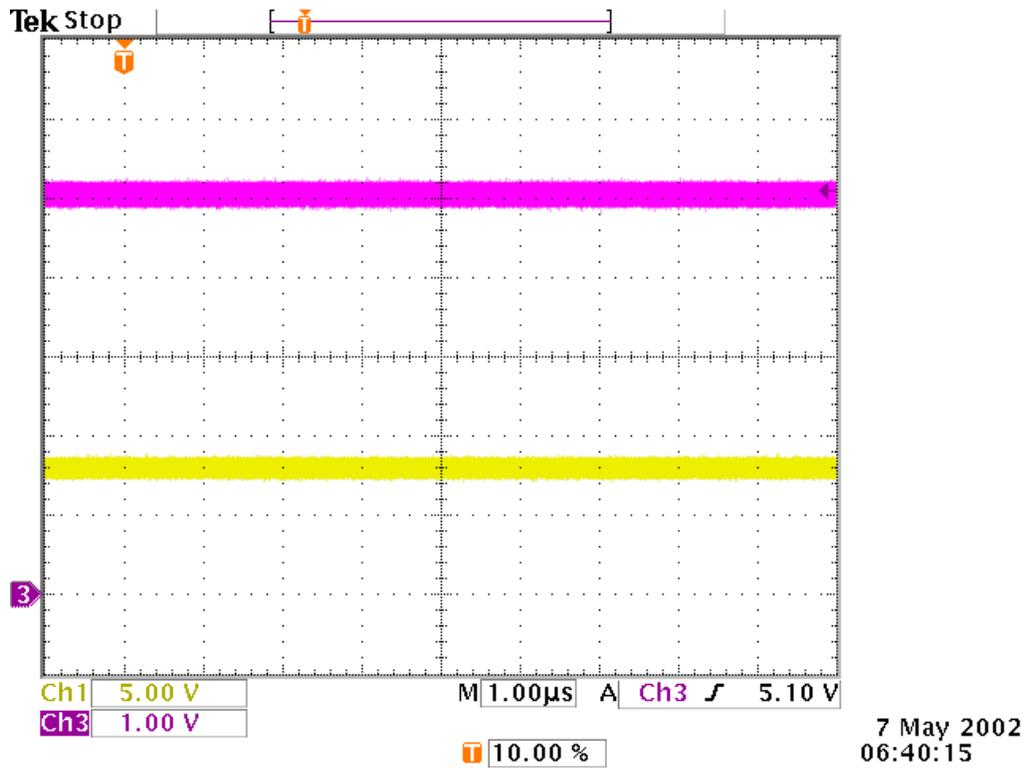

Figure 26: Test #26 Results ($V_{in}=8V$; $V_{out}=5V$; $I_{out}=500mA$; $C_{out}=44\mu F$)

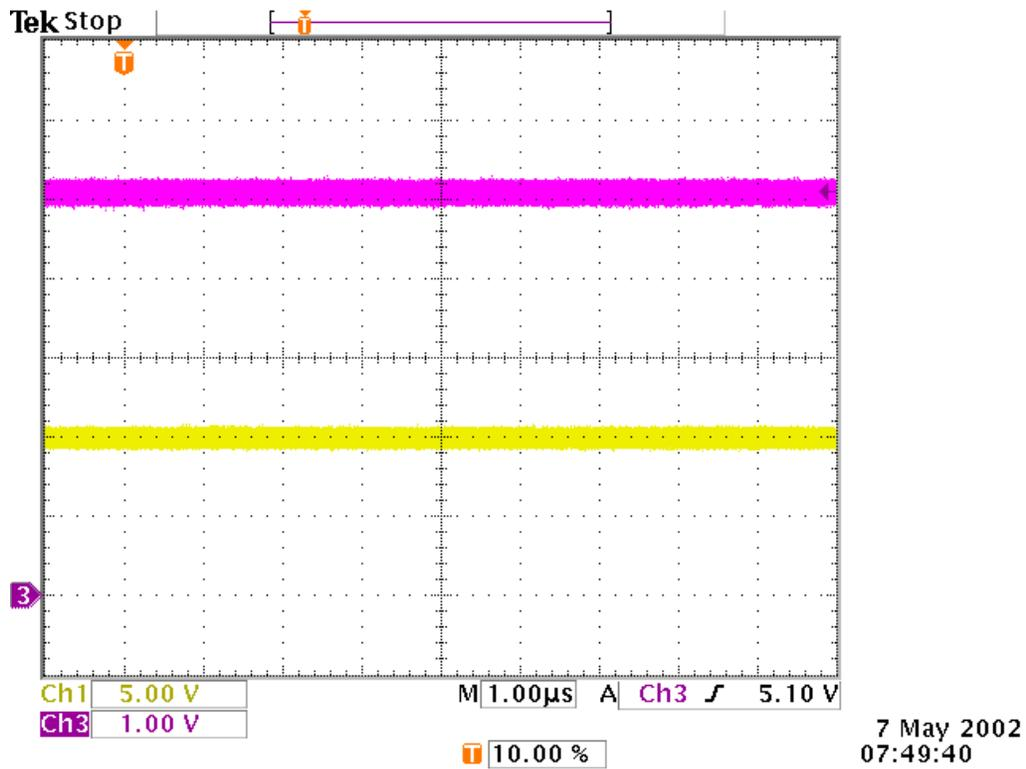

Figure 27: Test #27 Results ($V_{in}=10V$; $V_{out}=5V$; $I_{out}=6.25mA$; $C_{out}=22\mu F$)

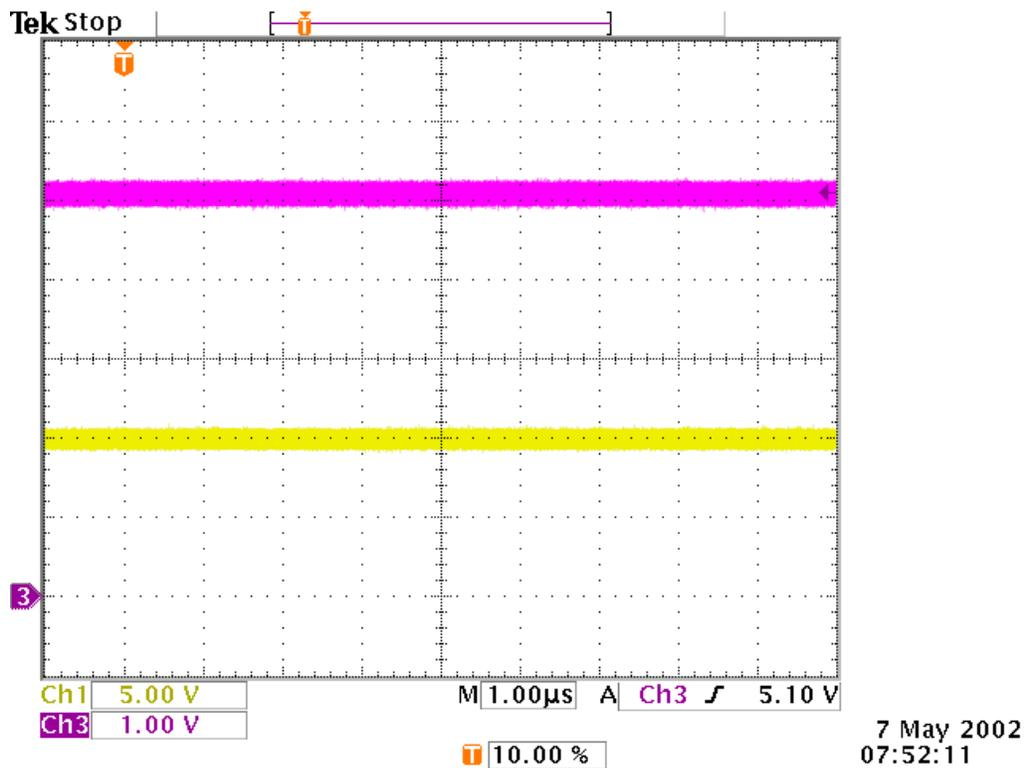

Figure 28: Test #28 Results ($V_{in}=10V$; $V_{out}=5V$; $I_{out}=6.25mA$; $C_{out}=44\mu F$)

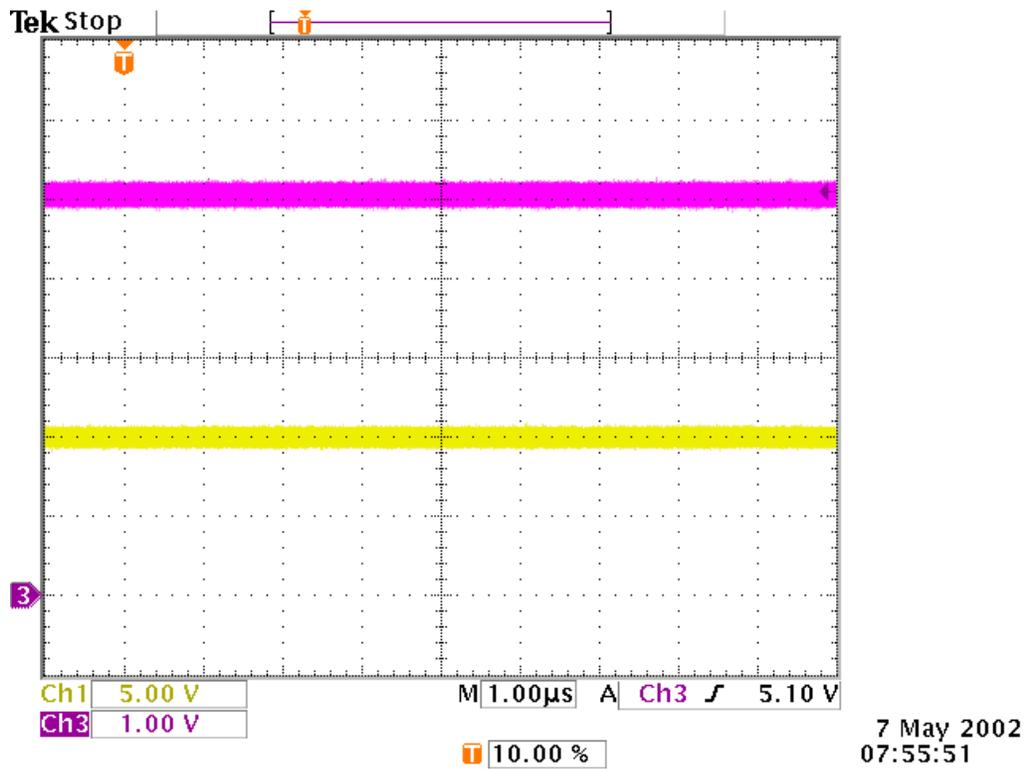

Figure 29: Test #29 Results ($V_{in}=10V$; $V_{out}=5V$; $I_{out}=500mA$; $C_{out}=22\mu F$)

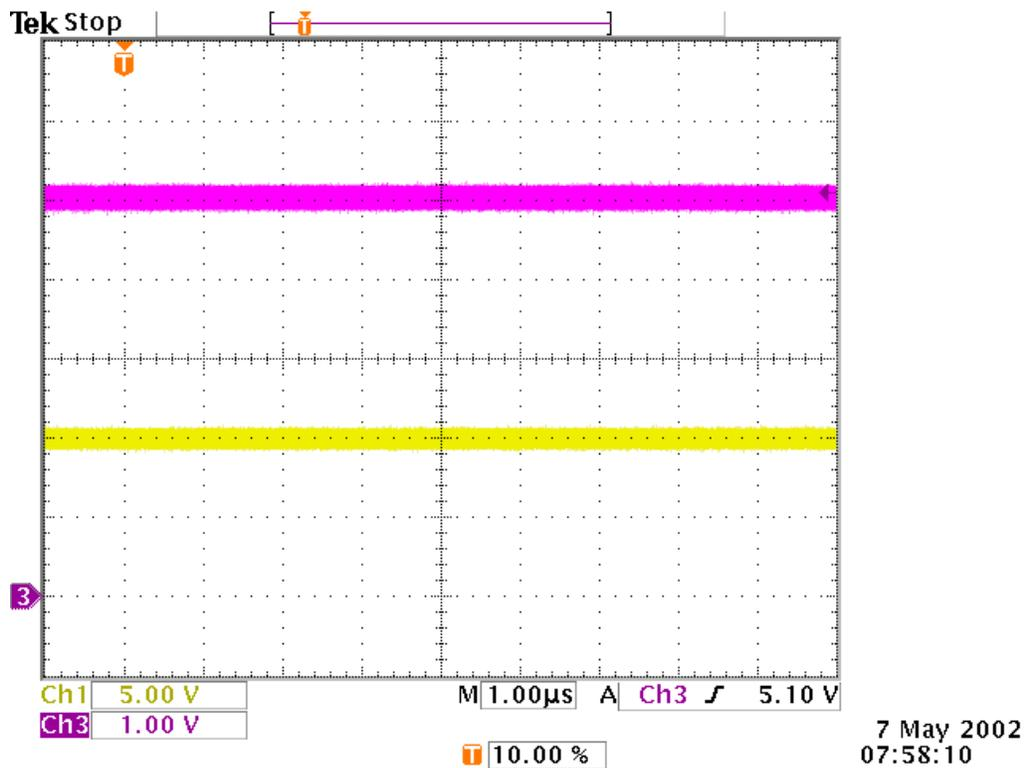

Figure 30: Test #30 Results ($V_{in}=10V$; $V_{out}=5V$; $I_{out}=500mA$; $C_{out}=44\mu F$)

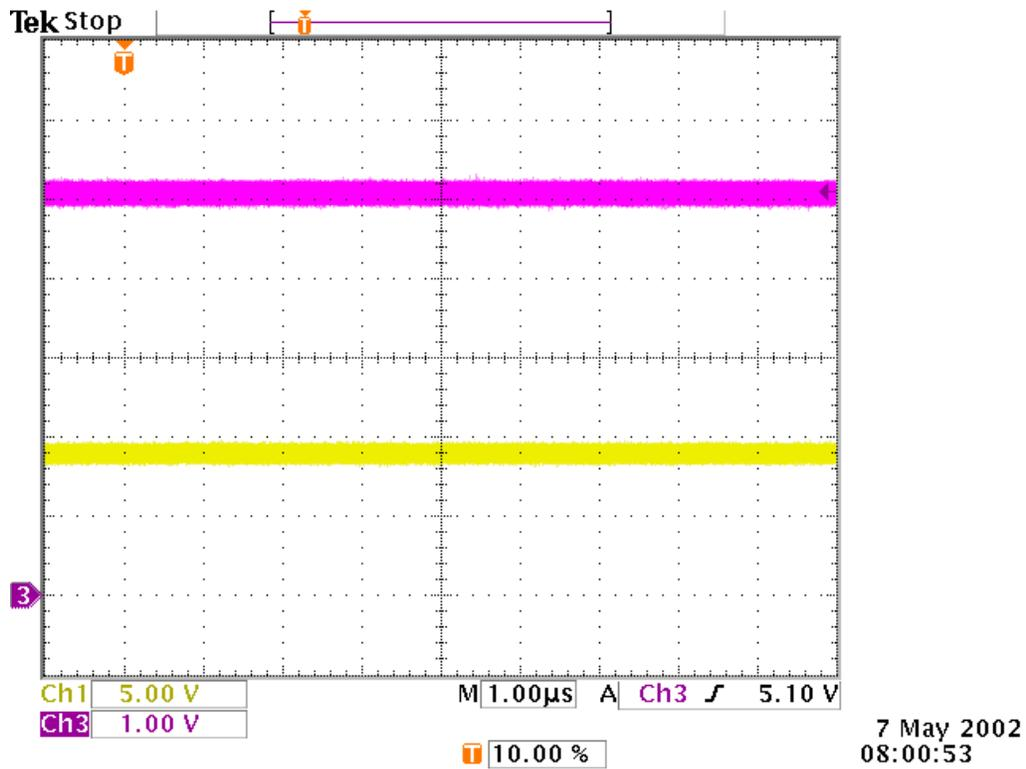

Figure 31: Test #31 Results ($V_{in}=9V$; $V_{out}=5V$; $I_{out}=6.25mA$; $C_{out}=22\mu F$)

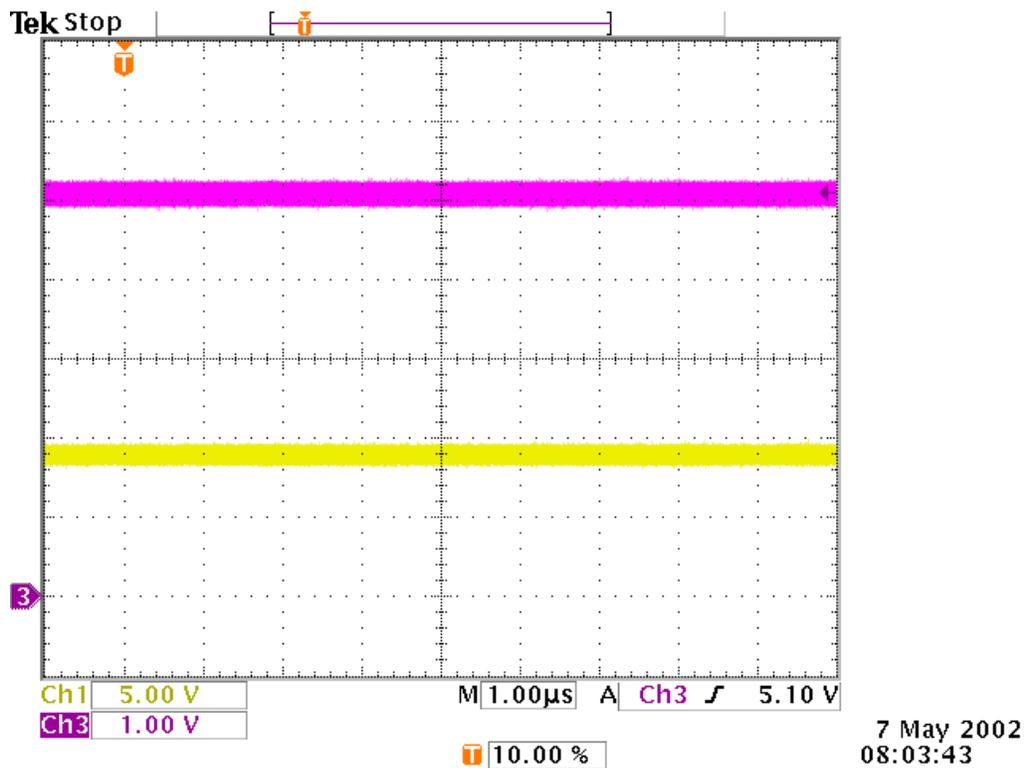

Figure 32: Test #32 Results ($V_{in}=9V$; $V_{out}=5V$; $I_{out}=6.25mA$; $C_{out}=44\mu F$)

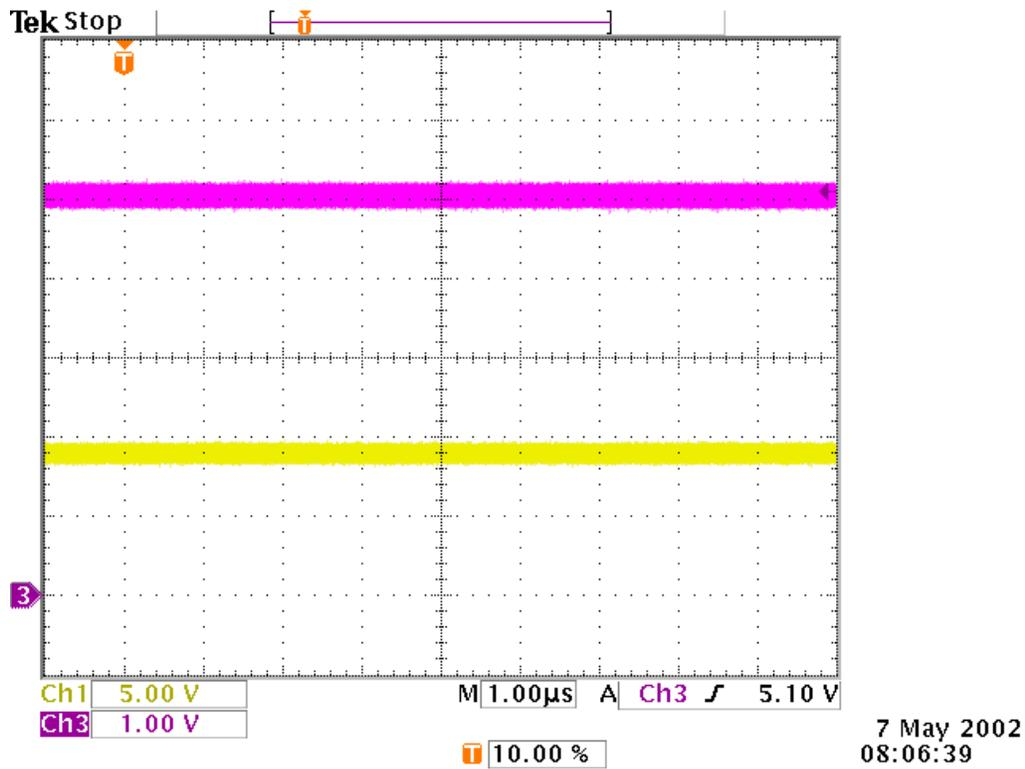

Figure 33: Test #33 Results ($V_{in}=9V$; $V_{out}=5V$; $I_{out}=500mA$; $C_{out}=22\mu F$)

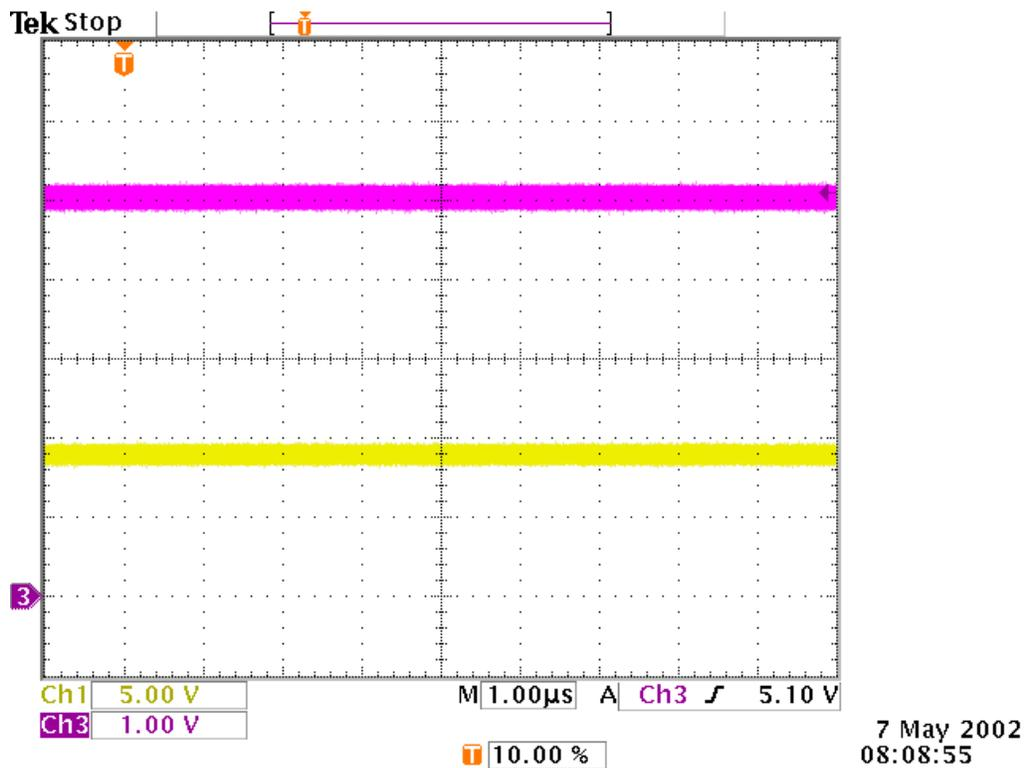

Figure 34: Test #34 Results ($V_{in}=9V$; $V_{out}=5V$; $I_{out}=500mA$; $C_{out}=44\mu F$)

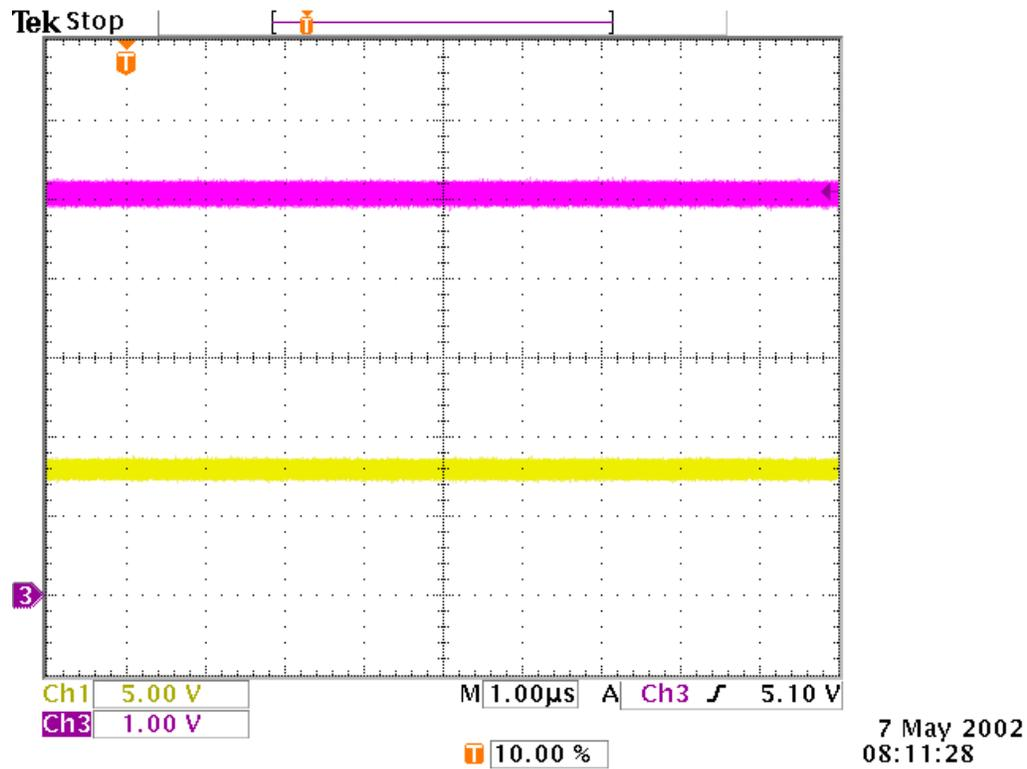

Figure 35: Test #35 Results ($V_{in}=8V$; $V_{out}=5V$; $I_{out}=6.25mA$; $C_{out}=22\mu F$)

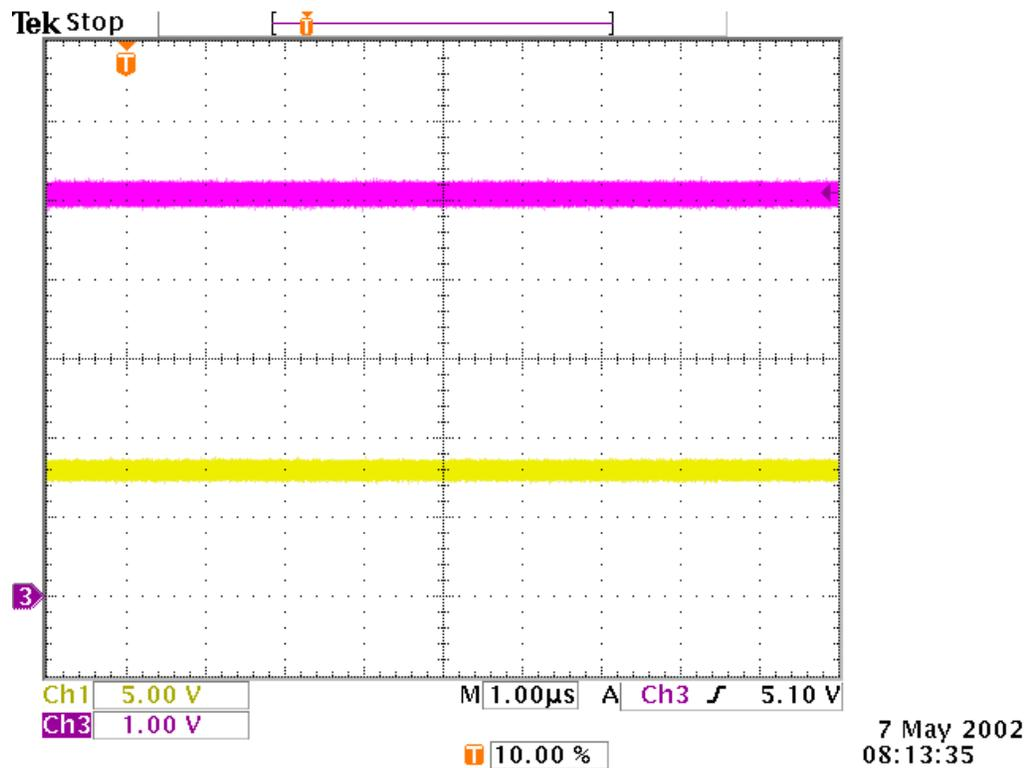

Figure 36: Test #36 Results ($V_{in}=8V$; $V_{out}=5V$; $I_{out}=6.25mA$; $C_{out}=44\mu F$)

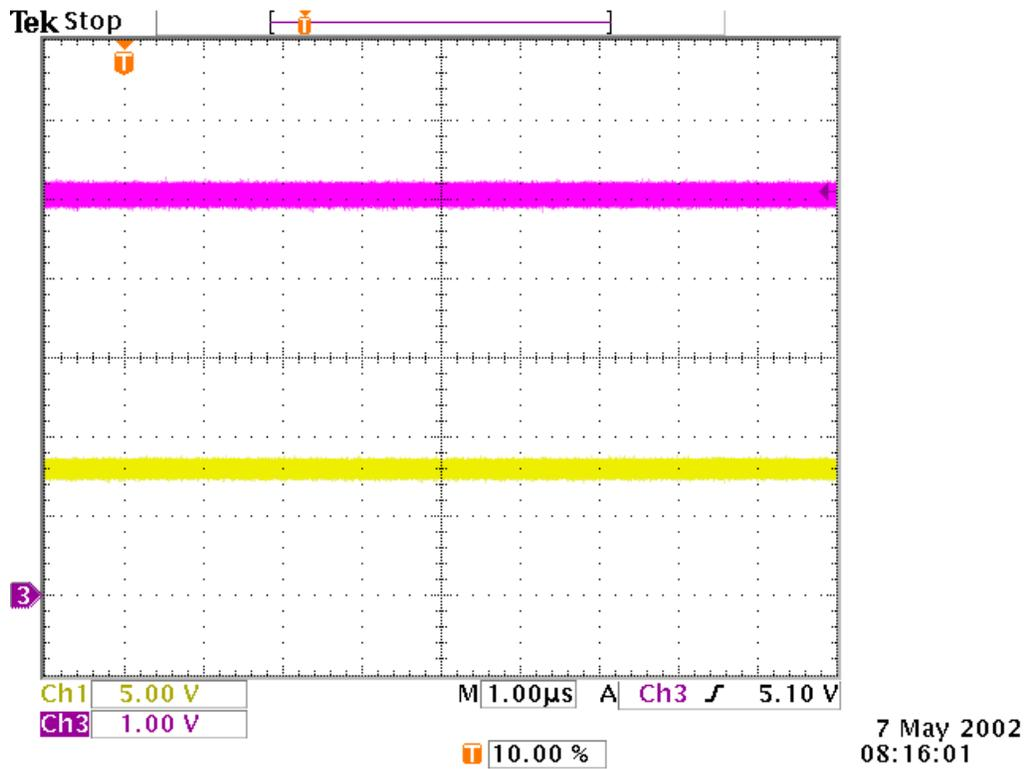

Figure 37: Test #37 Results ($V_{in}=8V$; $V_{out}=5V$; $I_{out}=500mA$; $C_{out}=22\mu F$)

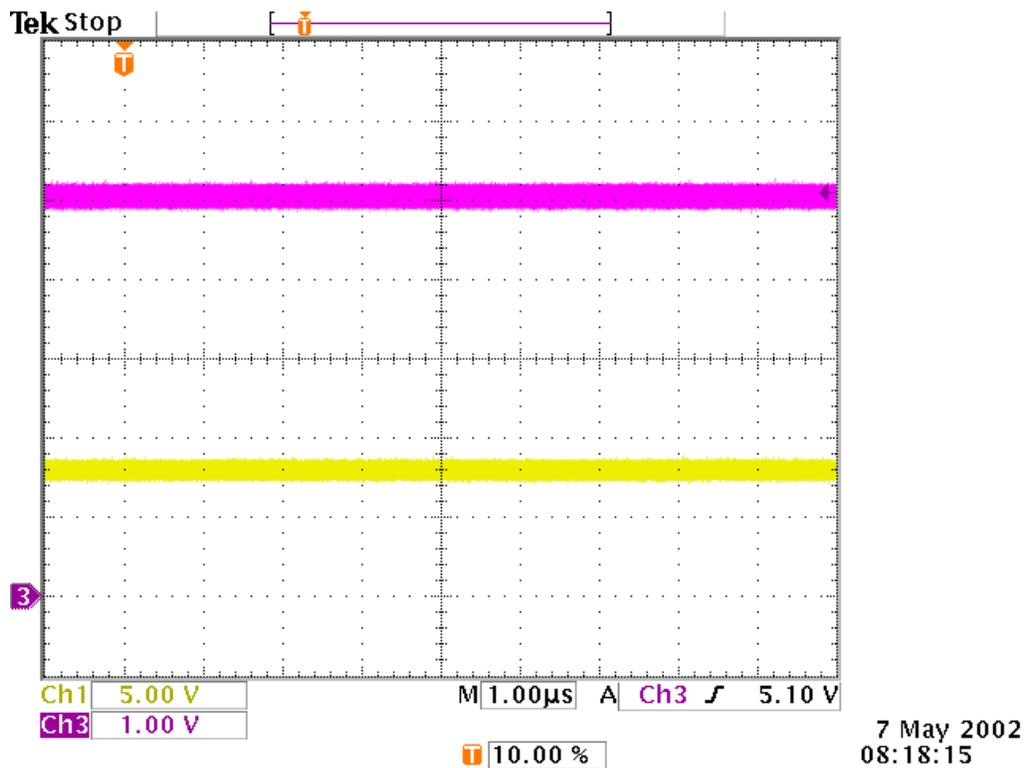

Figure 38: Test #38 Results ($V_{in}=8V$; $V_{out}=5V$; $I_{out}=500mA$; $C_{out}=44\mu F$)