

R-IN32M4-CL2

Industrial Ethernet Communication LSI

R18UZ0048EJ0202

Rev2.0.2

Apr 19, 2019

1.	IAR Tool Installation and License Setup	1
1.1	Download IAR Tool Installer <R>	1
1.2	Install and Setup Evaluation License	2
2.	Setup and Connect R-IN32M4-CL2 Board.....	8
2.1	Boot Mode Selection for R-IN32M4-CL2 Boards.....	8
2.2	IAR Starter-Kit Setup Procedure	10
2.3	R-IN32M4-CL2 Evaluation Board Setup Procedure	11
3.	Install USB Serial Conversion Driver on PC.....	13
3.1	Download the Driver	13
3.2	Install the FT232R USB UART Driver	14
3.3	Install USB Serial Port Driver	17
3.4	Configure UART Communication.....	19
4.	Use Sample Programs	22
4.1	Download the R-IN32M4 Sample Programs	22
4.2	Run “cie_intelligent_device” Sample Program with EWARM Tool.....	22
4.3	Select Build Setting	24
4.4	Build and Run “cie_intelligent_device” Program.....	25
5.	CC-Link IE Field Communication	27
5.1	Get the Sample Stack for CC-Link IE Field	27
5.2	Download CC-Link IE Field Utility	27
5.3	Install WinPcap.....	27
5.4	Confirm CC-Link IE Field Communication	28
5.4.1	Link CC-Link IE Field.....	28
5.4.2	Cyclic Communication — Data for Transmission	29
5.4.3	Cyclic Communication — Received Data	30
5.4.4	Transient Communication.....	31

General Precautions in the Handling of Microprocessing Unit and Microcontroller Unit Products0

Notice 1

Corporate Headquarters 1

Contact information..... 1

Trademarks..... 1

1. IAR Tool Installation and License Setup

1.1 Download IAR Tool Installer <R>

Download the IAR tool installer from the IAR web page (<https://www.iar.com/iar-embedded-workbench/>).

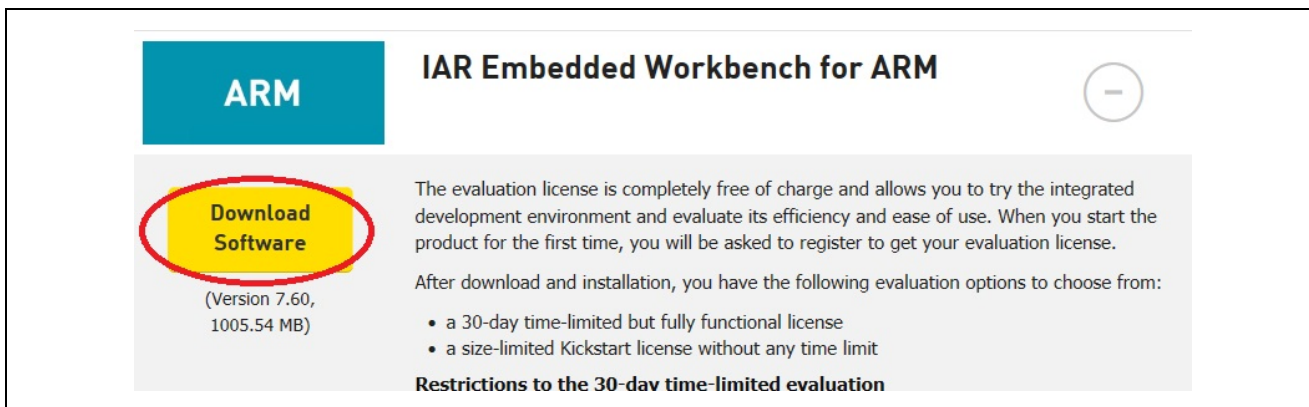
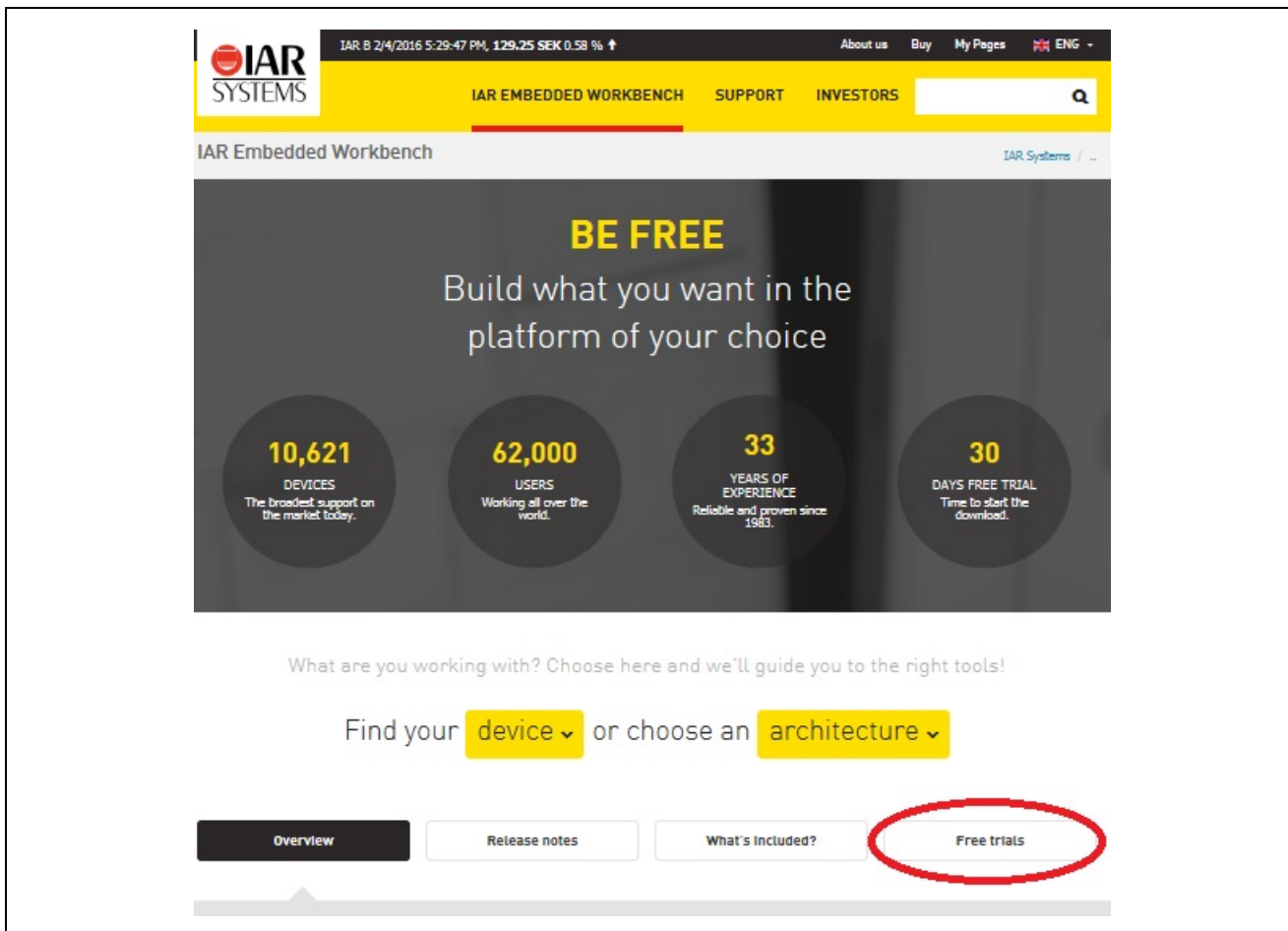

Run the downloaded installer (EARM-CD-****-****.exe: **** = version number). The below window will pop up and the necessary files will be unzipped automatically in the C:\Users directory. After extraction, the installer menu window will appear.

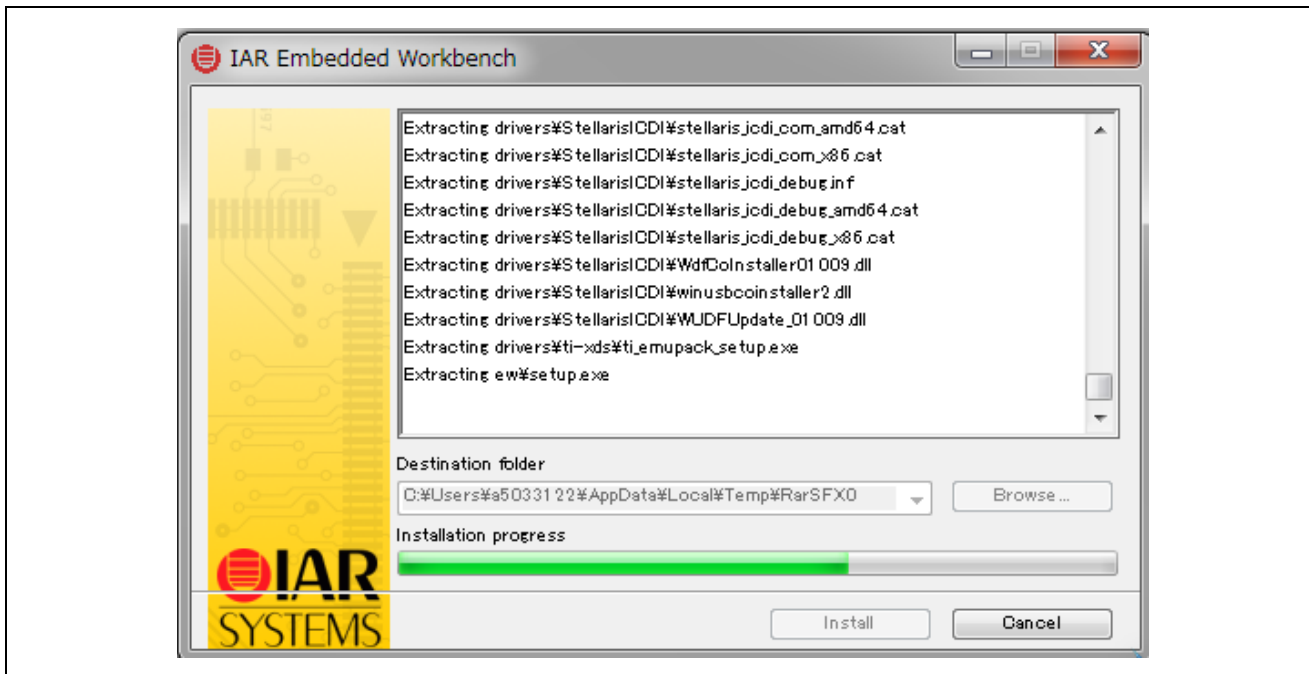

1.2 Install and Setup Evaluation License

Click "Install IAR Embedded Workbench®" in the menu window.

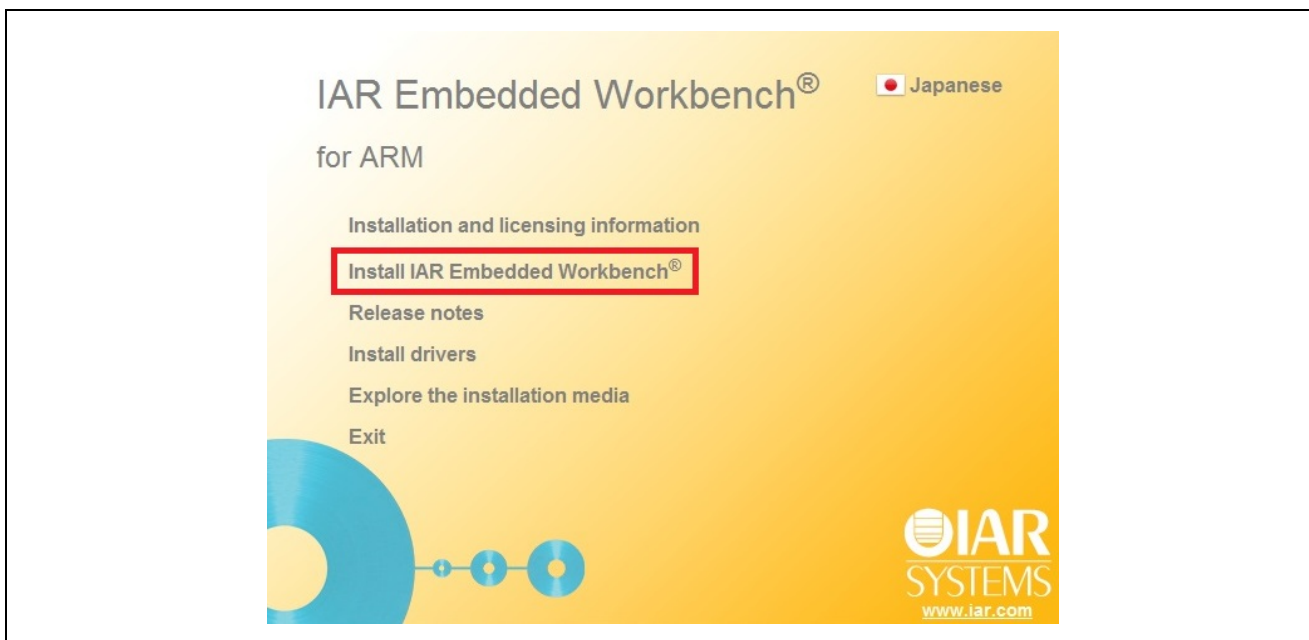

The license wizard window will open. Make sure the computer has access to internet and select “Register with IAR Systems to get an evaluation license”.

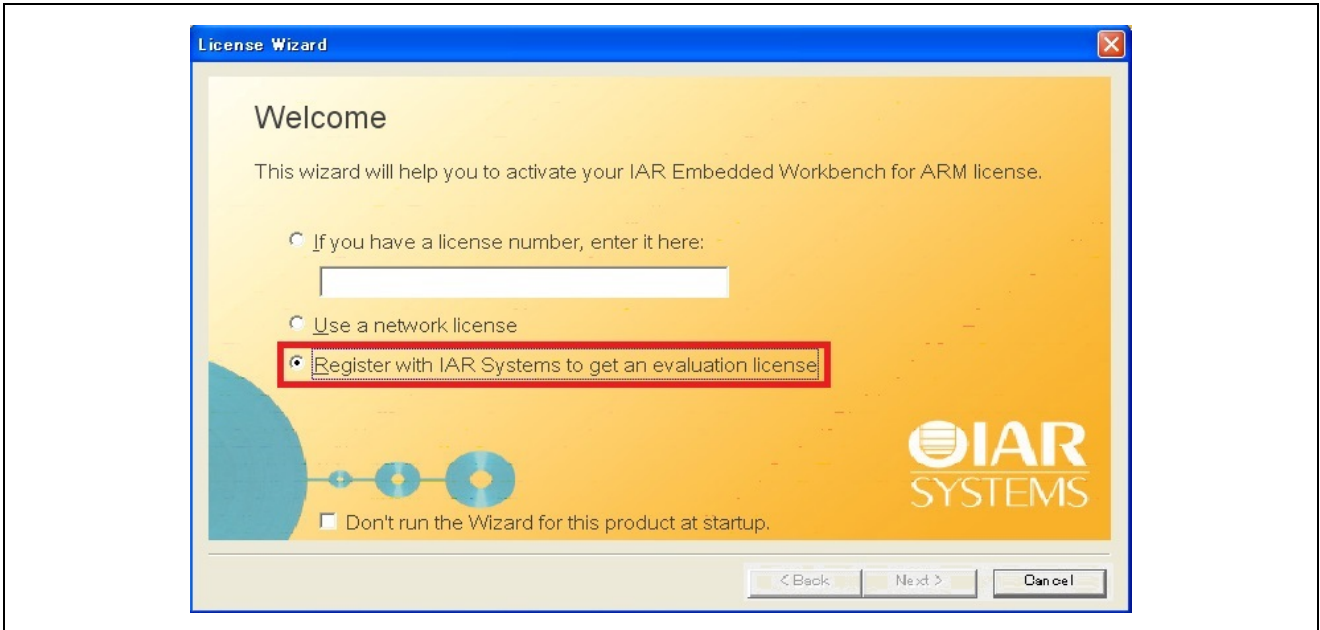

Choose a product and click [Next] button.

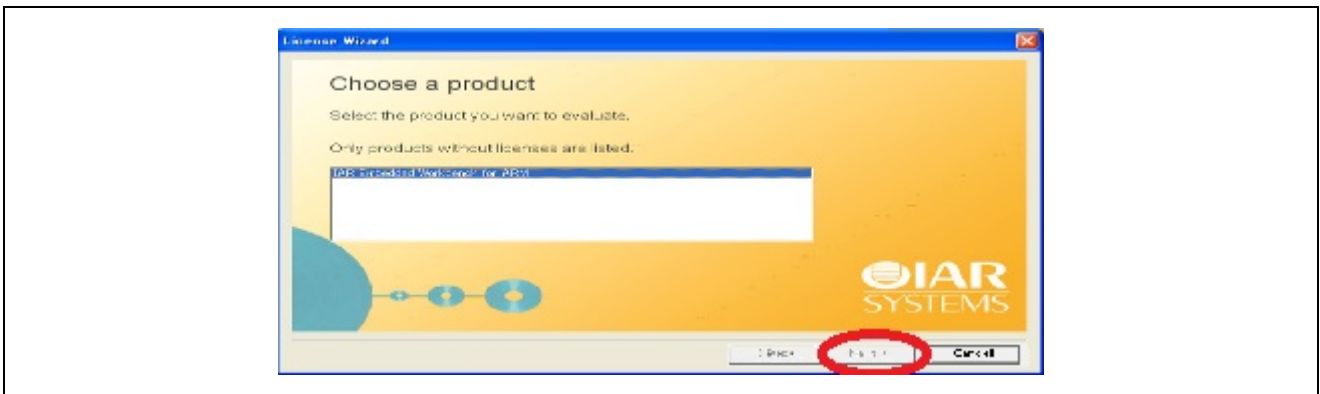

Click [Register] button

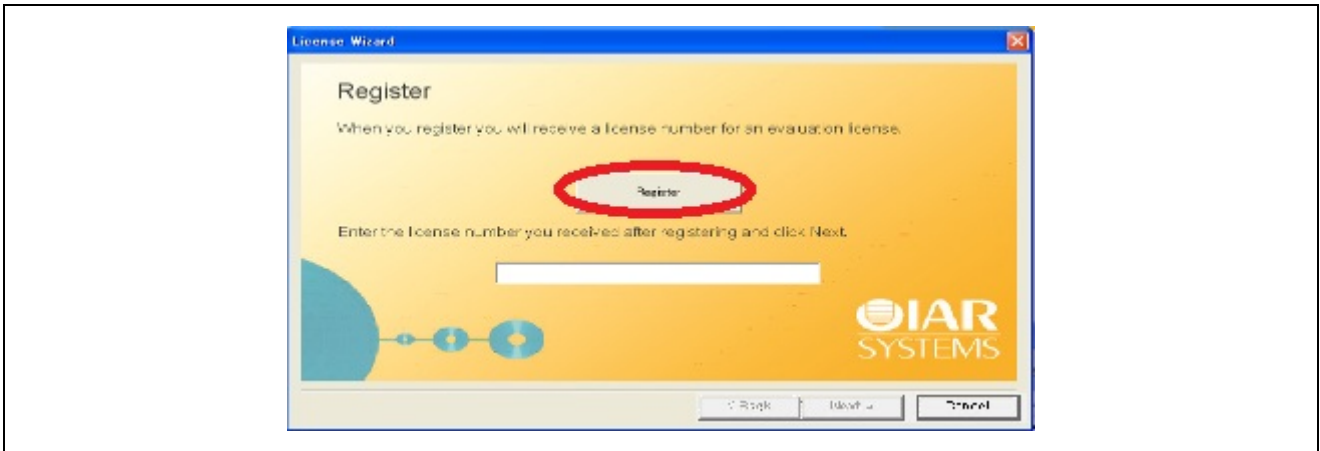

This will start the web browser and navigate to the user registration page for the evaluation license. Select either "Time limited" or "Code size limited", then enter the necessary user information.

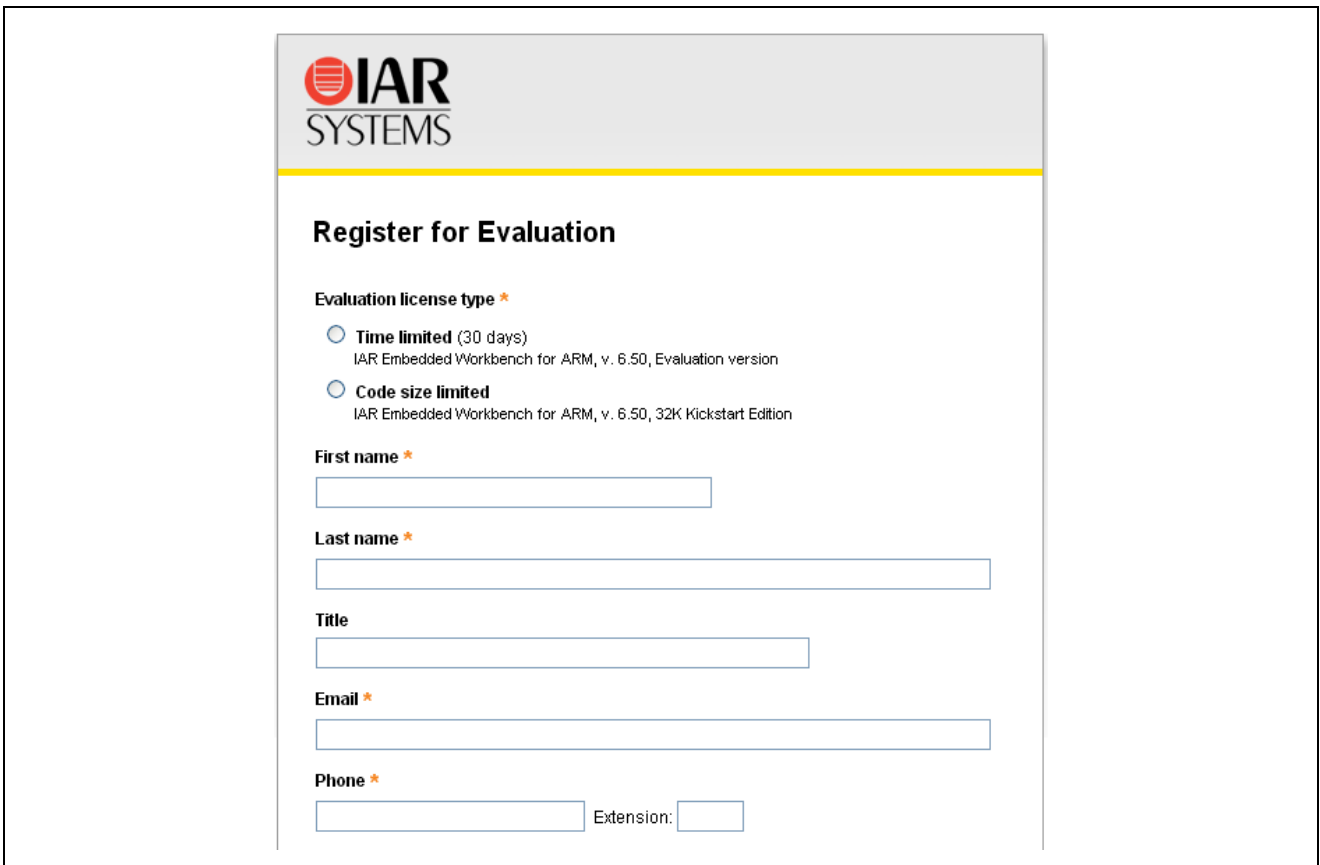

Click [Submit Registration] button.

Will you use an RTOS in your project? *

Yes
 No

Which RTOS vendor would you be interested in?

CMX
 Eforce
 Express Logic
 FreeRTOS
 Freescale MQX
 Micrium
 Micro Digital
 Quadros
 Sciopta
 SEGGER
 Wittenstein
 Other, please specify:

* indicates a required field.

Submit Registration

By registering, you accept to receive information from IAR Systems in the future.

An email with license number will be sent to your registered email address within a few minutes.

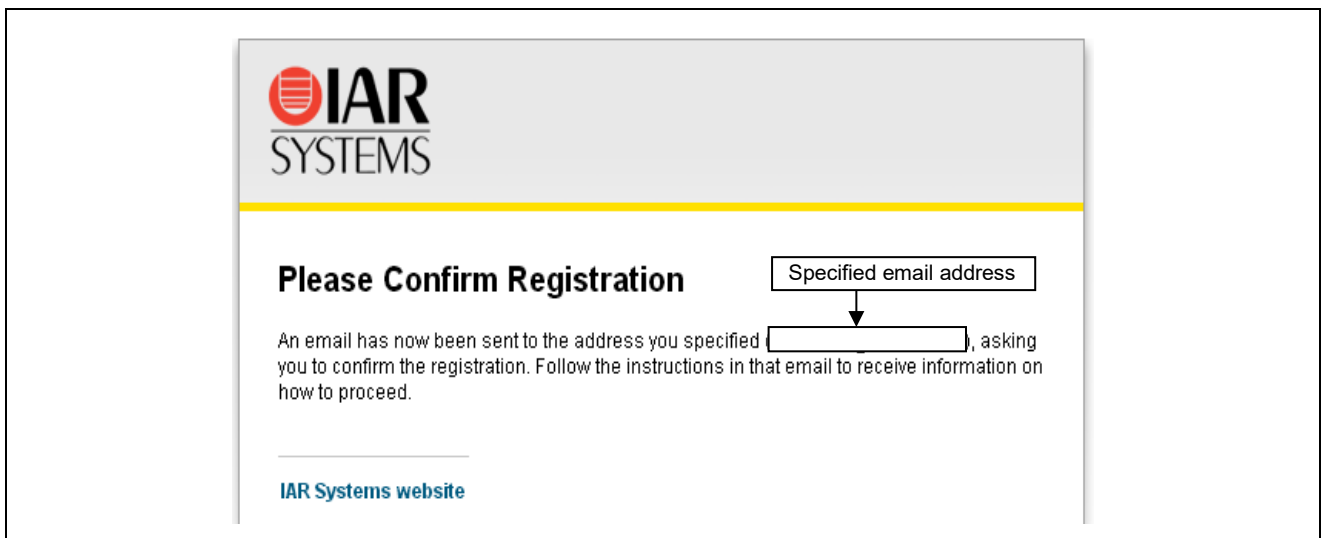

Double click the registration address (<https://register.iar.com/confirm?key=XXXX>) in the e-mail.

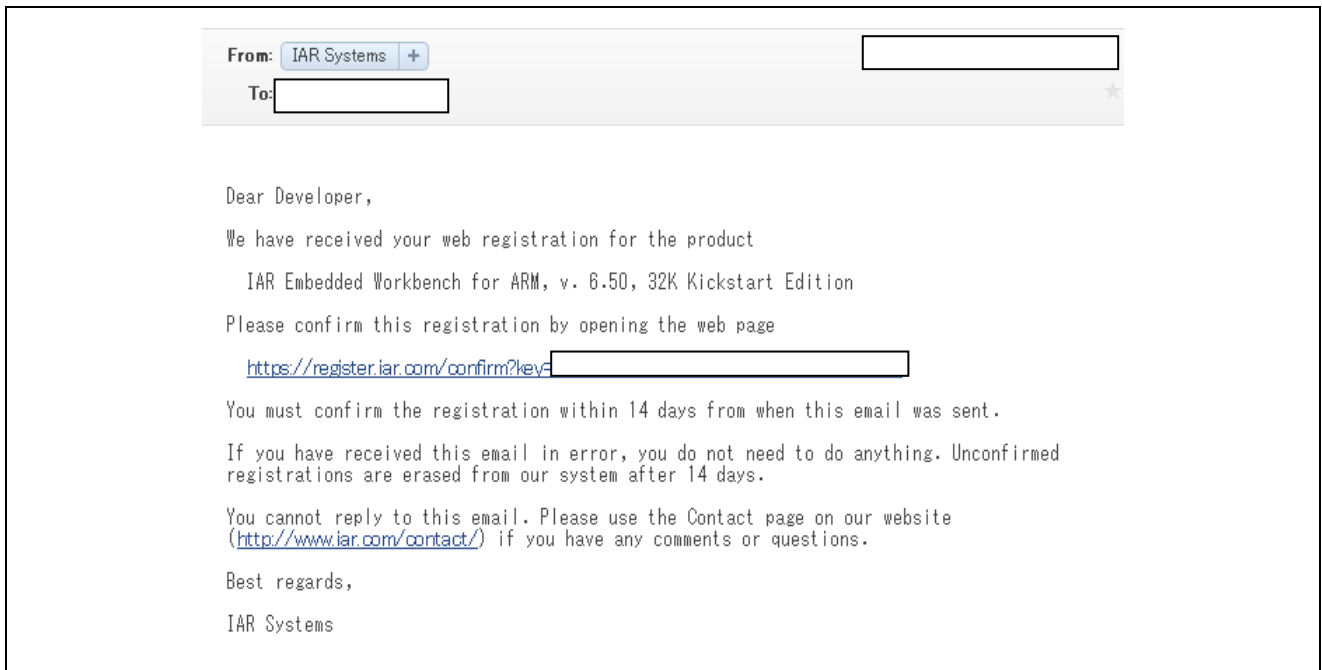

A 14-digit license key will be displayed in “XXXX” below. This license key is bound to the registered PC, so when using several PC’s, it is necessary to acquire and setup license for each PC.

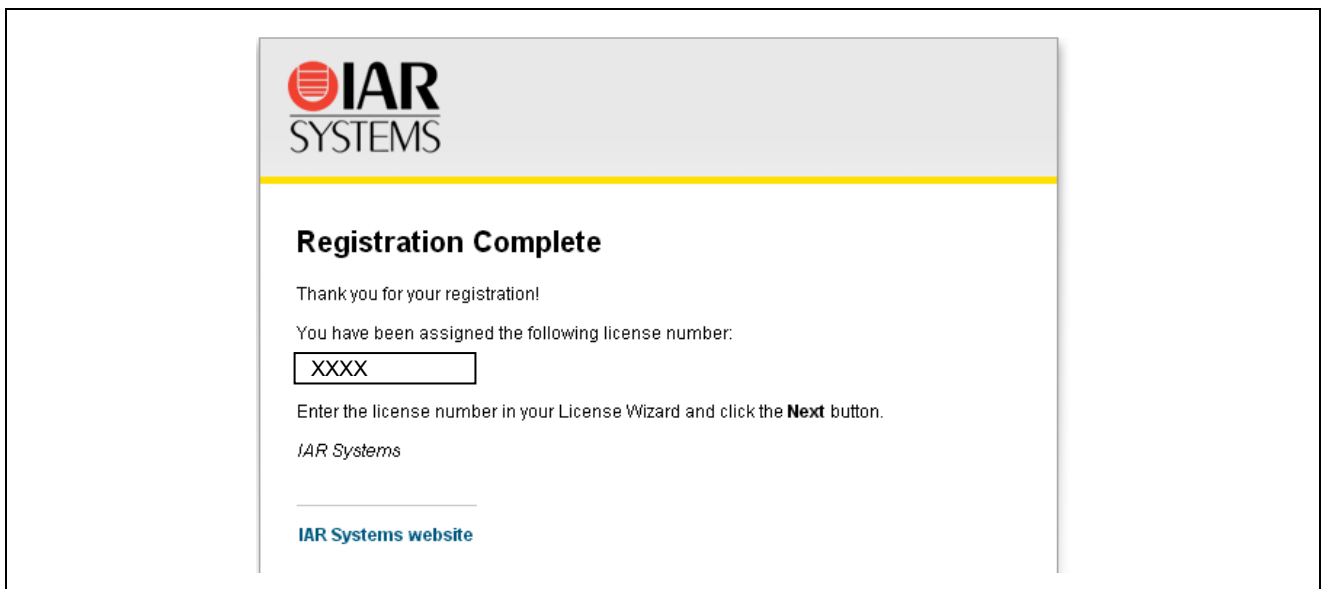

Go back to License Wizard window; input the received license number and click [Next] button to activate the IAR tool.



Registration is completed.

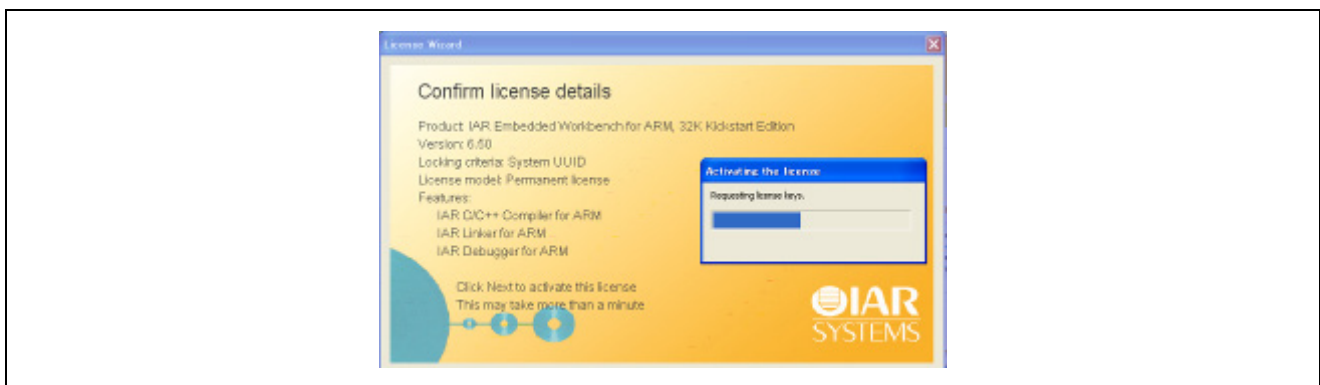

It is possible to activate the software with both a “Time limited” license and a “Code size limited” license, and switch them with license manager. For details, refer to the license guide (EW_LicensingGuide_LMS2.ENU.pdf) in installation directory “¥IAR Systems¥Embedded Workbench *.¥common¥doc” folder. For release information of the IAR tool and related documents, refer to <https://www.iar.com/iar-embedded-workbench/> <R>

2. Setup and Connect R-IN32M4-CL2 Board

There are two types of R-IN32M4-CL2 mounting board, a starter-kit board from IAR and an evaluation board from TSSR. Refer to the WEB site of each company for detailed information of each board.

IAR starter kit for R-IN32M4-CL2

<https://www.iar.com/iar-embedded-workbench/partners/renesas/tools-for-renesas-r-in32/> <R>

TSSR evaluation board TS-R-IN32M4-CL2

<http://www.tessera.co.jp/ts-r-in32m4.html> <R>

2.1 Boot Mode Selection for R-IN32M4-CL2 Boards

Select the boot mode with on-board terminals (BOOT0, BOOT1). In the case of the IAR starter-kit board, DSW2 selects boot mode. While for the TSSR evaluation board, SW1 selects boot mode.

Table 2.1 Select Boot Mode (IAR Starter-Kit Board)

DSW2 (BOOT1)	Boot Mode Selection
ON (High)	Boot from instruction RAM (only for debug)
OFF (Low)	Boot from external serial flash ROM

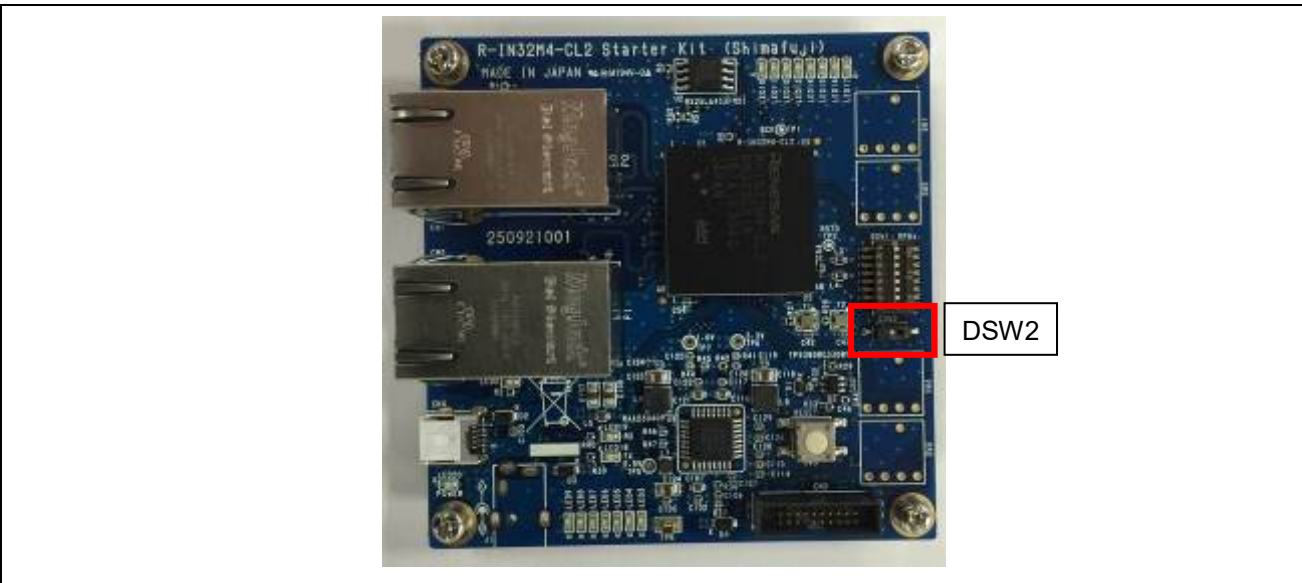
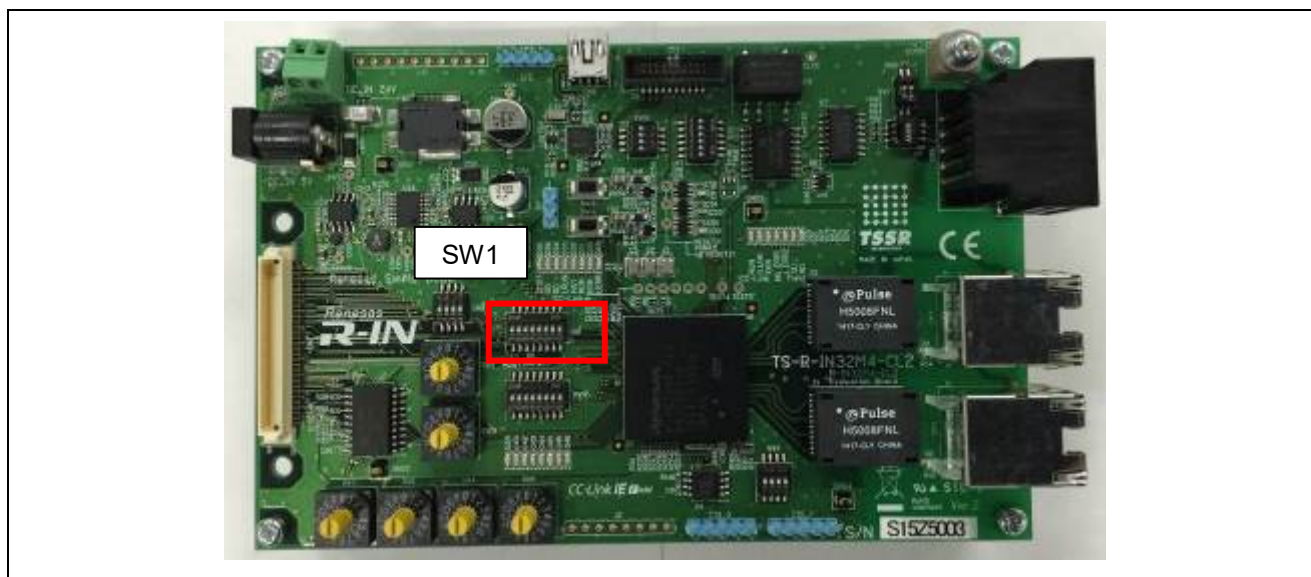

Table 2.2 Select Boot Mode (TS-R-IN32M4-CL2)

SW1		Boot Mode Selection
1 (BOOT1)	2 (BOOT0)	
ON (High)	ON (High)	Boot from instruction RAM (for debug only)
ON (High)	OFF (Low)	Boot from external MCU
OFF (Low)	ON (High)	Boot from external serial flash ROM
OFF (Low)	OFF (Low)	Boot from external memory (not available for users)



2.2 IAR Starter-Kit Setup Procedure

Follow the steps below to connect and boot an IAR starter-kit board:

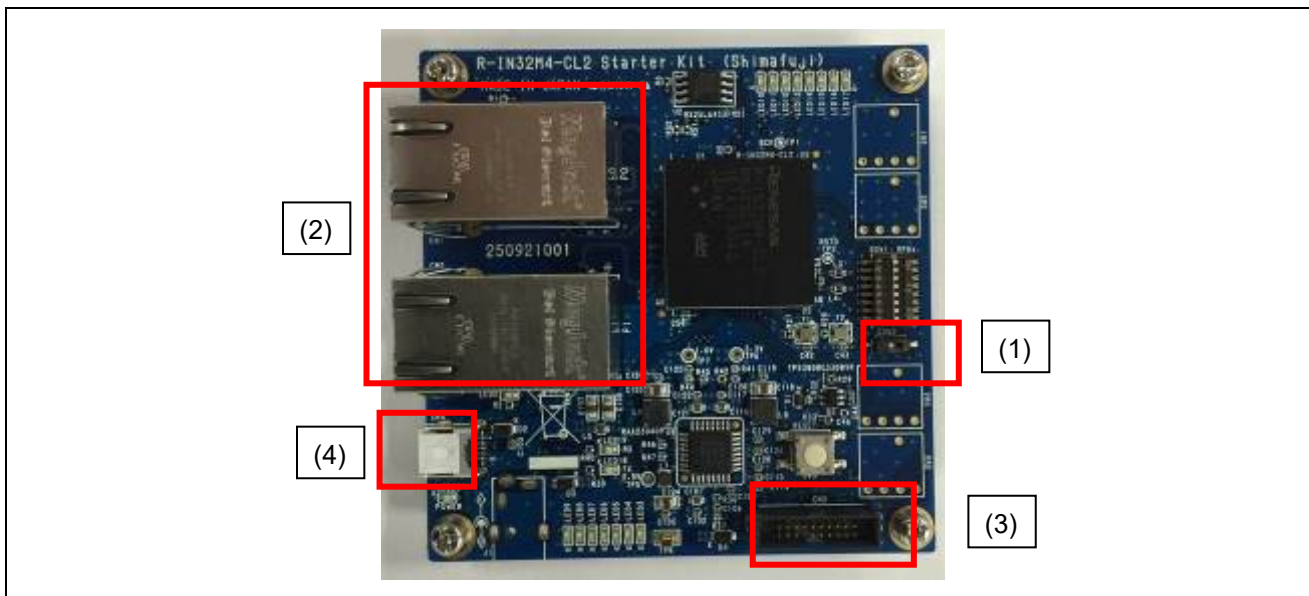

- (1) Set DIP-SW (DSW2) to select boot mode.
- (2) Use an Ethernet cable (category 5e or later recommended) to connect either port 0 or port 1 on the board (the picture above) with your PC's Ethernet port.
- (3) Connect the 20-pin half-pitch connector to the ICE.
Notice: No.1 terminal of the cable, which is Red one, must be on the left.
Then connect the ICE to the PC by the USB cable that comes with ICE I-jet.
- (4) Use the kit-include mini-USB cable to connect the mini-USB port on the starter-kit board and a USB port on the PC.
This USB cable supplies power to the starter-kit board.

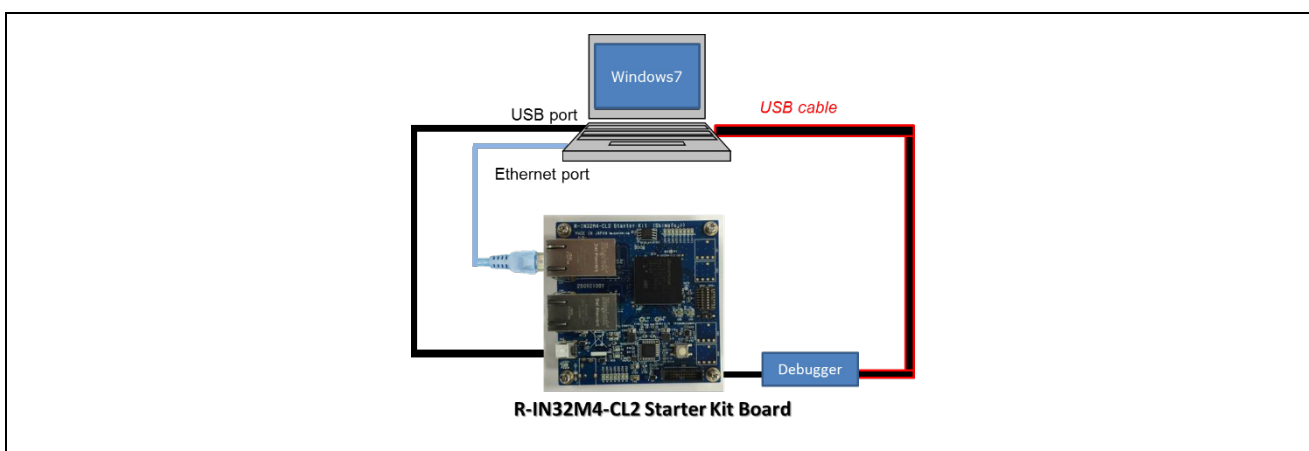

2.3 R-IN32M4-CL2 Evaluation Board Setup Procedure

Follow the steps below to setup the TSSR evaluation board. For more details, refer to the user manual published by TSSR on their web: <http://www.tessera.co.jp/eng/products/r-in32m4-cl2-e.html>

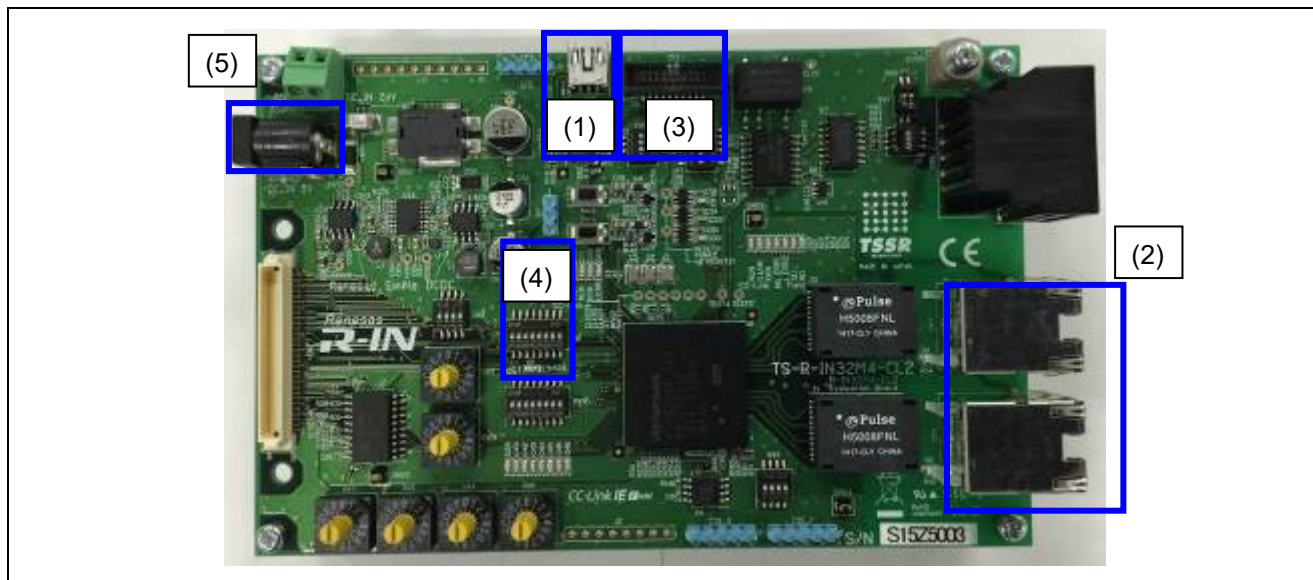

- (1) Use the mini-USB cable to connect the mini-USB port of the board to a USB port on the PC.
- (2) Use an Ethernet cable (category 5e or later recommended) to connect either Port 0 or Port 1 of the board to the PC's Ethernet port.
- (3) Connect the 20-pin half-pitch connector to the ICE.
Notice: No.1 terminal of the cable, which is Red one, must be on the left.
 Then connect the ICE to the PC by the USB cable that comes with ICE I-jet.
- (4) Set DIP-SW (SW1) switch to select the desired boot mode
- (5) Connect the 5V DC power adapter to the power jack on the evaluation board

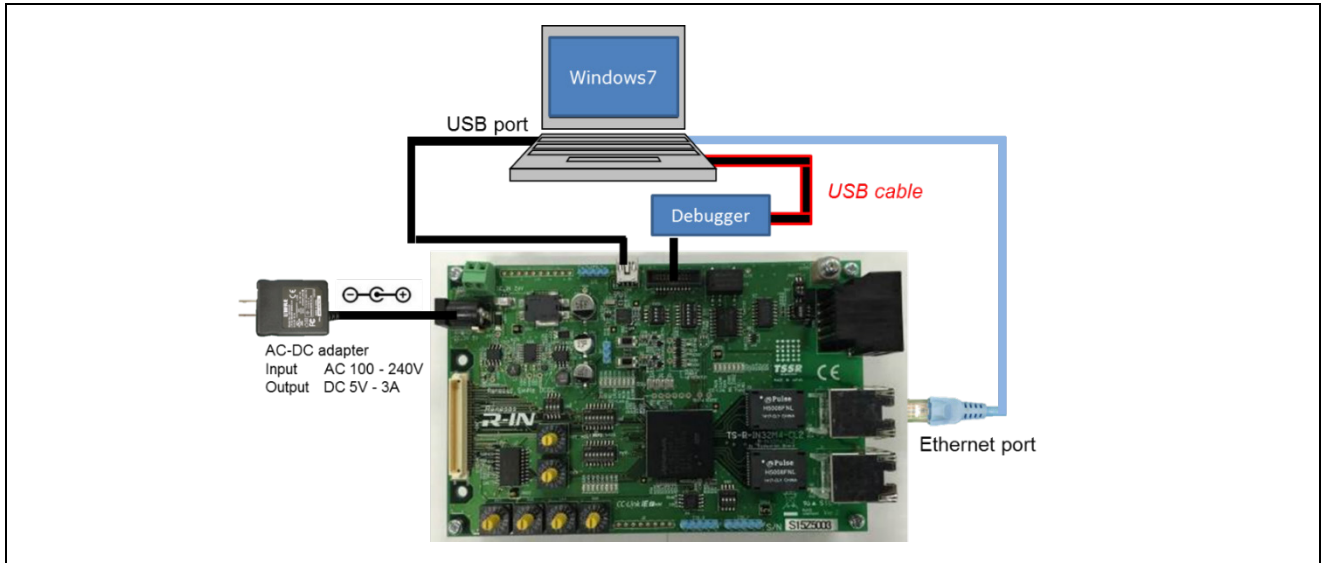

3. Install USB Serial Conversion Driver on PC

3.1 Download the Driver

A driver for FT232R USB UART may be required when connecting the PC to the R-IN32M4-CL2 boards with the included USB cable. For Windows 7, the driver is already included in the OS and, therefore, does not require manual installation.

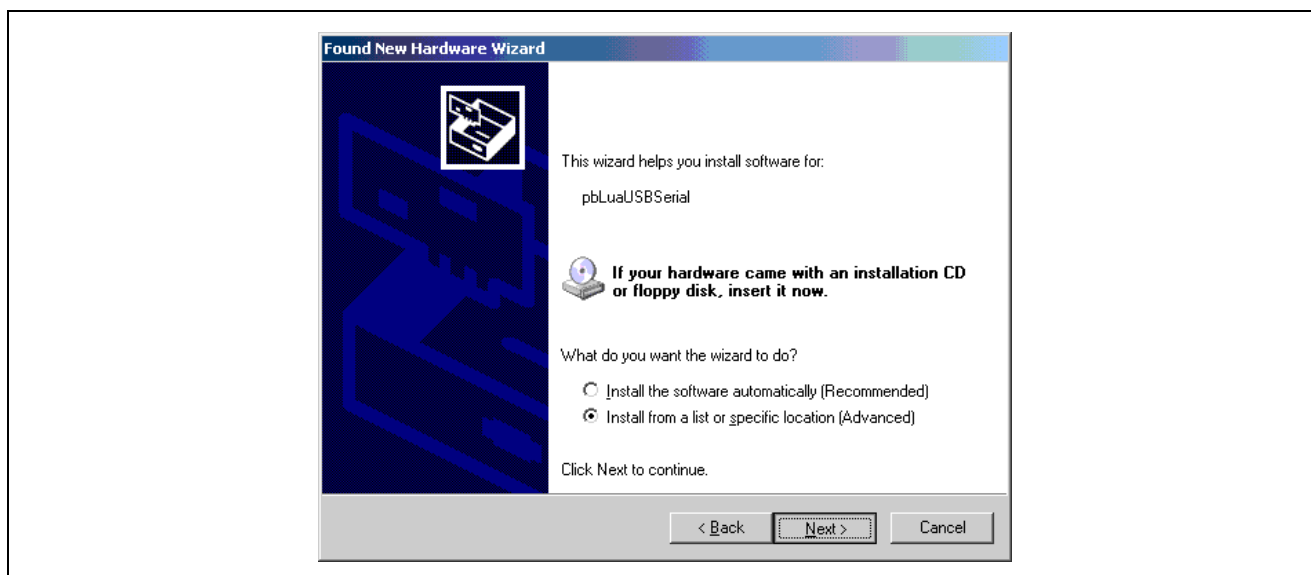

In case the driver is necessary, download it from the website <http://www.ftdichip.com/Drivers/VCP.htm>, and follow the steps below to install the driver.

3.2 Install the FT232R USB UART Driver

Follow the steps below to install the FT232 USB UART driver.

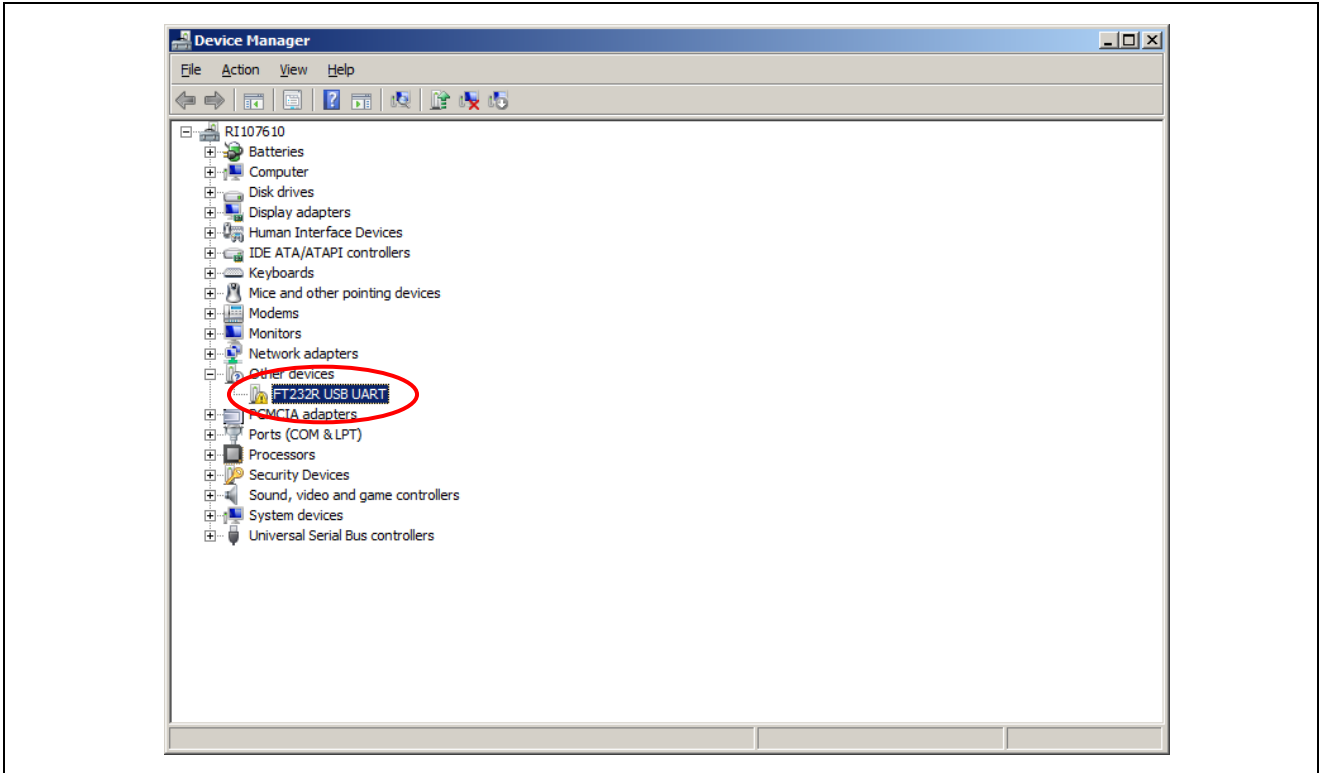

Unzip the downloaded driver files to a directory of your choice. Locate the FT232R USB UART device in the "Device Manager". Right click and select update driver. Then select [Install from a list or a specific location], and click [Next].

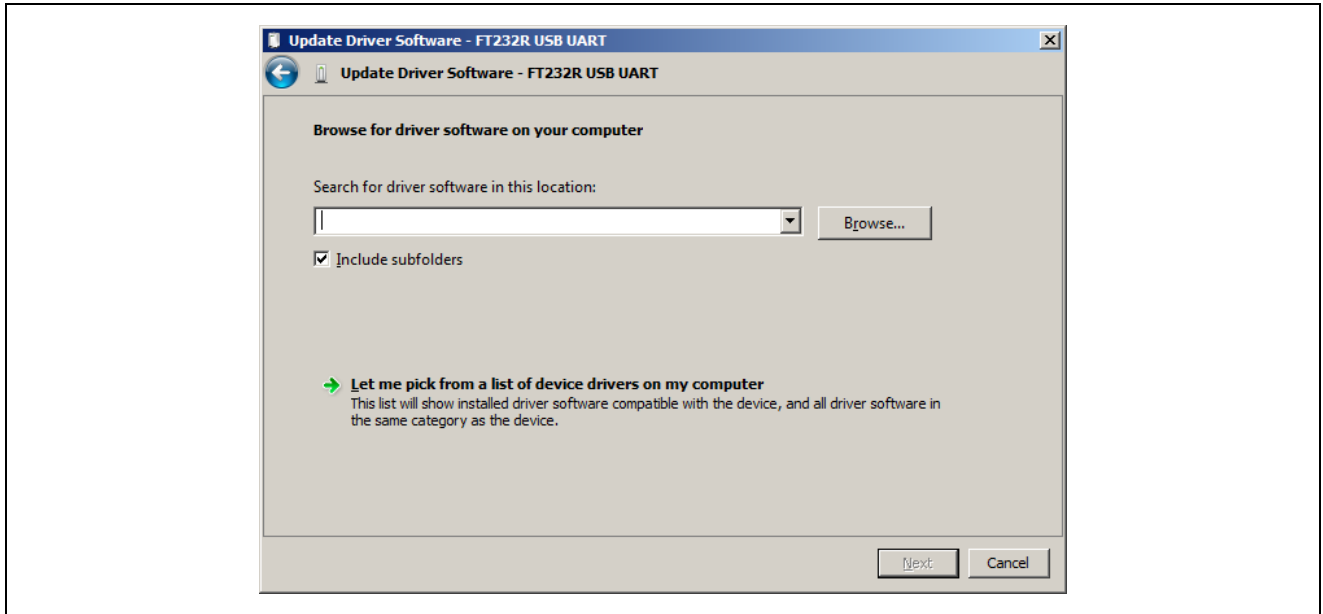

Select the unzip directory (CDM *.**.* WHQL Certified) and then click [OK].

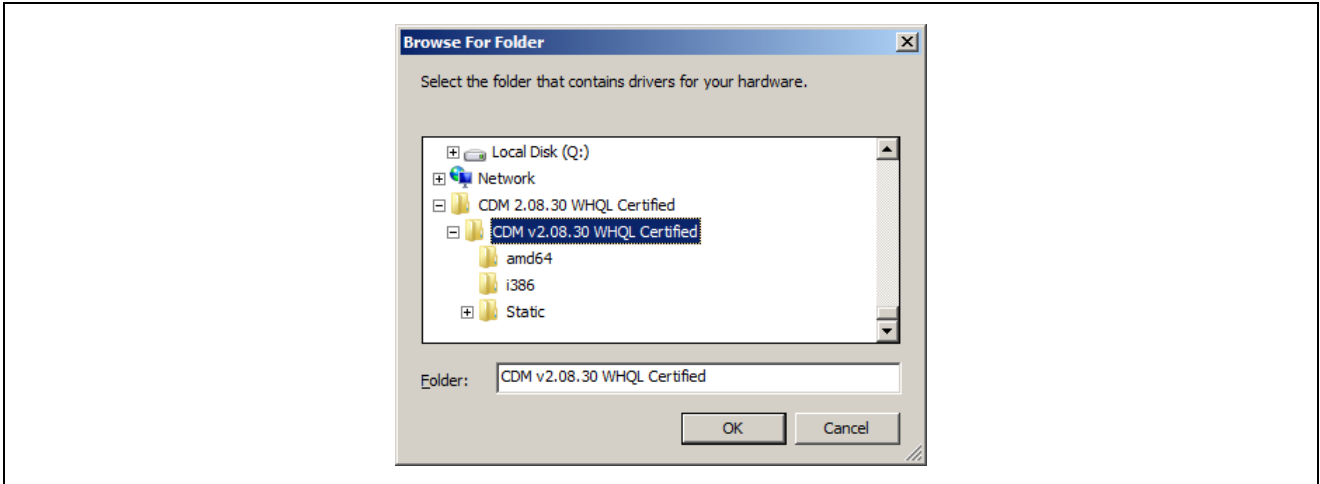

After the driver software update is completed, click [Close].

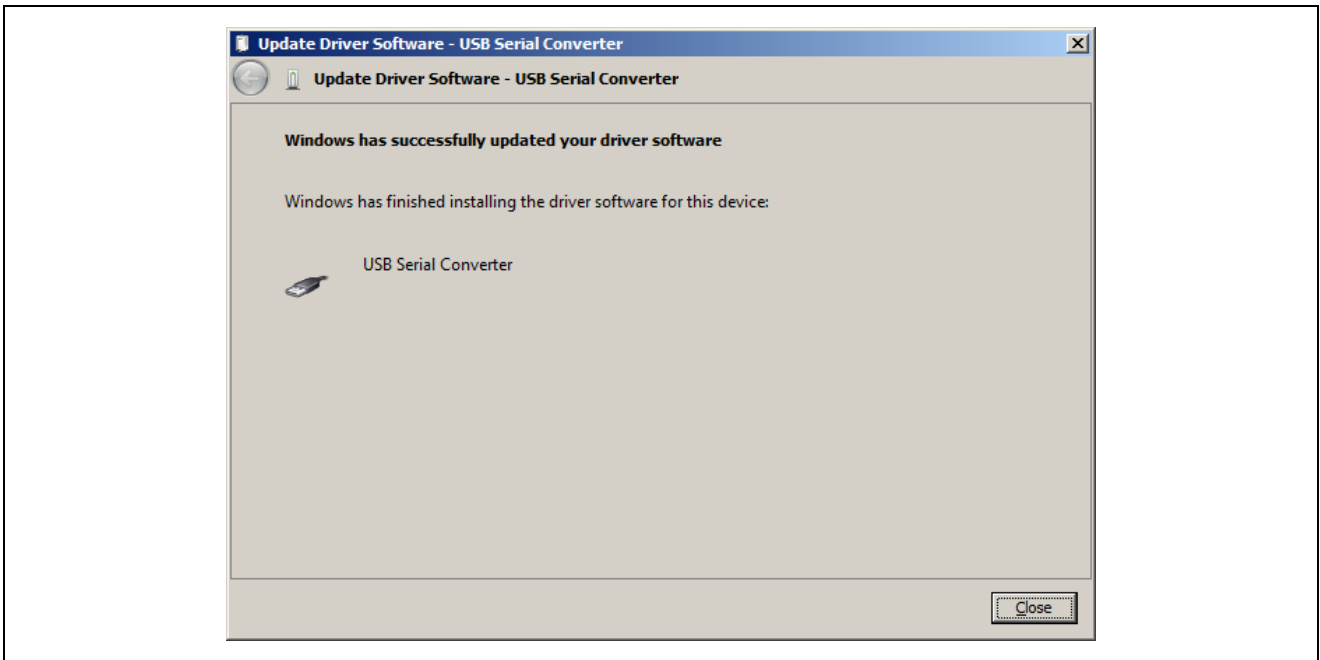

3.3 Install USB Serial Port Driver

Follow the steps below to install the USB Serial Port driver.

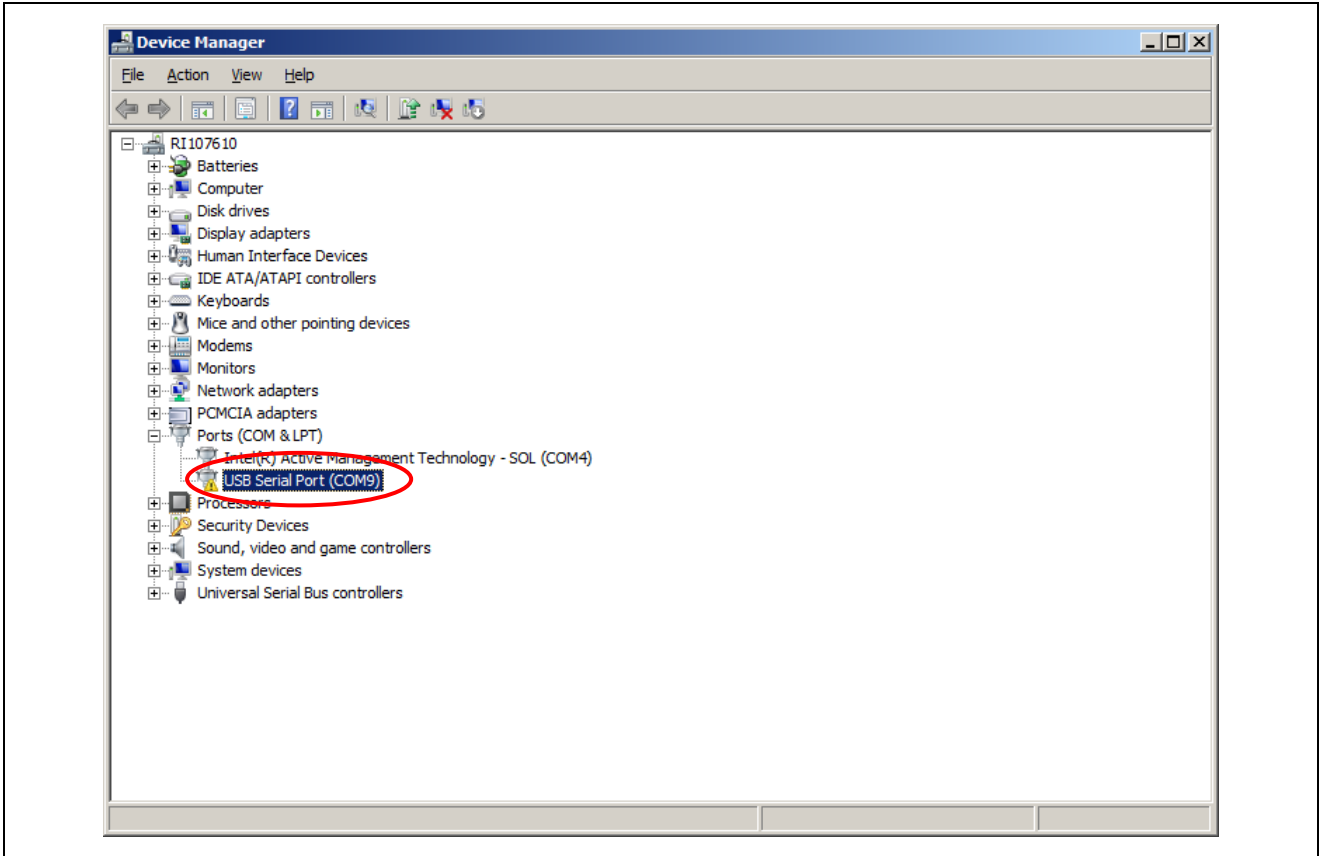

Locate USB Serial Port (COM*) in the device manager, right click and select driver update. Select [Install from a list or a specific location], click [Next] and then select [CDM 2.08.30 WHQL Certified] and click [OK].

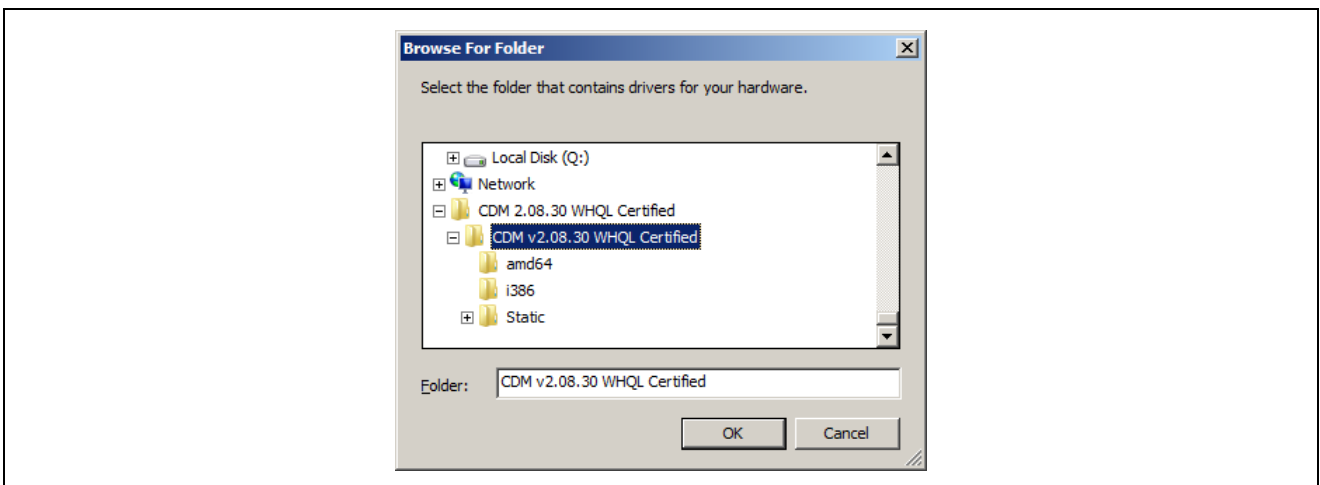

After the driver update is completed, click [Close].

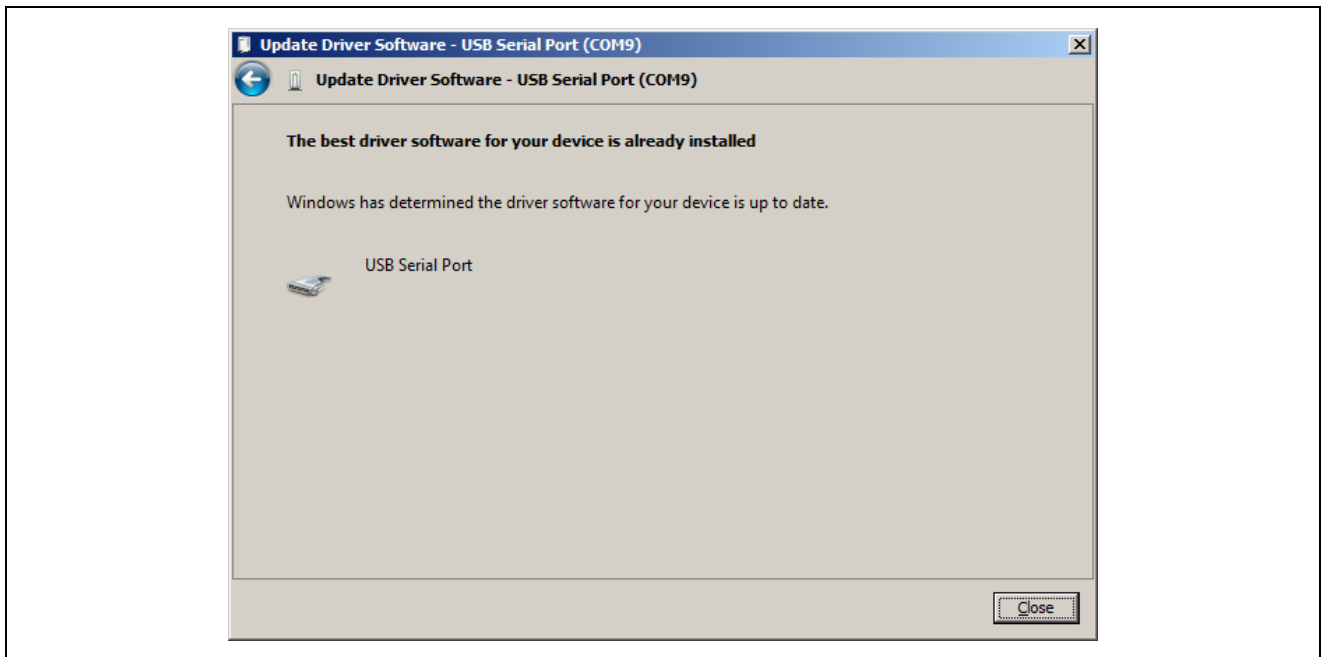

3.4 Configure UART Communication

Install serial terminal software such as Tera Term on the PC, start a new terminal connection and select the USB serial port where the R-IN32M4-CL2 board is connected.

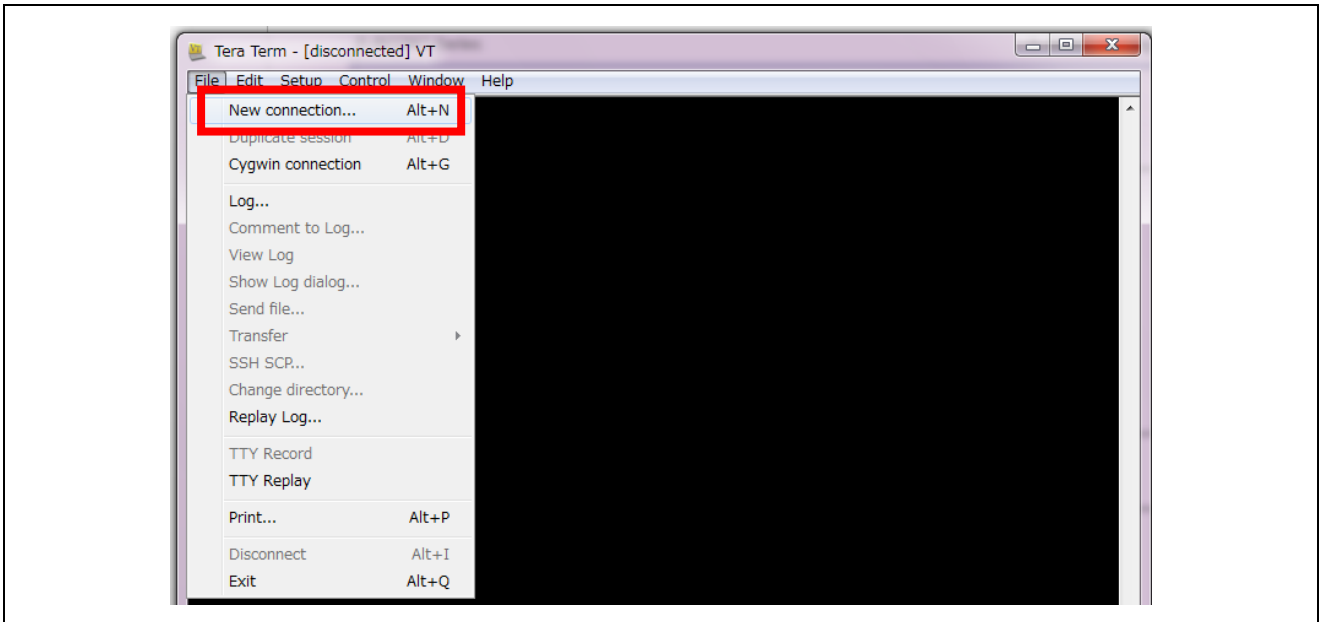

Port name varies from PC to PC, not necessarily COM 14 as is shown in the figure.

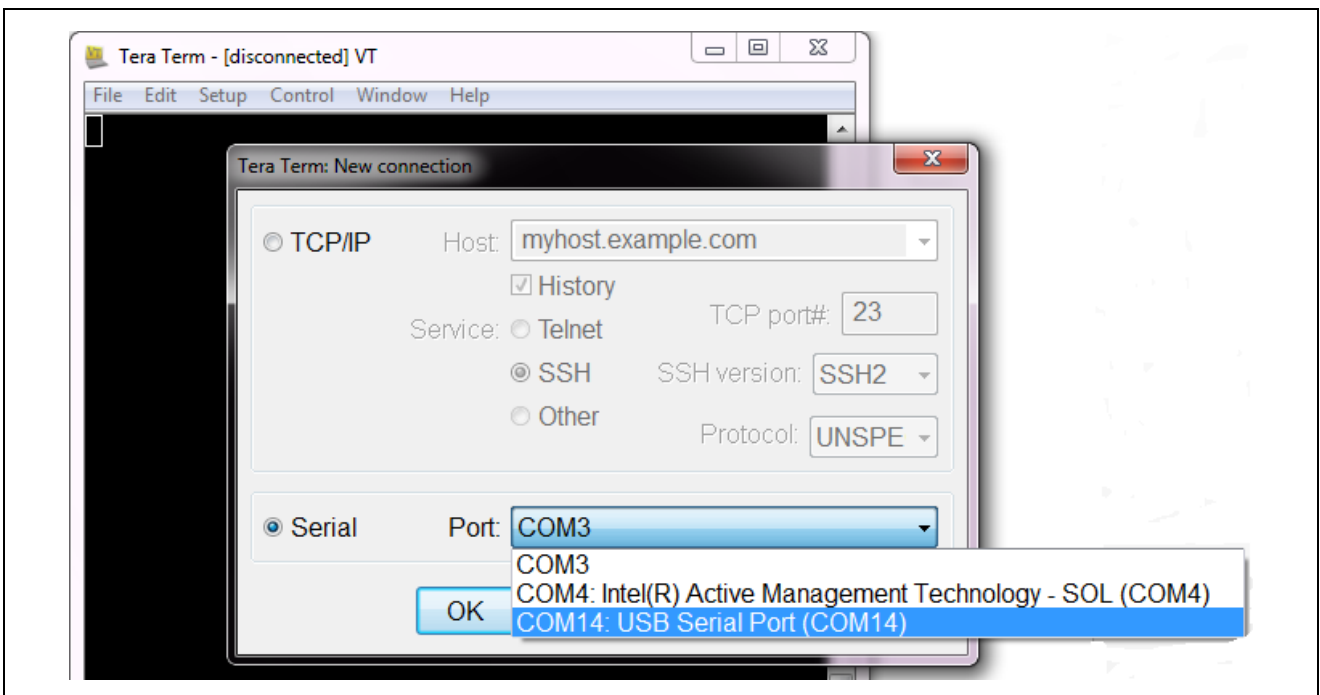

Select [Setup] > [Serial port...].

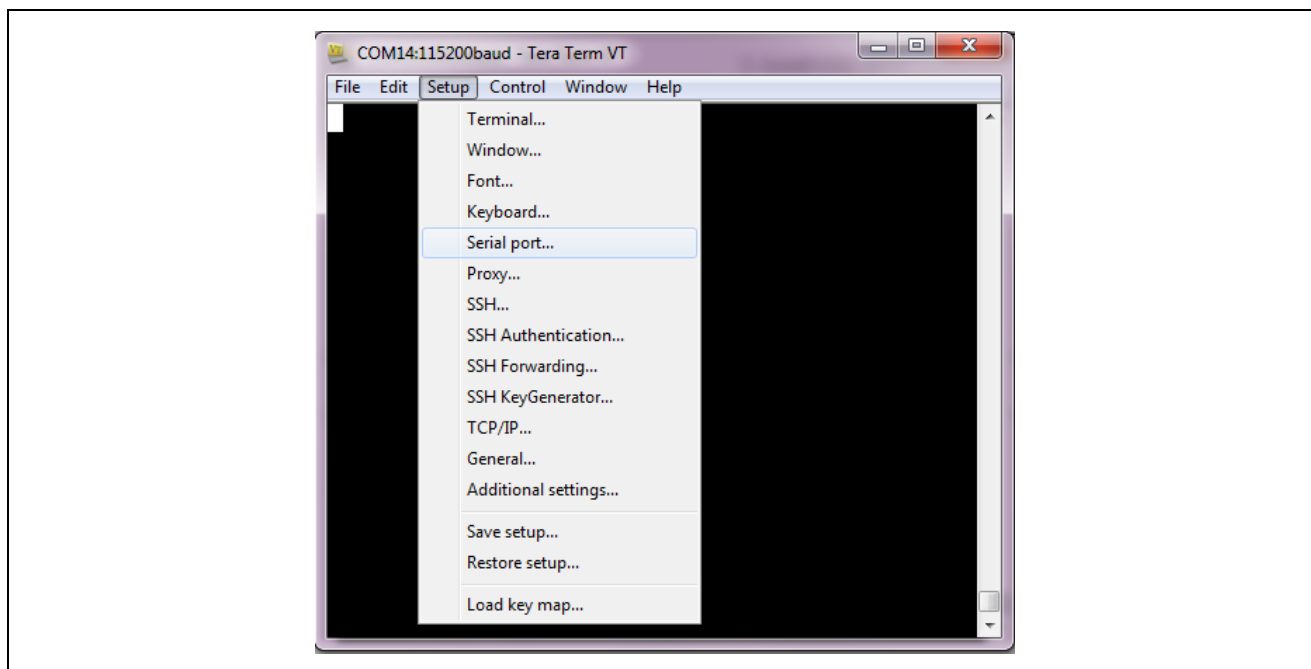

Configure the serial port settings to set the baud rate to “115200”.

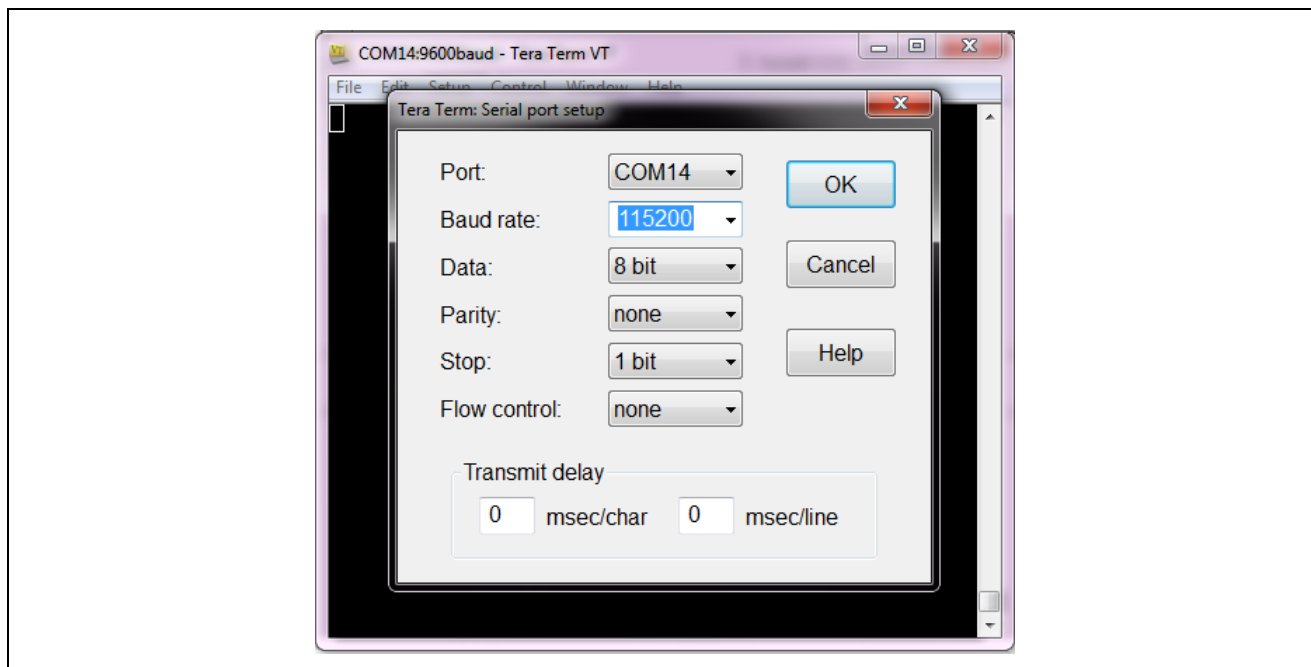

Select [Setup] > [Terminal...].

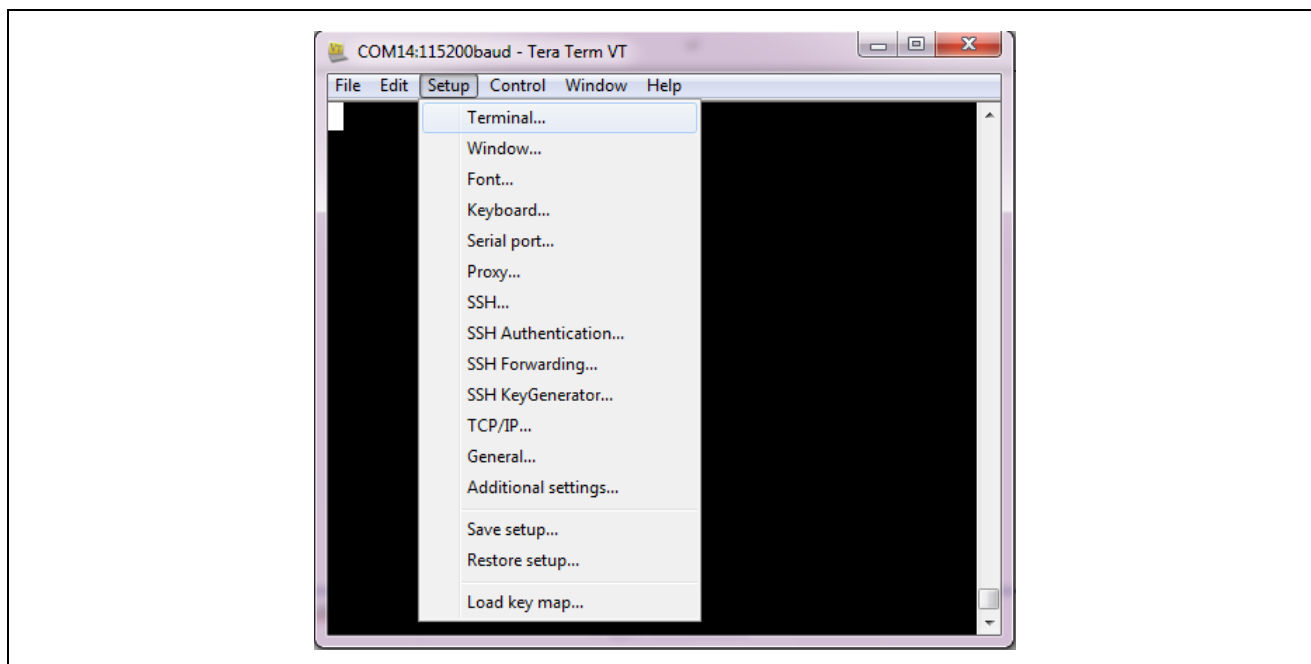

In terminal setup, select "CR+LF" as the Transmit New-Line symbol.

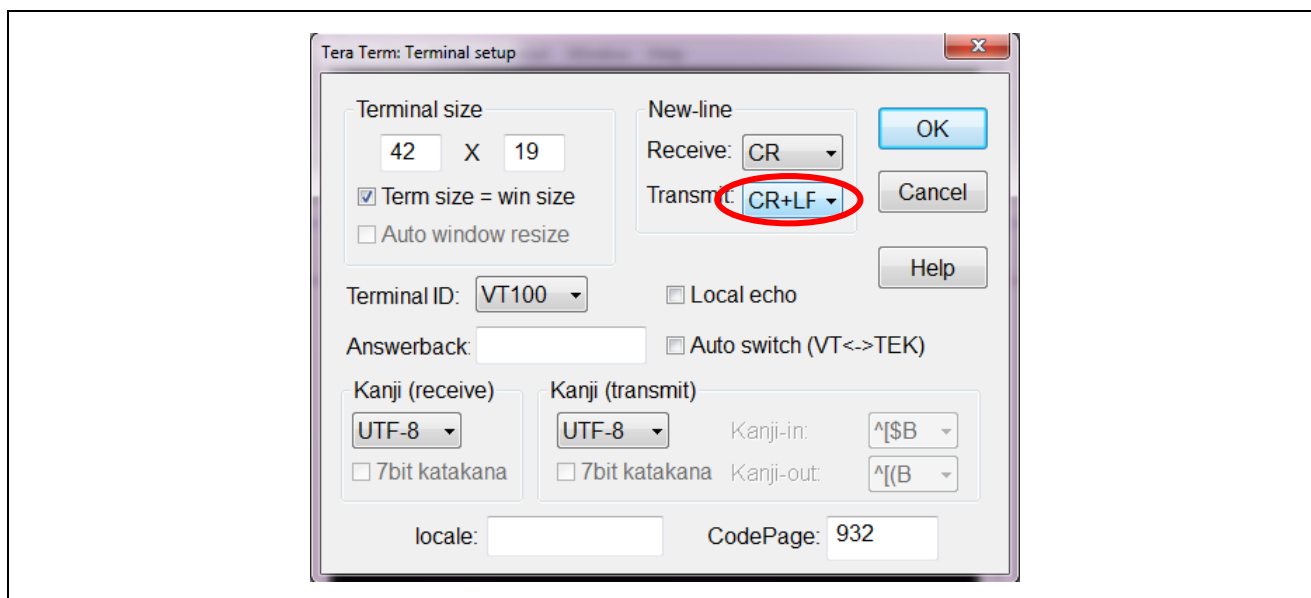

4. Use Sample Programs

4.1 Download the R-IN32M4 Sample Programs

The sample programs of R-IN32M4-CL2 are available for download from the web site below:

Sample software for IAR starter kit

<https://www.renesas.com/us/en/software/D6002928.html> <R>

Sample software for TSSR evaluation board

<https://www.renesas.com/us/en/software/D6002926.html> <R>

4.2 Run “cie_intelligent_device” Sample Program with EWARM Tool

The following steps describe how to run sample program of CC-Link IE Field intelligent device station from the previously installed Embedded Workbench IDE (EWARM).

To launch EWARM, double click the following executables depending on which board is used.

For IAR starter kit

```
¥r-in32m4_samplesoft¥Device¥Renesas¥RIN32M4¥Source¥Project¥IAR_StarterKit_CL2¥  
cie_intelligent_device¥IAR¥main_en.eww
```

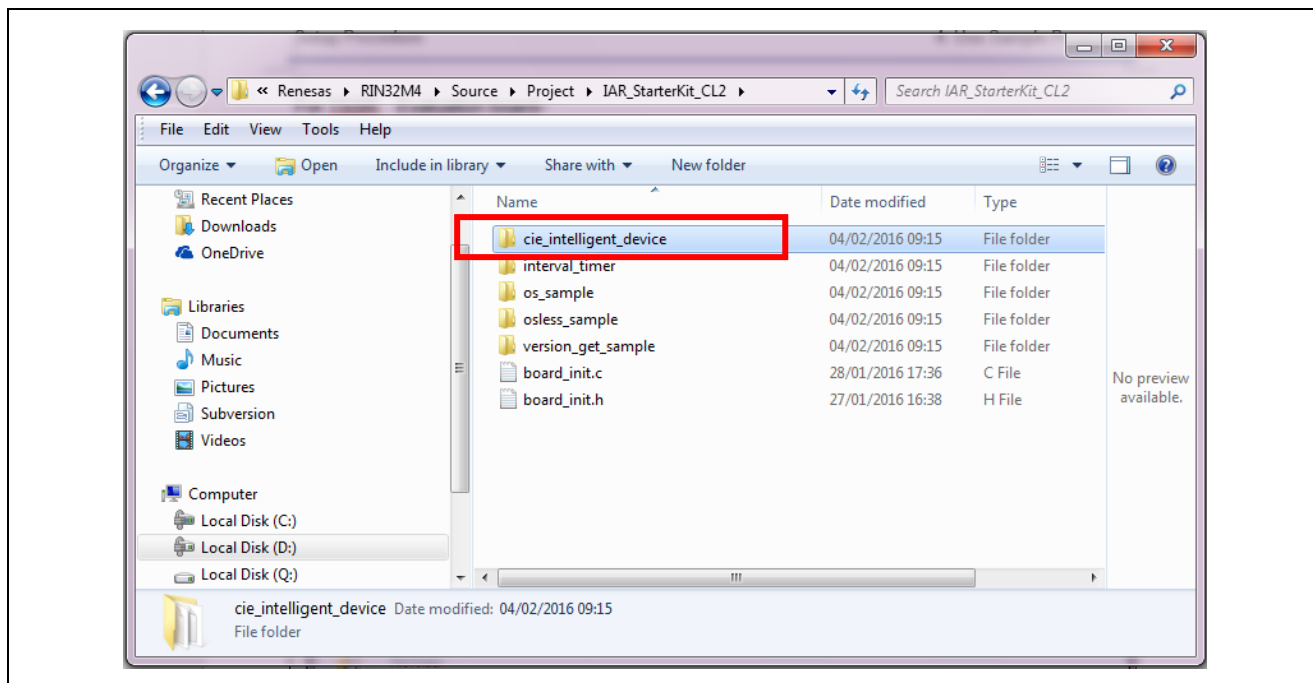

For TSSR evaluation board

¥r-in32m4_samplesoft¥Device¥Renesas¥RIN32M4¥Source¥Project¥TS-R-IN32M4-CL2¥
cie_intelligent_device¥IAR¥main_en.eww

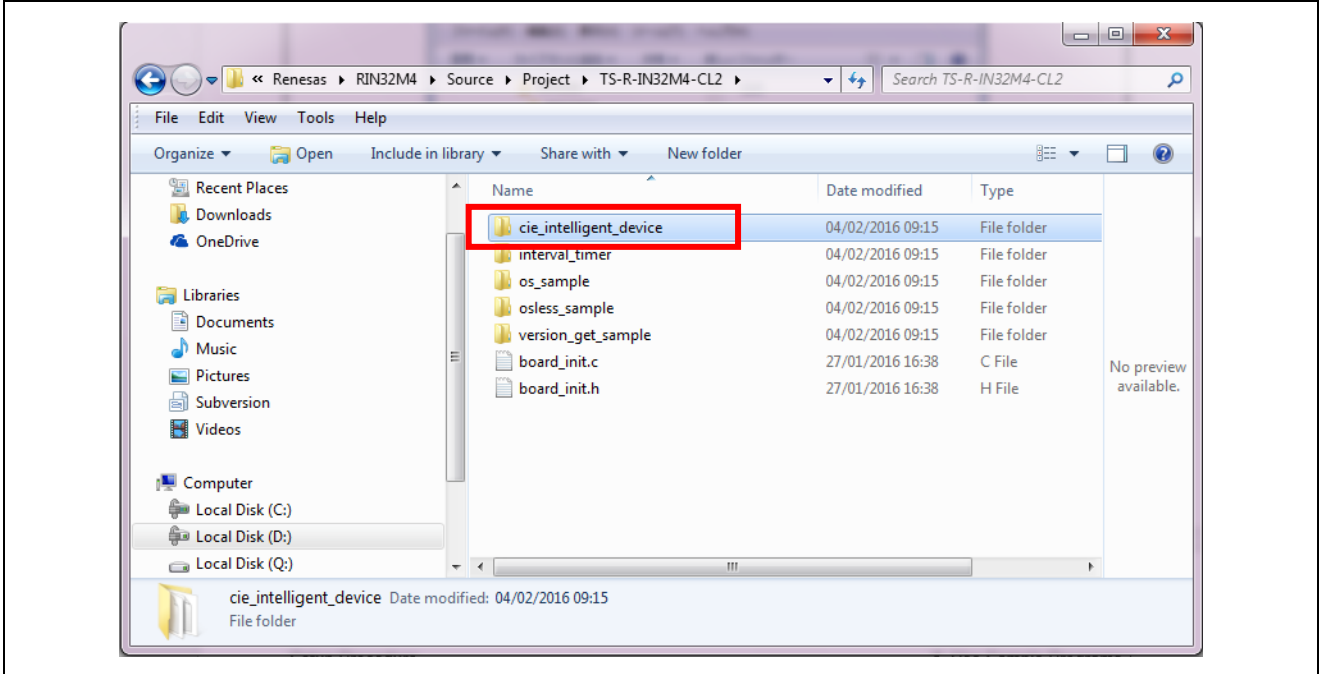

4.3 Select Build Setting

After EWARM is up, select build setting from the drop down list on the left panel (RAM Debug or Serial Flash Boot).

[To execute program in internal RAM (iRAM) of R-IN32M4-CL2 from ICE]

In the case of booting the R-IN32M4-CL2 from internal RAM (iRAM), select “RAM Debug”.

[To program external serial flash ROM of R-IN32M4-CL2 from ICE]

In the case of booting the R-IN32M4-CL2 from external serial flash ROM, select “Serial Flash Boot”.

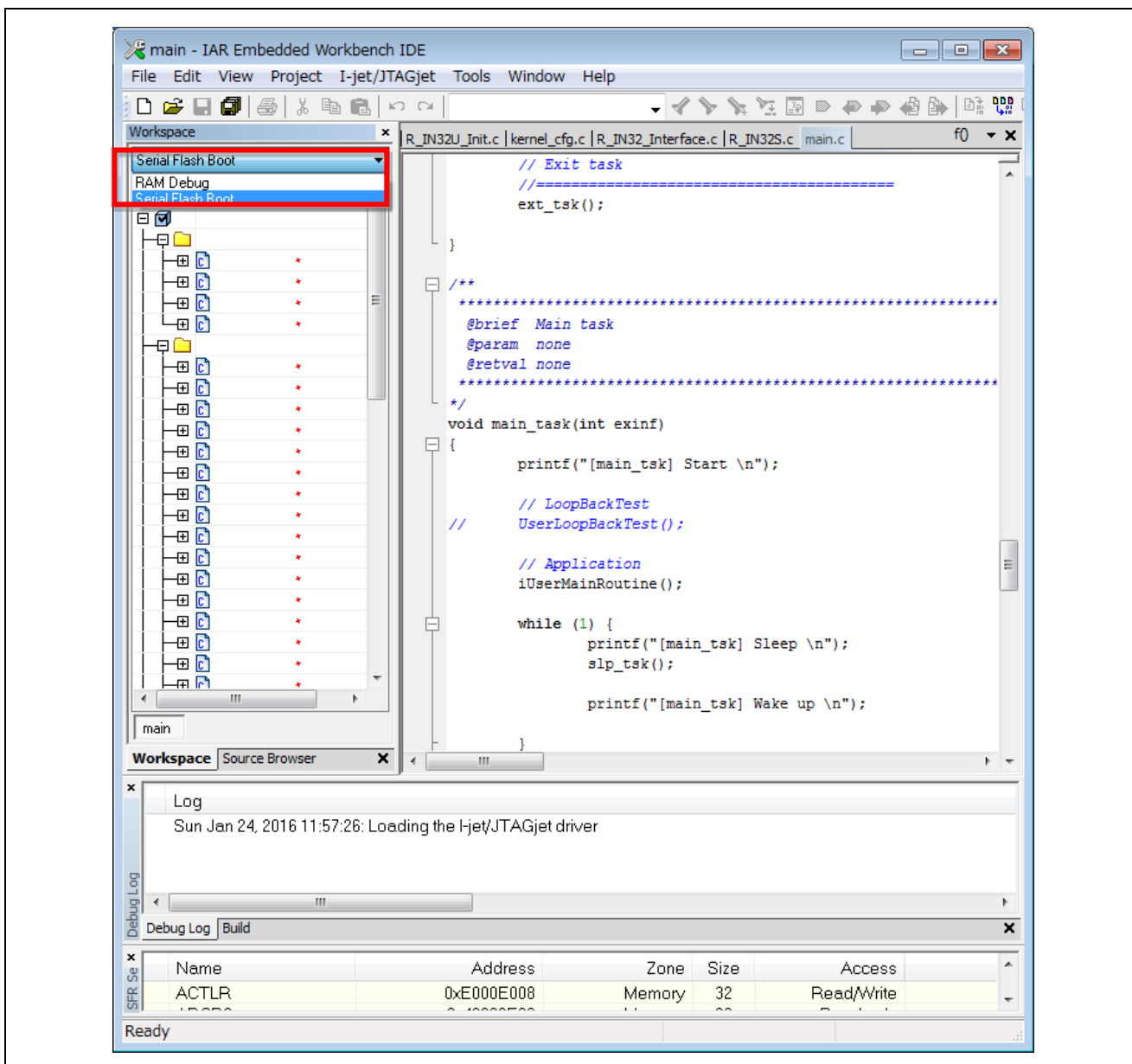

4.4 Build and Run “cie_intelligent_device” Program

Click [Project] > [Rebuild All].

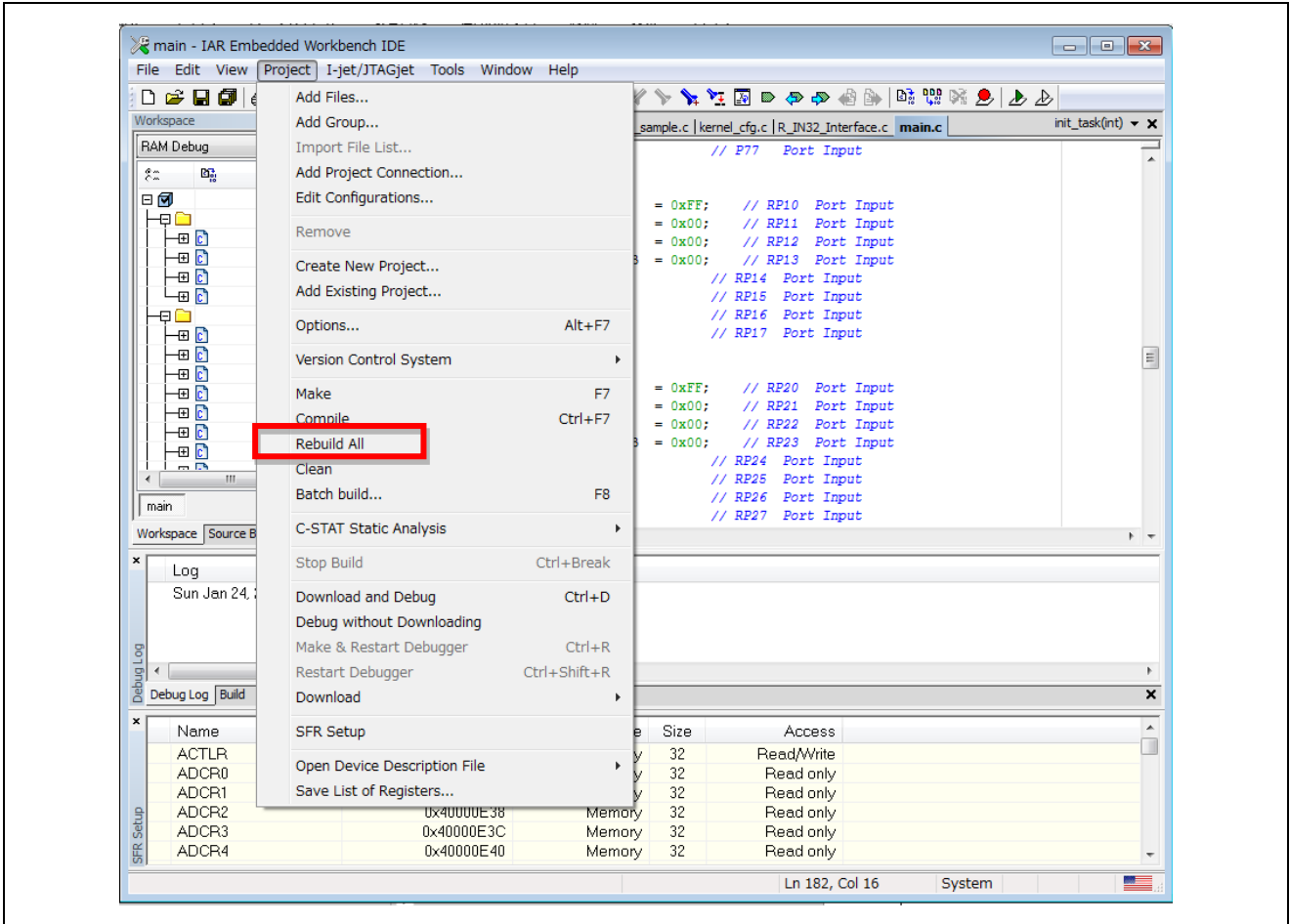

After build succeeded, click button (1) to download program to the target, then click button (2) to start running.

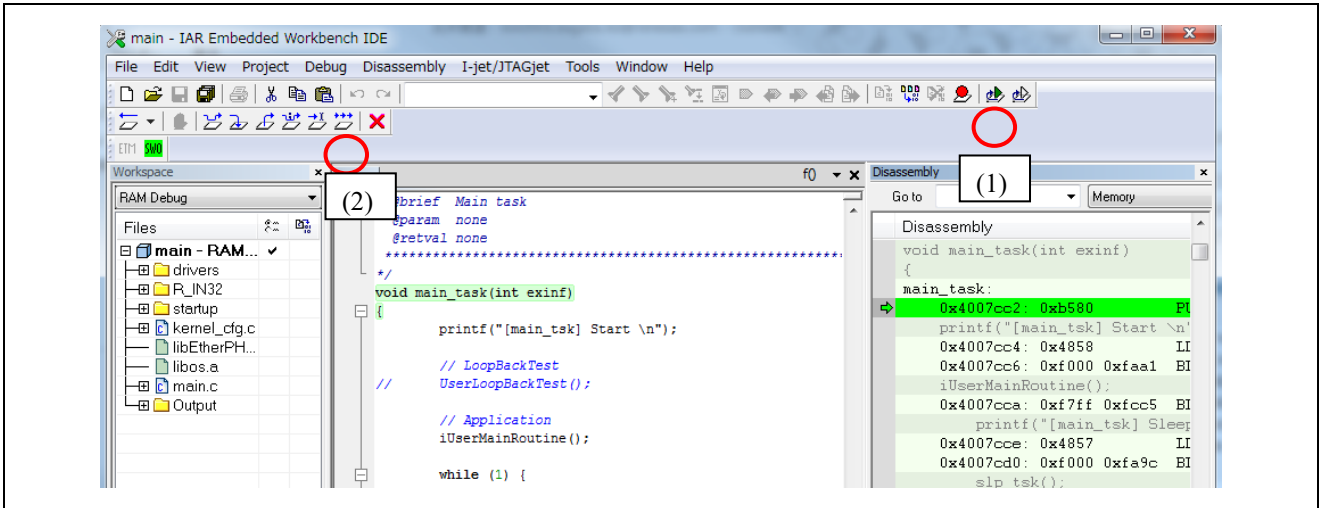

5. CC-Link IE Field Communication

In order to test and validate the CC-Link IE field communication, the CC-Link Partner Association provides a simple master tool. Follow the instructions below to test CC-Link IE field communication on the R-IN32M4-CL2 boards.

5.1 Get the Sample Stack for CC-Link IE Field

Refer to section 4.

5.2 Download CC-Link IE Field Utility

Download the CC-Link IE Field Utility tool and manual from the CC-Link Partner Association website. There is no need to be a registered member of the association; the tool is downloadable after filling in the names of the user and company.

<http://cc-link.org/eng/downloads/index.html>

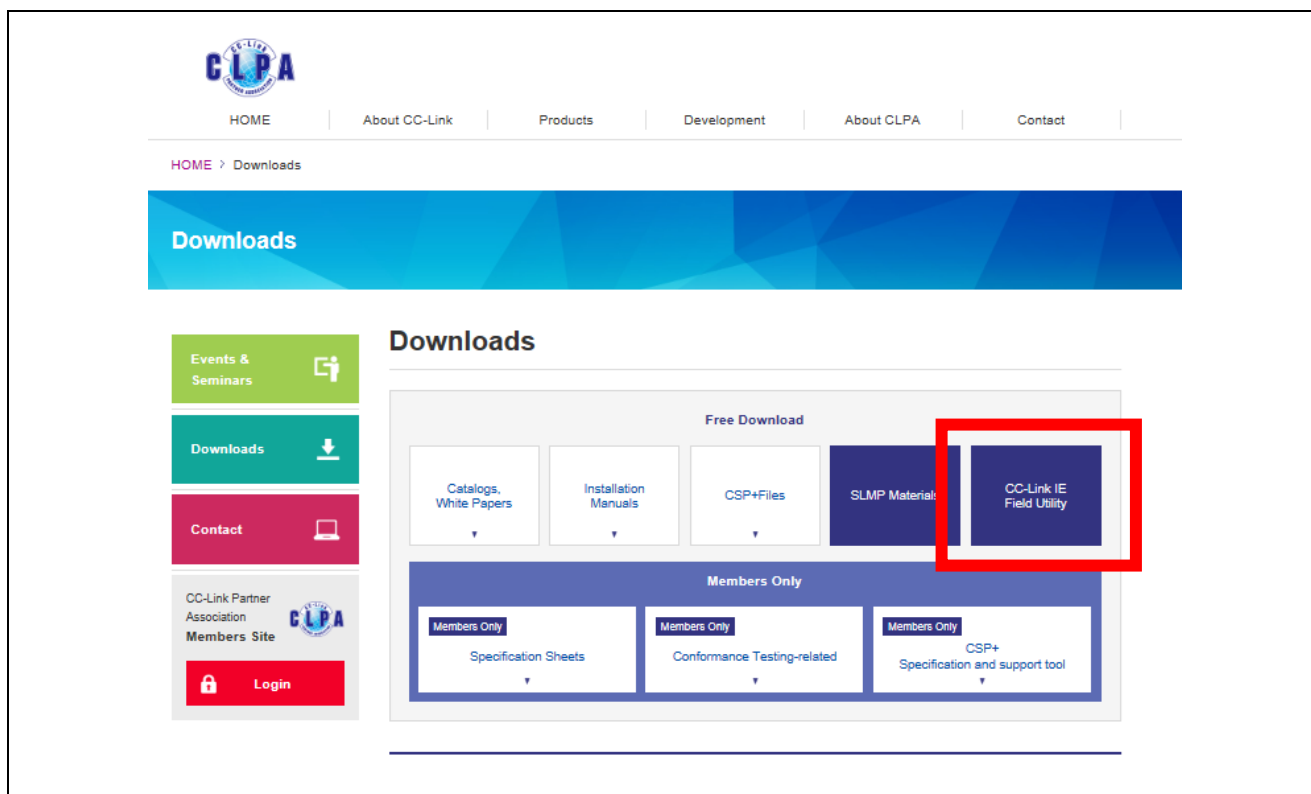

5.3 Install WinPcap

CC-Link IE Field utility is using WinPcap, therefore it is necessary to install on your PC. Download and install WinPcap from the following web site: <http://www.winpcap.org/install/default.htm>

5.4 Confirm CC-Link IE Field Communication

5.4.1 Link CC-Link IE Field

Double click the executable file (cciutl.exe) of CC-Link IE Field utility to run the tool.

- (1) Select Ethernet port for 1000 Base-T as the I/F.
- (2) Set station number, RX/RX, and RWw/RWr.
- (3) Press “Start Cyclic Communication” button. The box in “Link” group will turn into green color if the link succeeds.

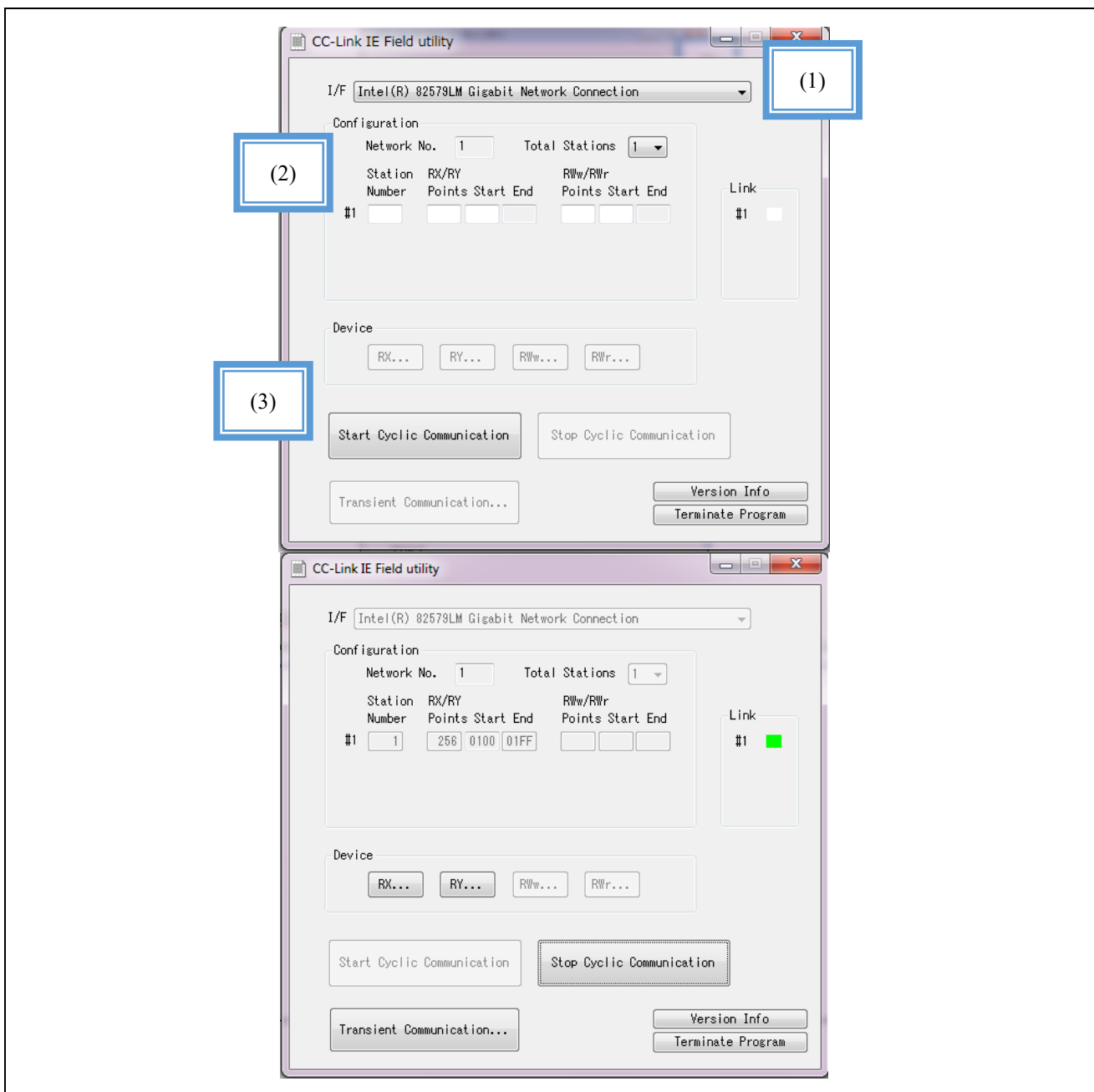

5.4.2 Cyclic Communication – Data for Transmission

Data for transmission from the R-IN32M4-CL2 to the PC can be confirmed by pushing “RX...” button and setting the start address as is shown in the figure below. The transmission data sent by the sample program has the data bit shifting within range between bit-0 and bit-7.

The transmission data can be altered by modifying function UserSendCyclic() in source file R_IN32M4_sample.c.

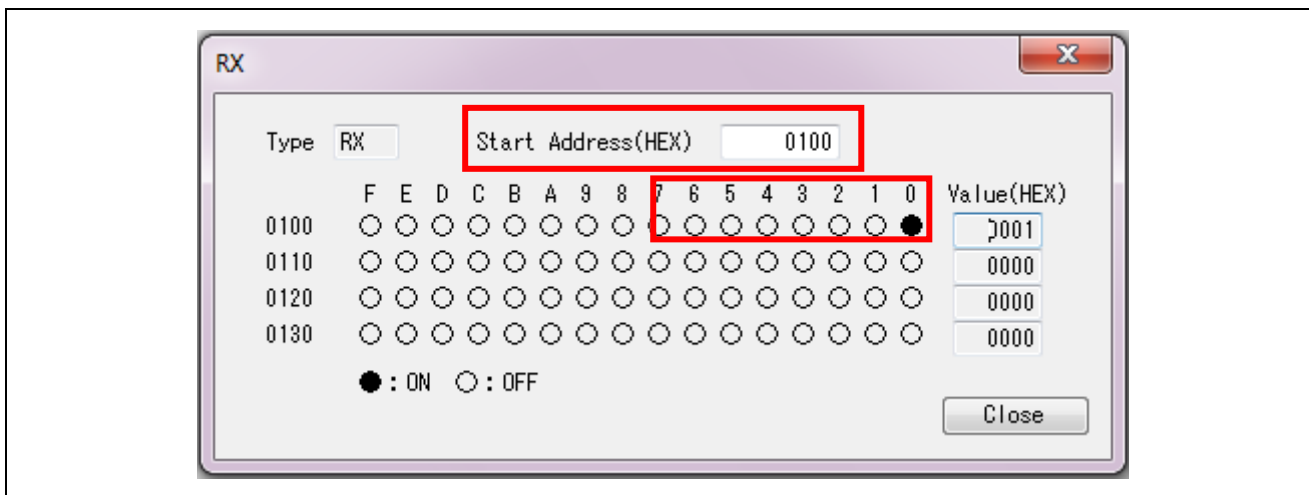

5.4.3 Cyclic Communication – Received Data

Data for transmission from R-IN to the PC can be confirmed by pushing “RY...” button and setting the start address as is shown in the figure below. The light of 8-bit LED array on the board shows received data. By double clicking the cycle symbols or entering values directly in the text fields on the utility tool, the status of LED will change.

The way to use the received data can be altered by modifying UserReceiveCyclic() in source file R_IN32M4_sample.c.

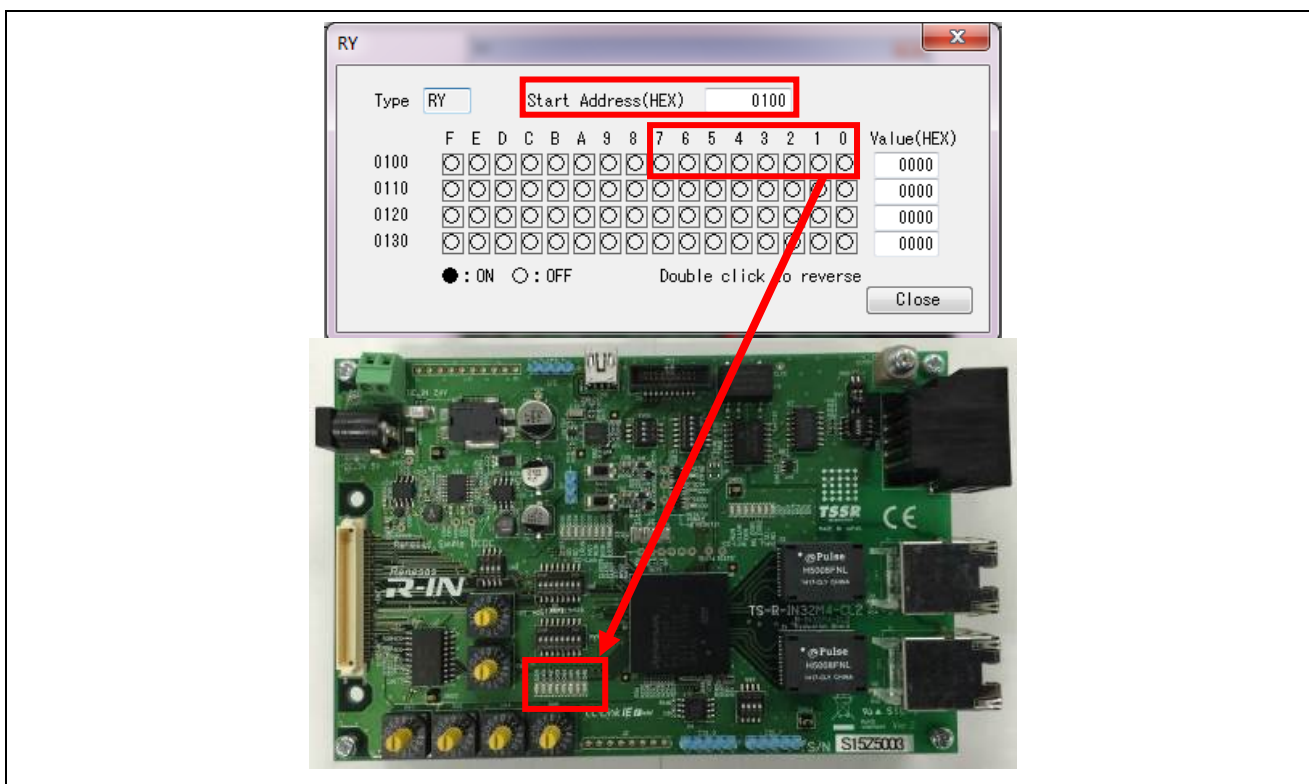

5.4.4 Transient Communication

Transient communication can be performed by pushing the transient communication button in the utility tool main window. It supports [Deliver Node Info], [Get Statistics] and [Acquire Detailed Node Info] commands. Commands can be sent by selecting the command from the drop down list and pressing “Transmit” button, and the reply from the R-IN boards is displayed in the “Response” field.

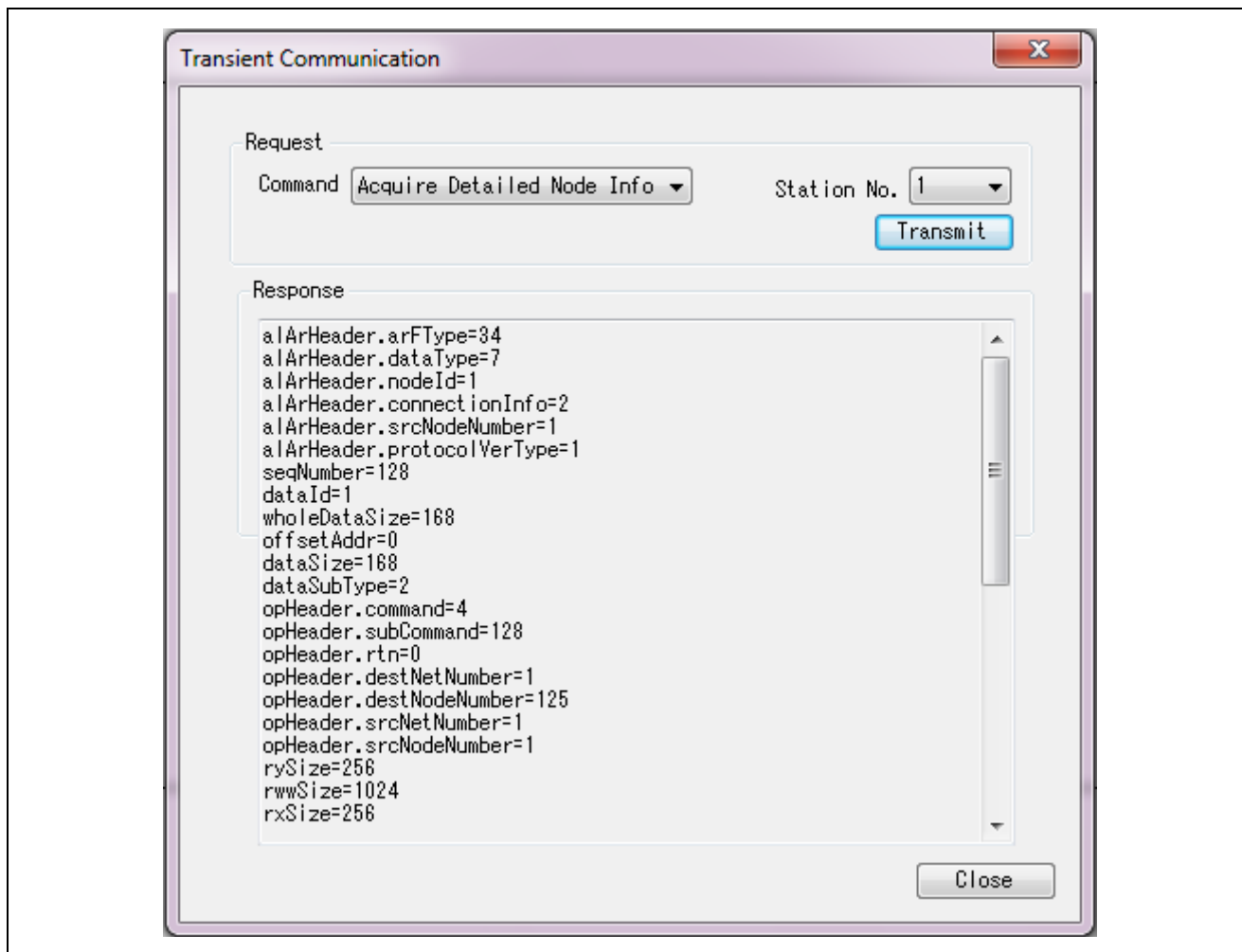

REVISION HISTORY

R-IN32M4-CL2 Development Tools Startup Manual

Rev.	Date	Description	
		Page	Summary
1.00	Jan 29, 2016	-	1st version issued
2.00	Mar 16, 2016	31-38	6. KEIL MDK-ARM Setup , added
2.01	Jun 19, 2018	1, 2	1.1 Download IAR Tool Installer , screenshot added and description changed (Complement)
		7	1.2 Install and Setup Evaluation License , URL for reference changed (Error correction)
		8	2. Setup and Connect R-IN32M4-CL2 Board URL for reference changed (Error correction)
		22	4.1 Download the R-IN32M4 Sample Programs , URL for reference changed (Error correction)
2.02	Mar 29, 2019	32-39	6. KEIL MDK-ARM Setup , deleted

General Precautions in the Handling of Microprocessing Unit and Microcontroller Unit Products

The following usage notes are applicable to all Microprocessing unit and Microcontroller unit products from Renesas. For detailed usage notes on the products covered by this document, refer to the relevant sections of the document as well as any technical updates that have been issued for the products.

1. Precaution against Electrostatic Discharge (ESD)

A strong electrical field, when exposed to a CMOS device, can cause destruction of the gate oxide and ultimately degrade the device operation. Steps must be taken to stop the generation of static electricity as much as possible, and quickly dissipate it when it occurs. Environmental control must be adequate. When it is dry, a humidifier should be used. This is recommended to avoid using insulators that can easily build up static electricity. Semiconductor devices must be stored and transported in an anti-static container, static shielding bag or conductive material. All test and measurement tools including work benches and floors must be grounded. The operator must also be grounded using a wrist strap. Semiconductor devices must not be touched with bare hands. Similar precautions must be taken for printed circuit boards with mounted semiconductor devices.

2. Processing at power-on

The state of the product is undefined at the time when power is supplied. The states of internal circuits in the LSI are indeterminate and the states of register settings and pins are undefined at the time when power is supplied. In a finished product where the reset signal is applied to the external reset pin, the states of pins are not guaranteed from the time when power is supplied until the reset process is completed. In a similar way, the states of pins in a product that is reset by an on-chip power-on reset function are not guaranteed from the time when power is supplied until the power reaches the level at which resetting is specified.

3. Input of signal during power-off state

Do not input signals or an I/O pull-up power supply while the device is powered off. The current injection that results from input of such a signal or I/O pull-up power supply may cause malfunction and the abnormal current that passes in the device at this time may cause degradation of internal elements. Follow the guideline for input signal during power-off state as described in your product documentation.

4. Handling of unused pins

Handle unused pins in accordance with the directions given under handling of unused pins in the manual. The input pins of CMOS products are generally in the high-impedance state. In operation with an unused pin in the open-circuit state, extra electromagnetic noise is induced in the vicinity of the LSI, an associated shoot-through current flows internally, and malfunctions occur due to the false recognition of the pin state as an input signal become possible.

5. Clock signals

After applying a reset, only release the reset line after the operating clock signal becomes stable. When switching the clock signal during program execution, wait until the target clock signal is stabilized. When the clock signal is generated with an external resonator or from an external oscillator during a reset, ensure that the reset line is only released after full stabilization of the clock signal. Additionally, when switching to a clock signal produced with an external resonator or by an external oscillator while program execution is in progress, wait until the target clock signal is stable.

6. Voltage application waveform at input pin

Waveform distortion due to input noise or a reflected wave may cause malfunction. If the input of the CMOS device stays in the area between V_{IL} (Max.) and V_{IH} (Min.) due to noise, for example, the device may malfunction. Take care to prevent chattering noise from entering the device when the input level is fixed, and also in the transition period when the input level passes through the area between V_{IL} (Max.) and V_{IH} (Min.).

7. Prohibition of access to reserved addresses

Access to reserved addresses is prohibited. The reserved addresses are provided for possible future expansion of functions. Do not access these addresses as the correct operation of the LSI is not guaranteed.

8. Differences between products

Before changing from one product to another, for example to a product with a different part number, confirm that the change will not lead to problems. The characteristics of a microprocessing unit or microcontroller unit products in the same group but having a different part number might differ in terms of internal memory capacity, layout pattern, and other factors, which can affect the ranges of electrical characteristics, such as characteristic values, operating margins, immunity to noise, and amount of radiated noise. When changing to a product with a different part number, implement a system-evaluation test for the given product.

- Arm® and Cortex® are registered trademarks of Arm Limited (or its subsidiaries) in the EU and/or elsewhere. All rights reserved.
- Ethernet is a registered trademark of Fuji Xerox Co., Ltd.
- IEEE is a registered trademark of the Institute of Electrical and Electronics Engineers Inc.
- TRON is an acronym for "The Real-time Operation system Nucleus".
- ITRON is an acronym for "Industrial TRON".
- μ ITRON is an acronym for "Micro Industrial TRON".
- TRON, ITRON, and μ ITRON do not refer to any specific product or products.
- Additionally all product names and service names in this document are a trademark or a registered trademark which belongs to the respective owners.

Notice

1. Descriptions of circuits, software and other related information in this document are provided only to illustrate the operation of semiconductor products and application examples. You are fully responsible for the incorporation or any other use of the circuits, software, and information in the design of your product or system. Renesas Electronics disclaims any and all liability for any losses and damages incurred by you or third parties arising from the use of these circuits, software, or information.
 2. Renesas Electronics hereby expressly disclaims any warranties against and liability for infringement or any other claims involving patents, copyrights, or other intellectual property rights of third parties, by or arising from the use of Renesas Electronics products or technical information described in this document, including but not limited to, the product data, drawings, charts, programs, algorithms, and application examples.
 3. No license, express, implied or otherwise, is granted hereby under any patents, copyrights or other intellectual property rights of Renesas Electronics or others.
 4. You shall not alter, modify, copy, or reverse engineer any Renesas Electronics product, whether in whole or in part. Renesas Electronics disclaims any and all liability for any losses or damages incurred by you or third parties arising from such alteration, modification, copying or reverse engineering.
 5. Renesas Electronics products are classified according to the following two quality grades: "Standard" and "High Quality". The intended applications for each Renesas Electronics product depends on the product's quality grade, as indicated below.
 - "Standard": Computers; office equipment; communications equipment; test and measurement equipment; audio and visual equipment; home electronic appliances; machine tools; personal electronic equipment; industrial robots; etc.
 - "High Quality": Transportation equipment (automobiles, trains, ships, etc.); traffic control (traffic lights); large-scale communication equipment; key financial terminal systems; safety control equipment; etc.
- Unless expressly designated as a high reliability product or a product for harsh environments in a Renesas Electronics data sheet or other Renesas Electronics document, Renesas Electronics products are not intended or authorized for use in products or systems that may pose a direct threat to human life or bodily injury (artificial life support devices or systems; surgical implantations; etc.), or may cause serious property damage (space system; undersea repeaters; nuclear power control systems; aircraft control systems; key plant systems; military equipment; etc.). Renesas Electronics disclaims any and all liability for any damages or losses incurred by you or any third parties arising from the use of any Renesas Electronics product that is inconsistent with any Renesas Electronics data sheet, user's manual or other Renesas Electronics document.
6. When using Renesas Electronics products, refer to the latest product information (data sheets, user's manuals, application notes, "General Notes for Handling and Using Semiconductor Devices" in the reliability handbook, etc.), and ensure that usage conditions are within the ranges specified by Renesas Electronics with respect to maximum ratings, operating power supply voltage range, heat dissipation characteristics, installation, etc. Renesas Electronics disclaims any and all liability for any malfunctions, failure or accident arising out of the use of Renesas Electronics products outside of such specified ranges.
 7. Although Renesas Electronics endeavors to improve the quality and reliability of Renesas Electronics products, semiconductor products have specific characteristics, such as the occurrence of failure at a certain rate and malfunctions under certain use conditions. Unless designated as a high reliability product or a product for harsh environments in a Renesas Electronics data sheet or other Renesas Electronics document, Renesas Electronics products are not subject to radiation resistance design. You are responsible for implementing safety measures to guard against the possibility of bodily injury, injury or damage caused by fire, and/or danger to the public in the event of a failure or malfunction of Renesas Electronics products, such as safety design for hardware and software, including but not limited to redundancy, fire control and malfunction prevention, appropriate treatment for aging degradation or any other appropriate measures. Because the evaluation of microcomputer software alone is very difficult and impractical, you are responsible for evaluating the safety of the final products or systems manufactured by you.
 8. Please contact a Renesas Electronics sales office for details as to environmental matters such as the environmental compatibility of each Renesas Electronics product. You are responsible for carefully and sufficiently investigating applicable laws and regulations that regulate the inclusion or use of controlled substances, including without limitation, the EU RoHS Directive, and using Renesas Electronics products in compliance with all these applicable laws and regulations. Renesas Electronics disclaims any and all liability for damages or losses occurring as a result of your noncompliance with applicable laws and regulations.
 9. Renesas Electronics products and technologies shall not be used for or incorporated into any products or systems whose manufacture, use, or sale is prohibited under any applicable domestic or foreign laws or regulations. You shall comply with any applicable export control laws and regulations promulgated and administered by the governments of any countries asserting jurisdiction over the parties or transactions.
 10. It is the responsibility of the buyer or distributor of Renesas Electronics products, or any other party who distributes, disposes of, or otherwise sells or transfers the product to a third party, to notify such third party in advance of the contents and conditions set forth in this document.
 11. This document shall not be reprinted, reproduced or duplicated in any form, in whole or in part, without prior written consent of Renesas Electronics.
 12. Please contact a Renesas Electronics sales office if you have any questions regarding the information contained in this document or Renesas Electronics products.

(Note1) "Renesas Electronics" as used in this document means Renesas Electronics Corporation and also includes its directly or indirectly controlled subsidiaries.

(Note2) "Renesas Electronics product(s)" means any product developed or manufactured by or for Renesas Electronics.

(Rev.4.0-1 November 2017)

Corporate Headquarters

TOYOSU FORESIA, 3-2-24 Toyosu,
Koto-ku, Tokyo 135-0061, Japan
www.renesas.com

Trademarks

Renesas and the Renesas logo are trademarks of Renesas Electronics Corporation. All trademarks and registered trademarks are the property of their respective owners.

Contact information

For further information on a product, technology, the most up-to-date version of a document, or your nearest sales office, please visit:
www.renesas.com/contact/