

# CubeSuite Ver.1.30

Integrated Development Environment

User's Manual: 78K0 Coding

Target Device

78K0 Microcontroller

All information contained in these materials, including products and product specifications, represents information on the product at the time of publication and is subject to change by Renesas Electronics Corp. without notice. Please review the latest information published by Renesas Electronics Corp. through various means, including the Renesas Electronics Corp. website (<http://www.renesas.com>).

## Notice

1. All information included in this document is current as of the date this document is issued. Such information, however, is subject to change without any prior notice. Before purchasing or using any Renesas Electronics products listed herein, please confirm the latest product information with a Renesas Electronics sales office. Also, please pay regular and careful attention to additional and different information to be disclosed by Renesas Electronics such as that disclosed through our website.
2. Renesas Electronics does not assume any liability for infringement of patents, copyrights, or other intellectual property rights of third parties by or arising from the use of Renesas Electronics products or technical information described in this document. No license, express, implied or otherwise, is granted hereby under any patents, copyrights or other intellectual property rights of Renesas Electronics or others.
3. You should not alter, modify, copy, or otherwise misappropriate any Renesas Electronics product, whether in whole or in part.
4. Descriptions of circuits, software and other related information in this document are provided only to illustrate the operation of semiconductor products and application examples. You are fully responsible for the incorporation of these circuits, software, and information in the design of your equipment. Renesas Electronics assumes no responsibility for any losses incurred by you or third parties arising from the use of these circuits, software, or information.
5. When exporting the products or technology described in this document, you should comply with the applicable export control laws and regulations and follow the procedures required by such laws and regulations. You should not use Renesas Electronics products or the technology described in this document for any purpose relating to military applications or use by the military, including but not limited to the development of weapons of mass destruction. Renesas Electronics products and technology may not be used for or incorporated into any products or systems whose manufacture, use, or sale is prohibited under any applicable domestic or foreign laws or regulations.
6. Renesas Electronics has used reasonable care in preparing the information included in this document, but Renesas Electronics does not warrant that such information is error free. Renesas Electronics assumes no liability whatsoever for any damages incurred by you resulting from errors in or omissions from the information included herein.
7. Renesas Electronics products are classified according to the following three quality grades: “Standard”, “High Quality”, and “Specific”. The recommended applications for each Renesas Electronics product depends on the product’s quality grade, as indicated below. You must check the quality grade of each Renesas Electronics product before using it in a particular application. You may not use any Renesas Electronics product for any application categorized as “Specific” without the prior written consent of Renesas Electronics. Further, you may not use any Renesas Electronics product for any application for which it is not intended without the prior written consent of Renesas Electronics. Renesas Electronics shall not be in any way liable for any damages or losses incurred by you or third parties arising from the use of any Renesas Electronics product for an application categorized as “Specific” or for which the product is not intended where you have failed to obtain the prior written consent of Renesas Electronics. The quality grade of each Renesas Electronics product is “Standard” unless otherwise expressly specified in a Renesas Electronics data sheets or data books, etc.
  - “Standard”: Computers; office equipment; communications equipment; test and measurement equipment; audio and visual equipment; home electronic appliances; machine tools; personal electronic equipment; and industrial robots.
  - “High Quality”: Transportation equipment (automobiles, trains, ships, etc.); traffic control systems; anti-disaster systems; anti-crime systems; safety equipment; and medical equipment not specifically designed for life support.
  - “Specific”: Aircraft; aerospace equipment; submersible repeaters; nuclear reactor control systems; medical equipment or systems for life support (e.g. artificial life support devices or systems), surgical implantations, or healthcare intervention (e.g. excision, etc.), and any other applications or purposes that pose a direct threat to human life.
8. You should use the Renesas Electronics products described in this document within the range specified by Renesas Electronics, especially with respect to the maximum rating, operating supply voltage range, movement power voltage range, heat radiation characteristics, installation and other product characteristics. Renesas Electronics shall have no liability for malfunctions or damages arising out of the use of Renesas Electronics products beyond such specified ranges.
9. Although Renesas Electronics endeavors to improve the quality and reliability of its products, semiconductor products have specific characteristics such as the occurrence of failure at a certain rate and malfunctions under certain use conditions. Further, Renesas Electronics products are not subject to radiation resistance design. Please be sure to implement safety measures to guard them against the possibility of physical injury, and injury or damage caused by fire in the event of the failure of a Renesas Electronics product, such as safety design for hardware and software including but not limited to redundancy, fire control and malfunction prevention, appropriate treatment for aging degradation or any other appropriate measures. Because the evaluation of microcomputer software alone is very difficult, please evaluate the safety of the final products or system manufactured by you.
10. Please contact a Renesas Electronics sales office for details as to environmental matters such as the environmental compatibility of each Renesas Electronics product. Please use Renesas Electronics products in compliance with all applicable laws and regulations that regulate the inclusion or use of controlled substances, including without limitation, the EU RoHS Directive. Renesas Electronics assumes no liability for damages or losses occurring as a result of your noncompliance with applicable laws and regulations.
11. This document may not be reproduced or duplicated, in any form, in whole or in part, without prior written consent of Renesas Electronics.
12. Please contact a Renesas Electronics sales office if you have any questions regarding the information contained in this document or Renesas Electronics products, or if you have any other inquiries.

(Note 1) “Renesas Electronics” as used in this document means Renesas Electronics Corporation and also includes its majority-owned subsidiaries.

(Note 2) “Renesas Electronics product(s)” means any product developed or manufactured by or for Renesas Electronics.

## NOTES FOR CMOS DEVICES

### ① VOLTAGE APPLICATION WAVEFORM AT INPUT PIN

Waveform distortion due to input noise or a reflected wave may cause malfunction. If the input of the CMOS device stays in the area between  $V_{IL}$  (MAX) and  $V_{IH}$  (MIN) due to noise, etc., the device may malfunction. Take care to prevent chattering noise from entering the device when the input level is fixed, and also in the transition period when the input level passes through the area between  $V_{IL}$  (MAX) and  $V_{IH}$  (MIN).

### ② HANDLING OF UNUSED INPUT PINS

Unconnected CMOS device inputs can be cause of malfunction. If an input pin is unconnected, it is possible that an internal input level may be generated due to noise, etc., causing malfunction. CMOS devices behave differently than Bipolar or NMOS devices. Input levels of CMOS devices must be fixed high or low by using pull-up or pull-down circuitry. Each unused pin should be connected to  $V_{DD}$  or GND via a resistor if there is a possibility that it will be an output pin. All handling related to unused pins must be judged separately for each device and according to related specifications governing the device.

### ③ PRECAUTION AGAINST ESD

A strong electric field, when exposed to a MOS device, can cause destruction of the gate oxide and ultimately degrade the device operation. Steps must be taken to stop generation of static electricity as much as possible, and quickly dissipate it when it has occurred. Environmental control must be adequate. When it is dry, a humidifier should be used. It is recommended to avoid using insulators that easily build up static electricity. Semiconductor devices must be stored and transported in an anti-static container, static shielding bag or conductive material. All test and measurement tools including work benches and floors should be grounded. The operator should be grounded using a wrist strap. Semiconductor devices must not be touched with bare hands. Similar precautions need to be taken for PW boards with mounted semiconductor devices.

### ④ STATUS BEFORE INITIALIZATION

Power-on does not necessarily define the initial status of a MOS device. Immediately after the power source is turned ON, devices with reset functions have not yet been initialized. Hence, power-on does not guarantee output pin levels, I/O settings or contents of registers. A device is not initialized until the reset signal is received. A reset operation must be executed immediately after power-on for devices with reset functions.

### ⑤ POWER ON/OFF SEQUENCE

In the case of a device that uses different power supplies for the internal operation and external interface, as a rule, switch on the external power supply after switching on the internal power supply. When switching the power supply off, as a rule, switch off the external power supply and then the internal power supply. Use of the reverse power on/off sequences may result in the application of an overvoltage to the internal elements of the device, causing malfunction and degradation of internal elements due to the passage of an abnormal current.

The correct power on/off sequence must be judged separately for each device and according to related specifications governing the device.

### ⑥ INPUT OF SIGNAL DURING POWER OFF STATE

Do not input signals or an I/O pull-up power supply while the device is not powered. The current injection that results from input of such a signal or I/O pull-up power supply may cause malfunction and the abnormal current that passes in the device at this time may cause degradation of internal elements. Input of signals during the power off state must be judged separately for each device and according to related specifications governing the device.

## How to Use This Manual

This manual describes the role of the CubeSuite integrated development environment for developing applications and systems for 78K0 microcontrollers and provides an outline of its features.

CubeSuite is an integrated development environment (IDE) for 78K0 microcontrollers, integrating the necessary tools for the development phase of software (e.g. design, implementation, and debugging) into a single platform.

By providing an integrated environment, it is possible to perform all development using just this product, without the need to use many different tools separately.

**Readers** This manual is intended for users who wish to understand the functions of the CubeSuite and design software and hardware application systems.

**Purpose** This manual is intended to give users an understanding of the functions of the Cubesuite to use for reference in developing the hardware or software of systems using these devices.

**Organization** This manual can be broadly divided into the following units.

**CHAPTER 1 GENERAL**  
**CHAPTER 2 FUNCTIONS**  
**CHAPTER 3 COMPILER LANGUAGE SPECIFICATIONS**  
**CHAPTER 4 ASSEMBLY LANGUAGE SPECIFICATION**  
**CHAPTER 5 LINK DIRECTIVE SPECIFICATION**  
**CHAPTER 6 FUNCTION SPECIFICATION**  
**CHAPTER 7 STARTUP**  
**CHAPTER 8 ROMIZATION**  
**CHAPTER 9 REFERENCING COMPILER AND ASSEMBLER**  
**CHAPTER 10 CAUTIONS**  
**APPENDIX A INDEX**

**How to Read This Manual** It is assumed that the readers of this manual have general knowledge of electricity, logic circuits, and microcontrollers.

**Conventions**

Data significance:	Higher digits on the left and lower digits on the right
Active low representation:	$\overline{XXX}$ (overscore over pin or signal name)
Note:	Footnote for item marked with Note in the text
Caution:	Information requiring particular attention
Remark:	Supplementary information
Numeric representation:	Decimal ... XXXX Hexadecimal ... 0xXXXX



**Related Documents**

The related documents indicated in this publication may include preliminary versions. However, preliminary versions are not marked as such.

Document Name		Document No.
CubeSuite Ver.1.30 Integrated Development Environment User's Manual	Start	R20UT0003E
	Programming	U19390E
	Message	U19391E
	78K0 Coding	This document
	78K0 Build	R20UT0005E
	78K0 Debug	U19387E

**Caution** The related documents listed above are subject to change without notice. Be sure to use the latest edition of each document when designing.

**All trademarks or registered trademarks in this document are the property of their respective owners.**

[MEMO]

[MEMO]

# TABLE OF CONTENTS

## CHAPTER 1 GENERAL ... 13

- 1.1 Outline ... 13
  - 1.1.1 C compiler and assembler ... 13
  - 1.1.2 Position of compiler and assembler ... 16
  - 1.1.3 Processing flow ... 17
  - 1.1.4 Basic structure of C source program ... 18
- 1.2 Features ... 20
  - 1.2.1 Features of C compiler ... 20
  - 1.2.2 Features of assembler ... 21
  - 1.2.3 Limits ... 21

## CHAPTER 2 FUNCTIONS ... 24

- 2.1 Variables (Assembly Language) ... 24
  - 2.1.1 Defining variables with no initial values ... 24
  - 2.1.2 Defining const constants with initial values ... 24
  - 2.1.3 Defining 1-bit variables ... 24
  - 2.1.4 1/8 bit access of variable ... 25
  - 2.1.5 Allocating to sections accessible with short instructions ... 26
  - 2.1.6 Specifying option bytes ... 26
- 2.2 Variables (C Language) ... 27
  - 2.2.1 Allocating data only of reference in ROM ... 27
  - 2.2.2 Allocating to sections accessible with short instructions ... 27
  - 2.2.3 Allocating addresses directly ... 28
  - 2.2.4 Defining 1-bit variables ... 29
  - 2.2.5 Empty area of the structure is stuffed ... 29
  - 2.2.6 Data location in internal extended RAM ... 30
- 2.3 Functions ... 31
  - 2.3.1 Allocating to sections accessible with short instructions ... 31
  - 2.3.2 Allocating addresses directly ... 31
  - 2.3.3 Inline expansion of function ... 31
  - 2.3.4 Embedding assembly instructions ... 32
  - 2.3.5 norec functions and noauto functions is described ... 33
- 2.4 Using Microcontroller Functions ... 34
  - 2.4.1 Accessing special function registers (SFR) from C ... 34
  - 2.4.2 Interrupt functions in C ... 35
  - 2.4.3 Using CPU control instructions in C ... 36
- 2.5 Startup Routine ... 38
  - 2.5.1 Deleting unused functions and areas from startup routine ... 38
  - 2.5.2 Allocating stack area ... 39
  - 2.5.3 Initializing RAM ... 39
- 2.6 Link Directives ... 41

- 2.6.1 Partitioning default areas ... 41
- 2.6.2 Specifying section allocation ... 41
- 2.7 Reducing Code Size ... 42
  - 2.7.1 Using extended functions to generate efficient object code ... 42
  - 2.7.2 Calculating complex expressions ... 46
- 2.8 Compiler and Assembler Mutual References ... 47
  - 2.8.1 Mutually referencing variables ... 47
  - 2.8.2 Mutually referencing functions ... 49
  - 2.8.3 When the assembler calls functions written in C, registers must be saved ... 51

## **CHAPTER 3 COMPILER LANGUAGE SPECIFICATIONS ... 52**

- 3.1 Basic Language Specifications ... 52
  - 3.1.1 Processing system dependent items ... 52
- 3.2 Environment During Compilation ... 62
  - 3.2.1 Internal representation and value area of data ... 62
  - 3.2.2 Memory ... 67
- 3.3 Extended Language Specifications ... 68
  - 3.3.1 Macro names ... 68
  - 3.3.2 Keywords ... 69
  - 3.3.3 #pragma directives ... 71
  - 3.3.4 Using extended functions ... 72
  - 3.3.5 C source modifications ... 223
- 3.4 Function Call Interface ... 224
  - 3.4.1 Return values ... 224
  - 3.4.2 Ordinary function call interface ... 224
  - 3.4.3 noauto function call interface (only for normal model) ... 230
  - 3.4.4 norec function call interface (only for normal model) ... 232
  - 3.4.5 Static model function call interface ... 234
  - 3.4.6 Pascal function call interface ... 238
- 3.5 List of saddr Area Labels ... 241
  - 3.5.1 Normal model ... 241
  - 3.5.2 Static model ... 242
- 3.6 List of Segment Names ... 243
  - 3.6.1 List of segment names ... 244
  - 3.6.2 Segment allocation ... 245
  - 3.6.3 Example of C source ... 245
  - 3.6.4 Example of output assembler module ... 246

## **CHAPTER 4 ASSEMBLY LANGUAGE SPECIFICATION ... 250**

- 4.1 Description Methods of Source Program ... 250
  - 4.1.1 Basic configuration ... 250
  - 4.1.2 Description method ... 256
  - 4.1.3 Expressions and operators ... 267
  - 4.1.4 Arithmetic operators ... 270
  - 4.1.5 Logic operators ... 278
  - 4.1.6 Relational operators ... 283
  - 4.1.7 Shift operators ... 290

4.1.8	Byte separation operators ...	293
4.1.9	Special operators ...	296
4.1.10	Other operator ...	301
4.1.11	Restrictions on operations ...	303
4.1.12	Absolute expression definitions ...	307
4.1.13	Bit position specifier ...	307
4.1.14	Identifiers ...	309
4.1.15	Operand characteristics ...	309
4.2	Directives ...	313
4.2.1	Overview ...	313
4.2.2	Segment definition directives ...	314
4.2.3	Symbol definition directives ...	330
4.2.4	Memory initialization, area reservation directives ...	337
4.2.5	Linkage directives ...	345
4.2.6	Object module name declaration directive ...	352
4.2.7	Branch instruction automatic selection directives ...	354
4.2.8	Macro directives ...	357
4.2.9	Assemble termination directive ...	372
4.3	Control Instructions ...	374
4.3.1	Overview ...	374
4.3.2	Assemble target type specification control instruction ...	375
4.3.3	Debug information output control instructions ...	377
4.3.4	Cross-reference list output specification control instructions ...	382
4.3.5	Include control instruction ...	387
4.3.6	Assembly list control instructions ...	391
4.3.7	Conditional assembly control instructions ...	414
4.3.8	Kanji code control instruction ...	440
4.3.9	Other control instructions ...	442
4.4	Macros ...	443
4.4.1	Overview ...	443
4.4.2	Using macros ...	443
4.4.3	Symbols in macros ...	446
4.4.4	Macro operators ...	447
4.5	Reserved Words ...	449
4.6	Instructions ...	450
4.6.1	Memory space ...	450
4.6.2	Registers ...	451
4.6.3	Addressing ...	456
4.6.4	Instruction set ...	463
4.6.5	Explanation of instructions ...	469

## **CHAPTER 5 LINK DIRECTIVE SPECIFICATION ... 561**

5.1	Coding Method ...	561
5.1.1	Link directives ...	561
5.2	Reserved Words ...	566
5.3	Coding Examples ...	566
5.3.1	When specifying link directive ...	566
5.3.2	When using the compiler ...	567

## **CHAPTER 6 FUNCTION SPECIFICATION ... 569**

- 6.1 Distribution Libraries ... 569**
  - 6.1.1 Standard library ... 570**
  - 6.1.2 Runtime library ... 576**
- 6.2 Interface Between Functions ... 586**
  - 6.2.1 Arguments ... 586**
  - 6.2.2 Return values ... 586**
  - 6.2.3 Saving registers used by separate libraries ... 586**
  - 6.2.4 Bank area restrictions ... 590**
- 6.3 Header Files ... 591**
  - 6.3.1 ctype.h ... 591**
  - 6.3.2 setjmp.h ... 592**
  - 6.3.3 stdarg.h (normal model only) ... 593**
  - 6.3.4 stdio.h ... 593**
  - 6.3.5 stdlib.h ... 594**
  - 6.3.6 string.h ... 596**
  - 6.3.7 error.h ... 597**
  - 6.3.8 errno.h ... 597**
  - 6.3.9 limits.h ... 597**
  - 6.3.10 stddef.h ... 598**
  - 6.3.11 math.h (normal model only) ... 599**
  - 6.3.12 float.h ... 601**
  - 6.3.13 assert.h (normal model only) ... 603**
- 6.4 Re-entrant (Normal Model Only) ... 603**
- 6.5 Character/String Functions ... 605**
- 6.6 Program Control Functions ... 625**
- 6.7 Special Functions ... 628**
- 6.8 Input and Output Functions ... 633**
- 6.9 Utility Functions ... 650**
- 6.10 String and Memory Functions ... 682**
- 6.11 Mathematical Functions ... 705**
- 6.12 Diagnostic Function ... 752**
- 6.13 Library Stack Consumption List ... 754**
  - 6.13.1 Standard libraries ... 754**
  - 6.13.2 Runtime libraries ... 758**
- 6.14 List of Maximum Interrupt Disabled Times for Libraries ... 766**
- 6.15 Batch Files for Update of Startup Routine and Library Functions ... 767**
  - 6.15.1 Using batch files ... 768**

## **CHAPTER 7 STARTUP ... 771**

- 7.1 Function Overview ... 771**
- 7.2 File Organization ... 771**
  - 7.2.1 "bat" folder contents ... 772**
  - 7.2.2 "lib" folder contents ... 772**
  - 7.2.3 "src" folder contents ... 774**
- 7.3 Batch File Description ... 775**
  - 7.3.1 Batch files for creating startup routines ... 775**

<b>7.4 Startup Routines ...</b>	<b>776</b>
7.4.1 Overview of startup routines ...	776
7.4.2 Startup routine preprocessing ...	778
7.4.3 Startup routine initial settings ...	780
7.4.4 Startup routine main function startup and postprocessing ...	783
<b>7.5 ROMization Processing in Startup Module for Flash Area ...</b>	<b>784</b>
<b>7.6 Coding Examples ...</b>	<b>785</b>
7.6.1 When revising startup routine ...	785

## **CHAPTER 8 ROMIZATION ... 787**

## **CHAPTER 9 REFERENCING COMPILER AND ASSEMBLER ... 788**

<b>9.1 Accessing Arguments and Automatic Variables ...</b>	<b>788</b>
9.1.1 Normal model ...	788
9.1.2 Static model ...	791
<b>9.2 Storing Return Values ...</b>	<b>793</b>
<b>9.3 Calling Assembly Language Routines from C Language ...</b>	<b>793</b>
9.3.1 Function information file modifications ...	793
9.3.2 C language function calling procedure ...	794
9.3.3 Saving data from assembly language routine and returning ...	795
<b>9.4 Calling C Language Routines from Assembly Language ...</b>	<b>797</b>
9.4.1 Calling C language function from assembly language program ...	797
<b>9.5 Referencing Variables Defined in C Language ...</b>	<b>801</b>
<b>9.6 Referencing Variables Defined in Assembly Language from C Language ...</b>	<b>802</b>
<b>9.7 Points of Caution for Calling Between C Language Functions and Assembler Functions ...</b>	<b>802</b>

## **CHAPTER 10 CAUTIONS ... 804**

## **APPENDIX A INDEX ... 811**



CHAPTER 1 GENERAL

This chapter explains the roles of the 78K0 C compiler package (called "CA78K0" ) in system development, and provides an outline of their functions.

1.1 Outline

78K0 C compiler is a translation program that converts source programs written in traditional C or ANSI C into machine language. 78K0 C compiler can produce either object files or assembly source files.

78K0 assembler is a language processing program that converts source programs written in assembly language into machine language.

1.1.1 C compiler and assembler

(1) C language and assembly language

A C compiler takes C source modules as input and produces either object modules or assembly source modules as output. This means that you can develop your programs in C and use assembly language as required to make fine adjustments.

An assembler takes assembly source modules as input and produces object modules as output.

The following figure shows the flow of program development with a C compiler and an assembler.

Figure 1-1. Flow of Development with C Compiler and Assembler

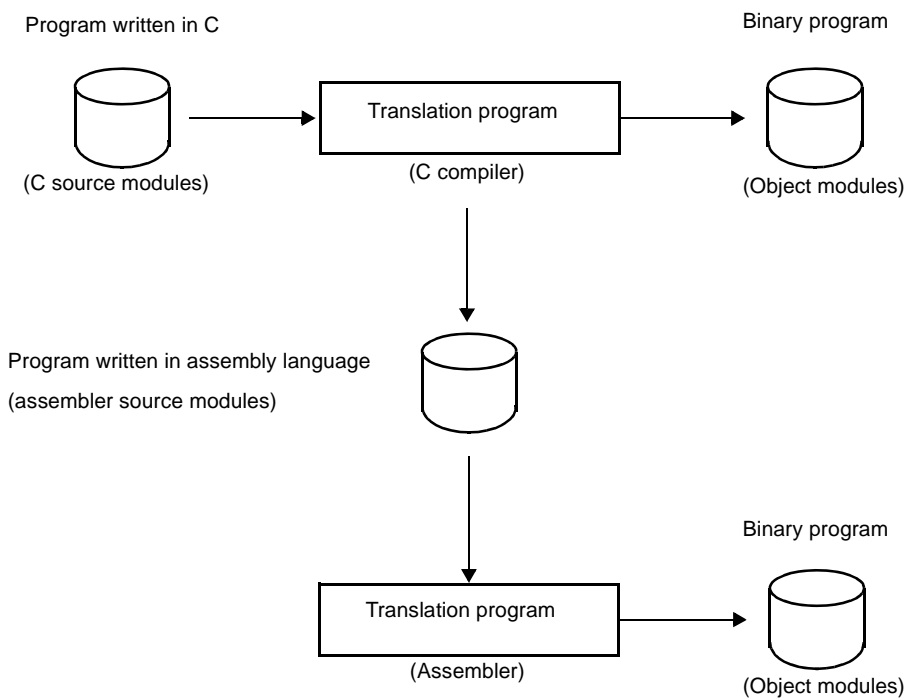

**(2) Relocatable assemblers**

The machine language translated from assembly source files by the assembler is written to the memory of the microcontroller before use. To do this, the location in memory where each machine language instruction is to be written must already be determined.

Therefore, information is added to the machine language assembled by the assembler, stating where in memory each machine language instruction is to be located.

Depending on the method used to allocate machine language instructions to memory addresses, assemblers can be broadly divided into absolute assemblers and relocatable assemblers. RA78K0 is a relocatable assembler.

- Absolute assembler

An absolute assembler allocates machine language instructions assembled from the assembly language at absolute addresses.

- Relocatable assembler

In a relocatable assembler, the addresses determined for the machine language instructions assembled from the assembly language are tentative

Absolute addresses are determined subsequently by the linker.

In the past, when programs were created with absolute assemblers, programmers normally had to write the entire program as a single large block. However, when all the components of a large program are contained in a single block, the program becomes complicated, making it harder to understand and maintain.

To avoid this, large programs are now usually developed by dividing them into several subprograms, called modules, one for each functional unit. This programming technique is called modular programming.

Relocatable assemblers are well suited for modular programming, which has the following advantages:

**(a) Greater development efficiency**

It is difficult to write a large program all at the same time. In such cases, dividing the program into modules for individual functions enables two or more programmers to develop subprograms in parallel to increase development efficiency.

Moreover, when bugs are found, only the module that contained the bugs needs to be corrected and assembled again, instead of needing to assemble the entire program. This shortens debugging time.

**Figure 1-2. Division into Modules**

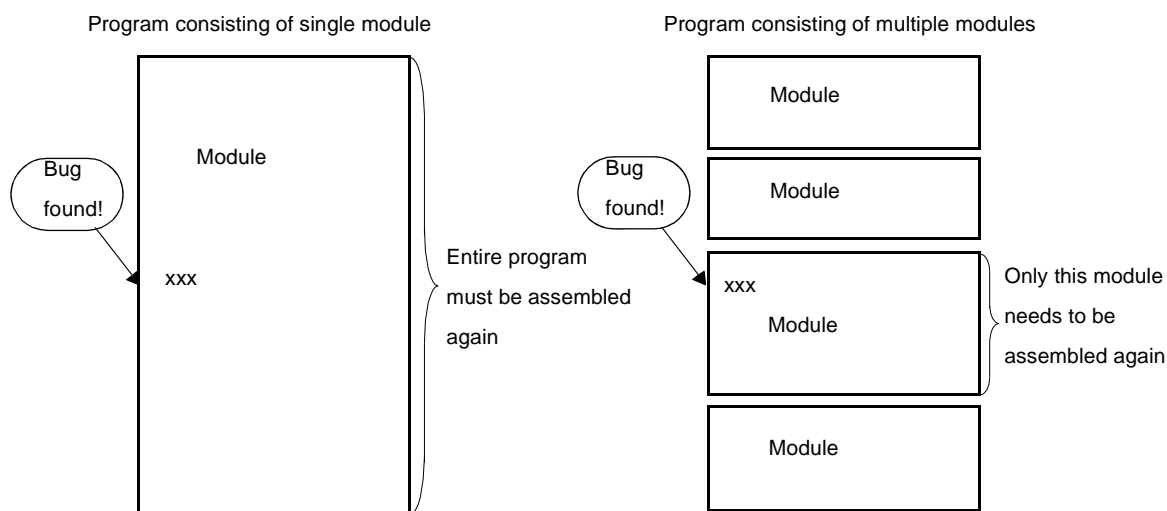

(b) Utilization of resources

Reliable and versatile modules from previous development efforts are software resources that can be reused in new programs. As you accumulate more of these resources, you save time and labor in developing new programs.

Figure 1-3. Resource Utilization

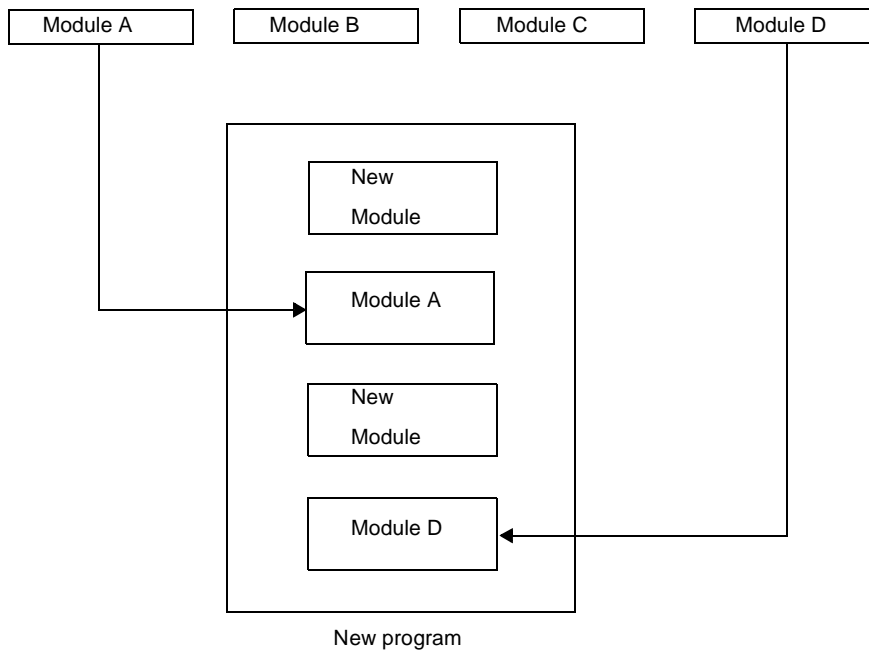

1.1.2 Position of compiler and assembler

The following figure shows the position of compiler and assembler in the flow of product development.

Figure 1-4. Flow of microcontroller Application Product Development

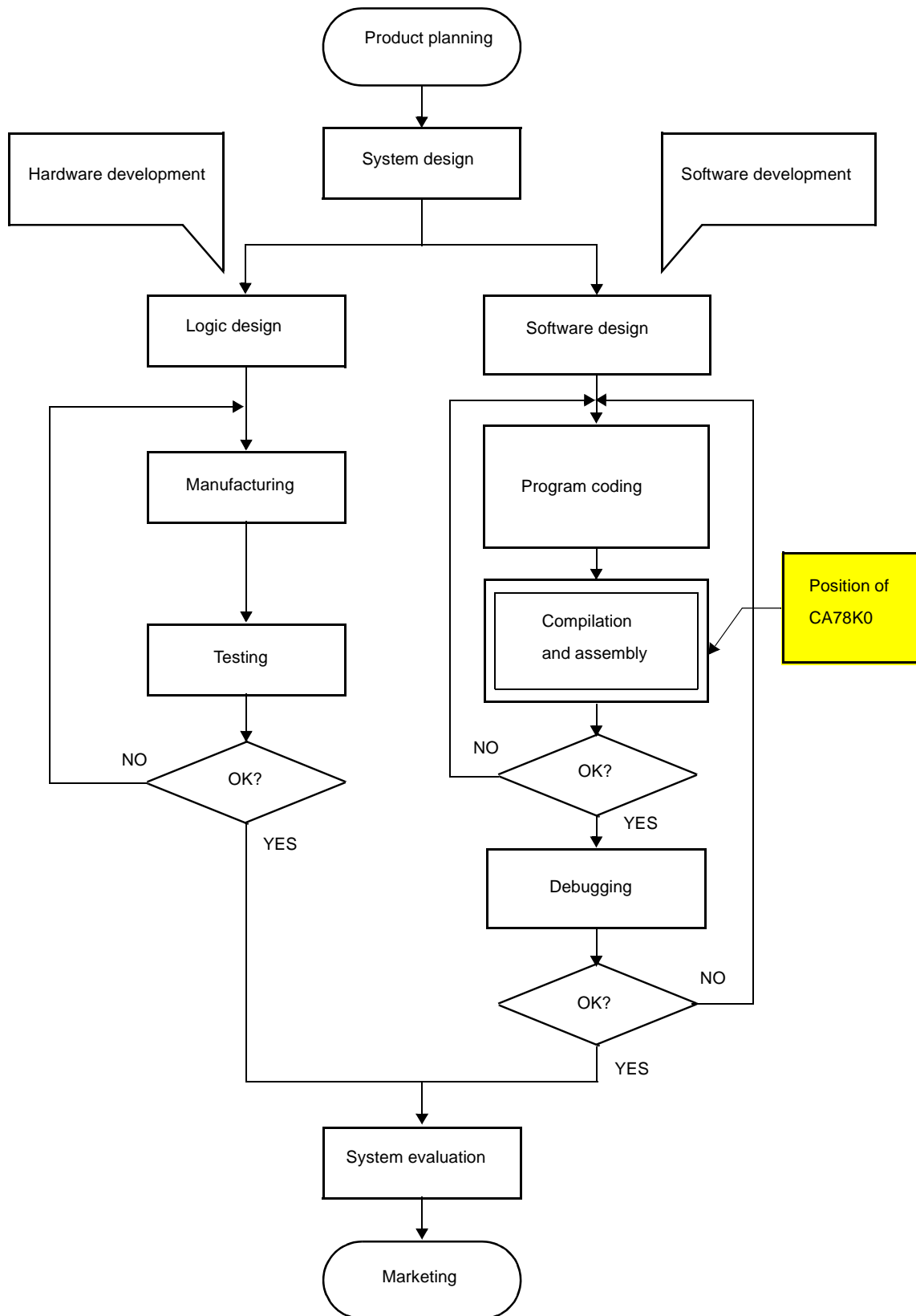

1.1.3 Processing flow

This section explains the flow of processing in program development.

The C compiler compiles C source module files and generates object files or assembly source module files. By hand optimizing the generated assembly source module files, you can create more efficient object module files. This is useful when the program must perform high-speed processing and when compact modules are desirable.

The following programs are involved in the processing flow.

Table 1-1. Programs Involved in Processing Flow

Program	Function
Compiler	Compiles C source module files
Assembler	Assembles assembly language source module files
Linker	Links object module files Determines addresses of relocatable segments
Object converter	Converts to HEX-format object module files
Librarian	Creates library files
List converter	Generates absolute assemble list files

Figure 1-5. Flow of Compiler and Assembler Processing

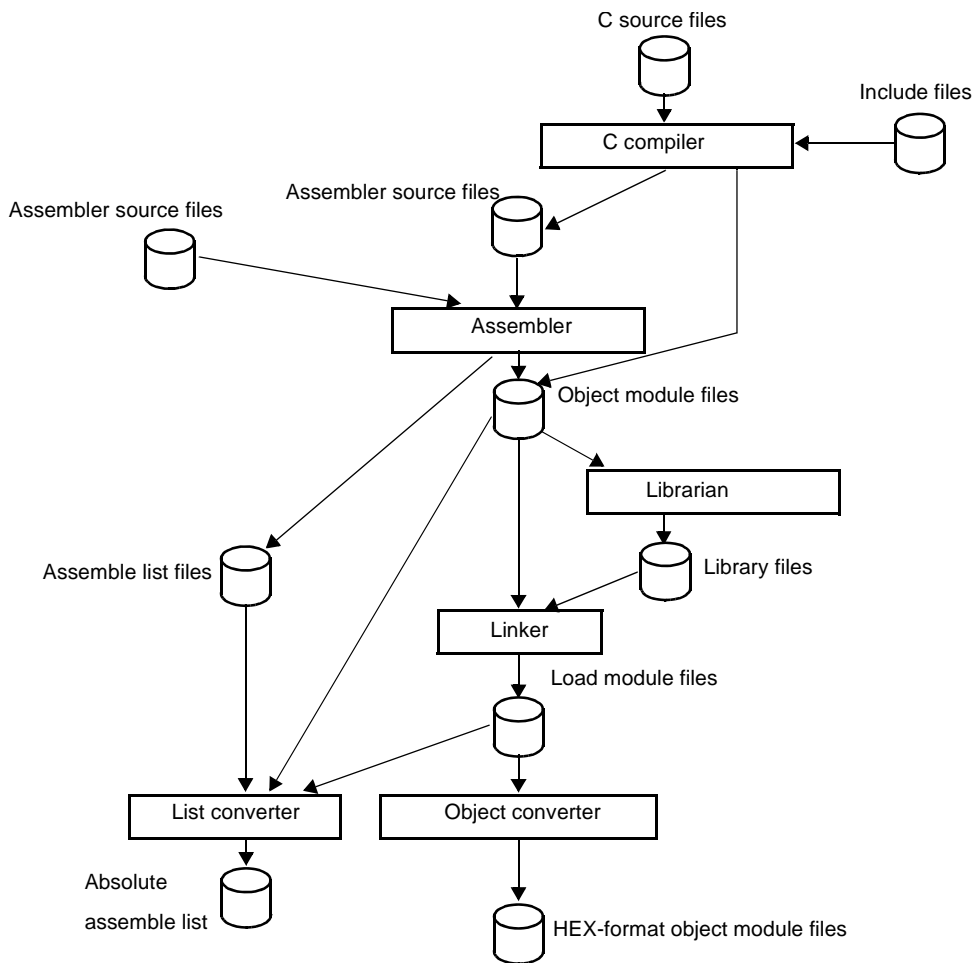

1.1.4 Basic structure of C source program

A program in C is a collection of functions. A function is an independent unit of code that performs a specific action. Every C language program must have a function "main" which becomes the main routine of the program and is the first function to be called when execution begins.

Each function consists of a header part, which defines its function name and arguments, and a body part, which consists of declarations and statements. The format of C programs is shown below.

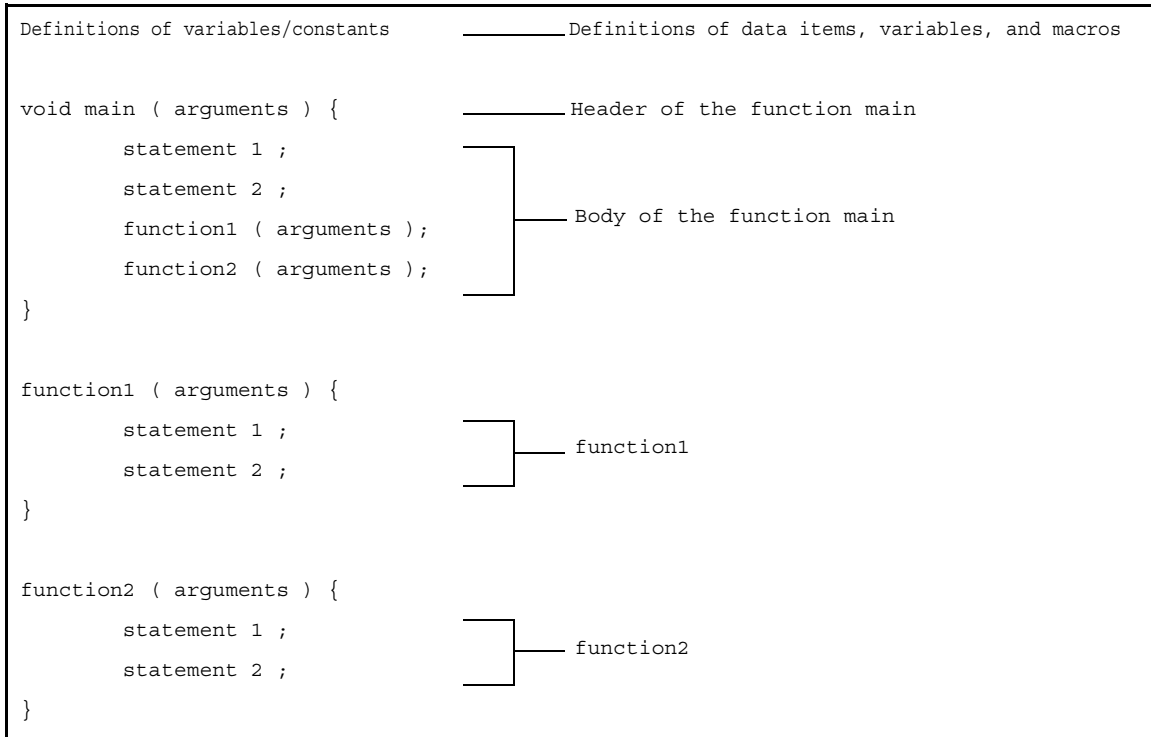

An actual C source program looks like this.

```

#define TRUE    1      /* #define xxx xxx Preprocessor directive (macro definition) */
#define FALSE   0      /* #define xxx xxx Preprocessor directive (macro definition) */
#define SIZE    200    /* #define xxx xxx Preprocessor directive (macro definition) */

void displaystring ( char*, int );      /* xxx xxxxx ( xxx, xxx )
                                         Function prototype declaration */
void displaychar ( char );              /* xxx xxxxx ( xxx )
                                         Function prototype declaration */

char    mark[SIZE + 1] ;                /* char xxx
                                         Type declaration, External definition */
                                         /* xx[xx] Operator */

void main ( void ) {
    int    i, prime, k, count ;          /* int xxx Type declaration */

    count = 0 ;                          /* xx = xx Operator */
    
```

```

for ( i = 0 ; i <= SIZE ; i ++ )      /* for ( xx ; xx ; xx ) xxx ; Control
                                         structure */
    mark[i] = TRUE ;
for ( i = 0 ; i <= SIZE ; i ++ ) {
    if ( mark[i] ) {
        prime = i + i + 3 ;           /* xxx = xxx + xxx + xxx   Operator */
        displaystring ( "%6d", prime ); /* xxx ( xxx );           Operator */

        count ++ ;
        if ( ( count%8 ) == 0 ) displaychar ( '\n' ); /* if ( xxx ) xxx ;
                                                         Control structure */

        for ( k = i + prime ; k <= SIZE ; k += prime )
            mark[k] = FALSE ;
    }
}
displaystring ( "\n%d primes found.", count ); /* xxx ( xxx ); Operator */
}

void displaystring ( char *s, int i ) {
    int    j ;
    char   *ss ;

    j = i ;
    ss = s ;
}

void displaychar ( char c ) {
    char   d ;

    d = c ;
}

```

**(1) Declaration of type and storage class**

Declares the data type and storage class of an object identifier.

**(2) Operator or expression**

Performs arithmetic, logical, or assignment operations.

**(3) Control structure**

Specifies the flow of the program. C has a number of instructions for different types of control, such as conditional control, iteration, and branching.

**(4) Structure or union**

Declares a structure or union. A structure is a data object that contains several subobjects or members that may have different types. A union is like a structure, but allows two or more variables to share the same memory.

**(5) External definition**

Declares a function or external object. A function is an independent unit of code that performs a specific action. A C program is a collection of functions.

**(6) Preprocessor directive**

An instruction to the compiler. The #define directive instructs the compiler to replace any instances of the first operand that appear in the program with the second operand.

**(7) Declaration of function prototype**

Declares the types of the return value and arguments of a function.

**1.2 Features**

This section explains the features of the CA78K0.

**1.2.1 Features of C compiler****(1) Conforms to ANSI C**

The compiler conforms to the ANSI standard for the C language.

**Remark** ANSI: American National Standards Institute

**(2) Designed for efficient use of ROM and RAM memory**

- External variables can be allocated to short direct addressing memory.  
Function arguments and auto variables can be allocated to short direct addressing memory or registers.
- Bit instructions enable definitions and operations on data in units of 1 bit.

**(3) Interrupt control features**

- Peripheral hardware of 78K0 can be controlled directly from C.
- Interrupt handlers can be written directly in C.

**(4) Supports extended functions of 78K0**

78K0 C compiler supports the following extended functions, which are not defined in the ANSI standard. Some of these functions allow special-purpose registers to be accessed in C, while others enable more compact object code and higher execution speed.

The following table lists extended functions that reduce the size of object code and improve execution speed.

**Table 1-2. Methods to Improve Execution Speed**

Method	Extended Function
Functions can be called using the callt table area.	callf/___callf functions
Allocate variables to registers	Register variables
Allocate variables to the saddr area	sreg/___sreg
Use sfr names.	sfr area
Functions that do not output code for preprocessing and post-processing (stack frame formation) can be created.	noauto functions, norec/___leaf functions,
Embed assembly language statements in C source programs.	ASM statements
Accessing the saddr or sfr area can be made on a bit-by-bit basis.	bit type variables, boolean/___boolean type variables



Method	Extended Function
A function body can be stored in the callf area.	callf/ __callff unctions,
Specify bit fields using the unsigned char type.	Bit field declarations
The code to multiply can be directly output with inline expansion.	Multiplication function
The code to divide can be directly output with inline expansion.	Division function
The code to rotate can be directly output with inline expansion.	Rotation functions
Specific addresses in the memory space can be accessed.	Absolute address function
Specific data and instructions can be directly embedded in the code area.	Data insertion function
The used stack is corrected on the called function side.	__pascal function
memcpy and memset are directly expanded inline and output.	Memory function

See "[3.3 Extended Language Specifications](#)" for detailed information about the extended functions of the 78K0R C compiler.

### 1.2.2 Features of assembler

The 78K0 assembler has the following features.

#### (1) Macro function

When the same group of instructions occurs in a source program over and over again, you can define a macro to give a single name to the group of instructions.

Macros can increase your coding efficiency and make your programs more readable.

The 78K0 assembler provides the BR ([Branch instruction automatic selection directives](#)).

A characteristic of programs that make efficient use of memory is selection of the appropriate branching instructions, using only the number of bytes required by the branch destination range. But it is a burden for the programmer to need to be conscious of the branch destination range for every branch. The BR directives are automatic solutions to this problem. They facilitate memory-efficient branching by instructing the assembler to generate the most appropriate branching instruction for the branch destination range. This function is called branch instruction optimization.

#### (2) Conditional assembly

Conditional assembly allows you to specify conditions that determine whether or not specific sections of the source program are assembled.

For example, when the source contains debugging statements, a switch can be set to determine whether or not they should be translated into machine language. When they are no longer needed, they can be excluded from the output with no major modifications to the source program.

### 1.2.3 Limits

#### (1) Compiler limits

See "[\(9\) Translation Limit](#)" for the limits of the compiler.

## (2) Assembler limits

Table 1-3. Assembler Translation Limits

Description	Limit
Number of symbols (local + public)	65,535
Number of symbols for which cross-reference list can be output	65,534 <sup>Note 1</sup>
Maximum size of macro body for one macro reference	1 Mbyte
Total size of all macro bodies	10 Mbyte
Number of segments in one file	256
Number of macro and include specifications in one file	10,000
Number of macro and include specifications in one include file	10,000
Number of relocation data items <sup>Note 2</sup>	65,535
Line number data items	65,535
Number of BR directives in one file	32,767
Character length of source line	2,048 <sup>Note 3</sup>
Character length of symbol	256
Character length of name definition <sup>Note 4</sup>	1,000
Character length of switch name <sup>Note 4</sup>	31
Character length of segment name	8
Character length of module name (NAME directive)	256
Number of parameters in MACRO directive	16
Number of arguments in macro reference	16
Number of arguments in IRP directive	16
Number of local symbols in macro body	64
Total number of local symbols in expanded macro	65,535
Nesting levels in macro (macro reference, REPT directive, IRP directive)	8 levels
Number of characters in TITLE control instruction (-lh option)	60 <sup>Note 5</sup>
Number of characters in SUBTITLE control instruction	72
Include file nesting levels in 1 file	16 levels
Conditional assembly nesting levels	8 levels
Number of include file paths specifiable by -i option	64
Number of symbols definable by -d option	30

**Notes 1.** Excluding the number of module names and section names.

Available memory is used. When memory is insufficient, a file is used.

**2.** Information passed to the linker when a symbol value cannot be resolved by the assembler.

For example, when an externally referenced symbol is referenced by the MOV instruction, two items of relocation information are generated in a .rel file.

**3.** Including CR and LF codes. If a line is longer than 2048 characters, a warning message is output and the 2049th and following characters are ignored.

4. Switch names are set to true/false by the SET and RESET directives and are used by constructs such as \$If.
5. If the maximum number of characters that can be specified in one line of the assemble list file ("X") is 119, this figure will be "X - 60" or less.

### (3) Linker limits

**Table 1-4. Linker Limits**

Description	Limit
Number of symbols (local + public)	65,535
Line number data items in 1 segment	65,535
Number of segments	65,535
Number of input modules	1,024
Character length of memory area name	256
Number of memory areas	100 <sup>Note</sup>
Number of library files specifiable by the -b option	64
Number of include file paths specifiable by the -i option	64

**Note** Including those defined by default.

## CHAPTER 2 FUNCTIONS

This section explains programming technique to use CA78K0 more effectively and use of extended functions.

## 2.1 Variables (Assembly Language)

This section explains techniques for using variables in assembly language.

### 2.1.1 Defining variables with no initial values

Allocate memory area in a data segment.

Use the DSEG quasi directive to define a data segment, and use the DS quasi directive to allocate memory area.

**Example** Define an 10-byte variable with no initial values.

```
DSEG
_table: DS      10
```

**Remark** See "DSEG" and "DS".

### 2.1.2 Defining const constants with initial values

Initialize memory area in a code segment.

Use the CSEG quasi directive to define a code segment, and use the DB (1 byte), or DW (2 bytes) quasi directive to initialize memory area.

**Example** Defining constants with initial values

```
CSEG
_val1: DB      0F0H   ; 1 byte
_val2: DW      1234H   ; 2 bytes
```

**Remark** See "CSEG", "DB", and "DW".

### 2.1.3 Defining 1-bit variables

Allocate 1 bit memory area in a bit segment.

Use the BSEG quasi directive to define a bit segment, and use the DBIT quasi directive to allocate 1 bit memory area.

**Example** Define bit variables with no initial values.

```
BSEG
_bit1 DBIT
_bit2 DBIT
_bit3 DBIT
```

**Remark** See "BSEG" and "DBIT".

#### 2.1.4 1/8 bit access of variable

In assembly language source code, give two symbols for the address in the saddr area. To use the symbol name respectively for the bit access and for byte access, specify saddr as the relocation attribute of a DSEG segment, define bit name of a symbol for byte access as a symbol name for bit access by a EQU quasi directives.

**Example** Byte access symbol name: FLAGBYTE  
Bit access symbol name: FLAGBIT

- smp1.asm

```
NAME SMP1
PUBLIC FLAGBYTE, FLAGBIT

FLAGS DSEG SADDR ; The relocation attribute of DSEG is SADDR
FLAGBYTE: DS (1) ; Define FLAGBYTE
FLAGBIT EQU FLAGBYTE.0 ; Define FLAGBIT

END
```

- smp2.asm

```
NAME SMP2

EXTRN FLAGBYTE
EXTBIT FLAGBIT ; FLAGBIT declared as EXTBIT

CSEG
C1:
MOV FLAGBYTE, #0FFH
CLR1 FLAGBIT

END
```

**Remark** See "DSEG" and "EQU".

### 2.1.5 Allocating to sections accessible with short instructions

Compared to other data memory areas, the short direct addressing area can be accessed with shorter instructions. Improve the memory efficiency of programs by efficiently using this area.

To allocate in the short direct addressing area, specify `saddr` or `saddrp` as the relocation attribute of a DSEG quasi directive.

The following examples explain use in assembly source code.

- Module 1

```
PUBLIC  TMP1, TMP2
WORK   DSEG saddrp
TMP1:  DS 2 ; word
TMP2:  DS 1 ; byte
```

- Module 2

```
EXTRN  TMP1, TMP2
SAB    CSEG
MOVW   TMP1, #1234H
MOV    TMP2, #56H
:
```

**Remark** See "[DSEG](#)".

### 2.1.6 Specifying option bytes

To specify an option byte, add an assembly source module and specify the byte with a DB pseudo instruction. A simple method is to add it to the startup routine.

**Example** To set an option byte to 0F1H

```
OPT    CSEG    OPT_BYTE
OPTION: DB     30H
        DB     00H
        DB     00H
        DB     00H
        DB     02H
```

**Remark** See "[CSEG](#)" and "[DB](#)".

## 2.2 Variables (C Language)

This section explains Variables (C language).

### 2.2.1 Allocating data only of reference in ROM

#### (1) Allocating variables with initial values in ROM

Specify the const qualifier to allocate variables with initial values only of a reference in ROM.

**Example** Allocating variable "a" with initial values only of a reference in ROM

```
const int a = 0x12 ; /* Allocating ROM */
int b = 0x12 ;      /* Allocating ROM/RAM */
```

Variable "a" is allocated in ROM.

For variable "b", the initializing value is allocated in ROM and the variable itself is allocated in RAM (areas is required in both ROM and RAM).

Startup routine ROMization, an initial value of ROM is copied in a variable of RAM.

ROMization requires areas in both ROM and RAM.

#### (2) Allocating table data in ROM

If allocating table data in ROM only, define type qualifier const, as follows.

```
const unsigned char table_data[9] = { 1, 2, 3, 4, 5, 6, 7, 8, 9 };
```

### 2.2.2 Allocating to sections accessible with short instructions

Compared to other data memory areas, the short direct addressing area can be accessed with shorter instructions. Improve the memory efficiency of programs by efficiently using this area.

The use example is shown below.

External variables defined sreg or \_\_sreg, and static variables within functions (called sreg variables) are automatically allocated in relocatable in short direct addressing area [FE20H to FEB3H] (normal model) and [FE20H to FECFH] (Static Model).

```
extern sreg int hsmm0 ;
extern sreg int hsmm1 ;
extern sreg int *hsptr ;

void main ( void ) {
    hsmm0 -= hsmm1 ;
}
```

**Remark** See "[How to use the saddr area \(sreg/\\_\\_sreg\)](#)".

### 2.2.3 Allocating addresses directly

#### (1) directmap

External variable declared `__directmap` and the initializing value of static variable in functions are allocation address, the variable is mapped to the specified address. Specify the allocation address as an integral number.

`__directmap` variables in C source files are handled as well as static variables.

Make the `__directmap` declaration in the module which defines the variable that to map to an absolute address.

```
__directmap char c = 0xfe00 ;
__directmap __sreg char d = 0xfe20 ;
__directmap __sreg char e = 0xfe21 ;

__directmap struct x {
    char a ;
    char b ;
} xx = { 0xfe30 } ;

void main ( void ) {
    c = 1 ;
    d = 0x12 ;
    e.5 = 1 ;
    xx.a = 5 ;
    xx.b = 10 ;
}
```

**Remark** See "[Absolute address allocation specification \(`\_\_directmap`\)](#)".

#### (2) Using section names

Change the compiler output section name and specify a starting address.

Use the `#pragma` directive to specify the name of the section to be changed, a new name, and the starting address of the new section.

The following example changes the section name from `@CODEL` to `CC1`, and specifies `2400H` as the starting address.

```
#pragma section @CODEL CC1 AT 2400H

void main ( void ) {
    /* Function definition */
}
```

**Remark** See "[Changing compiler output section name \(`#pragma section ...`\)](#)".



### 2.2.4 Defining 1-bit variables

The variable is made bit and boolean type, are handled as 1-bit data, and are allocated in the short direct addressing area.

bit and boolean type variables are handled in the same way as external variables with no initial values (irregularity). The compiler generates the following bit manipulation instructions to this bit variables.

```
MOV1 , AND1 , OR1 , XOR1 , SET1 , CLR1 , NOT1 , BT , BF
```

The bit access to the short direct addressing area becomes possible in C source code.

```
#define ON      1
#define OFF    0
extern bit data1 ;
extern bit data2 ;

void main ( void ) {
    data1 = ON ;
    data2 = OFF ;
    while (data1 ) {
        data1 = data2 ;
        testb ( ) ;
    }
    if ( data1 && data2 ) {
        chgb ( ) ;
    }
}
```

**Remark** See "[bit type variables \(bit\)](#), [boolean type variables \(boolean/\\_\\_boolean\)](#)".

### 2.2.5 Empty area of the structure is stuffed

Specify the -rc option to deselect alignment of structure members on 2-byte boundaries. However, there is no support for deselecting alignment of non-structure variables.

### 2.2.6 Data location in internal extended RAM

To locate data in internal extended RAM using C language, specify the data to locate in the alias section and also specify the link directive.

**Example** If you locate the data as follows,

```
#pragma section @@DATA IXDATA
int i;                               /* Data allocated in internal extended RAM */
#pragma section @@DATA @DATA
int j;                               /* Data allocated in High-speed internal RAM */
```

specify the link directive as follows.

```
memory IXRAM : ( 0F400H, 400H )
merge IXDATA := IXRAM
```

**Remark** See "[Changing compiler output section name \(#pragma section ...\)](#)".

## 2.3 Functions

This section explains functions.

### 2.3.1 Allocating to sections accessible with short instructions

Using callt function calls, obtain code that is more compact than the code for normal function calls.

A callt instruction stores the address of the called function in the area [40H - 7FH] called a callt table. And possible to call the function by a short code than the function is called directly.

```
__callt void func1 ( void );
__callt void func1 ( void ) {
    :
    /* Function definition */
    :
}
```

**Remark** See "[callt functions \(callt/ \\_\\_callt\)](#)", "[norec functions \(norec\)](#)" and "[callf functions \(callf/ \\_\\_callf\)](#)".

### 2.3.2 Allocating addresses directly

#### (1) Using section names

Change the compiler output section name and specify a starting address.

Use the #pragma directive to specify the name of the section to be changed, a new name, and the starting address of the new section.

```
#pragma section @@DATA ??DATA AT 0DE00H
int          a1 ;                               // ??DATA
int          a2 ;                               // ??DATA
#pragma section @@DATS ??DATS AT 0FE30H
sreg int     b1 ;                               // ??DATS
sreg int     b2 ;                               // ??DATS
```

**Remark** See "[Changing compiler output section name \(#pragma section ...\)](#)".

### 2.3.3 Inline expansion of function

#pragma inline instructs to generate inline expansion code for memory operation standard library memcpy and memse, instead of calling functions.

If to make the execution faster by expanding other functions inline, there are no instructions which can be inline expansive every function. If the function except memcpy and memset being inline-expansive, define a macro in function format, as shown below.

```
#define MEMCOPY ( a, b, c ) \
{ \
    struct st { unsigned char d[ ( c ) ]; }; \
    * ( ( struct st * ) ( a ) ) = * ( ( struct st * ) ( b ) ); \
}
```

**Remark** See "[Memory manipulation function \(#pragma inline\)](#)".

### 2.3.4 Embedding assembly instructions

Embedding assembly instructions in the assembler source file output by the compiler.

#### (1) #asm - #endasm

#asm marks the start of an assembly source code block, and #endasm marks its end. Write assembly source code between the #asm and #endasm.

```
#asm
    : /* Assembly source */
#endasm
```

[Output assemble file] by [Compile Options] tab of Property panel, set it as "Yes." (See the "CubeSuite 78K0 build" for a setting method.)

**Remark** See "[ASM statements \(#asm - #endasm/ \\_\\_asm\)](#)".

#### (2) \_\_asm

Described by the next form in the C source.

```
__asm ( string literal );
```

Characters in the string literal are interpreted according to the ANSI conventions. Escape sequences, the line continues on the next line by '\ ' character, and concatenate strings can be described.

[Output assemble file] by [Compile Options] tab of Property panel, set it as "Yes." (See the "CubeSuite 78K0 build" for a setting method.)

**Remark** See "[ASM statements \(#asm - #endasm/ \\_\\_asm\)](#)".

### 2.3.5 norec functions and noauto functions is described

No pre/post-processing (stack frame) code is generated for norec and noauto functions.

#### - noauto function

A function can be defined as noauto if the following two conditions are met.

- All the arguments of the function can be assigned to registers according to the rules described in "[3.4.3 noauto function call interface \(only for normal model\)](#)".
- All automatic variables can be assigned to surplus registers and saddr areas<sup>Note</sup> for register variable after arguments are assigned.

```
noauto short  nfunc ( short a, short b, short c );
short  l, m ;

void main ( ) {
    static short ii, jj, kk ;
    l = nfunc ( ii, jj, kk );
}

noauto short  nfunc ( short a, short b, short c ) {
    m = a + b + c ;
    return ( m );
}
```

#### - norec function

A function can be defined as norec if the following three conditions are met.

- The function does not call other functions.
- All the arguments of the function can be assigned to registers and the saddr areas<sup>Note</sup> according to the rules described in "[3.4.4 norec function call interface \(only for normal model\)](#)".
- All the automatic variables are assigned to the surplus registers, saddr areas<sup>Note</sup> for arguments for norec functions and saddr areas<sup>Note</sup> for automatic variables for norec functions.

```
norec int      rout ( int a, int b, int c );

int  i, j ;

void main ( void ) {
    int  k, l, m ;
    i = l + rout ( k, l, m ) + ++k ;
}

norec int      rout ( int a, int b, int c ) {
    int  x, y ;
    return ( x + ( a << 2 ) );
}
```

**Note** The saddr area is only available when the -qr option is specified.

**Remark** See "[noauto functions \(noauto\)](#)" and "[norec functions \(norec\)](#)".

## 2.4 Using Microcontroller Functions

This section explains using microcontroller functions.

### 2.4.1 Accessing special function registers (SFR) from C

#### (1) Setting each register of SFR

The SFR area are a area of group of special function registers, such as mode and control registers for the peripheral hardware of 78K microcontrollers (PM1, P1, TMC80, etc.).

To use the SFR area from C, place the `#pragma sfr` at the start of C source file. This declares the name of each SFR register. The `sfr` keyword can be either uppercase or lowercase.

```
#pragma sfr
```

The following error message appears if attempt to use the SFR area without declaring the register names.

```
E0711 Undeclared 'variable-name' ; function 'function-name'
```

The symbols made available by the `#pragma sfr` directive are the same as the abbreviations given in the list of special function registers.

If `#pragma PC` (processor type) is specified, however, describe `#pragma sfr` after that.

The following items can be described before `#pragma sfr`:

- Comments
- Preprocessor directive which does neither define nor refer to a variable or a function

In the C source, simply use the `sfr` names supported by the target device. The `sfr` names do not need to be declared individually.

SFR names are external variables with no initial values (irregularity).

A compiler error occurs if assign invalid constant data to an SFR name.

**Remark** See "[How to use the sfr area \(sfr\)](#)".

#### (2) Specifying bits in SFR registers

As shown below, specify bits in SFR registers by using reserved names or by using the "register-name.bit-position".

##### Examples 1. Starting TM1

```
TCE1 = 1 ;  
or  
TMC1.0 = 1 ;
```

##### 2. Stopping TM1

```
TCE1 = 0 ;  
or  
TMC1.0 = 0 ;
```

## 2.4.2 Interrupt functions in C

### (1) Interrupt function

The following two directives are provided when the interrupt function is specified.

- #pragma interrupt
- #pragma vect

Either can be used. And the vector table is generated, which can check in the assembler source list output.

Place the #pragma directive at the start of the C source file.

The following items can be described before #pragma directives:

- Comments
- Preprocessor directive which does neither define nor refer to a variable or a function

**Example** Processing for input to INTPO pin

```
#pragma interrupt INTPO inter rbl
void inter ( void ) {
    /* Processing for input to INTPO pin*/
}
```

**Remark** See "[Interrupt functions \(#pragma vect/#pragma interrupt\)](#)".

### (2) Allocating stack area

When using the extended functions for interrupt functions, and do not specify stack switching, the compiler uses the default stack. It does not allocate any extra stack space that be required.

### 2.4.3 Using CPU control instructions in C

#### (1) halt instruction

The halt instruction is one of the standby functions of the microcontroller. To use it, use the #pragma HALT as shown below.

Place the #pragma directive at the start of the C source file.

The following items can be described before #pragma directives:

- Comments
- Preprocessor directive which does neither define nor refer to a variable or a function

In the form similar to the function call, describes it by the uppercase letter in C source as follows.

#### Example Using the halt instruction

```
#pragma HALT
:

void func ( void ) {
:
    HALT ( );
}
```

**Remark** See " [CPU control instruction\(#pragma HALT/STOP/BRK/NOP\)](#)".

#### (2) stop instruction

The stop instruction is one of the standby functions of the microcontroller. To use it, use the #pragma STOP as shown below.

Place the #pragma directive at the start of the C source file.

The following items can be described before #pragma directives:

- Comments
- Preprocessor directive which does neither define nor refer to a variable or a function

In the form similar to the function call, describes it by the uppercase letter in C source as follows.

#### Example Using the stop instruction

```
#pragma STOP
:

void func ( void ) {
:
    STOP ( );
}
```

**Remark** See " [CPU control instruction\(#pragma HALT/STOP/BRK/NOP\)](#)".



**(3) brk instruction**

To use software interrupt of a microcontroller, use the #pragma BRK as shown below.

Place the #pragma directive at the start of the C source file.

The following items can be described before #pragma directives:

- Comments
- Preprocessor directive which does neither define nor refer to a variable or a function

In the form similar to the function call, describes it by the uppercase letter in C source as follows.

**Example** Using the brk instruction

```
#pragma BRK
:

void func ( void ) {
:
    BRK ( );
}
```

**Remark** See " [CPU control instruction\(#pragma HALT/STOP/BRK/NOP\)](#)".

**(4) nop instruction**

The nop instruction advances the clock without operating a microcontroller. To use it, use the #pragma NOP as shown below.

Place the #pragma directive at the start of the C source file.

The following items can be described before #pragma directives:

- Comments
- Preprocessor directive which does neither define nor refer to a variable or a function

In the form similar to the function call, describes it by the uppercase letter in C source as follows.

**Example** Using the nop instruction

```
#pragma NOP
:

void func ( void ) {
:
    NOP ( );
}
```

**Remark** See " [CPU control instruction\(#pragma HALT/STOP/BRK/NOP\)](#)".

## 2.5 Startup Routine

This section explains startup routine.

### 2.5.1 Deleting unused functions and areas from startup routine

#### (1) Deleting the exit function

Delete the exit function by setting the EQU symbol EXITSW in the startup routine to 0.

#### (2) Deleting unused areas

An unused area about the area such as `_@FNCTBL` that a standard library uses can be deleted by confirming the library used, and changing the value of the EQU symbol such as EXITSW in startup routine `cstart.asm`.

The following table lists the controlling EQU symbols and the affected library function names and symbol names.

EQU Symbol	Library Function Name	Symbol Name
BRKSW	brk sbrk malloc calloc realloc free	_errno _@MEMTOP _@MEMBTM _@BRKADR
EXITSW	exit	_@FNCTBL _@FNCENT
RANDSW	rand srand	_@SEED
DIVSW	div	_@DIVR
LDIVSW	ldiv	_@LDIVR
STRTOKSW	strtok	_@TOKPTR
FLOATSW	vatof strtod Math functions Floating point runtime library	_errno

**Remark** See "7.4 Startup Routines".

2.5.2 Allocating stack area

(1) Stack setting

If specify the stack resolution symbol option -s when linking, the symbol `_@STEND` is generated to mark the lowest address in the stack, and the symbol `_@STBEG` is generated to mark the highest address + 1.

```
-sSTACK    <-- Stack area defined by directive
```

Figure 2-1. Stack Setting

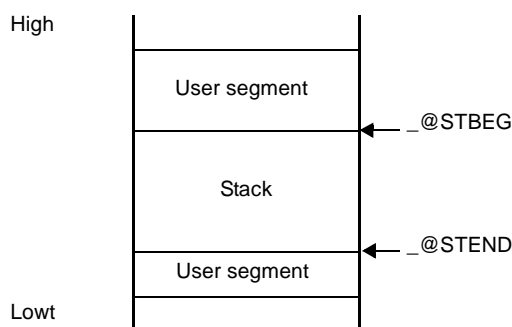

In this case, set the stack pointer as follows.

```
MOVW    SP, #_@STBEG
```

(2) Checking stack area

To check the stack area, specify the linker -kp option to output the public symbol list in the link list file. The stack area is between the `_@STEND` symbol and the `_@STBEG` symbol.

Example Public symbol list

```
*** Public symbol list ***

MODULE  ATTR   VALUE   NAME

        NUM    0FE20H  _@STBEG

        NUM    0FB7EH  _@STEND
```

### 2.5.3 Initializing RAM

In the default startup routine, initial values are copied to the following areas.

- @@INIT segment
- @@INIS segment

The following areas are zero cleared.

- saddr area (0FE20H to 0FEDFH)
- @@DATA segment
- @@DATS segment

If to initialize areas other than the above, add the appropriate initialization processing code to the startup routine.

**Remark** See "[7.4 Startup Routines](#)".

## 2.6 Link Directives

This section explains link directives.

### 2.6.1 Partitioning default areas

Link directives allow to specify names for memory areas that define. However, care is required regarding the location of the special function register (SFR) area.

For example, if define two areas in RAM and specify 1) the name "RAM", which is defined by default, and 2) the user-defined name "STACK", then should make sure that the SFR area is contained within the area named RAM.

#### Example Link directives

```
MEMORY STACK : ( 0EF00H , 00100H )
MEMORY RAM : ( 0F000H , 01000H )
```

**Remark** See "5.1.1 Link directives".

### 2.6.2 Specifying section allocation

#### (1) Specifying areas

When specifying the allocation of a section, can specify a memory area.

Use the MERGE quasi directive to allocate the target section in a memory area.

**Example** Allocate input segment SEG1 to memory area MEM1.

```
MEMORY ROM : ( 0000H , 1000H )
MEMORY MEM1 : ( 1000H , 2000H )
MERGE SEG1 : = MEM1
```

**Remark** See "5.1.1 Link directives".

#### (2) Specifying addresses

When specifying the allocation of a section, can specify addresses.

Use the MERGE quasi directive to specify the allocation address of the target section.

**Example** Allocate input segment SEG1 to address 500H.

```
MEMORY ROM : ( 0000H , 1000H )
MERGE SEG1 : AT ( 500H )
```

**Remark** See "5.1.1 Link directives".

2.7 Reducing Code Size

This section explains techniques for reducing the code size.

2.7.1 Using extended functions to generate efficient object code

When 78K0 application product is developed, 78K0 C compiler generates efficient object code by using the saddr and callt, or callf areas in the device.

- Using external variables

if (saddr area available)       use sreg/\_\_sreg variables/  
or compiler's -rd option

- Using 1 bit data

if (saddr area available)       use bit/boolean/\_\_boolean type variables

- Function definitions

if (frequently called function)

- if (callt area available)
  - Use as \_\_callt/callt function (effective for reducing code size and improving execution speed)
- if (callf area available)
  - Use as \_\_callf/callf function (effective for reducing code size and improving execution speed)
- if (not used recursively)
  - Use as \_\_leaf/norec function

if (automatic variables are not used)
 

- Use as noauto function

if (automatic variables are used &&saddr area is usable)
 

- register declaration

(1) Using external variables

If available in the saddr area when defining external variables, define external variables as sreg/\_\_sreg variables. sreg/\_\_sreg variables are shorter instruction code than the instructions to memory. Object code will be smaller and execution speed will be faster. (Instead of the sreg variables, can use the compiler -rd option.)

```

sreg/__sreg variable define :   extern sreg int   variable-name ;
                               extern __sreg int variable-name ;
    
```

**Remark** See "[How to use the saddr area \(sreg/\\_\\_sreg\)](#)".

**(2) Using 1 bit data**

When using only 1 bit of data, define a bit type (or boolean/\_\_\_boolean type) variable. The compiler generates bit operation instructions to manipulate bit/boolean/\_\_\_boolean type variables. Like sreg variables, they are stored in the saddr area for smaller code and faster execution speed.

```
bit/boolean type variable define : bit          variable-name ;
                                boolean       variable-name ;
                                ___boolean    variable-name ;
```

**Remark** See "[bit type variables \(bit\)](#), [boolean type variables \(boolean/\\_\\_\\_boolean\)](#)".

**(3) Function definitions**

Functions that are called over and over should be written in a way that reduces the size of the object code or modifies the function structure to improve execution speed. When the functions can use the callt area, they should be declared as callt functions. When they can use the callf area, they should be declared as callf functions. callt/callf functions are called by using the callt/callf areas of the device, so they can be called by code that is shorter than normal function calls.

When a function does not call other functions, it can be declared as a \_\_\_leaf/norec function. No pre/post-processing (stack frame) code is generated for norec functions. This reduces the size of the object code and improves execution speed compared to ordinary functions.

```
Definition of callt function : callt  int    tsub ( ) {
                               :
                               }
Definition of norec function : norec  int    tsub ( ) {
                               :
                               }
Definition of callf function : callf  int    tsub ( ) {
                               :
                               }
```

**Remark** See "[callt functions \(callt/\\_\\_\\_callt\)](#)", "[norec functions \(norec\)](#)" and "[callf functions \(callf/\\_\\_\\_callf\)](#)".

**(4) Optimization option**

The following optimization option emphasizes object code size.

```
-qx3, or -qx4
```

Specify the -qx2 (default) option if execution speed is to be emphasized.

-qx4 reduces the code size by "subroutine-ization of a common code" and calling "library for the stack access" in addition to -qx3. Therefore the execution speed has the possibility of slowing compared with -qx3.

Adding the \_\_\_sreg qualifier to variable declarations can reduce code size and improve execution speed. However, this is restricted to the case when space is available in the saddr area. A build error occurs when there is not enough space, and when the saddr area cannot be used.

In addition, object code efficiency can be improved by using the extended functions supported by 78K0 C compiler in C source code.

Without changing the C source code by the thing compiled using optimization option in addition to use in saddr area, it's possible to generate a high-quality object.

### (5) Using extended functions

- Function definitions

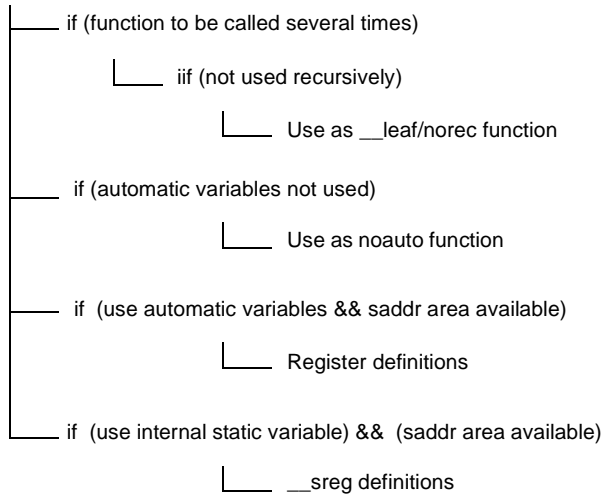

#### (a) Functions that are not used recursively

If a function will be called over and over again, and it will not be called recursively, then it should be defined as a `__leaf/norec` function.

No pre/post-processing (stack frame) code is generated for norec functions. This reduces the size of the object code and improves execution speed compared to ordinary functions.

**Remark** See "[norec functions \(norec\)](#)" and "[3.4.4 norec function call interface \(only for normal model\)](#)" for the definition of norec functions (`norec int rout () ...`).

#### (b) Functions that do not use automatic variables

Functions that do not use automatic variables should be defined as `noauto` functions. No stack frame is generated for notuto function. Their arguments will be passed by registers as much as possible. The size of object code will be reduced and the execution speed will be improved.

**Remark** See "[noauto functions \(noauto\)](#)" or "[3.4.3 noauto function call interface \(only for normal model\)](#)" for the definition of `noauto` function (`noauto int sub1 (int i) ...`).

#### (c) Functions that use automatic variables

When the function for which an automatic variable is used can use `saddr` area, define register. A register definitions allocates a defined object to a register.

Programs that use registers are shorter object and faster execution than programs that use memory.

**Remark** About defining register variables (`register int i ; ...`), see "[Register variables \(register\)](#)".

#### (d) Functions that use internal static variables

When the function for which an internal static variables is used can use `saddr` area, define `__sreg` or specify the `-rs` option. Like `sreg` variables, they are possible to shorter object and faster execution.

**Remark** See "[How to use the saddr area \(sreg/\\_\\_sreg\)](#)".



**(6) Other functions**

Other extended functions allow to generate faster execution or more compact code.

**(a) Use SFR names (or SFR bit names)**

```
#pragma sfr
```

**Remark** See "[How to use the sfr area \(sfr\)](#)".

**(b) \_\_sreg definitions for bit fields of 1-bit members (members can also use unsigned char type)**

```
__sreg struct bf {  
    unsigned char a : 1 ;  
    unsigned char b : 1 ;  
    unsigned char c : 1 ;  
    unsigned char d : 1 ;  
    unsigned char e : 1 ;  
    unsigned char f : 1 ;  
} bf_1 ;
```

**Remark** See "[How to use the saddr area \(sreg/\\_\\_sreg\)](#)".

**(c) Use register bank switching for interrupt routines**

```
#pragma interrupt INTPO inter RB1
```

**Remark** See "[Interrupt functions \(#pragma vect/#pragma interrupt\)](#)".

**(d) Use of multiplication, division embedded function**

```
#pragma mul
```

```
#pragma div
```

**Remark** See "[Multiplication function \(#pragma mul\)](#)", [Division function \(#pragma div\)](#)".

**(e) Described by assembly language to be faster modules.**

### 2.7.2 Calculating complex expressions

The following example shows the most reasonable way to calculate an expression whose result will always fit into byte type, even when intermediate results require double word type.

**Example** Find the rounded percentage C of B in A.

$$C = ( A \times 100 + B \div 2 ) \div B$$

In a function like the following, the variable for the result C must be defined as a long int, requiring 4 bytes of area when a single byte would have been enough.

```
void _x ( ) {  
    c = ( ( unsigned long int ) a * ( unsigned long int ) 100 + ( unsigned long int  
    ) b / ( unsigned long int ) 2 ) / ( unsigned long int ) b ;  
}
```

This can be written as follows, if using double word type for intermediate results only.

```
#pragma mul  
#pragma div  
unsigned int    a, b ;  
unsigned char   c ;  
  
void _x ( ) {  
    c = ( unsigned char ) divux ( ( unsigned long ) ( b / 2 ) + muluw ( a, 100 ) , b  
);  
}
```

## 2.8 Compiler and Assembler Mutual References

This section explains compiler and assembler mutual references.

### 2.8.1 Mutually referencing variables

#### (1) Reference a variable defined in C language

To reference a extern variable defined in a C program from an assembly language routine, define extern. Prefix the name of the variable with an underscore (\_) in the assembly language module.

#### Example C source

```
extern void subf ( void );
char    c = 0 ;
int     i = 0 ;

void main ( void ) {
    subf ( );
}
```

#### Example Assembly source

```
$PROCESSOR ( F051144 )

    PUBLIC  _subf
    EXTRN  _c
    EXTRN  _i

@@CODE CSEG
_subf :
    MOV    a , #04H
    MOV    !_c , a
    MOVW   ax , #07H ; 7
    MOVW   !_i , ax
    RET
    END
```

**Remark** See "[9.5 Referencing Variables Defined in C Language](#)".

**(2) Reference a variable defined in assembly language**

To reference a extern variable defined in an assembly language program from a C routine, define extern. Prefix the name of the variable with an underscore (\_) in the assembly language routine.

**Example** C source

```
extern char    c ;
extern int     i ;

void subf ( void ) {
    c = ' A ' ;
    i = 4 ;
}
```

**Example** Assembly source

```
NAME ASMSUB
                PUBLIC  _i
                PUBLIC  _c
ABC DSEG        BASEP
_i : DW         0
_c : DB         0
                END
```

**Remark** See "[9.6 Referencing Variables Defined in Assembly Language from C Language](#)".

## 2.8.2 Mutually referencing functions

**(1) Reference a function defined in C language**

The following procedure is used to call functions written in C from assembly language routines.

- (a) Save the C work registers (AX, BC, DE)**
- (b) Push the arguments on the stack**
- (c) Call the C function**
- (d) Adjust the stack pointer (SP) by the byte length of the arguments**
- (e) Reference the return value of the C function (BC, or DE, BC)**

**Example** Assembly language

```

$PROCESSOR ( F051144 )
    NAME     FUNC2
    EXTRN   _CSUB
    PUBLIC  _FUNC2
@@CODE CSEG
_FUNC2 :
    movw   ax, #20H           ; set 2nd argument ( j )
    push  ax                  ;
    movw   ax, #21H           ; set 1st argument ( i )
    call  !_CSUB              ; call "CSUB ( i, j )"
    pop   ax                  ;
    ret
END

```

See "[9.4 Calling C Language Routines from Assembly Language](#)".

**(2) Reference a function defined in assembly language**

Functions defined in assembly language to be called from C functions perform the following processing.

- (a) Save the base pointer and saddr area for register variables**
- (b) Copy the stack pointer (SP) to the base pointer (HL)**
- (c) Perform the processing of the function FUNC**
- (d) Set the return value**
- (e) Restore the saved registers**

## (f) Return to the function main

**Example** Assembly language

```

$PROCESSOR ( F051144 )
    PUBLIC _FUNC
    PUBLIC _DT1
    PUBLIC _DT2
@@DATA DSEG UNITP
_DT1 : DS ( 2 )
_DT2 : DS ( 4 )
@@CODE CSEG
_FUNC :
    PUSH    HL            ; save base pointer
    PUSH    AX
    MOVW    AX , SP      ; copy stack pointer
    MOVW    HL , AX
    MOV     A , [ HL ]   ; arg1
    XCH     A , X
    MOV     A , [ HL + 1 ] ; arg1
    MOVW    !_DT1 , AX   ; move 1st argument ( i )
    MOV     A , [ HL + 8 ] ; arg2 (add 6 to the offset when the argument is
                        ; in the bank area)
    XCH     A , X
    MOV     A , [ HL + 9 ] ; arg2 (add 6 to the offset when the argument is
                        ; in the bank area)
    MOVW    !_DT2 + 2 , AX
    MOV     A , [ HL + 6 ] ; arg2 (add 6 to the offset when the argument is
                        ; in the bank area)
    XCH     A , X
    MOV     A , [ HL + 7 ] ; arg2 (add 6 to the offset when the argument is
                        ; in the bank area)
    MOVW    !_DT2 , AX   ; move 2nd argument ( l )
    MOVW    BC , #0AH    ; set return value
    POP     AX
    POP     HL            ; restore base pointer
    RET
    END

```

See "9.3 Calling Assembly Language Routines from C Language".

### 2.8.3 When the assembler calls functions written in C, registers must be saved

When the assembler calls a function written in C, the following registers must be saved.

hl register	Saved on the side of the C function.
ax, bc, de register	These are work registers, so they may be used by the C function.

Save the above registers on the assembler side before calling the function.

**Example** Save ax, bc, and de registers before calling `_c_function`.

```
push    ax
push    bc
push    de
call    !_c_function    ; Function written in C
pop     de
pop     bc
pop     ax
```

See "[CHAPTER 9 REFERENCING COMPILER AND ASSEMBLER](#)" for the details.

## CHAPTER 3 COMPILER LANGUAGE SPECIFICATIONS

This chapter explains the language specifications supported by 78K0 C compiler.

### 3.1 Basic Language Specifications

The C compiler supports the language specifications stipulated by the ANSI standards. These specifications include items that are stipulated as processing definitions. This chapter explains the language specifications of the items dependent on the processing system of the micro processors for 78K0 microcontrollers.

The differences between when options strictly conforming to the ANSI standards are used and when those options are not used are also explained.

See "3.3 [Extended Language Specifications](#)" for extended language specifications explicitly added by 78K0 C compiler.

#### 3.1.1 Processing system dependent items

This section explains items dependent on processing system in the ANSI standards.

##### (1) Data types and sizes

The byte order in multibyte data types is "from least significant to most significant byte" Signed integers are expressed by 2's complements. The sign is added to the most significant bit (0 for positive or 0, and 1 for negative).

- The number of bits of 1 byte is 8.
- The number of bytes, byte order, and encoding in an object files are stipulated below.

**Table 3-1. Data Types and Sizes**

Data Types	Sizes
char	1 byte
int, short	2 bytes
long, float, double	4 bytes
Pointer	Pointer variable (except function pointers when using bank function (-mf) ): 2 bytes Function pointers (when using bank function (-mf) ): 4 bytes

##### (2) Translation stages

The ANSI standards specify eight translation stages (known as "phases" ) of priorities among syntax rules for translation. The arrangement of "non-empty white space characters excluding line feed characters" which is defined as processing system dependent in phase 3 "Decomposition of source file into preprocessing tokens and white space characters" is maintained as it is without being replaced by single white space character.

However, tabs are replaced by the space character specified with the -lt option.

##### (3) Diagnostic messages

When syntax rule violation or restriction violation occurs on a translation unit, the compiler outputs as error message containing source file name and (when it can be determined) the number of line containing the error.

These error messages are classified into three types: "alarm", "fatal error", and "other error" messages.



**(4) Free standing environment**

- (a) The name and type of a function that is called on starting program processing are not stipulated in a free-standing environment<sup>Note</sup>. Therefore, it is dependent on the user-own coding and target system.

**Note** Environment in which a C Language source program is executed without using the functions of the operating system.

In the ANSI Standard two environments are stipulated for execution environment: a free-standing environment and a host environment. The 78K0 C compiler does not supply a host environment at present.

- (b) The effect of terminating a program in a free-standing environment is not stipulated. Therefore, it is dependent on the user-own coding and target system.

**(5) Program execution**

The configuration of the interactive unit is not stipulated.

Therefore, it is dependent on the user-own coding and target system.

**(6) Character set**

The values of elements of the execution environment character set are ASCII codes.

**(7) Multi-byte characters**

Multi-byte characters are not supported by character constants and character strings.

However, Japanese description in comments is supported.

**(8) Significance of character display**

The values of expanded notation are stipulated as follows.

**Table 3-2. Expanded Notation and Meaning**

Expanded Notation	Value (ASCII)	Meaning
\a	07	Alert (Warning tone)
\b	08	Backspace
\f	0C	Form feed (New Page)
\n	0A	New line (Line feed)
\r	0D	Carriage return (Restore)
\t	09	Horizontal tab
\v	0B	Vertical tab

**(9) Translation Limit**

The limit values of translation are explained below.

The values marked with \* are guaranteed values. These values may be exceeded in some cases, but the operation is not guaranteed.

Table 3-3. Translation Limit Values

Contents	Limit Values
Number of nesting levels of compound statements, repetitive control structures, and selective control structures (However, dependent on the number of "case" labels)	45
Number of nesting levels of condition embedding	255
Number of pointers, arrays, and function declarators (in any combination) qualifying one arithmetic type, structure type, union type, or incomplete type in one declaration	12
Number of nesting levels enclosed by parentheses in a complete declarator	591*
Number of nesting levels of an expression enclosed by parentheses in a complete expression	32
Valid number of first characters in a macro name	256
Valid number of first characters of an external identifier	249
Valid number of first characters in an internal identifier	249
Number of identifiers having an external identifier in one translation unit	1024*
Number of identifiers having the valid block range declared in one basic block	255
Number of macro identifiers simultaneously defined in one translation unit	32767
Number of dummy arguments in one function definition and number of actual arguments in one function call	39*
Number of dummy arguments in one macro definition	31
Number of actual arguments in one macro call	31
Number of characters in one logical source line	2048*
One character string constant after concatenation, or number of characters in a wide character string constant	509*
Object size of 1-file (Data is indicated)	65535
Number of nesting levels for include (#include) files	50
Number of "case" labels for one "switch" statement (including those nested, if any)	257
Number of source lines per compilation unit	65535*
Number of nested function calls	40*
Total size of code, data, and stack segments in a single object module	65535
Number of members of a single structure or single union	256
Number of enumerate constants in a single enumerate type	255
Number of nesting levels of a structure or union definition in the arrangement of a single structure declaration	15
Nesting of initializer elements	15
Number of function definitions in a single source file	4095
Macro nesting	200
Number of include file paths	64

## (10) Quantitative limit

## (a) The limit values of the general integer types (limits.h file)

The limits.h file specifies the limit values of the values that can be expressed as general integer types (char type, signed/unsigned integer type, and enumerate type).

Because multibyte characters are not supported, MB\_LEN\_MAX does not have a corresponding limit.

Consequently, it is only defined with MB\_LEN\_MAX as 1.

If a -qu option is specified, CHAR\_MIN is 0, and CHAR\_MAX takes the same value as UCHAR\_MAX. The limit values defined by the limits.h file are as follows.

Table 3-4. Limit Values of General Integer Type (limits.h File)

Name	Value	Meaning
CHAR_BIT	+8	The number of bits (= 1 byte) of the minimum object not in bit field
SCHAR_MIN	-128	Minimum value of signed char
SCHAR_MAX	+127	Maximum value of signed char
UCHAR_MAX	+255	Maximum value of unsigned char
CHAR_MIN	-128	Minimum value of char
CHAR_MAX	+127	Maximum value of char
SHRT_MIN	-32768	Minimum value of short int
SHRT_MAX	+32767	Maximum value of short int
USHRT_MAX	+65535	Maximum value of unsigned short int
INT_MIN	-32768	Minimum value of int
INT_MAX	+32767	Maximum value of int
UINT_MAX	+65535	Maximum value of unsigned int
LONG_MIN	-2147483648	Minimum value of long int
LONG_MAX	+2147483647	Maximum value of long int
ULONG_MAX	+4294967295	Maximum value of unsigned long int

## (b) The limit values of the floating-point type (float.h file)

The limit values related to characteristics of the floating-point type are defined in float.h file.

The limit values defined by the float.h file are as follows.

Table 3-5. Definition of Limit Values of Floating-point Type (float.h File)

Name	Value	Meaning
FLT_ROUNDS	+1	Rounding mode for floating-point addition. 1 for the 78K0 microcontrollers (rounding in the nearest direction).
FLT_RADIX	+2	Radix of exponent (b)
FLT_MANT_DIG	+24	Number of numerals (p) with FLT_RADIX of floating-point mantissa as base
DBL_MANT_DIG		
LDBL_MANT_DIG		

Name	Value	Meaning
FLT_DIG	+6	Number of digits of a decimal number <sup>Note 1</sup> (q) that can round a decimal number of q digits to a floating-point number of p digits of the radix b and then restore the decimal number of q
DBL_DIG		
LDBL_DIG		
FLT_MIN_EXP	-125	Minimum negative integer ( $e_{min}$ ) that is a normalized floating-point number when FLT_RADIX is raised to the power of the value of FLT_RADIX minus 1.
DBL_MIN_EXP		
LDBL_MIN_EXP		
FLT_MIN_10_EXP	-37	Minimum negative integer $\log_{10} b^{e_{min}-1}$ that falls in the range of a normalized floating-point number when 10 is raised to the power of its value.
DBL_MIN_10_EXP		
LDBL_MIN_10_EXP		
FLT_MAX_EXP	+128	Maximum integer ( $e_{max}$ ) that is a finite floating-point number that can be expressed when FLT_RADIX is raised to the power of its value minus 1.
DBL_MAX_EXP		
LDBL_MAX_EXP		
FLT_MAX_10_EXP	+38	Maximum value of finite floating-point numbers that can be expressed $(1 - b^{-p}) * b^{e_{max}}$
DBL_MAX_10_EXP		
LDBL_MAX_10_EXP		
FLT_MAX	3.40282347E + 38F	Maximum value of finite floating-point numbers that can be expressed $(1 - b^{-p}) * b^{e_{max}}$
DBL_MAX		
LDBL_MAX		
FLT_EPSILON	1.19209290E - 07F	Difference <sup>Note 2</sup> between 1.0 that can be expressed by specified floating-point number type and the lowest value which is greater than 1. $b^{1-p}$
DBL_EPSILON		
LDBL_EPSILON		
FLT_MIN	1.17549435E - 38F	Minimum value of normalized positive floating-point number $b^{e_{min}-1}$
DBL_MIN		
LDBL_MIN		

- Notes 1.** DBL\_DIG and LDBL\_DIG are 10 or more in the ANSI standards but are 6 in the 78K0 microcontrollers because both the double and long double types are 32 bits.
- 2.** DBL\_EPSILON and LDBL\_EPSILON are 1E-9 or less in the ANSI standards, but 1.19209290E-07F in the 78K0 microcontrollers.

#### (11) Identifier

The initial 249 characters of identifiers are recognized.  
Uppercase and lowercase characters are distinguished.

**(12)char type**

A char type with no type specifier (signed, unsigned) specified is treated as a signed integer as the default assumption.

However, a simple char type can be treated as an unsigned integer by specifying the -qi option of the C compiler. The types of those that are not included in the character set of the source program required by the ANSI standards (escape sequence) is converted for storage, in the same manner as when types other than char type are substituted for a char type.

```
char    c = '\777' ;    /* Value of c is -1 */
```

**(13)Floating-point constants**

The floating-point constants conform to IEEE754<sup>Note</sup>.

**Note** IEEE:Institute of Electrical and Electronics Engineers

Moreover, IEEE754 is a standard to unify specifications such as the data format and numeric range in systems that handle floating-point operations.

**(14)Character constants**

- (a) Both the character set of the source program and the character set in the execution environment are basically ASCII codes, and correspond to members having the same value.
- (b) The last character of the value of an integer character constant including two or more characters is valid.
- (c) A character that cannot be expressed by the basic execution environment character set or escape sequence is expressed as follows.

<1> An octal or hexadecimal escape sequence takes the value indicated by the octal or hexadecimal notation

\077	63
------	----

<2> The simple escape sequence is expressed as follows.

\'	'
\"	"
\?	?
\\	\

<3> Values of \a, \b, \f, \n, \r, \t, \v are same as the values explained in "(8) Significance of character display".

(d) Character constants of multi byte characters are not supported.

**(15)Header file name**

The method to reflect the string in the two formats (<> and " ") of a header file name on the header file or an external source file name is stipulated in "(32) Loading header file".

**(16) Comment**

A comment can be described in Japanese. The default character code set for Japanese is Shift JIS.

The character code set of the input source file can be specified by the compiler's -z option, or by an environmental variable. An option specification takes priority over an environment variable specification. However, character codes are not guaranteed when "none" is specified.

**(a) Option specification**

```
-ze | -zn | -zs
```

**(b) Environment variable**

```
LANG78K [ euc | none | sjis ]
```

To set environment variables, use the standard procedure for environment.

**(17) Signed constants and unsigned constants**

If the value of a general integer type is converted into a signed integer of a smaller size, the higher bits are truncated and a bit string image is copied.

If an unsigned integer is converted into the corresponding signed integer, the internal representation is not changed.

**(18) Floating-points and general integers**

If the value of a general integer type is converted into the value of a floating-point type, and if the value to be converted is within a range that can be expressed but not accurately, the result is rounded to the closest expressible value.

When the result is just a middle value, it can be rounded to the even number (with the least significant bit of the mantissa being 0).

**(19) double type and float type**

In the 78K0 C compiler, a double type is expressed as a floating-point number in the same manner as a float type, and is treated as 32-bit (single-precision) data

**(20) Signed type in operator in bit units**

The characteristics of the shift operator conform to the stipulation in [\(26\) Shift operator in bit units](#).

The other operators in bit units for signed type are calculated as unsigned values (as in the bit imag.

**(21) Members of structures and unions**

If the value of a member of a union is stored in a different member, it is stored according to an alignment condition. Therefore, the members of that union are accessed according to the alignment condition (see [\(b\) Structure type](#) and [\(c\) Union type](#)).

In the case of a union that includes a structure sharing the arrangement of the common first members as a member, the internal representation is the same, and the result is the same even if the first member common to any structure is referred.

**(22) sizeof operator**

The value resulting from the "sizeof" operator conforms to the stipulation related to the bytes in an object in [\(1\) Data types and sizes](#).

For the number of bytes in a structure and union, it is byte including padding area.

**(23) Cast operator**

When a pointer is converted into a general integer type, the required size of the variable is the same as the following table lists. The bit string is saved as is as the conversion result.

Any integer can be converted by a pointer. However, the result of converting an integer smaller than an int type is expanded according to the type.

Pointer variable (except function pointers when using bank function (-mf) )	2 bytes
Function pointers (when using bank function (-mf) )	4 bytes

**(24) Division/remainder operator**

The result of the division operator ("/") when the operands are negative and do not divide perfectly with integer division, is as follows: If either the divisor or the dividend is negative, the result is the smallest integer greater than the algebraic quotient.

If both the divisor and the dividend are negative, the result is the largest integer less than the algebraic quotient.

If the operand is negative, the result of the "%" operator takes the sign of the first operand in the expression.

**(25) Addition and subtraction operators**

If two pointers indicating the elements of the same array are subtracted, the type of the result is int type, and the size is 2 bytes.

**(26) Shift operator in bit units**

If E1 of "E1 >> E2" is of signed type and takes a negative value, an arithmetic shift is executed.

**(27) Storage area class specifier**

The storage area class specifier "register" is declared to increase the access speed as much as possible, but this is not always effective.

**(28) Structure and union specifier**

**(a) int type bit field sign Simple int type bit fields without a signed or unsigned specifier are treated as unsigned.**

**(b) To retain a bit field, a storage area unit to which any address with sufficient size can be assigned can be allocated. If there is insufficient area, however, the bit field that does not match is packed into to the next unit according to the alignment condition of the type of the field.**

**(c) The allocation sequence of the bit field in unit is from lower to higher. However, the -rb option can be specified for the allocation sequence is from higher to lower.**

**(d) Each member of the non-bit field of one structure or union is aligned at a boundary as follows**

cchar and unsigned char types, and arrays of char and unsigned char types	Byte boundary
Other (including pointers)	2-byte boundary

**(29) Enumerate type specifier**

The type of an enumeration is the first type from among the following which is capable of expressing all of the enumeration constants.

- signed char
- unsigned char
- signed int

**(30) Type qualifier**

The configuration of access to data having a type qualified to be "volatile" is dependent upon the address (I/O port, etc.) to which the data is mapped.

**(31) Condition embedding**

- (a) The value for the constant specified for condition embedding and the value of the character constant appearing in the other expressions are equal.**
- (b) The character constant of a single character must not have a negative value.**

**(32) Loading header file****(a) A preprocessing directive in the form of "#include <character string>"**

Unless "filename" begins with the character "\" <sup>Note</sup> the #include <filename> preprocessor directive instructs the preprocessor to search for the file specified between the angle brackets (<..>) in the following locations: 1) the folder specified by the -i option, 2) the folder specified by the INC78K0 environment variable, and 3) the ..\inc78k0 folder relative to the bin folder where cc78k0.exe resides.

If a header file uniformly identified is searched with a character string specified between delimiters "<" and ">", the whole contents of the header file are replaced.

**Note** Both "\" and "/" are regarded as the delimiters of a folder.

**Example**

```
#include <header.h>
```

The search order is as follows.

- The folder specified by the -i option
- The folder specified by the INC78K0 environment variable
- The standard folder

**(b) A preprocessing directive in the form of "#include "character string" "**

Unless "character string" begins with the character "\" <sup>Note</sup>, the #include "character string" preprocessor directive instructs the preprocessor to search for the file specified between the quotation marks ("..") in the following locations: 1) the folder that contains the source file, 2) the folder specified by the -i option, 3) the folder specified by the INC78K0 environment variable, and 4) the ..\inc78k0 folder relative to the bin folder where cc78k0.exe resides.

If the file specified between the quotation mark delimiters is found, the #include directive line is replaced with the entire contents of the file.

**Note** Both "\" and "/" are regarded as the delimiters of a folder.



**Example**

```
#include "header.h"
```

The search order is as follows.

- The folder that contains the source file
- The folder specified by the -i option
- The folder specified by the INC78K0 environment variable
- The standard folder

**(c) The format of "#include preprocessing character phrase string"**

The format of "#include preprocessing character phrase string" is treated as the preprocessing character phrase of single header file only if the preprocessing character phrase string is a macro that is replaced to the form of <character string> or "character string".

**(d) A preprocessing directive in the form of "#include <character string>"**

Between a string delimited (finally) and a header file name, the length of the alphabetic characters in the strings is identified,

And the file name length valid in the compiler operating environment is valid.

The folder that searches a file conforms to the above stipulation.

**(33)#pragma directive**

#pragma directives are one of the preprocessing directive types defined by the ANSI standard. The string that follows #pragma the compiler to translate in an implementation-defined manner.

When a #pragma directive is not recognized by the compiler, it is ignored and translation continues. If the directive adds a keyword, then an error occurs if the C source contains that keyword. To avoid the error, delete the keyword from the source or exclude it with #ifdef.

**(34)Predefined macro names**

All the following macro names are supported.

Macros not ending with "\_\_" are supplied for the sake of former C language specifications (K&R specifications).

To perform processing strictly conforming to the ANSI standards, use macros with "\_\_" before and after.

**Table 3-6. List of Supported Macros**

Macro Name	Definition
__LINE__	Line number of source line at that point (decimal).
__FILE__	Name of assumed source file (character string constant).
__DATE__	Date of translating source file (character string constant in the form of "Mmm dd yyyy" ). Here, the name of the month is the same as that created by the asctime function stipulated by ANSI standards (3 alphabetic characters with only the first character is capital letter) (The first character of dd is blank if its value is less than 10).
__TIME__	Translation time of source file (character string constant having format "hh:mm:ss" similar to the time created by the asctime function).
__STDC__	Decimal constant 1, indicating conformance to the ANSI standard. <sup>Note</sup>

Macro Name	Definition
__K0__	Decimal constant 1
__STATIC_MODEL__	Decimal constant 1 (when static model is specified).
__CHAR_UNSIGNED__	Decimal constant 1 (When the -qu option was specified.)
CPUmacro	Decimal constant 1 of a macro indicating the target CPU. A character string indicated by "product type specification" in the device file with "__" prefixed and suffixed is defined.

**Note** Defined when the -za option is specified

### (35) Definition of special data type

NULL, size\_t, and ptrdiff\_t defined by stddef.h file are as follows.

**Table 3-7. Definition of NULL, size\_t, ptrdiff\_t (stddef.h File)**

NULL/size_t/ptrdiff_t	Definition
NULL	((void *) 0)
size_t	unsigned int
ptrdiff_t	int

## 3.2 Environment During Compilation

This section explains how the C compiler handles data, registers, device specifications and the environment during execution.

### 3.2.1 Internal representation and value area of data

This section explains the internal representation and value area of each type for the data handled by the 78K0 C compiler.

#### (1) Basic types

The basic types, also called arithmetic types, consist of the integer types and the floating point types.

The integer types can be classified into the char type, signed integer types, unsigned integer types, and enumeration type.

##### (a) Integer types

Integer types can be divided into 4 categories, as follows. Integer types are expressed as binary 0s and 1s.

- char type
- signed integer types
- unsigned integer types
- enumeration types

##### <1> char type

The char type is large enough to store any member of the execution character set.

If a member of the basic execution character set is stored in a char object, its value is guaranteed to be nonnegative.

Objects other than characters are treated as signed integers.

If an overflow occurs when a value is stored, the overflow part is ignored.

**<2> Signed integer types**

There are four signed integer types, as follows.

- signed char
- short int
- int
- long int

An object defined as signed char type occupies the same amount of area as a "plain" char.

A "plain" int has the natural size suggested by the CPU architecture of the execution environment.

For each of the signed integer types, there is a corresponding unsigned integer type that uses the same amount of area.

The positive number of a signed integer type is a subset of the the unsigned integer type.

**<3> Unsigned integer types**

Unsigned integer types are designated by the keyword "unsigned".

A computation involving unsigned integer types can never overflow, because a result that cannot be represented by the resulting unsigned integer type is reduced modul the number that is one greater than the largest value that can be represented by the resulting type.

**<4> Enumeration types**

An enumeration comprises a set of named integer constant values.

Each distinct enumeration constitutes a different enumerated type.

Each enumeration constitutes a enumerated type.

**(b) Floating point types**

There are three real floating types, as follows.

- float
- double
- long double

Like the float type, the double and long double types of 78K0 C compiler are supported as floating point representations of the single-precision normalized numbers defined in ANSI/IEEE 754-1985. This means that the float, double, and long double types have the same value range.

**Table 3-8. Value Ranges by Type**

Type	Value Range
(signed) char	-128 to +127
unsigned char	0 to 255
(signed) short int	-32768 to +32767
unsigned short int	0 to 65535
(signed) int	-32768 to +32767
unsigned int	0 to 65535
(signed) long int	-2147483648 to +2147483647
unsigned long int	0 to 4294967295
float	1.17549435E - 38F to 3.40282347E + 38F
double	1.17549435E - 38F to 3.40282347E + 38F
long double	1.17549435E - 38F to 3.40282347E + 38F

- Remarks 1. The "signed" type specifier may be omitted. However, when it is omitted for the char type, a compiling condition (option) determines whether the type is the signed char or unsigned char type.
- 2. The short int and int types have the same value range, but they are treated as different types.
- 3. The unsigned short int and unsigned int types have the same value range, but they are treated as different types.
- 4. The float, double, and long double types have the same value range, but they are treated as different types.
- 5. The ranges of the float, double, and long double types are ranges of absolute values.

The following show the specifications of floating point numbers (float type).

<1> Format

The floating point number format is shown below.

Figure 3-1. Floating Point Number Format



Numerical values in this format are as follows.

$$\begin{matrix}
 \text{(Value of sign)} & \text{(Value of exponent)} \\
 ( -1 ) & * \text{(Value of mantissa)} * 2
 \end{matrix}$$

s	Sign (1 bit) 0 for a positive number and 1 for a negative number.																		
e	Exponent (8 bits) A base-2 exponent is expressed as a 1-byte integer (expressed by 2's complement in the case of a negative), after the further addition of a bias of 7FH. These relationships are shown in the table below.																		
<table border="1"> <thead> <tr> <th>Exponent (Hexadecimal)</th> <th>Value of Exponent</th> </tr> </thead> <tbody> <tr> <td style="text-align: center;">FE</td> <td style="text-align: center;">127</td> </tr> <tr> <td style="text-align: center;">:</td> <td style="text-align: center;">:</td> </tr> <tr> <td style="text-align: center;">81</td> <td style="text-align: center;">2</td> </tr> <tr> <td style="text-align: center;">80</td> <td style="text-align: center;">1</td> </tr> <tr> <td style="text-align: center;">7F</td> <td style="text-align: center;">0</td> </tr> <tr> <td style="text-align: center;">7E</td> <td style="text-align: center;">-1</td> </tr> <tr> <td style="text-align: center;">:</td> <td style="text-align: center;">:</td> </tr> <tr> <td style="text-align: center;">01</td> <td style="text-align: center;">-126</td> </tr> </tbody> </table>		Exponent (Hexadecimal)	Value of Exponent	FE	127	:	:	81	2	80	1	7F	0	7E	-1	:	:	01	-126
Exponent (Hexadecimal)	Value of Exponent																		
FE	127																		
:	:																		
81	2																		
80	1																		
7F	0																		
7E	-1																		
:	:																		
01	-126																		
m	Mantissa (23 bits) The mantissa is expressed as an absolute value, with bit positions 22 to 0 equivalent to the 1st to 23rd places of a binary number. Except for when the value of the floating point is 0, the value of the exponent is always adjusted so that the mantissa is within the range of 1 to 2 (normalization). The result is that the position of 1 (i.e. the value of 1) is always 1, and is thus represented by omission in this format.																		

<2> **Expression of zero**

When exponent = 0 and mantissa = 0, ± 0 is expressed as follows.

$$\begin{matrix} & \text{(Value of sign)} & \\ \text{( -1 )} & & * 0 \end{matrix}$$

<3> **Expression of infinity**

When exponent = FFH and mantissa = 0, ± ∞ is expressed as follows.

$$\begin{matrix} & \text{(Value of sign)} & \\ \text{( -1 )} & & * \infty \end{matrix}$$

<4> **Denormalized values**

When exponent = 0 and mantissa ≠ 0, the denormalized value is expressed as follows.

$$\begin{matrix} & \text{(Value of sign)} & & -126 & \\ \text{( -1 )} & & * & \text{(Value of mantissa)} & * 2 \end{matrix}$$

**Remark** The mantissa value here is a number less than 1, so bit positions 22 to 0 of the mantissa express the 1st to 23rd decimal places.

<5> **Expression of NaN (Not-a-number)**

When exponent = FFH and mantissa ≠ 0, NaN is expressed, regardless of the sign.

<6> **Rounding of computation results**

Numerical values are rounded down to the nearest even number. If the computation result cannot be expressed in the above floating point format, round to the nearest expressible number. If there are 2 values that can express the differential of the prerounded value, round to an even number (a number whose least significant binary bit is 0).

<7> **Exceptions**

There are 5 types of exceptions, as shown in the table below.

**Table 3-9. Numerical Exception**

Exception	Return Value
Underflow	Denormalized number
Inexact	± 0
Overflow	± ∞
Division by zero	± ∞
Invalid operation	NaN

When an exception occurs, calling the matherr function causes a warning to appear.

**(2) Character types**

There are 3 char data types.

- char
- signed char
- unsigned char

**(3) Incomplete types**

There are 4 incomplete data types.

- Arrays with indefinite object size
- Structures
- Unions
- void type

**(4) Derived types**

There are 5 derived data types.

- Array type
- Structure type
- Union type
- Function type
- Pointer type

**(a) Array type**

An array type describes a contiguously allocated set of objects with a particular member object type, called the element type.

All member objects have the area of the same size. Array types and individual elements can be specified. It is not possible to create an incomplete array type.

**(b) Structure type**

A structure type describes a sequentially allocated set of member objects, each of which has an optionally specified name and possibly a distinct type.

**Remark** Array and structure types are collectively called aggregate types. The member objects in aggregate types are allocated sequentially.

**(c) Union type**

A union type describes an overlapping set of member objects.

Each member of a union has an optionally specified name and possibly a distinct type. Union members can be specified individually.

**(d) Function type**

A function type describes a function with the return value of the specified type.

A function type is characterized by its return value type and the number and types of its parameters.

If its return value type is T, the function is called a "function returning T".

**(e) Pointer type**

A pointer type may be derived from a function type, an object type, or an incomplete type, called the referenced type.

A pointer type describes an object whose value provides a reference to an entity of the referenced type.

A pointer type derived from the referenced type T is sometimes called a "pointer to T".

3.2.2 Memory

The memory model is determined by the memory space of the target device.

(1) Memory models

The memory model refers to 64K in total with the code and data section because the memory space is at most 64K Byte. If the bank function is used, more than 64K is allowed only for the code section.

(2) Register banks

- The current register bank is set to "RB0" by the 78K0 C compiler startup routine. Unless it is changed, it remains set to register bank 0.
- It's set as a specified register bank at the start of the interrupt function where register bank change designation was done.

(3) Memory space

78K0 C compiler utilizes the following memory space.

(a) Normal model

Figure 3-2. Utilization of Memory Space (Normal Model)

Address		Use		Size (bytes)
00	40 - 7FH	CALLT table		64
0800 - 0FFFH		CALLF entry		2048
FE	20 - B7H	sreg variables, boolean variables		152
FE	B8 - BFH	Arguments of runtime library		8
FE	C0 - C7H	Arguments of norec functions		8
FE	C8 - CFH	Automatic variables of norec functions		8
FE	D0 - DFH	Register variables		16
FE	E0 - F7H	RB3-RB1	Work registers <sup>Note</sup>	24
	F8 - FFH	RB0	Work registers	8
FF	00 - FFH	sfr variables		256

**Note** Used when the register bank is specified.

## (b) Static model (at -sm16 specification)

Figure 3-3. Utilization of Memory Space (Static Model)

Address		Use		Size (bytes)
00	40 - 7FH	CALLT table		64
0800 - 0FFFH		CALLF entry		2048
FE	20 - CFH	sreg variables, boolean type variables		176
FE	D0 - D7H	Shared area <sup>Note 2</sup>		16
FE	Consecutive areas between 20 and DFH	For arguments, automatic variables, and work <sup>Note 3</sup>		8
FE	E0 - F7H	RB3-RB1	Work registers <sup>Note</sup>	24
	F8 - FFH	RB0	Work registers	8
FF	00 - FFH	sfr variables		256

- Notes**
1. Used when the register bank is specified.
  2. The area where the compiler uses change with the parameter of the -sm.  
Areas not used as shared area can be utilized as sreg variables or boolean type variables.
  3. Only available when the static model extended option (-zm) is specified.

### 3.3 Extended Language Specifications

This section explains extensions unique to the 78K0 C compiler, which are not specified by the ANSI (American National Standards Institute) standard.

The 78K0 C compiler extensions allow to generate code that makes the most effective use of the target device. These extensions are not necessarily useful in every situation, so recommended to use only those which are useful for purposes. For more information about effective use of the 78K0 C compiler extensions, see "[CHAPTER 2 FUNCTIONS](#)".

Use of the 78K0R C compiler extensions introduces microcontroller dependencies into C source programs, but compatibility on the C language level is maintained. Even if using the 78K0R C compiler extensions in C source programs, can still port the programs to other microcontrollers with a few easy-to-make modifications.

#### 3.3.1 Macro names

78K0 C compiler defines a macro name to indicate the microcontroller name of the target device and a macro name to indicate the device name. These device names are specified by a compiling option to generate object code for the target device or by device classification in the C source code. The following examples define the macro names `__K0__` and `__F051144__`.

See "[\(34\) Predefined macro names](#)" for more information about macro names.



```

Compiling option:
    >cc78k0 -cF051144 prime.c ...

Processor type:
    #pragma pc ( F051144 )

```

### 3.3.2 Keywords

78K0 C compiler defines the following keywords to enable the extended functions. Like ANSI C keywords, these keywords cannot be used as labels or variable names.

All of these keywords are in lowercase. Any token that contains an uppercase character is not regarded as a keyword.

In the following table of keywords added by 78K0 C compiler, keywords that do not begin with "\_\_" can be undefined by specifying the strict ANSI C conformance option (-za).

**Table 3-10. Keywords Added by 78K0 C Compiler**

Keyword		Purpose
Always Defined	Undefined When -za Option Is Specified	
__callt	callt	Call functions via callt table
__callf	callf	Call functions via callf area
__sreg	sreg	Allocate variables in saddr area
-	noauto	Generate functions without pre/post-processing
__leaf	norec	Generate functions without pre/post-processing
__boolean	boolean	Bit access to saddr and sfr area
-	bit	Bit access to saddr and sfr area
__interrupt	-	Hardware interrupt
__interrupt_brk	-	Software interrupt
__asm	-	ASM statements
__pascal	-	Generate code that removes arguments to a function from the stack before the function returns
__flash	-	Firmware ROM functions
__flashf	-	__flashf functions
__directmap	-	Absolute address mapping
__temp	-	Temporary variables
__mxcall	-	__mxcall function

#### (1) Functions

The callt, \_\_callt, callf, \_\_callf, noauto, norec, \_\_leaf, \_\_interrupt, \_\_interrupt\_brk, , \_\_flash, \_\_flashf, \_\_pascal keywords are attribute qualifiers that may be added to the start of function descriptions.

The syntax is shown below.

```
attribute-qualifier ordinary-declarator function-name (parameter-type-list/identifier-list)
```

Following is an example description .

```
__callt int func ( int );
```

Valid attribute qualifiers are limited to the following (noauto and norec/\_\_leaf cannot be specified at the same time). Note that callt and \_\_callt, callf and \_\_callf, norec and \_\_leaf are regarded as the same specification. However, the qualifier that begins with "\_\_" is defined even when the -za option is specified.

- callt
- callf
- noauto
- norec
- callt noauto
- callt norec
- noauto callt
- norec callt
- callf noauto
- callf norec
- noauto callf
- norec callf
- \_\_interrupt
- \_\_interrupt\_brk
- \_\_pascal
- \_\_pascal noauto
- \_\_pascal callt
- \_\_pascal callf
- noauto \_\_pascal
- callt \_\_pascal
- callf \_\_pascal
- callt noauto \_\_pascal
- callf noauto \_\_pascal
- \_\_flash
- \_\_flashf

## (2) Variables

- sreg and \_\_sreg follow the same rules as the "register" of the C language. (See " [How to use the saddr area \(sreg/\\_\\_sreg\)](#)" for more information about the sreg keywords.)
- The bit, boolean, and \_\_boolean type specifiers follow the same rules as the "char" and "int" type specifiers of the C language.  
However, they can be applied only to variables declared outside functions (external variables).
- The \_\_directmap qualifier follows the same rules as the qualifiers of the C language. (See " [Absolute address allocation specification \(\\_\\_directmap\)](#)" for details.)
- Specify the \_\_temp using the same rule as the type modifier of the C language (please see " [Temporary variables \(\\_\\_temp\)](#)" for more details).

### 3.3.3 #pragma directives

#pragma directives are one of the types of preprocessing directives supported by the ANSI C standard. A #pragma directive instructs the compiler to translate in a specific way, depending on the string that follows the #pragma.

When a compiler encounters a #pragma directive that it does not recognize, it ignores the directive and continues compiling. If the function of the unrecognized #pragma was to define a keyword, then an error will occur when that keyword is encountered in the C source. To avoid this, the undefined keyword should be deleted from the C source or excluded by #ifdef.

78K0 C compiler supports the following #pragma directives, which allow extended functions.

The keyword after #pragma may be specified in either uppercase or lowercase.

See "3.3.4 Using extended functions" for more information about using these directives to enable extended functions. #pragma directive list.

**Table 3-11. #pragma Directives List**

#pragma Directive	Purpose
#pragma sfr	Use SFR names in C source files. -> See "How to use the sfr area (sfr)".
#pragma asm	Inserts ASM statement in C source. -> See "ASM statements (#asm - #endasm/ __asm)".
#pragma vect #pragma interrupt	Write interrupt service routines in C. -> See "Interrupt functions (#pragma vect/#pragma interrupt)".
#pragma di #pragma ei	Disable and enable interrupts in C. -> See "Interrupt functions (#pragma DI, #pragma EI)".
#pragma halt #pragma stop #pragma brk #pragma nop	Write CPU control instructions in C. -> See "CPU control instruction(#pragma HALT/STOP/BRK/NOP)".
#pragma access	Uses absolute address access functions. -> See "Absolute address access function (#pragma access)".
#pragma section	Change the compiler output section name and specify the section location. -> See "Changing compiler output section name (#pragma section ...)".
#pragma name	Change the module name. -> See "Module name changing function (#pragma name)".
#pragma rot	Use the inline rotation functions. -> See "Rotate function (#pragma rot)".
#pragma mul	Use the inline multiplication function. -> See "Multiplication function (#pragma mul)".
#pragma div	Use optimized division functions. -> See "Division function (#pragma div)".
#pragma bcd	Uses operation functions -> See "BCD operation function (#pragma bcd)".
#pragma opc	Insert data at the current code address. -> See "Data insertion function (#pragma opc)".

#pragma Directive	Purpose
#pragma ext_table	Specify the starting address of the flash area branch table. -> See " <a href="#">Flash area branch table (#pragma ext_table)</a> ".
#pragma ext_func	Call flash area functions from boot area. -> See " <a href="#">Function of function call from boot area to flash area (#pragma ext_func)</a> ".
#pragma realregister	Use register direct reference function -> See " <a href="#">Register direct reference function (#pragma realregister)</a> ".
#pragma hromcall	Use firmware self-programming subroutine direct call function -> See " <a href="#">On-chip firmware self-programming subroutine direct call function (#pragma hromcall)</a> ".
#pragma inline	Inline expansion of the standard library functions memcpy and memset. -> See " <a href="#">Memory manipulation function (#pragma inline)</a> ".

### 3.3.4 Using extended functions

The following lists the extended functions of 78K0 C compiler.

**Table 3-12. Extended Function List**

Extended Function	Description
<a href="#">callt functions (callt/___callt)</a>	Allocated the address of a called function in the callt table area. It's possible to reduce an object code compared with usual calling instruction call..
<a href="#">Register variables (register)</a>	Instructs the compiler to place a variable in a register or the saddr area, for greater execution speed. Object code is also more compact.
<a href="#">How to use the saddr area (sreg/___sreg)</a>	Allocated a external variable of specified sreg or specified ___sreg, and a static variable in a function in the saddr area. Variables in the saddr area can be faster execution speed than normal variables. Object code is also more compact. Variables can be allocated in the saddr area by compiler options.
<a href="#">Usage with saddr automatic allocation option of external variables/external static variables (-rd)</a>	Allocated a external variable and a external static variable in the saddr area. Variables in the saddr area can be faster execution speed than normal variables. Object code is also more compact. Variables can be allocated in the saddr area by compiler options.
<a href="#">Usage with saddr automatic allocation option of internal static variables (-rs)</a>	Allocated a internal static variable in the saddr area. Variables in the saddr area can be faster execution speed than normal variables. Object code is also more compact. Variables can be allocated in the saddr area by compiler options.
<a href="#">Usage with saddr automatic allocation option for arguments/automatic variables (-rk)</a>	Arguments and automatic variables can be allocated to saddr area. Compared to the usage of the normal variables, the execution speed is improved. Also, the object code can be reduced. Variables can be allocated to saddr area with options.
<a href="#">Usage by variable information file specification option (-ma)</a>	The external variable and external static variable (except const type) is allocated to saddr area with specification of a variable information file. Variables in the saddr area can be faster execution speed than normal variables. Also, the object code can be reduced.

Extended Function	Description
<a href="#">How to use the sfr area (sfr)</a>	The #pragma sfr directive declares sfr names, which can use to manipulate special function registers (sfr) from C source files.
<a href="#">noauto functions (noauto)</a>	This function generates a function without pre/post-processing (stack frame). The argument will be passed by register when calling noauto function. This will improve the execution speed and reduce the object code. This function has limited number of arguments and automatic variables. See " <a href="#">noauto functions (noauto)</a> " for the details.
<a href="#">norec functions (norec)</a>	This function generates a function without pre/post-processing (stack frame). The argument will be passed by register when calling norec/___leaf function. Automatic variables which are used in the norec/___leaf functions will be allocated to the register or the saddr area. This will improve the execution speed and reduce the object code. This functions have limited number of automatic variables. This function cannot call another functions. See " <a href="#">norec functions (norec)</a> " for the details.
<a href="#">bit type variables (bit), boolean type variables (boolean/___boolean)</a>	Generate variables having 1-bit memory area. bit and boolean/___boolean type variables allow bit access to the saddr area. boolean and ___boolean type variables are functionally identical to bit type variables, and can be used in the same way.
<a href="#">ASM statements (#asm - #endasm/___asm)</a>	The #asm and ___asm directives allow to use assembly language statements in C source code. The statements are embedded in the assembly source code generated by the C compiler.
<a href="#">Kanji (2-byte character) (* kanji */, // kanji)</a>	C source comments can contain kanji (multibyte Japanese characters). Select the kanji encoding from Shift-JIS, EUC, or none.
<a href="#">Interrupt functions (#pragma vect/#pragma interrupt)</a>	Generate the interrupt vector table, and output object code required by interrupt. This allows to write interrupt functions in C..
<a href="#">Interrupt function qualifier (___interrupt, ___interrupt_brk)</a>	It's possible to describe a vector table setting and an interrupt function definition in another file.
<a href="#">Interrupt functions (#pragma DI, #pragma EI)</a>	Embed instructions to disable/enable interrupts in object code.
<a href="#">CPU control instruction(#pragma HALT/ STOP/BRK/NOP)</a>	Embed the following instruction in object code. halt instruction stop instruction brk instruction nop instruction
<a href="#">calf functions (calf/___calf)</a>	The calf instruction stores the body of a function in the calf entry area and allow the calling of the function with a code shorter than that with the call instruction. The execution speed will be improved and the object code will be reduced.
<a href="#">Absolute address access function (#pragma access)</a>	This function creates an object file by outputting the code that accesses the ordinary memory space through direct in-line expansion without using the function call.
<a href="#">Bit field declaration (Extension of type specifier)</a>	Defining bit fields of unsigned char, signed char, signed int, unsigned short, signed short type can save memory and make object code shorter and faster execution speed.
<a href="#">Bit field declaration (Allocation direction of bit field)</a>	The -rb option changes the bit-field allocation order.

Extended Function	Description
Changing compiler output section name (#pragma section ...)	Allows to change the compiler output section name and instruct the linker to locate that section independently.
Binary constant (0bxxx)	Allows specifying binary constants in C source code.
Module name changing function (#pragma name)	The module name of an object can be changed to any name in C source code.
Rotate function (#pragma rot)	Outputs the code that rotates the value of an expression to the object with direct inline expansion.
Multiplication function (#pragma mul)	Outputs the code that multiplies the value of an expression to the object with direct inline expansion. The resulting object code is smaller and faster execution speed.
Division function (#pragma div)	Outputs the code to divide the value of an expression to the object through direct in-line expansion. This function will reduce the object code and improve the execution speed.
BCD operation function (#pragma bcd)	Outputs the code that performs a BCD operation on the expression value in an object by direct inline expansion. BCD operation is the calculation to express 1 digit of decimal number by 4 bits of binary number.
Bank function	Allocate the functions to the bank area or the common area. This allows the device with the bank to be used.
Bank function in a constant address	The bank function at the constant address can be called. This is only used with the devices with the bank.
Data insertion function (#pragma opc)	Inserts constant data into the current address. Specific data and instruction can be embedded in the code area without using the ASM statement.
Static model	By compiling with the -sm option, the object code can be reduced, execution speed can be improved, interrupt processing can be speeded up, and the memory can be saved.
Change from int and short types to char type (-zi)	By compiling with the -zi option, int and short types are regarded as char type.
Change from long type to int type (-zl)	By compiling with the -zl option, long type is regarded as int type.
Pascal function (__pascal)	The correction of the stack used for the place of arguments during the function call is performed on the called function side, not on the side calling the function. With this function, the object code can be reduced if a lot of function call appears.
Automatic pascal functionization of function call interface (-zr)	With the exception of norec/__interrupt/__interrupt_brk/__flash/__flashf/variable length argument functions, __pascal attributes are added to all functions when the -zr option is specified during compiling
Flash area allocation method (-zf)	By compiling with the -zf option, allows programs to be allocated to the flash area, and allows those programs to be linked to object code (compiled without the -zf option) in the boot area.
Flash area branch table (#pragma ext_table)	By specifying the first address of the flash area branch table following #pragma instruction, a start-up routine and interrupt function can be located in the flash area and the function calls can be performed from the boot area to the flash area.
Function of function call from boot area to flash area (#pragma ext_func)	The #pragma instruction specifies the function name and ID value in the flash area called from the boot area, allowing flash area functions to be called from the boot area.

Extended Function	Description
Firmware ROM function ( <code>__flash</code> )	Adding <code>__flash</code> attributes to the top of the program during interface library prototype declaration, you can describe the operation in terms with the firmware ROM at the C source level.
Method of int expansion limitation of argument/return value ( <code>-zb</code> )	Compiling with the <code>-zb</code> option, to generate smaller object code and faster execution speed.
Array offset calculation simplification method ( <code>-qw2</code> )	Specifying the <code>-qw2</code> and <code>-qw3</code> options while compiling, offset calculation code is simplified, the object code can be reduced, and the execution speed can be improved.
Register direct reference function ( <code>#pragma realregister</code> )	An access to the register which is described by C can be performed easily by describing this function in the source in the same format as a function call and declaring the usage of this function following the <code>#pragma realregister</code> instruction of the module.
[HL + B] based indexed addressing utilization method ( <code>-qe</code> )	Specifying the <code>-qe</code> option during compiling enables the object code to be reduced and the execution speed to be improved.
On-chip firmware self-programming subroutine direct call function ( <code>#pragma hromcall</code> )	The firmware self-programming subroutine called by C description can be performed easily by describing this function in the source in the same format as a function call and declaring the usage of this function following the <code>#pragma hromcall</code> instruction of the module.
<code>__flashf</code> function ( <code>__flashf</code> )	Adding the <code>__flashf</code> attributes to the top of the function during its declaration, a code which switches to bank save/restore and register bank 3 at each call is not generated when describing this function in the function.
Memory manipulation function ( <code>#pragma inline</code> )	An object file is generated by the output of the standard library functions <code>memcpy</code> and <code>memset</code> with direct inline expansion. The resulting code is faster execution speed.
Absolute address allocation specification ( <code>__directmap</code> )	Declare <code>__directmap</code> in the module in which the variable to be allocated in an absolute address is to be defined. One or more variables can be allocated to the same arbitrary address.
Static model expansion specification ( <code>-zm</code> )	By compiling with the <code>-zm</code> option, the restrictions on existing static models can be relaxed and the descriptiveness are improved.
Temporary variables ( <code>__temp</code> )	By compiling with the <code>-sm</code> and <code>zm</code> options and declaring <code>__temp</code> for arguments and automatic variables, an argument and automatic variable area can be reserved. If the sections containing arguments and automatic variables are clearly identified and the <code>__temp</code> declaration is applied to variables that do not require a guaranteed value match before and after a function call, memory can be reserved.
Library supporting prologue/epilogue ( <code>-zd</code> )	By compiling with the <code>-zd</code> option, prolog and epilog codes are replaced by libraries and the object code can be reduced.

**callt functions (callt/ \_\_callt)**

The address of the called function is allocated in the callt table area, and the function is called.

**[Function]**

- The callt instruction stores the address of a function to be called in an area [40H - 7FH] called the callt table, so that the function can be called with a shorter code than the one used to call the function directly.
- To call a function declared by the callt (or \_\_callt) (called the callt function), a name with ? prefixed to the function name is used. To call the function, the callt instruction is used.
- The function to be called is not different from the ordinary function.

**[Effect]**

- The object code can be shortened.

**[Usage]**

- Add the callt/ \_\_callt attribute to the function to be called as follows (described at the beginning):

callt	extern	type-name	function-name
__callt	extern	type-name	function-name

**[Restrictions]**

- The address of each function declared with callt/ \_\_callt will be allocated to the callt table at the time of linking object modules. For this reason, when using the callt table in an assembler source module, the routine to be created must be made "relocatable" using symbols.
- A check on the number of callt functions is made at linking time.
- When the -za option is specified, \_\_callt is enabled and callt is disabled.
- When the -zf option is specified, callt functions cannot be defined. If a callt function is defined, an error will occur.
- The area of the callt table is 40H to 7FH.
- When the callt table is used exceeding the number of callt attribute functions permitted, a compile error will occur.
- The callt table is used by specifying the -ql option. For that reason, the number of callt attributes permitted per 1 load module and the total in the linking modules is as shown below.
- In the case of devices without multiply and divide instructions, two callt tables are used for executing multiply and divide, so the maximum number of tables is reduced by two.
- Because two callt entries are used by the library that supports prologue/epilogue in the case of a normal model and up to ten in the case of a static model, the maximum number of callt entries is reduced two in the case of a normal model and no more than ten in the case of a static model.

Option	no -ql	-ql1	-ql2	-ql3	-ql4	-ql5
Normal model	30	30	28	17	8	2
Static model	32	32	31	18	10	-

- The -ql5 option cannot be specified at the static model.



- Cases where the -ql option is not used and the defaults are as shown in the table below.

callt Function	Restriction Value	
	Normal Model	Static Model
Number per load module	30 max.	32 max.
Total number in linked module	30 max.	32 max.

**Caution** When normal model is specified, two callt tables are used in the bank function call library. Please see "[Bank function](#)" for the details.

**[Example]**

<pre>(C source) ===== cal.c ===== __callt extern int    tsub ( );  void main ( ) {     int    ret_val ;     ret_val = tsub ( ); }</pre>	<pre>===== ca2.c =====  __callt int    tsub ( ) {     int val ;     return val ; }</pre>
<pre>(Output object of compiler)  cal module     EXTRN    ?tsub                ; Declaration     callt    [?tsub]              ; Call  ca2 module     PUBLIC   _tsub                ; Declaration     PUBLIC   ?tsub                ; @@CALT CSEG    CALLT0            ; Allocation to segment ?tsub : DW    _tsub @@CODE CSEG _tsub :                ; Function definition     :     ; function body     :</pre>	

The callt attribute is given to the function tsub( ) so that it can be stored in the callt table.

**[Compatibility]**

**(1) From another C compiler to the 78K0 C compiler**

- The C source program need not be modified if the keyword callt/ \_\_callt is not used.
- To change functions to callt functions, observe the procedure described in the USAGE above.

**(2) From the 78K0 C compiler to another C compiler**

- #define must be used. For details, see "[3.3.5 C source modifications](#)".

### Register variables (register)

A variable is allocated to a register and saddr area.

#### [Function]

- Allocates the declared variables (including arguments of function) to the register (HL) and saddr area (\_@KREG00 to \_@KREG15). Saves and restores registers or saddr area during the preprocessing/ postprocessing of the module that declared a register.
- In the case of the static model, the allocation is performed based on the number of times referenced. Therefore, which register or the saddr area the variables are allocated is undefined.
- For the details of the allocation of register variables, see "3.4 Function Call Interface".
- Register variables are allocated to different areas depending on the compile condition as shown below (for each option, see the User's Manual for "78K0 Build").
- In the case of the normal model, the register variables are allocated in the declared sequence to register HL or the saddr area [FED0H to FEDFH]. Register variables are allocated to register HL only if there is no stack frame. To the saddr area, the register variables are allocated only when the -qr option is specified.
- In the case of the static model, the register variables are allocated to register DE or \_@KREGxx secured by the -sm option according to the number of times referenced. To \_@KREGxx, the register variables are allocated only when the -zm2 option is specified.  
See "Static model" for the -zm2 option.

#### [Effect]

- Instructions to the variables allocated to the register or saddr area are generally shorter in code length than those to memory. This helps shorten object and also improves program execution speed.

#### [Usage]

- Declare a variable with the register storage class specifier as follows:

```
register      type-name      variable-name
```

#### [Restrictions]

- If register variables are not used so frequently, object code may increase (depending on the size and contents of the source).
- Register variable declarations may be used for char/int/short/long/float/double/long double and pointer data types.

##### (1) Normal model

- char type uses a half of the space that the other types do and long/float/double/long double/function pointers (when using bank (-mf)) use twice the space. char types have byte boundaries between themselves while others have word boundaries.
- For int/short, a data pointer and a function pointer (when not using bank function(-mf)), at maximum 8 variables can be used per function. From the 9th variable, they are allocated to the ordinary memory.
- In the case of a function without a stack frame, a maximum of 9 variables per function is usable for int/ short and pointer (when the bank function (-mf) is not used). From the 10th variable, the register variables are assigned to the normal memory.

**(2) Static model)**

- char type uses a half of the space compared to the others.
- int/short/ pointers can use up to 1 variable per a function.
- From the second variable, they are allocated to the ordinary memory.
- long/float/double/long double types are invalid.

Data Type	Usable Number (per Function)	
	Normal Model	Static Model
int/short	8 variables max.	1 variables max.
Pointer	8 variables max. (In the case of functions without a stack frame, up to nine variables are usable. When the bank function (-mf) is used, up to 4 variables can be used for function pointers.)	1 variables max.

**[Example]**

&lt;C source&gt;

```

void func ( );

void main ( ) {
    register int    i, j ;
    i = 0 ;
    j = 1 ;
    i += j ;
    func ( ) ;
}

```

**(1) When -sm option is not specified (an example for the case that a register variable is allocated to Register HL and saddr area.)**

The following label is declared at a start-up routine (see "3.5 List of saddr Area Labels" ).

An output object of the compiler is as follows.

```

        EXTRN    _@KREG00        ; References the saddr area to be used
_main :
        push    hl                ; Saves the contents of the register at the beginning
                                ; of the function
        movw   ax, _@KREG00      ; Saves the contents of the saddr at the beginning of
                                ; the function
        push    ax                ;
        movw   hl, #00H          ; The following codes are output in the middle of the
                                ; function
        movw   _@KREG00, #01H    ;
        movw   ax, _@KREG00      ;
        xch    a, x              ;

```

```

add    l, a          ;
xch    a, x          ;
addc   h, a          ;
call   !_func        ;

pop    ax            ; Restores contents of the saddr at the end of the
                        function
movw   @_KREG00, ax  ;
pop    hl            ; Restores contents of the register at the end of the
                        function
ret

```

- (2) When **-sm** option is specified (an example for the case that a register variable is allocated to register DE).  
An output object of the compiler is as follows.

```

_main :
push   de            ; Saves the contents of the register at the beginning
                        of the function
movw   de, #00H      ;
movw   ax, #01H      ;
movw   !?L0003, ax   ;
xch    a, x          ;
add    e, a          ;
xch    a, x          ;
addc   d, a          ;
call   !_func        ;
pop    de            ; Restores contents of the register at the end of the
                        function
ret

```

- To use register variables, declare register class for the storage class.
- The label `_@KREG00` includes the module with PUBLIC declaration in the library attached to 78K0 C compiler.

### [Compatibility]

#### (1) From another C compiler to the 78K0 C compiler

- The C source program need not be modified if the other C compiler supports register declarations.
- To change to register variables, add the register declarations for the variables to the program.

#### (2) From the 78K0 C compiler to another C compiler

- The C source program need not be modified if the other compiler supports register declarations.
- How many variable registers can be used and to which area they will be allocated depend on the implementations of the other C compiler.

### How to use the saddr area (sreg/ \_\_sreg)

External variables that the sreg or \_\_sreg is declared and static variables declared within functions are allocated in the saddr area.

#### [Function]

- The external variables and in-function static variables (called sreg variable) declared with keyword sreg or \_\_sreg are automatically allocated to saddr area [0FE20H to 0FEB7H] (normal model), [0FE20H to 0FECFH] (static model) and with relocatability. When those variables exceed the area shown above, a compile error will occur.
- The sreg variables are treated in the same manner as the ordinary variables in the C source.
- Each bit of sreg variables of char, short, int, and long type becomes boolean type variable automatically.
- sreg variables declared without an initial value take 0 as the initial value.
- Of the sreg variables declared in the assembler source, the saddr area [0FE20H to 0FEFFH] can be referred to. The area [0FEB8H to 0FEFFH] (normal model), [0FED0H to 0FEFFH] (static model) are used by compiler so that care must be taken (see "Figure 3-2. Utilization of Memory Space (Normal Model)", "Figure 3-3. Utilization of Memory Space (Static Model)").

#### [Effect]

- Instructions to the saddr area are generally shorter in code length than those to memory. This helps shorten object code and also improves program execution speed.

#### [Usage]

- Declare variables with the keywords sreg and \_\_sreg inside a module and a function which defines the variables. Only the variable with a static storage class specifier can become a sreg variable inside a function.

```
sreg    type-name    variable-name/ sreg    static    type-name    variable-name
__sreg  type-name    variable-name/ __sreg  static    type-name    variable-name
```

- Declare the following variables inside a module which refers to sreg external variables. They can be described inside a function as well.

```
extern sreg    type-name    variable-name/ extern __sreg  type-name    variable-name
```

#### [Restrictions]

- If const type is specified, or if sreg/ \_\_sreg is specified for a function, a warning message is output, and the sreg declaration is ignored.
- char type uses a half the space of other types and long/float/double/long double/function pointer (when the bank function (-mf) is used) types use a space twice as wide as other types.
- Between char types there are byte boundaries, but in other cases, there are word boundaries.
- When the -za option is specified, only \_\_sreg is enabled and sreg is disabled.
- In the case of normal model, int/shortt, data pointer, function pointer (when the bank function (-mf) is not used), and pointer, a maximum of 76 variables per load module is usable (when saddr area [0FE20H - 0FEB7H] is used).

Note that the number of usable variables decreases when bit and boolean type variables, boolean type variables are used.

- In the case of static model, int/short and pointers , a maximum of 88 variables per load module is available (when saddr area [0FE20H to 0FECFH] is used). However, the number of variables available decreases when bit and Boolean type variables and shared areas are used (static model).

**[Example]**

&lt;C source&gt;

```
extern sreg    int    hsmm0 ;
extern sreg    int    hsmm1 ;
extern sreg    int    *hsptr ;

void main ( ) {
    hsmm0 -= hsmm1 ;
}
```

The following example shows a definition code for sreg variable that the user creates. If extern declaration is not made in the C source, the 78K0 C compiler outputs the following codes. In this case, the ORG quasi-directive will not be output.

```
    PUBLIC  _hsmm0  ; Declaration
    PUBLIC  _hsmm1  ;
    PUBLIC  _hsptr  ;

@@DATS  DSEG      SADDRP  ; Allocation to segment
    ORG      0FE20H  ;
_hsmm0 :      DS      ( 2 )  ;
_hsmm1 :      DS      ( 2 )  ;
_hsptr :      DS      ( 2 )  ;
```

The following codes are output in the function.

```
movw    ax, _hsmm0
xch     a, x
sub     a, _hsmm1
xch     a, x
subc    a, _hsmm1 + 1
movw    _hsmm0, ax
```

**[Compatibility]****(1) From another C compiler to the 78K0 C compiler**

- Modifications are not needed if the other compiler does not use the keyword sreg/ \_\_sreg. To change to sreg variable, modifications are made according to the method shown above.

**(2) From the 78K0 C compiler to another C compiler**

- Modifications are made by #define. For the details, see "3.3.5 C source modifications". Thereby, sreg variables are handled as ordinary variables.

**Usage with saddr automatic allocation option of external variables/external static variables (-rd)**

The -rd option to automatically allocate external variables and external static variables in the saddr area.

**[Function]**

- External variables/external static variables (except const type) are automatically allocated to the saddr area regardless of whether sreg declaration is made or not.
- Depending on the value of  $n$  and the specification of  $m$ , the external variables and external static variables to allocate can be specified as follows.

Specification of $n,m$	Variables Allocated to saddr Area
$n$	(1) When $n = 1$ Variables of char and unsigned char types  (2) When $n = 2$ Variables for when $n = 1$ , plus variables of short, unsigned short, int, unsigned int, enum, and pointer type (Except function pointers when bank function (-mf) is used.)  When $n = 4$ Variables for when $n = 2$ , plus variables, function pointers (when the bank function (-mf) is used.) of long, unsigned long, float, double, and long double type
$m$	Structures, unions, and arrays
When omitted	All variables

- Variables declared with the keyword sreg are allocated to the saddr area, regardless of the above specification.
- The above rule also applies to variables referenced by extern declaration, and processing is performed as if these variables were allocated to the saddr area.
- The variables allocated to the saddr area by this option are treated in the same manner as the sreg variable. The functions and restrictions of these variables are as described in [\[How to use the saddr area \(sreg/\\_\\_\\_sreg\)\]](#).

**[Usage]**

- Specify the -rd[ $n$ ][ $m$ ] ( $n = 1, 2, \text{ or } 4$ ) option.

**[Restrictions]**

- In the -rd[ $n$ ][ $m$ ] option, modules specifying different  $n, m$  value cannot be linked each other.

### Usage with `saddr` automatic allocation option of internal static variables (`-rs`)

The `-rs` option to automatically allocate internal static variables in the `saddr` area.

#### [Function]

- Automatically allocates internal static variables (except `const` type) to `saddr` area regardless of with/ without `sreg` declaration.
- Depending on the value of  $n$  and the specification of  $m$ , the internal static variables to allocate can be specified as follows.

Specification of $n, m$	Variables Allocated to <code>saddr</code> Area
$n$	(1) When $n = 1$ : Variables of <code>char</code> and unsigned <code>char</code> types (2) When $n = 2$ : Variables for when $n = 1$ , plus variables of <code>short</code> , unsigned <code>short</code> , <code>int</code> , unsigned <code>int</code> , <code>enum</code> , and, pointer type (Except function pointers when bank function ( <code>-mf</code> ) is used.) (3) When $n = 4$ : Variables, function pointers (when the bank function ( <code>-mf</code> ) is used.) for when $n = 2$ , plus variables of <code>long</code> , unsigned <code>long</code> , <code>float</code> , <code>double</code> , and <code>long double</code> type
$m$	Structures, unions, and arrays
When omitted	All variables (including structures, unions, and arrays in this case only)

- Variables declared with the keyword `sreg` are allocated to the `saddr` area regardless of the above specification.
- The variables allocated to the `saddr` area by this option are handled in the same manner as the `sreg` variable. The functions and restrictions for these variables are as described in [[How to use the `saddr` area \(`sreg/\_\_sreg`\)](#)].

#### [Usage]

- Specify the `-rs[n][m]` ( $n = 1, 2, \text{ or } 4$ ) option.

**Remark** In the `-rs[n][m]` option, modules specifying different  $n, m$  value can also be linked each other.



**Usage with saddr automatic allocation option for arguments/automatic variables (-rk)**

Arguments and automatic variables are allocated to the saddr area.

**[Function]**

- Arguments and automatic variables (except const type) are automatically allocated to the saddr area regardless of whether or not a sreg declaration exists.
- The arguments and automatic variables to be allocated are specified using the values of *n* and the specification of *m*.

Specification of <i>n</i> , <i>m</i>	Variables Allocated to saddr Area
<i>n</i>	(1) When <i>n</i> = 1: Variables of char and unsigned char types  (2) When <i>n</i> = 2: In addition to values for when <i>n</i> = 1, variables of the short, unsigned short, int, unsigned int, enum, and pointer types (Except function pointers when bank function (-mf) is used.)  (3) When <i>n</i> = 4: In addition to values for when <i>n</i> = 2, variables of the long, unsigned long, float, double, and long double types, function pointers (when the bank function (-mf) is used.)
<i>m</i>	Structures, unions, and arrays
When omitted	All variables

- Variables declared with sreg are allocated to the saddr area regardless of the above specifications.
- Variables allocated to the saddr area by this option are handled in the same way as sreg variables.

**[Usage]**

- Specify -rk[*n*][*m*] option (where *n* is 1,2, or 4).

**Remark** Modules that have different *n*, *m* values specified in -rk[*n*][*m*] option can be linked.

**[Restrictions]**

- Only the static model is supported. When -sm option is not specified, a warning message is output and arguments and automatic variables are not automatically allocated.
- Arguments/variables with register variable declaration are not allocated to the saddr area.
- When -qv option is also specified, allocation to register DE has the priority.

**[Example]**

<C source>

```

sub ( int      hsmarg ) {
    int      hsmauto ;
    hsmauto = hsmarg ;
}
    
```

<Output object of compiler>

```
@@DATS      DSEG      SADDRP
?L0003 :    DS        ( 2 )
@@CODE      CSEG
_sub :
           movw     ?L0003, ax      ; hsmauto
           ret
```

**Usage by variable information file specification option (-ma)**

Depending on the specification of variables information file, the -ma option allocate external variables and external static variables (except const type) in the saddr area.

**[Function]**

- Depending on the specification of variables information file, the -ma option allocate external variables and external static variables (except const type) in the saddr area.
- The variable information file that the variables information file generator output can be specified.
- Variables declared with the keyword sreg are allocated to the saddr area, regardless of the variables information file specification.
- Depending on the specification of variables information file also applies to variables referenced by extern declaration, and processing is performed as if these variables were allocated to the saddr area.
- The -ma option is defined even when the -za option is specified.
- The variables allocated to the saddr area by -ma option are treated in the same manner as the sreg variable. The functions of these variables are as described in [\[How to use the saddr area \(sreg/ \\_\\_sreg\)\]](#).

**[Effect]**

- Instructions to the saddr area are generally shorter in code length than those to memory. This helps shorten object code and also improves program execution speed.

**[Usage]**

- Specify the -ma option.

**[Restrictions]**

- When the variable of the const type is specified for the saddr area allocation with the variable information file, a warning message is output, and the saddr area allocation specification of the variable becomes invalid.
- When the variable that doesn't exist on C source is specified for the saddr area allocation with the variable information file, the saddr area allocation of the variable becomes invalid. An warning message is not output.
- If the -ma and -rd options are specified at the same time, a warning message that the -rd option will be ignored is output.
- If the -ma and -rs options are specified at the same time, allocation via -ma will be suppressed because -rs takes higher precedence.

### How to use the sfr area (sfr)

The #pragma sfr directive declares sfr names, which can use to manipulate special function registers (sfr) from C source files.

#### [Function]

- The sfr area refers to a group of special function registers such as mode registers and control registers for the various peripherals of the 78K0 microcontrollers.
- By declaring use of sfr names, manipulations on the sfr area can be described at the C source level.
- sfr variables are external variables without initial value (undefined).
- A write check will be performed on read-only sfr variables.
- A read check will be performed on write-only sfr variables.
- Assignment of an illegal data to an sfr variable will result in a compile error.
- The sfr names that can be used are those allocated to an area consisting of addresses[0FF00H - 0FFFFH].

#### [Effect]

- Manipulations to the sfr area can be described in the C source level.
- Instructions to the sfr area are shorter in code length than those to memory. This helps shorten object code and also improves program execution speed.

#### [Usage]

- Declare the use of an sfr name in the C source with the #pragma preprocessor directive, as follows (The keyword sfr can be described in uppercase or lowercase letters.):

```
#pragma sfr
```

The #pragma sfr directive must be described at the beginning of the C source line. If #pragma PC (processor type) is specified, however, describe #pragma sfr after that.

If #pragma PC (processor type) is specified, however, describe #pragma sfr after that.

The following statement and directives may precede the #pragma sfr directive:

- Comment
  - Preprocessor directives which do not define nor refer to a variable or function
- In the C source program, describe an sfr name that the device has as is (without change). In this case, the sfr need not be declared.

#### [Restrictions]

- All sfr names must be described in uppercase letters. Lowercase letters are treated as ordinary variables.

**[Example]****(1) Use of sfr area 1**

&lt;C source&gt;

```

#ifdef __K0__
#pragma sfr
#endif

void main ( ) {
    P0 -= ADCR ;
    /* ADCR = 10 ; ==> error */
}

```

Codes that relate to declarations are not output and the following codes are output in the middle of the function.

```

mov    a, P0
sub    a, ADCR
mov    P0, a

```

**(2) Use of sfr area 2**

The CA78K0 can access each bit of sfr. "bit number" is specified as 0 to 7 in the case of a 8-bit register.

```

register name.bit number

```

The bits of the flag of each register can be accessed by using a bit name. Names defined by the device file are specified as "bit names".

&lt;C source&gt;

```

#pragma sfr
void func1(void)
{
    unsigned char  c;

    P0 = 1;          /* Writes 1 to P0 */
    c = PM0;        /* Reads from RM0 */
    P0.1 = 1;       /* Sets bit 1 of P0 to 1 */
    SPT0 = 1;       /* Sets the bit named SPT0 to 1 */
}

```

**[Compatibility]****(1) From another C compiler to the 78K0 C compiler**

- Those portions of the C source program not dependent on the device or compiler need not be modified.

**(2) From the 78K0 C compiler to another C compiler**

- Delete the "#pragma sfr" statement or sort by "#ifdef" and add the declaration of the variable that was formerly a sfr variable.

The following shows an example.

```
#ifdef __K0__
#pragma sfr
#else
/*Declaration of variables*/
unsigned char P0 ;
#endif

void main ( void ) {
    P0 = 0 ;
}
```

- In case of a device which has the sfr or its alternative functions, a dedicated library must be created to access that area.

**noauto functions (noauto)**

This function generates a function without pre/post-processing(stack frame).

**[Function]**

- noauto function sets restrictions for automatic variables not to output the codes of pre/post-processing (generation of stack frame).
  - All the arguments are allocated to registers or saddr area (FEDCH - FEDFH) for register variables. If there is an argument that cannot be allocated to registers, a compile error occurs.
  - Automatic variables can be used only if all the automatic variables are allocated to the registers or saddr area for register variable-use left over after argument allocation.
  - noauto function allocates arguments to the saddr area for register variable-use, but only if -qr option is specified during compiling.
  - noauto function stores arguments other than argument allocated to the register in saddr area for register variable-use.
- Arguments are stored in ascending sequence of their order of description (see "3.5 List of saddr Area Labels").
- The code for calling noauto output is the same code as the code for calling a normal function.
  - When -sm option is specified, a warning message is output only to the line in which noauto is described first, and all the noauto functions are handled as normal functions.

**[Effect]**

- The object code can be reduced and execution speed can be improved.

**[Usage]**

- Declare a function with noauto attribute.

```
noauto  type-name      function-name
```

**[Restrictions]**

- When -za option is specified, noauto function is disabled.
  - Arguments for noauto functions have restrictions for their types and numbers.
- The types that can be used in noauto functions are as follows. Note that arguments other than long/signed long/unsigned long, float/double/long double, function pointers (when the bank function (-mf) is used.) are allocated to register HL..
- Pointer
  - char/signed char/unsigned char
  - int/signed int/unsigned int
  - short/signed short/unsigned short
  - long/signed long/unsigned long
  - float/double/long double
- The number of arguments available is a maximum of 6 bytes in total size.
  - These restrictions are checked while compiling.
  - If arguments are declared with a register, the register declaration is ignored.

**[Example]****(1) When -qr option is specified**

&lt;C source&gt;

```

noauto short  nfunc ( short a, short b, short c );
short  l, m ;

void main ( ) {
    static short ii, jj, kk ;
    l = nfunc ( ii, jj, kk );
}
noauto short  nfunc ( short a, short b, short c ) {
    m = a + b + c ;
    return ( m );
}

```

&lt;Output object of compiler&gt;

```

@@CODE CSEG
_main :
; line 5 :      static short ii, jj, kk ;
; line 6 :      l = nfunc ( ii, jj, kk ) ;
    movw    ax, !?L0005          ; kk
    push   ax
    movw    ax, !?L0004          ; jj
    push   ax
    movw    ax, !?L0003          ; ii
    call   !_nfunc              ; Calls function nfunc(a,b,c)
    pop    ax
    pop    ax
    movw    ax, bc
    movw    !_l, ax              ; Assigns return value to external variable L
; line 7 :      }
    ret
; line 8 :      noauto short nfunc ( short a, short b, short c ) {
_nfunc :
    push   hl                    ; Saves HL
    xch    a, x                  ;
    xch    a, @_KREG12           ; Sets argument a to @_KREG12
    xch    a, x                  ;
    xch    a, @_KREG13           ;
    push   ax                    ; Saves @_KREG12
    push   ax                    ; Saves @_KREG14
    movw   ax, sp                ;
    movw   hl, ax                ;

```



```

mov    a, [hl + 10]      ;
xch    a, x              ;
mov    a, [hl + 11]     ;
movw   @_KREG14, ax      ; Sets argument c to @_KREG14
mov    a, [hl + 8]      ;
xch    a, x              ;
mov    a, [hl + 9]      ;
movw   hl, ax            ; Sets argument b to HL
; line 9 : m = a + b + c ;
movw   ax, hl            ;
xch    a, x              ;
add    a, @_KREG12       ;
xch    a, x              ;
addc   a, @_KREG13       ;
xch    a, x              ;
add    a, @_KREG14       ;
xch    a, x              ;
addc   a, @_KREG15       ; Adds b(HL) and c(@_KREG14) to a(@_KREG12)
movw   !_m, ax           ; Assigns operation result to external variable m
; line 10 : return ( m ) ;
movw   bc, ax            ; Returns the contents of external variable m
pop    ax                ;
movw   @_KREG14, ax      ; Restores @_KREG14
pop    ax                ;
movw   @_KREG12, ax      ; Restores @_KREG12
pop    hl                ; Restores HL
ret

```

**[Description]**

- In this example, `noauto` attribute is added at the header part of the C source code.
- `noauto` is declared not to generate the stack frame.

**[Compatibility]****(1) From another C compiler to the 78K0 C compile**

- If the keyword, `noauto` is not used, the modification of the C source program is not needed.
- To change variables to `noauto` variables, modify the program according to the procedure described in Usage above.

**(2) From the 78K0 C compiler to another C compiler**

- Use `#define`. See "[3.3.5 C source modifications](#)" for the details.

**norec functions (norec)**

This function generates a function without pre/post-processing (stack frame).

**[Function]**

- A function that does not call other functions can be defined as norec function.
- norec function does not output the pre/post-processing code (stack frame generation)
- The arguments of norec function are allocated to registers and saddr area [FEC0H - FEC7H] for arguments of norec function.
- If arguments cannot be allocated to register and saddr area, a compile error occurs.
- Arguments are stored either in the register or saddr area [FEC0H - FEC7H] and the norec function is called.
- Automatic variables are allocated to the saddr area [FEC8H - FECFH]. So are the register variables.
- The saddr area is only used for allocation when -qr option is specified during compiling.
- If arguments other than long/float/double/long double types, function pointers (when the bank function (-mf) is used.) are used, the first argument is stored in register AX, the second in register DE, the third and successive arguments are stored in the saddr area in ascending order.  
long/float/double/long double type, function pointers (when the bank function (-mf) is used.) arguments are stored in the saddr area from the first argument in ascending order. Note that the arguments stored in register AX and DE are one argument each regardless of the type of argument.
- The argument stored in register AX is copied to register DE if DE does not have the argument stored at the beginning of norec function. If there is an argument stored in register DE already, the argument stored in AX is copied to `__RTARG6, 7`.
- If automatic variables other than long/float/double/long double types, function pointers (when the bank function (-mf) is used.) are used, the arguments that are left after allocation are stored in the declared order; DE, `__RTARG6, 7`, `__NRARG0, 1, ...`  
If automatic variables are long/float/double/long double types, function pointers (when the bank function (-mf) is used.), the arguments that are left after allocation are stored in the declared order; `__NRARG0, 1, ...`  
See "3.5 List of saddr Area Labels" for the details for `__RTARG6, 7`, `__NRARG0, 1, ...`

**[Effect]**

- The object code can be reduced and the execution speed can be improved.

**[Usage]**

- Declare a function with the norec attribute.

```
norec  type-namez  function-name
```

- `_leaf` can also be described instead of norec.

**[Restrictions]**

- No other function can be called from a norec function.
- There are restrictions on the type and number of arguments and automatic variables that can be used in a norec function.
- When -za option is specified, norec is disabled and only `_leaf` is enabled.
- When -sm option is specified, a warning message is output only to the line in which `noauto` is described first, and all the `noauto` functions are handled as normal functions.
- The restrictions for arguments and automatic variables are checked at compiling, and an error occurs.
- If arguments and automatic variables are declared with a register, the register declaration is ignored.

- The following shows the types of arguments and automatic variables that can be used in norec functions. norec functions are allocated to the saddr area consecutively if between char/signed char/unsigned char, however if connected to other types, allocation is performed in two-byte alignment.

- Pointer
- char/signed char/unsigned char
- int/signed int/unsigned int
- short/signed short/unsigned short
- long/signed long/unsigned long
- float/double/long double

#### (1) When -qr option is not specified

- If the types are not long/float/double/long double, function pointers (when the bank function (-mf) is used.), the number of arguments that can be used in a norec function is 2 variables and long/float/double/long double types, function pointers (when the bank function (-mf) is used.) cannot be used.
- Automatic variables that can be used in norec functions are up to 4 bytes, which is leftovers from not being used with arguments when the types are not long/float/double/long double, function pointers (when the bank function (-mf) is used.). Arguments can not be used for long/float/double/long double types, function pointers (when the bank function (-mf) is used.).

#### (2) When -qr option is specified

- If the types are not long/float/double/long double, function pointers (when the bank function (-mf) is used), the number of arguments that can be used in a norec function is 6 variables. Otherwise, the number of arguments that can be used is 2 variables.
- Automatic variables can use the area that is the combined total of the number of bytes remaining unused by arguments and the number of saddr area bytes. If types other than long/float/double/long double, function pointers (when the bank function (-mf) is used) are used, automatic variables can use up to 20 bytes and if long/float/double/long double types, function pointers (when the bank function (-mf) is used) are used, automatic variables can use up to 16 bytes.
- These restrictions are checked while compiling and if it is violated, an error occurs.

#### [Example]

<C source>

```
norec int      rout ( int a, int b, int c );

int          i, j ;

void main ( void ) {
    int      k, l, m ;
    i = l + rout ( k, l, m ) + ++k ;
}

norec int      rout ( int a, int b, int c ) {
    int      x, y ;
    return ( x + ( a << 2 ) );
}
```

**(1) When -qr option is specified**

&lt;Output object of compiler&gt;

```

EXTRN  _@NRARG0          ; References saddr area to be used
EXTRN  _@NRARG1          ;
EXTRN  _@NRARG6          ;
:
_@NRARG0 <- m            ; Stores argument to saddr area
:
de     <- l              ; Stores argument to DE
:
ax     <- k              ; Stores argument to AX
call   !_rout           ; Calls norec function

_rout :
movw   _@NRARG6, ax     ; Receives argument from saddr area

mov    c, #02H
xch   a, x
add   a, a
xch   a, x
rolc  a, 1
dbnz  c, $$-5
xch   a, x
add   a, _@NRARG1      ; Use automatic variables of saddr area
xch   a, x
addc  a, _@NRARG1 + 1  ; Use automatic variables of saddr area
movw  bc, ax
ret

```

**[Description]**

- The norec attribute is added in the definition of the rout function as well to indicate that the function is norec.

**[Compatibility]****(1) From another C compiler to the 78K0 C compile**

- If the keyword, norec is not used, the modification of the C source program is not needed.
- To change variables to norec variables, modify the program according to the procedure described in Usage above.

**(2) From the 78K0 C compiler to another C compiler**

- Use #define. See "3.3.5 C source modifications" for the details.

**bit type variables (bit), boolean type variables (boolean/ \_\_boolean)**

The bit, boolean, and \_\_boolean type specifiers generate variables having 1-bit of memory area.

**[Function]**

- A bit or boolean type variable is handled as 1-bit data and allocated to saddr area.
- This variable can be handled the same as an external variable that has no initial value (or has an unknown value).
- To this variable, the C compiler outputs the following bit manipulation instructions:

```
MOV1 , AND1 , OR1 , XOR1 , SET1 , CLR1 , NOT1 , BT , BF
```

**[Effect]**

- Programming at the assembler source level can be performed in C, and the saddr and sfr area can be accessed in bit units.

**[Usage]**

- Declare a bit or boolean type inside a module in which the bit or boolean type variable is to be used, as follows:
- \_\_boolean can also be described instead of bit.

```
bit          variable-name
boolean      variable-name
__boolean    variable-name
```

- Declare a bit or boolean type inside a module in which the bit or boolean type variable is to be used, as follows:

```
extern bit          variable-name
extern boolean      variable-name
extern __boolean    variable-name
```

- char, int, short, and long type sreg variables (except the elements of arrays and members of structures) and 8-bit sfr variables can be automatically used as bit type variables.

```
variable-name.n (where n = 0 to 31)
```

**[Restrictions]**

- An operation on 2 bit or boolean type variables is performed by using the CY (Carry) flag. For this reason, the contents of the carry flag between statements are not guaranteed.
- Arrays cannot be defined or referenced.
- A bit or boolean type variable cannot be used as a member of a structure or union.
- This type of variable cannot be used as the argument type of a function.
- A bit type variable cannot be used as a type of automatic variable (except static model).
- With bit type variables only, up to 1216 variables can be used per load module (when saddr area [0FE20H - 0FEB7H] is used) (normal model).
- With bit type variables only, up to 1536 variables can be used per load module (when saddr area [0FE20H - 0FEDFH] is used) (static model).
- The variable cannot be declared with an initial value.

- If the variable is described along with const declaration, the const declaration is ignored.
- Only operations using 0 and 1 can be performed by the operators and constants shown in the table below.

Classification	Operator
Assignment	=
Bitwise AND	&, &=
Bitwise OR	,  =
Bitwise XOR	^, ^=
Logical AND	&&
Logical OR	
Equal	==
Not Equal	!=

- \*, & (pointer reference, address reference), and sizeof operations cannot be performed.
- When the -za option is specified, only \_\_boolean is enabled.
- In the case that sreg variables are used or if -rd, -rs, -rk (saddr automatic allocation option) options are specified, the number of usable bit type variables is decreased.

### [Example]

<C source>

```
#define ON      1
#define OFF    0

extern bit     data1 ;
extern bit     data2 ;

void main ( void ) {
    data1 = ON ;
    data2 = OFF ;
    while ( data1 ) {
        data1 = data2;
        testb ( );
    }

    if ( data1 && data2 ) {
        chgb ( );
    }
}
```

This example is for cases when the user has generated a definition code for a bit type variable. If an extern declaration has not been attached, the compiler outputs the following code. The ORG quasi-directive is not output in this case.

```

PUBLIC  _data1          ; Declaration
PUBLIC  _data2

@@BITS  BSEG           ; Allocation to segment
        ORG            0FE20H
_data1  DBIT
_data2  DBIT

```

The following codes are output in a function

```

set1    _data1          (Initialized)
clr1    _data2          (Initialized)
bf_     data1, $?L0001  (Judgment)
mov1    CY, _data2      (Assignment)
mov1    _data1, CY      (Assignment)
bf      _data1, $?L0005 (Logical AND expression)
bf      _data2, $?L0005 (Logical AND expression)

```

### [Compatibility]

#### (1) From another C compiler to the 78K0 C compiler

- The C source program need not be modified if the keyword bit, boolean, or \_\_boolean is not used.
- To change variables to bit or boolean type variables, modify the program according to the procedure described in USAGE above.

#### (2) From the 78K0 C compiler to another C compiler

- #define must be used. For details, see "[3.3.5 C source modifications](#)" (As a result of this, the bit or boolean type variables are handled as ordinary variables.).

**ASM statements (#asm - #endasm/ \_\_asm)**

The #asm and \_\_asm directives allow to use assembly language statements in C source code. The statements are embedded in the assembly source code generated by the C compiler.

**[Function]****(1) #asm - #endasm**

- The assembler source program described by the user can be embedded in an assembler source file to be output by the 78K0 C compiler by using the preprocessor directives #asm and #endasm.
- #asm and #endasm lines will not be output.

**(2) \_\_asm**

- An assembly instruction is output by describing an assembly code to a character string literal and is inserted in an assembler source.

**[Effect]**

- To manipulate the global variables of the C source in the assembler source
- To implement functions that cannot be described in the C source
- To hand-optimize the assembler source output by the C compiler and embed it in the C source (to obtain efficient object)

**[Usage]****(1) #asm #endasm**

- Indicate the start of the assembler source with the #asm directive and the end of the assembler source with the #endasm directive. Describe the assembler source between #asm and #endasm.

```
#asm
:      /* Assembler source */
#endasm
```

**(2) \_\_asm**

- The ASM statement is described in the following format in the C source:

```
__asm (string-literal);
```

- The description method of character string literal conforms to ANSI, and a line can be continued by using an escape character string (\n: line feed, \t: tab) or \, or character strings can be linked.

**[Restrictions]**

- Nesting of #asm directives is not allowed.

If ASM statements are used, no object module file will be created. Instead, an assembler source file will be created.

[Output assemble file] by [Compile Options] tab of Property panel, set it as "Yes." (See the "CubeSuite 78K0 build" for a setting method.)

- Only lowercase letters can be described for \_\_asm. If \_\_asm is described with uppercase and lowercase characters mixed, it is regarded as a user function.



- When the -za option is specified, only \_\_asm is enabled.
- #asm - #endasm and \_\_asm block can only be described inside a function of the C source. Therefore, the assembler source is output to CSEG of segment name @@CODE.

**[Example]****(1) #asm - #endasm**

&lt;C source&gt;

```
void main ( void ) {
#asm
    callt [init]
#endasm
}
```

&lt;Output object of compiler&gt;

```
@@CODE  CSEG
_main :
    callt [init]
    ret
    END
```

In the above example, statements between #asm and #endasm will be output as an assembler source program to the assembler source file.

**(2) \_\_asm**

&lt;C source&gt;

```
#pragma asm

int    a, b ;

void main ( ) {
    __asm ( "\tmovw ax, !_a \t ; ax <- a" );
    __asm ( "\tmovw !_b, ax \t ; b <- ax" );
}
```

&lt;Output object of compiler&gt;

```
@@CODE  CSEG
_main :
    movw    ax, !_a        ; ax <- a
    movw    !_b, ax        ; b <- ax
    ret
    END
```

**[Compatibility]**

- With the C compiler which supports #asm, modify the program according to the format specified by the C compiler.
- If the target device is different, modify the assembler source part of the program.

**Kanji (2-byte character) (*/\* kanji \*/*, *// kanji*)**

C source comments can contain kanji (multibyte Japanese characters).

**[Function]**

- Kanji code can be described in comments in C source files.
- Kanji code in comments is handled as a part of comments, so the code is not subject to compilation.
- The kanji code to be used in comments can be specified by using an option or the environment variable.  
If no option is specified, the code set in the environment variable LANG78K is set as the kanji code.
- If the kanji code is specified by both the option and environment variable LANG78K, specification by the option takes precedence.
- If "SJIS" is set in the environment variable LANG78K, the type of kanji in comments is interpreted as shift JIS code.
- If "EUC" is set in the environment variable LANG78K, the compiler interprets this as meaning that the type of kanji in comments is EUC code.
- If "NONE" is set in the environment variable LANG78K, the compiler interprets this as meaning that comments do not contain kanji codes.
- SJIS code is specified by default.

**[Effect]**

- The use of kanji code allows Japanese programmers to describe easier-to-understand comments, which makes C source management easier.

**[Usage]**

- Set the kanji code by using a compiler option or environment variable. (Setting is not needed if the default setting is used.)

**(1) Setting by compiler option**

Set any of the options listed in the following table.

Option	Explanation
-zs	SJIS (shift JIS code)
-ze	EUC (EUC code)
-zn	NONE (kanji code not used)

**(2) Setting by environment variable LANG78K**

- Set "SJIS", "EUC" or "NONE". (Also describe it in files such as autoexec.bat, if necessary.)
- Specification of SJIS, EUC or NONE is not case-sensitive.
- Describe kanji characters in comments in C source files, in accordance with the one specified in LANG78K.

```
SET    LANG78K = SJIS  (shift JIS code)
SET    LANG78K = EUC   (EUC code)
SET    LANG78K = NONE  (kanji code not used)
```

**[Restrictions]**

- Only shift JIS code and EUC code can be described in comments. Only the characters of 0x7F or lower ASCII codes can be described for places other than comments. Neither full-size characters nor half-size katakana (including half-size punctuation marks) can be described for any place other than comments. If any of these characters is described, the expected code may not be output.

**[Example]**

&lt;C source&gt;

```
// main function
void main ( void ) {
    /* Comment */
}
```

Kanji type information is output to the assembler source.

&lt;Output object of compiler&gt;

```
$KANJI CODE SJIS
```

When the C source contents are output to the assembler source, kanji characters in the comment are also output.

```
; line      1 : // main function
; line      2 : void main ( void ) {
@@CODE CSEG
_main :
; line      3 :          /* Comment */
; line      4 : }
```

**[Description]**

- Kanji code can be described only in comments in C source files.
- When using the format "// comment", specify compiler option -zp.

**[Compatibility]****(1) From another C compiler to the 78K0 C compiler**

- If there is kanji in the the area that comment cannot be described (the area other than "/\* ... \*/", or "// newline" ), the source files must be modified.
- If the kanji code differs from the one specified in the CC78K0R, the kanji code must first be converted.

**(2) From the 78K0 C compiler to another C compiler**

- The C source need not be modified for a C compiler that supports kanji characters to be described in comments.
- Kanji characters in the C source must be deleted if the C compiler does not support kanji characters to be described in comments.

**Interrupt functions (#pragma vect/#pragma interrupt)**

Generate the interrupt vector table, and output object code required by interrupt.

**[Function]**

- The address of a described function name is registered to an interrupt vector table corresponding to a specified interrupt request name.
- An interrupt function outputs a code to save or restore the following data (except that used in the ASM statement) to or from the stack at the beginning and end of the function (after the code if a register bank is specified):
  - Registers
  - saddr area for register variables
  - saddr area for arguments/auto variables of norec function (regardless of whether the arguments or variables are used)
  - saddr area for run time library (normal model only)

Note, however, that depending on the specification or status of the interrupt function, saving/restoring is performed differently, as follows:

- If no change is specified, codes that change the register bank or saves/restores register contents, and that saves/restores the contents of the saddr area are not output regardless of whether to use the codes or not.
- If a register bank is specified, a code to select the specified register bank is output at the beginning of the interrupt function, therefore, the contents of the registers are not saved or restored.
- If no change is not specified and if a function is called in the interrupt function, however, the entire register area is saved or restored, regardless of whether use of registers is specified or not.

**(1) Normal model**

If the -qr option is not specified during compiling, the saddr area for register variable and the saddr area for the arguments/auto variable of the norec function are not used; therefore, the saving/restoring code is not output. If the size of the saving code is smaller than that of the restoring code, the restoring code is output.

The following table summarizes the above and shows the saving/restoring area.

Save/Restore Are	NO BANK	Function Called				Function Not Called			
		Without -qr		With -qr		Without -qr		With -qr	
		Stack	RBn	Stack	RBn	Stack	RBn	Stack	RBn
Register used	NG	NG	NG	NG	NG	OK	NG	OK	NG
All registers	NG	OK	NG	OK	NG	NG	NG	NG	NG
saddr area for runtime library used	NG	NG	NG	NG	NG	OK	OK	OK	OK
saddr area for all runtime libraries	NG	OK	OK	OK	OK	NG	NG	NG	NG
saddr area for register variable used	NG	NG	NG	OK	OK	NG	NG	OK	OK
All saddr area for arguments/ auto variables of norec function	NG	NG	NG	OK	OK	NG	NG	NG	NG

- Stack : Use of stack is specified
- RBn : Register bank is specified
- OK : saved

NG : not saved

## (2) Static model

Since the saddr area for register variables, the saddr area for automatic variables or norec function arguments, and the saddr area for the runtime library are not used when the -sm option is specified during compiling, the save and restore code area is as follows.

Save/Restore Are	NO BANK	Function Called			
		Stack	RBn	Stack	RBn
Register used	NG	NG	NG	OK	NG
All registers	NG	OK	NG	NG	NG

Stack : Use of stack is specified  
 RBn : Register bank is specified  
 OK : saved  
 NG : not saved

However, when leafwork 1 to 16 has been specified, the code for saving and restoring the byte number to the stack is output from the higher-level address of shared area at the beginning and end of the interrupt function (see "[Static model](#)" when the -zm option is not specified. See "[Static model expansion specification \(-zm\)](#)" when the -zm option is specified).

**Caution** If there is an ASM statement in an interrupt function, and if the area reserved for registers of the compiler (area shown in above table) is used in that ASM statement, the area must be saved by the user.

### [Effect]

- Interrupt functions can be described at the C source level.
- Because the register bank can be changed, codes that save the registers are not output; therefore, object codes can be shortened and program execution speed can be improved.
- You do not have to be aware of the addresses of the vector table to recognize an interrupt request name.

### [Usage]

- Specify an interrupt request name, a function name, stack switching, registers used by the compiler, and whether the saddr area is saved/restored, with the #pragma directive. Describe the #pragma directive at the beginning of the C source. The #pragma directive is described at the start of the C source (for the interrupt request names, see the user's manual of the target device used). For the software interrupt BRK, describe BRK\_I.
- To describe #pragma PC (processor type), describe this #pragma directive after that.

The following items can be described before this #pragma directive:

- Comments
- Preprocessor directive which does neither define nor refer to a variable or a function

## (1) Normal model

```
#pragmaΔvect (or interrupt) Δinterrupt-request-nameΔfunction-nameΔ

    [stack change specification] Δ [ Use of stack is specified
                                   No change specification
                                   Register bank is specified ]
```

## (2) Static model

```
#pragmaΔvect (or interrupt) Δinterrupt-request-nameΔfunction-nameΔ

    [ Shared area save/restore specification ] Δ [ Use of stack is specified
    [ Save/restore target ]                   [ No change specification
                                             Register bank is specified ]
```

*- Interrupt request name*

Described in uppercase letters.

See the user's manual of the target device used (example: NMI, INTP0, etc.).

For the software interrupt BRK, describe BRK\_I.

*- Function name*

Name of the function that describes interrupt processing

*- Stack change specification*

SP = array name [+ offset location] (example: SP = buff + 10)

Define the array by unsigned char (example: unsigned char buff [10];).

*- Stack use specification*

STACK (default)

*- No change specification*

NOBANK

*- Register bank specification*

RB0/RB1/RB2/RB3

*- Shared area save/restore specification*

leafwork1 to 16

*- Save/restore target*

SAVE\_R Save/restore target limited to registers

SAVE\_RN Save/restore target limited to registers and @\_NRATxx (when -sm, -zm options are specified)

-Δ

Space

**Caution** Since the 78K0 C compiler startup routine is initialized to register bank 0, be sure to specify register banks 1 to 3. When saving shared area by the leafwork specification, the number of bytes specified needs to be same as the maximum bytes of the shared area secured in the -sm option of all modules.

**[Restrictions]**

- An interrupt request name must be described in uppercase letters.
- A duplication check on interrupt request names will be made within only 1 module.
- The contents of a register may be changed if the following three conditions are met, which the compiler cannot check.

If the register bank switching is set, set that they do not overlap. If register banks overlap, control their interrupts so that they do not overlap.

When NOBANK (no change specification) is specified, the registers are not saved. Therefore control the registers so that their contents are not lost.

- If two or more interrupts occur
  - If two or more interrupts that use the same BANK are included in the interrupt that has occurred
  - If NOBANK or a register bank is specified in the description `#pragma interrupt -`.
- As the interrupt function, `callt/ __callt/ callf/ __callf/ noauto/ norec/ __leaf/ __pascal/ __flash/ __flashf` cannot be specified.
  - An interrupt function is specified with void type (example: `void func (void);`) because it cannot have an argument nor return value.
  - Even if an ASM statement exists in the interrupt function, codes saving all the registers and variable areas are not output. If an area reserved for the compiler is used in the ASM statement in the interrupt function, therefore, or if a function is called in the ASM statement, the user must save the registers and variable areas.
  - If leafwork 1 to 16 is specified when the `-sm` option is not specified, a warning is output and the save/restore specification of the shared area is ignored.
  - When stack change is specified, the stack pointer is changed to the location where offset is added to the array name symbol. The area of the array name is not secured by the `#pragma` directive. It needs to be defined separately as global unsigned char/unsigned short type array.
  - The code that changes the stack pointer is generated at the start of a function, and the code that sets the stack pointer back is generated at the end of a function.
  - When keywords `sreg/ __sreg` are added to the array for stack change, it is regarded that two or more variables with the different attributes and the same name are defined, and a compile error will occur. It is possible to allocate an array in `saddr` area by the `-rd` option, but code and speed efficiency will not be improved because the array is used as a stack. It is recommended to use the `saddr` area for purposes other than a stack.
  - The stack change cannot be specified simultaneously with the no change. If specified so, an error will occur.
  - The stack change must be described before the stack use/register bank specification. If the stack change is described after the stack use/register bank specification, an error will occur.
  - If a function specifying no change, register bank, or stack change as the saving destination in `#pragma vect/ #pragma interrupt` specification is not defined in the same module, a warning message is output and the stack change is ignored. In this case, the default stack is used.



**[Example]****(1) When register bank is specified**

&lt;C source&gt;

```
#pragma interrupt NMI inter rb1

void inter ( ) {
    /* Interrupt processing to NMI pin input*/
}
```

&lt;Output object of compiler&gt;

```
@@CODE          CSEG
_inter :

    ; Switching code for the register bank
    ; Save code of the saddr area for use by the compiler
    ; Interrupt processing to NMI pin input (function body)
    ; Restore code of the saddr area used by the compiler
    reti

@@VECT02        CSEG    AT    02H ; NMI
_@vect02 :
    DW    _inter
```

**(2) When stack change and register bank are specified**

&lt;C source&gt;

```
#pragma interrupt INTP0 inter sp = buff + 10 rb2

unsigned char buff[10] ;

void func ( );

void inter ( ) {
    func ( );
}
```

&lt;Output object of compiler&gt;

```

@@CODE          CSEG
_inter :
    sel    RB2                ; Changes register bank
    push  ax                  ; Changes stack pointer
    movw  ax, sp              ;      :
    movw  sp, #_buff + 10    ;      :
    push  ax                  ;      :
    movw  ax, @_RTARG0       ; Saves saddr used by the compiler
    push  ax                  ;      :
    movw  ax, @_RTARG2       ;      :
    push  ax                  ;      :
    movw  ax, @_RTARG4       ;      :
    push  ax                  ;      :
    movw  ax, @_RTARG6       ;      :
    push  ax                  ;      :
    call  !_func
    pop   ax                  ; Restores saddr used by the compiler
    movw  @_RTARG6           ;      :
    pop   ax                  ;      :
    movw  @_RTARG4           ;      :
    pop   ax                  ;      :
    movw  @_RTARG2           ;      :
    pop   ax                  ;      :
    movw  @_RTARG0           ;      :
position
    pop   ax                  ; Returns the stack pointer to its original
    movw  sp, ax             ;      :
    pop   ax                  ;      :
    reti

@@VECT06        CSEG      AT      0006H
_@vect06 :
    DW    _inter

```

**(3) When a shared area save/restore is specified (static model only)**

&lt;C source&gt;

```

#pragma interrupt INTP0 inter leafwork4

void func ( );

void inter ( ) {
    func ( );
}

```

<Output object of compiler>

```

        EXTRN    @_KREG12
        EXTRN    @_KREG14

@@CODE        CSEG
_inter :
        push    ax            ; Saves register
        push    bc            ;      :
        push    hl            ;      :
        movw   ax, @_KREG12   ; Saves shared area
        push    ax            ;      :
        movw   ax, @_KREG14   ;      :
        push    ax            ;      :
        call   !_func
        pop     ax            ; Restores shared area
        movw   @_KREG14, ax   ;      :
        pop     ax            ;      :
        movw   @_KREG12, ax   ;      :
        pop     hl            ; Restores register
        pop     bc            ;      :
        pop     ax            ;      :
        reti

@@VECT06      CSEG    AT    0006H
_@vect06 :
        DW     _inter

```

### [Compatibility]

#### (1) From another C compiler to the 78K0 C compiler

- The C source program need not be modified if interrupt functions are not used at all.
- To change an ordinary function to an interrupt function, modify the program according to the procedure described in USAGE above.

#### (2) From the 78K0 C compiler to another C compiler

- An interrupt function can be used as an ordinary function by deleting its specification with the #pragma vect, #pragma interrupt directive.
- When an ordinary function is to be used as an interrupt function, change the program according to the specifications of each compiler.

### Interrupt function qualifier (`__interrupt`, `__interrupt_brk`)

It's possible to describe a vector table setting and an interrupt function definition in another file.

#### [Function]

- A function declared with the `__interrupt` qualifier is regarded as a hardware interrupt function, and execution is returned by the return RETI instruction for non-maskable/maskable interrupt function.
- By declaring a function with the `__interrupt_brk` qualifier, the function is regarded as a software interrupt function, and execution is returned by the return instruction RETB for software interrupt function.
- A function declared with this qualifier is regarded as (non-maskable/maskable/software) interrupt function, and saves or restores the registers and variable areas (1) and (4) below, which are used as the work area of the compiler, to or from the stack.  
If a function call is described in this function, however, all the variable areas are saved to the stack.

#### (1) Registers

#### (2) `saddr` area for register variables

#### (3) `saddr` area for arguments/auto variables of `norec` function (regardless of whether the arguments or variables are used)

#### (4) `saddr` area for run time library

**Remark** If the `-qr` option is not specified (default) at compile time, save/restore codes are not output because areas (2) and (3) are not used. If the `-sm` option is specified at compiling, save/restore codes are not output because areas (2), (3) and (4) are not used.

#### [Effect]

- By declaring a function with this qualifier, the setting of a vector table and interrupt function definition can be described in separate files.

#### [Usage]

- Describe either `__interrupt` or `__interrupt_brk` as the qualifier of an interrupt function.

#### (1) For non-maskable/maskable interrupt function

```
__interrupt void func ( ) {processing}
```

#### (2) For software interrupt function

```
__interrupt_brk void func ( ) {processing}
```

#### [Restrictions]

- The interrupt function cannot specify `callt`/`__callt`/`callf`/`__callf`/`noauto`/`norec`/`__leaf`/`__pascal`/`__flash`/`__flashf`.

**[Example]**

- Declare or define interrupt functions in the following format. The code to set the vector address is generated by `#pragma interrupt`.

```

#pragma interrupt      INTPO   inter  RB1   /*The interrupt request name of*/
#pragma interrupt      BRK_I   inter_b RB2   /*The software interrupt is "BRK_I"*/

__interrupt          void inter ( );          /*Prototype declaration*/
__interrupt_brk      void inter_b ( );        /*Prototype declaration*/
__interrupt          void inter ( ) {processing}; /*Function body*/
__interrupt_brk      void inter_b ( ) {processing}; /*Function body*/

```

**[Compatibility]****(1) From another C compiler to the 78K0 C compiler**

- The C source program need not be modified unless interrupt functions are supported.
- Modify the interrupt functions, if necessary, according to the procedure described in USAGE above.

**(2) From the 78K0 C compiler to another C compiler**

- `#define` must be used to allow the interrupt qualifiers to be handled as ordinary functions.
- To use the interrupt qualifiers as interrupt functions, modify the program according to the specifications of each compiler.

**[Cautions]**

- The vector address is not set by merely declaring this qualifier. The vector address must be separately set by using the `#pragma vect/interrupt` directive or assembler description.
- The `saddr` area and registers are saved to the stack.
- Even if the vector address is set or the saving destination is changed by `#pragma vect` (or `interrupt`) ..., the change in the saving destination is ignored if there is no function definition in the same file, and the default stack is assumed.
- To define an interrupt function in the same file as the `#pragma vect` (or `interrupt`) ... specification, the function name specified by `#pragma vect` (or `interrupt`) ... is judged as the interrupt function, even if this qualifier is not described. For details of `#pragma vect/interrupt`, see USAGE of "[Interrupt functions \(#pragma vect/#pragma interrupt\)](#)".

**Interrupt functions (#pragma DI, #pragma EI)**

Embed instructions to disable/enable interrupts in object code.

**[Function]**

- Codes DI and EI are output to the object and an object file is created.
- If the #pragma directive is missing, DI( ) and EI( ) are regarded as ordinary functions.
- If "DI();" is described at the beginning in a function (except the declaration of an automatic variable, comment, and preprocessor directive), the DI code is output before the preprocessing of the function (immediately after the label of the function name).
- To output the code of DI after the preprocessing of the function, open a new block before describing "DI();" (delimit this block with "{").
- If "EI();" is described at the end of a function (except comments and preprocessor directive), the EI code is output after the post-processing of the function (immediately before the code RET).
- To output the EI code before the post-processing of a function, close a new block after describing "EI();" (delimit this block with "}").

**[Effect]**

- A function disabling interrupts can be created.

**[Usage]**

- Describe the #pragma DI and #pragma EI directives at the beginning of the C source.  
However, the following statement and directives may precede the #pragma DI and #pragma EI directives:
  - Comment
  - Other #pragma directives
  - Preprocessor directive which does neither define nor refer to a variable or function
- Describe DI( ); or EI( ); in the source in the same manner as function call.
- DI and EI can be described in either uppercase or lowercase letters after #pragma.

**[Restrictions]**

- When using these interrupt functions, DI and EI cannot be used as function names.
- DI and EI must be described in uppercase letters. If described in lowercase letters, they will be handled as ordinary functions.

**[Example]**

```
#ifndef __K0__
#pragma DI
#pragma EI
#endif
```

<C source>

```
#pragma DI
#pragma EI

void main ( void ) {
    DI ( );
    ;Function body
    EI ( );
}
```

<Output object of compiler>

```
_main :
    di
    ; Preprocessing
    ; Function body
    ; Postprocessing
    ei
    ret
```

**(1) To output DI and EI after and before preprocessing/post-processing**

<C source>

```
#pragma DI
#pragma EI

void main ( void ) {
    {
        DI ( );
        ; Function body
        EI ( );
    }
}
```

<Output object of compiler>

```
_main :
    ; Preprocessing
    di
    ; Function body
    ei
    ; Postprocessing
    ret
```

**[Compatibility]****(1) From another C compiler to the 78K0 C compiler**

- The C source program need not be modified if interrupt functions are not used at all.
- To change an ordinary function to an interrupt function, modify the program according to the procedure described in USAGE above.

**(2) From the 78K0 C compiler to another C compiler**

- Delete the #pragma DI and #pragma EI directives or invalidate these directives by separating them with #ifdef and DI and EI can be used as ordinary function names (example: #ifdef \_\_K0\_\_ ... #endif).
- When an ordinary function is to be used as an interrupt function, modify the program according to the specifications of each compiler.



**CPU control instruction(#pragma HALT/STOP/BRK/NOP)**

The #pragma HALT/STOP/BRK/NOP directives declare functions that embed CPU control instructions.

**[Function]**

- The following codes are output to the object to create an object file:
- Instruction for HALT operation (HALT)
- Instruction for STOP operation (STOP)
- BRK instruction
- NOP instruction

**[Effect]**

- The standby function of a microcontroller can be used with a C program.
- A software interrupt can be generated.
- The clock can be advanced without the CPU operating.

**[Usage]**

- Describe the #pragma HALT, #pragma STOP, #pragma NOP, and #pragma BRK instructions at the beginning of the C source.
- The following items can be described before the #pragma directive:
  - Comment
  - Other #pragma directive
  - Preprocessor directive which does neither define nor refer to a variable or function
- The keywords following #pragma can be described in either uppercase or lowercase letters.
- Describe as follows in uppercase letters in the C source in the same format as function call:

```
HALT ( );  
STOP ( );  
BRK ( );  
NOP ( );
```

**[Restrictions]**

- When this feature is used, HALT, STOP, BRK, and NOP cannot be used as function names.
- Describe HALT, STOP, BRK, and NOP in uppercase letters. If they are described in lowercase letters, they are handled as ordinary functions.

**[Example]**

&lt;C source&gt;

```
#pragma HALT
#pragma STOP
#pragma BRK
#pragma NOP

void main ( void ) {
    HALT ( );
    STOP ( );
    BRK ( );
    NOP ( );
}
```

&lt;Output object of compiler&gt;

```
@@CODE CSEG
_main :
    halt
    stop
    brk
    nop
```

**[Compatibility]****(1) From another C compiler to the 78K0 C compiler**

- The C source program need not be modified if the CPU control instructions are not used.
- Modify the program according to the procedure described in USAGE above when the CPU control instructions are used.

**(2) From the 78K0 C compiler to another C compiler**

- If "#pragma HALT", "#pragma STOP", "#pragma BRK", and "#pragma NOP" statements are delimited by means of deletion or with #ifdef, HALT, STOP, BRK, and NOP can be used as function names.
- To use these instructions as the CPU control instructions, modify the program according to the specifications of each compiler.

**callf functions (callf/ \_\_callf)**

Stores the body of a function in the callf entry area and allow the calling of the function with a code shorter than that with the call instruction.

**[Function]**

- The callf instruction stores the body of a function in the callf entry area and allow the calling of the function with a code shorter than that with the call instruction.
- If a function stored in the callf area is referenced without prototype declaration, the function must be called by the ordinary call instruction.
- The callee (the function to be called) is the same as ordinary functions.

**[Effect]**

- The object code can be reduced.

**[Usage]**

- Add the callf attribute or \_\_callf attribute to the beginning of the function at the time of the function declaration.

callf extern	<i>type-name</i>	<i>function-name</i>
__callf extern	<i>type-name</i>	<i>function-name</i>

**[Restrictions]**

- Functions declared with callf will be located in the callf entry area. At which address in the area each function is to be located will be determined at the time of linking object modules. For this reason, when using any callf function in an assembler source module, the routine to be created must be made relocatable using symbols.
- A check on the number of callf functions is made at linking time.
- callf entry area: [800H to FFFH]
- The number of functions that can be declared with the callf attribute is not limited.
- The total number of functions with the callf attribute is not limited as long as the first function is within the range of [800H to FFFH].
- When the -za option is specified, only \_\_callf is enabled.
- When the -za option is specified, callf functions cannot be defined. If a callf function is defined, an error occurs.

[Example]

<pre>&lt;C source 1&gt; __callf extern int fsub ( );  void main ( ) {     int ret_val ;     ret_val = fsub ( ); }</pre>	<pre>&lt;C source 2&gt; __callf int fsub ( ) {     int val ;     return val ; }</pre>
<p>(Output object of compiler)</p> <pre>&lt;C source 1&gt;     EXTRN _fsub ; Declaration     callf !_fsub ; Call  &lt;C source 2&gt; (to be allocate to callf entry area)     PUBLIC _fsub ; Declaration  @@CALF CSEG FIXED _fsub : ; Function definition     :     ; function body     :</pre>	

[Compatibility]

(1) From another C compiler to the 78K0 C compile

- If the keyword, callf/\_\_callf is not used, the modification of the C source program is not needed. To change functions to callf function, modify the program according to the procedure described in Usage above.

(2) From the 78K0 C compiler to another C compiler

- Use #define. This allows callf functions to be handled as ordinary functions.

### Absolute address access function (#pragma access)

This function creates an object file by outputting the code that accesses the ordinary RAM space through direct in-line expansion.

#### [Function]

- This function creates an object file by outputting the code that accesses the ordinary RAM space through direct in-line expansion without using the function call.
- If the #pragma instruction is not described, a function accessing an absolute address is regarded as an ordinary function.

#### [Effect]

- A specific address in the ordinary memory space can be easily accessed through C description.

#### [Usage]

- Describe the #pragma access instruction at the beginning of the C source code.
- Describe the instruction in the source code in the same format as function call.
- The following items can be described before #pragma access:
  - Comment statement
  - Other #pragma instructions
  - Preprocessor instruction which does neither define nor refer to a variable or function
- The keywords following #pragma are not case-sensitive.

The following four function names are available for absolute address accessing:

```
peekb, peekw, pokeb, pokew
```

#### (1) List of functions for absolute address accessing

##### (a) unsigned char peekb ( *addr* ) ;

**unsigned int *addr* ;**

Returns 1-byte contents of address *addr*.

##### (b) unsigned int peekw ( *addr* ) ;

**unsigned int *addr* ;**

Returns 2-byte contents of address *addr*.

##### (c) void pokeb ( *addr*, *data* ) ;

**unsigned int *addr* ;**

**unsigned char *data* ;**

Writes 1-byte contents of *data* to the location indicated by address *addr*.

##### (d) void pokew ( *addr*, *data* ) ;

**unsigned int *addr* ;**

**unsigned int *data* ;**

Writes 2-byte contents of *data* to the location indicated by address *addr*.

**[Restrictions]**

- A function name for absolute address accessing must not be used.
- Describe functions for absolute address accessing in lowercase letters. Functions described in uppercase letters are handled as ordinary functions.

**[Example]**

&lt;C source&gt;

```
#pragma access

char   a ;
int    b ;

void main ( ) {
    a = peekb ( 0x1234 );
    a = peekb ( 0xfe23 );
    b = peekw ( 0x1256 );
    b = peekw ( 0xfe68 );

    pokeb ( 0x1234, 5 );
    pokeb ( 0xfe23, 5 );
    pokew ( 0x1256, 7 );
    pokew ( 0xfe68, 7 );
}
```

&lt;Output object of compiler&gt;

```
:      :
mov    a, !01234H
mov    !_a, a
mov    a, 0FE23H
mov    !_a, a
movw   ax, !01256H
movw   !_b, ax
movw   ax, 0FE68H
movw   !_b, ax

mov    a, #05H
mov    !01234H, a
mov    0FE23H, #05H
movw   ax, #07H
movw   !01256H, ax
movw   0FE68H, #07H
```

**[Compatibility]****(1) From another C compiler to the 78K0 C compile**

- If a function for absolute address accessing is not used, the modification of the C source program.
- Modify the functions to the one for absolute address accessing according to the procedure written in the Usage above.

**(2) From the 78K0 C compiler to another C compiler**

- Delimit the “#pragma access” statement by means of deletion or with #ifdef. A function name for absolute address accessing can be used.
- To use a function for absolute address accessing, the program must be modified according to the specifications of each compiler (#asm, #endasm, asm( ), etc.).

**Bit field declaration (Extension of type specifier)**

It's possible to declare bit-fields of type unsigned char, signed char, unsigned int, signed int, unsigned short, and signed short.

**[Function]**

- The bit field of unsigned char, signed char type is not allocated straddling over a byte boundary.
- The bit field of unsigned int, signed int, unsigned short, signed short type is not allocated straddling over a word boundary, but can be allocated straddling over a word boundary when the -rc option is specified.
- The bit fields that the types are same size are allocated in the same byte units (or word units).  
If the types are different size, the bit fields are allocated in different byte units (or word units).
- unsigned short, signed short type is handled similarly with unsigned int, signed int type respectively.

**[Effect]**

- The memory can be saved, the object code can be shortened, and the execution speed can be improved.

**[Usage]**

- As a bit field type specifier, unsigned char, signed char, signed int, unsigned short, signed short type can be specified in addition to unsigned int type.

Declare as follows.

```
struct tag-name {  
    unsigned char    field-name : bit-width ;  
    unsigned char    field-name : bit-width ;  
    :  
    unsigned int     field-name : bit-width ;  
};
```

**[Example]**

```
struct tagname {  
    unsigned char    A : 1 ;  
    unsigned char    B : 1 ;  
    :  
    unsigned int     C : 2 ;  
    unsigned int     D : 1 ;  
    :  
};
```



**[Compatibility]****(1) From another C compiler to the 78K0 C compiler**

- The source program need not be modified.
- Change the type specifier to use unsigned char, signed char, unsigned short, signed short as the type specifier.

**(2) From the 78K0 C compiler to another C compiler**

- The source program need not be modified if unsigned char, signed char, signed int, unsigned short and signed short is not used as a type specifier.
- Change into unsigned int, if unsigned char, signed char, signed int, unsigned short and signed short is used as a type specifier.

**Bit field declaration (Allocation direction of bit field)**

The -rb option changes the bit-field allocation order.

**[Function]**

- The direction in which a bit field is to be allocated is changed and the bit field is allocated from the MSB side when the -rb option is specified.
- If the -rb option is not specified, the bit field is allocated from the LSB side.

**[Usage]**

- Specify the -rb option at compile time to allocate the bit field from the MSB side.
- Do not specify the option to allocate the bit field from the LSB side.

**[Example]**

**(1) Bit field declaration 1**

```

struct t {
    unsigned char a : 1 ;
    unsigned char b : 1 ;
    unsigned char c : 1 ;
    unsigned char d : 1 ;
    unsigned char e : 1 ;
    unsigned char f : 1 ;
    unsigned char g : 1 ;
    unsigned char h : 1 ;
};
    
```

Because a through h are 8 bits or less, they are allocated in 1-byte units.

Bit allocation from MSB  
with the -rb option specified

Bit allocation from LSB  
without the -rb option specified

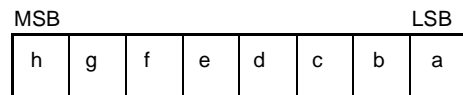
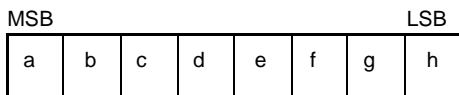

(2) Bit field declaration 2

```

struct t {
    char          a ;
    unsigned char b : 2 ;
    unsigned char c : 3 ;
    unsigned char d : 4 ;
    int           e ;
    unsigned int  f : 5 ;
    unsigned int  g : 6 ;
    unsigned char h : 2 ;
    unsigned int  i : 2 ;
};
    
```

Bit field allocated from the MSB side when the -rb option is specified

Bit field allocated from the LSB side when the -rb option is not specified

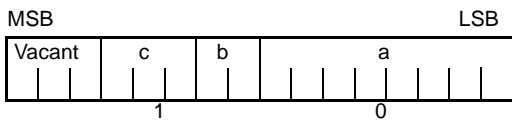
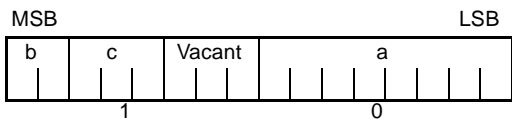

Member a of char type is allocated to the first byte unit. Members b and c are allocated to subsequent byte units, starting from the second byte unit. If a byte unit does not have enough space to hold the type char member, that member will be allocated to the following byte unit. In this case, if there is only space for 3 bits in the second byte unit, and member d has 4 bits, it will be allocated to the third byte unit.

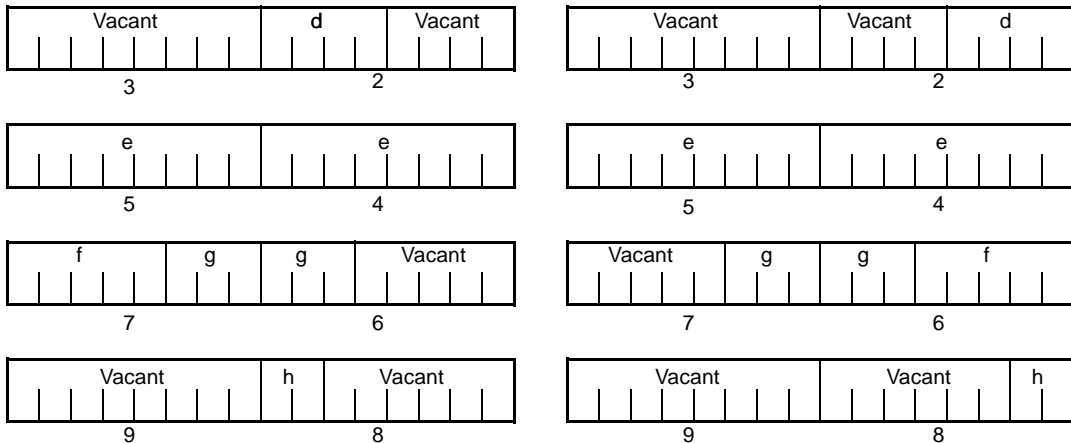

Since member g is a bit field of type unsigned int, it can be allocated across byte boundaries.

Since h is a bit field of type unsigned char, it is not allocated in the same byte unit as the g bit field of type unsigned int, but is allocated in the next byte unit.

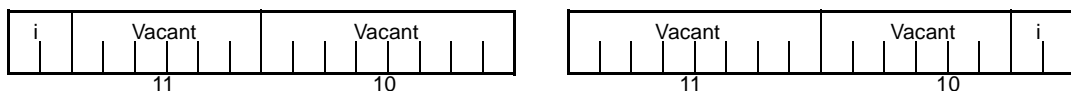

Since *i* is a bit field of type unsigned int, it is allocated in the next word unit.

When the `-rc` option is specified (to pack the structure members), the above bit field becomes as follows.

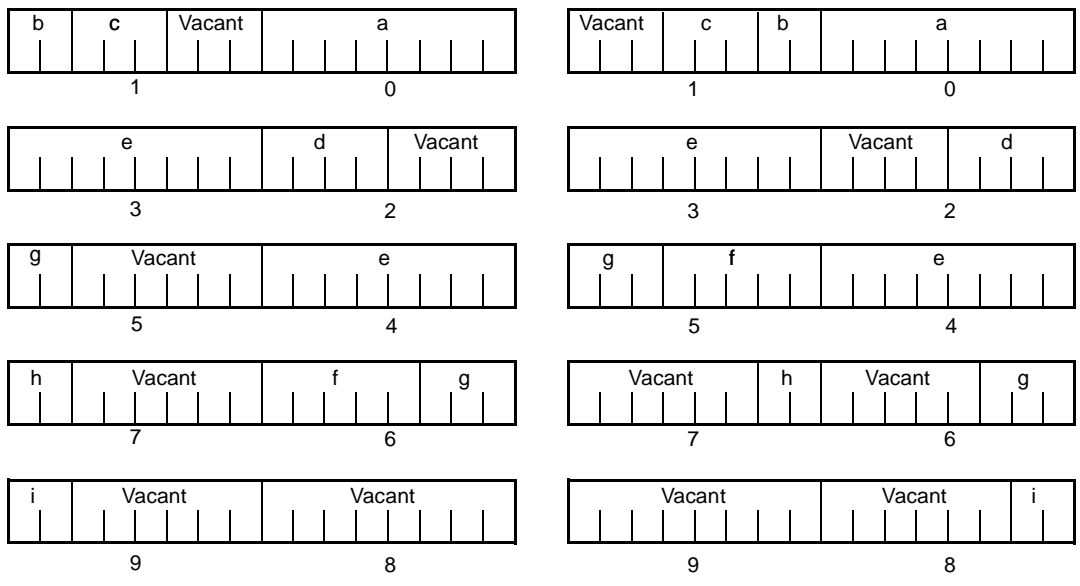

**Remark** The numbers below the allocation diagrams indicate the byte offset values from the beginning of the structure.

**(3) Bit field declaration 3**

```

struct t {
    char          a ;
    unsigned int  b : 6 ;
    unsigned int  c : 7 ;
    unsigned int  d : 4 ;
    unsigned char e : 3 ;
    unsigned int  f : 10 ;
    unsigned int  g : 2 ;
    unsigned int  h : 5 ;
    unsigned int  i : 6 ;
};
    
```

Bit field allocated from the MSB side when the `-rb` option is specified

Bit field allocated from the LSB side when the `-rb` option is not specified

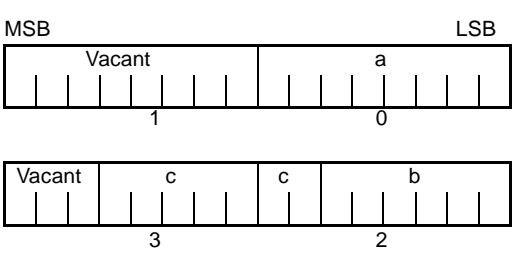
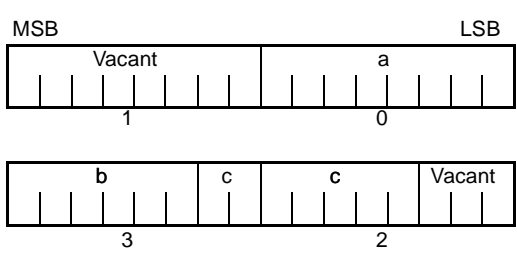

Since b and c are bit fields of type unsigned int, they are allocated from the next word unit.  
 Since d is also a bit field of type unsigned int, it is allocated from the next word unit.

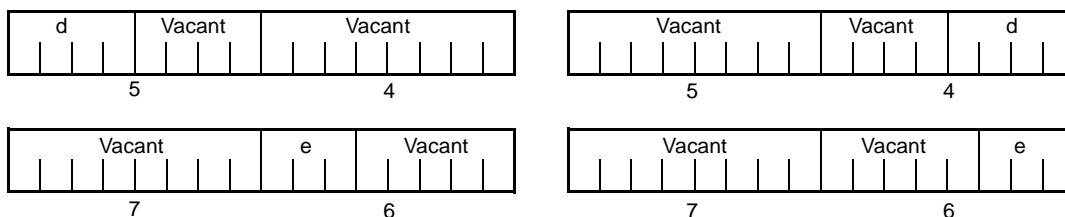

Since e is a bit field of type unsigned char, it is allocated to the next byte unit.

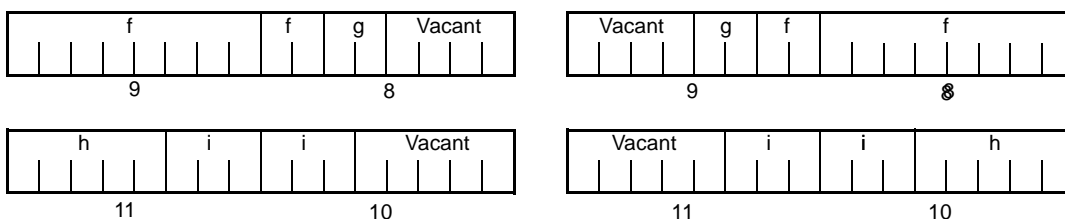

f and g, and h and i are each allocated to separate word units.

When the -rc option is specified (to pack the structure members), the above bit field becomes as follows.

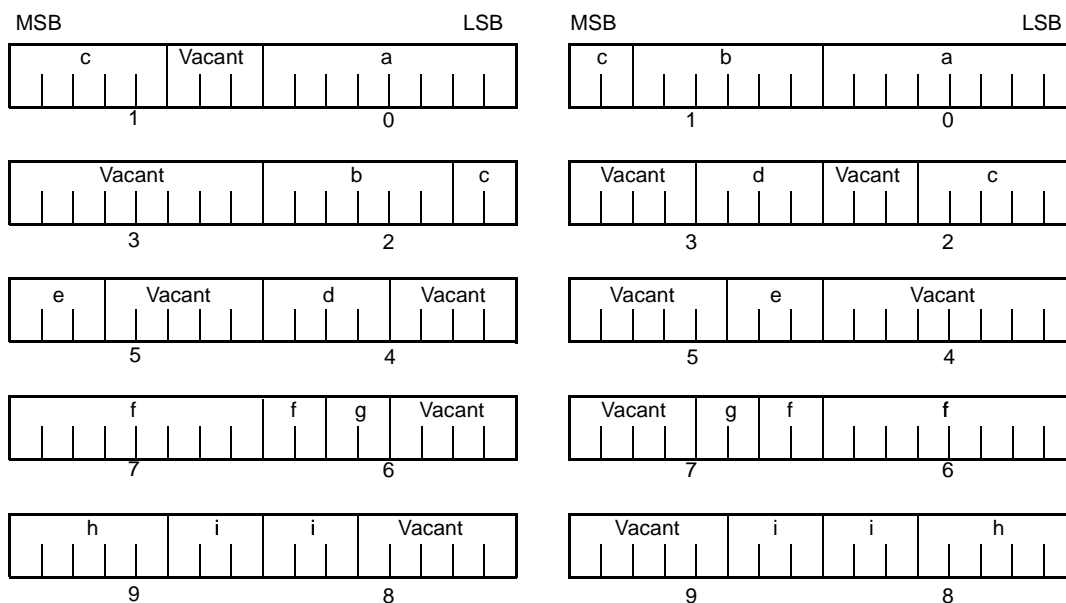

**Remark** The numbers below the allocation diagrams indicate the byte offset values from the beginning of the structure.

**[Compatibility]****(1) From another C compiler to the 78K0 C compiler**

- The source program need not be modified.

**(2) From the 78K0 C compiler to another C compiler**

- he source program must be modified if the -rb option is used and coding is performed taking the bit field allocation sequence into consideration.

### Changing compiler output section name (#pragma section ...)

Changing compiler output section name, and specifying the starting address.

#### [Function]

- A compiler output section name is changed and a start address is specified.  
If the start address is omitted, the default allocation is assumed. For the compiler output section name and default location, see "3.6 List of Segment Names".  
In addition, the location of sections can be specified by omitting the start address and using the link directive file at the time of link. For the link directives, see "5.1.1 Link directives".
- To change section names @@CALT, @@CALF with an AT start address specified, the callt, callf functions must be described before or after the other functions in the source file.
- If data are described after the #pragma instruction is described, those data are located in the data change section. Another change instruction is possible, and if data are described after the rechange instruction, those data are located in the rechange section.  
If data defined before a change are redefined after the change, they are located in the rechanged section. Furthermore, this is valid in the same way for static variables (within the function).

#### [Effect]

- Changing the compiler output section repeatedly in 1 file enables to locate each section independently, so that data can be located in data units to be located independently.

#### [Usage]

- Specify the name of the section which is to be changed, a new section name, and the start address of the section, by using the #pragma directive as indicated below.

Describe this #pragma directive at the beginning of the C source.

To describe #pragma PC (processor type), describe this #pragma directive after that.

The following items can be described before this #pragma directive:

- Comment
- Preprocessor directive which does neither define nor refer to a variable or a function

However, all sections in BSEG and DSEG, and the @@CNST section in CSEG can be described anywhere in the C source, and rechange instructions can be performed repeatedly. To return to the original section name, describe the compiler output section name in the changed section.

Declare as follows at the beginning of the file:

```
#pragma section compiler-output-section-name new-section-name [ AT startaddress ]
```

- Of the keywords to be described after #pragma, be sure to describe the compiler output section name in upper-case letters.  
section, AT can be described in either uppercase or lowercase letters, or in combination of those.
- The format in which the new section name is to be described conforms to the assembler specifications (up to 8 letters can be used for a segment name).
- Only the hexadecimal numbers of the C language and the hexadecimal numbers of the assembler can be described as the start address.

**(1) Hexadecimal numbers of C language**

```
0xn/0xn ... n
0Xn/0Xn ... n
(n = 0, 1, 2, 3, 4, 5, 6, 7, 8, 9, A, B, C, D, E, F)
```

**(2) Hexadecimal numbers of assembler**

```
nH/n ... nH
nh/n ... nh
(n = 0, 1, 2, 3, 4, 5, 6, 7, 8, 9, A, B, C, D, E, F)
```

The hexadecimal number must start with a numeral.

To example, to express a numeric value with a value of 255 in hexadecimal number, specify zero before F. It is therefore 0FFH.

- For sections other than the @@CNST section in CSEG, that is, sections which locate functions, this #pragma instruction cannot be described in other than the beginning of the C source (after the C text is described). If described, it causes an error.
  - If this #pragma instruction is executed after the C text is described, an assembler source file is created without an object module file being created.
  - If this #pragma instruction is after the C text is described, a file which contains this #pragma instruction and which does not have the C text (including external reference declarations for variables and functions) cannot be included. This results in an error (see "CODING ERROR EXAMPLE1").
  - #include statement cannot be described in a file which executes this #pragma instruction following the C text description. If described, it causes an error (see "CODING ERROR EXAMPLE2").
  - If #include statement follows the C text, this #pragma instruction cannot be described after this description. If described, it causes an error (see "CODING ERROR EXAMPLE3").
- But, when a body of C is in the header file, it isn't cause an error.

```
d1.h
    extern int      a;

d2.h
    #define VAR 1

d.c
    #include "d1.h";           // When there is a body of C and it's in #include,
    #include "d2.h"           // #pragma instruction of d.c isn't an error.
    #pragma section @@DATA ??DATA1
```

**[Restrictions]**

- A section name that indicates a segment for vector table (e.g., @@VECT02, etc.) must not be changed.
- If two or more sections with the same name as the one specifying the AT start address exist in another file, a link error will occur.
- Section names (@@BANK1, etc.) that indicate segments for bank function use cannot be changed.
- Specify the address within the range from 0FE20H - 0FEB7H for compiler output section names @@DATS, @@BITS and @@INIS.



**[Example]**

Section name @@CODE@@CODEL is changed to CC1 and address 2400H is specified as the start address.

<C source>

```
#pragma section @@CODE CC1 AT 2400H

void main ( ) {
    ; Function body
}
```

<Output object of compiler>

```
CC1 CSEG AT 2400H
_main :
    ; Preprocessing
    ; Function body
    ; Postprocessing
    ret
```

The following is a code example in which the main C code is followed by a #pragma directive.

The contents are allocated in the section following "//".

**(1) EXAMPLE1**

```
#pragma section @@DATA ??DATA
int a1 ; // ??DATA
sreg int b1 ; // @@DATS
int c1 = 1 ; // @@INIT and @@R_INIT
const int d1 = 1 ; // @@CNST
#pragma section @@DATS ??DATS
int a2 ; // ??DATA
sreg int b2 ; // ??DATS
int c2 = 1 ; // @@INIT and @@R_INIT
const int d2 = 1 ; // @@CNST
#pragma section @@DATA ??DATA2
// ??DATA is automatically closed and ??DATA2 becomes valid
int a3 ; // ??DATA2
sreg int b3 ; // ??DATS
int c3 = 3 ; // @@INIT and @@R_INIT
const int d3 = 3 ; // @@CNST
#pragma section @@DATA @@DATA
// ??DATA2 is closed and processing returns to the default @@DATA
#pragma section @@INIT ??INIT
#pragma section @@R_INIT ??R_INIT

int a4 ; // @@DATA
sreg int b4 ; // ??DATS
```

```

// ROMization is invalidated unless both names (@@INIT and @@R_INIT) are changed. This
// is the user's responsibility.
int          c4 = 1 ;                // ??INIT and ??R_INIT
const int    d4 = 1 ;                // @@CNST
#pragma section @@INIT              @@INIT
#pragma section @@R_INIT            @@R_INIT
// ??INIT and ??R_INIT are closed and processing returns to the default setting
#pragma section @@BITS              ??BITS
__boolean e4 ;                       // ??BITS
#pragma section @@CNST              ??CNST
char         *const p = "Hello" ;    // p and "Hello" are both ??CNSTT

```

**(2) EXAMPLE2**

```

#pragma section @@INIT              ??INIT1
#pragma section @@R_INIT            ??R_INIT1
#pragma section @@DATA              ??DATA1
char         c1 ;
int          i2 ;
#pragma section @@INIT              ??INIT2
#pragma section @@R_INIT            ??R_INIT2
#pragma section @@DATA              ??DATA2
char         c1 ;
int          i2 = 1 ;
#pragma section @@DATA              ??DATA3
#pragma section @@INIT              ??INIT3
#pragma section @@R_INIT            ??R_INIT3
extern char   c1 ;                   // ??DATA3
int          i2 ;                   // ??INIT3 と ??R_INIT3
#pragma section @@DATA              ??DATA4
#pragma section @@INIT              ??INIT4
#pragma section @@R_INIT            ??R_INIT4

```

Restrictions when this #pragma directive has been specified after the main C code are explained in the following coding error examples.

**(3) CODING ERROR EXAMPLE1**

```

a1.h
    #pragma section @@DATA ??DATA1    // File containing only the #pragma
                                       // section

a2.h
    extern int    func1( void );s
    #pragma section @@DATA ??DATA2    // File containing the main C code
                                       // followed by the #pragma directive.

```

```

a3.h
    #pragma section @@DATA ??DATA3          // File containing only the #pragma
                                           // section

a4.h
    #pragma section @@DATA ??DATA3
    extern int      func2 ( void );         // File that includes the main C code.

a.c
    #include "a1.h"
    #include "a2.h"
    #include "a3.h"                        // <- Error
                                           // Because the a2.h file contains the main C code
                                           // followed by this #pragma directive, file a3.h, which
                                           // includes only this #pragma directive, cannot be
                                           // included.

    #include "a4.h"

```

**(4) CODING ERROR EXAMPLE2**

```

b1.h
    const int i ;

b2.h
    const int j ;

    #include "b1.h"                        // This does not result in an error since it is not
                                           // file (b.c) in which the main C code is followed by
                                           // this #pragma directive.

b.c
    const int      k ;
    #pragma section @@DATA ??DATA1
    #include "b2.h"                        // <- Error
                                           // Since an #include statement cannot be coded afterward
                                           // in file (b.c) in which the main C code is followed by
                                           // this #pragma directive.

```

## (5) CODING ERROR EXAMPLE3

```

c1.h
extern int      j ;
#pragma section @@DATA ??DATA1 // This does not result in an error since the
                                // #pragma directive is included and
                                // processed before the processing of c3.h.

c2.h
extern int      k ;
#pragma section @@DATA ??DATA2 // <- Error
                                // This #include statement is specified after
                                // the main C code in c3.h, and the #pragma
                                // directive cannot be specified afterward.

c3.h
#include "c1.h"
extern int      i ;
#include "c2.h"
#pragma section @@DATA ??DATA3 // <- Error
                                // This #include statement is specified after
                                // the main C code, and the #pragma directive
                                // cannot be specified afterward.

c.c
#include "c3.h"
#pragma section @@DATA ??DATA4 // <- Error
                                // This #include statement is specified after
                                // the main C code in c3.h, and the #pragma
                                // directive cannot be specified afterward.

int      i ;

```

**[Compatibility]****(1) From another C compiler to the 78K0 C compiler**

- The source program need not be modified if the section name change function is not supported.
- To change the section name, modify the source program according to the procedure described in USAGE above.

**(2) From the 78K0 C compiler to another C compiler**

- Delete or delimit #pragma section ... with #ifdef.
- To change the section name, modify the program according to the specifications of each compiler.

**[Cautions]**

- A section is equivalent to a segment of the assembler.
- The compiler does not check whether the new section name is in duplicate with another symbol. Therefore, the user must check to see whether the section name is not in duplicate by assembling the output assemble list.
- When the -zf option has been specified, each section name is changed so that the second "@" is replaced with "E".
- If a section name<sup>Note</sup> related to ROMization is changed by using #pragma section, the startup routine must be changed by the user on his/her own responsibility.

**Note** ROMization-related section name

```
@@R_INIT, @@R_INIS, @@INIT, @@INIS
```

Here are examples of changing the startup routine (cstart.asm or cstartn.asm) and termination routine (rom.asm) in connection with changing a section name related to ROMization.

<C source>

```
#pragma section @@R_INIT      RTT1
#pragma section @@INIT       TT1
```

If a section name that stores an external variable with an initial value has been changed by describing #pragma section indicated above, the user must add to the startup routine the initial processing of the external variable to be stored to the new section.

To the startup routine, therefore, add the declaration of the first label of the new section and the portion that copies the initial value, and add the portion that declares the end label to the termination routine, as described below.

RTT1\_S and RTT1\_E are the names of the first and end labels of section RTT1, and TT1\_S and TT1\_E are the names of the first and end labels of section TT1.

**(1) Changing startup routine cstartx.asm****(a) Add the declaration of the label indicating the end of the section with the changed name**

```
:
EXTRN  _main, _exit, _@STBEG
EXTRN  _?R_INIT, _?R_INIS, _?DATA, _?DATS

EXTRN  RTT1_E, TT1_E          ; Adds EXTRN declaration of RTT1_E and TT1_E
:
```

- (b) Add a section to copy the initial values from the RTT1 section with the changed name to the TT1 section.

```

:
LDATS1 :
    MOVW    AX, HL
    CMPW    AX, #LOW_?DATS
    BZ      $LDATS2
    MOV     A, #0
    MOV     [HL], A
    INCW    HL
    BR      $LDATS1

LDATS2 :
    MOVW    DE, #TT1_S
    MOVW    HL, #RTT1_S

LTT1 :
    MOVW    AX, HL
    CMPW    AX, #RTT1_E
    BZ      $LTT2
    MOV     A, [HL]
    MOV     [DE], A
    INCW    HL
    INCW    DE
    BR      $LTT1

LTT2 :
;
    CALL    !_main ; main ( );
    MOVW    AX, #0
    CALL    !_exit ; exit ( 0 );
    BR      $$
;
    
```

Adds section to copy the initial values from the RTT1 section to the TT1 section

(c) Set the label of the start of the section with the changed name.

```

:
@@R_INIT      CSEG    UNITP
_@R_INIT :
@@R_INIS      CSEG    UNITP
_@R_INIS :
@@INIT        DSEG    UNITP
_@INIT :
@@DATA        DSEG    UNITP
_@DATA :
@@INIS        DSEG    SADDRP
_@INIS :
@@DATS        DSEG    SADDRP
_@DATS :

RTT1          CSEG    UNITP      ; Indicates the start of the RTT1 section
RTT1_S :      ; Adds the label setting
TT1           DSEG    UNITP      ; Indicates the start of the TT1 section
TT1_S :      ; Adds the label setting

@@CALT        CSEG    CALLT0
@@CALF        CSEG    FIXED
@@CNST        CSEG    UNITP
@@BITS        BSEG

;
END

```

## (2) Changing termination routine rom.asm

**Caution** Don't change the object module name "@rom" and "@rome".

## (a) Add the declaration of the label indicating the end of the section with the changed name

```

NAME          @rom
;
PUBLIC        _?R_INIT, _?R_INIS
PUBLIC        _?INIT, _?DATA, _?INIS, _?DATS

PUBLIC        RTT1_E, TT1_E          ; Adds RTT1_E, TT1_E

;
@@R_INIT     CSEG    UNITP
_?R_INIT :
@@R_INIS     CSEG    UNITP
_?R_INIS :
@@INIT       DSEG    UNITP
_?INIT :
@@DATA       DSEG    UNITP
_?DATA :
@@INIS       DSEG    SADDRP
_?INIS :
@@DATS       DSEG    SADDRP
_?DATS
:

```

## (b) Setting the label indicating the end

```

:
RTT1     CSEG    UNITP          ; Adds the label setting indicating the end of the
                                RTT1 section.
RTT1_E :                        ; Adds the label setting

TT1      DSEG    UNITP          ; Adds the label setting indicating the end of the
                                TT1 section.
TT1_E :                        ; Adds the label setting

;
                                END

```



**Binary constant (0bxxx)**

The compiler supports the 0bxxx notation for expressing binary constants in C source code.

**[Function]**

- Describes binary constants to the location where integer constants can be described.

**[Effect]**

- Constants can be described in bit strings without being replaced with octal or hexadecimal number. Readability is also improved.

**[Usage]**

- Describe binary constants in the C source.
- The following shows the description method of binary constants.

```
0b      binary-number
0B      binary-number
```

**Remark** Binary number: either "0" or "1".

- A binary constant has 0b or 0B at the start and is followed by the list of numbers 0 or 1.
- The value of a binary constant is calculated with 2 as the base.
- The type of a binary constant is the first one that can express the value in the following list.

Subscripted binary number:	int, unsigned int, long int, unsigned long int
Subscripted u or U:	unsigned int, unsigned long int
Subscripted l or L:	long int, unsigned long int
Subscripted u or U and subscripted l or L with:	unsigned long int

**[Example]**

<C source>

```
unsigned      i ;
i = 0b11100101 ;
```

Output object of compiler is the same as the following case.

```
unsigned      i ;
i = 0xE5 ;
```

**[Compatibility]****(1) From another C compiler to the 78K0 C compiler**

- Modifications are not needed.

**(2) From the 78K0 C compiler to another C compiler**

- Modifications are needed to meet the specification of the compiler if the compiler supports binary constants.
- Modifications into other integer formats such as octal, decimal, and hexadecimal are needed if the compiler does not support binary constants.

**Module name changing function (#pragma name)**

The module name of an object can be changed to any name in C source code.

**[Function]**

- Outputs the first 254 letters of the specified module name to the symbol information table in a object module file.
- Outputs the first 254 letters of the specified module name to the assemble list file as symbol information (MOD\_NAME) when the -g2 option is specified and as NAME pseudo instruction when the -ng option is specified.
- If a module name with 255 or more letters are specified, a warning message is output.
- If unauthorized letters are described, an error will occur and the processing is aborted.
- If more than one of this #pragma directive exists, a warning message is output, and whichever described later is enabled.

**[Effect]**

- The module name of an object can be changed to any name.

**[Usage]**

- The following shows the description method.

```
#pragma name    module-name
```

A module name must consist of the characters that the OS authorizes as a file name except "(", ")", and kanji (2-byte character).

Upper/lowercase is distinguished.

**[Example]**

```
#pragma name    module1
```

**[Compatibility]****(1) From another C compiler to the 78K0 C compiler**

- Modifications are not needed if the compiler does not support the module name changing function.
- To change a module name, modification is made according to USAGE above.

**(2) From the 78K0 C compiler to another C compiler**

- #pragma name ... is deleted or sorted by #ifdef.
- To change a module name, modification is needed depending on the specification of each compiler.

**Rotate function (#pragma rot)**

Outputs the code that rotates the value of an expression to the object with direct inline expansion.

**[Function]**

- Outputs the code that rotates the value of an expression to the object with direct inline expansion instead of function call and generates an object file.
- If there is not a #pragma directive, the rotate function is regarded as an ordinary function.

**[Effect]**

- Rotate function is realized by the C source or ASM description without describing the processing to perform rotate.

**[Usage]**

- Describe in the source in the same format as the function call.  
There are the following 4 function names.

```
rorb, rolb, rorw, rolw
```

**(1) unsigned char rorb ( x , y ) ;**

**unsigned char x ;**

**unsigned char y ;**

Rotates x to right for y times.

**(2) unsigned char rolb ( x , y ) ;**

**unsigned char x ;**

**unsigned char y ;**

Rotates x to left for y times.

**(3) unsigned int rorw ( x , y ) ;**

**unsigned int x ;**

**unsigned char y ;**

Rotates x to right for y times.

**(4) unsigned int rolw ( x , y ) ;**

**unsigned int x ;**

**unsigned char y ;**

Rotates x to left for y times.

**Caution** The above mentioned function declaration is not affected by the -zi option.

- Declare the use of the function for rotate by the #pragma rot directive of the module.  
However, the followings can be described before #pragma rot.
  - Comments
  - Other #pragma directives
  - Preprocessing directives which do not generate definition/reference of variables and definition/reference of functions
- Keywords following #pragma can be described in either uppercase or lowercase letters.

**[Restrictions]**

- The function names for rotate cannot be used as the function names.
- The function names for rotate must be described in lowercase letters. If the functions for rotate are described in uppercase letters, they are handled as ordinary functions.

**[Example]**

&lt;C source&gt;

```
#pragma rot
unsigned char  a = 0x11 ;
unsigned char  b = 2 ;
unsigned char  c ;

void main ( void ) {
    c = rorb ( a, b );
}
```

&lt;Output assembler source&gt;

```
mov    a, !_b
mov    c, a
mov    a, !_a
ror    a, 1
dbnz   c, $$-1
mov    !_c, a
```

**[Compatibility]****(1) From another C compiler to the 78K0 C compiler**

- Modification is not needed if the compiler does not use the functions for rotate.
- To change to functions for rotate, modifications are made according to USAGE above.

**(2) From the 78K0 C compiler to another C compiler**

- #pragma rot statement is deleted or sorted by #ifdef.
- To use as a function for rotate, modification is needed depending on the specification of each compiler (#asm, #endasm or asm( ) ; , etc.).

**Multiplication function (#pragma mul)**

Outputs the code that multiplies the value of an expression to the object with direct inline expansion.

**[Function]**

- Outputs the code that multiplies the value of an expression to the object with direct inline expansion instead of function call and generates an object file.
- If there is not a #pragma directive, the multiplication function is regarded as an ordinary function.

**[Effect]**

- The codes utilizing the data size of input/output of the multiplication instruction are generated. Therefore, the codes with faster execution speed and smaller size than the description of ordinary multiplication expressions can be generated.

**[Usage]**

- Describe in the same format as that of function call in the source.  
The following shows list of multiplication function.

```
mulu
```

**(1) unsigned int mulu ( x , y ) ;****unsigned char x ;****unsigned char y ;**

Performs unsigned multiplication of x and y.

- Declare the use of functions for multiplication by #pragma mul directive of the module.  
However, the followings can be described before #pragma mul.
  - Comments
  - Other #pragma directives
  - Preprocessing directives that do not generate definition/reference of variables and definition/reference of functions
- Keywords following #pragma can be described in either uppercase or lowercase letters.

**[Restrictions]**

- Multiplication functions are called by the library, if the target device does not have multiplication instructions.
- The function for multiplication cannot be used as the function names (when #pragma mul is declared).
- The function for multiplication must be described in lowercase letters. If they are described in uppercase letters, they are handled as ordinary functions.

**[Example]**

&lt;C source&gt;

```
#pragma mul

unsigned char  a = 0x11 ;
unsigned char  b = 2 ;
unsigned int   i ;

void main ( void ) {
    i = mulu ( a, b );
}
```

&lt;Output object of compiler&gt;

```
mov    a, !_b
mov    x, a
mov    a, !_a
mulu   x
movw   !_i, ax
```

**[Compatibility]****(1) From another C compiler to the 78K0 C compiler**

- Modifications are not needed if the compiler does not use the functions for multiplication.
- To change to functions for multiplication, modification is made according to USAGE above.

**(2) From the 78K0 C compiler to another C compiler**

- #pragma mul statement is deleted or sorted by #ifdef. Function names for multiplication can be used as the function names.
- To use as functions for multiplication, modification is needed depending on the specification of each compiler (#asm, #endasm or asm( ); , etc.).

**Division function (#pragma div)**

Outputs the code to divide the value of an expression to the object through direct in-line expansion.

**[Function]**

- Creates an object file by outputting the code that divides the value of an expression through direct in-line expansion without using the function call
- If there is not a #pragma directive, the function for division is regarded as an ordinary function.

**[Effect]**

- Utilize the data size of the division instruction I/O are generated. Therefore, codes with faster execution speed and smaller size than the description of ordinary division expressions can be generated.

**[Usage]**

- Describe in the same format as that of function call in the source.  
There are the following 2 functions for division.

```
divuw, moduw
```

**(1) unsigned int divuw ( x , y ) ;**

**unsigned int x ;**

**unsigned char y ;**

Performs unsigned division of x and y and returns the quotient.

**(2) unsigned char moduw ( x , y ) ;**

**unsigned int x ;**

**unsigned char y ;**

Performs unsigned division of x and y and returns the remainder.

**Caution** The above mentioned function declaration is not affected by the -zi option.

- Declare the use of the function for divisions by the #pragma div directive of the module.  
However, the followings can be described before #pragma div.
  - Comments
  - Other #pragma directives
  - Preprocessing directives which do not generate definition/reference of variables and definition/ reference of functions
- Keywords following #pragma can be described in either uppercase or lowercase letters.

**[Restrictions]**

- The division functions are called by the library, if the target device does not have division instructions.
- The function names for division cannot be used as the function names.
- The function names for division must be described in lowercase letters. If they are described in uppercase letters, they are handled as ordinary functions.



**[Example]**

&lt;C source&gt;

```
#pragma div

unsigned int    a = 0x1234 ;
unsigned char  b = 0x12 ;
unsigned char  c ;
unsigned int    i ;

void main ( void ) {
    i = divuw ( a, b );
    c = moduw ( a, b );
}
```

&lt;Output object of compiler&gt;

```
mov    a, !_b
mov    c, a
movw   ax, !_a
divuw  c
movw   !_i, ax
mov    a, !_b
mov    c, a
movw   ax, !_a
divuw  c
mov    a, c
mov    !_c, a
```

**[Compatibility]****(1) From another C compiler to the 78K0 C compiler**

- Modification is not needed if the compiler does not use the functions for division.
- To change to functions for division, modifications are made according to USAGE above.

**(2) From the 78K0 C compiler to another C compiler**

- #pragma div statement is deleted or sorted by #ifdef. The function names for division can be used as the function name.
- To use as a function for division, modification is needed depending on the specification of each compiler (#asm, #endasm or asm( ) ; , etc.).

**BCD operation function (#pragma bcd)**

Outputs the code that performs a BCD operation on the expression value in an object by direct inline expansion.

**[Function]**

- Outputs the code that performs a BCD operation on the expression value in an object by direct inline expansion rather than by function call, and generates an object file.  
However, bcdtob, btobcd, bcdtow, wtobcd and bbcd function are not developed inline.
- If there are no #pragma directives, the function for BCD operation is regarded as an ordinary function.

**[Effect]**

- Even if the process of the BCD operation is not described, the BCD operation function can be realized by the C source or ASM statements.

**[Usage]**

- The same format as that of a function call is coded in the source.  
There are 13 types of function name for BCD operation, as listed below.

**(1) unsigned char adbcdb ( x , y ) ;**

**unsigned char x ;**

**unsigned char y ;**

Decimal addition is carried out by the BCD adjustment instruction.

**(2) unsigned char sbbcdb ( x , y ) ;**

**unsigned char x ;**

**unsigned char y ;**

Decimal subtraction is carried out by the BCD adjustment instruction.

**(3) unsigned int adbcdb ( x , y ) ;**

**unsigned char x ;**

**unsigned char y ;**

Decimal addition is carried out by the BCD adjustment instruction (with result expansion).

**(4) unsigned int sbbcdb ( x , y ) ;**

**unsigned char x ;**

**unsigned char y ;**

Decimal subtraction is carried out by the BCD adjustment instruction (with result expansion).

If a borrow occurs, the high-order digits are set to 0x99.

**(5) unsigned int adbcdw ( x , y ) ;**

**unsigned int x ;**

**unsigned int y ;**

Decimal addition is carried out by the BCD adjustment instruction.

**(6) unsigned int sbbcdw ( x , y ) ;**

**unsigned int x ;**

**unsigned int y ;**

Decimal subtraction is carried out by the BCD adjustment instruction.

**(7) unsigned long adbcuwe ( x , y ) ;****unsigned int x ;****unsigned int y ;**

Decimal addition is carried out by the BCD adjustment instruction (with result expansion).

**(8) unsigned long sbbcuwe ( x , y ) ;****unsigned int x ;****unsigned int y ;**

Decimal subtraction is carried out by the BCD adjustment instruction (with result expansion).

If a borrow is occurred, the higher digits are set to 0x9999.

**(9) unsigned char bcdtob ( x ) ;****unsigned char x ;**

Values in decimal number are converted to binary number values.

**(10) unsigned int btobcde ( x ) ;****unsigned char x ;**

Values in binary number are converted to decimal number values.

**(11) unsigned int bcdtow ( x ) ;****unsigned int x ;**

Values in decimal number are converted to binary number values.

**(12) unsigned int wtobcd ( x ) ;****unsigned int x ;**

Values in decimal number are converted to binary number values.

However, if the value of x exceeds 10000, 0xffff is returned.

**(13) unsigned char btobcd ( x ) ;****unsigned char x ;**

Values in decimal number are converted to those in binary number.

However, the overflow is discarded.

**Caution** The above mentioned function declaration is not affected by the -zi and -zl options.

- Use of functions for division is declared by the module's #pragma bcd directive. The following items, however, can be coded before #pragma bcd.
  - Comments
  - Other #pragma directives
  - Preprocessing directives that do not generate definitions/sreferences of variables or function definitions/ references
- Either uppercase or lowercase letters can be used for keywords described after #pragma.

**[Restrictions]**

- BCD operation function names cannot be used as function names.
- The BCD operation function is coded in lowercase letters. If uppercase letters are used, these functions are regarded as an ordinary functions.
- The adbcuwe and sbbcuwe are not supported in the static model.

**[Example]**

&lt;C source&gt;

```
#pragma bcd

unsigned char  a = 0x12 ;
unsigned char  b = 0x34 ;
unsigned char  c ;

void main ( void ) {
    c = adbcdb ( a, b );
    c = sbbcdb ( b, a );
}
```

&lt;Output object of compiler&gt;

```
mov    a, !_a
add    a, !_b
adjba
mov    !_c, a
mov    a, !_b
sub    a, !_a
adjbs
mov    !_c, a
```

**[Compatibility]****(1) From another C compiler to the 78K0 C compiler**

- Corrections are not needed if functions for the BCD operations are not used.
- To change another function to the function for BCD operation, use the description above.

**(2) From the 78K0 C compiler to another C compiler**

- The #pragma bcd statements are either deleted or separated by #ifdef. A BCD operation function name can be used as a function name.
- If using "pragma bcd" as a BCD operation function, the changes to the program source must conform to the C compiler's specifications (#asm, #endasm or asm( ); etc.).

**Bank function**

Allocate the functions to the bank area or the common area.

**[Function]**

- Whether the functions are allocated to the bank area or the common area is specified using the function information file specification option, -mf.
- The functions allocated to the bank area (bank functions) are called by the library for calling bank functions.
- The functions allocated to the common area are called normally.
- If there is no source file information in the function information file which is specified by the function information file specification option -mf, add information to the file that the source file functions to be allocated to the common area.
- static functions are called normally.
- When calling the bank functions of the constant address, use the bank function reference functions \_\_BANK0, \_\_BANK1, ..., \_\_BANK15, having the constant address.  
See "[Bank function in a constant address](#)" for the details.
- Use the same function information file to all the source files that are to be linked. If two or more output object with different function information file are linked, an error occurs at linking time.
- If two or more output object with and without specifying the function information file are linked, an error occurs at linking time.

**[Effect]**

- Can be located at code block exceeding 64 KB.

**[Usage]**

- Specify the function information file using the function information file specification option, -mf for all the source files to be linked.
- Create a new file when the specified function information file does not exist.
- If there is no information on the source file in the specified function information file, add the function information of the source file to the file. The source file will be allocated to the common area.
- If the source file cannot be allocated and an error occurs at linking time, change some of the file locations to the bank area.
- Only the changes in destination locations are reflected.
- See User's Manual "78K0 Build" for how to edit the function information file.

The following is an example of the function information file.

```

/ #0xxxxx
// 78K/0 Series C Compiler Vx.xx Function Information File

file name := allocation(C ... common area, 0 - 15 ... bank number ) (code size)
{
    function name 1 ;
    function name 2 ;
}

// *** Code Size Information ***
// COMMON : total code size of the files that are specified to be allocated to the common

```

```
        area bytes
// BANK00 : total code size of the files that are specified to be allocated to bank 0 bytes
// BANK01 : total code size of the files that are specified to be allocated to bank 1 bytes
```

**[Restrictions]**

- Only the function body is allocated to the bank area. Data cannot be allocated to the bank area.
- All the functions in a file are allocated to the same bank.
- The bank function cannot specify `callt/callf/noauto/norec/__callt/__callf/__leaf/__interrupt/__interrupt_brk/`  
`__pascal/__flash/__flashf`.
- When `-mf` option is specified, `-sm` option is ignored.  
Static model cannot be used.
- When `-mf` option is specified, `-zr` option is ignored.  
Pascal function interface cannot be used.
- Only the destination location by a source file can be edited in the function information file.
- The code size of the ASM statement is not included in the output code size information within the function information file.  
Moreover, the size of the ROM data is not included. ROM data refers to the following types of data.
  - Segment for const variables
  - Unnamed string literals
  - Initial data for auto variables
- Comment statements cannot be written in the function information file.
- An output code changes both at from and to the function call if functions are allocated to the bank area. If the source file location is changed, compile the source file of the from/to function call again.
- If the function size in a file is bigger than the bank area, it cannot be allocated to the bank area.
- The following functions cannot be allocated to the bank area.
  - Startup routine
  - Library
  - Interrupt functions
  - `callt` functions, `callf` functions
  - `noauto` functions, `norec` functions, `pascal` functions

**[Example]**

Compile each source file using the same function information name by specifying the function information file specification option, -mf.

- a.c

```
extern int    func1 ( );
extern int    func2 ( );
int    func3 ( );

int    a = 0, b ;
void func ( ) {
    b = func1 ( a );
    :
    b = func2 ( a );
    :
    b = func3 ( a );
}

int    func3 ( int a ) {
    :
}
```

- b.c

```
int    func1 ( int a ) {
    :
}
```

- c.c

```
int    func2 ( int a ) {
    :
}
```

Create the function information file as follows.

```
/ #0xxxx
// 78K/0 Series C Compiler Vx.xx Function Information File

a.c    := C    (3000)    <- File a.c is allocated to the common area.
{
    func ;
    func3 ;
}

b.c    := C    (1000)    <- File b.c is allocated to the common area.
```

```

{
    func1 ;
}

c.c := C (2500) <- File c.c is allocated to the common area.
{
    func2 ;
}

// *** Code Size Information ***
// COMMON      : 6500 byte
// BANK00      : 0 bytes
// BANK01      : 0 bytes
// BANK02      : 0 bytes

```

The function information file that is created first is set to allocate all the files to the common area.

If all the files cannot be allocated to the common area, an error occurs at linking time. If this happens, edit the function information file to allocate some of the source file to the bank area referring to the information of the output code size within the function information file.

The following is an example of the edited function information file.

```

/ #0xxxx
// 78K0 Series C Compiler Vx.xx Function Information File

a.c := 0 (3000) <- File a.c is allocated to bank 0.
{
    func ;
    func3 ;
}

b.c := 1 (1000) <- File b.c is allocated to bank 1.
{
    func1 ;
}

c.c := C (2500) <- File c.c is allocated to common area.
{
    func2 ;
}

// *** Code Size Information ***
// COMMON      : 6500 byte
// BANK00      : 0 bytes
// BANK01      : 0 bytes
// BANK02      : 0 bytes

```



The code size of the function changes with changing the file location.

Specify the edited function information file with the function information file specification option -mf and compile again.

The compiler output objects that makes each file to be allocated to the common/bank area according to the function information file.

An output object of the compiler is as follows.

```

@@BANK0 CSEG      BANK0
_func :
      :
      push   hl
      movw  hl, #_func1
      mov   e, #BANKNUM _func1
      callt [@@bcall]
      pop   hl
      :
      call  !_func2
      :
      push  hl
      movw  hl, #_func3
      callt [@@bcals]
      pop   hl
      :

_func3 :
      :

@@BANK1 CSEG      BANK1
_func1 :
      :

@@CODE CSEG
_func2 :
      :

```

The bank function call routine that is supplied by the compiler is as follows.

```

@@CALT      CSEG      CALLT0
@@bcall :    DW        ?@bcall
@@bcals :   DW        ?@bcals

@@LCODE     CSEG
?@bcall :
      xch   a, e
      xch   a, BANK
      push  ax

```

```
    mov     a, e
    call   !@@bcsub
    pop    ax
    mov    BANK, a
    ret

?@bcals :
    push   de
    call   !@@bcsub
    pop    ax
    ret

@@bcsub :
    push   hl
    ret
```

**[Compatibility]****(1) From another C compiler to the 78K0 C compile**

- Modification is not needed.

**(2) From the 78K0 C compiler to another C compiler**

- Modification is not needed.

**[Caution]**

- When using bank (-mf), the size of the function pointer is 4 bytes.
- The functions allocated to the common area can be called faster than the functions allocated to the bank area.
- The functions allocated to the bank area are called slower because they are called through the bank function call routine.
- For the function call in the same bank area, the faster bank function call routine is used than in the different bank area.
- The functions can be called as the same speed as the ones allocated in the common area if the functions that are not called from the other file are changed to the static functions.
- If the source file is deleted or its name is changed, the original file information must be deleted from the .fin.

<b>Bank function in a constant address</b>
--

The bank function at the constant address can be called.

**[Function]**

- Generates codes that refer to the bank functions at constant address.
- This is only used with the devices with the bank.

**[Effect]**

- The bank function at the constant address can be called.

**[Usage]**

- Describe the directive in the source code in uppercase letters in the same format as function call.
- The function names for the bank function reference function of the constant address are `__BANK0`, `__BANK1`,..., `__BANK15`.

**(1) Function list for the bank function reference function with the constant address**

```

unsigned long __BANK0 ( unsigned int addr );
unsigned long __BANK1 ( unsigned int addr );
unsigned long __BANK2 ( unsigned int addr );
unsigned long __BANK3 ( unsigned int addr );
unsigned long __BANK4 ( unsigned int addr );
unsigned long __BANK5 ( unsigned int addr );
unsigned long __BANK6 ( unsigned int addr );
unsigned long __BANK7 ( unsigned int addr );
unsigned long __BANK8 ( unsigned int addr );
unsigned long __BANK9 ( unsigned int addr );
unsigned long __BANK10 ( unsigned int addr );
unsigned long __BANK11 ( unsigned int addr );
unsigned long __BANK12 ( unsigned int addr );
unsigned long __BANK13 ( unsigned int addr );
unsigned long __BANK14 ( unsigned int addr );
unsigned long __BANK15 ( unsigned int addr );

```

Total of 4 bytes data are obtained, which 2 bytes constant from *addr* are set in the lower 2 bytes, bank number is set above them, and the constant 1 which means bank function is set in the upper byte.

Only constants can be described in the arguments (*addr*). *addr* is a CPU address.

**[Restrictions]**

- For devices that have bank, the function names for the bank function reference function with the constant address cannot be used as functions.
- For devices that do not have bank, the bank function reference function with the constant address is described as normal function.
- Describe `__BANK0`, `__BANK1`,..., `__BANK15` in uppercase letters. If they are described in lowercase letters, they are handled as ordinary functions.

**[Example]**

&lt;C source&gt;

```

#define FUNC_CALL ( addr )      ( ( void ( * ) ( ) ) ( addr ) ) ( )
#define FUNC_ADDR ( addr )      ( void ( * ) ( ) ) ( addr )
void ( *fp ) ( );
void func ( ) {
    fp = FUNC_ADDR ( __BANK1 ( 0x8000 ) );
    FUNC_CALL ( 0x2000 );          /* Normal function call */
    FUNC_CALL ( __BANK2 ( 0x9000 ) ); /* Bank function call */
}

```

&lt;Output object of compiler&gt;

```

_func :
; line 6 :      fp = FUNC_ADDR ( __BANK1 ( 0x8000 ) );
               movw    ax, #08000H
               movw    !_fp, ax
               movw    ax, #0101H
               movw    !_fp + 2, ax
; line 7 :      FUNC_CALL ( 0x2000 );          /* Normal function call */
               call    !02000H
; line 8 :      FUNC_CALL ( __BANK2 ( 0x9000 ) ); /* Bank function call */
               push    hl
               movw    hl, #09000H
               mov     e, #02H
               vcallt  [@@bcall]
               vpop   hl
; line 9 :      }
               vret

```

**[Compatibility]****(1) From another C compiler to the 78K0 C compile**

- Modification is not needed if the bank function reference function with the constant address is not used.
- To change functions to the bank function reference function with the constant address, modify the program according to the procedure described in Usage above.

**(2) From the 78K0 C compiler to another C compiler**

- The names of the bank function reference functions with the constant address can be used as functions.
- To use a function for bank function reference function with the constant address, the program must be modified according to the specifications of each compiler.

**Data insertion function (#pragma opc)**

Inserts constant data into the current address.

**[Function]**

- Inserts constant data into the current address.
- When there is not a #pragma directive, the function for data insertion is regarded as an ordinary function.

**[Effect]**

- Specific data and instruction can be embedded in the code area without using the ASM statement. When ASM is used, an object cannot be obtained without the intermediary of assembler. On the other hand, if the data insertion function is used, an object can be obtained without the intermediary of assembler.

**[Usage]**

- Describe using uppercase letters in the source in the same format as that of function call.
- The function name for data insertion is \_\_OPC.

**(1) void \_\_OPC ( unsigned char x , ... );**

Insert the value of the constant described in the argument to the current address.

Arguments can describe only constants.

- Declare the use of functions for data insertion by the #pragma opc directive. However, the followings can be described before #pragma opc.
  - Comments
  - Other #pragma directives
  - Preprocessing directives which do not generate definition/reference of variables and definition/reference of functions
- Keywords following #pragma can be described in either uppercase or lowercase letters.

**[Restrictions]**

- The function names for data insertion cannot be used as the function names (when #opc is specified).
- \_\_OPC must be described in uppercase letters. If they are described in lowercase letters, they are handled as ordinary functions.

**[Example]**

<C source>

```
#pragma opc

void main ( ) {
    __OPC ( 0xBF );
    __OPC ( 0xA1, 0x12 );
    __OPC ( 0x10, 0x34, 0x12 );
}
```

<Output object of compiler>

```
_main :  
; line 4 : __OPC ( 0xBF );  
    DB      0BFH  
; line 5 : __OPC ( 0xA1, 0x12 );  
    DB      0A1H  
    DB      012H  
; line 6 : __OPC ( 0x10, 0x34, 0x12 );  
    DB      010H  
    DB      034H  
    DB      012H  
; line 7 : }  
    ret
```

### [Compatibility]

#### (1) From another C compiler to the 78K0 C compiler

- Modification is not needed if the compiler does not use the functions for data insertion.
- To change to functions for data insertion, use the USAGE above.

#### (2) From the 78K0 C compiler to another C compiler

- The #pragma opc statement is deleted or delimited by #ifdef. Function names for data insertion can be used as function names.
- To use as a function for data insertion, changes to the program source must conform to the specification of the C compiler (#asm, #endasm or asm( ) ; , etc.).

**Static model**

By specifying the `-sm` option during compiling, the object code can be reduced, execution speed can be improved, interrupt processing can be speeded up, and the memory can be saved.

**[Function]**

- All arguments are passed by registers (See "[3.4.5Static model function call interface](#)").
- Function arguments that are passed by registers are allocated in the function-specific static area.
- Automatic variables are allocated to the function-specific static area.
- In the case of the leaf function<sup>Note</sup>, arguments and automatic variables are allocated to the `saddr` area below `0FEDFH`, in the order of description starting from the high-order addresses. Since the `saddr` area is commonly used by the leaf functions of all modules, this area is referred to as the shared area. The maximum size of the shared area is defined by the parameter when the `-sm` option is specified.

```
-sm[nn]:nn = 0 - 16
```

`nn` bytes are assigned as shared area and the rest are allocated to the function-specific static area. If `nn = 0` is specified or this specification is omitted, the shared area is not used.

**Note** For the functions that do not call functions, it is not necessary to describe `norec/_leaf` since the compiler executes automatic determination.

- It is possible to add the `sreg/_sreg` keywords to function arguments and automatic variables. Function arguments and automatic variables that have the `sreg/_sreg` keywords added are allocated to the `saddr` area. As a result, bit manipulation becomes possible.
- By specifying the `-rk` option, function arguments and automatic variables (except for the static variables in functions) are allocated to `saddr` and bit manipulation becomes possible (see "[How to use the saddr area \(sreg/\\_sreg\)](#)").
- The compiler executes the following macro definition automatically.

```
#define __STATIC_MODEL__ 1
```

**[Effect]**

- Normally, instructions that access the static area are shorter and faster than those that access static frames. Accordingly, it is possible to reduce object codes and improve execution speed.
- As the save/restore processing of arguments and variables that use the `saddr` area (register variables in interrupt functions, `norec` function argument/automatic variables, run time library arguments) is not performed, it is possible to increase the speed of interrupt processing.
- Memory space can be saved since the data area is commonly used by several leaf functions.

**[Usage]**

- Specify the `-sm` option during compiling.  
The object in this case is called the static model, while the object without specification of the `-sm` option is called normal model.

**[Restrictions]**

- Cannot be linked with modules of the normal model. However, modules of a static model can be linked each other even if the maximum size of the shared area is different.
- Floating-point numbers are not supported. If the float and double keywords are described, a fatal error occurs.
- Arguments are limited to a maximum of 3 arguments and 6 bytes in total.
- Variable length arguments cannot be used since arguments are not passed on stacks. Using variable length arguments causes an error.
- Arguments and return values of structures/unions cannot be used. The description of these arguments and values causes an error.
- The noauto/norec/\_leaf functions cannot be used. A warning message is output and the descriptions are ignored (see "[noauto functions \(noauto\)](#)", "[norec functions \(norec\)](#)").
- Recursive functions cannot be used. As function arguments and the automatic variable area are statically secured, recursive functions cannot be used. An error is generated for recursive functions that can be detected by the compiler.
- A prototype declaration cannot be omitted. In spite of there is a function call, neither the entity definition nor the prototype declaration of the function exist, an error occurs.
- Due to the restrictions of arguments and return value, and inability to use recursive functions, some standard libraries cannot be used.
- If the -zl option is not specified, a warning is output and processing is carried out as if the -zl option was specified. long types are therefore always regarded as int types (see "[Change from long type to int type \(-zl\)](#)").
- The optimization specification option -ql5 cannot be specified at the same time as the -sm option. If it is specified, a warning message (W0076) is output and the -ql5 option is replaced with the -ql4 option and processed.

**[Example]****(1) When -sm4 is specified**

&lt;C source&gt;

```
void sub ( char, char, char );

void main ( ) {
    char    i = 1 ;
    char    j, k ;
    j = 2 ;
    k = i + j ;
    sub ( i, j, k );
}

void sub ( char p1, char p2, char p3 ) {
    char    a1, a2 ;
    a1 = 1<<p1 ;
    a2 = p2 + p3 ;
}
```



&lt;Output object of compiler&gt;

```

@@DATA      DSEG      UNITP
L0003 :      DS        ( 1 )                ; Automatic variable k of function main
           DS        ( 1 )

; line 1 :   void sub ( char, char, char );
; line 2 :   void main ( ) {

@@CODE      CSEG
_main :
           push      de
; line 3 :   char    i = 1 ;
           mov       e, #01H                ; 1 ; Automatic variable i
; line 4 :   char    j, k ;
; line 5 :   j = 2 ;
           mov       d, #02H                ; 2 ; Automatic variable j
; line 6 :   k = i + j ;
           mov       a, e
           add       a, d                    ; Add i and j
           mov       !?L0003, a            ; k ; Substitute for K
; line 8 :   sub ( i, j, k );
           mov       h, a                    ; Pass k through register H
           push      de
           pop       bc                      ; Pass j through register B
           mov       a, e                    ; Pass i through register A
           call     !_sub
; line 9 :   }
           pop       de
           ret
; line 10 :  void sub ( char p1, char p2, char p3 )
; line 11 :  {
_sub :
           mov       l, a                    ; Allocate the 1st argument to l
           mov       a, h
           mov       @_KREG15, a            ; Allocate the 3rd argument to
           ; shared area
; line 12 :  char    a1, a2 ;
; line 13 :  a1 = 1<<p1 ;
           mov       a, l                    ; The 1st argument p1
           mov       c, a
           mov       a, #01H
           dec       c
           inc       c
           bz        $?L0006
           add       a, a

```

```

                dbnz    c, $$-2
?L0006 :
                mov     @_KREG14, a      ; a1      ; Automatic variable a1 is in the
                                           shared area
; line 14 :    a2 = p2 + p3 ;
                mov     a, b              ; The 2nd argument p2
                add     a, @_KREG15      ; p3      ; Adds the 3rd argument p3
                mov     @_KREG13, a      ; a2      ; Automatic variable a2 is in the
                                           shared area
; line 15 :    }
                ret

```

**[Compatibility]****(1) From another C compiler to the 78K0 C compile**

- When creating objects of normal model, source modification is not needed unless the -sm option is specified.
- To create a static model object, modifications should be made according to the method above.

**(2) From the 78K0 C compiler to another C compiler**

- Source modification is not needed if re-compiling is performed by another compiler.

**[Caution]**

- Since arguments/automatic variables are secured statically, the contents of arguments/automatic variables in recursive functions may be destroyed. An error occurs when the function calls itself directly. However, no error occurs when the function calls itself in the function called beforehand since the compiler cannot detect this processing.
- During an interruption, the contents of arguments/automatic variables may be destroyed if the function being processed is called by interrupt servicing (interrupt functions and functions that are called by interrupt functions).
- During an interruption, save/return of the shared area is not executed even when the functions being processed are using the shared area.

**Change from int and short types to char type (-zi)**

By specifying -zi option during compiling, int and short types are regarded as char type.

**[Function]**

- int and short types are regarded as char type. In other words, int and short descriptions become equal to a char description.
- Details of the type modification are given as follows (Some -qu options are affected).

Type Described in C Source	Option	Type after Modification
short, short int, int	With -qu	unsigned char
short, short int, int	Without -qu	signed char
unsigned short, unsigned short int, unsigned, unsigned int	-	unsigned char
signed short, signed short int, signed, signed int	-	signed char

- Outputs warning message to the line where the int or short keywords first appeared in C source code.
- The -qc option becomes effective regardless of whether it is specified. A warning message is output when -qc option is not specified, and the -qc option becomes enable.
- If the -za option is specified at the same time (such as the -zai option), a warning message is output (only when -w2 is specified).
- The statements that can describe the following type specifier and that can be omitted are regarded as char type.
- Arguments and returned values of functions
- Type specifier omitted variables/function declaration
- The compiler executes the following macro definition automatically.

```
#define __FROM_INT_TO_CHAR__ 1
```

- Some standard libraries cannot be used.

**[Usage]**

- Specify -zi option.

**[Restrictions]**

- -zi specified and -zi unspecified modules cannot be linked together.

**Change from long type to int type (-zl)**

By specifying the -zl option during compiling, long type is regarded as int type.

**[Function]**

- long type is regarded as int type. In other words, a long description becomes equal to an int description.
- Details of the type modification are given as follows.

Type Described in C Source	Type after Modification
unsigned long, unsigned long int	unsigned int
long, long int, signed long, signed long int	signed int

- Outputs warning message to the line where the long keyword first appeared in C source code.
- If the -za option is specified at the same time (such as the -zal option), a warning message is output (only when -w2 is specified).
- The compiler executes the following macro definition automatically.

```
#define __FROM_LONG_TO_INT__ 1
```

- Some standard libraries cannot be used.

**[Usage]**

- Specify -zl option.

**[Restrictions]**

- -zl specified and -zl unspecified modules cannot be linked together.

**Pascal function ( \_\_pascal)**

The correction of the stack used for the place of arguments during the function call is performed on the called function side, not on the side calling the function.

**[Function]**

- Generates the code that the correction of the stack used for the place of arguments during the function call is performed on the called function side, not on the side calling the function.

**[Effect]**

- Object code can be reduced if a lot of function call appears.

**[Usage]**

- Adds a \_\_pascal attribute to the beginning when a function is declared.

**[Restrictions]**

- The pascal function does not support variable length arguments. If a variable length argument is defined, a warning is output and the \_\_pascal keyword is disregarded.
- Pascal function cannot specify norec/\_\_interrupt/\_\_interrupt\_brk\_\_flash/\_\_flashf. If they are specified, in the case of the norec keyword, the \_\_pascal keyword is disregarded and in the case of the \_\_interrupt/\_\_interrupt\_brk/ \_\_flash/ \_\_flashf keywords, an error is output.
- If a prototype declaration is incomplete, it won't operate normally, so a warning message is output when a pascal function's entity definition or prototype declaration is missing.
- Pascal functions are not supported when the static model specification option (-sm) is specified. If -sm option is specified when using the pascal function, a warning message is output to the place where the \_\_ pascal keyword first appeared, and the \_\_ pascal keyword in the input file is ignored.

**[Example]**

<C source>

```
__pascal      int      func ( int a, int b, int c );

void main ( ) {
    int      ret_val ;

    ret_val = func ( 5, 10, 15 );
}

__pascal      int      func ( int a, int b, int c ) {
    return ( a + b + c );
}
```

<Output object of compiler>

```

_main :
    push    hl
    movw   ax, #0FH        ; A 4-byte stack is consumed by arguments
    push   ax              ;
    mov    x, #0AH        ;
    push   ax              ;
    mov    x, #05H        ;
    call   !_func
                                ; The stack is not modified here.

    movw   ax, bc
    movw   hl, ax
    pop    hl
    ret

_func :
    push   hl
    push   ax
    movw   ax, sp
    movw   hl, ax
    mov    a, [hl + 6]
    add    a, [hl]
    xch    a, x
    mov    a, [hl + 7]
    addc   a, [hl + 1]
    xch    a, x
    add    a, [hl + 8]
    xch    a, x
    addc   a, [hl + 9]
    movw   bc, ax
    pop    ax
    pop    hl
    pop    de              ; Obtains the return address
    pop    ax              ;
    pop    ax              ; The 4-byte stack that was consumed by the caller is
                                modified.

    push   de              ; Return address is reloaded
    ret

```

### [Description]

- The -zr option enables the change of all functions to the pascal function. However, if the pascal function is used for the functions that have few calls, the object code may increase.

**[Compatibility]****(1) From another C compiler to the 78K0 C compile**

- If the reserved word, `__pascal` is not used, modification is not needed.
- To change to the Pascal function, change according to the above method.

**(2) From the 78K0 C compiler to another C compiler**

- Use `#define`.
- By this conversion, the Pascal function is regarded as an ordinary function.

**Automatic pascal functionization of function call interface (-zr)**

When the -zr option is specified during compiling, all the functions except norec/ \_\_interrupt/ \_\_interrupt\_brk/ \_\_flash/ \_\_flashf/variable length argument functions are added \_\_pascal attributes.

[Function]

**[Function]**

- With the exception of norec/ \_\_interrupt/ \_\_interrupt\_brk \_\_flash/ \_\_flashf/variable length argument functions, \_\_pascal attributes are added to all functions.

**[Usage]**

- Specify the -zr option during compiling.

**[Restrictions]**

- -zr specified and -zr unspecified modules cannot be linked together. If they are linked, a link error occurs.
- Static model specification option (-sm) and the -zr option cannot be specified at the same time.  
If specified, a warning message is output and the -zr option is ignored.
- Since the mathematical function standard library does not support the pascal function, the -zr option cannot be used when the mathematical function standard library is used.

**Remark** For pascal function call interface, see "[3.4.6 Pascal function call interface](#)".



**Flash area allocation method (-zf)**

Enables locating a program in the flash area compiling with specifying the -zf option. Enables using function linking with a boot area object created without specifying the -zf option.

**Caution** Do not use this flash function for the devices that have no flash area self-rewriting function. Operation is not guaranteed if it is used.

This function enables the function of rewriting the flash memory of devices.

**[Function]**

- Generates an object file located in the flash area.
- External variables in the flash area cannot be referred to from the boot area.
- External variables in the boot area can be referred to from the flash area.
- The same external variables and the same global functions cannot be defined in a boot area program and a flash area program.

**[Effect]**

- Enables locating a program in the flash area.
- Enables using function linking with a boot area object created without specifying the -zf option.

**[Usage]**

- Specify the -zf option during compiling.

**[Restrictions]**

- Use startup routines or library for the flash area.

### Flash area branch table (#pragma ext\_table)

The #pragma directive specifies the starting address of the flash branch table. A startup routine and interrupt function can be located in the flash area and a function call can be performed from the boot area to the flash area.

**Caution** Do not use this flash function for the devices that have no flash area self-rewriting function. Operation is not guaranteed if it is used.

This function enables the function of rewriting the flash memory of devices.

#### [Function]

- Determines the first address of the branch table for the startup routine, the interrupt function, or the function call from the boot area to the flash area.
- 32 addresses from the first address of the branch table are dedicated for interrupt functions (including startup routine), and each of them occupies 3 bytes of area.
- The branch tables for ordinary functions are normally allocated after the "first address of the branch table + 3 \* 32". The branch table of the device with bank function 8 bytes and the one without bank function 3 bytes of area. Each of the branch tables occupies 4 bytes of area. See "[Function of function call from boot area to flash area \(#pragma ext\\_func\)](#)" for more information about ext\_func ID values.
- The branch table of the device with bank function  $3 * 32 + 8 * (\text{the ID maximum value of ext\_func} + 1)$  bytes of area.  
The branch table of the device without bank function  $3 * (32 + \text{the ID maximum value of ext\_func} + 1)$  bytes of area.  
See "[Function of function call from boot area to flash area \(#pragma ext\\_func\)](#)".

#### [Effect]

- A startup routine and interrupt function can be located in the flash area.
- A function call can be performed from the boot area to the flash area.

#### [Usage]

- The following #pragma instruction specifies the first address of the flash area branch table.

```
#pragma ext_table    branch-table-first-address
```

Describe the #pragma instructions at the beginning of the C source code.

- The following items can be described before the #pragma instruction:
  - Comment
  - #pragma instructions other than #pragma ext\_func, #pragma vect with -zf specification, #pragma interruptt.
  - Preprocessor instruction which does neither define nor refer to a variable or function

**[Restrictions]**

- The branch table is located at the first address of the flash area.
- If #pragma ext\_table does not exist before #pragma ext\_func, #pragma vect with -zf specification, #pragma interrupt, an error occurs.
- The first address of the branch table is 80H to 0FF80H. In the device with bank, the branch table cannot be located in the bank area. Match the first address value with the flash start address which is specified in the -zb linker option. If the address does not match, a link error occurs.
- 2000H is the default starting address of the interrupt service routine library vector table (\_@vect00 to \_@vect3e). The default of the start address of the branch table in the interrupt vector library is 2000H.
- To specify the value other than 2000H, reconfigure the library as shown below.

**(1) Change the first address of the branch table in the library for the interrupt vector**

Change the place of 2000H in ITBLTOP EQU 2000H of vect.inc in the NEC Electronics CubeSuite\CubeSuite\CA78K0\Vx.xx\Src\cc78k0\src folder to the specified address.

**(2) Update the library for the interrupt vector**

Run NEC Electronics CubeSuite\CubeSuite\CA78K0\Vx.xx\Src\cc78k0\bat\repvect.bat in command prompt, and update library by assembly. Copy the updated library in NEC Electronics CubeSuite\CubeSuite\CA78K0\Vx.xx\Src\cc78k0\lib to NEC Electronics CubeSuite\CubeSuite\CA78K0\Vx.xx\Lib78k0 to be used for link.

**Caution** The above folder may differ depending on the installation method.

**[Example]**

To generate a branch table after the address 2000H and place the interrupt function:

<C source>

```
#pragma ext_table      0x2000
#pragma interrupt      INTP0   intp

void intp ( void ) {
}
```

**(1) To place the interrupt function to the boot area (no -zf specified)**

<Output object of compiler>

```
                PUBLIC  _intp
                PUBLIC  _@vect06
@@CODE          CSEG
_intp :
                reti
@@VECT06        CSEG   AT      0006H
_@vect06 :
                DW      _intp
```

Sets the first address of the interrupt function in the interrupt vector table.

**(2) To place the interrupt function in the flash area (-zf specified)**

&lt;Output object of compiler&gt;

```

PUBLIC _intp
@EBCODE      CSEG
_intp :
            reti

@EVECT06     CSEG   AT      02009H
            br     !_intp

```

Sets the first address of the interrupt function in the branch table.

The address value of the branch table is  $2000H + 3 * (0006H / 2)$  since the first address of the branch table is 200CH and the interrupt vector address (2 bytes) is 0006H.

The interrupt vector library performs the setting of the address 2009H in the interrupt vector table.

&lt;Library for interrupt vector 06&gt;

```

PUBLIC @_vect06
@@VECT06     CSEG   AT      0006H
_@vect06 :
            DW     2009H

```

**[Compatibility]****(1) From another C compiler to the 78K0 C compiler**

- If #pragma ext\_table is not used, modification is not needed.
- To specify the first address of the flash area branch table, change the address in accordance with USAGE above.

**(2) From the 78K0 C compiler to another C compiler**

- Delete the #pragma ext\_table instruction or divide it by #ifdef.
- To specify the first address of the flash area branch table, the following change is required.

### Function of function call from boot area to flash area (#pragma ext\_func)

The #pragma instruction specifies the function name and ID value in the flash area called from the boot area. It becomes possible to call a function in the flash area from the boot area.

**Caution** Do not use this flash function for the devices that have no flash area self-rewriting function. Operation is not guaranteed if it is used.

This function enables the function of rewriting the flash memory of devices.

#### [Function]

- Function calls from the boot area to the flash area are executed via the flash area branch table.
- From the flash area, functions in the boot area can be called directly.

#### [Effect]

- It becomes possible to call a function in the flash area from the boot area.

#### [Usage]

- The following #pragma instruction specifies the function name and ID value in the flash area called from the boot area.

```
#pragma ext_func      function-name  ID-value
```

- This #pragma instruction is described at the beginning of the C source.
- The following items can be described before this #pragma instruction.
  - Comments
  - Instructions not to generate the definition/reference of variables or functions among the preprocess instructions.

#### [Restrictions]

- The ID value is set at 0 to 255 (0xFF).
- If #pragma ext\_table does not exist before #pragma ext\_func, an error occurs.
- For the same function with a different ID value and a different function with the same ID value, an error will occur. (1) and (2) below are errors.

(1) #pragma ext\_func f1 3  
#pragma ext\_func f1 4

(2) #pragma ext\_func f1 3  
#pragma ext\_func f2 3

- If a function is called from the boot area to the flash area and there is no corresponding function definition in the flash area, the linker cannot conduct a check. This is the user's responsibility.
- The callt, callf functions can only be located in the boot area. If the callt, callf functions are defined in the flash area (when the -zf option is specified), it results in an error.

**[Example]**

- In the case that the branch table is generated after address 2000H and functions f1 and f2 in the flash area are called from the boot area.

**(1) The device without bank**

&lt;C source&gt;

- Boot area side

```
#pragma ext_table      0x2000
#pragma ext_func       f1      3
#pragma ext_func       f2      4

extern void f1 ( void );
extern void f2 ( void );

void func ( void ) {
    f1 ( );
    f2 ( );
}
```

- Flash area side

```
#pragma ext_table      0x2000
#pragma ext_func       f1      3
#pragma ext_func       f2      4

void f1 ( void ) {
}

void f2 ( void ) {
}
```

- Remarks 1.** #pragma ext\_func f1 3 means that the branch destination to function f1 is located in branch table address  $2000H + 3 * 32 + 3 * 3$ .
- 2.** #pragma ext\_func f2 4 means that the branch destination to function f2 is located in branch table address  $2000H + 3 * 32 + 3 * 4$ .
- 3.**  $3 * 32$  bytes from the beginning of the branch table are dedicated to interrupt functions (including the startup routine).

&lt;Output object of compiler&gt;

- Boot area side (without -zf specification)

```
@@CODE  CSEG
_func :
    call    !02069H
    call    !0206CH
    ret
```

- Flash area side (with -zf specification)

```
@ECODE CSEG
_f1 :
    ret

_f2 :
    ret

@EXT03 CSEG AT 02069H
    br    !_f1
    br    !_f2
```

### (1) The device with bank function

<C source>

- Boot area side

```
#pragma    ext_table    0x2000
#pragma    ext_func     f1      3
#pragma    ext_func     f2      4

extern void f1 ( void );
extern void f2 ( void );

void func ( ) {
    f1 ( );
    f2 ( );
}
```

- Flash area side

```
#pragma    ext_table    0x2000
#pragma    ext_func     f1      3

void f1 ( ) {
}
```

- Flash area side(Common area allocate)

```
#pragma    ext_table 0x2000
#pragma    ext_func f2 4

void f2 ( ) {
}
```

**Remarks 1.** pragma ext\_func f1 3 means that the branch destination to function f1 is located in branch table address  $2000H + 3 \times 32 + 8 \times 3$ .

2. #pragma ext\_func f2 4 means that the branch destination to function f2 is located in branch table address  $2000H + 3 * 32 + 8 * 4$ .
3.  $3 * 32$  bytes from the beginning of the branch table is exclusively for interrupt functions (including the start-up routine).

<Output object of compiler>

- Boot area side (without -zf specification)

```

@@CODE CSEG
_func :
    push    hl
    call    !02078H
    pop     hl
    call    !02080H
    ret

```

- Flash area side (with -zf specification)

```

@@BANK0 CSEG    BANK0
_f1 :
    ret

@EXT03 CSEG    AT        02078H
    movw    hl, #_f1
    mov     e, #BANKNUM _f1
    br     !?@bcall

```

- Flash area side (Common area allocate)(with -zf specification)

```

@@ECODE CSEG
_f2 :
    ret

@EXT04 CSEG    AT        02080H
    br     !_f2
    DB     ( 5 )

```

### [Compatibility]

#### (1) From another C compiler to the 78K0 C compiler

- If the #pragma ext\_func is not used, no corrections are necessary.
- To perform the function call from the boot area to the flash area, make the change in accordance with USAGE above.

#### (2) From the 78K0 C compiler to another C compiler

- Delete the #pragma ext\_func instruction or divide it by #ifdef.
- To perform the function call from the boot area to the flash area, the following change is required.



### Firmware ROM function ( \_\_flash)

Adding \_\_flash attributes to the top of the program during interface library prototype declaration, you can describe the operation in terms with the firmware ROM at the C source code level.

**Caution** Do not use this flash function for the devices that have no flash area self-rewriting function. Operation is not guaranteed if it is used.

This function enables the function of rewriting the flash memory of devices.

#### [Function]

- This calls a firmware ROM function which self-writes to the flash memory via the interface library positioned between the firmware ROM function and the C language function.
- In the interface library call interface, the first argument is passed by the register and the second and subsequent arguments are transferred to the stack. The first argument's register is as follows.

1, 2-byte data	AX
4-byte data	AX (low-order), BC (high-order)

- It is necessary that the interface library be set to the return values in the following registers according to the size of return values.

1, 2-byte data	BC
4-byte data	BC (low-order), DE (high-order)

#### [Effect]

- The operations related to the firmware ROM function can be described at the C source code level.

#### [Usage]

- During interface library prototype declaration, \_\_flash attributes are added to the top.

#### [Restrictions]

- Function calls by a function pointer are not supported.
- When a function with \_\_flash is defined, an error occurs.
- When the static model is specified, 4-byte data are not supported.

#### [Compatibility]

##### (1) From another C compiler to the 78K0 C compile

- If the reserved word, \_\_flash is not used, modification is not needed.
- To change to the firmware ROM function, change according to the above method.

##### (2) From the 78K0 C compiler to another C compiler

- Use #define. (see "3.3.5C source modifications").
- In a CPU with a firmware ROM function or substitute function, it is necessary for the user to create an exclusive library to access that area.

**Method of int expansion limitation of argument/return value (-zb)**

The -zb option is specified during compiling, the object code is reduced and the execution speed improved.

**[Function]**

- When the type definition of the function return value is char/unsigned char, the int expansion code of the return value is not generated.
- When the prototype of the function argument is defined and the argument definition of the prototype is char/unsigned char, the int expansion code of the argument is not generated.

**[Effect]**

- The object code is reduced and the execution speed improved since the int expansion codes are not generated.

**[Usage]**

- The -zb option is specified during compiling.

**[Restrictions]**

- If the files are different between the definition of the function body and the prototype declaration to this function, the program may operate incorrectly.

**[Example]**

<C source>

```
unsigned char  func1 ( unsigned char x, unsigned char y );
unsigned char  c, d, e ;

void main ( void ) {
    c = func1 ( d, e );
    c = func2 ( d, e );
}

unsigned char  func1 ( unsigned char x, unsigned char y ) {
    return x + y ;
}
```

(1) When the **-zb** option is specified

&lt;Output object of compiler&gt;

```

_main :
; line 5 :      c = func1 ( d, e );
      mov     a, !_e
      mov     x, a                ; Do not execute int expansion
      push   ax
      mov     a, !_d
      mov     x, a                ; Do not execute int expansion
      call   !_func1
      pop    ax
      mov     a, c
      mov     !_c, a
; line 6 :      c = func2 ( d, e );
      mov     a, !_e
      mov     x, #00H            ; 0
      xch    a, x                ; Execute int expansion since there is no
                                ; prototype declaration
      push   ax
      mov     a, !_d
      mov     x, #00H            ; 0
      xch    a, x                ; Execute int expansion since there is no
                                ; prototype declaration
      call   !_func2
      pop    ax
      mov     a, c
      mov     !_c, a
      ret
; line 8 :      unsigned char  func1 ( unsigned char x, unsigned char y )
_func1 :
      push   hl
      push   ax
      movw   ax, sp
      movw   hl, ax
      mov    a, [hl]
      xch   a, x
      mov    a, [hl + 6]
      movw  hl, ax
; line 10 :     return x + y ;
      mov    a, l
      add   a, h
      mov    c, a                ; Do not execute int expansion
      pop   ax
      pop   hl
      ret

```

**[Compatibility]****(1) From another C compiler to the 78K0 C compiler**

- If the prototype declarations for all definitions of function bodies are not correctly performed, perform correct prototype declaration. Alternatively, do not specify the -zb option.

**(2) From the 78K0 C compiler to another C compiler**

- No modification is needed.

### Array offset calculation simplification method (-qw2)

Specifying the -qw2 option while compiling, offset calculation code is simplified, the object code can be reduced, and the execution speed can be improved.

#### [Function]

- When calculating the offset of char/unsigned char/int/unsigned int/short/unsigned short types and the index is an unsigned char-type variable, a code to calculate only low-order bytes is generated based on the presumption that there is no carry-over.
- When the -qw2 option is specified, a code to calculate only low-order bytes for the offset is generated only when referencing the sequence of the saddr area configuration with an unsigned char variable.

#### [Effect]

- As the offset calculation code is simplified, object code can be reduced and the execution speed can be improved.

#### [Usage]

- Specify the -qw2 option during compiling.

#### [Restrictions]

- -qw4 is not supported.

#### [Example]

<C source>

```

unsigned char      c ;
unsigned char      ary[10] ;
sreg unsigned char sary[10] ;

void main ( ) {
    unsigned char  a ;

    a = ary[c] ;
    a = sary[c] ;
}

```

#### (1) When -qw2 option is specified

<Output object of compiler>

```

_main :
    push    hl
; line 6 :    unsigned char a ;
; line 7 :
; line 8 :    a = ary[c] ;
    mov    a, !_c
    mov    c, a

```

```
    push    hl
    movw   hl, #_ary
    mov    a, [hl + c]
    pop    hl
    mov    l, a
; line 9 :    a = sary[c] ;
    mov    a, !_c
    add    a, #low ( _sary )
    mov    e, a                ; Calculate only low-order bytes
    mov    d, #0FEH ; 254
    mov    a, [de]
    mov    l, a
; line 10 : }
    pop    hl
    ret
```

**[Compatibility]****(1) From another C compiler to the 78K0 C compile**

- No modification is needed.

**(2) From the 78K0 C compiler to another C compiler**

- No modification is needed.

**Register direct reference function (#pragma realregister)**

An access to the register which is described by C can be performed easily by describing this function in the source in the same format as a function call and declaring the usage of this function following the #pragma realregister instruction of the module.

**[Function]**

- Output the code that accesses the object register with direct in-line expansion instead of function call, and generates an object file.
- When there is no #pragma instructions, the register direct reference function is regarded as an ordinary function.

**[Effect]**

- Due to the C description, register access can be performed easily.

**[Usage]**

- Describe the instruction in the source code in the same format as function call.  
There are 21 types of register direct reference function names.

(1) **unsigned char \_\_geta ( void ) ;**  
Obtains the value of the A register.

(2) **void \_\_seta ( unsigned char x ) ;**  
Sets x in the A register.

(3) **unsigned int \_\_getax ( void ) ;**  
Obtains the value of the AX register.

(4) **void \_\_setax ( unsigned int x ) ;**  
Sets x in the AX register.

(5) **bit \_\_getcy ( void ) ;**  
Obtains the value of the CY flag.

(6) **void \_\_setcy ( unsigned char x ) ;**  
Sets the lower 1 bit of x in the CY flag.

(7) **void \_\_set1cy ( void ) ;**  
Generates the set1 CY instruction.

(8) **void \_\_clr1cy ( void ) ;**  
Generates the clr1 CY instruction.

(9) **void \_\_not1cy ( void ) ;**  
Generates the not1 CY instruction.

(10) **void \_\_inca ( void ) ;**  
Generates the inc a instruction.

(11) **void \_\_deca ( void ) ;**

Generates the dec a instruction.

(12) **void \_\_ror ( void ) ;**

Generates the ror a, 1 instruction.

(13) **void \_\_rorca ( void ) ;**

Generates the rorc a, 1 instruction.

(14) **void \_\_rol ( void ) ;**

Generates the rol a, 1 instruction.

(15) **void \_\_rolca ( void ) ;**

Generates the rolc a, 1 instruction.

(16) **void \_\_shl ( void ) ;**

Generates the code that performs logical-shift of the A register 1 bit to the left.

(17) **void \_\_shr ( void ) ;**

Generates the code that performs a logical-shift of the A register 1 bit to the right.

(18) **void \_\_ashr ( void ) ;**

Generates the code that performs an arithmetic-shift of the A register 1 bit to the right.

(19) **void \_\_nega ( void ) ;**

Generates the code that obtains 2's complement in the A register.

(20) **void \_\_coma ( void ) ;**

Generates the code that obtains 1's complement in the A register.

(21) **void \_\_absa ( void ) ;**

Generates the code that obtains the absolute value of the A register.

- By using the #pragma realregister instruction in a module, use of register direct reference function is declared.

However, the following items can be described before #pragma realregister:

- Comment
- Other #pragma instructions
- Preprocessor instruction which does neither define nor refer to a variable or function

### [Restrictions]

- The function name for that register direct reference cannot be not used as function name. The register direct reference function is described in lowercase letters. If they are described in uppercase letters, they are handled as ordinary functions.
- The values of the A and AX registers, and the CY flag that are set by the \_\_seta, \_\_setax, and \_\_setcy functions are not retained in the next code generation.
- The timing that is referenced by A and AX registers, and the CY flag with the \_\_geta, \_\_getax, and \_\_getcy functions are corresponds to the evaluation sequence of the expression.



**[Example]**

&lt;C source&gt;

```

#pragma realregister
unsigned char  c = 0x88, d, e ;

void main ( ) {
    __seta ( c );           /* Sets the variable of C in A register */
    __shla ( );           /* Logically shifts 1 bit to left */
    d = __geta ( );       /* Sets the value of A register in variable d */
    if ( __getcy ( ) ) {  /* Refers CY (checks overflow) */
        e = 1 ;          /* Sets e to 1 when CY = = 1 */
    }
}

```

&lt;Output object of compiler&gt;

```

__main :
; line 5 :    __seta ( c );           /* Sets the variable of C in A register */
            mov     a, !_c
; line 6 :    __shla ( );           /* Logically shift 1 bit to left */
            add     a, a
; line 7 :    d = __geta ( );       /* Sets value of A register in variable d */
            mov     !_d, a
; line 8 :    if ( __getcy ( ) ) {  /* Refers CY (checks overflow) */
            bnc     $?L0003
; line 9 :    e = 1 ;              /* Sets e to 1 when CY = = 1 */
            mov     a, #01H ;1
            mov     !_e, a
?L0003 :
; line 10 :   }
; line 11 :   }
            ret

```

**[Compatibility]****(1) From another C compiler to the 78K0 C compile**

- If the register direct reference function is not used, modification is not needed.
- To change to the register direct referencing function, use the method above.

**(2) From the 78K0 C compiler to another C compiler**

- The "#pragma realregister" instruction should be deleted or delimited using #ifdef. Register direct reference function names can be used as function names.
- When using "pragma realregister" as a register direct reference function, the change to the source program must conform to the specification of the C compiler (#asm, #endasm, or asm();, etc.).

**[Caution]**

- There is no guarantee that CY, A, AX will be saved as intended before the register direct reference function is executed. Accordingly, it is recommended to use this function before values change by describing it in the first term of the expansion.

**[HL + B] based indexed addressing utilization method (-qe)**

Specifying the -qe option during compiling enables the object code to be reduced and the execution speed to be improved.

**[Function]**

- When the index is the unsigned char variable while referring the char/unsigned char-type arrangement and char/unsigned char-type pointer, codes that include [HL + B] based indexed addressing is generated.

**[Effect]**

- The object code is reduced and the execution speed improved.

**[Usage]**

- Specify the -qe option during compiling.

**[Restrictions]**

- The object code may increase in some source description.  
In the normal model, this function is disabled.

**[Example]**

<C source>

```
unsigned char  c, d ;
unsigned char  ary[10] ;
char          *p ;

void main ( ) {
    ary[c] *= d + 1 ;

    * ( p + c ) * = 4 ;
}
```

**(1) When -sm, -qce options are specified**

<Output object of compiler>

```
_main :
; line 6 :      ary[c] *= d + 1 ;
    mov     a, !_d
    inc    a
    mov     x, a
    mov     a, !_c
    mov     b, a
    movw   hl, #_ary
    mov     a, [hl + b] ; Uses [HL + B] based indexed addressing
    mulux
```

```
    mov     a, x
    mov     [hl + b], a ; Uses [HL + B] based indexed addressing
; line 7 :
; line 8 :     * ( p + c ) * = 4 ;
    mov     a, !_c
    mov     b, a
    movw    ax, !_p
    movw    hl, ax
    mov     a, [hl + b] ; Uses [HL + B] based indexed addressing
    add     a, a
    add     a, a
    mov     [hl + b], a ; Uses [HL + B] based indexed addressing
; line 9 :     }
    ret
```

### [Compatibility]

**(1) From another C compiler to the 78K0 C compile**

- Modification is not needed.

**(2) From the 78K0 C compiler to another C compiler**

- Modification is not needed.

<b>On-chip firmware self-programming subroutine direct call function (#pragma hromcall)</b>
---

The firmware self-programming subroutine called by C description can be performed easily by describing this function in the source in the same format as a function call and declaring the usage of this function following the #pragma hromcall instruction of the module.

**Caution** Do not use this flash function for the devices that have no flash area self-rewriting function. Operation is not guaranteed if it is used.

This function enables the function of rewriting the flash memory of devices.

### [Function]

- An object file is generated by the output of the on-chip firmware self-programming subroutine direct call code to an object with direct inline expansion instead of function call.
- When there is no #pragma instruction, the on-chip firmware self-programming subroutine direct call function is regarded as an ordinary function.
- The `__setup` function sets SP (stack pointer) to the specified address.
- The `__hromcall` function calls the specified address by switching the register bank to bank 3 temporarily and setting the function number in the C register and the entry RAM area beginning address in HL, respectively. The values in the B register are the return values.
- The `__hromcalla` function calls the specified address by switching the register bank to bank 3 temporarily and setting the function number in the C register and the entry RAM area beginning address in HL, respectively. The values in the A register are the return values.

### [Effect]

- Due to the C description, calling the on-chip firmware self-programming subroutine can be performed easily.

### [Usage]

- Describe the instruction in the source code in the same format as function call. The following 3 functions are on-chip firmware self-programming subroutine direct call function names.

#### (1) On-chip firmware self-programming subroutine direct call function list

**(a) unsigned char \_\_hromcall ( unsigned int *entryaddr* , unsigned char *funcno* , void \**entrydata* ) ;**

Calls the *entryaddr* address after switching to register bank 3 temporarily and setting *entrydata* in the HL register and *funcno* in the C register, respectively.

The values in the B register are the return values.

**(b) unsigned char \_\_hromcalla ( unsigned int *entryaddr* , unsigned char *funcno* , void \**entrydata* ) ;**

Calls the *entryaddr* address after switching to register bank 3 temporarily and setting *entrydata* in the HL register and *funcno* in the C register, respectively.

The values in the A register are the return values.

**(c) void \_\_setsp ( unsigned int *spaddr* ) ;**

Sets the value of *spaddr* in SP (stack pointer).

- The #pragma hromcall instruction in a module performs declaration of the use of on-chip firmware self-programming subroutine direct call.  
The following items can be described before #pragma hromcall:

- Comment
- Other #pragma instructions
- Preprocessor instruction which does neither define nor refer to a variable or function

**[Restrictions]**

- Function names for on-chip firmware self-programming subroutine direct call cannot be used for function name.
- This function is not available in devices that do not incorporate the BFA area in which the self-programming subroutine direct call is written.
- If the specifications of the on-chip firmware self-programming subroutine are not as follows, this function cannot be used.
  - Uses register bank 3
  - Sets function number in the C register
  - Sets the beginning address of the entry RAM area in the HL register
- Only a constant can be specified for the first and second arguments in the \_\_hromcall and \_\_hromcalla functions. If other than a constant is specified, an error occurs.

**[Example]**

&lt;C source&gt;

```

#pragma di
#pragma sfr
#pragma hromcall
unsigned char  entryram[32] ;
unsigned char  ret ;
void func ( ) {
    /* Interrupt disabled */
    DI ( );
    /* Enter self-programming mode */
    FLSPM0 = 1 ;

    /* Call __hromcall subroutine call */
    __hromcall ( 0x8100, 0, entryram );

    /*Set write time data*/
    entryram[7] = 0x20 ;
    /*Set delete time data*/
    entryram[8] = 0x4c ;
    entryram[9] = 0x4c ;
    entryram[10] = 0x00 ;
    /* Set convergence time data */
    entryram[11] = 0x01 ;
    entryram[12] = 0x3d ;
    /* Call __hromcall subroutine */
    ret = __hromcall ( 0x8100, 1, entryram );
    :
}

```

&lt;Output object of compiler&gt;

```

_func :
    di
; line 8 :      /* Interrupt disabled */
; line 9 :      DI ( );
; line 10 :     /* Enter self-programming mode */
; line 11 :     FLSPM0 = 1 ;
                setl    FLSPM0
; line 12 :
; line 13 :     /* Call __hromcall subroutine call */
; line 14 :     __hromcall ( 0x8100, 0, entryram );
                push   psw                ; Save current register bank
                sel    rb3                ; Switch to bank 3
                movw  hl, #_entryram
                mov   c, #00H            ; 0
                call  !08100H
                pop   psw                ; Return to current register bank
                mov   a, 0FEE3H
; line 15 :     /* Set write time data */
; line 16 :     entryram[7] = 0x20 ;
                mov   a, #020H            ; 32
                mov   !_entryram + 7, a
; line 17 :     /* Set delete time data */
; line 18 :     entryram[8] = 0x4c ;
                mov   a, #04CH            ; 76
                mov   !_entryram + 8, a
; line 19 :     entryram[9] = 0x4c ;
                mov   !_entryram + 9, a
; line 20 :     entryram[10] = 0x00 ;
                mov   a, #00H            ; 0
                mov   !_entryram + 10, a
; line 21 :     /* Set convergence time data */
; line 22 :     entryam[11] = 0x01 ;
                inc   a
                mov   !_entryram + 11, a
; line 23 :     entryram[12] = 0x3d ;
                mov   a, #03DH            ; 61
                mov   !_entryram + 12, a
; line 24 :     /* Calls __hromcall subroutine */
; line 25 :     ret = __hromcall ( 0x8100, 1, entryram );
                push   psw                ; Save current register bank
                sel    rb3                ; Switch to bank 3
                movw  hl, #_entryram
                mov   c, #01H            ; 1
                call  !08100H

```

```
pop    psw                ; Return to current bank register
mov    a, 0FEE3H
mov    !_ret, a
      :
      ret
```

**[Compatibility]****(1) From another C compiler to the 78K0 C compile**

- Modification is not needed if the on-chip firmware self-programming subroutine direct call function is not used.
- When changing to the on-chip firmware self-programming subroutine direct call function, use the method above.

**(2) From the 78K0 C compiler to another C compiler**

- The "#pragma hromcall" instruction should be deleted or delimited using #ifdef. Function names for on-chip firmware self-programming subroutine direct call can be used for function name.
- To use as "pragma hromcall" as the function for on-chip firmware self-programming subroutine direct call, changes to the source program must conform to the specification of each C compiler (#asm, #endasm, or asm();, etc).

**[Caution]**

- Before calling this function, arguments should be set in the entry RAM area. See relevant device user's manual for the values set in the entry RAM area.
- This function does not perform either interrupt disable processing or transition to self-programming mode processing. Accordingly, these processes should be performed before using this function.
- For the firmware entry address that is set in the \_\_hromcall and \_\_hromcalla function and values that are set in the function number, see the relevant device user's manual.



**\_\_flashf function ( \_\_flashf)**

Adding the \_\_flashf attributes to the top of the function during its declaration, a code which switches to bank save/restore and register bank 3 at each call is not generated when describing this function in the function.

**Caution** Do not use this flash function for the devices that have no flash area self-rewriting function. Operation is not guaranteed if it is used.

This function enables the function of rewriting the flash memory of devices.

**[Function]**

- After storing program status word in the stack at the beginning of a function, this function switches to interrupt disable and register bank 3.
- A program status word that is stored in the stack is restored at the end of a function.
- The function for "On-chip firmware self-programming subroutine direct call function (#pragma hromcall)" becomes valid regardless of whether or not the #pragma hromcall declaration exist.
- The function caller calls by setting arguments to A (1-byte data) or AX (2-byte data); the function definition side copies the arguments that are passed into A or AX to the saddr area ([FEBAH to FEBFH] in normal model).
- Automatic variables are allocated to the saddr area ([FEBAH to FEBFH] in normal model). So are the register variables.

**[Effect]**

- When "On-chip firmware self-programming subroutine direct call function (#pragma hromcall)" is written in a function in which the \_\_flashf attributes are added, a code, which switches to bank save/restore and register bank 3 at each call, is not generated.

**[Usage]**

- When a function is declared, a \_\_flashf attribute is added to the beginning.

**[Restrictions]**

- Functions other than "On-chip firmware self-programming subroutine direct call function (#pragma hromcall)" cannot be called from the \_\_flashf function.
- Only char/unsigned char/int/unsigned int/short/unsigned short/ pointer type of 1 argument can be defined for a function argument.
- Only char/unsigned char/int/unsigned int/short/unsigned short/ pointer type can be defined for return values and automatic variables.
- Only a maximum of 6 bytes can be defined for argument and automatic variables combined.
- A long type operation cannot be performed.

**[Example]**

<C source>

```
#pragma di
#pragma sfr
#pragma hromcall
unsigned char  entryram[32] ;
unsigned char  ret ;
__flashf      void func ( ) {
```

```

/* Move to self-programming mode */
FLSPM0 = 1 ;

/* Call __hromcall subroutine */
__hromcall ( 0x8100, 0, entryram );
/* Set write time data */
entryram[7] = 0x20 ;
/* Set delete time data */
entryram[8] = 0x4c ;
entryram[9] = 0x4c ;
entryram[10] = 0x00 ;
/* Set convergence time */
entryram[11] = 0x01 ;
entryram[12] = 0x3d ;
/* Call __hromcall subroutine */
ret = __hromcall ( 0x8100, 1, entryram );
:
}

```

## &lt;Output object of compiler&gt;

```

_func ;
    push    psw          ; Save current register bank      ;Compiler generates these 3
    di      ; Interrupt disabled                          ;
    sel     rb3          ; Switch to bank 3                ;
; line 7 :   /* Move to self-programming mode */
; line 8 :   FLSPM0 = 1 ;
            setl    FLSPM0
; line 9 :
; line 10 :  /* Call __hromcall subroutine */
; line 11 :  __hromcall ( 0x8100, 0, entryram );
            movw   hl, #_entryram
            mov    c, #00H      ; 0
            call  !08100H
; line 12 :  /* Set write time data */
; line 13 :  entryram[7] = 0x20 ;
            mov    a, #020H     ; 32
            mov    [hl + 7], a
; line 14 :  /* Set delete time data */
; line 15 :  entryram[8] = 0x4c ;
            mov    a, #04CH     ; 76
            mov    [hl + 8], a
; line 16 :  entryram[9] = 0x4c ;
            mov    [hl + 9], a
; line 17 :  entryram[10] = 0x00 ;

```

```

    mov    a, #00H    ; 0
    mov    [hl + 10], a
; line 18 :    /* Set convergence time */
; line 19 :    entryram[11] = 0x01 ;
    inc    a
    mov    [hl + 11], a
; line 20 :    entryram[12] = 0x3d ;
    mov    a, #03DH    ; 61
    mov    [hl + 12], a
; line 21 :    /* Call __hromcall subroutine */
; line 22 :    ret = __hromcall ( 0x8100, 1, entryram );
    mov    c, #01H    ; 1
    call   !08100H
    mov    a, b
    mov    !_ret, a
    :
    pop    psw        ; Return to current register bank    ; Compiler automatically
                                                generates this line also
    ret

```

### [Compatibility]

#### (1) From another C compiler to the 78K0 C compile

- If the keyword, `__flashf` is not used, modification is not needed.
- To change to the `__flashf` function, change according to the above method.

#### (2) From the 78K0 C compiler to another C compiler

- Use `#define`. (see "[3.3.5C source modifications](#)")

### Memory manipulation function (#pragma inline)

An object file is generated by the output of the standard library functions memcpy and memset with direct inline expansion.

#### [Function]

- An object file is generated by the output of the standard library memory manipulation functions memcpy and memset with direct inline expansion instead of function call.
- When there is no #pragma directive, the code that calls the standard library functions is generated.

#### [Effect]

- Compared with when a standard library function is called, the execution speed is improved.
- Object code is reduced if a constant is specified for the specified character number.

#### [Usage]

- The function is described in the source in the same format as a function call.
- The following items can be described before #pragma inline.
  - Comments
  - Other #pragma directives
  - Preprocess directives that do not generate variable definitions/references or function definitions/references

#### [Example]

<C source>

```
#pragma inline

char   ary1[100], ary2[100] ;

void main ( void ) {
    memset ( ary1, 'A', 50 );
    memcpy ( ary1, ary2, 50 );
}
```

#### (1) When -sm option is not specified

<Output object of compiler>

```
_main :
    push    hl
; line 5 :   memset ( ary1, 'A', 50 );
    movw   de, #_ary1
    mov    a, #041H      ; 65
    mov    c, #032H      ; 50
    mov    [de], a
    incw   de
    dbnz  c, $$-2
; line 6 :   memcpy ( ary1, ary2, 50 );
```

```

movw    de, #_ary1
movw    hl, #_ary2
mov     c, #032H      ; 50
mov     a, [hl]
mov     [de], a
incw    de
incw    hl
dbnz   c, $$-4
; line 7 :    }
pop     hl
ret

```

**(2) When -sm option is specified**

&lt;Output object of compiler&gt;

```

_main :
push    de
; line 5 :    memset ( ary1, 'A', 50 );
movw    hl, #_ary1
mov     a, #041H      ; 65
mov     c, #032H      ; 50
mov     [hl], a
incw    hl
dbnz   c, $$-2
; line 6 :    memcpy ( ary1, ary2, 50 );
movw    hl, #_ary1
movw    de, #_ary2
mov     c, #032H      ; 50
mov     a, [de]
mov     [hl], a
incw    de
incw    hl
dbnz   c, $$-4
; line 7 :    }
pop     de
ret

```

**[Compatibility]****(1) From another C compiler to the 78K0 C compiler**

- Modification is not needed if the memory manipulation function is not used.
- When changing the memory manipulation function, use the method above.

**(2) From the 78K0 C compiler to another C compiler**

- The #pragma inline directive should be deleted or delimited using #ifdef.

### Absolute address allocation specification (`__directmap`)

Declare `__directmap` in the module in which the variable to be allocated in an absolute address is to be defined. Variables can be allocated to the arbitrary address.

#### [Function]

- The initial value of an external variable declared by `__directmap` and a static variable in a function is regarded as the allocation address specification, and variables are allocated to the specified addresses. Specify the variables address using integers.
- The `__directmap` variable in the C source is treated as an ordinary variable.
- Because the initial value is regarded as the allocation address specification, the initial value cannot be defined and remains an undefined value.
- The specifiable address specification range, secured area range linked by the module for securing the area for the specified addresses, and variable duplication check range are shown in the table below.

Item	Range
Address Specification Range	0x80 - 0xffff
Secured Area Range	0xfd00 - 0xfeff
Duplication Check Range	0xf000 - 0xfeff

- If the address specification is outside the address specification range, an error is output.
- A variable that is declared with `__directmap` cannot be allocated to an area that extends over a boundary of the following areas. If allocated, an error will be output.
  - `saddr` area (0xfe20 to 0xfeff)
  - `sfr` area or an area with which `saddr` area overlaps (0xff00 to 0xff1f)
  - `sfr` area (0xff20 to 0xffff)
- If the allocation address of a variable declared by `__directmap` is duplicated and is within the duplication check range, a warning message (W0762) is output and the name of the duplicated variable is displayed.
- If the address specification range is inside the `saddr` area, the `__sreg` declaration is made automatically and the `saddr` instruction is generated.
- If `char/unsigned char/short/unsigned short/int/unsigned int/long/unsigned long` type variables declared by `__directmap` are bit referenced, `sreg/_sreg` must be specified along with `__directmap`. If they are not, an error will occur.

#### [Effect]

- One or more variables can be allocated to the same arbitrary address.

#### [Usage]

- Declare `__directmap` in the module in which the variable to be allocated in an absolute address is to be defined.

```

__directmap          type-name  variable-name = allocation-address-specification ;
__directmap static   type-name  variable-name = allocation-address-specification ;
__directmap __sreg    type-name  variable-name = allocation-address-specification ;
__directmap __sreg static type-name variable-name = allocation-address-specification ;

```

- If `__directmap` is declared for a structure/union/array, specify the address in braces {}.

- `__directmap` does not have to be declared in a module in which a `__directmap` external variable is referenced, so only declare `extern`.

```
extern          Type-name  Variable-name ;
extern  __sreg  Type-name  Variable-name ;
```

- To generate the `saddr` instruction in a module in which a `__directmap` external variable allocated inside the `saddr` area is referenced, `__sreg` must be used together to make `extern __sreg Type-name Variable-name`.

### [Restrictions]

- `__directmap` cannot be specified for function arguments, return values, or automatic variables. If it is specified in these cases, an error will occur.
- If short/unsigned short/int/unsigned int/long/unsigned long type variables are allocated to odd addresses, the correct code will be generated in the file declared by `__directmap`, but illegal code will be generated if these variables are referenced by an `extern` declaration from an external file.
- If an address outside the secured area range is specified, the variable area will not be secured, making it necessary to either describe a directive file or create a separate module for securing the area.

### [Example]

<C source>

```
__directmap    char    c = 0xfe00 ;
__directmap    __sreg  char    d = 0xfe20 ;
__directmap    __sreg  char    e = 0xfe21 ;
__directmap    struct  x {
    char    a ;
    char    b ;
} xx = { 0xfe30 } ;

void main ( ) {
    c = 1 ;
    d = 0x12 ;
    e.5 = 1 ;
    xx.a = 5 ;
    xx.b = 10 ;
}
```

&lt;Output object of compiler&gt;

```

PUBLIC  _c
PUBLIC  _d
PUBLIC  _e
PUBLIC  _xx
PUBLIC  _main
_c      EQU      0FE00H          ; Addresses for variables declared by __directmap
_d      EQU      0FE20H          ; are defined by EQU
_e      EQU      0FE21H          ;
_xx     EQU      0FE30H          ;
        EXTRN   __mmfe00        ; EXTRN output for linking secured area modules
        EXTRN   __mmfe20        ;
        EXTRN   __mmfe21        ;
        EXTRN   __mmfe30        ;
        EXTRN   __mmfe31        ;
@@CODE  CSEG
_main :
; line 10 :    c = 1 ;
        mov     a, #01H ;1
        mov     !_c, a
; line 11 :    d = 0x12 ;
        mov     _d, #012H          ; saddr instruction output because address
                                   ; specified in saddr area
; line 12 :    e.5 = 1 ;
        set1    _e.5                ; Bit manipulation possible because __sreg also used
; line 13 :    xx.a = 5 ;
        mov     _xx, #05H           ; saddr instruction output because address
                                   ; specified in saddr area
; line 14 :    xx.b = 10 ;
; ]
        mov     _xx + 1, #0AH       ; saddr instruction output because address
                                   ; specified in saddr area
; line 15 :    }
        ret

```

**[Compatibility]****(1) From another C compiler to the 78K0 C compiler**

- No modification is necessary if the keyword `__directmap` is not used.
- To change to the `__directmap` variable, modify according to the description method above.

**(2) From the 78K0 C compiler to another C compiler**

- Compatibility can be attained using `#define` (see "3.3.5 C source modifications" for details).
- When the `__directmap` is being used as the absolute address allocation specification, modify according to the specifications of each compiler.



### Static model expansion specification (-zm)

By specifying the -zm option during compiling, the restrictions on existing static models can be relaxed and the descriptiveness are improved.

#### [Function]

- The 8-byte saddr area of `__NRAT00` to `__NRAT07` is secured as area reserved by the compiler for arguments and work.
- Temporary variables can be used by declaring `__temp` for arguments and automatic variables (see "[Temporary variables \(\\_\\_temp\)](#)" for details).
- The number of argument declarations that can be described ranges from 3 to 6 for int-sized variables and 3 to 9 for char-sized variables. The 4th and subsequent arguments are set by the calling side to the area of `__NRAT00` to `__NRAT05` and copied by the called side to a separate area. However, if `__temp` has been declared for a leaf function or an argument, the called side will not copy the argument, and the `__NRATxx` area where the argument was set will be used as is.
- sStructures and unions that are 2 bytes or smaller can be described for arguments.
- Structures and unions can be described for function return values.  
If the structures and unions are 2 bytes or smaller, the value will be returned.  
If 3 bytes or larger, the return value will be stored in a static area secured for storing return values and returned to the top address of that area.
- The 8-byte area of `__NRAT00` to `__NRAT07` is also used as the leaf function shared area. In shared-area allocation, the 8-byte area of `__NRAT00` to `__NRAT07` is allocated to first, and then the `__KREGxx` area secured by specifying the -sm option.
- Arrays, unions, and structures can also be allocated to `__NRATxx` and `__KREGxx`, provided their size fits into the `__KREGxx` area secured by specifying `__NRATxx` and -sm.
- Interrupt functions that are targeted for saving are shown in table below.

Restore/Save Area	NO BANK	With Function Call				Without Function Call			
		-zm1		-zm2		-zm1		-zm2	
		Stack	RBn	Stack	RBn	Stack	RBn	Stack	RBn
Registers used	NG	NG	NG	NG	NG	OK	NG	OK	NG
All registers	NG	OK	NG	OK	NG	NG	NG	NG	NG
Entire <code>__NRATxx</code> area	NG	OK	OK	OK	OK	NG	NG	NG	NG
Entire <code>__KREGxx</code> area	NG	OK	OK	NG	NG	NG	NG	NG	NG
<code>@KREGxx</code> area used	NG	NG	NG	OK	OK	NG	NG	OK	OK

Stack : Use of stack is specified  
 RBn : Register bank is specified  
 OK : saved  
 NG : not saved

Note, however, that when `#pragma interrupt` is specified, the interrupt functions that are targeted for saving can be limited by specifying as follows.

SAVE\_R (Save/restore target limited to registers)  
 SAVE\_RN (Save/restore target limited to registers and `__NRATxx`)

- The only difference between the -zm1 and -zm2 options is in the treatment of the `__KREGxx` area secured by specifying -sm.

When the -zm1 option is specified, the `__KREGxx` area is only used for leaf function shared area.

When the -zm2 option is specified, the `__KREGxx` area is saved/restored and arguments and automatic variables are allocated there (compatibility with the -qr option in the normal model).

- If the -zm option is specified when the -sm option has not been specified, a warning message (W0055) is output and the -zm option specification is disregarded.

#### [Effect]

- Restrictions on existing static models can be relaxed, improving descriptiveness.

#### [Usage]

- Specify the -sm option along with the -zm during compiling.

#### [Example]

##### (1) Example 1

<C source>

```
char  func1 ( char a, char b, char c, char d, char e );
char  func2 ( char a, char b, char c, char d );

void main ( ) {
    char  a = 1, b = 2, c = 3, d = 4, e = 5, r ;
    r = func1 ( a, b, c, d, e );
}
char  func1 ( char a, char b, char c, char d, char e ) {
    char  r ;

    r = func2 ( a, b, c, d );
    return e + r ;
}
char  func2 ( char a, char b, char c, char d ) {
    return a + b + c + d ;
}
```

##### (a) When -sm8, -zm1, and -qc options are specified

<Output object of compiler>

```
_main :
; line 5 :      char  a = 1, b = 2, c = 3, d = 4, e = 5, r ;
      mov     a, #01H          ; 1
      mov     !L0003, a        ; a
      inc     a
      mov     !L0004, a        ; b
      inc     a
```

```

    mov    !L0005, a      ; c
    inc   a
    mov   !L0006, a      ; d
    inc   a
    mov   !L0007, a      ; e
; line 6 :
; line 7 :   r = func1 ( a, b, c, d, e );
    mov   @_NRAT01, a    ; 5th argument set in saddr area for passing arguments
    mov   a, !L0006     ; d
    mov   @_NRAT00, a    ; 4th argument set in saddr area for passing arguments
    mov   a, !L0005     ; c
    mov   h, a
    mov   a, !L0004     ; b
    mov   b, a
    mov   a, !L0003     ; a
    call  !_func1
    mov   !L0008, a     ; r
; line 8 :   }
    ret
; line 9 :   char   func1 ( char a, char b, char c, char d, char e ) {
_func1 :
    mov   !L0011, a
    mov   a, b
    mov   !L0012, a
    mov   a, h
    mov   !L0013, a
    mov   a, @_NRAT00   ; Copied to static area
    mov   !L0014, a    ;
    mov   a, @_NRAT01   ; Copied to static area
    mov   !L0015, a
; line 10 :   char   r ;
; line 11 :
; line 12 :   r = func2 ( a, b, c, d )
    mov   a, !L0014     ; d
    mov   @_NRAT00,a    ; 4th argument set in saddr area for passing arguments
    mov   a, !L0013     ; c
    mov   h, a
    mov   a, !L0012     ; b
    mov   b, a
    mov   a, !L0011     ; a
    call  !_func2
    mov   !L0016, a     ; r
; line 13 :   return e + r ;
    add   a, !L0015     ; e
L0010 :

```

```

; line 14 :      }
                ret
; line 15 :      char    func2 ( char a, char b, char c, char d ) {
_func2 :
                mov     @_NRAT01, a
                mov     a, b
                mov     @_NRAT02, a
                mov     a, h
                mov     @_NRAT03, a
; line 16 :      return a + b + c + d ;
                mov     a, @_NRAT01    ; a
                add     a, @_NRAT02    ; b
                add     a, @_NRAT03    ; c
                add     a, @_NRAT00    ; d  @_NRAT00 used as is for leaf function
L0018 :
; line 17 :      }
                ret

```

**(b) When -sm8, -zm2, and -qc options are specified**

&lt;Output object of compiler&gt;

```

@@CODE  CSEG
_main :
                movw   ax, @_KREG10    ;
                push   ax              ; Area of @_KREG10 to @_KREG15 saved
                movw   ax, @_KREG12    ;
                push   ax              ;
                movw   ax, @_KREG14    ;
                push   ax              ;
; line 5 :      char    a = 1, b = 2, c = 3, d = 4, e = 5, r ;
                mov     @_KREG15, #01H ; a, 1 Variables allocated to @_KREG11 to @_KREG15
                mov     @_KREG14, #02H ; b, 2
                mov     @_KREG13, #03H ; c, 3
                mov     @_KREG12, #04H ; d, 4
                mov     @_KREG11, #05H ; e, 5
; line 6 :
; line 7 :      r = func1 ( a, b, c, d, e );
                mov     a, @_KREG11    ; e
                mov     @_NRAT01, a    ; 5th argument set in saddr area for passing arguments
                mov     a, @_KREG12    ; d
                mov     @_NRAT00, a    ; 4th argument set in saddr area for passing arguments
                mov     a, @_KREG13    ; c
                mov     h, a
                mov     a, @_KREG14    ; b
                mov     b, a

```

```

    mov    a, @_KREG15    ; a
    call  !_func1
    mov    @_KREG10, a    ; r
; line 8 :    }
    pop   ax              ;
    mov    w_@KREG14, ax  ; Area of @_KREG10 to @_KREG15 restored
    pop   ax              ;
    mov    w_@KREG12, ax  ;
    pop   ax              ;
    mov    w_@KREG10, ax  ;
    ret
; line 9 :    char func1 ( char a, char b, char c, char d, char e ) {
_func1 :
    mov    @_NRAT06, a    ; Register a saved
    movw   ax, @_KREG10   ;
    push  ax              ; Area of @_KREG10 to @_KREG15 saved
    movw   ax, @_KREG12   ;
    push  ax              ;
    movw   ax, @_KREG14   ;
    push  ax              ;
    mov    a, @_NART06    ; Register a restored
    mov    @_KREG15, a
    movw   ax, bc
    mov    @_KREG14, a
    movw   ax, hl
    mov    @_KREG13, a
    mov    a, @_NART00    ; Copied to @_KREG12
    mov    @_KREG12, a
    mov    a, @_NART01    ; Copied to @_KREG11
    mov    @_KREG11, a
; line 10 :    char r ;
; line 11 :
; line 12 :    r = func2 ( a, b, c, d )
    mov    a, @_KREG12    ; d
    mov    @_NRAT00, a    ; 4th argument set in saddr area for passing arguments
    mov    a, @_KREG13    ; c
    mov    h, a
    mov    a, @_KREG14    ; b
    mov    b, a
    mov    a, @_KREG15    ; a
    call  !_func2
    mov    @_KREG10, a    ; r
; line 13 :    return e + r ;
    add   a, @_KREG11    ; e
L0004 :

```

```

; line 14 :      }
                movw  hl, ax          ; Register a saved
                pop   ax              ;
                movw  @_KREG14, ax    ; Area of @_KREG10 to @_KREG15 restored
                pop   ax              ;
                movw  @_KREG12, ax    ;
                pop   ax              ;
                movw  @_KREG10, ax    ;
                movw  ax, hl          ; Register a restored
                ret

; line 15 :      char func2 ( char a, char b, char c, char d ) {
_func2 :
                mov   @_NRAT01, a
                mov   a, b
                mov   @_NRAT02, a
                mov   a, h
                mov   @_NRAT03, a
; line 16 :      return a + b + c + d ;
                mov   a, @_NRAT01    ; a
                add   a, @_NRAT02    ; b
                add   a, @_NRAT03    ; c
                add   a, @_NRAT00    ; d @_NRAT00 used as is for leaf function
L0006 :
; line 17 :      }
                ret

```

**(2) Example 2**

&lt;C source&gt;

```

__sreg struct x {
    unsigned char  a ;
    unsigned char  b : 1 ;
    unsigned char  c : 1 ;
} xx, yy ;
__sreg struct y {
    int  a ;
    int  b ;
} ss, tt ;
struct x      func1 ( struct x );
struct y      func2 ( );

void main ( ) {
    yy = func1( xx );
    tt = func2 ( );
}

```

```

struct x      func1 ( struct x aa ) {
    aa.a = 0x12 ;
    aa.b = 0 ;
    aa.c = 1 ;
    return aa ;
}
struct y      func2 ( ) {
    return tt ;
}

```

**(a) When -sm and -zm options are specified**

&lt;Output object of compiler&gt;

```

@@CODE  CSEG
_main :
; line 14 :   yy = func1 ( xx );
    movw    ax, _xx
    call   !_func1
    movw   _yy, ax
; line 15 :   tt = func2 ( );
    call   !_func2
    movw   hl, ax
    push   de
    movw   de, #_tt
    mov    c, #04H           ; 4
    mov    a, [hl]
    mov    [de], a
    incw   hl
    incw   de
    dbnz   c, $$-4
    pop    de
; line 16 :   }
    ret
; line 17 :   struct x      func1 ( struct x aa ) {
_func1 :
    movw   @_NRAT00, ax
; line 18 :   aa.a = 0x12 ;
    mov    @_NRAT00, #012H     ; aa, 18
; line 19 :   aa.b = 0 ;
    clr1   @_NRAT01.0
; line 20 :   aa.c = 1 ;
    set1   @_NRAT01.1
; line 21 :   return aa ;
    movw   ax, @_NRAT00       ; aa Value returned because 2 bytes or smaller

```

```
; line 22 :      }
                ret
; line 23 :      struct y      func2 ( ) {
; line 24 :      return tt ;
                movw hl, #_tt                ; Return value copied to secured static area
                push de                    ; because 3 bytes or larger
                movw de, #L0007
                mov c, #04H                ; 4
                mov a, [hl]
                mov [de], a
                incw hl
                incw de
                dbnz c, $$-4
                pop de
                movw ax, #L0007            ; Returned top address of static area
; line 25 :      }
                ret
```

**[Compatibility]****(1) From another C compiler to the 78K0 C compile**

- No modification is needed.

**(2) From the 78K0 C compiler to another C compiler**

- No modification is needed.



**Temporary variables ( \_\_temp )**

By specifying the -sm and zm options during compiling and declaring \_\_temp for arguments and automatic variables, an argument and automatic variable area can be reserved.

**[Function]**

- Arguments and automatic variables are allocated to the area of @\_NRAT00 to @\_NRAT07, regardless of whether they correspond to a leaf function. If arguments and automatic variables are not allocated to the area of @\_NRAT00 to @\_NRAT07 they will be treated in the same way as when \_\_temp is not declared.
- The values of arguments and automatic variables declared by \_\_temp are discarded upon a function call.
- \_\_temp cannot be declared for external and static variables.
- If \_\_sreg is declared as well, char/unsigned char/short/unsigned short/int/unsigned int variables can be bit manipulated.
- If \_\_temp is declared when the -sm and -zm options have not been specified, a warning message (W0339) is output and the \_\_temp declaration in the file is disregarded.

**[Effect]**

- Because arguments and automatic variables declared by \_\_stemp share the area of @\_NRAT00 to @\_NRAT07, an argument and automatic variable area can be saved.
- If the sections containing arguments and automatic variables are clearly identified and the \_\_temp declaration is applied to variables that do not require a guaranteed value match before and after a function call, memory can be saved.

**[Usage]**

- Specify the -sm and -zm options during compiling and declare \_\_stemp for arguments and automatic variables.

**[Restrictions]**

- If there are 3 arguments or less when a function is called, arguments and automatic variables declared by \_\_temp can be described for the arguments at function call.  
If there are 4 or more arguments, because the values of the arguments could be discarded during argument evaluation, values described cannot be guaranteed.

**[Example]**

<C source>

```
void func1 ( __temp char a, char b, char c, __sreg __temp char d );
void func2 ( char a );

void main ( ) {
    func1 ( 1, 2, 3, 4 );
}

void func1 ( __temp char a, char b, char c, __sreg __temp char d ) {
    __temp char    r ;

    d.1 = 0 ;
    r = a + b + c + d ;
}
```

```

    func2 ( r );
}
void func2 ( char r ) {
    int    a = 1, b = 2 ;
    r++ ;
}

```

**(1) When -sm, -zm, and -qc options are specified**

&lt;Output object of compiler&gt;

```

@@CODE  CSEG
_main :
; line 5 :      func1 ( 1, 2, 3, 4 );
    mov    a, #04H      ; 4
    mov    @_NRAT00, a
    mov    h, #03H      ; 3
    mov    b, #02H      ; 2
    mov    a, #01H      ; 1
    call   !_func1
; line 6 :      }
    ret
; line 7 :      void func1 ( __temp char a, char b, char c, __sreg __temp char d ) {
_func1 :
    mov    @_NRAT01, a    ; Allocated to @_NRAT01
    mov    a, b
    mov    !L0005, a
    mov    a, h
    mov    !L0006, a
                                ; Argument allocated to @_NRAT00 is unchanged
; line 8 :      __temp char r ;
; line 9 :
; line 10 :     d.1 = 0 ;
    clr1   @_NRAT00.1    ; Bit manipulation possible
; line 11 :     r = a + b + c + d ;
    mov    a, @_NRAT01    ; a
    add    a, !L0005      ; b
    add    a, !L0006      ; c
    add    a, @_NRAT00    ; d
    mov    @_NRAT02, a    ; r @_NRAT02 used
; line 12 :     func2 ( r );
    call   !_func2
; line 13 :     }
                                ; Values of @_NRAT00 to @_NRAT02
                                ; changed after return
    ret

```

```
; line 14 : void func2 ( char r ) {  
_func2 :  
    mov    @_NRAT00, a  
; line 15 : int      a = 1, b = 2 ;  
    movw  @_NRAT02, #01H ; a, 1  
    movw  @_NRAT04, #02H ; b, 2  
; line 16 : r++ ;  
    inc   @_NRAT00  
; line 17 : }  
    ret
```

### [Compatibility]

#### (1) From another C compiler to the 78K0 C compile

- If the reserved word, \_\_temp is not used, modification is not required.
- To change to a temporary variable, modify according to the description method above.

#### (2) From the 78K0 C compiler to another C compiler

- Use #define. (see "[3.3.5C source modifications](#)")  
This modification means that the \_temp variable is treated as an ordinary variable.

### Library supporting prologue/epilogue (-zd)

By specifying the -zd option during compiling, prolog and epilog codes are replaced by libraries and the object code can be reduced.

#### [Function]

- A specified pattern of the prologue/epilogue code can be replaced with a library call.
- Number of callt entries that users can use is reduced two in the case of a normal model and up to ten in the case of a static model.
- The library replacement patterns in the case of a normal model are as follows.
  - HL, \_@KREGxx save/copy, stack frame secure -> callt [@@cprep2]
  - HL, \_@KREGxx restore, stack frame release -> callt [@@cdisp2]
- In the case of a static model, arguments are allocated to \_@NRATxx and \_@KREGxx so that the first 3 arguments accord with the patterns described below. When char and int are mixed, the allocation interval is adjusted so that it accords with the patterns of multiple int type arguments.
- The library replacement patterns in the case of a static model are as follows.

#### (1) For char 2 arguments

```

mov    _@NRAT00, a    ->    callt [@@nrpc2]
mov    a, b
mov    _@NRAT01, a
mov    _@KREG15, a    ->    callt [@@krpc2]
mov    a, b
mov    _@KREG14, a

```

#### (2) For char 3 arguments

```

mov    _@NRAT05, a    ->    callt [@@nrpc3]
mov    a, b
mov    _@NRAT06, a
mov    a, h
mov    _@NRAT07, a
mov    _@KREG15, a    ->    callt [@@krpc3]
mov    a, b
mov    _@KREG14, a
mov    a, h
mov    _@KREG13, a
mov    _@NRAT06, a    ->    call !@@nkrc3
mov    a, b
mov    _@NRAT07, a
mov    a, h
mov    _@KREG15, a

```

**(3) For int 2 arguments**

```

movw  _@NRAT00, ax    ->    callt [@@nrip2]
movw  ax, bc
movw  _@NRAT02, ax

movw  _@KREG14, ax   ->    callt [@@krip2]
movw  ax, bc
movw  _@KREG12, ax

```

**(4) For int 3 arguments**

```

movw  _@NRAT02, ax   ->    callt [@@nrip3]
movw  ax, bc
movw  _@NRAT04, ax
movw  ax, hl
movw  _@NRAT06, ax

movw  _@KREG14, ax   ->    callt [@@krip3]
movw  ax, bc
movw  _@KREG12, ax
movw  ax, hl
movw  _@KREG10, ax

movw  _@NRAT04, ax   ->    call !@@nkri31
movw  ax, bc
movw  _@NRAT06, ax
movw  ax, hl
movw  _@KREG14, ax

movw  _@NRAT06, ax   ->    call !@@nkri32
movw  ax, bc
movw  _@KREG14, ax
movw  ax, hl
movw  _@KREG12, ax

```

**(5) For save/restore**

```

_@NRAT00 to _@NRAT07 save    ->    callt [@@nrsave]

_@NRAT00 to _@NRAT07 restore ->    callt [@@nrload]

_@KREG14 to 15 save          ->    call !@@krs02

_@KREG12 to 15 save          ->    call !@@krs04
                                ->    call !@@krs04i

```

_@KREG10 to 15 save	->	call !@@krs06
	->	call !@@krs06i
_@KREG08 to 15 save	->	call !@@krs08
	->	call !@@krs08i
_@KREG06 to 15 save	->	call !@@krs10
	->	call !@@krs10i
_@KREG04 to 15 save	->	call !@@krs12
	->	call !@@krs12i
_@KREG02 to 15 save	->	call !@@krs14
	->	call !@@krs14i
_@KREG00 to 15 save	->	call !@@krs16
	->	call !@@krs16i
_@KREG14 to 15 restore	->	call !@@krl02
_@KREG12 to 15 restore	->	call !@@krl04
	->	call !@@krl04i
_@KREG10 to 15 restore	->	call !@@krl06
	->	call !@@krl06i
_@KREG08 to 15 restore	->	call !@@krl08
	->	call !@@krl08i
_@KREG06 to 15 restore	->	call !@@krl10
	->	call !@@krl10i
_@KREG04 to 15 restore	->	call !@@krl12
	->	call !@@krl12i
_@KREG02 to 15 restore	->	call !@@krl14
	->	call !@@krl14i
_@KREG00 to 15 restore	->	call !@@krl16
	->	call !@@krl16i

**[Effect]**

- By replacing prolog and epilog code with a library, object code can be reduced.

**[Usage]**

- Specify the -zd option during compiling.

**[Restrictions]**

- The flash area allocation specification option `-zf` cannot be specified at the same time as the `-zd` option. If it is specified, a warning message (W0054) is output and the `-zd` option is disregarded.

**[Example]****(1) EXAMPLE 1**

&lt;C source&gt;

```

int    func1 ( int a, int b, int c );
int    func2 ( int a, int b, int c );

void main ( ) {
    int    r ;

    r = func1 ( 1, 2, 3 );
}
int    func1 ( int a, int b, int c ) {
    return func2 ( a + 1, b + 1, c + 1 );
}
int    func2 ( int a, int b, int c ) {
    return a + b + c ;
}

```

**(a) When `-sm8`, `-zm2`, and `-qc` are specified**

```

@@CODE CSEG
_main :
    movw    ax,  _@KREG14
    push   ax
; line 5 :    int    r ;
; line 6 :
; line 7 :    r = func1 ( 1, 2, 3 );
    movw   hl,  #03H    ; 3
    movw   bc,  #02H    ; 2
    movw   ax,  #01H    ; 1
    call   !_func1
    movw   _@KREG14, ax ; r
; line 8 :    }
    pop    ax
    movw   _@KREG14, ax
    ret
; line 9 :    int    func1 ( int a, int b, int c ) {
_func1 :
    call   !@@krs06
    callt  [@@krip3]

```

```

; line 10 :    return func2 ( a + 1, b + 1, c + 1 );
              movw    ax, @_KREG10    ; c
              incw    ax
              movw    hl, ax
              movw    ax, @_KREG12    ; b
              incw    ax
              movw    bc, ax
              movw    ax, @_KREG14    ; a
              incw    ax
              call    !_func2
L0004 :
; line 11 :    }
              call    !@krl06
              ret
; line 12 :    int    func2 ( int a, int b, int c ) {
_func2 :
              callt   [:@nrip3]
; line 13 :    return a + b + c ;
              movw    ax, @_NRAT02    ; a
              xch     a, x
              add     a, @_NRAT04    ; b
              xch     a, x
              addc    a, @_NRAT05    ; b
              xch     a, x
              add     a, @_NRAT06    ; c
              xch     a, x
              addc    a, @_NRAT07    ; c
L0006 :
; line 14 :    }
              ret

```

**(2) EXAMPLE 2**

&lt;C source&gt;

```

int    func ( register int a, register int b );

void main ( ) {
    register int    a = 1, b = 2, c = 3, r ;
    r = func ( a, b );
}
int    func ( register int a, register int b ) {
    register int    r ;

    r = a + b ;
    return r ;
}

```



}

**(a) When -or and -zd are specified**

&lt;Output object of compiler&gt;

```

@@CODE CSEG
_main :
    movw    de, #0300H
    callt   [@@cprep2]
; line 4 :   register int    a = 1, b = 2, c = 3, r ;
    movw    hl, #01H        ; 1
    movw    @_KREG00, #02H ; b, 2
    movw    @_KREG02, #03H ; c, 3
; line 5 :
; line 6 :   r = func ( a, b );
    movw    ax, @_KREG00    ; b
    push   ax
    movw    ax, hl
    call   !_func
    pop    ax
    movw    ax, bc
    movw    @_KREG04, ax    ; r
; line 7 :   }
    movw    ax, #0300H
    callt   [@@cdisp2]
    ret
; line 8 :   int    func ( register int a, register int b ) {
_func :
    movw    de, #0C940H
    callt   [@@cprep2]
; line 9 :   register int    r ;
; line 10 :
; line 11 :   r = a + b ;
    movw    ax, hl
    xch    a, x
    add    a, @_KREG12    ; a
    xch    a, x
    addc   a, @_KREG13    ; a
    movw    @_KREG00, ax  ; r
; line 12 :   return r ;
    movw    bc, ax
L0004 :
; line 13 :   }
    movw    ax, #0C940H
    callt   [@@cdisp2]
    ret

```

**[Compatibility]****(1) From another C compiler to the 78K0 C compile**

- No modification is needed.
- To replace the prologue/epilogue code with a library, modify the source program according to the description method above.

**(2) From the 78K0 C compiler to another C compiler**

- No modification is needed.

**[Caution]**

- The argument copy pattern in the case of a static model will be pattern-matched only when register has not been specified for any of the first 3 arguments or `__temp` has been specified for all of the first 3 arguments. Therefore, because pattern matching will not be performed if the `-qv` option is specified or if `register/_temp` are partially specified for the first 3 arguments, it will no longer be possible to replace the `-zd` option specification.

### 3.3.5 C source modifications

The compiler generates efficient object code when using the extended functions. But these functions are designed for use on 78K0R microcontrollers. If programs make use of the extended functions, they must be modified when porting them for use on other devices.

This section explains techniques that can use to port programs from other C compilers to 78K0R C compiler, and from 78K0R C compiler to other C compilers.

#### (1) From another C compiler to the 78K0 C compiler

- #pragma<sup>Note</sup>

If the other C compiler supports the #pragma directive, the C source must be modified. The method and extent of modifications to the C source depend on the specifications of the other C compiler.

- Extended specifications

If the other C compiler has extended specifications such as addition of keywords, the C source must be modified. The method and extent of modifications to the C source depend on the specifications of the other C compiler.

**Note** #pragma is one of the preprocessing directives supported by ANSI. The character string following the #pragma is identified as a directive to the compiler. If the compiler does not support this directive, the #pragma directive is ignored and the compile will be continued until it properly ends.

#### (2) From the 78K0 C compiler to another C compiler

- Because the 78K0 C compiler has added keywords as the extended functions, the C source must be made portable to the other C compiler by deleting such keywords or invalidating them with #ifdef.

Following are some examples.

##### (a) To invalidate a keyword (Same applies to callf, sreg, noauto, and norec, etc.)

```
#ifndef __K0__
#define callt          /* Makes callt as ordinary function */
#endif
```

##### (b) To change from one type to another

```
#ifndef __K0__
#define bit          char /* Changes bit type to char type variable*/
#endif
```

### 3.4 Function Call Interface

This section explains the following features of the function call interface.

- [Return values](#) (common to all functions)
- [Ordinary function call interface](#)
- [noauto function call interface \(only for normal model\)](#)
- [norec function call interface \(only for normal model\)](#)
- [Static model function call interface](#)
- [Pascal function call interface](#)

#### 3.4.1 Return values

- The return value of a function is stored in registers or carry flags.
- The locations at which a return value is stored are listed below.s

**Table 3-13. Storage Locations of Return Values**

Type	Location of Storing	
	Normal Model	Static Model
1-byte integer	BC	A
2-byte integer		AX
4-byte integer	BC (Lower) DE (Upper)	Not supported
Pointer (when the bank function (-mf) is not used)	BC	AX
Pointer (when the bank function (-mf) is used)	BC (data pointer) BC (Lower), DE (Upper) (function pointer)	Not supported
Structure, union	BC (if copied to the area specific to the function, the start address of the structure or union)	Not supported
1 bit	CY (carry flag)	CY (carry flag)
Floating-point number (float type)	BC (Lower) DE (Upper)	Not supported
Floating-point number (double type)	BC (Lower) DE (Upper)	Not supported

#### 3.4.2 Ordinary function call interface

When all the arguments are allocated to registers and there is not an automatic variable, the ordinary function call interface is the same as noauto function call interface.

##### (1) Passing arguments

- There are two types of arguments; arguments that are allocated to a register and normal arguments.
- An argument that is allocated to a register is an argument that has undergone register declaration and is allocated to a register or `_@KREGxx` as long as an allocatable register and `_@KREGxx` exist. However, arguments are allocated to `_@KREGxx` only when `-qr` option is specified. Arguments that are allocated to a register or `_@KREGxx` are referred to as register arguments hereafter.
- See "[3.5 List of saddr Area Labels](#)" for the details for `_@KREGxx`.
- The remaining arguments are allocated to a stack.
- On the function call side, both the arguments declared with registers and the ordinary arguments are passed in the same manner. The second argument and later are passed on a stack, and the first argument is passed by register or on a stack.

- On the function definition side, arguments passed by register or stack are saved in the place where arguments are allocated.
- Register arguments are copied in a register or `__KREGxx`. Even when the arguments are passed by registers, register copying is necessary since the registers on the function caller (passing side) are different to those on the function definition side (receiving side).
- Normal arguments are loaded on a stack by the function definition side from the last one to the first. The minimum unit to be loaded on a stack is 16-bit. If the number of arguments is more than 16-bit, they are loaded on a stack by the unit of 16-bit from the upper bit. The 8-bit type is extended to 16-bit type. When an argument is passed on a stack, the area where the arguments are passed to becomes the area to which they are allocated.
- Saving and restoring registers to which arguments are allocated is performed on the function definition side.
- The location where the first argument is passed is shown below.

**Table 3-14. Location Where First Argument Is Passed (Function Calling Side) (Normal Model)**

Type	Storage Location
1-byte data <sup>Note</sup> 2-byte data <sup>Note</sup>	AX
3-byte data <sup>Note</sup> 4-byte data <sup>Note</sup>	AX, BC
Floating-point number	AX, BC
Other	On the stack

**Note** 1-byte to 4-byte data includes structures, unions, and pointers.

**Table 3-15. List Where Argument Is Passed (Function Calling Side) (Static Model)**

Argument type	The First Argument	The Second Argument	The Third Argument
1-byte integer	A	B	H
2-byte integer	AX	BC	HL

**Remark** When the arguments are 4 bytes, Allocates to AX and BC and the remainder allocated to H or HL. Neither structures nor unions are included in 1- to 4- byte integer.

## (2) Location and order of storing arguments

- There are two types of arguments; arguments that are allocated to a register and normal arguments. The automatic variables to be allocated to registers are ones which are declared with registers and automatic variables with `-qv` is specified.
- The automatic variables not allocated to a register are allocated to a stack. The arguments allocated to the stack are loaded from the last one.
- Saving and restoring registers to which arguments are allocated is performed on the function definition side.
- Normal arguments are loaded on a stack. When an argument is passed on a stack, the area where the arguments are passed to becomes the area to which they are allocated.
- On the function definition side, arguments passed by register or stack are saved in the place where arguments are allocated. Register arguments are copied in a register or `__KREGxx`. They are only copied when `-qr` option is specified. Even when the arguments are passed by registers, register copying is necessary since the registers on the function caller (passing side) are different to those on the function definition side (receiving side).

- On the function call side, both the arguments declared with registers and the ordinary arguments are passed in the same manner.

The second argument and later are passed on a stack, and the first argument is passed by register or on a stack.

See "[Table 3-14. Location Where First Argument Is Passed \(Function Calling Side\) \(Normal Model\)](#)" for the location where the first argument is passed by.

The allocation sequence of automatic variables to argument registers are `__KREGxx` is as follows.

**(a) Register to be used**

HL

**Caution** Arguments are not allocated to HL when there is a stack frame.

**(b) saddr area to be used**

`__KREG12` to 15

**(c) Allocation sequence**

- Registers

char type	The sequence is L, H
int, short, enum type	HL

- saddr area

char type	The sequence is <code>__KREG12</code> , <code>__KREG13</code> , <code>__KREG14</code> , and <code>__KREG15</code>
int, short, enum type	The sequence is <code>__KREG12</code> to 13 and <code>__KREG14</code> to 15
long, float, double type	The sequence is <code>__KREG12</code> to 13 (low-order) - <code>__KREG14</code> to 15 (high-order)

**(3) Location and order of storing automatic variables**

- There are two types of automatic variables; automatic variables that are allocated to a register and normal arguments. An automatic variable that is allocated to a register is a variable that has undergone register declaration and is allocated to a register or `__KREGxx` as long as an allocatable register and `__KREGxx` exist. However, arguments are allocated to `__KREGxx` only when `-qr` option is specified. Automatic variables that are allocated to a register or `__KREGxx` are referred to as register variables hereafter.
- See "[3.5 List of saddr Area Labels](#)" for the details for `__KREGxx`.
- Register variables are allocated after register arguments are allocated. Therefore, register variables are only allocated to the register when the register has any free spaces after register arguments are allocated.
- The automatic variables which are not allocated to a register are allocated to a stack.
- Saving and restoring registers and `__KREGxx` to which automatic variables are allocated is performed on the function definition side.

The allocation sequence of automatic variables to `__KREGxx` is as follows.

**(a) Register to be used**

HL

**Caution** Arguments are not allocated to HL when there is a stack frame.

**(b) saddr area to be used**

\_**@KREG00** to 11

**(c) Allocation sequence**

- Registers

char type	The sequence is L, H
int, short, enum type	HL

- saddr area

char type	The sequence is <b>_<b>@KREG00</b>, <b>_<b>@KREG01</b>...</b>, and <b>_<b>@KREG11</b></b></b>
int, short, enum type	The sequence is <b>_<b>@KRET00</b> to 01, <b>_<b>@KREG02</b> to 03...</b>, and <b>_<b>@KREG10</b> to 11</b></b>
long, float, double type	The sequence is <b>_<b>@KREG00</b> to 03, <b>_<b>@KREG04</b> to 07, and <b>_<b>@KREG08</b> to 11</b></b></b>

- The automatic variables that are allocated to a stack are loaded on the stack in the sequence of declaration.

**(4) Examples**

**(a) Examples 1**

<C source>

```
void func0 ( register int, int );

void main ( void ) {
    func0 ( 0x1234, 0x5678 );
}

void func0 ( register int p1, int p2 ) {
    register int    r ;
    int            a ;
    r = p2 ;
    a = p1 ;
}
```

The output code is as follows.

```
_main :
; line 4 :      func0 ( 0x1234, 0x5678 );
               movw   ax, #05678H    ; 22136
               push   ax                ; Argument passed via a stack
               movw   ax, #01234H    ; 4660    ; The first argument that is passed via a
```

```

                                register
    call    !_func0                ; Function call
    pop    ax                      ; Argument passed via a stack
; line 5 :    }
    ret
; line 6 :    void func0 ( register int p1, int p2 ) {
_func0 :
    push   hl
    xch    a, x
    xch    a, @_KREG12
    xch    a, x
    xch    a, @_KREG13            ; Allocate register argument p1 to @_KREG12
    push   ax                    ; Saves the saddr area for register argument
    movw   ax, @_KREG00
    push   ax                    ; Saves the saddr area for a register
                                variable
    push   ax                    ; Reserves area for the automatic variable a
    movw   ax, sp
    movw   hl, ax
; line 7 :    register int    r ;
; line 8 :    int            a ;
; line 9 :    r = p2 ;
    mov    a, [hl+10] ; p2        ; Argument p2 passed via a stack
    xch    a, x
    mov    a, [hl+11] ; p2
    movw   @_KREG00, ax ; r        ; Assigns to register variable @_KREG00
; line 10 :   a = p1 ;
    movw   ax, @_KREG12 ; p1      ; Register argument @_KREG12
    mov    [hl+1], a ; a
    xch    a, x
    mov    [hl], a ; a           ; Assigns to automatic variable a
; line 11 :   }
    pop    ax                    ; Releases area of the automatic variable a
    pop    ax
    movw   @_KREG00, ax          ; Restores the saddr area for a register
                                variables
    pop    ax
    movw   @_KREG12, ax          ; Restores the saddr area for a register
argument
    pop    hl
    ret

```



## (b) Example 2

&lt;C source&gt;

```

void func1 ( int, register int );

void main ( void ) {
    func1 ( 0x1234, 0x5678 );
}

void func1 ( int p1, register int p2 ) {
    register int    r ;
    int            a ;
    r = p2 ;
    a = p1 ;
}

```

The output code is as follows.

```

_main :
; line 4 :      func1 ( 0x1234, 0x5678 );
    movw      ax, #05678H      ; 22136
    push      ax                ; Argument passed via a stack
    movw      ax, #01234H      ; 4660   ; The first argument that is passed via a
                                register
    call      !_func1          ; Function call
    pop       ax                ; Argument passed via a stack
; line 5 : }
    ret
; line 6 : void func1 ( int p1, register int p2 ) {
_func1 :
    push      hl
    push      ax                ; Loads the first argument p1 on the stack
    movw      ax, @_KREG00
    push      ax                ; Saves the saddr area for register variables
    movw      ax, @_KREG12
    push      ax                ; Saves the saddr area for register arguments
    push      ax                ; Reserves area for the automatic variable a
    movw      ax, sp
    movw      hl, ax
    mov       a, [hl+12]        ; Argument p2 passed via a stack and received
                                via the saddr area

    xch       a, x
    mov       a, [hl+13]
    movw      @_KREG12, ax      ; Allocates the register argument to @_KREG12
; line 7 :      register int    r ;
; line 8 :      int            a ;

```

```

; line 9 :      r = p2 ;
               movw   ax,  _@KREG12      ; p2
               movw   _@KREG00, ax      ; r      ; Register variable _@KREG00
; line 10 :     a = p1;
               mov    a,  [hl+6]        ; p1      ; Argument p1 (low-order) passed via a stack
               ;                                     and received by a register
               mov    [hl], a           ; a      ; Automatic variable a (low-order)
               xch    a, x
               mov    a,  [hl+7]        ; p1      ; Argument p1 (high-order) passed via a
               ;                                     stack and received by a register
               mov    [hl+1], a         ; a      ; Automatic variable a (high-order)
; line 11 : }
               pop    ax                ; Releases area for the automatic variable a
               pop    ax
               movw   _@KREG12, ax      ; Restores the saddr area for register
               ;                                     arguments
               pop    ax
               movw   _@KREG00, ax      ; Restores the saddr area for register
               ;                                     variables
               pop    ax
               pop    hl
               ret

```

### 3.4.3 noauto function call interface (only for normal model)

#### (1) Passing arguments

- On the function caller, arguments are passed in the same way as in an ordinary function (see "[3.4.2 Ordinary function call interface](#)").
- On the function definition side, arguments passed by register or on a stack are copied to a register as well as `_@KREG12` to 15. Copying to `_@KREG12` to 15 are only done when `-qr` option is specified. Even when the arguments are passed by registers, register copying is necessary since the registers on the function caller (passing side) are different to those on the function definition side (receiving side).
- Saving and restoring registers to which arguments and `_@KREG12` to 15 are allocated is performed on the function definition side.

#### (2) Location and order of storing arguments

- On the function definition side, all arguments are allocated to registers and `_@KREG12` to 15. However, arguments are allocated to `_@KREG12` to 15 only when `-qr` is specified.
- If there are arguments that are not allocated to registers or `_@KREG12` to 15, an error occurs.
- On the function caller, arguments are passed in the same way as in an ordinary function (see "[3.4.2 Ordinary function call interface](#)").
- On the function definition side, arguments passed by register or on a stack are copied to a register as well as `_@KREG12` to 15. Even when the arguments are passed by registers, register copying is necessary since the registers on the function caller (passing side) are different to those on the function definition side (receiving side).
- Saving and restoring registers to which arguments and `_@KREG12` to 15 are allocated is performed on the function definition side.

**(a) Allocation sequence**

- The allocation sequence is the same as in an ordinary function (see "3.4.2 Ordinary function call interface").

**(3) Location and order of storing automatic variables**

- Automatic variables are allocated to registers and `__KREG12` to 15. However, arguments are allocated to `__KREG12` to 15 only when `-qr` is specified. See "3.5 List of `saddr` Area Labels" for the details for `__KREG12` to 15.
- Automatic variables are allocated to registers when there are excess registers after the allocation of arguments. When `-qr` option is specified, automatic variables are allocated also to `__KREG12` to 15. If there are automatic variables that are not allocated to registers or `__KREG12` to 15, an error occurs.
- Saving and restoring registers and `__KREG12` to 15 to which automatic variables are allocated is performed on the function definition side.

**(a) Allocation sequence**

- The order of allocating automatic variables to registers is the same as the order of allocating arguments.
- The automatic variables allocated to `__KREG12` to 15 are allocated in the order of declaration.

**(4) Example**

<C source>

```
noauto void func2 ( int, int );

void main ( ) {
    func2 ( 0x1234, 0x5678 );
}
noauto void func2 ( int p1, int p2 ) {
    :
}
```

The output code is as follows.

```
_main :
; line 4 :      func2 ( 0x1234, 0x5678 );
    movw    ax, #05678H      ; 22136
    push   ax                ; Argument passed via a stack
    movw    ax, #01234H      ; 4660  ; The first argument that is passed via a
                                register
    call   !_func2           ; Function call
    pop    ax                ; Argument passed via a stack
; line 5 :      }
    ret
; line 6 :      noauto void func2 ( int p1, int p2 ) {
_func2 :
    push   hl                ; Saves a register for the argument
    xch    a, x
    xch    a, __KREG12       ; Allocate the argument p1 to __KREG12 (lower)
```

```

xch    a, x
xch    a, _@KREG13           ; Allocate the argument p1 to _@KREG13 (higher)
push   ax                   ; Saves the saddr area for arguments
movw   ax, sp
movw   hl, ax
mov    a, [hl+6]           ; Argument p2 (low-order) passed via a stack and
                           ; received via a register
xch    a, x
mov    a, [hl+7]           ; Argument p2 (high-order) passed via a stack
                           ; and received via a register
movw   hl, ax              ; Allocate arguments to HL
:
pop    ax
movw   _@KREG12, ax        ; Restore the saddr area for argument
pop    hl                  ; Restores the register for argument
ret

```

#### 3.4.4 norec function call interface (only for normal model)

##### (1) Passing arguments

- All the arguments are allocated to \_@NRARGx and \_@RTARG6, 7. On the function caller, arguments are passed by register \_@NRARGx.
- On the function definition side, arguments passed by registers are copied to registers, or to \_@RTARG6, 7 (see "3.5 List of saddr Area Labels").

##### (2) Location and order of storing arguments

- On the function definition side, all arguments are allocated to \_@NRARGx and \_@RTARG6, 7. Arguments are allocated to \_@NRARGx only when -qr is specified.
- Arguments are allocated to \_@RTARG6, 7 only when there are arguments in DE (see "3.5 List of saddr Area Labels").
- If there are arguments that are not allocated to registers, \_@NRARGx, \_@RTARG6, 7, an error will result.
- On the function caller, arguments are passed by register \_@NRARGx.
- On the function definition side, arguments that are passed by registers are copied to registers or \_@RTARG6, 7. Even when the arguments are passed by registers, register copying is necessary since the registers on the function caller (passing side) are different to those on the function definition side (receiving side).  
If the arguments are passed by \_@NRARGx, the area where the arguments are passed becomes the area to which they are allocated.
- If arguments can no longer be passed by register, they can be allocated to \_@NRARGx and passed by there. In this case, passing is carried out with registers and \_@NRARGx intermingled.

##### (a) Allocation sequence

- Arguments allocated to \_@NRARGx are allocated in the sequence of declaration.
- Arguments allocated to registers are allocated to registers and \_@RTARG6, 7 according to the following rules.

**(b) Registers to be used**

When one argument is used in char, int, short, enum, or pointer type	AX pass, DE receive
When two or more arguments are used in char, int, short, enum, or pointer type	AX and DE pass @_RTARG6, 7 and DE receive

**(c) Allocation sequence**

char, int, short, enum, and pointer type	In the sequence of DE, @_RTARG6 and 7
--	---------------------------------------

**(3) Location and order of storing automatic variables**

- The automatic variables are allocated to registers and @\_NRARGx as long as there are allocable registers and @\_NRARGx. If there is no allocable register, they are allocated to @\_NRATxx. However, automatic variables are allocated to @\_NRARGx and @\_NRATxx only when -qr option is specified. For @\_NRATxx, see "3.5 List of saddr Area Labels".
- If there are automatic variables that cannot be allocated to registers, @\_NRARGx, or @\_NRATxx, an error occurs.
- Saving and restoring registers to which automatic variables are allocated is performed on the function definition side.

**(a) Allocation sequence**

- The order of allocating automatic variables to registers and @\_RTARG6 to 7 is the same as the order of allocating arguments.
- The automatic variables allocated to @\_NRARG and @\_NRATxx are allocated in the order of declaration.

**(4) Example**

&lt;C source&gt;

```
norec void func3 ( char, int, char, int );

void main ( ) {
    func3 ( 0x12, 0x34, 0x56, 0x78 );
}
norec void func3 ( char p1, int p2, char p3, int p4 ) {
    int a ;
    a = p2 ;
}
```

**(a) When -qr option is specified**

The output code is as follows.

```
_main :
; line 4 :      func3 ( 0x12, 0x34, 0x56, 0x78 );
movw    @_NRARG1, #078H    ; 120    ; Argument is passed via @_NRARG1
mov     @_NRARG0, #056H    ; 86     ; Argument is passed via @_NRARG0
movw    de, #034H         ; 52     ; Argument is passed via register DE
mov     a, #012H          ; 18     ; Argument is passed via register A
```

```

    call    !_func3                ; Function call
    ret
; line 6 :    norec    void func3 ( char p1, int p2, char p3, int p4 ) {
_func3 :
    mov     @_RTARG6, a            ; Allocates the argument p1 to @_RTARG6
; line 7 :    int      a ;
; line 8 :    a = p2 ;
    movw   ax, de                 ; Argument p2
    movw   @_NRARG2, ax          ; a      ; Automatic variable a
    ret

```

### 3.4.5 Static model function call interface

#### (1) Passing arguments

- On the function call side, both the arguments declared with registers and the ordinary arguments are passed in the same manner.  
There can be a maximum of three arguments, up to 6 bytes, and all arguments are passed by registers.
- On the function definition side, arguments passed by register are saved in the place where arguments are allocated.  
Register arguments are copied in a register. Even when the arguments are passed by registers, register copying is necessary since the registers on the function caller (passing side) are different to those on the function definition side (receiving side).
- Ordinary functions are allocated to the function-specific area.

#### (2) Location and order of storing arguments

##### (a) Argument storage location

- There are two types of arguments; arguments that are allocated to a register and normal arguments.
- The arguments allocated to registers are arguments that have undergone a register declaration.
- On the function definition side, arguments passed by register are saved in the place where arguments are allocated.  
Register arguments are copied in a register. Even when the arguments are passed by registers, register copying is necessary since the registers on the function caller (passing side) are different to those on the function definition side (receiving side). Ordinary functions are allocated to the function-specific area.
- Saving and restoring registers to which arguments/automatic variables are allocated is performed on the function definition side.
- The remaining arguments are allocated to a stack.
- On the function call side, both the arguments declared with registers and the ordinary arguments are passed in the same manner.  
There can be a maximum of three arguments, up to 6 bytes, and all arguments are passed by registers.  
The location where the first argument is passed is shown below.

Data Size	The First Argument	The Second Argument	The Third Argument
1-byte data <sup>Note</sup>	A	B	H
2-byte data <sup>Note</sup>	AX	BC	HL
4-byte data <sup>Note</sup>	Allocates to AX and BC and the remainder allocated to H or HL.		

**Note** Neither structures nor unions are included in 1- to 4- byte data.

**(b) Allocation sequence**

- Arguments allocated to the function-specific area are allocated sequentially from the last argument.
- Register arguments are allocated to register DE according to the following rules.

**<1> Registers to be used**

DE

**<2> Allocation sequence**

char type	The sequence is D, E
int, short, enum type	DE

**(3) Location and order of storing automatic variables**

**(a) Automatic variables storage location**

- There are two types of automatic variables; automatic variables that are allocated to a register and normal arguments.
- Automatic variables allocated to registers are register-declared automatic variables and automatic variables specified at -qv specification.
- Register variables are allocated after register arguments are allocated. Therefore, register variables are only allocated to the register when the register has any free spaces after register arguments are allocated.
- the remained automatic variables are allocated to the function-specific area.
- Saving and restoring registers to which automatic variables are allocated is performed on the function definition side.

**(b) Automatic variables allocation sequence**

- Automatic variables are allocated to register DE according to the following rules.

**<1> Registers to be used**

DE

**<2> Allocation sequence**

char type	The sequence is E, D
int, short, enum type	DE

- The automatic variables that are allocated to the function-specific area are allocated in the sequence of declaration.

**(4) Example**

**(a) Example 1**

<C source>

```
void func4 ( register int, char );
void func ( void );
```

```

void main ( ) {
    func4 ( 0x1234, 0x56 );
}
void func4 ( register int p1, char p2 ) {
    register char  r ;
    int          a ;
    r = p2 ;
    a = p1 ; func ( );
}

```

The output code is as follows.

```

@@DATA  DSEG  UNITP
L0005   : DS   ( 1 )                ; Argument p2
L0006   : DS   ( 1 )                ; Automatic variable rAutomatic variable r
L0007   : DS   ( 2 )                ; Automatic variable a

; line 1 :   void func4 ( register int, char ); void func ( void );
; line 2 :   void main ( ) {
@@CODE  CSEG
_main :
; line 3 :   func4 ( 0x1234, 0x56 );
        mov   b, #056H              ; 86   ; Pass the second argument via register B
        movw  ax, #01234H          ; 4660 ; Pass the first argument via register AX
        call  !_func4              ; Function call
; line 4 :   }
        ret
; line 5 :   void func4 ( register int p1, char p2 ) {
_func4 :
        push  de                    ; Saves register for register argument
        movw  de, ax                ; Allocate a register argument p1 to DE
        movw  a, b
        mov   !L0005, a             ; Copy argument p2 to L0005
; line 6 :   register char  r ;
; line 7 :   int          a ;
; line 8 :   r = p2 ;
        mov   !L0006, a            ; r      ; Automatic variable r
; line 9 :   a = p1 ; func ( );
        movw  ax, de                ; Register argument p1
        movw  !L0007, ax           ; a      ; Automatic variable a
        call  !_func
; line 10 :  }
        pop   de                    ; Returns the register for register argument
        ret

```



**(b) Example 2**

&lt;C source&gt;

```

void func5 ( int, register char );
void func ( void );

void main ( ) {
    func5 (0x1234, 0x56 );
}

void func5 ( int p1, register char p2 ) {
    register char  r ;
    int          a ;
    r = p2 ;
    a = p1 ; func ( );
}

```

**<1> When -nq is specified**

The output code is as follows.

```

@@DATA  DSEG  UNITP
L0005   : DS   ( 2 )
L0006   : DS   ( 2 )

; line 1 :   void func5 ( int, register char ); void func ( void );
; line 2 :   void main ( ) {

@@CODE  CSEG
_main :
; line 3 :   func5 ( 0x1234, 0x56 );
          mov    b, #056H      ; 86      ; Pass the second argument via register B
          movw   ax, #01234H ; 4660    ; Pass the first argument via register AX
          call  !_func5        ; Function call
; line 4 :   }
          ret

; line 5 :   void func5 ( int p1, register char p2 ) {
_func5 :
          push  de              ; Saves a register for register
                                variables and register arguments
          movw  !L0005, ax      ; Copy argument p1 to L0005
          mov   a, b
          mov   d, a            ; Allocates a register argument p2 to d
; line 6 :   register char  r ;
; line 7 :   int          a ;
; line 8 :   r = p2 ;
          mov   a, d            ; Register argument p2
          mov   e, a            ; Automatic variable r

```

```

; line 9 :   a = p1 ; func ( );
            movw   ax, !L0005      ; p1      ; Argument p1
            movw   !L0006, ax      ; a       ; Automatic variable a
            call   !_func
; line 10 :   }
            pop    de              ; Returns the register for register
                                   argument
            ret

```

### 3.4.6 Pascal function call interface

The difference between the pascal function call interface and other function call interfaces is that the correction for the amount of stack used to store function argument is done by the called function, rather than by the calling side. All other features are determined by function attributes specified at the same time as the pascal attribute.

[Area where arguments are allocated]

[Order in which arguments are allocated]

[Area where automatic variables are allocated]

[Order in which automatic variables are allocated]

- If the noauto attribute is specified at the same time, other features are the same as when a noauto function is called. (See "[3.4.3 noauto function call interface \(only for normal model\)](#)").
- If the noauto attribute is not specified at the same time, other features are the same as when an ordinary function is called. (See "[3.4.2 Ordinary function call interface](#)".)

#### (1) Example

##### (a) Example1

<C source>

```

__pascal      void func0 ( register int, int );

void main ( ) {
    func0 ( 0x1234, 0x5678 );
}

__pascal      void func0 ( register int p1, int p2 ) {
    register int    r ;
    int            a ;
    r = p2 ;
    a = p1 ;
}

```

#### <1> When -qr option is specified

The output code is as follows.

```

_main :
; line 4 :   func0 ( 0x1234, 0x5678 );
            movw   ax, #05678H      ; 22136

```

```

    push    ax                /* Stack is passed via the argument*/
    movw   ax, #01234H      ; 4660 /* The first argument that is passed
                                   via a register */
    call   !_func0         /* Function call */
                                   /* Stack is not corrected here */
; line 5 :    }
    ret
; line 6 :    __pascal      void func0 ( register int p1, int p2 ) {
_func0 :
    push   hl
    xch   a, x
    xch   a, @_KREG12
    xch   a, x
    xch   a, @_KREG13      /* Allocate a register argument p1 to
                           @_KREG12 */
    push  ax                /* Saves the saddr area for register
                           arguments */
    movw  ax, @_KREG00
    push  ax                /* Saves the saddr area for register
                           variable */
    push  ax                /* Reserves the area automatic variable a */
    movw  ax, sp
    movw  hl, ax
; line 7 :    register int   r ;
; line 8 :    int          a ;
; line 9 :    r = p2 ;
    mov   a, [hl+10]      ; p2 /* Stack transfer argument p2 */
    xch  a, x
    mov  a, [hl+11]      ; p2
    movw @_KREG00, ax    ; r /* Assign to register variable
                           @_KREG00 */
; line 10 :   a = p1 ;
    movw ax, @_KREG12    ; p1 /* Register argument @_KREG12 */
    mov  [hl+1], a      ; a
    xch  a, x
    mov  [hl], a        ; a /* Assign to automatic variable a */
; line 11 :   }
    pop  ax                /* Releases the automatic variable a area */
    pop  ax
    movw @_KREG00, ax    /* Restore the saddr area for register
                           variable */
    pop  ax
    movw @_KREG12, ax    /* Restore the saddr area for register
                           argument */
    pop  hl

```

```

pop     de          /* Obtains the return address */
pop     ax          /* The stack consumed by arguments
                    passed via a stack is corrected */
push    de          /* Reloads the return address */
ret

```

**(b) Example2**

&lt;C source&gt;

```

__pascal      noauto void func2 ( int, int );

void main ( ) {
    func2 ( 0x1234, 0x5678 );
}
__pascal      noauto void func2 ( int p1, int p2 ) {
:
}

```

**<1> When -qr option is specified**

The output code is as follows.

```

_main :
; line 4 :      func2 ( 0x1234, 0x5678 );
movw    ax, #05678H      ; 22136
push    ax              /* Argument passed via a stack */
movw    ax, #01234H      ; 4660 /* The first argument that is passed
                               via a register */
call    !_func2         /* Function call */
                               /* The stack is not corrected here */
; line 5 :      }
ret
; line 6 :      __pascal      noauto void func2 ( int p1, int p2 ) {
_func2 :
push    hl              /* Saves a register for the argument */
xch     a, x
xch     a, @_KREG12     /* Allocate the argument p1 to @_KREG12
                       (lower) */
xch     a, x
xch     a, @_KREG13     /* Allocate the argument p1 to @_KREG13
                       (higher) */
push    ax              /* Saves the saddr area for arguments */
movw    ax, sp
movw    hl, ax
mov     a, [hl+6]      /* Argument p2 (low-order) passed via a stack
                       and received via a register */

```

```

xch    a, x
mov    a, [hl+7]    /* Argument p2 (high-order) passed via a stack
                   and received via a register */
movw   hl, ax      /* Allocate arguments to HL */
:
pop    ax
movw   @_KREG12, ax /* Restore the saddr area for argument */
pop    hl          /* Restores the register for argument */
pop    de          /* Obtains the return address */
pop    ax          /* The stack consumed by arguments passed via a
                   stack is corrected */
push   de          /* Reloads the return address */
ret

```

### 3.5 List of saddr Area Labels

78K0 C compiler uses the following labels to reference addresses in the saddr area. Therefore, the names in the following tables cannot be used in C and assembler source programs.

#### 3.5.1 Normal model

##### (1) Register variables

Label Name	Address
_ <b>@KREG00</b>	0FED0H
_ <b>@KREG01</b>	0FED1H
_ <b>@KREG02</b>	0FED2H
_ <b>@KREG03</b>	0FED3H
_ <b>@KREG04</b>	0FED4H
_ <b>@KREG05</b>	0FED5H
_ <b>@KREG06</b>	0FED6H
_ <b>@KREG07</b>	0FED7H
_ <b>@KREG08</b>	0FED8H
_ <b>@KREG09</b>	0FED9H
_ <b>@KREG10</b>	0FEDA H
_ <b>@KREG11</b>	0FEDB H
_ <b>@KREG12</b>	0FEDC H <sup>Note</sup>
_ <b>@KREG13</b>	0FEDD H <sup>Note</sup>
_ <b>@KREG14</b>	0FEDE H <sup>Note</sup>
_ <b>@KREG15</b>	0FEDF H <sup>Note</sup>

**Note** When the arguments of the function are declared by register or the -qv option is specified and the -qr option is specified, arguments are allocated to the saddr area.

**(2) Arguments of norec function**

Label Name	Address
_ @NRARG0	0FEC0H
_ @NRARG1	0FEC2H
_ @NRARG2	0FEC4H
_ @NRARG3	0FEC6H

**(3) Automatic variables of norec function**

Label Name	Address
_ @NRAT00	0FEC8H
_ @NRAT01	0FEC9H
_ @NRAT02	0FECAH
_ @NRAT03	0FECBH
_ @NRAT04	0FECCH
_ @NRAT05	0FECDH
_ @NRAT06	0FECEH
_ @NRAT07	0FECFH

**(4) Arguments of runtime library**

Label Name	Address
_ @RTARG0	0FEB8H
_ @RTARG1	0FEB9H
_ @RTARG2	0FEBAH
_ @RTARG3	0FEBBH
_ @RTARG4	0FEBCH
_ @RTARG5	0FEBDH
_ @RTARG6	0FEBEH
_ @RTARG7	0FEBFH

**3.5.2 Static model****(1) Shared area**

Label Name	Address
_ @KREG00	0FED0H
_ @KREG01	0FED1H
_ @KREG02	0FED2H
_ @KREG03	0FED3H

Label Name	Address
_ @KREG04	0FED4H
_ @KREG05	0FED5H
_ @KREG06	0FED6H
_ @KREG07	0FED7H
_ @KREG08	0FED8H
_ @KREG09	0FED9H
_ @KREG10	0FEDA H
_ @KREG11	0FEDBH
_ @KREG12	0FEDCH
_ @KREG13	0FEDDH
_ @KREG14	0FEDEH
_ @KREG15	0FEDFH

**(2) For arguments, automatic variables, and work**

Label Name	Address
_ @NRAT00	0FE <sub>xx</sub> H <sup>Note</sup>
_ @NRAT01	_ @NRAT00 + 1
_ @NRAT02	_ @NRAT00 + 2
_ @NRAT03	_ @NRAT00 + 3
_ @NRAT04	_ @NRAT00 + 4
_ @NRAT05	_ @NRAT00 + 5
_ @NRAT06	_ @NRAT00 + 6
_ @NRAT07	_ @NRAT00 + 7

**Note** Any address in the saddr area

**3.6 List of Segment Names**

This section explains all the segments that the compiler outputs and their locations.

The tables below list the relocation attributes that appear in the tables of this section.

- CSEG relocation attributes

CALLT0	Allocates the specified segment so that the start address is a multiple of two within the range of 40H - 7FH.
AT absolute expression	Allocates the specified segment to an absolute address (within the range of 0000H - 0FEFFH).
FIXED	Allocates the specified segment within the range 800H to 0FFFH.
UNITP	Allocates the specified segment so that the start address is a multiple of two within any position (within the range of 80H - 0FA7EH).

- DSEG relocation attributes

SADDRP	Allocates the specified segment so that the start address is a multiple of two within the range of 0FE20H - 0FEFFH in the saddr area.
UNITP	Allocates the specified segment so that the start address is a multiple of two within any position (default is within the RAM area).

### 3.6.1 List of segment names

#### (1) Program areas and data areas

Section Name	Segment Type	Re-allocation Attribute	Description
@@CODE	CSEG		Segment for code portion
@@LCODE	CSEG		Segment for library code
@@CNST	CSEG	UNITP	ROM data <sup>Note 1</sup>
@@R_INIT	CSEG	UNITP	Segment for initialization data (with initial value)
@@R_INIS	CSEG	UNITP	Segment for initialization data (sreg variable with initial value)
@@CALF	CSEG	FIXED	Segment for callf functions
@@CALT	CSEG	CALLT0	Segment for callt function table
@@VECT $nn$	CSEG	AT 00 $nn$ H	Segment for vector table <sup>Note 2</sup>
@@INIT	DSEG	UNITP	Segment for data area (with initial value)
@@DATA	DSEG	UNITP	Segment for data area (without initial value)
@@INIS	DSEG	SADDRP	Segment for data area (sreg variable with initial value)
@@DATS	DSEG	SADDRP	Segment for data area (sreg variable without initial value)
@@BITS	BSEG		Segment for boolean-type and bit-type variables
@@BANK0 to @@BANK15	CSEG	BANK0 to BANK15	Segments for bank functions

**Notes 1.** ROM data refers to the following types of data.

- Segment for const variables
- Unnamed string literals
- Initial data for auto variables

**2.** The value of  $nn$  varies depending on the interrupt type.

#### (2) Flash memory areas

Section Name	Segment Type	Re-allocation Attribute	Description
@ECODE	CSEG		Segment for code portion
@LECODE	CSEG		Segment for library code
@ECNST	CSEG	UNITP	ROM data <sup>Note 1</sup>
@ER_INIT	CSEG	UNITP	Segment for initialization data (with initial value)



Section Name	Segment Type	Re-allocation Attribute	Description
@ER_INIS	CSEG	UNITP	Segment for initialization data (sreg variable with initial value)
@EVECT $nn$	CSEG	AT $mmmm$ H	Segment for vector table <sup>Note 2</sup>
@EXT $xx$	CSEG	AT $yyyy$ H	Segment for flash area branch table <sup>Note 3</sup>
@EINIT	DSEG	UNITP	Segment for data area (with initial value)
@EDATA	DSEG	UNITP	Segment for data area (without initial value)
@EINIS	DSEG	SADDRP	Segment for data area (sreg variable with initial value)
@EDATS	DSEG	SADDRP	Segment for data area (sreg variable without initial value)
@EBITS	BSEG		Segment for boolean-type and bit-type variables
@CALF	CSEG		Dummy segment
@ECALT	CSEG		Dummy segment

**Notes 1.** ROM data refers to the following types of data.

- Segment for const variables
- Unnamed string literals
- Initial data for auto variables

**2.** The values of  $nn$  and  $mmmm$  vary depending on the interrupt type.

**3.** The values of  $xx$  and  $yyyy$  vary depending on the ID of the flash area function.

### 3.6.2 Segment allocation

Segment Type	Location (Default)
CSEG	ROM
BSEG	saddr area of RAM
DSEG	RAM

### 3.6.3 Example of C source

```
#pragma INTERRUPT      INTPO  inter  rbl  /* Interrupt vector */

void inter ( void );          /* Interrupt function prototype
                              declaration */

const  int      i_cnst = 1 ;   /* const variable */
callt  void f_clt ( void );   /* callt function prototype declaration */
callf  void f_clf ( void );   /* callf function prototype declaration */
boolean b_bit ;              /* boolean-type variable */
long   l_init = 2 ;          /* External variable with initial value */
int    i_data ;              /* External variable without initial
                              value */

sreg   int      sr_inis = 3 ;  /* sreg variable with initial value */
sreg   int      sr_dats ;     /* sreg variable without initial value */
```

```

void main ( ) {                                     /* Function definition */
    int    i ;
    i = 100 ;
}

void inter ( ) {                                     /* Interrupt function definition */
    unsigned char  uc = 0 ;
    uc++ ;
    if ( b_bit )
        b_bit = 0 ;
}

callt void f_clt ( ) {                               /* callt function definition */
}

callf void f_clf ( ) {                               /* callf function definition */
}

```

#### 3.6.4 Example of output assembler module

Directives and instructions sets in assembly language source output vary according to the target device. For details, see "[CHAPTER 4 ASSEMBLY LANGUAGE SPECIFICATION](#)".

```

; 78K0 C Compiler V3.30 Assembler Source
;
;                                     Date : xx xxx xxxx Time : xx : xx : xx
;
; Command   : -cF051144 sample.c -sa -ng
; In-file   : sample.c
; Asm-file  : sample.asm
; Para-file :

$PROCESSOR ( F051144 )
$NODEBUG
$NODEBUGA
$KANJI CODE SJIS
$TOL_INF    03FH, 0330H, 00H, 020H, 00H

        PUBLIC  _inter
        PUBLIC  _i_cnst
        PUBLIC  ?f_clt
        PUBLIC  _f_clf
        PUBLIC  _b_bit
        PUBLIC  _l_init
        PUBLIC  _i_data
        PUBLIC  _sr_inis
        PUBLIC  _sr_dats

```

```

PUBLIC _main
PUBLIC _f_clt
PUBLIC _@vect06

@@BITS      BSEG                ; Segment for boolean-type variable
_b_bit      BIT

@@CNST      CSEG UNITP          ; Segment for const variable
_i_cnst :   DW    01H           ; 1

@@R_INIT    CSEG UNITP          ; Segment for initialization data (External variable
                                with initial value)
                                DW    00002H, 00000H ; 2

@@INIT      DSEG UNITP          ; Segment for data area (External variable with initial
                                value)
_l_init :   DS    ( 4 )

@@DATA      DSEG UNITP          ; Segment for data area (External variable without
                                initial value)
_i_data :   DS    ( 2 )

@@R_INIS    CSEG UNITP          ; Segment for initialization data (sreg variable with
                                initial value)
                                DW    03H           ; 3

@@INIS      DSEG SADDRP        ; Segment for data area (sreg variable with initial
                                value)
_sr_inis :  DS    ( 2 )

@@DATS      DSEG SADDRP        ; Segment for data area (sreg variable without initial
                                value)
_sr_dats :  DS    ( 2 )

@@CALT      CSEG CALLT0        ; Segment for callt function
?f_clt :    DW    _f_clt
; line 1 :  #pragma INTERRUPT  INTP0  inter  rbl  /* Interrupt vector */
; line 2 :
; line 3 :  void inter ( void );                /* Interrupt function prototype declaration */
; line 4 :  const int    i_cnst = 1 ;           /* const variable */
; line 5 :  callt void f_clt ( void );          /* callt function prototype declaration */
; line 6 :  callf void f_clf ( void );          /* callf function prototype declaration */
; line 7 :  boolean b_bit ;                    /* boolean-type variable */
; line 8 :  long l_init = 2 ;                  /* External variable with initial value */
; line 9 :  int i_data ;                       /* External variable without initial

```

```

value */
; line 10 : sreg    int    sr_inis = 3 ;    /* sreg variable with initial value */
; line 11 : sreg    int    sr_dats ;        /* sreg variable without initial value */
; line 12 :
; line 13 : void main ( ) {                /* Function definition */

@@CODE CSEG                                ; Segment for code portion
_main :
    push hl                                ; [INF] 1, 4
; line 14 : int     i ;
; line 15 : i = 100 ;
    movw hl, #064H    ; 100 ; [INF] 3, 6
; line 16 : }
    pop  hl                                ; [INF] 1, 4
    ret                                    ; [INF] 1, 6
; line 17 :
; line 18 : void inter ( ) {                /* Interrupt function definition */
_inter :
    sel   RB1                                ; [INF] 2, 4 Selects register bank 1
    push hl                                ; [INF] 1, 4
; line 19 : unsigned char uc = 0 ;
    mov  l, #00H    ; 0 ; [INF] 2, 4
; line 20 : uc++ ;
    inc  l                                ; [INF] 1, 2
; line 21 : if ( b_bit )
    bf   _b_bit, $L0005    ; [INF] 4, 10
; line 22 : b_bit = 0 ;
    clr1 _b_bit    ; [INF] 2, 4
L0005 :
; line 23 : }
    pop  hl                                ; [INF] 1, 4
    reti                                ; [INF] 1, 6
; line 24 :
; line 25 : callt void f_clt ( ) {          /* callt function definition */
_f_clt:
; line 26 : }
    ret                                    ; [INF] 1, 6
; line 27 :
; line 28 : callf void f_clf ( ) {          /* callf function definition */

@@CALF CSEG FIXED                          ; Segment for callf function
_f_clf :
; line 29 : }
    ret                                    ; [INF] 1, 6
@@VECT06 CSEG AT    0006H    ; Interrupt vector

```

```

_@vect06 :
    DW    _inter
    END
; *** Code Information ***
;
; $FILE C:\NECTools32\work\sample.c
;
; $FUNC  main ( 14 )
;      void = ( void )
;      CODE SIZE = 6 bytes, CLOCK_SIZE = 20 clocks, STACK_SIZE = 2 bytes
;
; $FUNC  inter ( 20 )
;      void = ( void )
;      CODE SIZE = 14 bytes, CLOCK_SIZE = 38 clocks, STACK_SIZE = 2 bytes
;
; $FUNC  f_clt ( 28 )
;      void = ( void )
;      CODE SIZE = 1 bytes, CLOCK_SIZE = 6 clocks, STACK_SIZE = 0 bytes
;
; $FUNC  f_clf ( 32 )
;      void = ( void )
;      CODE SIZE = 1 bytes, CLOCK_SIZE = 6 clocks, STACK_SIZE = 0 bytes

; Target chip : uPD78F051144
; Device file : Vx.xx

```

## CHAPTER 4 ASSEMBLY LANGUAGE SPECIFICATION

This chapter explains the assembly language specifications supported by 78K0 assembler.

#### 4.1 Description Methods of Source Program

This section explains the description methods, expressions and operators of the source program.

##### 4.1.1 Basic configuration

When a source program is described by dividing it into several modules, each module that becomes the unit of input to the assembler is called a source module (if a source program consists of a single module, "source program" means the same as "source module").

Each source module that becomes the unit of input to the assembler consists mainly of the following three parts:

- [Module header](#) (Module Header)
- [Module body](#) (Module Body)
- [Module tail](#) (Module Tail)

**Figure 4-1. Source Module Configuration**

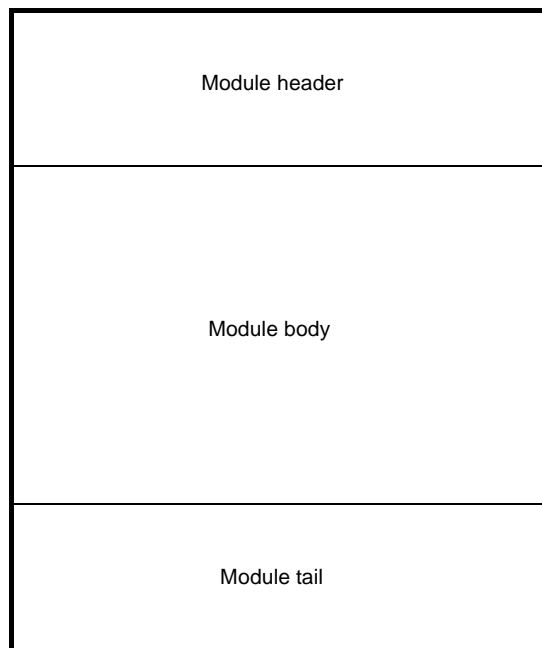

##### (1) Module header

In the module header, the control instructions shown below can be described. Note that these control instructions can only be described in the module header.

Also, the module header can be omitted.

Table 4-1. Instructions That Can Appear in Module Headers

Type of Instruction	Description
Control instructions with the same functions as assembler options	<ul style="list-style-type: none"> <li>- PROCESSOR</li> <li>- DEBUG/NODEBUG/DEBUGA/NODEBUGA</li> <li>- XREF/NOXREF</li> <li>- SYMLIST/NOSYMLIST</li> <li>- TITLE</li> <li>- FORMFEED/NOFORMFEED</li> <li>- WIDTH</li> <li>- LENGTH</li> <li>- TAB</li> <li>- KANJICODE</li> </ul>
Special control instructions output by a C compiler or other high-level program	<ul style="list-style-type: none"> <li>- TOL_INF</li> <li>- DGS</li> <li>- DGL</li> </ul>

**(2) Module body**

he following may not appear in the module body.

- Control instructions with the same functions as assembler options

All other directives, control instructions, and instructions can be described in the module body.

The module body must be described by dividing it into units, called "segments".

Segments are defined with the corresponding directives, as follows.

- Code segment  
Defined with the CSEG directive
- Data segment  
Defined with the DSEG directive
- Bit segment  
Defined with the BSEG directive
- Absolute segment  
Defined with the CSEG, DSEG, or BSEG directive, plus an absolute address (AT location address) as the relocation attribute. Absolute segments can also be defined with the ORG directive.

The module body may be configured as any combination of segments.

However, data segments and bit segments should be defined before code segments.

**(3) Module tail**

The module tail indicates the end of the source module. The END directive must be described in this part.

If anything other than a comment, a blank, a tab, or a line feed code is described following the END directive, the assembler will output a warning message and ignore the characters described after the END directive.

(4) Overall configuration of source program

The overall configuration of a source module (source program) is as shown below.

Figure 4-2. Overall Configuration of Source Program

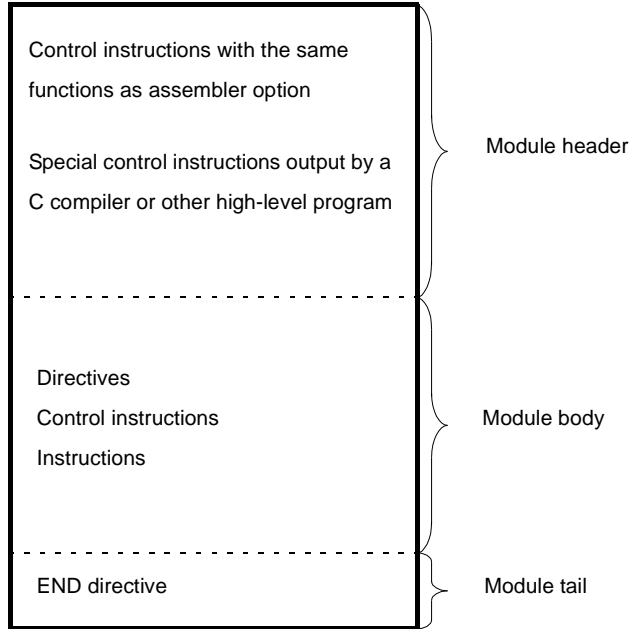

Examples of simple source module configurations are shown below.

Figure 4-3. Examples of Source Module Configurations

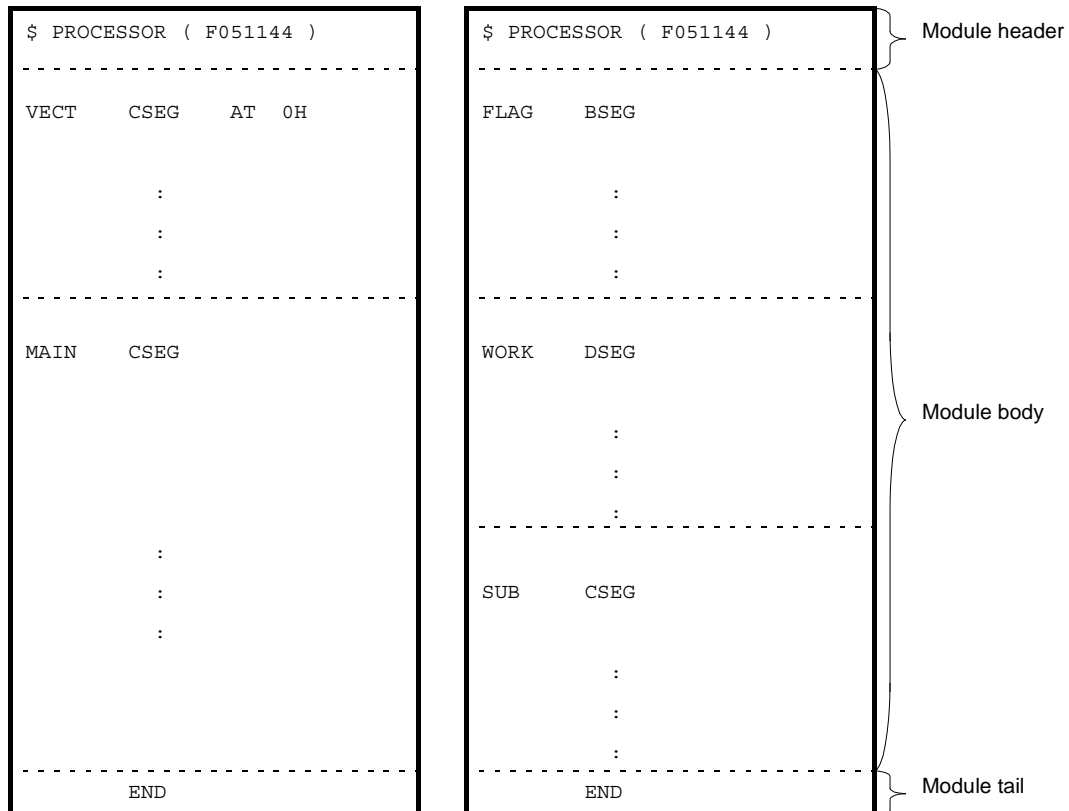



(5) Coding example

In this subsection, a description example of a source module (source program) is shown as a sample program. The configuration of the sample program can be illustrated simply as follows.

Figure 4-4. Sample Source Program Configuration

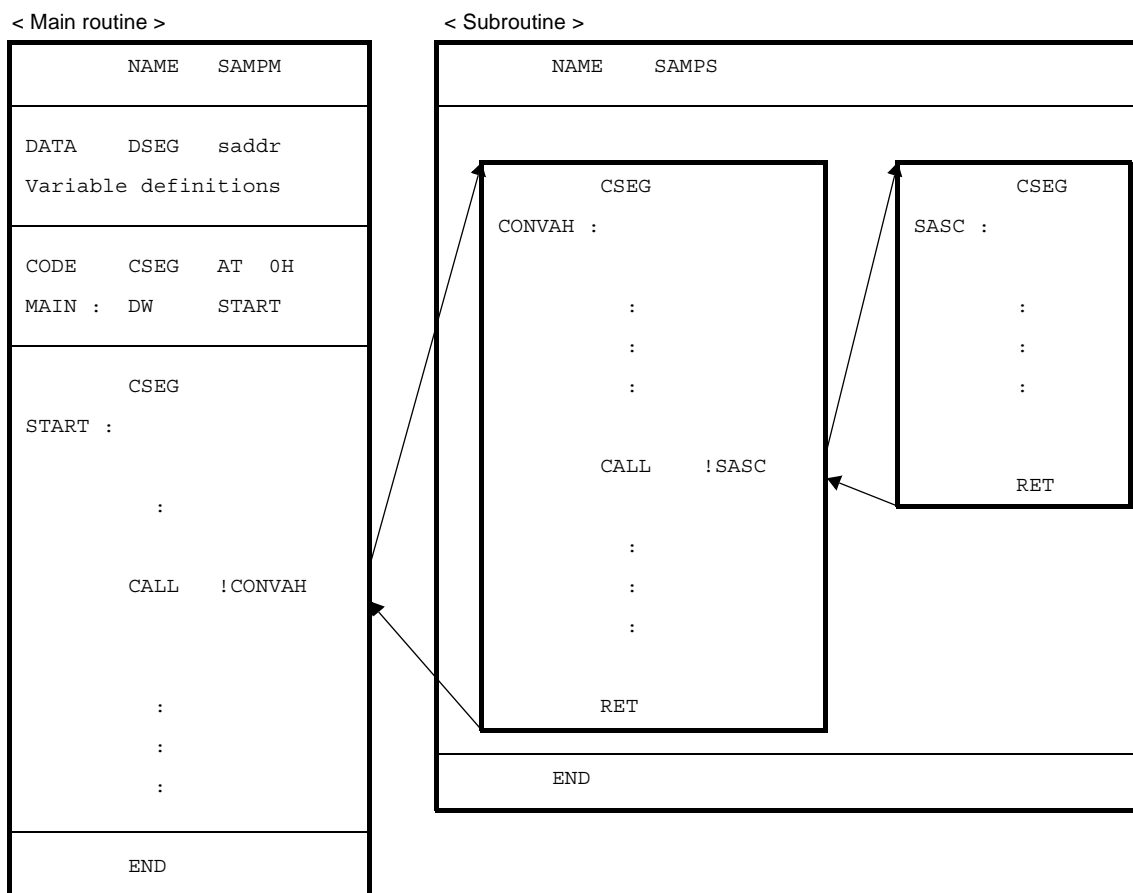

- Main routine

```

NAME      SAMPM          ; (1)
; *****
;      HEX -> ASCII Conversion Program
;      main-routine
; *****

PUBLIC MAIN, START      ; (2)
EXTRN  CONVAH           ; (3)
EXTRN  @_STBEG         ; (4)  <- Error

DATA    DSEG    saddr    ; (5)
HDTSA  : DS     1
STASC  : DS     2

CODE    CSEG    AT 0H    ; (6)
    
```

```

MAIN : DW      START

      CSEG          ; (7)

START :
      ; chip initialize
      MOVW    SP, #_@STBEG

      MOV     HDTSA, #1AH
      MOVW   HL, #HDTSA      ; set hex 2-code data in HL register
      CALL  !CONVAH        ; convert ASCII <- HEX
                          ; output BC-register <- ASCII code

      MOVW   DE, #STASC     ; set DE <- store ASCII code table
      MOV    A, B
      MOV    [DE], A
      INCW  DE
      MOV    A, C
      MOV    [DE], A
      BR    $$
      END          ; (8)

```

- (1) Declaration of module name
- (2) Declaration of symbol referenced from another module as an external reference symbol
- (3) Declaration of symbol defined in another module as an external reference symbol
- (4) Declaration of stack resolution symbol. This will be generated by the linker when the program is linked with the -s option specified. (An error occurs if the linker -s option is not specified.)
- (5) Declaration of the start of a data segment (to be located in saddr)
- (6) Declaration of start of code segment (to be located as an absolute segment starting from address 0H)
- (7) Declaration of start of another code segment (ending the absolute code segment)
- (8) Declaration of end of module

- Subroutine

```

      NAME    SAMPS          ; (9)
; *****
;      HEX -> ASCII Conversion Program
;      sub-routine
;
;      input condition      : ( HL )      <- hex 2 code

```

```

; *****
PUBLIC CONVAH                ; (10)

; output condition : BC-register  <- ASCII 2 code
CSEG                          ; (11)
CONVAH :
    XOR    A, A
    ROL4   [HL]                ; hex upper code load
    CALL  !SASC
    MOV    B, A                ; store result

    XOR    A, A
    ROL4   [HL]                ; hex lower code load
    CALL  !SASC
    MOV    C, A                ; store result
    RET

; *****
;      subroutine  convert ASCII code
;
; input      Acc ( lower 4bits )  <- hex code
; output     Acc                  <- ASCII code
; *****

CSEG
SASC :
    CMP    A, #0AH            ; check hex code > 9
    BC     $SASC1
    ADD    A, #07H            ; bias ( +7H )
SASC1 :
    ADD    A, #30H            ; bias ( +30H )
    RET
END                          ; (12)

```

**(9) Declaration of module name**

**(10) Declaration of symbol referenced from another module as an external definition symbol**

**(11) Declaration of start of code segment**

**(12) Declaration of end of module**

4.1.2 Description method

(1) Configuration

A source program consists of statements.  
 A statement is made up of the 4 fields shown below.

Figure 4-5. Statement Fields

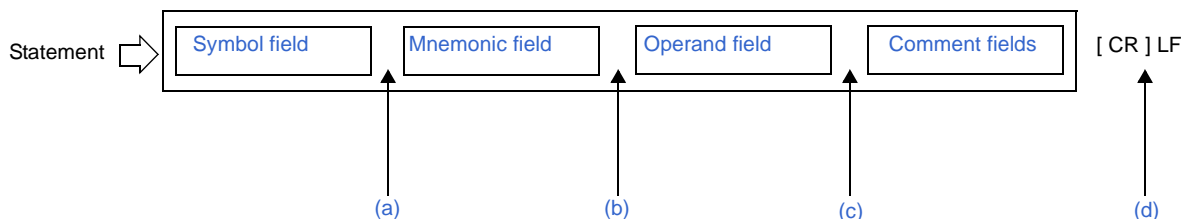

- (a) The symbol field and the mnemonic field must be separated by a colon ( : ) or one or more spaces or tabs. (Whether a colon or space is required depends on the instruction in the mnemonic field.)
- (b) The mnemonic field and the operand field must be separated by one or more spaces or tabs. Depending on the instruction in the mnemonic field, the operand field may not be required.
- (c) The comment field, if present, must be preceded by a semicolon ( ; ).
- (d) Each line in the source program ends with an LF code. (One CR code may exist before the LF code.)

- A statement must be described in 1 line. The line can be up to 2048 characters long (including CR/LF). TAB and the CR (if present) are each counted as 1 character. If the length of the line exceeds 2048 characters, a warning is issued and all characters beyond the 2048th are ignored for purposes of assembly. However, characters beyond 2048 are output to assembler list files.
- Lines consisting of CR only are not output to assembler list files.
- The following line types are valid.
  - Empty lines (lines with no statements)
  - Lines consisting of the symbol field only
  - Lines consisting of the comment field only

(2) Character set

Source files can contain the following 3 types of characters.

- Language characters
- Character data
- Comment characters

(a) Language characters

Language characters are the characters used to describe instructions in source programs.  
 The language character set includes alphabetic, numeric, and special characters.

Table 4-2. Alphanumeric Characters

Name	Characters
Numeric characters	0 1 2 3 4 5 6 7 8 9

Name		Characters
Alphabetic characters	Uppercase	A B C D E F G H I J K L M N O P Q R S T U V W X Y Z
	Lowercase	a b c d e f g h i j k l m n o p q r s t u v w x y z

**Table 4-3. Special Characters**

Character	Name	Main Use	
?	Question mark	Symbol equivalent to alphabetic characters	
@	Circa	Symbol equivalent to alphabetic characters	
_	Underscore	Symbol equivalent to alphabetic characters	
	Blank	Field delimiter	Delimiter symbols
HT (09H)	Tab code	Character equivalent to blank	
,	Comma	Operand delimiter	
:	Colon	Label delimiter	
;	Semicolon	Symbol indicating the start of the Comment field	
CR (0DH)	Carriage return code	Symbol indicating the end of a line (ignored in the assembler)	
LF (0AH)	Line feed code	Symbol indicating the end of a line	
+	Plus sign	Add operator or positive sign	Assembler operators
-	Minus sign	Subtract operator or negative sign	
*	Asterisk	Multiply operator	
/	Slash	Divide operator	
.	Period	Bit position specifier	
( )	Left and right parentheses	Symbols specifying the order of arithmetic operations to be performed	
<>	Not equal sign	Relational operator	
=	Equal sign	Relational operator	
'	Single quote mark	- Symbol indicating the start or end of a character constant - Symbol indicating a complete macro parameter	
\$	Dollar sign	- Symbol indicating the location counter - Symbol indicating the start of a control instruction equivalent to an assembler option - Symbol specifying relative addressing	
&	Ampersand	Concatenation symbol (used in macro body)	
#	Sharp sign	Symbol specifying immediate addressing	
!	Exclamation point	Symbol specifying absolute addressing	
[ ]	Brackets	Symbol specifying indirect addressing	

**(b) Character data**

Character data refers to characters used to write string literals, strings, and the quote-enclosed operands of some control instructions (TITLE, SUBTITLE, INCLUDE).

- Cautions**
1. **Character data can use all characters except 00H (including multibyte kanji, although the encoding depends on the OS). If 00H is encountered, an error occurs and all characters from the 00H to the closing single quote ( ' ) are ignored.**
  2. **When an invalid character is encountered, the assembler replaces it with an exclamation point ( ! ) in the assembly list. (The CR (0DH) character is not output to assembly lists.)**
  3. **The Windows OS interprets code 1AH as an end of file (EOF) code. Input data cannot contain this code.**

**(c) Comment characters**

Comment characters are used to write comments.

**Caution** **Comment characters and character data have the same character set. However, no error is output for 00H in comments. 00H is replaced by "!" in assembly lists.**

**(3) Symbol field**

The symbol field is for symbols, which are names given to addresses and data objects. Symbols make programs easier to understand.

**(a) Symbol types**

Symbols can be classified as shown below, depending on their purpose and how they are defined.

Symbol Type	Purpose	Definition Method
Name	Used as names for addresses and data objects in source programs.	Write in the symbol field of an EQU, SET, or DBIT directive.
Label	Used as labels for addresses and data objects in source programs.	Write a name followed by a colon ( : ).
External reference name	Used to reference symbols defined by other source modules.	Write in the operand field of an EXTRN or EXTBIT directive.
Segment name	Used at link time.	Write in the symbol field of a CSEG, DSEG, BSEG, or ORG directive.
Module name	Used during symbolic debugging.	Write in the operand field of a NAME directive.
Macro name	Use to name macros in source programs.	Write in the symbol field of a MACRO directive.

**Caution** **The 4 types of symbols that can be written in symbol fields are names, labels, segment names, and macro names.**

**(b) Conventions of symbol description**

Observe the following conventions when writing symbols.

- The characters which can be used in symbols are the alphanumeric characters and special characters (? , @ , \_).
- The first character in a symbol cannot be a digit (0 to 9).
- The maximum length of symbols is 256 characters.  
Characters beyond the maximum length are ignored.
- Reserved words cannot be used as symbols.  
See "4.5 Reserved Words" for a list of reserved words.
- The same symbol cannot be defined more than once.  
However, a name defined with the SET directive can be redefined with the SET directive.
- The assembler distinguishes between lowercase and uppercase characters.
- When a label is written in a symbol field, the colon ( : ) must appear immediately after the label name.

<Examples of correct symbols>

```
CODE01 CSEG          ; "CODE01" is a segment name.
VAR01 EQU 10H       ; "VAR01" is a name.
LAB01 : DW 0        ; "LAB01" is a label.
          NAME SAMPLE ; "SAMPLE" is a module name.
MAC1  MACRO         ; "MAC1" is a macro name.
```

<Examples of incorrect symbols>

```
1ABC EQU 3          ; The first character is a digit.s
LAB MOV A, R0       ; "LAB" is a label and must be separated from the mnemonic field by
                    ; a colon ( : ).
FLAG : EQU 10H     ; The colon ( : ) is not needed for names.
```

<Example of a symbol that is too long>

```
A123456789B12...Y123456789Z123456 EQU 70H
    └──────────────────────────┘
    257characters
; The last character (6) is ignored because it is
; beyond the maximum symbol length.
; The symbol is defined as
; A123456789B12...Y123456789Z12345
```

< Example of a statement composed of a symbol only>

```
ABCD :              ; ABCD is defined as a label.
```

**(c) Points to note about symbols**

??Rannnn (where nnnn = 0000 to FFFF) is a symbol that the assembler replaces automatically every time it generates a local symbol in a macro body. Unless care is taken, this can result in duplicate definitions, which are errors.

The assembler generates a name automatically when a segment definition directive does not specify a name. These segment names are listed below.

Duplicate segment name definitions are errors.

Segment Name	Directive	Relocation Attribute
?A00nnnn (nnnn = 0000 to FFFF)	ORG directive	(none)
?CSEG	CSEG directive	UNIT
?CSEGUP		UNITP
?CSEGTO		CALLTO
?CSEGFIX		FIXED
?CSEGIX		IXRAM
?CSEGS		SECUR_ID
?CSEGB0 to 15		BANK0 to 15
?CSEGOB0		OPT_BYTE
?DSEG		DSEG directive
?DSEGUP	UNITP	
?DSEGS	SADDR	
?DSEGSP	SADDRP	
?DSEGIH	IHRAM	
?DSEGL	LRAM	
?DSEGDSP	DSPRAM	
?DSEGIX	IXRAM	
?BSEG	BSEG directive	UNIT

**(d) Symbol attributes**

Every name and label has both a value and an attribute.

The value is the value of the defined data object, for example a numerical value, or the value of the address itself.

Segment names, module names, and macro names do not have values.

The following table lists symbol attributes.

Attribute Type	Classification	Value
NUMBER	- Name to which numeric constants are assigned - Symbols defined with the EXTRN directive - Numeric constants	Decimal notation : 0 to 65535 Hexadecimal notation : 0H to FFFFH(unsigned)
ADDRESS	- Symbols defined as labels - Names of labels defined with the EQU and SET directives	Decimal notation : 0 to- 65535 Hexadecimal notation : 0H to FFFFH



Attribute Type	Classification	Value
BIT	- Names defined as bit values - Names in BSEG - Symbols defined with the EXTBIT directive	SFR, saddr area
SFR	Names defined as SFRs with the EQU directive	SFR area
SFRP	Names defined as SFRs with the EQU directive	
CSEG	Segment names defined with the CSEG directive	These attribute types have no values.
DSEG	Segment names defined with the DSEG directive	
BSEG	Segment names defined with the BSEG directive	
MODULE	Module names defined with the NAME directive. (If not specified, a module name is created from the primary name of the input source filename.)	
MACRO	Macro names defined with the MACRO directive	

<Examples>

TEN	EQU	10H	; Name "TEN" has attribute "NUMBER" and value "10H".
	ORG	80H	
START	: MOV	A, #10H	; Label "START" has attribute "ADDRESS" and value "80H".
BIT1	EQU	0FE20H.0	; Name "BIT1" has attribute "BIT" and value "0FE20H.0".

#### (4) Mnemonic field

Write instruction mnemonics, directives, and macro references in the mnemonic field.

If the instruction or directive requires an operand or operands, the mnemonic field must be separated from the operand field with one or more blanks or tabs.

However, if the first operand begins with "#", "\$", "!", or "[", the statement will be assembled properly even if nothing exists between the mnemonic field and the first operand field.

<Examples of correct mnemonics>

MOV	A, #0H
CALL	!CONVAH
RET	

<Examples of incorrect mnemonics>

MOVA	#0H	; There is no blank between the mnemonic and operand fields.
C ALL	!CONVAH	; The mnemonic field contains a blank.
ZZZ		; The 78K0 series does not have a ZZZ instruction.

**(5) Operand field**

In the operand field, write operands (data) for the instructions, directives, or macro references that require them. Some instructions and directives require no operands, while others require two or more.

When you provide two or more operands, delimit them with a comma ( , ).

The following types of data can appear in the operand field:

- Constants (numeric or string)
- Character strings
- Register names
- Special characters (\$ # ! [ ])
- Relocation attributes of segment definition directives
- Symbols
- Expressions
- Bit terms

The size and attribute of the required operand depends on the instruction or directive. See "4.1.15 Operand characteristics" for details.

See the user's manual of the target device for the format and notational conventions of instruction set operands.

The following sections explain the types of data that can appear in the operand field.

**(a) Constants**

A constant is a fixed value or data item and is also referred to as immediate data.

There are numeric constants and character string constants.

- Numeric constants

Numeric constants can be written in binary, octal, decimal, or hexadecimal notation.

The table below lists the notations available for numeric constants.

Numeric constants are handled as unsigned 16-bit data.

The range of possible values is  $0 \leq n \leq 65535$  (FFFFH).

Use the minus sign operator to indicate minus values.

Type	Notation	Example
Binary	Append a "B" or "Y" suffix to the number.	1101B 1101Y
Octal	Append an "O" or "Q" suffix to the number.	74O 74Q
Decimal	Simply write the number, or append a "D" or "T" suffix.	128 128D 128T
Hexadecimal	- Append an "H" suffix to the number. - If the number begins with "A", "B", "C", "D", "E", or "F", prefix it with "0"	8CH 0A6H

- Character string constants

A character-string constant is expressed by enclosing a string of characters from those shown in "(2) Character set", in a pair of single quotation marks ( ' ).

The assembler converts string constants to 7-bit ASCII codes, with the parity bit set to 0.

The length of a string constant is 0 to 2 characters.

To include the single quote character in the string, write it twice in succession.

<Example string constants >

```
'ab'          ; 6162H
'A'           ; 0041H
'A''         ; 4127H
' '          ; 0020H (1 space character)
```

**(b) Character strings**

A character string is expressed by enclosing a string of characters from those shown in "(2) Character set", in a pair of single quotation marks ( ' ).

The main use for character strings is as operands for the DB directives and the TITLE and SUBTITLE control instructions.

<Special character example>

```
                CSEG
MAS1 : DB      'YES'          ; Initialize with character string "YES".
MAS2 : DB      'NO'         ; Initialize with character string "NO".
```

**(c) Register names**

The following registers can be named in the operand field:

- General registers
- General register pairs
- Special function registers

General registers and general register pairs can be described with their absolute names (R0 to R7 and RP0 to RP3), as well as with their function names (X, A, B, C, D, E, H, L, AX, BC, DE, HL).

The register names that can be described in the operand field may differ depending on the type of instruction.

For details of the method of describing each register name, see the user's manual of each device for which software is being developed.

**(d) Special characters**

The following table lists the special characters that can appear in the operand field.

Special Character	Function
\$	- Indicates the location address of the instruction that has the operand (or the first byte of the address, in the case of multibyte instructions). - Indicates relative addressing for a branch instruction.
!	- Indicates absolute addressing for a branch instruction. - Indicates an addr16 specification, which allows a MOV instruction to access the entire memory space.
#	- Indicates immediate data.

Special Character	Function
[ ]	- Indicates indirect addressing.

<Special character example>

Address	Source			
100		ADD	A, #10H	
102	LOOP :	INC	A	
103		BR	\$\$ - 1	; The second \$ in the operand indicates ; address 103H. Describing "BR \$ - 1" ; results in the same operation.
105		BR	!\$ + 100H	; The second \$ in the operand indicates ; address 105H. Describing "BR \$+100H" ; results in the same operation.

**(e) Relocation attributes of segment definition directives**

Relocation attributes can appear in the operand field.

See "4.2.2 Segment definition directives" for more information about relocation attributes.

**(f) Symbols**

When a symbol appears in the operand field, the address (or value) assigned to that symbol becomes the operand value.

<Symbol value example>

VALUE	EQU	1234H		
	MOV	AX, #VALUE	; This could also be written	MOV AX, #1234H

**(g) Expressions**

An expression is a combination of constants, location addresses (indicated by \$), names, labels, and operators, which is evaluated to produce a value.

Expressions can be specified as instruction operands wherever a numeric value can be specified.

See "4.1.3 Expressions and operators" for more information about expressions.

<Expression example>

TEN	EQU	10H	
	MOV	A, #TEN - 5H	

In this example, "TEN - 5H" is an expression.

In this expression, a name and a numeric value are connected by the - (minus) operator. The value of the expression is 0BH, so this expression could be rewritten as "MOV A, #0BH".

**(h) Bit terms**

Bit terms are obtained by the bit position specifier.

See "4.1.13 Bit position specifier" for more information about bit terms.

<Bit term examples>

```
CLR1    A.5
SET1    1 + 0FE30H.3    ; The operand value is 0FE31H.3.
CLR1    0FE40H.4 + 2    ; The operand value is 0FE40H.6.
```

**(6) Comment fields**

Describe comments in the comment field, after a semicolon (;).

The comment field continues from the semicolon to the new line code at the end of the line, or to the EOF code of the file.

Comments make it easier to understand and maintain programs.

Comments are not processed by the assembler, and are output verbatim to assembly lists.

Characters that can be described in the comment field are those shown in "(2) Character set".

<Comment example>

```

NAME      SAMPM
; *****
;      HEX -> ASCII Conversion Program
;      main-routine
; *****

PUBLIC   MAIN, START
EXTRN   CONVAH
EXTRN   @STBEG

DATA    DSEG      saddr
HDTSA:  DS        1
STASC:  DS        2

CODE    CSEG      AT 0H
MAIN :  DW        START

        CSEG
START :

                                ; chip initialize
MOVW    SP, #_@STBEG

MOV     HDTSA, #1AH
MOVW   HL, #HDTSA      ; set hex 2-code data in HL register

CALL   !CONVAH        ; convert ASCII <- HEX
                                ; output BC-register <- ASCII code

MOVW   DE, #STASC     ; set DE <- store ASCII code table
MOV    A, B
MOV    [DE], A
INCW  DE
MOV    A, C
MOV    [DE], A
BR    $$
END

```

Lines with comment fields only

Lines with comment fields only

Lines with comments in comment fields

4.1.3 Expressions and operators

An expression is a symbol, constant, location address (indicated by \$) or bit term, an operator combined with one of the above, or a combination of operators.

Elements of an expression other than the operators are called terms, and are referred to as the 1st term, 2nd term, and so forth from left to right, in the order that they occur in the expression.

The assembler supports the operators shown in "Table 4-4. Operator Types". Operators have priority levels, which determine when they are applied in the calculation. The priority order is shown in "Table 4-5. Operator Precedence Levels".

The order of calculation can be changed by enclosing terms and operators in parentheses "( )".

<Example>

```
MOV    A, #5 * ( SYM + 1 )
```

In the above example, "5 \* ( SYM+1 )" is an expression. "5" is the 1st term, "SYM" is the 2nd term, and "1" is the 3rd term. The operators are "\*", "+", and "( )".

Table 4-4. Operator Types

Operator Type	Operators
Arithmetic operators	+, -, *, /, MOD, +sign, -sign
Logic operators	NOT, AND, OR, XOR
Relational operators	EQ (=), NE (<>), GT (>), GE (>=), LT (<), LE (<=)
Shift operators	SHR, SHL
Byte separation operators	HIGH, LOW
Special operators	DATAPOS, BITPOS, MASK, BANKNUM
Other operator	( )

The above operators can also be divided into unary operators, special unary operators, binary operators, N-ary operators, and other operators.

Unary operators	+sign, -sign, NOT, HIGH, LOW, BANKNUM
Special unary operators	DATAPOS, BITPOS
Binary operators	+, -, *, /, MOD, AND, OR, XOR, EQ (=), NE (<>), GT (>), GE (>=), LT (<), LE (<=), SHR, SHL
N-ary operators	MASK
Other operators	( )

Table 4-5. Operator Precedence Levels

Priority	Level	Operators
Higher	1	+ sign, - sign, NOT, HIGH, LOW, BANKNUM, DATAPOS, BITPOS, MASK
	2	*, /, MOD, SHR, SHL
	3	+, -
	4	AND
	5	OR, XOR
Lower	6	EQ (=), NE (<>), GT (>), GE (>=), LT (<), LE (<=)

Expressions are operated according to the following rules.

- The order of operation is determined by the priority level of the operators.  
When two operators have the same priority level, operation proceeds from left to right, except in the case of unary operators, where it proceeds from right to left.
- Sub-expressions in parentheses "( )" are operated before sub-expressions outside parentheses.
- Operations involving consecutive unary operators are allowed.

Examples:

$$1 = --1 == 1$$

$$-1 = ++1 = -1$$

- Expressions are operated using unsigned 16-bit values.  
If intermediate values overflow 16 bits, the overflow value is ignored.
- If the value of a constant exceeds 16 bits (0FFFFH), an error occurs, and its value is calculated as 0.
- In division, the decimal fraction part is discarded.  
If the divisor is 0, an error occurs and the result is 0.
- Negative values are represented as two's complement.
- External reference symbols are evaluated as 0 at the time when the source is assembled (the evaluation value is determined at link time).
- The results of operating an expression in the operand field must meet the requirements of the instruction for a valid operand.

When the expression includes a relocatable or external reference term, and the instruction requires an 8-bit operand, then object code is generated with the value of the least significant 8 bits and the information required for 16 bits is output in the relocation information. Subsequently the linker checks whether the previously determined value overflows the range of 8 bits. If it overflows, a linking error occurs.

In the case of absolute expressions, the value is determined at the assembly stage and a check is performed at that stage to test whether the result fits in the required range.

For example, the MOV instruction requires 8-bit operands, so the operand must be in the range 0H to 0FFH.

**(1) Correct examples**

```
MOV    A, #'2*' AND 0FH
MOV    A, #4 * 8 * 8 - 1
```

**(2) Incorrect examples**

```
MOV    A, #'2* .
MOV    A, #4 * 8 * 8
```



## (3) Evaluation examples

Expression	Evaluation
$2 + 4 * 5$	22
$(2 + 3) * 4$	20
$10/4$	2
$0 - 1$	0FFFFH
$-1 > 1$	00H (False)
$EXT^{Note} + 1$	1

**Note** EXT : External reference symbols

#### 4.1.4 Arithmetic operators

The following arithmetic operators are available.

Operator	Overview
+	Addition of values of first and second terms
-	Subtraction of value of first and second terms
*	Multiplacation of value of first and second terms.
/	Divides the value of the 1st term of an expression by the value of its 2nd term and returns the integer part of the result.
MOD	Obtains the remainder in the result of dividing the value of the 1st term of an expression by the value of its 2nd term.
+sign	Returns the value of the term as it is.
-sign	The term value 2 complement is sought.

+
---

Addition of values of first and second terms

**[Function]**

Returns the sum of the values of the 1st and 2nd terms of an expression.

**[Application example]**

ORG        100H
START : BR        !\$ + 6                    ; (1)

(1) The BR instruction causes a jump to "current location address plus 6", namely, to address "100H + 6H = 106H".

Therefore, (1) in the above example can also be described as: START : BR !106H

-
---

Subtraction of value of first and second terms

**[Function]**

Returns the result of subtraction of the 2nd-term value from the 1st-term value.

**[Application example]**

ORG	100H		
BACK :	BR	BACK - 6H	; (1)

(1) The BR instruction causes a jump to "address assigned to BACK minus 6", namely, to address "100H - 6H = 0FAH".

Therefore, (1) in the above example can also be described as: **BACK : BR !0FAH**

```
*
```

Multiplication of value of first and second terms

**[Function]**

Returns the result of multiplication (product) between the values of the 1st and 2nd terms of an expression.

**[Application example]**

```
TEN    EQU    10H
      MOV    A, #TEN * 3    ; (1)
```

(1) With the EQU directive, the value "10H" is defined in the name "TEN".

"#" indicates immediate data. The expression "TEN \* 3" is the same as "10H \* 3" and returns the value "30H".

Therefore, (1) in the above expression can also be described as: MOV A , #30H

/

Divides the value of the 1st term of an expression by the value of its 2nd term and returns the integer part of the result.

**[Function]**

Divides the value of the 1st term of an expression by the value of its 2nd term and returns the integer part of the result.

The decimal fraction part of the result will be truncated. If the divisor (2nd term) of a division operation is 0, an error occurs

**[Application example]**

MOV     A, #256 / 50             ;   (1)

**(1) The result of the division "256 / 50" is 5 with remainder 6.**

**The operator returns the value "5" that is the integer part of the result of the division.**

**Therefore, (1) in the above expression can also be described as: MOV A , #5**

**MOD**

Obtains the remainder in the result of dividing the value of the 1st term of an expression by the value of its 2nd term.

**[Function]**

Obtains the remainder in the result of dividing the value of the 1st term of an expression by the value of its 2nd term.

An error occurs if the divisor (2nd term) is 0.

A blank is required before and after the MOD operator.

**[Application example]**

```
MOV    A, #256 MOD 50    ; (1)
```

(1) The result of the division "256 / 50" is 5 with remainder 6.

The MOD operator returns the remainder 6.

Therefore, (1) in the above expression can also be described as: MOV A , #6

**+sign**

Returns the value of the term as it is.

**[Function]**

Returns the value of the term of an expression without change.

**[Application example]**

```
FIVE EQU +5 ; (1)
```

(1) The value "5" of the term is returned without change.

The value "5" is defined in name "FIVE" with the EQU directive.



**-sign**

The term value 2 complement is sought.

**[Function]**

Returns the value of the term of an expression by the two's complement.

**[Application example]**

```
NO      EQU      -1      ; (1)
```

(1) -1 becomes the two's complement of 1.

The two's complement of binary 0000 0000 0000 0001 becomes:

1111 1111 1111 1111 Therefore, with the EQU directive, the value "0FFFFH" is defined in the name "NO".

#### 4.1.5 Logic operators

The following logic operators are available.

Operator	Overview
NOT	Obtains the logical negation (NOT) by each bit.
AND	Obtains the logical AND operation for each bit of the first and second term values.
OR	Obtains the logical OR operation for each bit of the first and second term values.
XOR	Obtains the exclusive OR operation for each bit of the first and second term values.

**NOT**

Obtains the logical negation (NOT) by each bit.

**[Function]**

Negates the value of the term of an expression on a bit-by-bit basis and returns the result.  
 A blank is required between the NOT operator and the term.

**[Application example]**

```
MOVW AX, #NOT 3H ; (1)
```

(1) Logical negation is performed on "3H" as follows :  
**0FFFCH is returned.**

Therefore , (1) can also be described as : **MOVW AX , #0FFFCH**

NOT)	0000	0000	0000	0011
	1111	1111	1111	1100

**AND**

Obtains the logical AND operation for each bit of the first and second term values.

**[Function]**

Performs an AND (logical product) operation between the value of the 1st term of an expression and the value of its 2nd term on a bit-by-bit basis and returns the result.

A blank is required before and after the AND operator.

**[Application example]**

```
MOV    A, #6FAH AND 0FH    ; (1)
```

(1) AND operation is performed between the two values "6FAH" and "0FH" as follows:

	0000	0110	1111	1010
AND)	0000	0000	0000	1111
	0000	0000	0000	1010

The result "0AH" is returned. Therefore, (1) in the above expression can also be described as:  
**MOV A , #0AH**

**OR**

Obtains the logical OR operation for each bit of the first and second term values.

**[Function]**

Performs an OR (Logical sum) operation between the value of the 1st term of an expression and the value of its 2nd term on a bit-by-bit basis and returns the result.

A blank is required before and after the OR operator.

**[Application example]**

```
MOV    A, #0AH OR 1101B    ; (1)
```

**(1) OR operation is performed between the two values "0AH" and "1101B" as follows:**

	0000	0000	0000	1010
OR)	0000	0000	0000	1101
	0000	0000	0000	1111

**The result "0FH" is returned.**

**Therefore, (1) in the above expression can also be described as: MOV A , #0FH**

**XOR**

Obtains the exclusive OR operation for each bit of the first and second term values.

**[Function]**

Performs an Exclusive-OR operation between the value of the 1st term of an expression and the value of its 2nd term on a bit-by-bit basis and returns the result. A blank is required before and after the XOR operator.

**[Application example]**

```
MOV    A, #9AH XOR 9DH    ; (1)
```

(1) XOR operation is performed between the two values "9AH" and "9DH" as follows:

	0000	0000	1001	1010
XOR)	0000	0000	1001	1101
	0000	0000	0000	0111

The result "7H" is returned.

Therefore, (1) in the above expression can also be described as: MOV A , #7H

#### 4.1.6 Relational operators

The following relational operators are available.

Operator	Overview
EQ ( = )	Compares whether values of first term and second term are equivalent.
NE ( <> )	Compares whether values of first term and second term are not equivalent.
GT ( > )	Compares whether value of first term is greater than value of the second.
GE ( >= )	Compares whether value of first term is greater than or equivalent to the value of the second term.
LT ( < )	Compares whether value of first term is smaller than value of the second.
LE ( <= )	Compares whether value of first term is smaller than or equivalent to the value of the second term.

**EQ (=)**

Compares whether values of first term and second term are equivalent.

**[Function]**

Returns 0FFH (True) if the value of the 1st term of an expression is equal to the value of its 2nd term, and 00H (False) if both values are not equal.

A blank is required before and after the EQ operator.

**[Application example]**

A1	EQU	12C4H			
A2	EQU	12C0H			
	MOV	A, #A1 EQ ( A2 + 4H )			; (1)
	MOV	X, #A1 EQ A2			; (2)

(1) In (1) above, the expression "A1 EQ ( A2 + 4H )" becomes "12C4H EQ ( 12C0H + 4H)".

The operator returns 0FFH because the value of the 1st term is equal to the value of the 2nd term.

(2) In (2) above, the expression "A1 EQ A2" becomes "12C4H EQ 12C0H".

The operator returns 00H because the value of the 1st term is not equal to the value of the 2nd term.



**NE ( <> )**

Compares whether values of first term and second term are not equivalent.

**[Function]**

Returns 0FFH (True) if the value of the 1st term of an expression is not equal to the value of its 2nd term, and 00H (False) if both values are equal.

A blank is required before and after the NE operator.

**[Application example]**

```
A1      EQU      5678H
A2      EQU      5670H

        MOV      A, #A1 NE  A2          ; (1)
        MOV      A, #A1 NE ( A2 + 8H ) ; (2)
```

(1) In (1) above, the expression "A1 NE A2" becomes "5678H NE 5670H".

The operator returns 0FFH because the value of the 1st term is not equal to the value of the 2nd term.

(2) In (2) above, the expression "A1 NE ( A2 + 8H )" becomes "5678H NE ( 5670H + 8H )".

The operator returns 00H because the value of the 1st term is equal to the value of the 2nd term.

**GT ( > )**

Compares whether value of first term is greater than value of the second.

**[Function]**

Returns 0FFH (True) if the value of the 1st term of an expression is greater than the value of its 2nd term, and 00H (False) if the value of the 1st term is equal to or less than the value of the 2nd term.

A blank is required before and after the GT operator.

**[Application example]**

```
A1      EQU      1023H
A2      EQU      1013H

        MOV      A, #A1 GT  A2          ; (1)
        MOV      X, #A1 GT  ( A2 + 10H ) ; (2)
```

**(1) In (1) above, the expression "A1 GT A2" becomes "1023H GT 1013H".**

**The operator returns 0FFH because the value of the 1st term is greater than the value of the 2nd term.**

**(2) In (2) above, the expression "A1 GT ( A2 + 10H )" becomes "1023H GT ( 1013H + 10H )".**

**The operator returns 00H because the value of the 1st term is equal to the value of the 2nd term.**

**GE ( >= )**

Compares whether value of first term is greater than or equivalent to the value of the second term.

**[Function]**

Returns 0FFH (True) if the value of the 1st term of an expression is greater than or equal to the value of its 2nd term, and 00H (False) if the value of the 1st term is less than the value of the 2nd term.

A blank is required before and after the GE operator.

**[Application example]**

```
A1      EQU      2037H
A2      EQU      2015H

        MOV      A, #A1 GE  A2          ; (1)
        MOV      X, #A1 GE  ( A2 + 23H ) ; (2)
```

(1) In (1) above, the expression "A1 GE A2" becomes "2037H GE 2015H".

The operator returns 0FFH because the value of the 1st term is greater than the value of the 2nd term.

(2) In (2) above, the expression "A1 GE ( A2 + 23H )" becomes "2037H GE ( 2015H + 23H )".

The operator returns 00H because the value of the 1st term is less than the value of the 2nd term.

**LT (<)**

Compares whether value of first term is smaller than value of the second.

**[Function]**

Returns 0FFH (True) if the value of the 1st term of an expression is less than the value of its 2nd term, and 00H (False) if the value of the 1st term is equal to or greater than the value of the 2nd term.

A blank is required before and after the LT operator

**[Application example]**

```

A1      EQU      1000H
A2      EQU      1020H

        MOV      A, #A1 LT A2          ; (1)
        MOV      X, # ( A1 + 20H ) LT A2 ; (2)

```

**(1) In (1) above, the expression "A1 LT A2" becomes "1000H LT 1020H".**

The operator returns 0FFH because the value of the 1st term is less than the value of the 2nd term.

**(2) In (2) above, the expression "( A1 + 20H ) LT A2" becomes "( 1000H + 20H ) LT 1020H".**

The operator returns 00H because the value of the 1st term is equal to the value of the 2nd term.

**LE ( <= )**

Compares whether value of first term is smaller than or equivalent to the value of the second term.

**[Function]**

Returns 0FFH (True) if the value of the 1st term of an expression is less than or equal to the value of its 2nd term, and 00H (False) if the value of the 1st term is greater than the value of the 2nd term.

A blank is required before and after the LE operator.

**[Application example]**

A1	EQU	103AH		
A2	EQU	1040H		
	MOV	A, #A1 LE A2		; (1)
	MOV	X, # ( A1 + 7H ) LE A2		; (2)

**(1) In (1) above, the expression "A1 LE A2" becomes "103AH LE 1040H".**

The operator returns 0FFH because the value of the 1st term is less than the value of the 2nd term.

**(2) In (2) above, the expression "( A1 + 7H ) LE A2" becomes "( 103AH + 7H ) LE 1040H".**

The operator returns 00H because the value of the 1st term is greater than the value of the 2nd term.

#### 4.1.7 Shift operators

The following shift operators are available.

Operator	Overview
SHR	Obtains only the right-shifted value of the first term which appears in the second term.
SHL	Obtains only the left-shifted value of the first term which appears in the second term.

**SHR**

Obtains only the right-shifted value of the first term which appears in the second term.

**[Function]**

Returns a value obtained by shifting the value of the 1st term of an expression to the right the number of bits specified by the value of the 2nd term. Zeros equivalent to the specified number of bits shifted move into the high-order bits.

A blank is required before and after the SHR operator.

If the number of shifted bits is 0, the value of the first term is returned as is. If the number of shifted bits exceeds 16, the space is automatically filled with zeros.

**[Application example]**

```
MOV    A, #01AFH SHR 5      ; (1)
```

(1) This operator shifts the value "01AFH" to the right by 5 bits.

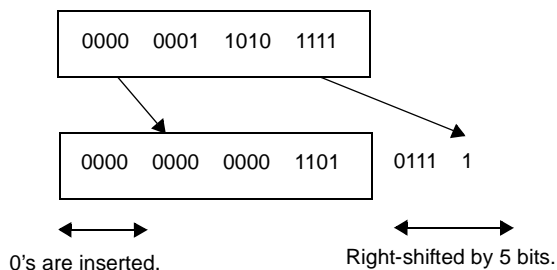

The value "000DH" is returned.

Therefore, (1) in the above example can also be described as: MOV A , #0DH

**SHL**

Obtains only the left-shifted value of the first term which appears in the second term.

**[Function]**

Returns a value obtained by shifting the value of the 1st term of an expression to the left the number of bits specified by the value of the 2nd term. Zeros equivalent to the specified number of bits shifted move into the low-order bits.

A blank is required before and after the SHL operator.

If the number of shifted bits is 0, the value of the first term is returned as is. If the number of shifted bits exceeds 16, the space is automatically filled with zeros.

**[Application example]**

```
MOV    A, #21H SHL 2      ; (1)
```

(1) This operator shifts the value "21H" to the left by 2 bits.

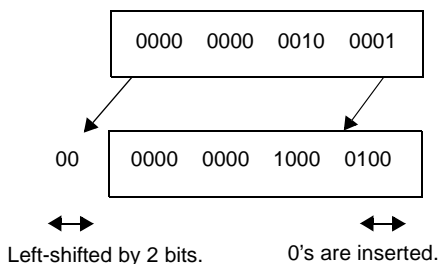

The value "84H" is returned.

Therefore, (1) in the above example can also be described as: MOV A , #84H



**4.1.8 Byte separation operators**

The following byte separation operators are available.

Operator	Overview
HIGH	Returns the high-order 8-bit value of a term.
LOW	Returns the low-order 8-bit value of a term.

**HIGH**

Returns the high-order 8-bit value of a term.

**[Function]**

Returns the high-order 8-bit value of a term.  
 A blank is required between the HIGH operator and the term.

**[Application example]**

```
MOV    A, #HIGH 1234H    ; (1)
```

(1) By executing a MOV instruction, this operator returns the high-order 8-bit value "12H" of the expression "1234H".  
 Therefore, (1) in the above example can also be described as: MOV A , #12H

**[Remark]**

A HIGH operation for an SFR/EFR name is performed, using either of the following description methods.

```
HIGHΔSFR-name  
HIGHΔEFR-name
```

Or,

```
HIGH [Δ] ( [Δ] SFR-name [Δ] )  
HIGH [Δ] ( [Δ] EFR-name [Δ] )
```

The result obtained from the operation is an operand of the absolute NUMBER attribute.  
 No other operations can be performed for the SFR/EFR name at the same time.

<Example>

<u>Symbol field</u>	<u>Mnemonic field</u>	<u>Operand field</u>
	MOV	R0, #HIGH PM0
	MOV	R1, #HIGH PM1 + 1H ; Equivalent to ( HIGH PM1 ) + 1
	MOV	R1, #HIGH ( PM1 + 1H ) ; An error is returned because
		; operands other than HIGH
		; are specified as the SFR name
		; at the same time

**LOW**

Returns the low-order 8-bit value of a term.

**[Function]**

Returns the low-order 8-bit value of a term.

A blank is required between the LOW operator and the term.

**[Application example]**

```
MOV    A, #LOW 1234H    ; (1)
```

(1) By executing a MOV instruction, this operator returns the low-order 8-bit value "34H" of the expression "1234H".

Therefore, (1) in the above example can also be described as: MOV A , #34H

**[Remark]**

A LOW operation for an SFR/EFR name is performed, using either of the following description methods.

```
LOW△SFR-name
LOW△EFR-name
```

Or,

```
LOW [Δ] ( [Δ] SFR-name [Δ] )
LOW [Δ] ( [Δ] EFR-name [Δ] )
```

The result obtained from the operation is an operand of the absolute NUMBER attribute.

No other operations can be performed for the SFR/EFR name at the same time.

<Example>

<u>Symbol field</u>	<u>Mnemonic field</u>	<u>Operand field</u>
	MOV	R0, #LOW PM0
	MOV	R1, #LOW PM1 + 1H ; Equivalent to #( LOW PM1 ) + 1
	MOV	R1, #LOW ( PM1 + 1H ) ; An error is returned because
		; operands other than LOW
		; are specified as the SFR name
		; at the same time

#### 4.1.9 Special operators

The following special operators are available.

Operator	Overview
<a href="#">DATAPOS</a>	Obtains the address part of a bit symbol.
<a href="#">BITPOS</a>	Obtains the bit part of a bit symbol.
<a href="#">MASK</a>	Obtains a 16-bit value in which the specified bit positions are 1 and all others are 0.
<a href="#">BANKNUM</a>	Obtains the number of the bank where the segment in which the symbol is defined is located.

**DATAPOS**

Obtains the address part of a bit symbol.

**[Function]**

Returns the address portion (byte address) of a bit symbol.

**[Application example]**

```

SYM      EQU      0FE68H.6                ; (1)

        MOV      A, !DATAPOS SYM          ; (2)
    
```

(1) An EQU directive defines the name "SYM" with a value of 0FE68H.6.

(2) "DATAPOS SYM" represents "DATAPOS 0FE68H.6", and "0FE68H" is returned.  
 Therefore, (2) in the above example can also be described as: MOV A , !0FE68H

**[Remark]**

A DATAPOS operation for an SFR/EFR name is performed, using the following description methods.

```

DATAPOSΔSFR-name
DATAPOSΔEFR-name
    
```

The result obtained from the operation is an operand of the absolute NUMBER attribute.

No other operations can be performed for the SFR/EFR name at the same time.

<Example>

<u>Symbol field</u>	<u>Mnemonic field</u>	<u>Operand field</u>
	MOVW	HL, #DATAPOS PIF0
	MOVW	HL, #DATAPOS PIF0 + 1H

**BITPOS**

Obtains the bit part of a bit symbol.

**[Function]**

Returns the bit portion (bit position) of a bit symbol.

**[Application example]**

```

SYM      EQU      0FE68H.6                ; (1)

CLR1     [HL].BITPOS SYM                  ; (2)
    
```

(1) An EQU directive defines the name "SYM" with a value of 0FE68H.6.

(2) "BITPOS.SYM" represents "BITPOS 0FE68H.6", and "6" is returned.  
 A CLR1 instruction clears [HL].6 to 0.

**[Remark]**

A BITPOS operation for an SFR/EFR name is performed, using the following description methods.

```

BITPOSΔSFR-name
BITPOSΔEFR-name
    
```

The result obtained from the operation is an operand of the absolute NUMBER attribute.

No other operations can be performed for the SFR/EFR name at the same time.

<Example>

<u>Symbol field</u>	<u>Mnemonic field</u>	<u>Operand field</u>
	MOV1	[HL].BITPOS PIF0, CY
	MOVW	[HL].BITPOS PIF0 + 1H, CY

**MASK**

Obtains a 16-bit value in which the specified bit positions are 1 and all others are 0.

**[Function]**

Returns a 16-bit value in which the specified bit position is 1 and all others are set to 0.

**[Application example]**

```
MOVW    AX, #MASK ( 0, 3, 0FE00H.7, 15 ) ; (1)
```

(1) A MOVW instruction returns the value "8089H".

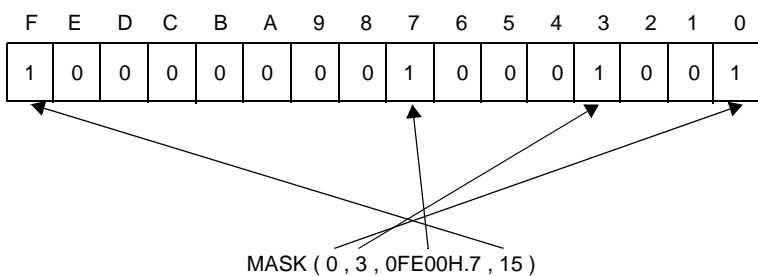

**BANKNUM**

Obtains the number of the bank where the segment in which the symbol is defined is located.

**[Function]**

Returns the number of the bank where the segment in which the symbol is defined is located.

A blank is required between the BANKNUM operator and the symbol.

**[Example]**

```
CSEG    BANK1
SYM :   NOP
      :
      MOV    A, #BANKNUM    SYM    ;    (1)
```

(1) "1" , which is the number of the bank where the segment in which the label "SYM" is defined is located , is returned by the BANKNUM operator.

Therefore , (c) in the above example can also be described as : MOV A , #1.

**Note** , however , that "0" is returned if the memory area where the segment in which the label "SYM" is defined is located is other than a bank.



**4.1.10 Other operator**

The following operators are also available.

Operator	Overview
( )	Prioritizes the calculation within ( )

( )

Prioritizes the calculation within ( )

**[Function]**

Causes an operation in parentheses to be performed prior to operations outside the parentheses.  
 This operator is used to change the order of precedence of other operators.  
 If parentheses are nested at multiple levels, the expression in the innermost parentheses will be calculated first.

**[Application example]**

MOV     A, # ( 4 + 3 ) \* 2

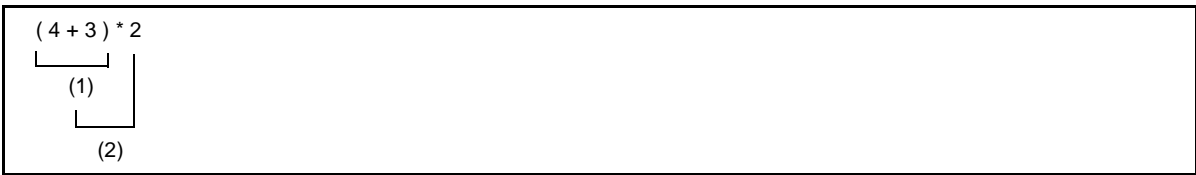

Calculations are performed in the order of expressions (1), (2) and the value "14" is returned as a result.  
 If parentheses are not used,



Calculations are performed in the order (1), (2) shown above, and the value "10" is returned as a result.  
 See [Table 4-5. Operator Precedence Levels](#), for the order of precedence of operators.

4.1.11 Restrictions on operations

The operation of an expression is performed by connecting terms with operator(s). Elements that can be described as terms are constants, \$, names and labels. Each term has a relocation attribute and a symbol attribute.

Depending on the types of relocation attribute and symbol attribute inherent in each term, operators that can work on the term are limited. Therefore, when describing an expression it is important to pay attention to the relocation attribute and symbol attribute of each term constituting the expression.

(1) Operators and relocation attributes

Each term constituting an expression has a relocation attribute and a symbol attribute.

If terms are categorized by relocation attribute, they can be divided into 3 types: absolute terms, relocatable terms and external reference terms.

The following table shows the types of relocation attributes and their properties, and also the corresponding terms.

Table 4-6. Relocation Attribute Types

Type	Property	Corresponding Elements
Absolute term	Term that is a value or constant determined at assembly time	<ul style="list-style-type: none"> <li>- Constants</li> <li>- Labels in absolute segments</li> <li>- \$, indicating a location address defined in an absolute segment</li> <li>- Names defined with absolute values such as constants or the labels and \$ listed above.</li> </ul>
Relocatable term	Term with a value that is not determined at assembly time	<ul style="list-style-type: none"> <li>- Labels defined in relocatable segments</li> <li>- \$, indicating a relocatable address defined in a relocatable segment</li> <li>- Names defined with relocatable symbols</li> </ul>
External reference term <sup>Note</sup>	Term for external reference of symbol in other module	<ul style="list-style-type: none"> <li>- Labels defined with EXTRN directive</li> <li>- Names defined with EXTBIT directive</li> </ul>

**Note** There are 5 operators which can take an external reference term as the target of an operation; these are "+", "-", "HIGH", "LOW", "BANKNUM". However, only one external reference term is allowed in one expression, and it must be connected with the "+" operator.

The following tables categorize combinations of operators and terms which can be used in expressions by relocation attribute.

Table 4-7. Combinations of Operators and Terms by Relocation Attribute (Relocatable Terms)

Operator Type	Relocation Attribute of Term			
	X:ABS Y:ABS	X:ABS Y:REL	X:REL Y:ABS	X:REL Y:REL
X + Y	A	R	R	-
X - Y	A	-	R	A <sup>Note 1</sup>
X * Y	A	-	-	-
X / Y	A	-	-	-
X MOD Y	A	-	-	-
X SHL Y	A	-	-	-

Operator Type	Relocation Attribute of Term			
	X:ABS Y:ABS	X:ABS Y:REL	X:REL Y:ABS	X:REL Y:REL
X SHR Y	A	-	-	-
X EQ Y	A	-	-	A <sup>Note 1</sup>
X LT Y	A	-	-	A <sup>Note 1</sup>
X LE Y	A	-	-	A <sup>Note 1</sup>
X GT Y	A	-	-	A <sup>Note 1</sup>
X GE Y	A	-	-	A <sup>Note 1</sup>
X NE Y	A	-	-	A <sup>Note 1</sup>
X AND Y	A	-	-	-
X OR Y	A	-	-	-
X XOR Y	A	-	-	-
NOT X	A	A	-	-
+ X	A	A	R	R
- X	A	A	-	-
HIGH X	A	A	R <sup>Note 2</sup>	R <sup>Note 2</sup>
LOW X	A	A	R <sup>Note 2</sup>	R <sup>Note 2</sup>
BANKNUM X	A	A	A <sup>Note 2</sup>	A <sup>Note 2</sup>
MASK ( X )	A	A	-	-
DATAPOS X.Y	A	-	-	-
BITPOS X.Y	A	-	-	-
MASK ( X.Y )	A	-	-	-
DATAPOS X	A	A	R	R
BITPOS X	A	A	A	A

- ABS : Absolute term  
REL : Relocatable term  
A : Result is absolute term  
R : Result is relocatable term  
- : Operation not possible

- Notes 1.** Operation is possible only when X and Y are defined in the same segment, and when X and Y are not relocatable terms operated on by HIGH, LOW, **BANKNUM**, or DATAPOS.  
**2.** Operation is possible when X and Y are not relocatable terms operated on by HIGH, LOW, **BANKNUM**, or DATAPOS.

There are 5 operators which can take an external reference term as the target of an operation; these are "+", "-", "HIGH", "LOW", "BANKNUM". However, only one external reference term is allowed in one expression, and it must be connected with the "+" operator.

The possible combinations of operators and terms are as follows, categorized by relocation attribute.

Table 4-8. Combinations of Operators and Terms by Relocation Attribute (External Reference Terms)

Operator Type	Relocation Attribute of Term				
	X:ABS Y:EXT	X:EXT Y:ABS	X:REL Y:EXT	X:EXT Y:REL	X:EXT Y:EXT
X + Y	E	E	-	-	-
X - Y	-	E	-	-	-
+ X	A	E	R	E	E
HIGH X	A	E <sup>Note 1</sup>	R <sup>Note 2</sup>	E <sup>Note 1</sup>	E <sup>Note 1</sup>
LOW X	A	E <sup>Note 1</sup>	R <sup>Note 2</sup>	E <sup>Note 1</sup>	E <sup>Note 1</sup>
BANKNUM X	A	E <sup>Note 1</sup>	A <sup>Note 2</sup>	E <sup>Note 1</sup>	E <sup>Note 1</sup>
MASK ( X )	A	-	-	-	-
DATAPOS X.Y	-	-	-	-	-
BITPOS X.Y	-	-	-	-	-
MASK ( X.Y )	-	-	-	-	-
DATAPOS X	A	E	R	E	E
BITPOS X	A	E	A	E	E

- ABS : Absolute term
- EXT : External reference term
- REL : Relocatable term
- A : Result is absolute term
- E : Result is external reference term
- R : Result is relocatable term
- : Operation not possible

- Notes 1.** Operation is possible only when X and Y are not external reference terms operated on by HIGH, LOW, BANKNUM, DATAPOS, or BITPOS.
- 2.** Operation is possible only when X and Y are not relocatable terms operated on by HIGH, LOW, BANKNUM, or DATAPOS.

**(2) Operators and symbol attributes**

Each of the terms constituting an expression has a symbol attribute in addition to a relocation attribute. If terms are categorized by symbol attribute, they can be divided into two types: NUMBER terms and ADDRESS terms.

The following table shows the types of symbol attributes used in expressions and the corresponding terms.

Table 4-9. Symbol Attribute Types in Operations

Symbol Attribute Type	Corresponding Terms
NUMBER term	- Symbol with NUMBER attribute - Constant
ADDRESS term	- Symbol with ADDRESS attribute - "\$", indicating the location counter

The possible combinations of operators and terms are as follows, categorized by symbol attribute.

Table 4-10. Combinations of Operators and Terms by Symbol Attribute

Operator Type	Symbol Attribute of Term			
	X:ADDRESS Y:ADDRESS	X:ADDRESS Y:NUMBER	X:NUMBER Y:ADDRESS	X:NUMBER Y:NUMBER
X + Y	-	A	A	N
X - Y	N	A	-	N
X * Y	-	-	-	N
X / Y	-	-	-	N
X MOD Y	-	-	-	N
X SHL Y	-	-	-	N
X SHR Y	-	-	-	N
X EQ Y	N	-	-	N
X LT Y	N	-	-	N
X LE Y	N	-	-	N
X GT Y	N	-	-	N
X GE Y	N	-	-	N
X NE Y	N	-	-	N
X AND Y	-	-	-	N
X OR Y	-	-	-	N
X XOR Y	-	-	-	N
NOT X	-	-	N	N
+ X	A	A	N	N
- X	-	-	N	N
HIGH X	A	A	N	N
LOW X	A	A	N	N
BANKNUM X	A	A	-	-
DATAPOS X	A	A	N	N
MASK X	N	N	N	N

- ADDRESS : ADDRESS term
- NUMBER : NUMBER term
- A : Result is ADDRESS term
- N : Result is NUMBER term
- : Operation not possible

**(3) How to check operation restrictions**

The following is an example of how to interpret the operation of relocation attributes and symbol attributes.

```
BR    $TABLE + 5H
```

Here, "TABLE" is presumed to be a defined label in a relocatable code segment.

**(a) Operation and relocation attributes**

"TABLE + 5H" is a relocatable term + an absolute term, so the rules of "Table 4-7. Combinations of Operators and Terms by Relocation Attribute (Relocatable Terms)" apply.

Operator type ... X + Y  
 Relocation attribute of term ... X:REL, Y:ABS

Therefore, it can be understood that the result is "R", or more specifically a relocatable term.

**(b) [Operation and symbol attributes]**

"TABLE + 5H" is an ADDRESS term + a NUMBER term, so the rules of "Table 4-10. Combinations of Operators and Terms by Symbol Attribute" apply.

Operator type ... X + Y  
 Relocation attribute of term ... X:ADDRESS, Y:NUMBER

Therefore, it can be understood that the result is "A", or more specifically an ADDRESS term.

**4.1.12 Absolute expression definitions**

Absolute expressions are expressions with values determined by evaluation at assembly time.

The following belong to the category of absolute expressions:

- Constants
- Expressions that are composed only of constants (constant expressions)
- Constants, EQU symbols defined from constant expressions, and SET symbols
- Expressions that operate on the above

**Remark** Only backward referencing of symbols is possible.

**4.1.13 Bit position specifier**

Bit access becomes possible via use of the ( . ) bit position specifier.

**(1) Description Format**



X (First Term)		Y (Second Term)
General register	A	Expression (0 - 7)
Control register	PSW	Expression (0 - 7)
Special function register	sfr <sup>Note</sup>	Expression (0 - 7)
Memory	[HL] <sup>Note</sup>	Expression (0 - 7)

**Note** For details on the specific description, see the user's manual of each device.

**(2) Function**

- The first term specifies a byte address, and the second term specifies a bit position. This makes it possible to access a specific bit.

**(3) Explanation**

- An expression that uses a bit position specifier is called a bit term.

- The bit position specifier is not affected by the precedence order of operators. The left side is recognized as term 1 and the right side is recognized as term 2.
- The following restrictions apply to the first term:
  - A NUMBER or ADDRESS attribute expression, an SFR name supporting 8-bit access, or a register name (A) can be specified.
  - If the first term is an absolute expression, the area must be 0FE20H to 0FF1FH.
  - External reference symbols can be specified.
- The following restrictions apply to the second term:
  - The value of the expression must be in the range from 0 to 7. When this range is exceeded, an error occurs.
  - It is possible to specify only absolute NUMBER attribute expressions.
  - External reference symbols cannot be specified.

#### (4) Operations and relocation attributes

- The following table shows combinations of terms 1 and 2 by relocation attribute.

Terms combination X:	ABS	ABS	REL	REL	ABS	EXT	REL	EXT	EXT
Terms combination Y:	ABS	REL	ABS	REL	EXT	ABS	EXT	REL	EXT
X.Y	A	-	R	-	-	E	-	-	-

- ABS : Absolute term  
 REL : Relocatable term  
 EXT : External reference term  
 A : Result is absolute term  
 E : Result is external reference term  
 R : Result is relocatable term  
 - : Operation not possible

#### (5) Bit symbol values

- When a bit symbol is defined by using the bit position specifier in the operand field of an EQU directive, the value of the bit symbol is as follows:

Operand Type	Symbol Value
A.bit <sup>Note 2</sup>	1.bit
PSW.bit <sup>Note 2</sup>	1FEH.bit
sfr <sup>Note 1</sup> .bit <sup>Note 2</sup>	0FFXXH.bit <sup>Note 3</sup>
expression.bit <sup>Note 2</sup>	XXXXH.bit <sup>Note 4</sup>

- Notes**
1. For a detailed description, see the user's manual of each device.
  2. bit = 0 - 7
  3. 0FFXXH is an sfr address
  4. XXXXH is an expression value



**(6) Example**

```

SET1    0FE20H.3
SET1    A.5
CLR1    P1.2
SET1    1 + 0FE30H.3    ; Equals 0FE31H.3
SET1    0FE40H.4 + 2    ; Equals 0FE40H.6

```

**4.1.14 Identifiers**

An identifier is a name used for symbols, labels, macros etc.

Identifiers are described according to the following basic rules.

- Identifiers consist of alphanumeric characters and symbols that are used as characters (? , @ , \_)
- However, the first character cannot be a number (0 to 9).
- Reserved words cannot be used as identifiers.
- With regard to reserved words, see "4.5 Reserved Words".
- The assembler distinguishes between uppercase and lowercase.

**4.1.15 Operand characteristics**

Instructions and directives requiring one or more operands differ in the size and address range of the required operand values and in the symbol attributes of the operands.

For example, the function of the instruction "MOV r , #byte" is to transfer the value indicated by "byte" to register "r". Because the register is an 8-bit register, the data size of "byte" must be 8 bits or less.

An assembly error will occur at the statement "MOV R0 , #100H", because the value of the second operand (100H) cannot be expressed with 8 bits.

Therefore, it is necessary to bear the following points in mind when describing operands.

- Whether the size and address range are suitable for an operand of that instruction (numeric value, name, label)
- Whether the symbol attribute is suitable for suitable for an operand of that instruction (name, label)

**(1) Operand value sizes and address ranges**

There are conditions that limit the size and address ranges of numeric values, names and labels used as instruction operands.

For instructions, the size and address range of operands are limited by the operand representation. For directives, they are limited by the directive type.

These limiting conditions are as follows.

**Table 4-11. Instruction Operand Value Ranges**

Operand Representation	Value Range	
byte	8-bit value : 0H to 0FFH	
word	16-bit valu : 0H to 0FFFFH	
saddr	0FE20H - 0FF1FH	
saddrp	0FE20H - 0FF1FHeven numbe	
sfr	0FF00H - 0FFCFH, 0FFE0H - 0FFFFH	
sfrp	Even values of 0FF00H to 0FFCFH, 0FFE0H to 0FFFFH	
addr16	MOV, MOVW	0H - 0FFFFH <sup>Note</sup>
	Other instructions	0H - 0FA7FH

Operand Representation	Value Range
addr11	800H - 0FFFH
addr5	Even values of 40H to 7EH
bit	3-bit value : 0 to 7
n	2-bit value : 0 to 3

**Note** To describe sfr or efr as an operand, it can be specified as !sfr and !efr. These are output as the operands for !addr16 in the code.

It is possible to describe sfr or efr without "!". The same !addr16 operand code will be output.

**Table 4-12. Value ranges of Directive Operands**

Directive Type	Directive	Value Range
Segment definition	CSEG AT	0H to 0FFFFH
	DSEG AT	0H to 0FFFFH
	BSEG AT	0FE20H to 0FEFFH
	ORG	0H to 0FFFFH
Symbol definition	EQU	16-bit value 0H to 0FFFFH
	SET	16-bit value 0H to 0FFFFH
Memory initialization and area reservation	DB	8-bit value 0H - 0FFH
	DW	16-bit value 0H - 0FFFFH
	DS	16-bit value 0H - 0FFFFH
Automatic branch instruction selection	BR	0H to 0FFFFH

## (2) Sizes of operands required by instructions

Instructions can be classified into machine instructions and directives. When they require immediate data or symbols, the size of the required operand differs according to the instruction or directive. An error occurs when source code specifies data that is larger than the required operand.

Expressions are operated as unsigned 16 bits. When evaluation results exceed 0FFFFH (16 bits), a warning message is issued.

However, when relocatable or external symbols are specified as operands, the value cannot be determined by the assembler. In these cases, the linker determines the value and performs range checks.

## (3) Symbol attributes and relocation attributes of operands

When names, labels, and \$ (which indicate location counters) are described as instruction operands, they may or may not be describable as operands. This depends on the symbol attributes and relocation attributes (see "[4.1.11 Restrictions on operations](#)").

When names and labels are described as instruction operands, they may or may not be describable as operands. This depends on the direction of reference.

Reference direction for names and labels can be backward reference or forward reference.

- Backward reference: A name or label referenced as an operand, which is defined in a line above (before) the name or label
- Forward reference: A name or label referenced as an operand, which is defined in a line below (after) the name or label

<Example>

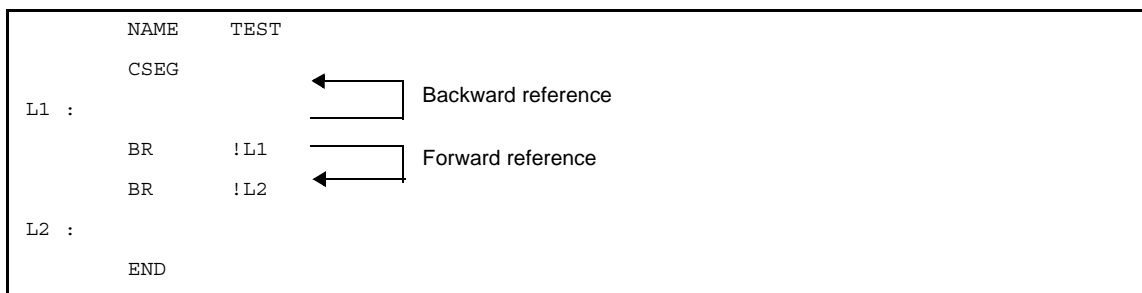

These symbol attributes and relocation attributes, as well as direction of reference for names and labels, are shown below.

**Table 4-13. Properties of Described Symbols as Operands**

	Symbol Attributes	NUMBER		ADDRESS				NUMBER ADDRESS		sfr Reserved Words <sup>Note 1</sup>	
	Relocation Attributes	Absolute Terms		Absolute Terms		Relocatable Terms		External Reference Terms		sfr	efr
	Reference Pattern	Backward	Forward	Backward	Forward	Backward	Forward	Backward	Forward		
Descriptor	byte	OK	OK	OK	OK	OK	OK	OK	OK	NG	NG
	word	OK	OK	OK	OK	OK	OK	OK	OK	NG	NG
	saddr	OK	OK	OK	OK	OK	OK	OK	OK	OK <sup>Note 2,3</sup>	NG
	saddrp	OK	OK	OK	OK	OK	OK	OK	OK	OK <sup>Note 2,4</sup>	NG
	sfr	OK <sup>Note 5</sup>	NG	NG	NG	NG	NG	NG	NG	OK <sup>Note 2,6</sup>	NG
	sfrp	NG	NG	NG	NG	NG	NG	NG	NG	OK <sup>Note 2,7</sup>	NG
	addr16 <sup>Note 8</sup>	OK	OK	OK	OK	OK	OK	OK	OK	OK <sup>Note 9</sup>	OK <sup>Note 9</sup>
Formant	addr11	OK	OK	OK	OK	OK	OK	OK	OK	NG	NG
	addr5	OK	OK	OK	OK	OK	OK	OK	OK	NG	NG
	bit	OK	OK	NG	NG	NG	NG	NG	NG	NG	NG
	n	OK	OK	NG	NG	NG	NG	NG	NG	NG	NG

- Forward : Forward reference
- Backward : Backward reference
- OK : Description possible
- NG : An error
- : Description impossible

**Notes 1.** The defined symbol specifying sfr or sfrp (sfr area where saddr and sfr are not overlapped) as an operand of EQU directive is only referenced backward. Forward reference is prohibited.

2. If an sfr reserved word in the saddr area has been described for an instruction in which a combination of sfr/sfrp changed from saddr/saddrp exists in the operand combination, a code is output as saddr/saddrp.
3. sfr reserved word in saddr area
4. sfrp reserved word in saddr area
5. Only absolute expressions
6. Only sfr reserved words that allow 8-bit accessing
7. Only sfr reserved words that allow 16-bit accessing
8. When the address of use prohibited area (FA80H to FADFH) as a value of addr16 is described, check is not performed.
9. !sfr and lefr can be specified only for operand !addr16 of instructions other than BR and CALL.

Table 4-14. Properties of Described Symbols as Operands of Directives

	Symbol Attributes	NUMBER		ADDRESS, SADDR						BIT						
	Relocation Attributes	Attributes Terms		Attributes Terms		Relocatable Terms		External Reference Terms		Attributes Terms		Relocatable Terms		External Reference Terms		
	Reference Pattern	Backward	Forward	Backward	Forward	Backward	Forward	Backward	Forward	Backward	Forward	Backward	Forward	Backward	Forward	
Directive	ORG	OK <sup>Note 1</sup>	-	-	-	-	-	-	-	-	-	-	-	-	-	
	EQU <sup>Note 2</sup>	OK	-	OK	-	OK <sup>Note 3</sup>	-	-	-	OK	-	OK <sup>Note 3</sup>	-	-	-	
	SET	OK <sup>Note 1</sup>	-	-	-	-	-	-	-	-	-	-	-	-	-	
	DB	Size	OK <sup>Note 1</sup>	-	-	-	-	-	-	-	-	-	-	-	-	-
		Initial value	OK	OK	OK	OK	OK	OK	OK	OK	-	-	-	-	-	-
	DW	Size	OK <sup>Note 1</sup>	-	-	-	-	-	-	-	-	-	-	-	-	-
		Initial value	OK	OK	OK	OK	OK	OK	OK	OK	-	-	-	-	-	-
	DS	OK <sup>Note 4</sup>	-	-	-	-	-	-	-	-	-	-	-	-	-	
BR	OK	-	-	-	-	-	-	-	-	-	-	-	-	-		

Forward : Forward reference  
 Backward : Backward reference  
 OK : Description possible  
 - : Description impossible

- Notes**
1. Only an absolute expression can be described.
  2. An error occurs if an expression including one of the following patterns is described.
    - ADDRESS attribute - ADDRESS attribute
    - ADDRESS attribute relational operator ADDRESS attribute
    - HIGH absolute ADDRESS attribute
    - LOW absolute ADDRESS attribute
    - BANKNUM absolute ADDRESS attribute
    - DATAPOS absolute ADDRESS attribute

- MASK absolute ADDRESS attribute
  - When the operation results can be affected by optimization from the above 7 patterns.
3. A term created by the HIGH/LOW/BANKNUM/DATAPOS/MASK operator that has a relocatable term is not allowed.
  4. See "[4.2.4 Memory initialization, area reservation directives](#)".

## 4.2 Directives

This chapter explains the directives.

Directives are instructions that direct all types of instructions necessary for the 78K0 assembler to perform a series of processes.

### 4.2.1 Overview

Instructions are translated into object codes (machine language) as a result of assembling, but directives are not converted into object codes in principle.

Directives contain the following functions mainly:

- To facilitate description of source programs
- To initialize memory and reserve memory areas
- To provide the information required for assemblers and linkers to perform their intended processing

The following table shows the types of directives.

**Table 4-15. List of Directives**

Type	Directives
Segment definition directives	CSEG, DSEG, BSEG, ORG
Symbol definition directives	EQU, SET
Memory initialization, area reservation directives	DB, DW, DS, DBIT
Linkage directives	EXTRN, EXTBIT, PUBLIC
Object module name declaration directive	NAME
Branch instruction automatic selection directives	BR
Macro directives	MACRO, LOCAL, REPT, IRP, EXITM, ENDM
Assemble termination directive	END

The following sections explain the details of each directive.

In the description format of each directive, "[ ]" indicates that the parameter in square brackets may be omitted from specification, and "..." indicates the repetition of description in the same format.

#### 4.2.2 Segment definition directives

The source module is described by dividing each segment unit.

The segment directive is what defines these "segments".

There are 4 types of these segments.

- Code segment
- Data segment
- Bit segment
- Absolute segment

The type of segment determines which area of the memory it is mapped to.

The following shows each segment definition method and the memory address that is mapped to.

**Table 4-16. Segment Definition Method and Memory Address Location**

Segment Type	Definition Method	Memory Address Location
Code segment	CSEG directive	In internal or external ROM address area
Data segment	DSEG directive	In internal or external RAM address area
Bit segment	BSEG directive	In internal RAM saddr area
Absolute segment	Specifies location address (AT location address) to relocation attribute with CSEG, DSEG, BSEG directive	Specified address

The absolute segment is defined for when the user wants to set the address mapped in the memory. For stack area, the user must set a stack pointer and secure an area in the data segment.

Also, segments cannot be located to the areas below.

When specifying security ID	Address range 85H to 8EH
When on-chip-debug function is used	Address range 02H to 03H (for on-chip debug) Address range from 84H to on-chip-debug program size +1.

Examples of segment mapping are shown below.

Figure 4-6. Segment Memory Mapping

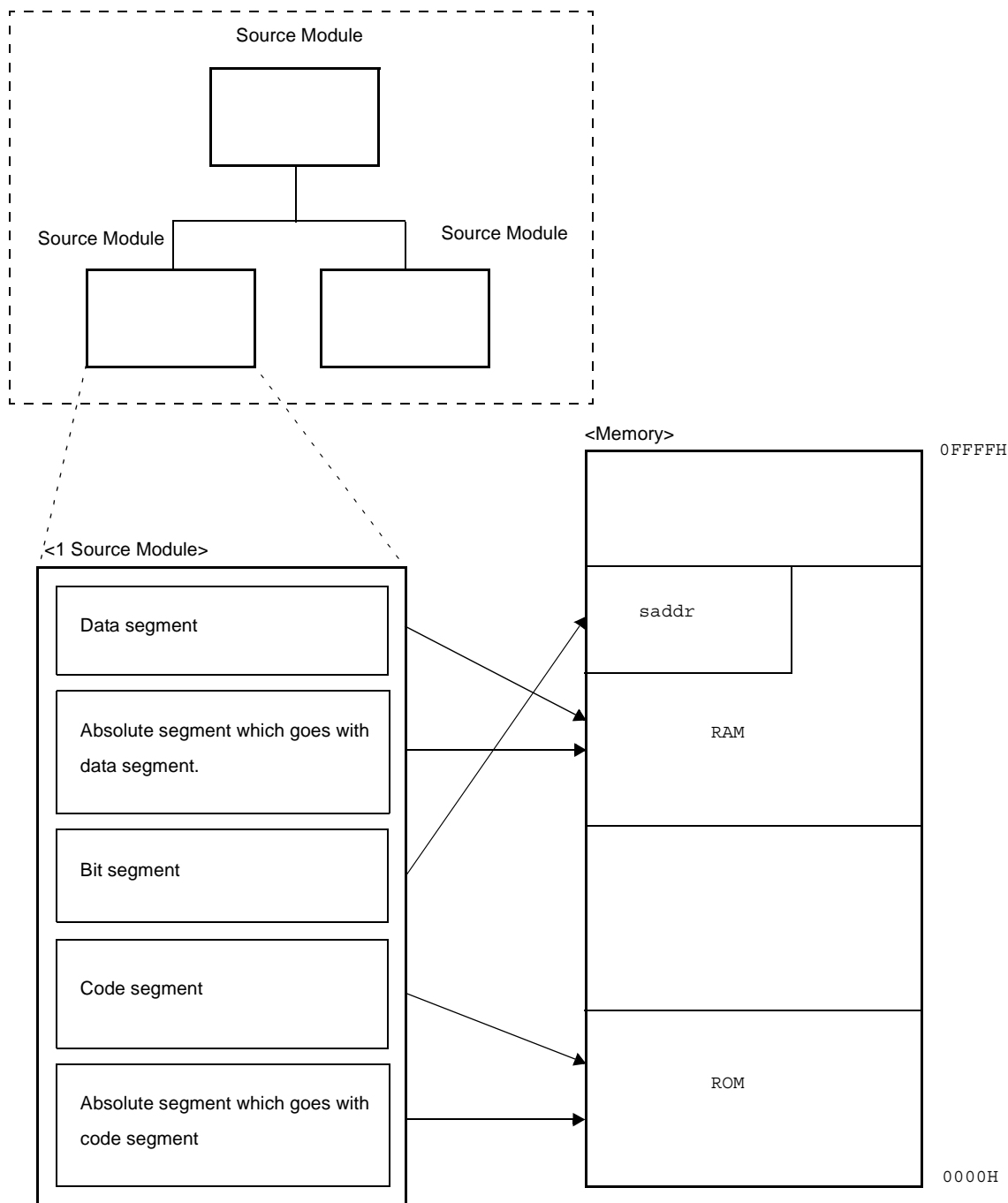

The following segment definition directives are available.

Control Instruction	Overview
CSEG	Indicate to the assembler the start of a code segment
DSEG	Indicate to the assembler the start of a data segment
BSEG	Indicate to the assembler the start of a bit segment
ORG	Set the value of the expression specified by its operand of the location counter.

**CSEG**

Indicate to the assembler the start of a code segment.

**[Description Format]**

Symbol field	Mnemonic field	Operand field	Comment field
[ <i>segment-name</i> ]	CSEG	[ <i>relocation-attribute</i> ]	[; <i>comment</i> ]

**[Function]**

- The CSEG directive indicates to the assembler the start of a code segment.
- All instructions described following the CSEG directive belong to the code segment until it comes across a segment definition directives (CSEG, DSEG, BSEG, or ORG) or the END directive, and finally those instructions are located within a ROM address after being converted into machine language.

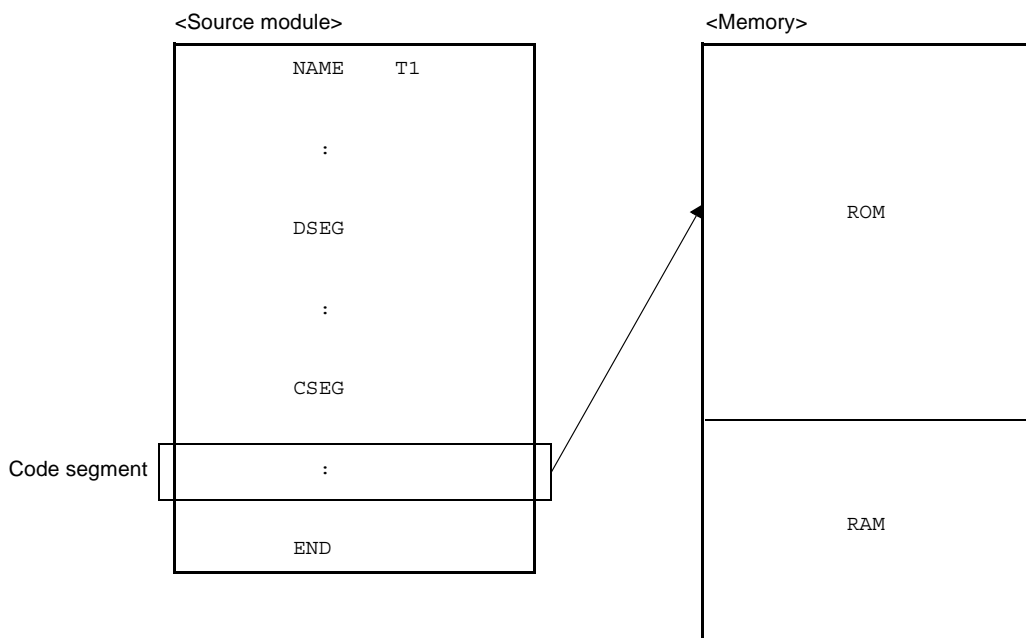

**[Use]**

- The CSEG directive is used to describe instructions, DB, DW directives, etc. in the code segment defined by the CSEG directive.  
However, to relocate the code segment from a fixed address, "AT *absolute-expression*" must be described as its relocation attribute in the operand field.
- Description of one functional unit such as a subroutine should be defined as a single code segment.  
If the unit is relatively large or if the subroutine is highly versatile (i.e. can be utilized for development of other programs), the subroutine should be defined as a single module.

**[Description]**

- The start address of a code segment can be specified with the ORG directive.  
It can also be specified by describing the relocation attribute "AT *absolute-expression*".
- A relocation attribute defines a range of location addresses for a code segment.



Table 4-17. Relocation Attributes of CSEG

Relocation Attribute	Description Format	Explanation
CALLT0	CALLT0	Tells the assembler to locate the specified segment so that the start address of the segment becomes a multiple of 2 within the address range 0040H to 007FH. Specify this relocation attribute for a code segment that defines the entry address of a subroutine to be called with the one-byte instruction "CALLT".
FIXED	FIXED	Tells the assembler to locate the beginning of the specified segment within the address range 0800H to 0FFFH Specify this relocation attribute for a code segment that defines a subroutine to be called with the 2-byte instruction "CALLF".
AT	AT <i>absolute-expression</i>	Tells the assembler to locate the specified segment to an absolute address(0000H to 0FFFFH) (excluding SFR and EFR).
UNIT	UNIT	Tells the assembler to locate the specified segment to any address. (0080H to 0FA7FH)
UNITP	UNITP	Tells the assembler to locate the specified segment to any address, so that the start of the address may be an even number. (0080H to 0FA7EH)
IXRAM	IXRAM	Tells the assembler to locate the specified segment to the internal expansion RAM.
SECUR_ID	SECUR_ID	It is a security ID specific attribute. Not specify except security ID. Tells the assembler to locate the specified segment within the address range 0085H to 008EH.
BANK0 to 15	BANK0 to 15	Tells the assembler to locate the specified segment within the address range x8000H to xBFFFH (x = 0 to F).
BANK0 AT to BANK15 AT	BANK0 AT <i>absolute-expression</i> to BANK15 AT <i>absolute-expression</i>	Tells the assembler to locate the specified segment within the absolute address range x8000H to xBFFFH (x8000H + the specified address) (x = 0 to F).
OPT_BYTE	OPT_BYTE	It is a user option byte specific attribute. Not specify except user option byte. Tells the assembler to locate the specified segment within the address range 0080H to 0084H.

- If no relocation attribute is specified for the code segment, the assembler will assume that "UNIT" has been specified.
- If a relocation attribute other than those listed in "Table 4-17. Relocation Attributes of CSEG" is specified, the assembler will output an error and assume that "UNIT" has been specified. An error occurs if the size of each code segment exceeds that of the area specified by its relocation attribute.
- If the absolute expression specified with the relocation attribute "AT" is illegal, the assembler will output an error message and continue processing by assuming the value of the expression to be "0".
- By describing a segment name in the symbol field of the CSEG directive, the code segment can be named. If no segment name is specified for a code segment, the assembler will automatically give a default segment name to the code segment.

The default segment names of the code segments are shown below.

Relocation Attribute	Default Segment Name
CALLT0	?CSEGT0
FIXED	?CSEGFIX
UNIT (or omitted)	?CSEG
UNITP	?CSEGUP
IXRAM	?CSEGIX
SECUR_ID	?CSEGLSI
BANK0 to 15	?CSEGB0 to ?CSEGB15
OPT_BYTE	?CSEGOB0
AT	Segment name cannot be omitted.

- When the size of the following segment is 0 among the default segments that C compiler outputs, the relocation attribute is changed by the linker.

Section Name	Relocation Attribute	Relocation Attribute When Being Size 0
@@CALT	CSEG CALLT0	CSEG UNIT
@@CALF	CSEG FIXD	CSEG UNIT

- An error occurs if the segment name is omitted when the relocation attribute is AT.
- If two or more code segments have the same relocation attribute (except AT), these code segments may have the same segment name.  
These same-named code segments are processed as a single code segment within the assembler.  
An error occurs if the same-named segments differ in their relocation attributes. Therefore, the number of the same-named segments for each relocation attribute is one.
- Description of a code segment can be divided into units. The same relocation attribute and the samename code segment described in one module are handled by the assembler as a series of segments.

- Cautions 1. Description of a code segment whose relocation attribute is AT cannot be divided into units.**
- 2. Insert a 1-byte interval, as necessary, so that the address specified by relocation attribute CALLT0 may be an even number.**

- The same-named data segments in two or more different modules can be specified only when their relocation attributes are UNIT, CALLT0, FIXED, UNITP, or SECUR\_ID, and are combined into a single data segment at linkage.
- No segment name can be referenced as a symbol.
- The total number of segments that can be output by the assembler is up to 255 alias names, including those defined with the ORG directive. The same-named segments are counted as one.
- The maximum number of characters recognizable as a segment name is 8.
- The uppercase and lowercase characters of a segment name are distinguished.
- Specify user option byte by using OPT\_BYTE.

When the user option byte is not specified for the chip having the user option byte feature, define a default segment of "?CSEGOB0" and set the initial value by reading from a device file.

**[Example]**

```
NAME      SAMP1
C1        CSEG                ; (1)
C2        CSEG      CALLT0    ; (2)
          CSEG      FIXED     ; (3)
C1        CSEG      CALLT0    ; (4)  <- Error
          CSEG                ; (5)
END
```

- (1) The assembler interprets the segment name as "C1", and the relocation attribute as "UNIT".
- (2) The assembler interprets the segment name as "C2", and the relocation attribute as "CALLT0".
- (3) The assembler interprets the segment name as "?CSEGFx", and the relocation attribute as "FIXED".
- (4) An error occurs because the segment name "C1" was defined as the relocation attribute "UNIT" in (1).
- (5) The assembler interprets the segment name as "?CSEG", and the relocation attribute as "UNIT".

**DSEG**

Indicate to the assembler the start of a data segment.

**[Description Format]**

Symbol field	Mnemonic field	Operand field	Comment field
[ <i>segment-name</i> ]	DSEG	[ <i>relocation-attribute</i> ]	[; <i>comment</i> ]

**[Function]**

- The DSEG directive indicates to the assembler the start of a data segment.
- A memory defined by the DS directive following the DSEG directive belongs to the data segment until it comes across a segment definition directives (CSEG, DSEG, BSEG, or ORG) or the END directive, and finally it is reserved within the RAM address.

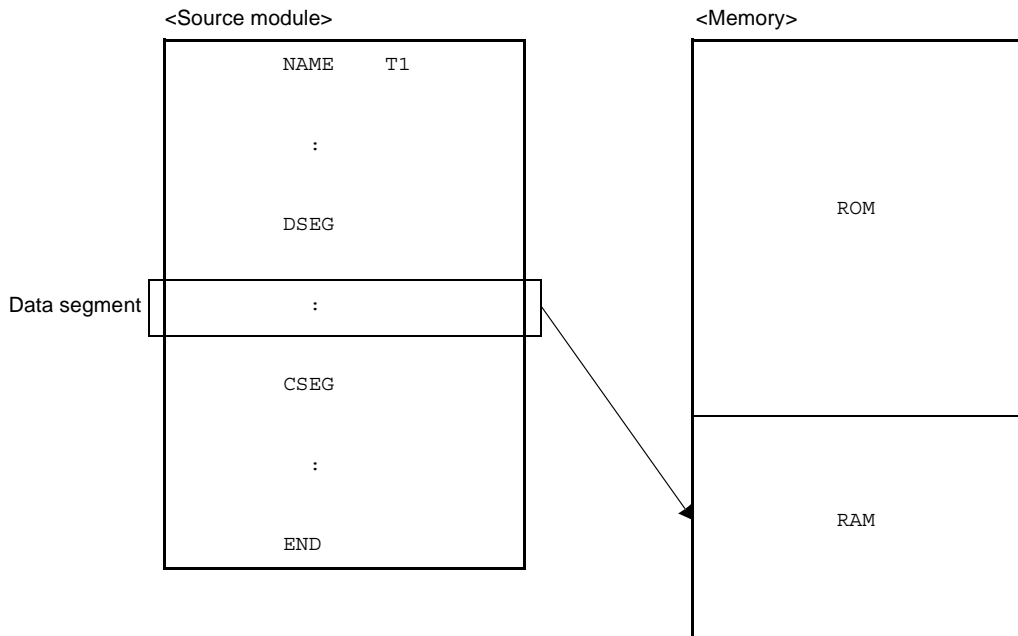

**[Use]**

- The DS directive is mainly described in the data segment defined by the DSEG directive. Data segments are located within the RAM area. Therefore, no instructions can be described in any data segment.
- In a data segment, a RAM work area used in a program is reserved by the DS directive and a label is attached to each work area. Use this label when describing a source program. Each area reserved as a data segment is located by the linker so that it does not overlap with any other work areas on the RAM (stack area, and work areas defined by other modules). The linker outputs a warning message if the data segment overlaps a general-purpose register area. The output level of the warning message can be changed using the warning message specification option (-w).

Value Specified by -w	Check Target
0	No areas

Value Specified by -w	Check Target
1	RB0
2	RB0 to RB3

**[Description]**

- The start address of a data segment can be specified with the ORG directive.  
It can also be specified by describing the relocation attribute "AT" followed by an absolute expression in the operand field of the DSEG directive.
- A relocation attribute defines a range of location addresses for a data segment.  
The relocation attributes available for data segments are shown below.

**Table 4-18. Relocation Attributes of DSEG**

Relocation Attribute	Description Format	Explanation
SADDR	SADDR	Tells the assembler to locate the specified segment in the saddr area (saddr area: 0FE20H to 0FEFFH).
SADDRP	SADDRP	Tells the assembler to locate the specified segment from an even-numbered address of the saddr area (saddr area: 0FE20H to 0FEFFH).
AT	AT <i>absolute-expression</i>	Tells the assembler to locate the specified segment in an absolute address (excluding SFR and EFR).
UNIT	UNIT or no specification	Tells the assembler to locate the specified segment in any location (within the memory area name "RAM" ).
UNITP	UNITP	Tells the assembler to locate the specified segment in any location from an even-numbered address (within the memory area name "RAM" ).
IHRAM	IHRAM	Tells the assembler to locate the specified segment in the high-speed RAM area.
LRAM	LRAM	Tells the assembler to locate the specified segment in the low-speed RAM area.
DSPRAM	DSPRAM	Tells the assembler to locate the specified segment in the display RAM area.
IXRAM	IXRAM	Tells the assembler to locate the specified segment in the internal expansion RAM area.

**Note** The address represented by xxxx varies depending on the device used.

- If no relocation attribute is specified for the data segment, the assembler will assume that "UNIT" has been specified.
- If a relocation attribute other than those listed in "[Table 4-18. Relocation Attributes of DSEG](#)" is specified, the assembler will output an error and assume that "UNIT" has been specified. An error occurs if the size of each data segment exceeds that of the area specified by its relocation attribute.
- If the absolute expression specified with the relocation attribute "AT" is illegal, the assembler will output an error and continue processing by assuming the value of the expression to be "0".
- Machine language instructions (including BR directive) cannot be described in a data segment. If described, an error is output and the line is ignored.

- By describing a segment name in the symbol field of the DSEG directive, the data segment can be named. If no segment name is specified for a data segment, the assembler automatically gives a default segment name. The default segment names of the data segments are shown below.

Relocation Attribute	Default Segment Name
SADDR	?DSEGS
SADDRP	?DSEGSP
UNIT(or no specification)	?DSEG
UNITP	?DSEGUP
IHRAM	?DSEGIH
LRAM	?DSEGL
DSPRAM	?DSEGDSP
IXRAM	?DSEGIX
AT	Segment name cannot be omitted.

- When the size of the following segment is 0 among the default segments that C compiler outputs, the relocation attribute is changed by the linker.

Section Name	Relocation Attribute	Relocation Attribute When Being Size 0
@@INIS	DSEG SADDRP	DSEG UNITP
@@DATS	DSEG SADDRP	DSEG UNITP
@EINIS	DSEG SADDRP	DSEG UNITP
@EDATS	DSEG SADDRP	DSEG UNITP

- If two or more data segments have the same relocation attribute (except AT), these data segments may have the same segment name. These segments are processed as a single data segment within the assembler.
- Description of a data segment can be divided into units. The same relocation attribute and the same-named code segment described in one module are handled by the assembler as a series of segments.

- Cautions 1. Description of a code segment whose relocation attribute is AT cannot be divided into units.**
- 2. When the relocation attribute is SADDR, insert a 1-byte interval, as necessary, so that the address immediately after a DESG directive is described may be an even number.**

- If the relocation attribute is SADDRP, the specified segment is located so that the address immediately after the DSEG directive is described becomes a multiple of 2.
- An error occurs if the same-named segments differ in their relocation attributes. Therefore, the number of the same-named segments for each relocation attribute is one.
- The same-named data segments in two or more different modules can be specified only when their relocation attributes are UNIT, UNITP, SADDR, SADDRP, LRAM, IHRAM, DSPRAM, IXRAM, and are combined into a single data segment at linkage.
- No segment name can be referenced as a symbol.
- The total number of segments that can be output by the assembler is up to 255 alias segments including those defined with the ORG directive. The same-named segments are counted as one.
- The maximum number of characters recognizable as a segment name is 8.

- The uppercase and lowercase characters of a segment name are distinguished.

**[Example]**

```
NAME      SAMP1
DSEG                                ; (1)
WORK1 : DS      2
WORK2 : DS      1
CSEG
MOV      A, !WORK2      ; (2)
MOV      A, WORK2      ; (3)  <- Error
MOVW     DE, #WORK1    ; (4)
MOVW     AX, WORK1     ; (5)  <- Error
END
```

- (1) The start of a data segment is defined with the DSEG directive.  
Because its relocation attribute is omitted, "UNIT" is assumed. The default segment name is "?DSEG".
- (2) This description corresponds to "MOV A, laddr16".
- (3) This description corresponds to "MOV A, saddr".  
Relocatable label "WORK2" cannot be described as "saddr". Therefore, an error occurs as a result of this description.
- (4) This description corresponds to "MOVW rp, #word".
- (5) This description corresponds to "MOVW AX, saddrp".  
Relocatable label "WORK1" cannot be described as "saddrp". Therefore, an error occurs as a result of this description.

**BSEG**

Indicate to the assembler the start of a bit segment.

**[Description Format]**

Symbol field	Mnemonic field	Operand field	Comment field
[segment-name]	BSEG	[relocation-attribute]	[; comment]

**[Function]**

- The BSEG directive indicates to the assembler the start of a bit segment.
- A bit segment is a segment that defines the RAM addresses to be used in the source module.
- A memory area that is defined by the DBIT directive after the BSEG directive until it comes across a segment definition directives (CSEG, DSEG, or BSEG) or the END directive belongs to the bit segment.

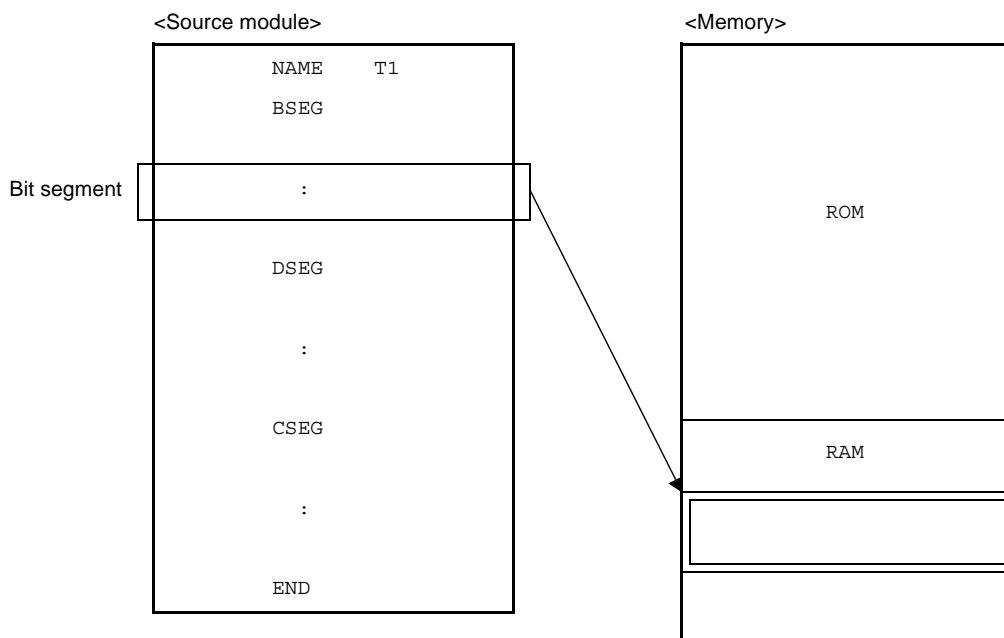

**[Use]**

- Describe the DBIT directive in the bit segment defined by the BSEG directive.
- No instructions can be described in any bit segment.

**[Description]**

- The start address of a bit segment can be specified by describing "AT absolute-expression" in the relocation attribute field.
- A relocation attribute defines a range of location addresses for a bit segment. Relocation attributes available for bit segments are shown below.



Table 4-19. Relocation Attributes of BSEG

Relocation Attribute	Description Format	Explanation
AT	AT <i>absolute-expression</i>	Tells the assembler to locate the starting address of the specified segment in the 0th bit of an absolute address. Specification in bit units is prohibited (0FE20H to 0FEFFH).
UNIT	UNIT or no specification	Tells the assembler to locate the specified segment in any location (0FE20H to 0FEFFH).

- If no relocation attribute is specified for the bit segment, the assembler assumes that "UNIT" is specified.
- If a relocation attribute other than those listed in Table 3-5 is specified, the assembler outputs an error and assumes that "UNIT" is specified. An error occurs if the size of each bit segment exceeds that of the area specified by its relocation attribute.
- In both the assembler and the linker, the location counter in a bit segment is displayed in the form "0xxxx.b" (The byte address is hexadecimal 4 digits and the bit position is hexadecimal 1 digit (0 to 7) ).

(1) Absolute

Byte Address	Bit Position							
	0	1	2	3	4	5	6	7
0FE20H	0FE20H.0	0FE20H.1	0FE20H.2	0FE20H.3	0FE20H.4	0FE20H.5	0FE20H.6	0FE20H.7
0FE21H	0FE21H.0	0FE21H.1	0FE21H.2	0FE21H.3	0FE21H.4	0FE21H.5	0FE21H.6	0FE21H.7

(2) Relocatable

Byte Address	Bit Position							
	0	1	2	3	4	5	6	7
0H	0H.0	0H.1	0H.2	0H.3	0H.4	0H.5	0H.6	0H.7
1H	1H.0	1H.1	1H.2	1H.3	1H.4	1H.5	1H.6	1H.7

**Remark** Within a relocatable bit segment, the byte address specifies an offset value in byte units from the beginning of the segment.

In a symbol table output by the object converter, a bit offset from the beginning of an area where a bit is defined is displayed and output.

Symbol Value	Bit Offset
0FE20H.0	0000
0FE20H.1	0001
0FE20H.2	0002
:	:
0FE20H.7	0007
0FE21H.0	0008
0FE21H.1	0009
:	:

Symbol Value	Bit Offset
0FE80H.0	0300
:	:

- If the absolute expression specified with the relocation attribute "AT" is illegal, the assembler outputs an error message and continues processing while assuming the value of the expression to be "0".
- By describing a segment name in the symbol field of the BSEG directive, the bit segment can be named. If no segment name is specified for a bit segment, the assembler automatically gives a default segment name. The following table shows the default segment names.

Relocation Attribute	Default Segment Name
UNIT (or no specification)	?BSEG
AT	Segment name cannot be omitted.

- When the size of the following segment is 0 among the default segments that C compiler outputs, the relocation attribute is changed by the linker.

Section Name	Relocation Attribute	Relocation Attribute When Being Size 0
@@BITS	BSEG UNIT (in SADDR area)	BSEG UNIT (in RAM area)

- If the relocation attribute is "UNIT", two or more data segments can have the same segment name (except AT). These segments are processed as a single segment within the assembler. Therefore, the number of same-named segments for each relocation attribute is one.
- The same-named bit segments name must have the same relocation attribute UNIT (when the relocation attribute is AT, specifying the same name for multiple segments is prohibited).
- If the relocation attribute of the same-named segments in a module is not UNIT, an error is output and the line is ignored.
- The same-named bit segments in two or more different modules will be combined into a single bit segment at linkage time.
- No segment name can be referenced as a symbol.
- Bit segments are located at 0FE20H to 0FEFFH by the linker.
- Labels cannot be described in a bit segment.
- The only instructions that can be described in the bit segments are the DBIT, EQU, SET, PUBLIC, EXTBIT, EXTRN, MACRO, REPT, IRP, ENDM directive, macro definition and macro reference. Description of instructions other than these causes in an error.
- The total number of segments that the assembler outputs is up to 255 alias segments, with segments defined by the ORG directive. The segments having the same name are counted as one.
- The maximum number of characters recognizable as a segment name is 8.
- The uppercase and lowercase characters of a segment name are distinguished.

**[Example]**

	NAME	SAMP1		
FLAG	EQU	0FE20H		
FLAG0	EQU	FLAG.0	; (1)	
FLAG1	EQU	FLAG.1	; (2)	
	BSEG		; (3)	
FLAG2	DBIT			
	CSEG			
	SET1	FLAG0	; (4)	
	SET1	FLAG2	; (5)	
	END			

(1) Bit addresses (bits 0 of 0FE20H are defined with consideration given to byte address boundaries.

(2) Bit addresses (bits 1 of 0FE20H) are defined with consideration given to byte address boundaries.

(3) A bit segment is defined with the BSEG directive. Because its relocation attribute is omitted, the relocation attribute "UNIT" and the segment name "?BSEG" are assumed.

In each bit segment, a bit work area is defined for each bit with the DBIT directive. A bit segment should be described at the early part of the module body.

Bit address FLAG2 defined within the bit segment is located without considering the byte address boundary.

(4) This description can be replaced with "SET1 FLAG.0". This FLAG indicates a byte address.

(5) In this description, no consideration is given to byte address boundaries.

**ORG**

Set the value of the expression specified by its operand of the location counter.

**[Description Format]**

Symbol field	Mnemonic field	Operand field	Comment field
[segment-name]	ORG	[absolute-expression]	[; comment]

**[Function]**

- The ORG directive sets the value of the expression specified by its operand of the location counter.
- After the ORG directive, described instructions or reserved memory area belongs to an absolute segment until it comes across a segment definition directives (CSEG, DSEG, BSEG, or ORG) or the END directive, and they are located from the address specified by an operand.

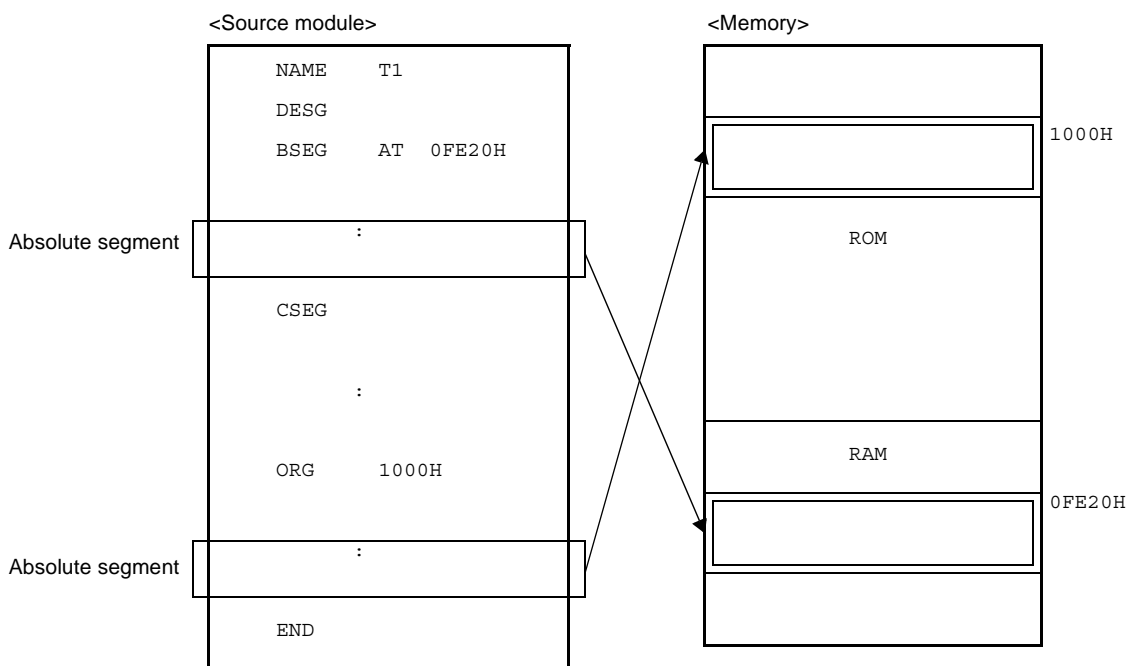

**[Use]**

- Specify the ORG directive to locate a code segment or data segment from a specific address.

**[Description]**

- The absolute segment defined with the ORG directive belongs to the code segment or data segment defined with the CSEG or DSEG directive immediately before this ORG directive. Within an absolute segment that belongs to a data segment, no instructions can be described. An absolute segment that belongs to a bit segment cannot be described with the ORG directive.
- The code segment or data segment defined with the ORG directive is interpreted as a code segment or data segment of the relocation attribute "AT".
- By describing a segment name in the symbol field of the ORG directive, the absolute segment can be named. The maximum number of characters that can be recognized as a segment name is 8.

- The same-named segments in a module, which are defined with the ORG directive, are handled in the same manner as segments of the AT attribute, which are defined with the CSEG or DESG directive.
- The same-named segments in different modules, which are defined with the ORG directive, are handled in the same manner as segments of the AT attribute, which are defined with the CSEG or DESG directive.
- If no segment name is specified for an absolute segment, the assembler will automatically assign the default segment name "?A00nnnn", where "nnnn" indicates the 4 digit hexadecimal start address (0000 to FFFF) of the segment specified.
- If neither CSEG nor DSEG directive has been described before the ORG directive, the absolute segment defined by the ORG directive is interpreted as an absolute segment in a code segment.
- If a name or label is described as the operand of the ORG directive, the name or label must be an absolute term that has already been defined in the source module.
- No segment name can be referenced as a symbol.
- The total number of segments that the assembler outputs is up to 255 alias segments, with segments defined by the segment definition directives. The segments having the same name are counted as one.
- The maximum number of characters recognizable as a segment name is 8.
- The uppercase and lowercase characters of a segment name are distinguished.

**[Example]**

```

NAME      SAMP1

DSEG
ORG       0FE20H      ; (1)
SADR1 : DS      1
SADR2 : DS      1
SADR3 : DS      2

MAIN0    ORG       100H
         MOV       A, SADR1      ; (2)  <- Error

CSEG      ; (3)
MAIN1    ORG       1000H      ; (4)
         MOV       A, SADR2
         MOVW      AX, SADR3
         END

```

**(1) An absolute segment that belongs to a data segment is defined.**

This absolute segment will be located from the short direct addressing area that starts from address "0FE20H". Because specification of the segment name is omitted, the assembler automatically assigns the name "?A00FE20".

**(2) An error occurs because no instruction can be described within an absolute segment that belongs to a data segment.****(3) This directive declares the start of a code segment.****(4) This absolute segment is located in an area that starts from address "1000H".**

### 4.2.3 Symbol definition directives

Symbol definition directives specify names for the data that is used when writing to source modules. With these, the data value specifications are made clear and the details of the source module are easier to understand.

Symbol definition directives indicate the names of values used in the source module to the assembler.

The following symbol definition directives are available.

Control Instruction	Overview
<a href="#">EQU</a>	The value of the expression specified by operand and the numerical data with attribute are defined as a name.
<a href="#">SET</a>	The value of the expression specified by operand and the variable with attribute are defined as a name.

**EQU**

The value of the expression specified by operand and the numerical data with attribute are defined as a name.

**[Description Format]**

Symbol field	Mnemonic field	Operand field	Comment field
<i>name</i>	EQU	<i>expression</i>	[; <i>comment</i> ]

**[Function]**

- The EQU directive defines a name that has the value and attributes (symbol attribute and relocation attribute) of the expression specified in the operand field.

**[Use]**

- Define numerical data to be used in the source module as a name with the EQU directive and describe the name in the operand of an instruction in place of the numerical data.  
Numerical data to be frequently used in the source module is recommended to be defined as a name. If you must change a data value in the source module, all you need to do is to change the operand value of the name.

**[Description]**

- The EQU directive may be described anywhere in a source program.
- A symbol defined with the EQU directive cannot be redefined with the SET, SFR, SFRP directive, nor as a label. In addition, a symbol or label defined with the SET, SFR, SFRP directive cannot be redefined with the EQU directive, nor as a label.
- When a name or label is to be described in the operand of the EQU directive, use the name or label that has already been defined in the source module.  
No external reference term can be described as the operand of this directive.  
SFRs and SFR bit symbols can be described.
- An expression including a term created by a HIGH/LOW/BANKNUM/DATAPOS/BITPOS operator that has a relocatable term in its operand cannot be described.
- An error occurs if an expression with any of the following patterns of operands is described:

(1) Expression 1 with ADDRESS attribute - expression 2 with ADDRESS attribute

(2) Expression 1 with ADDRESS attribute Relational operator Expression 2 with ADDRESS attribute

(3) Either of the following conditions (1) and (2) is fulfilled in the above expression (a) or (b) :

(a) If label 1 in the expression 1 with ADDRESS attribute and label 2 in the expression 2 with ADDRESS attribute belong to the same segment and if a BR directive for which the number of bytes of the object code cannot be determined is described between the two labels

(b) If label 1 and label 2 differ in segment and if a BR directive for which the number of bytes of the object code cannot be determined is described between the beginning of the segment and label

(4) HIGH absolute expression with ADDRESS attribute

- (5) LOW absolute expression with ADDRESS attribute
- (6) BANKNUM absolute expression with ADDRESS attribute
- (7) DATAPOS absolute expression with ADDRESS attribute
- (8) BITPOS absolute expression with ADDRESS attribute
- (9) The following (a) is fulfilled in the expression (4) to (8):

(a) If a BR directive for which the number of bytes of the object code cannot be determined instantly is described between the label in the expression with ADDRESS attribute and the beginning of the segment to which the label belongs

- If an error exists in the description format of the operand, the assembler will output an error message, but will attempt to store the value of the operand as the value of the name described in the symbol field to the extent that it can analyze.
- A name defined with the EQU directive cannot be redefined within the same source module.
- A name that has defined a bit value with the EQU directive will have an address and bit position as value.
- The following table shows the bit values that can be described as the operand of the EQU directive and the range in which these bit values can be referenced.

Operand Type	Symbol Value	Reference Range
A.bit <sup>Note 1</sup>	1.bit	Can be referenced within the same module only.
PSW.bit <sup>Note 1</sup>	1FEH.bit	
sfr <sup>Note 2</sup> .bit <sup>Note 1</sup>	0FFXXH <sup>Note 3</sup> .bit	
efr <sup>Note 4</sup> .bit <sup>Note 1</sup>	0FXXXH <sup>Note 4</sup> .bit	
saddr.bit <sup>Note 1</sup>	0XXXXH <sup>Note 5</sup> .bit	Can be referenced from another module.
expression.bit <sup>Note 1</sup>	0XXXXH <sup>Note 5</sup> .bit	

- Notes**
1. bit = 0 to 7
  2. For a detailed description, see the user's manual of each device.
  3. 0FFXXH : the address of a sfr
  4. 0FXXXH : the address of a efr
  5. 0XXXXH : saddr area (0FE20H to 0FF1FH)



**[Example]**

	NAME	SAMP1	
WORK1	EQU	0FE20H	; (1)
WORK10	EQU	WORK1.0	; (2)
P02	EQU	P0.2	; (3)
A4	EQU	A.4	; (4)
PSW5	EQU	PSW.5	; (5)
	SET1	WORK10	; (6)
	SET1	P02	; (7)
	SET1	A4	; (8)
	SET1	PSW5	; (9)
	END		

- (1) The name "WORK1" has the value "0FE20H", symbol attribute "NUMBER", and relocation attribute "ABSOLUTE".
- (2) The name "WORK10" is assigned to bit value "WORK1.0", which is in the operand format "saddr.bit". "WORK1", which is described in an operand, is already defined at the value "0FE20H", in (1) above.
- (3) The name "P02" is assigned to the bit value "P0.2", which is in the operand format "sfr.bit".
- (4) The name "A4" is assigned to the bit value "A.4", which is in the operand format "A.bit".
- (5) The name "PSW5" is assigned to the bit value "PSW.5", which is in the operand format "PSW.bit".
- (6) This description corresponds to "SET1 saddr.bit".
- (7) This description corresponds to "SET1 sfr.bit".
- (8) This description corresponds to "SET1 A.bit".
- (9) This description corresponds to "SET1 PSW.bit".

Names that have defined "sfr.bit", "A.bit", and "PSW.bit" as in (3), (4) through (5) can be referenced only within the same module.

A name that has defined "saddr.bit" can also be referenced from another module as an external definition symbol (see "4.2.5 Linkage directives").

As a result of assembling the source module in the application example, the following assemble list is generated.

Assemble list							
ALNO	STNO	ADRS	OBJECT	M I	SOURCE	STATEMENT	
1	1					NAME SAMP	
2	2						
3	3		( FE20 )	WORK1	EQU	0FE20H	; (1)
4	4		( FE20.0 )	WORK10	EQU	WORK1.0	; (2)
5	5		( FF00.2 )	P02	EQU	P0.2	; (3)
6	6		( 0001.4 )	A4	EQU	A.4	; (4)
7	7		( 01FE.5 )	PSW5	EQU	PSW.5	; (5)
8	8	0000	0A20		SET1	WORK10	; (6)
9	9	0002	2A00		SET1	P02	; (7)
10	10	0004	61CA		SET1	A4	; (8)
11	11	0006	5A1E		SET1	PSW5	; (9)
12	12					END	

On lines (2) through (5) of the assemble list, the bit address values of the bit values defined as names are indicated in the object code field.

**SET**

The value of the expression specified by operand and the variable with attribute are defined as a name.

**[Description Format]**

Symbol field	Mnemonic field	Operand field	Comment field
<i>name</i>	SET	<i>absolute-expression</i>	[; <i>comment</i> ]

**[Function]**

- The SET directive defines a name that has the value and attributes (symbol attribute and relocation attribute) of the expression specified in the operand field.
- The value and attribute of a name defined with the SET directive can be redefined within the same module. These values and attribute are valid until the same name is redefined.

**[Use]**

- Define numerical data (a variable) to be used in the source module as a name and describe it in the operand of an instruction in place of the numerical data (a variable).  
If you wish to change the value of a name in the source module, a different value can be defined for the same name using the SET directive again.

**[Description]**

- An absolute expression must be described in the operand field of the SET directive.
- The SET directive may be described anywhere in a source program.  
However, a name that has been defined with the SET directive cannot be forward-referenced.
- If an error is detected in the statement in which a name is defined with the SET directive, the assembler outputs an error message but will attempt to store the value of the operand as the value of the name described in the symbol field to the extent that it can analyze.
- A symbol defined with the EQU directive cannot be redefined with the SET directive.  
A symbol defined with the SET directive cannot be redefined with the EQU directive.
- A bit symbol cannot be defined.

**[Example]**

```
NAME      SAMP1
COUNT   SET      10H          ; (1)

        CSEG
        MOV      B, #COUNT   ; (2)
LOOP :
        DEC      B
        BNZ     $LOOP

COUNT   SET      20H          ; (3)

        MOV      B, #COUNT   ; (4)
        END
```

- (1) The name "COUNT" has the value "10H", the symbol attribute "NUMBER", and relocation attribute "ABSOLUTE". The value and attributes are valid until they are redefined by the SET directive in (3) below.
- (2) The value "10H" of the name "COUNT" is transferred to register B.
- (3) The value of the name "COUNT" is changed to "20H".
- (4) The value "20H" of the name "COUNT" is transferred to register B.

#### 4.2.4 Memory initialization, area reservation directives

The memory initialization directive defines the constant data used by the program.

The defined data value is generated as object code.

The area reservation directive secures the area for memory used by the program.

The following memory initialization and partitioning directives are available.

Control Instruction	Overview
DB	Initialization of byte area
DW	Initialization of word area
DS	Secures the memory area of the number of bytes specified by operand.
DBIT	Secures 1 bit of memory area in bit segment.

**DB**

Initialization of byte area

**[Description Format]**

Symbol field	Mnemonic field	Operand field	Comment field
[label:]	DB	(size)	[: comment]
		or	
[label:]	DB	initial-value[, ... ]	[: comment]

**[Function]**

- The DB directive tells the assembler to initialize a byte area.  
The number of bytes to be initialized can be specified as "size".
- The DB directive also tells the assembler to initialize a memory area in byte units with the initial value(s) specified in the operand field.

**[Use]**

- Use the DB directive when defining an expression or character string used in the program.

**[Description]**

- If a value in the operand field is parenthesized, the assembler assumes that a size is specified. Otherwise, an initial value is assumed.

**(1) With size specification:**

- (a) If a size is specified in the operand field, the assembler initializes an area equivalent to the specified number of bytes with the value "00H".**
- (b) An absolute expression must be described as a size. If the size description is illegal, the assembler outputs an error message and will not execute initialization.**

**(2) With initial value specification:****(a) Expression**

The value of an expression must be 8-bit data. Therefore, the value of the operand must be in the range of 0H to 0FFH. If the value exceeds 8 bits, the assembler will use only lower 8 bits of the value as valid data and output an error.

**(b) Character string**

If a character string is described as the operand, an 8-bit ASCII code will be reserved for each character in the string.

- The DB directive cannot be described in a bit segment.
- Two or more initial values may be specified within a statement line of the DB directive.
- As an initial value, an expression that includes a relocatable symbol or external reference symbol may be described.

**[Example]**

	NAME	SAMP1		
	CSEG			
WORK1 :	DB	( 1 )	; (1)	
WORK2 :	DB	( 2 )	; (1)	
	CSEG			
MASSAG :	DB	'ABCDEF'	; (2)	
DATA1 :	DB	0AH, 0BH, 0CH	; (3)	
DATA2 :	DB	( 3 + 1 )	; (4)	
DATA3 :	DB	'AB' + 1	; (5)	<- Error
	END			

- (1) Because the size is specified, the assembler will initialize each byte area with the value "00H".
- (2) A 6-byte area is initialized with character string 'ABCDEF'.
- (3) A 3-byte area is initialized with "0AH, 0BH, 0CH".
- (4) A 4-byte area is initialized with "00H".
- (5) Because the value of expression "AB" + 1 is 4143H (4142H + 1) and exceeds the range of 0 to 0FFH, this description occurs in an error.

**DW**

Initialization of word area

**[Description Format]**

Symbol field	Mnemonic field	Operand field	Comment field
[label:]	DW	(size)	[: comment]
		or	
[label:]	DW	initial-value[, ... ]	[: comment]

**[Function]**

- The DW directive tells the assembler to initialize a word area.  
The number of words to be initialized can be specified as "size".
- The DW directive also tells the assembler to initialize a memory area in word units (2 bytes) with the initial value(s) specified in the operand field.

**[Use]**

- Use the DW directive when defining a 16-bit numeric constant such as an address or data used in the program.

**[Description]**

- If a value in the operand field is parenthesized, the assembler assumes that a size is specified; otherwise an initial value is assumed.

**(1) With size specification:**

- (a) If a size is specified in the operand field, the assembler will initialize an area equivalent to the specified number of words with the value "00H".**
- (b) An absolute expression must be described as a size. If the size description is illegal, the assembler outputs an error and will not execute initialization.**

**(2) With initial value specification:****(a) Constant**

16 bits or less.

**(b) Expression**

The value of an expression must be stored as a 16-bit data.

No character string can be described as an initial value.

- The DW directive cannot be described in a bit segment.
- The upper 2 digits of the specified initial value are stored in the HIGH address and the lower 2 digits of the value in the LOW address.
- Two or more initial values may be specified within a statement line of the DW directive.
- As an initial value, an expression that includes a relocatable symbol or external reference symbol may be described.



[Example]

```

NAME      SAMP1
CSEG
WORK1 :   DW      ( 10 )      ; (1)
WORK2 :   DW      ( 128 )     ; (1)
CSEG
ORG       10H
DW        MAIN      ; (2)
DW        SUB1      ; (2)
CSEG
MAIN :
CSEG
SUB1 :
DATA :    DW      1234H, 5678H ; (3)
END
    
```

- (1) Because the size is specified, the assembler will initialize each word with the value "00H".
- (2) Vector entry addresses are defined with the DW directives.
- (3) A 2-word area is initialized with value "34127856".

**Caution** The HIGH address of memory is initialized with the upper 2 digits of the word value. The LOW address of memory is initialized with the lower 2 digits of the word value.

<Example>

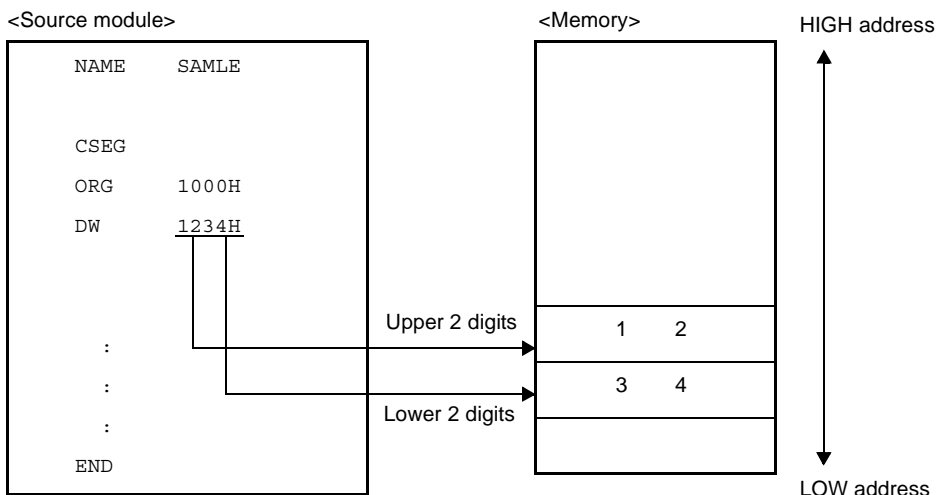

**DS**

Reserves the memory area of the number of bytes specified by operand.

**[Description Format]**

Symbol field	Mnemonic field	Operand field	Comment field
[label:]	DS	<i>absolute-expression</i>	[; <i>comment</i> ]

**[Function]**

- The DS directive tells the assembler to reserve a memory area for the number of bytes specified in the operand field.

**[Use]**

- The DS directive is mainly used to reserve a memory (RAM) area to be used in the program.  
If a label is specified, the value of the first address of the reserved memory area is assigned to the label. In the source module, this label is used for description to manipulate the memory.

**[Description]**

- The contents of an area to be reserved with this DS directive are unknown (indefinite).
- The specified absolute expression will be evaluated with unsigned 16 bits.
- When the operand value is "0", no area can be reserved.
- The DS directive cannot be described within a bit segment.
- The symbol (label) defined with the DS directive can be referenced only in the backward direction.
- Only the following parameters extended from an absolute expression can be described in the operand field:
  - A constant
  - An expression with constants in which an operation is to be performed (constant expression)
  - EQU symbol or SET symbol defined with a constant or constant expression ADDRESS
  - Expression 1 with ADDRESS attribute - expression 2 with ADDRESS attribute  
If both label 1 in "expression 1 with ADDRESS attribute" and label 2 in "expression 2 with ADDRESS attribute" are relocatable, both labels must be defined in the same segment.  
However, an error occurs in either of the following two cases:
    - If label 1 and label 2 belong to the same segment and if a BR directive for which the number of bytes of the object code cannot be determined is described between the two labels
    - If label 1 and label 2 differ in segment and if a BR directive for which the number of bytes of the object code cannot be determined is described between either label and the beginning of the segment to which the label belongs
  - Any of the expressions (1) through (4) above on which an operation is to be performed.
- The following parameters cannot be described in the operand field:
  - External reference symbol
  - Symbol that has defined "expression 1 with ADDRESS attribute - expression 2 with ADDRESS attribute" with the EQU directive
  - Location counter (\$) is described in either expression 1 or expression 2 in the form of "expression 1 with ADDRESS attribute - expression 2 with ADDRESS attribute"
  - Symbol that defines with the EQU directive an expression with the ADDRESS attribute on which the HIGH/LOW/BANKNUM/DATAPOS/BITPOS operator is to be operated

**[Example]**

```

                NAME    SAMPLE
                DSEG
TABLE1 :        DS      10          ; (1)
WORK1  :        DS      2           ; (2)
WORK2  :        DS      1           ; (3)
                CSEG
                MOVW   HL, #TABLE1
                MOV    A, !WORK2
                MOVW   BC, #WORK1
                END
```

- (1) A 10-byte working area is reserved, but the contents of the area are unknown (indefinite). Label "TABLE1" is allocated to the start of the address.**
- (2) A 1-byte working area is reserved.**
- (3) A 2-byte working area is reserved.**

**DBIT**

Secures 1 bit of memory area in bit segment.

**[Description Format]**

Symbol field	Mnemonic field	Operand field	Comment field
[name]	DBIT	None	[; comment]

**[Function]**

- The DBIT directive tells the assembler to reserve a 1-bit memory area within a bit segment.

**[Use]**

- Use the DBIT directive to reserve a bit area within a bit segment.

**[Description]**

- The DBIT directive is described only in a bit segment.
- The contents of a 1-bit area reserved with the DBIT directive are unknown (indefinite).
- If a name is specified in the Symbol field, the name has an address and a bit position as its value.
- The defined name can be described at the place where saddr.bit is required.

**[Example]**

```

NAME      SAMPLE
BSEG
BIT1      DBIT          ; (1)
BIT2      DBIT          ; (1)
BIT3      DBIT          ; (1)

CSEG
SET1      BIT1          ; (2)

CLR1      BIT2          ; (3)
END
    
```

- (1) By these three DBIT directives, the assembler will reserve three 1-bit areas and define names (BIT1, BIT2, and BIT3) each having an address and a bit position as its value.
- (2) This description corresponds to "SET1 saddr.bit" and describes the name "BIT1" of the bit area reserved in (1) above as operand "saddr.bit".
- (3) This description corresponds to "CLR1 saddr.bit" and describes name "BIT2" as "saddr.bit".

4.2.5 Linkage directives

Linkage directives clarify associations when referring to symbols defined by other modules. This is thought to be in cases when one program is written that divides module 1 and module 2.

In cases when you want to refer to a symbol defined in module 2 in module 1, there is nothing declared in either module and so the symbol cannot be used. Due to this, there is a need to display "I want to use" or "I don't want to use" in respective modules.

An "I want to refer to a symbol defined in another module" external reference declaration is made in module 1. At the same time, a "This symbol may be referred to by other symbols" external definition declaration is made in module 2.

This symbol can only begin to be referred to after both external reference and external definition declarations in effect. Linkage directives are used to form this relationship and the following instructions are available.

- Symbol external reference declaration: EXTRN, and also EXTBIT directive.
- Symbol external definition declaration: PUBLIC directive.

Figure 4-7. Relationship of Symbols Between 2 Modules

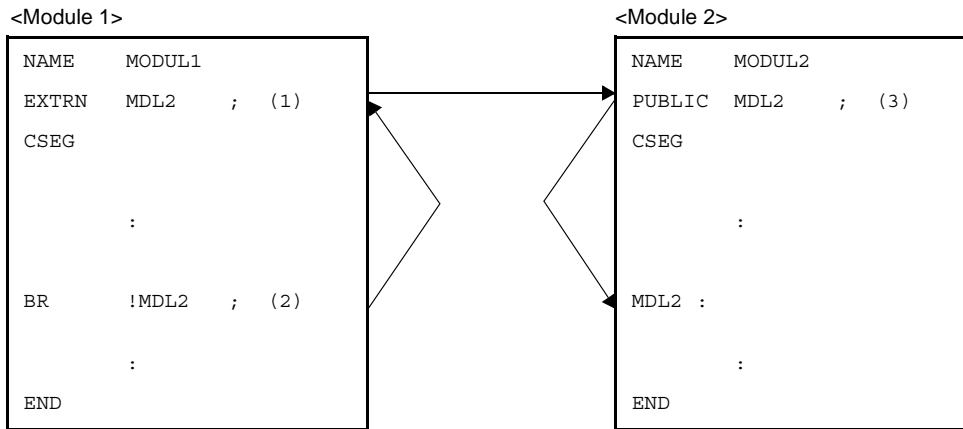

In the above modules, in order for the "MDL2" symbol defined in module 2 to be referred to in (2), an external reference is declared via an EXTRN directive in (1).

In module 2 (3), an external definition declaration is undergone of the "MDL2" symbol referenced from module 1 via a PUBLIC directive.

Whether or not this external reference and external definition symbols are correctly responding or not is checked via a linker.

The following linkage directives are available.

Control Instruction	Overview
EXTRN	Declares to the linker that a symbol (other than bit symbols) in another module is to be referenced in this module.
EXTBIT	Directive declares to the linker that a bit symbol that has a value of saddr.bit in another module is to be referenced in this module.
PUBLIC	Declares to the linker that the symbol described in the operand field is a symbol to be referenced from another module.

**EXTRN**

Declares to the linker that a symbol (other than bit symbols) in another module is to be referenced in this module.

**[Description Format]**

Symbol field	Mnemonic field	Operand field	Comment field
[label:]	EXTRN	symbol-name[, ... ]	[; comment]

**[Function]**

- The EXTRN directive declares to the linker that a symbol (other than bit symbols) in another module is to be referenced in this module.

**[Use]**

- When referencing a symbol defined in another module, the EXTRN directive must be used to declare the symbol as an external reference.
- The resulting operation varies depending on the description format for operands.

BASE(symbol-name[, ...])	The specified symbol is regarded as a symbol in an area within a 64 KB area (0H to 0FFFF) and can be referenced.
No relocation attribute specified	After located by the linker, processing is performed in accordance with the area for which PUBLIC is declared and then can be referenced.

**[Description]**

- The EXTRN directive may be described anywhere in a source program (see "4.1.1 Basic configuration").
- Up to 20 symbols can be specified in the operand field by delimiting each symbol name with a comma ( , ).
- When referencing a symbol having a bit value, the symbol must be declared as an external reference with the EXTBIT directive.
- The symbol declared with the EXTRN directive must be declared in another module with a PUBLIC directive.
- No error is output even if a symbol declared with the EXTRN directive is not referenced in the module.
- No macro name can be described as the operand of EXTRN directive (see "4.4 Macros" for the macro name).
- The EXTRN directive enables only one EXTRN declaration for a symbol in an entire module. For the second and subsequent EXTRN declarations for the symbol, the linker will output a warning.
- A symbol that has been declared cannot be described as the operand of the EXTRN directive. Conversely, a symbol that has been declared as EXTRN cannot be redefined or declared with any other directive.
- A symbol defined by the EXTRN directive can be used to for reference of an saddr area.
- The declared symbol becomes NUMBER attribute.

**[Example]**

- Module 1

```
NAME      SAMP1
EXTRN    SYM1, SYM2      ; (1)
CSEG
S1 :    DW      SYM1      ; (2)
        MOV     A, SYM2    ; (3)
        END
```

- Module 2

```
NAME      SAMP2
PUBLIC   SYM1, SYM2      ; (4)
CSEG
SYM1     EQU     0FFH      ; (5)
DATA1    DSEG    SADDR
SYM2 :   DB      012H      ; (6)
        END
```

- (1) This EXTRN directive declares symbols "SYM1" and "SYM2" to be referenced in (2) and (3) as external references.  
Two or more symbols may be described in the operand field.
- (2) This DW instruction references symbol "SYM1".
- (3) This MOV instruction references symbol "SYM2" and outputs a code that references an saddr area.
- (4) The symbols "SYM1" and "SYM2" are declared as external definitions.
- (5) The symbol "SYM1" is defined.
- (6) The symbol "SYM2" is defined.

**EXTBIT**

Directive declares to the linker that a bit symbol that has a value of `saddr.bit` in another module is to be referenced in this module.

**[Description Format]**

Symbol field	Mnemonic field	Operand field	Comment field
[label:]	EXTBIT	<i>bit-symbol-name</i> [, ... ]	[; <i>comment</i> ]

**[Function]**

- The EXTBIT directive declares to the linker that a bit symbol that has a value of `saddr.bit` in another module is to be referenced in this module.

**[Use]**

- When referencing a symbol that has a bit value and has been defined in another module, the EXTBIT directive must be used to declare the symbol as an external reference.

**[Description]**

- The EXTBIT directive may be described anywhere in a source program.
- Up to 20 symbols can be specified in the operand field by delimiting each symbol with a comma ( , ).
- A symbol declared with the EXTBIT directive must be declared with a PUBLIC directive in another module.
- The EXTBIT directive enables only one EXTBIT declaration for a symbol in an entire module. For the second and subsequent EXTBIT declarations for the symbol, the linker will output a warning.
- No error is output even if a symbol declared with the EXTRN directive is not referenced in the module.

**[Example]**

- Module 1

```

NAME      SAMP1
EXTBIT    FLAG1, FLAG2      ; (1)
CSEG
SET1      FLAG1              ; (2)
CLR1      FLAG2              ; (3)
END

```



- Module 2

```
NAME      SAMP2
PUBLIC    FLAG1, FLAG2      ; (4)
BSEG
FLAG1     DBIT              ; (5)
FLAG2     DBIT              ; (6)
CSEG
NOP
END
```

- (1) This EXTBIT directive declares symbols "FLAG1" and "FLAG2" to be referenced as external references. Two or more symbols may be described in the operand field.
- (2) This SET1 instruction references symbol "FLAG1". This description corresponds to "SET1 saddr.bit".
- (3) This CLR1 instruction references symbol "FLAG2". This description corresponds to "CLR1 saddr.bit".
- (4) This PUBLIC directive defines symbols "FLAG1" and "FLAG2".
- (5) This DBIT directive defines symbol "FLAG1" as a bit symbol of SADDR area.
- (6) This DBIT directive defines symbol "FLAG2" as a bit symbol of SADDR area.

**PUBLIC**

Declares to the linker that the symbol described in the operand field is a symbol to be referenced from another module.

**[Description Format]**

Symbol field	Mnemonic field	Operand field	Comment field
[label:]	PUBLIC	symbol-name[, ... ]	[; comment]

**[Function]**

- The PUBLIC directive declares to the linker that the symbol described in the operand field is a symbol to be referenced from another module.

**[Use]**

- When defining a symbol (including bit symbol) to be referenced from another module, the PUBLIC directive must be used to declare the symbol as an external definition.

**[Description]**

- The PUBLIC directive may be described anywhere in a source program.
- Up to 20 symbols can be specified in the operand field by delimiting each symbol name with a comma ( , ).
- Symbol(s) to be described in the operand field must be defined within the same module.
- The PUBLIC directive enables only one PUBLIC declaration for a symbol in an entire module. The second and subsequent PUBLIC declarations for the symbol will be ignored by the linker.
- Bit symbols in each bit area can be declared with PUBLIC.
- The following symbols cannot be used as the operand of the PUBLIC directive:

- (1) Name defined with the SET directive
- (2) Symbol defined with the EXTRN or EXTBIT directive within the same module
- (3) Segment name
- (4) Module name
- (5) Macro name
- (6) Symbol not defined within the module
- (7) Symbol defining an operand with a bit attribute with the EQU directive
- (8) Symbol defining with SFR and SFRP directive
- (9) Symbol defining an sfr and efr with the EQU directive (however, the place where sfr area and saddr area are overlapped is excluded)

**[Example]**

- Module 1

```
NAME      SAMP1
PUBLIC   A1, A2          ; (1)
EXTRN   B1
EXTBIT   C1

A1      EQU      10H
A2      EQU      0FE20H.1

CSEG

BR       B1
SET1     C1

END
```

- Module 2

```
NAME      SAMP2
PUBLIC   B1              ; (2)
EXTRN   A1
CSEG

B1 :
MOV      C, #LOW ( A1 )

END
```

- Module 3

```
NAME      SAMP3
PUBLIC   C1              ; (3)
EXTBIT   A2
C1      EQU      0FE21H.0
CSEG

CLR1     A2

END
```

- (1) This PUBLIC directive declares that symbols "A1" and "A2" are to be referenced from other modules.
- (2) This PUBLIC directive declares that symbol "B1" is to be referenced from another module.
- (3) This PUBLIC directive declares that symbol "C1" is to be referenced from another module.

**4.2.6 Object module name declaration directive**

An object module name directive gives a name to an object module generated by the assembler.

The following object module name declaration directives are available.

Control Instruction	Overview
NAME	Assign the object module name described in the operand field to an object module to be output by the assembler.

**NAME**

Assign the object module name described in the operand field to an object module to be output by the assembler.

**[Description Format]**

Symbol field	Mnemonic field	Operand field	Comment field
[label:]	NAME	<i>object-module-name</i>	[; <i>comment</i> ]

**[Function]**

- The NAME directive assigns the object module name described in the operand field to an object module to be output by the assembler.

**[Use]**

- A module name is required for each object module in symbolic debugging with a debugger.

**[Description]**

- The NAME directive may be described anywhere in a source program.
- For the conventions of module name description, see the conventions on symbol description in "(3) Symbol field".
- Characters that can be specified as a module name are those characters permitted by the operating system of the assembler software other than "(" (28H) or ")" (29H) or 2-byte characters.
- No module name can be described as the operand of any directive other than NAME or of any instruction.
- If the NAME directive is omitted, the assembler will assume the primary name (first 8 characters) of the input source module file as the module name. The primary name is converted to capital letters for retrieval. If two or more module names are specified, the assembler will output a warning and ignore the second and subsequent module name declarations.
- A module name to be described in the operand field must not exceed 8 characters.
- The uppercase and lowercase characters of a symbol name are distinguished.

**[Example]**

```

NAME    SAMPLE ; (1)
DSEG
BIT1 : DBIT

CSEG
MOV    A, B
END

```

- (1) This NAME directive declares "SAMPLE" as a module name.

**4.2.7 Branch instruction automatic selection directives**

There are two unconditional branch instructions which write the branch address to the operand directly, "BR !addr16", and "BR \$addr16".

With regard to these instructions, because the number of bytes for instructions differs, it is necessary for the user to use them after selecting which operand is suitable depending on the range of the branch destination in order to create a program with good memory efficiency.

Due to this, the 78K0 assembler has a directive to automatically select 2, or 3 branch instructions depending on the range of the branch destination. This is called the branch destination instruction automatic selection directive.

The following branch instruction automatic selection directives are available.

Control Instruction	Overview
BR	Depending on the range of the value of the expression specified by the operand, the assembler automatically selects 2, 3-byte branch instructions and generates corresponding object code.

**BR**

Tells the assembler to automatically select a 2-, 3-byte BR branch instruction according to the value range of the expression specified in the operand field and to generate the object code applicable to the selected instruction.

**[Description Format]**

Symbol field	Mnemonic field	Operand field	Comment field
[label:]	BR	expression	[: comment]

**[Function]**

- The BR directive tells the assembler to automatically select a 2-, 3-byte BR branch instruction according to the value range of the expression specified in the operand field and to generate the object code applicable to the selected instruction.

**[Use]**

- If the branch destination is within the range of -80H to +7FH from the address next to the BR directive, the 2-byte branch instruction "BR \$addr16" can be described. With this instruction, the required memory space can be reduced by one byte as compared with that when using the 3-byte branch instruction "BR !addr16". To create a program with high memory utilization efficiency, the 2-byte branch instruction should be used positively. However, it is troublesome to take the address range of the branch destination into account when describing the branch instruction. Therefore, use the BR directive if it is unclear whether a 2-byte branch instruction can be described.
- If it is definitely known which of a 2-byte or 3-byte branch instruction should be described, describe the applicable instruction. This shortens the assembly time in comparison with describing the BR directive.

**[Description]**

- The BR directive can only be used within a code segment.
- The direct jump destination is described as the operand of the BR directive. "\$" indicating the current location counter at the beginning of an expression cannot be described.
- For optimization, the following conditions must be satisfied.
  - No more than 1 label or forward-reference symbol in the expression.
  - Do not describe an EQU symbol with the ADDRESS attribute.
  - Do not describe an EQU defined symbol for "expression 1 with ADDRESS attribute - expression 2 with ADDRESS attribute".
  - Do not describe an expression with ADDRESS attribute on which the HIGH/LOW/BANKNUM/ DATAPOS/BIT-POS operator has been operated.

If these conditions are not met, the 3-byte BR instruction will be selected.

[Example]

ADDRESS	NAME	CSEG	AT	SAMPLE
	C1	CSEG	AT	50H
0050H		BR	L1	; (1)
0052H		BR	L2	; (2)
.....				
007DH	L1	:		
.....				
7FFFH	L2	:		
			END	

- (1) This BR directive generates a 2-byte branch instruction (BR \$addr16) because the displacement between this line and the branch destination is within the range of -80H and +7FH.
- (2) This BR directive will be substituted with the 3-byte branch instruction (BR !addr16) because the displacement between this line and the branch destination is without the range of -80H and +7FH.



#### 4.2.8 Macro directives

When describing a source it is inefficient to have to describe for each series of high usage frequency instruction groups. This is also the source of increased errors.

Via macro directives, using macro functions it becomes unnecessary to describe many times to the same kind of instruction group series, and coding efficiency can be improved.

Macro basic functions are in substitution of a series of statements.

The following macro directives are available.

Control Instruction	Overview
MACRO	Executes a macro definition by assigning the macro name specified in the symbol field to a series of statements described between MACRO directive and the ENDM directive.
LOCAL	Declares that the symbol name specified in the operand column is a local symbol only effective in that macro body.
REPT	Only the value of the expression specified by the series of statements written between the REPT directive and the ENDM directive is developed repeatedly.
IRP	Only the number of actual arguments is repeatedly developed while the dummy argument is replaced by the actual argument specified by the operand in the series of statements between the IRP directive and ENDM directive.
EXITM	Develops the macro body defined with the MACRO directive, and also via REPT-ENDM, IRP-END M repeat is forced to complete.
ENDM	Completes a set of statements defined as a macro function.

**MACRO**

Executes a macro definition by assigning the macro name specified in the symbol field to a series of statements described between MACRO directive and the ENDM directive.

**[Description Format]**

Symbol field	Mnemonic field	Operand field	Comment field
<i>macro-name</i>	MACRO	[ <i>formal-parameter</i> [, ... ]]	[; <i>comment</i> ]
	:		
	<i>Macro body</i>		
	:		
	ENDM		[; <i>comment</i> ]

**[Function]**

- The MACRO directive executes a macro definition by assigning the macro name specified in the symbol field to a series of statements (called a macro body) described between this directive and the ENDM directive.

**[Use]**

- Define a series of frequently used statements in the source program with a macro name. After its definition only describe the defined macro name (see "(2) Referencing macros" ), and the macro body corresponding to the macro name is expanded.

**[Description]**

- The MACRO directive must be paired with the ENDM directive.
- For the macro name to be described in the symbol field, see the conventions of symbol description in "(3) Symbol field".
- To reference a macro, describe the defined macro name in the mnemonic field.
- For the formal parameter(s) to be described in the operand field, the same rules as the conventions of symbol description will apply.
- Up to 16 formal parameters can be described per macro directive.
- Formal parameters are valid only within the macro body.
- An error occurs if any reserved word is described as a formal parameter. However, if a user-defined symbol is described, its recognition as a formal parameter will take precedence.
- The number of formal parameters must be the same as the number of actual parameters.
- A name or label defined within the macro body if declared with the LOCAL directive becomes effective with respect to one-time macro expansion.
- Nesting of macros (i.e., to refer to other macros within the macro body) is allowed up to eight levels including REPT and IRP directives.
- The number of macros that can be defined within a single source module is not specifically limited. In other words, macros may be defined as long as there is memory space available.
- Formal parameter definition lines, reference lines, and symbol names are not output to a cross-reference list.
- Two or more segments must not be defined in a macro body. If defined, an error will be output.

**[Example]**

```
NAME      SAMPLE

ADMAC    MACRO  PARA1, PARA2    ; (1)
          MOV   A, #PARA1
          ADD   A, #PARA2
          ENDM                    ; (2)

ADMAC    10H, 20H              ; (3)
          END
```

- (1) A macro is defined by specifying macro name "ADMAC" and two formal parameters "PARA1" and "PARA2".
- (2) This directive indicates the end of the macro definition.
- (3) Macro "ADMAC" is referenced.

**LOCAL**

Declares that the symbol name specified in the operand field is a local symbol that is valid only within the macro body

**[Description Format]**

Symbol field	Mnemonic field	Operand field	Comment field
<i>None</i>	LOCAL	<i>symbol-name[, ... ]</i>	<i>[: comment]</i>

**[Function]**

- The LOCAL directive declares that the symbol name specified in the operand field is a local symbol that is valid only within the macro body.

**[Use]**

- If a macro that defines a symbol within the macro body is referenced more than once, the assembler will output a double definition error for the symbol. By using the LOCAL directive, you can reference (or call) a macro, which defines symbol(s) within the macro body, more than once.

**[Description]**

- For the conventions on symbol names to be described in the operand field, see the conventions on symbol description in "(3) Symbol field".
- A symbol declared as LOCAL will be substituted with a symbol "??RAnnnn" (where n = 0000 to FFFF) at each macro expansion. The symbol "??RAnnnn" after the macro replacement will be handled in the same way as a global symbol and will be stored in the symbol table, and can thus be referenced under the symbol name "??RAnnnn".
- If a symbol is described within a macro body and the macro is referenced more than once, it means that the symbol would be defined more than once in the source module. For this reason, it is necessary to declare that the symbol is a local symbol that is valid only within the macro body.
- The LOCAL directive can be used only within a macro definition.
- The LOCAL directive must be described before using the symbol specified in the operand field (in other words, the LOCAL directive must be described at the beginning of the macro body).
- Symbol names to be defined with the LOCAL directive within a source module must be all different (in other words, the same name cannot be used for local symbols to be used in each macro).
- The number of local symbols that can be specified in the operand field is not limited as long as they are all within a line. However, the number of symbols within a macro body is limited to 64. If 65 or more local symbols are declared, the assembler will output an error and store the macro definition as an empty macro body. Nothing will be expanded even if the macro is called.
- Macros defined with the LOCAL directive cannot be nested.
- Symbols defined with the LOCAL directive cannot be called (referenced) from outside the macro.
- No reserved word can be described as a symbol name in the operand field. However, if a symbol same as the user-defined symbol is described, its recognition as a local symbol will take precedence.
- A symbol declared as the operand of the LOCAL directive will not be output to a cross-reference list and symbol table list.
- The statement line of the LOCAL directive will not be output at the time of the macro expansion.
- If a LOCAL declaration is made within a macro definition for which a symbol has the same name as a formal parameter of that macro definition, an error will be output.

**[Example]**

```
NAME      SAMPLE

          ; Macro definition
MAC1      MACRO
          LOCAL  LLAB          ; (1)
LLAB :    ;
          BR     $LLAB        ; (2)
          ENDM                ;

          ; Source text
REF1 :    MAC1                ; (3)

          BR     !LLAB        ; (4)    <- Error

REF2 :    MAC1                ; (5)
          END
```

- (1) This LOCAL directive defines symbol name "LLAB" as a local symbol.
- (2) This BR instruction references local symbol "LLAB" within macro MAC1.
- (3) This macro reference calls macro MAC1.
- (4) Because local symbol "LLAB" is referenced outside the definition of macro MAC1, this description results in an error.
- (5) This macro reference calls macro MAC1.

The assemble list of the above application example is shown below.

Assemble list						
ALNO	STNO	ADRS	OBJECT	M I	SOURCE STATEMENT	
1	1				NAME SAMPLE	
2	2			M	MAC1 MACRO	
3	3			M	LOCAL LLAB	; (1)
4	4			M	LLAB :	
5	5			M	BR \$LLAB	; (2)
6	6			M	ENDM	
7	7					
8	8	000000			REF1 : MAC1	; (3)
	9			#1	;	
10		000000		#1	??RA0000:	
11		000000	14FE	#1	BR \$??RA0000	; (2)
9	12					
10	13	000002	2C0000		BR !LLAB	; (4)
*** ERROR E2407 , STNO 13 ( 0 ) Undefined symbol reference 'LLAB'						
*** ERROR E2303 , STNO 13 ( 13 ) Illegal expression						
11	14					
12	15	000005			REF2 : MAC1	; (5)
16				#1	;	
17		000005		#1	??RA0001 :	
18		000005	14FE	#1	BR \$??RA0001	; (2)
13	19				END	

**REPT**

Tells the assembler to repeatedly expand a series of statements described between this directive and the ENDM directive the number of times equivalent to the value of the expression specified in the operand field.

**[Description Format]**

Symbol field	Mnemonic field	Operand field	Comment field
[label:]	REPT	<i>absolute-expression</i>	[; <i>comment</i> ]
	:		
	ENDM		[; <i>comment</i> ]

**[Function]**

- The REPT directive tells the assembler to repeatedly expand a series of statements described between this directive and the ENDM directive (called the REPT-ENDM block) the number of times equivalent to the value of the expression specified in the operand field.

**[Use]**

- Use the REPT and ENDM directives to describe a series of statements repeatedly in a source program.

**[Description]**

- An error occurs if the REPT directive is not paired with the ENDM directive.
- In the REPT-ENDM block, macro references, REPT directives, and IRP directives can be nested up to eight levels.
- If the EXITM directive appears in the REPT-ENDM block, subsequent expansion of the REPT-ENDM block by the assembler is terminated.
- Assembly control instructions may be described in the REPT-ENDM block.
- Macro definitions cannot be described in the REPT-ENDM block.
- The absolute expression described in the operand field is evaluated with unsigned 16 bits.  
If the value of the expression is 0, nothing is expanded.

**[Example]**

```

NAME    SAMP1
CSEG
    ; REPT-ENDM block
REPT    3                ; (1)
        INC    B
        DEC    C
        ; Source text
ENDM    ; (2)
END
    
```

**(1) This REPT directive tells the assembler to expand the REPT-ENDM block three consecutive times.**

**(2) This directive indicates the end of the REPT-ENDM block.**

When the above source program is assembled, the REPT-ENDM block is expanded as shown in the following assemble list:

```
NAME      SAMP1
CSEG
REPT      3
          INC      B
          DEC      C
ENDM
          INC      B
          DEC      C
          INC      B
          DEC      C
          INC      B
          DEC      C
END
```

The REPT-ENDM block defined by statements (1) and (2) has been expanded three times.

On the assemble list, the definition statements (1) and (2) by the REPT directive in the source module is not displayed.



**IRP**

Tells the assembler to repeatedly expand a series of statements described between IRP directive and the ENDM directive the number of times equivalent to the number of actual parameters while replacing the formal parameter with the actual parameters (from the left, the order) specified in the operand field.

**[Description Format]**

Symbol field	Mnemonic field	Operand field	Comment field
[label:]	IRP	<i>formal-parameter</i> , <[ <i>actual-parameter</i> [, ... ]]>	[; <i>comment</i> ]
	:		
	ENDM		[; <i>comment</i> ]

**[Function]**

- The IRP directive tells the assembler to repeatedly expand a series of statements described between this directive and the ENDM directive (called the IRP-ENDM block) the number of times equivalent to the number of actual parameters while replacing the formal parameter with the actual parameters (from the left, the order) specified in the operand field.

**[Use]**

- Use the IRP and ENDM directives to describe a series of statements, only some of which become variables, repeatedly in a source program.

**[Description]**

- The IRP directive must be paired with the ENDM directive.
- Up to 16 actual parameters may be described in the operand field.
- In the IRP-ENDM block, macro references, REPT and IRP directives can be nested up to eight levels.
- If the EXITM directive appears in the IRP-ENDM block, subsequent expansion of the IRP-ENDM block by the assembler is terminated.
- Macro definitions cannot be described in the IRP-ENDM block.
- Assembly control instructions may be described in the IRP-ENDM block.

**[Example]**

```

NAME    SAMP1
CSEG

IRP     PARA, <0AH, 0BH, 0CH>           ; (1)
      ; IRP-ENDM block
ADD     A, #PARA
MOV     [DE], A
ENDM    ; (2)
      ; Source text
END
    
```

- (1) The formal parameter is "PARA" and the actual parameters are the following three: "0AH", "0BH", and "0CH".

This IRP directive tells the assembler to expand the IRP-ENDM block three times (i.e., the number of actual parameters) while replacing the formal parameter "PARA" with the actual parameters "0AH", "0BH", and "0CH".

- (2) This directive indicates the end of the IRP-ENDM block.

When the above source program is assembled, the IRP-ENDM block is expanded as shown in the following assemble list:

```
NAME      SAMP1
CSEG
      ; IRP-ENDM block
ADD      A, #0AH      ; (3)
MOV      [DE], A
ADD      A, #0BH      ; (4)
MOV      [DE], A
ADD      A, #0CH      ; (5)
MOV      [DE], A
      ;Source text
END
```

The IRP-ENDM block defined by statements (1) and (2) has been expanded three times (equivalent to the number of actual parameters).

- (3) In this ADD instruction, PARA is replaced with 0AH.

- (4) In this ADD instruction, PARA is replaced with 0BH.

- (5) In this ADD instruction, PARA is replaced with 0CH.

**EXITM**

Forcibly terminates the expansion of the macro body defined by the MACRO directive and the repetition by the REPT-ENDM or IRP-ENDM block.

**[Description Format]**

Symbol field	Mnemonic field	Operand field	Comment field
[label:]	EXITM	None	[; comment]

**[Function]**

- The EXITM directive forcibly terminates the expansion of the macro body defined by the MACRO directive and the repetition by the REPT-ENDM or IRP-ENDM block.

**[Use]**

- This function is mainly used when a conditional assembly function (see "[4.3.7 Conditional assembly control instructions](#)") is used in the macro body defined with the MACRO directive.
- If conditional assembly functions are used in combination with other instructions in the macro body, part of the source program that must not be assembled is likely to be assembled unless control is returned from the macro by force using this EXITM directive. In such cases, be sure to use the EXITM directive.

**[Description]**

- If the EXITM directive is described in a macro body, instructions up to the ENDM directive will be stored as the macro body.
- The EXITM directive indicates the end of a macro only during the macro expansion.
- If something is described in the operand field of the EXITM directive, the assembler will output an error but will execute the EXITM processing.
- If the EXITM directive appears in a macro body, the assembler will return by force the nesting level of IF/\_IF/ELSE/ELSEIF/\_ELSEIF/ENDIF blocks to the level when the assembler entered the macro body.
- If the EXITM directive appears in an INCLUDE file resulting from expanding the INCLUDE control instruction described in a macro body, the assembler will accept the EXITM directive as valid and terminate the macro expansion at that level.

**[Example]**

```

NAME      SAMP1
MAC1      MACRO                                ; (1)
          ; macro body
          NOT1      CY
$         IF ( SW1 )                          ; (2)    <- IF block
          BT        A.1, $L1
          EXITM     ; (3)
$         ELSE      ; (4)    <- ELSE block
          MOV1     CY, A.1
          MOV      A, #0
$         ENDIF     ; (5)
$         IF ( SW2 )                          ; (6)    <- IF block
          BR       [HL]
$         ELSE      ; (7)    <- ELSE block
          BR       [DE]
$         ENDIF     ; (8)
          ; Source text
          ENDM      ; (9)

          CSEG
$         SET ( SW1 )                          ; (10)
          MAC1      ; (11)    <- Macro reference
L1:      NOP
          END

```

- (1) The macro "MAC1" uses conditional assembly functions (2) and (4) through (8) within the macro body.
- (2) An IF block for conditional assembly is defined here.  
If switch name "SW1" is true (not "0" ), the ELSE block is assembled.
- (3) This directive terminates by force the expansion of the macro body in (4) and thereafter.  
If this EXITM directive is omitted, the assembler proceeds to the assembly process in (6) and thereafter when the macro is expanded.
- (4) An ELSE block for conditional assembly is defined here.  
If switch name "SW1" is false ("0"), the ELSE block is assembled.
- (5) This ENDIF control instruction indicates the end of the conditional assembly.
- (6) Another IF block for conditional assembly is defined here.  
If switch name "SW2" is true (not "0" ), the following IF block is assembled.
- (7) Another ELSE block for conditional assembly is defined.  
If switch name "SW2" is false ("0"), the ELSE block is assembled.

(8) This ENDIF instruction indicates the end of the conditional assembly processes in (6) and (7).

(9) This directive indicates the end of the macro body.

(10) This SET control instruction gives true value (not "0" ) to switch name "SW1" and sets the condition of the conditional assembly.

(11) This macro reference calls macro "MAC1".

**Remark** In the example here, conditional assembly control instructions are used. See "[4.3.7 Conditional assembly control instructions](#)". See "[4.4 Macros](#)" for the macro body and macro expansion.

The assemble list of the above application example is shown below.

```

NAME      SAMP1
MAC1      MACRO                      ; (1)
          :
          ENDM                        ; (9)
          CSEG
$         SET ( SW1 )                 ; (10)
          MAC1                        ; (11)
          ; Macro-expanded part
          NOT1      CY
$         IF ( SW1 )
          BT        A.1, $L1
          ; Source text
L1 :     NOP
          END

```

The macro body of macro "MAC1" is expanded by referring to the macro in (11).

Because true value is set in switch name "SW1" in (10), the first IF block in the macro body is assembled. Because the EXITM directive is described at the end of the IF block, the subsequent macro expansion is not executed.

**ENDM**

Instructs the assembler to terminate the execution of a series of statements defined as the functions of the macro.

**[Description Format]**

Symbol field	Mnemonic field	Operand field	Comment field
<i>None</i>	ENDM	<i>None</i>	[; <i>comment</i> ]

**[Function]**

- The ENDM directive instructs the assembler to terminate the execution of a series of statements defined as the functions of the macro.

**[Use]**

- The ENDM directive must always be described at the end of a series of statements following the MACRO, REPT, and/or the IRP directives.

**[Description]**

- A series of statements described between the MACRO directive and ENDM directive becomes a macro body.
- A series of statements described between the REPT directive and ENDM directive becomes a REPT-ENDM block.
- A series of statements described between the IRP directive and ENDM directive becomes an IRP-ENDM block.

**[Example]**

**(1) MACRO-ENDM**

```

NAME      SAMP1
ADMAC    MACRO  PARA1, PARA2
          MOV   A, #PARA1
          ADD   A, #PARA2
          ENDM
          :
          END
    
```

**(2) REPT-ENDM**

```

NAME      SAMP2
CSEG
:
REPT     3
          INC   B
          DEC   C
          ENDM
          :
          END
    
```

## (3) IRP-ENDM

```
NAME    SAMP3
CSEG
:
IRP     PARA, <1, 2, 3>
        ADD     A, #PARA
        MOV     [DE], A
ENDM
:
END
```

#### 4.2.9 Assemble termination directive

The assemble termination directive specifies completion of the source module to the assembler. This assembly termination directive must always be described at the end of each source module.

The assembler processes as a source module until the assemble completion directive. Consequently, with REPT block and IRP Block, if the assemble directive is before ENDM, the REPT block and IRP block become ineffective.

The following assemble termination directives are available.

Control Instruction	Overview
END	Declares termination of the source module



**END**

Declares termination of the source module

**[Description Format]**

Symbol field	Mnemonic field	Operand field	Comment field
<i>None</i>	END	<i>None</i>	[; <i>comment</i> ]

**[Function]**

- The END directive indicates to the assembler the end of a source module.

**[Use]**

- The END directive must always be described at the end of each source module.

**[Description]**

- The assembler continues to assemble a source module until the END directive appears in the source module. Therefore, the END directive is required at the end of each source module.
- Always input a line-feed (LF) code after the END directive.
- If any statement other than blank, tab, LF, or comments appears after the END directive, the assembler outputs a warning message.

**[Example]**

```

NAME      SAMPLE
DSEG
:
CSEG
:
END                ; (1)
    
```

- (1) Always describe the END directive at the end of each source module.**

### 4.3 Control Instructions

This chapter describes control instructions.

Control Instructions provide detailed instructions for assembler operation.

#### 4.3.1 Overview

Control instructions provide detailed instructions for assembler operation and so are written in the source.

Control instructions do not become the target of object code generation.

Control instruction categories are displayed below.

**Table 4-20. Control Instruction List**

Control Instruction Type	Control Instruction
Assemble target type specification control instruction	PROCESSOR
Debug information output control instructions	DEBUG, NODEBUG, DEBUGA, NODEBUGA
Cross-reference list output specification control instructions	XREF, NOXREF, SYMLIST, NOSYMLIST
Include control instruction	INCLUDE
Assembly list control instructions	EJECT, LIST, NOLIST, GEN, NOGEN, COND, NOCOND, TITLE, SUBTITLE, FORMFEED, NOFORMFEED, WIDTH, LENGTH, TAB
Conditional assembly control instructions	IF, _IF, ELSEIF, _ELSEIF, ELSE, ENDIF, SET, RESET
Kanji code control instruction	KANJICODE
Other control instructions	TOL_INF, DGS, DGL

As with directives, control instructions are specified in the source.

Also, among the control instructions displayed in "Table 4-20. Control Instruction List", the following can be written as an assembler option even in the command line when the assembler is activated.

**Table 4-21. Control Instructions and Assembler Options**

Control Instruction	Assembler Options
PROCESSOR	-c
DEBUG/NODEBUG	-g/-ng
DEBUGA/NODEBUGA	-ga/-nga
XREF/NOXREF	-kx/-nkx
SYMLIST/NOSYMLIST	-ks/-nks
TITLE	-lh
FORMFEED/NOFORMFEED	-lf/-nlf
WIDTH	-lw
LENGTH	-ll
TAB	-lt
KANJICODE	-zs/-ze/-zn

**4.3.2 Assemble target type specification control instruction**

Assemble target type specification control instructions specify the assemble target type in the source module file. The following assemble target type specification control instructions are available.

Control Instruction	Overview
PROCESSOR	Specifies in a source module file the assemble target type.

**PROCESSOR**

Specifies in a source module file the assemble target type.

**[Description Format]**

```
[Δ] $ [Δ] PROCESSOR [Δ] ( [Δ] processor-type [Δ] )
[Δ] $ [Δ] PC [Δ] ( [Δ] processor-type [Δ] ) ; Abbreviated format
```

**[Function]**

- The PROCESSOR control instruction specifies in a source module file the processor type of the target device subject to assembly.

**[Use]**

- The processor type of the target device subject to assembly must always be specified in the source module file or in the startup command line of the assembler.
- If you omit the processor type specification for the target device subject to assembly in each source module file, you must specify the processor type at each assembly operation. Therefore, by specifying the target device subject to assembly in each source module file, you can save time and trouble when starting up the assembler.

**[Description]**

- The PROCESSOR control instruction can be described only in the header section of a source module file. If the control instruction is described elsewhere, the assembler will be aborted.
- For the specifiable processor name, see the user's manual of the device used or "Device Files Operating Precautions".
- If the specified processor type differs from the actual target device subject to assembly, the assembler will be aborted.
- Only one PROCESSOR control instruction can be specified in the module header.
- The processor type of the target device subject to assembly may also be specified with the assembler option (-c) in the startup command line of the assembler. If the specified processor type differs between the source module file and the startup command line, the assembler will output a warning message and give precedence to the processor type specification in the startup command line.
- Even when the assembler option (-c) has been specified in the startup command line, the assembler performs a syntax check on the PROCESSOR control instruction.
- If the processor type is not specified in either the source module file or the startup command line, the assembler will be aborted.

**[Application example]**

```
$      PROCESSOR ( 014 )
$      DEBUG
$      XREF

      NAME      TEST
      :
      CSEG
```

### 4.3.3 Debug information output control instructions

With debug information output control instructions it is possible to specify the output of debug information for the object module file in the source module file.

The following debug information output control instructions are available.

Control Instruction	Overview
DEBUG	Adds local symbol information in the object module file.
NODEBUG	Does not add local symbol information in the object module file.
DEBUGA	Adds assembler source debug information in the object module file.
NODEBUGA	Does not add assembler source debug information in the object module file.

**DEBUG**

Adds local symbol information in the object module file.

**[Description Format]**

```
[Δ] $ [Δ] DEBUG          ; Default assumption
[Δ] $ [Δ] DG             ; Abbreviated format
```

**[Function]**

- The DEBUG control instruction tells the assembler to add local symbol information to an object module file.
- The NODEBUG control instruction tells the assembler not to add local symbol information to an object module file. However, in this case as well, the segment name is output to an object module file.

**[Use]**

- Use the DEBUG control instruction when symbolic debugging including local symbols is to be performed.

**[Description]**

- The DEBUG or NODEBUG control instruction can be described only in the header section of a source module file.
- If the DEBUG or NODEBUG control instruction is omitted, the assembler will assume that the DEBUG control instruction has been specified.
- If two or more of these control instructions are specified, the last specified control instruction takes precedence over the others.
- The addition of local symbol information can be specified using the assembler option (-g/-ng) in the startup command line.
- If the control instruction specification in the source module file differs from the specification in the startup command line, the specification in the command line takes precedence.
- Even when the assembler option (-ng) has been specified, the assembler performs a syntax check on the DEBUG or NODEBUG control instruction.

**NODEBUG**

Does not add local symbol information in the object module file.

**[Description Format]**

```
[Δ] $ [Δ] NODEBUG  
[Δ] $ [Δ] NODG ; Abbreviated format
```

**[Function]**

- The NODEBUG control instruction tells the assembler not to add local symbol information to an object module file. However, in this case as well, the segment name is output to an object module file.
- "Local symbol information" refers to symbols other than module names and PUBLIC, EXTRN, and EXTBIT symbols.

**[Use]**

- Use the NODEBUG control instruction when:
  - Symbolic debugging is to be performed for global symbols only
  - Debugging is to be performed without symbols
  - Only objects are required (as for evaluation with PROM)

**[Description]**

- The DEBUG or NODEBUG control instruction can be described only in the header section of a source module file.
- If the DEBUG or NODEBUG control instruction is omitted, the assembler will assume that the DEBUG control instruction has been specified.
- If two or more of these control instructions are specified, the last specified control instruction takes precedence over the others.
- The addition of local symbol information can be specified using the assembler option (-g/-ng) in the startup command line.
- If the control instruction specification in the source module file differs from the specification in the startup command line, the specification in the command line takes precedence.
- Even when the assembler option (-ng) has been specified, the assembler performs a syntax check on the DEBUG or NODEBUG control instruction.

**DEBUGA**

Adds assembler source debug information in the object module file.

**[Description Format]**

```
[Δ] $ [Δ] DEBUGA ; Default assumption
```

**[Function]**

- The DEBUGA control instruction tells the assembler to add assembler source debugging information to an object module file.

**[Use]**

- Use the DEBUGA control instruction when debugging is to be performed at the assembler or structured assembler preprocessor source level. An integrated debugger will be necessary for debugging at the source level.

**[Description]**

- The DEBUGA or NODEBUGA control instruction can be described only in the header section of a source module file.
- If the DEBUGA or NODEBUGA control instruction is omitted, the assembler will assume that the DEBUGA control instruction has been specified.
- If two or more of these control instructions are specified, the last specified control instruction takes precedence over the others.
- The addition of assembler source debugging information can be specified using the assembler option (-ga/-nga) in the startup command line.
- If the control instruction specification in the source module file differs from the specification in the startup command line, the specification in the command line takes precedence.
- Even when the assembler option (-nga) has been specified, the assembler performs a syntax check on the DEBUGA or NODEBUGA control instruction.
- If compiling or structure-assembling the debug information output by the C compiler or structured assembler preprocessor, do not describe the debug information output control instructions when assembling the output assemble source. The control instructions necessary at assembly are output to assembler source as control statements by the C compiler or structured assembler preprocessor.



**NODEBUGA**

Does not add assembler source debug information in the object module file.

**[Description Format]**

[Δ] \$ [Δ] NODEBUGA

**[Function]**

- The NODEBUGA control instruction tells the assembler not to add assembler source debugging information to an object module file.

**[Use]**

- Use the NODEBUGA control instruction when:
  - Debugging is to be performed without the assembler source
  - Only objects are required (as for evaluation with PROM)

**[Description]**

- The DEBUGA or NODEBUGA control instruction can be described only in the header section of a source module file.
- If the DEBUGA or NODEBUGA control instruction is omitted, the assembler will assume that the DEBUGA control instruction has been specified.
- If two or more of these control instructions are specified, the last specified control instruction takes precedence over the others.
- The addition of assembler source debugging information can be specified using the assembler option (-ga/-nga) in the startup command line.
- If the control instruction specification in the source module file differs from the specification in the startup command line, the specification in the command line takes precedence.
- Even when the assembler option (-nga) has been specified, the assembler performs a syntax check on the DEBUGA or NODEBUGA control instruction.
- If compiling or structure-assembling the debug information output by the C compiler or structured assembler preprocessor, do not describe the debug information output control instructions when assembling the output assemble source. The control instructions necessary at assembly are output to assembler source as control statements by the C compiler or structured assembler preprocessor.

#### 4.3.4 Cross-reference list output specification control instructions

cross-reference list output specification control instructions specify cross-reference list output in a source module file.

The following cross-reference list output specification control instructions are available.

Control Instruction	Overview
<a href="#">XREF</a>	Outputs a cross-reference list to an assemble list file.
<a href="#">NOXREF</a>	Does not output a cross-reference list to an assemble list file.
<a href="#">SYMLIST</a>	Outputs a symbol list to a list file.
<a href="#">NOSYMLIST</a>	Does not output a symbol list to a list file.

**XREF**

Outputs a cross-reference list to an assemble list file.

**[Description Format]**

```
[Δ] $ [Δ] XREF  
[Δ] $ [Δ] XR           ; Abbreviated format
```

**[Function]**

- The XREF control instruction tells the assembler to output a cross-reference list to an assembly list file.

**[Use]**

- Use the XREF control instruction to output a cross-reference list when you want information on where each of the symbols defined in the source module file is referenced or how many such symbols are referenced in the source module file.
- If you must specify the output or non-output of a cross-reference list at each assembly operation, you may save time and labor by specifying the XREF and NOXREF control instruction in the source module file.

**[Description]**

- The XREF or NOXREF control instruction can be described only in the header section of a source module file.
- If two or more of these control instructions are specified, the last specified control instruction takes precedence over the others.
- Output or non-output of a cross-reference list can also be specified by the assembler option (-kx/-nkx) in the startup command line.
- If the control instruction specification in the source module file differs from the assembler option specification in the startup command line, the specification in the command line will take precedence over that in the source module.
- Even when the assembler option (-np) has been specified in the startup command line, the assembler performs a syntax check on the XREF/NOXREF control instruction.

**NOXREF**

Does not output a cross-reference list to an assemble list file.

**[Description Format]**

```
[Δ] $ [Δ] NOXREF      ; Default assumption
[Δ] $ [Δ] NOXR       ; Abbreviated format
```

**[Function]**

- The NOXREF control instruction tells the assembler not to output a cross-reference list to an assembly list file.

**[Use]**

- Use the XREF control instruction to output a cross-reference list when you want information on where each of the symbols defined in the source module file is referenced or how many such symbols are referenced in the source module file.
- If you must specify the output or non-output of a cross-reference list at each assembly operation, you may save time and labor by specifying the XREF and NOXREF control instruction in the source module file.

**[Description]**

- The XREF or NOXREF control instruction can be described only in the header section of a source module file.
- If two or more of these control instructions are specified, the last specified control instruction takes precedence over the others.
- Output or non-output of a cross-reference list can also be specified by the assembler option (-kx/-nkx) in the startup command line.
- If the control instruction specification in the source module file differs from the assembler option specification in the startup command line, the specification in the command line will take precedence over that in the source module.
- Even when the assembler option (-np) has been specified in the startup command line, the assembler performs a syntax check on the XREF/NOXREF control instruction.

**SYMLIST**

Outputs a symbol list to a list file

**[Description Format]**

```
[Δ] $ [Δ] SYMLIST
```

**[Function]**

- The SYMLIST control instruction tells the assembler to output a symbol list to a list file.

**[Use]**

- Use the SYMLIST control instruction to output a symbol list.

**[Description]**

- The SYMLIST or NOSYMLIST control instruction can be described only in the header section of a source module file.
- If two or more of these control instructions are specified, the last specified control instruction takes precedence over the others.
- Output of a symbol list can also be specified by the assembler option (-ks/-nks) in the startup command line.
- If the control instruction specification in the source module file differs from the assembler option specification in the startup command line, the specification in the command line will take precedence over that in the source module.
- Even when the assembler option (-np) has been specified in the startup command line, the assembler performs a syntax check on the SYMLIST/NOSYMLIST control instruction.

**NOSYMLIST**

Does not output a symbol list to a list file.

**[Description Format]**

```
[Δ] $ [Δ] NOSYMLIST ; Default assumption
```

**[Function]**

- The NOSYMLIST control instruction tells the assembler not to output a symbol list to a list file.

**[Use]**

- Use the NOSYMLIST control instruction not to output a symbol list.

**[Description]**

- The SYMLIST or NOSYMLIST control instruction can be described only in the header section of a source module file.
- If two or more of these control instructions are specified, the last specified control instruction takes precedence over the others.
- Output of a symbol list can also be specified by the assembler option (-ks/-nks) in the startup command line.
- If the control instruction specification in the source module file differs from the assembler option specification in the startup command line, the specification in the command line will take precedence over that in the source module.
- Even when the assembler option (-np) has been specified in the startup command line, the assembler performs a syntax check on the SYMLIST/NOSYMLIST control instruction.

#### 4.3.5 Include control instruction

Include control instructions are used when quoting other source module files in the source module

By using include control instructions effectively, the labor hours for describing source can be reduced.

The following include control instructions are available.

Control Instruction	Overview
INCLUDE	Quote a series of statements from another source module file.

**INCLUDE**

Quote a series of statements from another source module file.

**[Description Format]**

```
[Δ] $ [Δ] INCLUDE [Δ] ( [Δ] filename [Δ] )
[Δ] $ [Δ] IC [Δ] ( [Δ] filename [Δ] ) ; Abbreviated format
```

**[Function]**

- The INCLUDE control instruction tells the assembler to insert and expand the contents of a specified file beginning on a specified line in the source program for assembly.

**[Use]**

- A relatively large group of statements that may be shared by two or more source modules should be combined into a single file as an INCLUDE file.  
If the group of statements must be used in each source module, specify the filename of the required INCLUDE file with the INCLUDE control instruction.  
With this control instruction, you can greatly reduce time and labor in describing source modules.

**[Description]**

- The INCLUDE control instruction can only be described in ordinary source programs.
- The pathname or drive name of an INCLUDE file can be specified with the assembler option (-I).
- The assembler searches INCLUDE file read paths in the following sequence:

**(1) When an INCLUDE file is specified without pathname specification**

- Path in which the source file exists**
- Path specified by the assembler option (-I)**
- Path specified by the environment variable INC78K0**

**(2) When an INCLUDE file is specified with a pathname**

If the INCLUDE file is specified with a drive name or a pathname which begins with backslash (\), the path specified with the INCLUDE file will be prefixed to the INCLUDE filename. If the INCLUDE file is specified with a relative path (which does not begin with \), a pathname will be prefixed to the INCLUDE filename in the order described in (1) above.

- Nesting of INCLUDE files is allowed up to seven levels. In other words, the nesting level display of INCLUDE files in the assembly list is up to 8 (the term "nesting" here refers to the specification of one or more other INCLUDE files in an INCLUDE file).
- The END directive need not be described in an INCLUDE file.
- If the specified INCLUDE file cannot be opened, the assembler will abort operation.

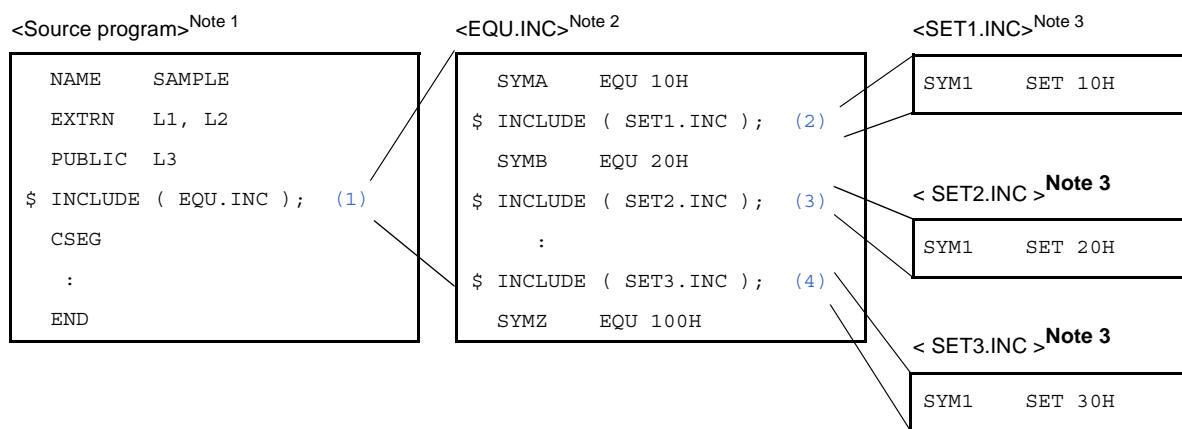

- An INCLUDE file must be closed with IF or \_IF control instruction that is properly paired with an ENDIF control instruction within the INCLUDE file. If the IF level at the entry of the INCLUDE file expansion does not correspond with the IF level immediately after the INCLUDE file expansion, the assembler will output an error message and force the IF level to return to that level at the entry of the INCLUDE file expansion.
- When defining a macro in an INCLUDE file, the macro definition must be closed in the INCLUDE file. If an ENDM directive appears unexpectedly (without the corresponding MACRO directive) in the INCLUDE file, an error message will be output and the ENDM directive will be ignored. If an ENDM directive is missing for the MACRO directive described in the INCLUDE file, the assembler will output an error message but will process the macro definition by assuming that the corresponding ENDM directive has been described.
- Two or more segments cannot be defined in an include file. An error is output, if defined.

**[Application example]**

- (1) This control instruction specifies "EQU.INC" as the INCLUDE file.
- (2) This control instruction specifies "SET1.INC" as the INCLUDE file.
- (3) This control instruction specifies "SET2.INC" as the INCLUDE file.
- (4) This control instruction specifies "SET3.INC" as the INCLUDE file.

- Notes 1.** Two or more \$IC control instructions can be specified in the source file. The same INCLUDE file may also be specified more than once.
2. Two or more \$IC control instructions may be specified for INCLUDE file "EQU.INC".
  3. No \$IC control instruction can be specified in any of the INCLUDE files "SET1.INC", "SET2.INC", and "SET3.INC".

When this source program is assembled, the contents of the INCLUDE file will be expanded as follows:

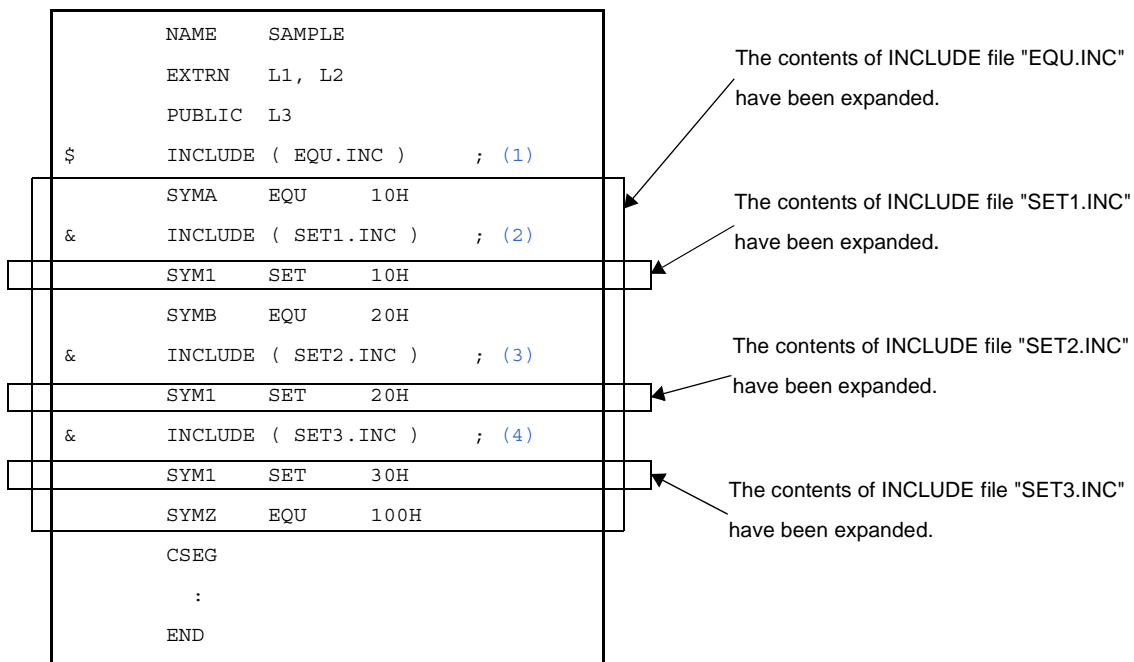

### 4.3.6 Assembly list control instructions

The assembly list control instructions are used in a source module file to control the output format of an assembly list such as page ejection, suppression of list output, and subtitle output.

The following assembly list control instructions are available.

Control Instruction	Overview
EJECT	Indicates an Assembly List page break.
LIST	Indicates starting location of output of assembly list.
NOLIST	Indicates stop location of output of assembly list.
GEN	Outputs macro definition lines, reference line and also macro-expanded lines to assembly list.
NOGEN	Does not output macro definition lines, reference line and also macro-expanded lines to assembly list.
COND	Outputs approved and failed sections of the conditional assemble to the assembly list.
NOCOND	Does not output approved and failed sections of the conditional assemble to the assembly list
TITLE	Prints character strings in the TITLE column at each page header of an assembly list, symbol table list, or cross-reference list.
SUBTITLE	Prints character strings in the SUBTITLE column at header of an assembly list.
FORMFEED	Outputs form feed at the end of a list file.
NOFORMFEED	Does not output form feed at the end of a list file.
WIDTH	Specifies the maximum number of characters for one line of a list file.
LENGTH	Specifies the number of lines for 1 page of a list file.
TAB	Specifies the number of characters for list file tabs.

**EJECT**

Indicates an assembly list page break.

**[Description Format]**

```
[Δ] $ [Δ] EJECT
[Δ] $ [Δ] EJ           ; Abbreviated format
```

**[Default Assumption]**

- EJECT control instruction is not specified.

**[Function]**

- The EJECT control instruction causes the assembler to execute page ejection (formfeed) of an assembly list.

**[Use]**

- Describe the EJECT control instruction in a line of the source module at which page ejection of the assembly list is required.

**[Description]**

- The EJECT control instruction can only be described in ordinary source programs.
- Page ejection of the assembly list is executed after the image of the EJECT control instruction itself is output.
- If the assembler option (-np) or (-llo) is specified in the startup command line or if the assembly list output is disabled by another control instruction, the EJECT control instruction becomes invalid.  
See "78K0 Build" for those assembler options.
- If an illegal description follows the EJECT control instruction, the assembler will output an error message.

**[Application example]**

```

      :
      MOV      [DE+], A
      BR      $$
$     EJECT           ; (1)
      :
      CSEG
      :
      END
```

- (1) Page ejection is executed with the EJECT control instruction.

The assemble list of the above application example is shown below.

```
      :  
      MOV      [DE+], A  
      BR      $$  
$      EJECT          ; (1)  
-----page ejection-----  
      :  
      CSEG  
      :  
      END
```

**LIST**

Indicates starting location of output of assembly list.

**[Description Format]**

```
[Δ] $ [Δ] LIST           ; Default assumption
[Δ] $ [Δ] LI            ; Abbreviated format
```

**[Function]**

- The LIST control instruction indicates to the assembler the line at which assembly list output must start.

**[Use]**

- LUse the LIST control instruction to cancel the assembly list output suppression specified by the NOLIST control instruction.
- By using a combination of NOLIST and LIST control instructions, you can control the amount of assembly list output as well as the contents of the list.

**[Description]**

- The LIST control instruction can only be described in ordinary source programs.
- If the LIST control instruction is specified after the NOLIST control instruction, statements described after the LIST control instruction will be output again on the assembly list. The image of the LIST or NOLIST control instruction will also be output on the assembly list.
- If neither the LIST nor NOLIST control instruction is specified, all statements in the source module will be output to an assembly list.

**[Application example]**

```

NAME      SAMP1
$      NOLIST           ; (1)
DATA1   EQU      10H   ; The statement will not be output to the assembly list.
DATA2   EQU      11H   ; The statement will not be output to the assembly list.
      :
DATA3   EQU      20H   ; The statement will not be output to the assembly list.
DATA4   EQU      20H   ; The statement will not be output to the assembly list.
$      LIST           ; (2)
      CSEG
      :
      END
```

- (1) Because the NOLIST control instruction is specified here, statements after "\$ NOLIST" and up to the LIST control instruction in (2) will not be output on the assembly list.**

**The image of the NOLIST control instruction itself will be output on the assembly list.**

- (2) Because the LIST control instruction is specified here, statements after this control instruction will be output again on the assembly list.

The image of the LIST control instruction itself will also be output on the assembly list.

**NOLIST**

Indicates stop location of output of assembly list.

**[Description Format]**

```
[Δ] $ [Δ] NOLIST
[Δ] $ [Δ] NOLI          ; Abbreviated format
```

**[Function]**

- The NOLIST control instruction indicates to the assembler the line at which assembly list output must be suppressed.
- All source statements described after the NOLIST control instruction specification will be assembled, but will not be output on the assembly list until the LIST control instruction appears in the source program.

**[Use]**

- Use the NOLIST control instruction to limit the amount of assembly list output.
  - Use the LIST control instruction to cancel the assembly list output suppression specified by the NOLIST control instruction.
- By using a combination of NOLIST and LIST control instructions, you can control the amount of assembly list output as well as the contents of the list.

**[Description]**

- The NOLIST control instruction can only be described in ordinary source programs.
- The NOLIST control instruction functions to suppress assembly list output and is not intended to stop the assembly process.
- If the LIST control instruction is specified after the NOLIST control instruction, statements described after the LIST control instruction will be output again on the assembly list. The image of the LIST or NOLIST control instruction will also be output on the assembly list.
- If neither the LIST nor NOLIST control instruction is specified, all statements in the source module will be output to an assembly list.

**[Application example]**

```

NAME      SAMP1
$         NOLIST          ; (1)
DATA1    EQU      10H    ; The statement will not be output to the assembly list.
DATA2    EQU      11H    ; The statement will not be output to the assembly list.
          :              ; The statement will not be output to the assembly list.
DATA3    EQU      20H    ; The statement will not be output to the assembly list.
DATA4    EQU      20H    ; The statement will not be output to the assembly list.
$         LIST           ; (2)
          CSEG
          :
          END
```



- (1) Because the NOLIST control instruction is specified here, statements after "\$ NOLIST" and up to the LIST control instruction in (2) will not be output on the assembly list.

The image of the NOLIST control instruction itself will be output on the assembly list.

- (2) Because the LIST control instruction is specified here, statements after this control instruction will be output again on the assembly list.

The image of the LIST control instruction itself will also be output on the assembly list.

**GEN**

Outputs macro definition lines, reference line and also macro-expanded lines to assembly list.

**[Description Format]**

```
[Δ] $ [Δ] GEN          ; Default assumption
```

**[Function]**

- The GEN control instruction tells the assembler to output macro definition lines, macro reference lines, and macro-expanded lines to an assembly list.

**[Use]**

- Use the GEN control instruction to limit the amount of assembly list output.

**[Description]**

- The GEN control instruction can only be described in ordinary source programs.
- If neither the GEN nor NOGEN control instruction is specified, macro definition lines, macro reference lines, and macro-expanded lines will be output to an assembly list.
- The specified list control takes place after the image of the GEN or NOGEN control instruction itself has been printed on the assembly list.
- If the GEN control instruction is specified after the NOGEN control instruction, the assembler will resume the output of macro-expanded lines.

**[Application example]**

```

NAME      SAMP
$         NOGEN          ; (1)
ADMAC    MACRO  PARA1, PARA2
          MOV    A, #PARA1
          ADD    A, #PARA2
          ENDM
          CSEG
ADMAC    10H, 20H
          END

```

The assemble list of the above application example is shown below.

```
NAME      SAMP1
$         NOGEN                               ; (1)
ADMAC    MACRO  PARA1, PARA2
          MOV    A, #PARA1
          ADD    A, #PARA2
          ENDM
          CSEG
          ADMAC  10H, 20H
          MOV    A, #10H                       ; The macro-expanded lines will not be output.
          AUD    A, #20H                       ; The macro-expanded lines will not be output.
          END
```

**(1) Because the NOGEN control instruction is specified, the macro-expanded lines will not be output to the assembly list.**

**NOGEN**

Does not output macro definition lines, reference line and also macro-expanded lines to assembly list.

**[Description Format]**

```
[Δ] $ [Δ] NOGEN
```

**[Function]**

- The NOGEN control instruction tells the assembler to output macro definition lines and macro reference lines but to suppress macro-expanded lines.

**[Use]**

- Use the NOGEN control instruction to limit the amount of assembly list output.

**[Description]**

- The NOGEN control instruction can only be described in ordinary source programs.
- If neither the GEN nor NOGEN control instruction is specified, macro definition lines, macro reference lines, and macro-expanded lines will be output to an assembly list.
- The specified list control takes place after the image of the GEN or NOGEN control instruction itself has been printed on the assembly list.
- The assembler continues its processing and increments the statement number (STNO) count even after the list output control by the NOGEN control instruction.
- If the GEN control instruction is specified after the NOGEN control instruction, the assembler will resume the output of macro-expanded lines.

**[Application example]**

```

NAME      SAMP
$         NOGEN                      ; (1)
ADMAC    MACRO  PARA1, PARA2
          MOV   A, #PARA1
          ADD  A, #PARA2
          ENDM
          CSEG
          ADMAC 10H, 20H
          END

```

The assemble list of the above application example is shown below.

```
NAME      SAMP1
$         NOGEN                               ; (1)
ADMAC    MACRO  PARA1, PARA2
          MOV    A, #PARA1
          ADD    A, #PARA2
          ENDM
          CSEG
          ADMAC  10H, 20H
          MOV    A, #10H                       ; The macro-expanded lines will not be output.
          AUD    A, #20H                       ; The macro-expanded lines will not be output.
          END
```

**(1) Because the NOGEN control instruction is specified, the macro-expanded lines will not be output to the assembly list.**

**COND**

Outputs approved and failed sections of the conditional assemble to the assembly list.

**[Description Format]**

```
[Δ] $ [Δ] COND ; Default assumption
```

**[Function]**

- The COND control instruction tells the assembler to output lines that have satisfied the conditional assembly condition as well as those which have not satisfied the conditional assembly condition to an assembly list.

**[Use]**

- Use the COND control instruction to limit the amount of assembly list output.

**[Description]**

- The COND control instruction can only be described in ordinary source programs.
- If neither the COND nor NOCOND control instruction is specified, the assembler will output lines that have satisfied the conditional assembly condition as well as those which have not satisfied the conditional assembly condition to an assembly list.
- The specified list control takes place after the image of the COND or NOCOND control instruction itself has been printed on the assembly list.
- If the COND control instruction is specified after the NOCOND control instruction, the assembler will resume the output of lines that have not satisfied the conditional assembly condition and lines in which IF/\_IF, ELSEIF/\_ELSEIF, ELSE, and ENDIF have been described.

**[Application example]**

```

NAME      SAMP
$         NOCOND
$         SET ( SW1 )
$         IF ( SW1 )                ; This part, though assembled, will not be outout
                                        ; to the list.
                MOV      A, #1H
$         ELSE                      ; This part, though assembled, will not be outout
                                        ; to the list.
                MOV      A, #0H      ; This part, though assembled, will not be outout
                                        ; to the list.
$         ENDIF                    ; This part, though assembled, will not be outout
                                        ; to the list.
         END
```

**NOCOND**

Does not output approved and failed sections of the conditional assemble to the assembly list.

**[Description Format]**

```
[Δ] $ [Δ] NOCOND
```

**[Function]**

- The NOCOND control instruction tells the assembler to output only lines that have satisfied the conditional assembly condition to an assembly list. The output of lines that have not satisfied the conditional assembly condition and lines in which IF/\_IF, ELSEIF/\_ELSEIF, ELSE, and ENDIF have been described will be suppressed.

**[Use]**

- Use the NOCOND control instruction to limit the amount of assembly list output.

**[Description]**

- The NOCOND control instruction can only be described in ordinary source programs.
- If neither the COND nor NOCOND control instruction is specified, the assembler will output lines that have satisfied the conditional assembly condition as well as those which have not satisfied the conditional assembly condition to an assembly list.
- The specified list control takes place after the image of the COND or NOCOND control instruction itself has been printed on the assembly list.
- The assembler increments the ALNO and STNO counts even after the list output control by the NOCOND control instruction.
- If the COND control instruction is specified after the NOCOND control instruction, the assembler will resume the output of lines that have not satisfied the conditional assembly condition and lines in which IF/\_IF, ELSEIF/\_ELSEIF, ELSE, and ENDIF have been described.

**[Application example]**

```

NAME      SAMP
$         NOCOND
$         SET ( SW1 )
$         IF ( SW1 )                ; This part, though assembled, will not be outout
                                        ; to the list.
                MOV      A, #1H
$         ELSE                    ; This part, though assembled, will not be outout
                                        ; to the list.
                MOV      A, #0H    ; This part, though assembled, will not be outout
                                        ; to the list.
$         ENDIF                  ; This part, though assembled, will not be outout
                                        ; to the list.
END

```

**TITLE**

Prints character strings in the TITLE column at each page header of an assembly list, symbol table list, or cross-reference list.

**[Description Format]**

```
[Δ] $ [Δ] TITLE [Δ] ( [Δ] 'title-string' [Δ] )
[Δ] $ [Δ] TT [Δ] ( [Δ] 'title-string' [Δ] ) ; Abbreviated format
```

**[Default Assumption]**

- When the TITLE control instruction is not specified, the TITLE column of the assembly list header is left blank.

**[Function]**

- The TITLE control instruction specifies the character string to be printed in the TITLE column at each page header of an assembly list, symbol table list, or cross-reference list.

**[Use]**

- Use the TITLE control instruction to print a title on each page of a list so that the contents of the list can be easily identified.
- If you need to specify a title with the assembler option at each assembly time, you can save time and labor in starting the assembler by describing this control instruction in the source module file.

**[Description]**

- The TITLE control instruction can be described only in the header section of a source module file.
- If two or more TITLE control instructions are specified at the same time, the assembler will accept only the last specified TITLE control instruction as valid.
- Up to 60 characters can be specified as the title string. If the specified title string consists of 61 or more characters, the assembler will accept only the first 60 characters of the string as valid. However, if the character length specification per line of an assembly list file (a quantity "X" ) is 119 characters or less, "X - 60 characters" will be acceptable.
- If a single quotation mark ( ' ) is to be used as part of the title string, describe the single quotation mark twice in succession.
- If no title string is specified (the number of characters in the title string = 0), the assembler will leave the TITLE column blank.
- If any character not included in "(2) Character set" is found in the specified title string, the assembler will output "!" in place of the illegal character in the TITLE column.
- A title for an assembly list can also be specified with the assembler option (-lh) in the startup command line of the assembler.



[Application example]

```

$      PROCESSOR ( 014 )
$      TITLE ( 'THIS IS TITLE' )
      NAME      SAMPLE
      CSEG
      MOV      A, B
      END
    
```

The assemble list of the above application example is shown below. (with the number of lines per page specified as 72).

```

78K0 Series Assembler Vx.xx   THIS IS TITLE   Date:xx xxx xxxx   Page : 1

Command :      sample.asm
Para-file :
In-file  :      sample.asm
Obj-file :      sample.rel
Prn-file :      sample.prn

      Assemble list

ALNO   STNO   ADRS   OBJECT  M I   SOURCE STATEMENT

  1     1           $      PROCESSOR ( 014 )
  2     2           $      TITLE ( 'THIS IS TITLE' )
  3     3           NAME      SAMPLE
  4     4     ----   CSEG
  5     5     0000   63     MOV      A, B
  6     6           END

Segment information :

ADRS   LEN     NAME

0000   0001H   ?CSEG

Target chip : uPD78014
Device file : Vx.xx
Assembly complete, 0 error(s) and 0 warning(s) found. (0)
    
```

**SUBTITLE**

Prints character strings in the SUBTITLE column at header of an assembly list.

**[Description Format]**

```
[Δ] $ [Δ] SUBTITLE [Δ] ( [Δ] 'title-string' [Δ] )
[Δ] $ [Δ] ST [Δ] ( [Δ] 'title-string' [Δ] ) ; Abbreviated format
```

**[Default Assumption]**

- When the SUBTITLE control instruction is not specified, the SUBTITLE section of the assembly list header is left blank.

**[Function]**

- The SUBTITLE control instruction specifies the character string to be printed in the SUBTITLE section at each page header of an assembly list.

**[Use]**

- Use the SUBTITLE control instruction to print a subtitle on each page of an assembly list so that the contents of the assembly list can be easily identified.  
The character string of a subtitle may be changed for each page.

**[Description]**

- The SUBTITLE control instruction can only be described in ordinary source programs.
- Up to 72 characters can be specified as the subtitle string.  
If the specified title string consists of 73 or more characters, the assembler will accept only the first 72 characters of the string as valid. A 2-byte character is counted as two characters, and tab is counted as one character.
- The character string specified with the SUBTITLE control instruction will be printed in the SUBTITLE section on the page after the page on which the SUBTITLE control instruction has been specified. However, if the control instruction is specified at the top (first line) of a page, the subtitle will be printed on that page.
- If the SUBTITLE control instruction has not been specified, the assembler will leave the SUBTITLE section blank.
- If a single quotation mark ( ' ) is to be used as part of the character string, describe the single quotation mark twice in succession.
- If the character string in the SUBTITLE section is 0, the SUBTITLE column will be left blank.
- If any character not included in "(2) Character set" is found in the specified subtitle string, the assembler will output "!" in place of the illegal character in the SUBTITLE column. If CR (ODH) is described, an error occurs and nothing will be output in the assembly list. If 00H is described, nothing from that point to the closing single quotation mark ( ' ) will be output.

[Application example]

```

NAME      SAMP
CSEG
$  SUBTITLE ( 'THIS IS SUBTITLE 1' )      ; (1)
$  EJECT                                  ; (2)
CSEG
$  SUBTITLE ( 'THIS IS SUBTITLE 2' )      ; (3)
$  EJECT                                  ; (4)
$  SUBTITLE ( 'THIS IS SUBTITLE 3' )      ; (5)
END
    
```

- (1) This control instruction specifies the character string "THIS IS SUBTITLE 1".
- (2) This control instruction specifies a page ejection.
- (3) This control instruction specifies the character string "THIS IS SUBTITLE 2".
- (4) This control instruction specifies a page ejection.
- (5) This control instruction specifies the character string "THIS IS SUBTITLE 3".

The assembly list for this example appears as follows (with the number of lines per page specified as 80).

```

78K0 Series Assembler Vx.xx                      Date : xx xxx xxxx Page : 1

Command :      -c014 sample.asm
Para-file :
In-file  :      sample.asm
Obj-file  :      sample.rel
Prn-file  :      sample.prn
          Assemble list

ALNO  STNO  ADRS  OBJECT  M I SOURCE STATEMENT

 1    1           NAME SAMP
 2    2  ----           CSEG
 3    3           $  SUBTITLE ( 'THIS IS SUBTITLE 1' )      ; (1)
 4    4           $  EJECT                                  ; (2)
-----page ejection-----
78K0 Series Assembler Vx.xx                      Date:xx xxx xxxx Page: 2

THIS IS SUBTITLE 1

ALNO  STNO  ADRS  OBJECT  M I SOURCE STATEMENT
    
```

```
5      5      ----          CSEG
6      6          $  SUBTITLE ( 'THIS IS SUBTITLE 2' ) ; (3)
7      7          $  EJECT                               ; (4)

-----page ejection-----
78K0 Series Assembler Vx.xx          Date:xx xxx xxxx Page: 3

THIS IS SUBTITLE 2

ALNO  STNO  ADRS  OBJECT  M I SOURCE STATEMENT

8      8          $  SUBTITLE ( 'THIS IS SUBTITLE 3' ) ; (5)
9      9          END

Target chip : uPD78014
Device file : Vx.xx

Assembly complete, 0 error(s) and 0 warning(s) found. (0)
```

**FORMFEED**

Outputs form feed at the end of a list file.

**[Description Format]**

```
[Δ] $ [Δ] FORMFEED
```

**[Function]**

- The FORMFEED control instruction tells the assembler to output a FORMFEED code at the end of an assembly list file.

**[Use]**

- Use the FORMFEED control instruction when you want to start a new page after printing the contents of an assembly list file.

**[Description]**

- The FORMFEED control instruction can be described only in the header section of a source module file.
- At the time of printing an assembly list, the last page of the list may not come out if printing ends in the middle of a page.  
In such a case, add a FORMFEED code to the end of the assembly list using the FORMFEED control instruction or assembler option (-lf).
- In many cases, a FORMFEED code will be output at the end of a file. For this reason, if a FORMFEED code exists at the end of a list file, an unwanted white page may be ejected. To prevent this, the NOFORMFEED control instruction or assembler option (-nlf) has been set by default value.
- If two or more FORMFEED/NOFORMFEED control instructions are specified at the same time, only the last specified control instruction will become valid.
- The output or non-output of a formfeed code may also be specified with the assembler option (-lf) or (-nlf) in the startup command line of the assembler.
- If the control instruction specification (FORMFEED/NOFORMFEED) in the source module differs from the specification (-lf/-nlf) in the startup command line, the specification in the startup command line will take precedence over that in the source module.
- Even when the assembler option (-np) has been specified in the startup command line, the assembler performs a syntax check on the FORMFEED or NOFORMFEED control instruction.

**NOFORMFEED**

Does not output form feed at the end of a list file.

**[Description Format]**

```
[Δ] $ [Δ] NOFORMFEED ; Default assumption
```

**[Function]**

- The NOFORMFEED control instruction tells the assembler not to output a FORMFEED code at the end of an assembly list file.

**[Use]**

- Use the FORMFEED control instruction when you want to start a new page after printing the contents of an assembly list file.

**[Description]**

- The NOFORMFEED control instruction can be described only in the header section of a source module file.
- At the time of printing an assembly list, the last page of the list may not come out if printing ends in the middle of a page.  
In such a case, add a FORMFEED code to the end of the assembly list using the FORMFEED control instruction or assembler option (-lf).  
In many cases, a FORMFEED code will be output at the end of a file. For this reason, if a FORMFEED code exists at the end of a list file, an unwanted white page may be ejected. To prevent this, the NOFORMFEED control instruction or assembler option (-nlf) has been set by default value.
- If two or more FORMFEED/NOFORMFEED control instructions are specified at the same time, only the last specified control instruction will become valid.
- The output or non-output of a formfeed code may also be specified with the assembler option (-lf) or (-nlf) in the startup command line of the assembler.
- If the control instruction specification (FORMFEED/NOFORMFEED) in the source module differs from the specification (-lf/-nlf) in the startup command line, the specification in the startup command line will take precedence over that in the source module.
- Even when the assembler option (-np) has been specified in the startup command line, the assembler performs a syntax check on the FORMFEED or NOFORMFEED control instruction.

**WIDTH**

Specifies the maximum number of characters for one line of a list file.

**[Description Format]**

```
[Δ] $ [Δ] WIDTH [Δ] ( [Δ] columns-per-line [Δ] )
```

**[Default Assumption]**

\$WIDTH ( 132 )

**[Function]**

- The WIDTH control instruction specifies the number of columns (characters) per line of a list file. "columns-per-line" must be a value in the range of 72 to 260.

**[Use]**

- Use the WIDTH control instruction when you want to change the number of columns per line of a list file.

**[Description]**

- The WIDTH control instruction can be described only in the header section of a source module file.
- If two or more WIDTH control instructions are specified at the same time, only the last specified control instruction will become valid.
- The number of columns per line of a list file may also be specified with the assembler option (-lw) in the startup command line of the assembler.
- If the control instruction specification (WIDTH) in the source module differs from the specification (-lw) in the startup command line, the specification in the command line will take precedence over that in the source module.
- Even when the assembler option (-np) has been specified in the startup command line, the assembler performs a syntax check on the WIDTH control instruction.

**LENGTH**

Specifies the number of lines for 1 page of a list file

**[Description Format]**

```
[Δ] $ [Δ] LENGTH [Δ] ( [Δ] lines-per-page [Δ] )
```

**[Default Assumption]**

\$LENGTH ( 66 )

**[Function]**

- The LENGTH control instruction specifies the number of lines per page of a list file. "lines-per-page" may be "0" or a value in the range of 20 to 32767.

**[Use]**

- Use the LENGTH control instruction when you want to change the number of lines per page of a list file.

**[Description]**

- The LENGTH control instruction can be described only in the header section of a source module file.
- If two or more LENGTH control instructions are specified at the same time, only the last specified control instruction will become valid.
- The number of columns per line of a list file may also be specified with the assembler option (-ll) in the startup command line of the assembler.
- If the control instruction specification (LENGTH) in the source module differs from the specification (-ll) in the startup command line, the specification in the command line will take precedence over that in the source module.
- Even when the assembler option (-np) has been specified in the startup command line, the assembler performs a syntax check on the LENGTH control instruction.



**TAB**

Specifies the number of characters for list file tabs.

**[Description Format]**

```
[Δ] $ [Δ] TAB [Δ] ( [Δ] number-of-columns [Δ] )
```

**[Default Assumption]**

\$TAB ( 8 )

**[Function]**

- The TAB control instruction specifies the number of columns as tab stops on a list file.  
"number-of-columns" may be a value in the range of 0 to 8.
- The TAB control instruction specifies the number of columns that becomes the basis of tabulation processing to output any list by replacing a HT (Horizontal Tabulation) code in a source module with several blank characters on the list.

**[Use]**

- Use HT code to reduce the number of blanks when the number of characters per line of any list is reduced using the TAB control instruction.

**[Description]**

- The TAB control instruction can be described only in the header section of a source module file.
- If two or more TAB control instructions are specified at the same time, only the last specified control instruction will become valid.
- The number of tab stops may also be specified with the assembler option (-lt) in the startup command line of the assembler.
- If the control instruction specification (TAB) in the source module differs from the specification (-lt) in the startup command line, the specification in the command line will take precedence over that in the source module.
- Even when the assembler option (-np) has been specified in the startup command line, the assembler performs a syntax check on the TAB control instruction.

4.3.7 Conditional assembly control instructions

Conditional assembly control instructions select, with the conditional assemble switch, whether to make a series of statements in the source module into an assemble target or not.

If conditional assemble instructions are made effective, it is possible to assemble without unnecessary statements and hardly changing the source module.

The following conditional assembly control instructions are available.

Control Instruction	Overview
IF	Sets conditions in order to limit the assembly target source statements.
_IF	
ELSEIF	
_ELSEIF	
ELSE	
ENDIF	
SET	Sets value for switch name specified by IF/ELSEIF control instruction.
RESET	

**IF**

Sets conditions in order to limit the assembly target source statements.

**[Description Format]**

```
[Δ] $ [Δ] IF [Δ] ( [Δ] switch-name [ [Δ] : [Δ] switch-name ] ... [Δ] )
      :
[Δ] $ [Δ] ELSEIF [Δ] ( [Δ] switch-name [ [Δ] : [Δ] switch-name ] ... [Δ] )
      :
[Δ] $ [Δ] ELSE
      :
[Δ] $ [Δ] ENDIF
```

**[Function]**

- The control instructions set the conditions to limit source statements subject to assembly. Source statements described between the IF control instruction and the ENDIF control instruction are subject to conditional assembly.
- If the evaluated value of the conditional expression or the switch name specified by the IF control instruction (i.e., IF or `_IF` condition) is true (other than 00H), source statements described after this IF control instruction until the appearance of the next conditional assembly control instruction (ELSEIF/ `_ELSEIF`, ELSE, or ENDIF) in the source program will be assembled. For subsequent assembly processing, the assembler will proceed to the statement next to the ENDIF control instruction.  
If the IF condition is false (00H), source statements described after this IF control instruction until the appearance of the next conditional assembly control instruction (ELSEIF/ `_ELSEIF`, ELSE, or ENDIF) in the source program will not be assembled.
- The ELSEIF or `_ELSEIF` control instruction is checked for true/false status only when the conditions of all the conditional assembly control instructions described before this ELSEIF or `_ELSEIF` control instruction are not satisfied (i.e. the evaluated values are false).  
If the evaluated value of the conditional expression or the switch name specified by the ELSEIF or `_ELSEIF` control instruction (i.e. ELSEIF or `_ELSEIF` condition) is true, source statements described after this ELSEIF or `_ELSEIF` control instruction until the appearance of the next conditional assembly control instruction (ELSEIF/ `_ELSEIF`, ELSE, or ENDIF) in the source program will be assembled. For subsequent assembly processing, the assembler will proceed to the statement next to the ENDIF control instruction.  
If the ELSEIF or `_ELSEIF` condition is false, source statements described after this ELSEIF or `_ELSEIF` control instruction until the appearance of the next conditional assembly control instruction (ELSEIF/ `_ELSEIF`, ELSE, or ENDIF) in the source program will not be assembled.
- If the conditions of all the IF/ `_IF` and ELSEIF/ `_ELSEIF` control instructions described before the ELSE control instruction are not satisfied (i.e., all the switch names are false), source statements described after this ELSE control instruction until the appearance of the ENDIF control instruction in the source program will be assembled.
- The ENDIF control instruction indicates to the assembler the termination of source statements subject to conditional assembly.

**[Use]**

- With these conditional assembly control instructions, source statements subject to assembly can be changed without major modifications to the source program.
- If a statement for debugging that becomes necessary only during the program development is described in a source program, whether or not the debugging statement should be assembled (translated into machine language) can be specified by setting switches for conditional assembly.

**[Description]**

- The IF and ELSEIF control instructions are used for true/false condition judgment with switch name(s), whereas the \_IF and \_ELSEIF control instructions are used for true/false condition judgment with a conditional expression. Both IF/ELSEIF and \_IF/\_ELSEIF may be used in combination. In other words, ELSEIF/\_ELSEIF may be used in a pair with IF or \_IF and ENDIF.
- Describe absolute expression for a conditional expression.
- The rules of describing switch names are the same as the conventions of symbol description (for details, see "(3) Symbol field" ).

However, the maximum number of characters that can be recognized as a switch name is always 31.

- If the two or more switch names are to be specified with the IF or ELSEIF control instruction, delimit each switch name with a colon ( : ).  
Up to five switch names can be used per module
- When two or more switch names have been specified with the IF or ELSEIF control instruction, the IF or ELSEIF condition is judged to be satisfied if one of the switch name values is true.
- The value of each switch name to be specified with the IF or ELSEIF control instruction must be defined with the SET/RESET control instruction.  
Therefore, if the value of the switch name specified with the IF or ELSEIF control instruction is not set in the source module with the SET or RESET control instruction in advance, it is assumed to be reset.
- If the specified switch name or conditional expression contains an illegal description, the assembler will output an error message and determine that the evaluated value is false.
- When describing the IF or \_IF control instruction, the IF or \_IF control instruction must always be paired with the ENDIF control instruction.
- If an IF-ENDIF block is described in a macro body and control is transferred back from the macro at that level by EXITM processing, the assembler will force the IF level to return to that level at the entry of the macro body. In this case, no error occurs.
- Description of an IF-ENDIF block in another IF-ENDIF block is referred to as nesting of IF control instructions. Nesting of IF control instructions is allowed up to 8 levels.
- In conditional assembly, object codes will not be generated for statements not assembled, but these statements will be output without change on the assembly list. If you do not wish to output these statements, use the \$NOCOND control instruction.

**[Application example]**

- Example 1

```

        text0
$      IF ( SW1 )          ; (1)
                text1
$      ENDIF              ; (2)
        :
        END

```

- (1) If the value of switch name "SW1" is true, statements in "text1" will be assembled.  
If the value of switch name "SW1" is false, statements in "text1" will not be assembled.  
The value of switch name "SW1" has been set to true or false with the SET or RESET control instruction described in "text0".
- (2) This instruction indicates the end of the source statement range for conditional assembly.

- Example 2

```

text0
$   IF ( SW1 )           ; (1)
      text1
$   ELSE                 ; (2)
      text2
$   ENDIF                ; (3)
      :
      END

```

- (1) The value of switch name "SW1" has been set to true or false with the SET or RESET control instruction described in "text0".  
If the value of switch name "SW1" is true, statements in "text1" will be assembled and statements in "text2" will not be assembled.
- (2) If the value of switch name "SW1" in (1) is false, statements in "text1" will not be assembled and statements in "text2" will be assembled.
- (3) This instruction indicates the end of the source statement range for conditional assembly.

- Example 3

```

text0
$   IF ( SW1 : SW2 )     ; (1)
      text1
$   ELSEIF ( SW3 )      ; (2)
      text2
$   ELSEIF ( SW4 )      ; (3)
      text3
$   ELSE                 ; (4)
      text4
$   ENDIF                ; (5)
      :
      END

```

- (1) The values of switch names "SW1", "SW2", and "SW3" have been set to true or false with the SET or RESET control instruction described in "text0".  
If the value of switch name "SW1" or "SW2" is true, statements in "text1" will be assembled and statements in "text2", "text3", and "text4" will not be assembled.

If the values of switch names "SW1" and "SW2" are false, statements in "text1" will not be assembled and statements after (2) will be conditionally assembled.

- (2) If the values of switch names "SW1" and "SW2" in (1) are false and the value of switch name "SW3" is true, statements in "text2" will be assembled and statements in "text1", "text3", and "text4" will not be assembled.
- (3) If the values of switch names "SW1" and "SW2" in (1) and "SW3" in (2) are false and the value of switch statements in "text4" will be assembled and statements in "text1", "text2", and "text3" will not be will not be assembled.
- (4) If the values of switch names "SW1" and "SW2" in (1), "SW3" in (2), and "SW4" in (3) are all false, statements in "text4" will be assembled and statements in "text1", "text2", and "text3" will not be assembled.
- (5) This instruction indicates the end of the source statement range for conditional assembly.

**\_IF**

Sets conditions in order to limit the assembly target source statements.

**[Description Format]**

```
[Δ] $ [Δ] _IF Δ conditional-expression
      :
[Δ] $ [Δ] _ELSEIF Δ conditional-expression
      :
[Δ] $ [Δ] ELSE
      :
[Δ] $ [Δ] ENDIF
```

**[Function]**

- The control instructions set the conditions to limit source statements subject to assembly. Source statements described between the \_IF control instruction and the ENDIF control instruction are subject to conditional assembly.
- If the evaluated value of the conditional expression or the switch name specified by the \_IF control instruction (i.e., IF or \_IF condition) is true (other than 00H), source statements described after this \_IF control instruction until the appearance of the next conditional assembly control instruction (ELSEIF/ \_ELSEIF, ELSE, or ENDIF) in the source program will be assembled. For subsequent assembly processing, the assembler will proceed to the statement next to the ENDIF control instruction.  
If the \_IF condition is false (00H), source statements described after this \_IF control instruction until the appearance of the next conditional assembly control instruction (ELSEIF/ \_ELSEIF, ELSE, or ENDIF) in the source program will not be assembled.
- The ELSEIF or \_ELSEIF control instruction is checked for true/false status only when the conditions of all the conditional assembly control instructions described before this ELSEIF or \_ELSEIF control instruction are not satisfied (i.e. the evaluated values are false).  
If the evaluated value of the conditional expression or the switch name specified by the ELSEIF or \_ELSEIF control instruction (i.e. ELSEIF or \_ELSEIF condition) is true, source statements described after this ELSEIF or \_ELSEIF control instruction until the appearance of the next conditional assembly control instruction (ELSEIF/ \_ELSEIF, ELSE, or ENDIF) in the source program will be assembled. For subsequent assembly processing, the assembler will proceed to the statement next to the ENDIF control instruction.  
If the ELSEIF or \_ELSEIF condition is false, source statements described after this ELSEIF or \_ELSEIF control instruction until the appearance of the next conditional assembly control instruction (ELSEIF/ \_ELSEIF, ELSE, or ENDIF) in the source program will not be assembled.
- If the conditions of all the IF/\_IF and ELSEIF/\_ELSEIF control instructions described before the ELSE control instruction are not satisfied (i.e., all the switch names are false), source statements described after this ELSE control instruction until the appearance of the ENDIF control instruction in the source program will be assembled.
- The ENDIF control instruction indicates to the assembler the termination of source statements subject to conditional assembly.

**[Use]**

- With these conditional assembly control instructions, source statements subject to assembly can be changed without major modifications to the source program.
- If a statement for debugging that becomes necessary only during the program development is described in a source program, whether or not the debugging statement should be assembled (translated into machine language) can be specified by setting switches for conditional assembly.

**[Description]**

- The IF and ELSEIF control instructions are used for true/false condition judgment with switch name(s), whereas the \_IF and \_ELSEIF control instructions are used for true/false condition judgment with a conditional expression. Both IF/ELSEIF and \_IF/\_ELSEIF may be used in combination. In other words, ELSEIF/\_ELSEIF may be used in a pair with IF or \_IF and ENDIF.
- Describe absolute expression for a conditional expression.
- The rules of describing switch names are the same as the conventions of symbol description (for details, see "(3) Symbol field" ).

However, the maximum number of characters that can be recognized as a switch name is always 31.

- If the two or more switch names are to be specified with the IF or ELSEIF control instruction, delimit each switch name with a colon ( : ).  
Up to five switch names can be used per module
- When two or more switch names have been specified with the IF or ELSEIF control instruction, the IF or ELSEIF condition is judged to be satisfied if one of the switch name values is true.
- The value of each switch name to be specified with the IF or ELSEIF control instruction must be defined with the SET/RESET control instruction.  
Therefore, if the value of the switch name specified with the IF or ELSEIF control instruction is not set in the source module with the SET or RESET control instruction in advance, it is assumed to be reset.
- If the specified switch name or conditional expression contains an illegal description, the assembler will output an error message and determine that the evaluated value is false.
- When describing the IF or \_IF control instruction, the IF or \_IF control instruction must always be paired with the ENDIF control instruction.
- If an IF-ENDIF block is described in a macro body and control is transferred back from the macro at that level by EXITM processing, the assembler will force the IF level to return to that level at the entry of the macro body. In this case, no error occurs.
- Description of an IF-ENDIF block in another IF-ENDIF block is referred to as nesting of IF control instructions. Nesting of IF control instructions is allowed up to 8 levels.
- In conditional assembly, object codes will not be generated for statements not assembled, but these statements will be output without change on the assembly list. If you do not wish to output these statements, use the \$NOCOND control instruction.

**[Application example]**

```

text0
$   _IF ( SYMA )           ; (1)
      text1
$   _ELSEIF ( SYMB = SYMC ) ; (2)
      text2
$   ENDIF                 ; (3)
      :
      END

```



- (1) The value of switch name "SYMA" has been defined with the EQU or SET directive described in "text0". If the symbol name "SYMA" is true (not "0" ), statements in "text1" will be assembled and "text2" will not be assembled.
- (2) If the value of the symbol name "SYMA" is "0", and "SYMB" and "SYMC" have the same value, statements in "text2" will be assembled.
- (3) This instruction indicates the end of the source statement range for conditional assembly.

**ELSEIF**

Sets conditions in order to limit the assembly target source statements.

**[Description Format]**

```
[Δ] $ [Δ] IF [Δ] ( [Δ] switch-name [ [Δ] : [Δ] switch-name ] ... [Δ] )
      :
[Δ] $ [Δ] ELSEIF [Δ] ( [Δ] switch-name [ [Δ] : [Δ] switch-name ] ... [Δ] )
      :
[Δ] $ [Δ] ELSE
      :
[Δ] $ [Δ] ENDIF
```

**[Function]**

- The control instructions set the conditions to limit source statements subject to assembly. Source statements described between the IF or \_IF control instruction and the ENDIF control instruction are subject to conditional assembly.
- If the evaluated value of the conditional expression or the switch name specified by the IF or \_IF control instruction (i.e., IF or \_IF condition) is true (other than 00H), source statements described after this IF or \_IF control instruction until the appearance of the next conditional assembly control instruction (ELSEIF/ \_ELSEIF, ELSE, or ENDIF) in the source program will be assembled. For subsequent assembly processing, the assembler will proceed to the statement next to the ENDIF control instruction.  
If the IF or \_IF condition is false (00H), source statements described after this IF or \_IF control instruction until the appearance of the next conditional assembly control instruction (ELSEIF/ \_ELSEIF, ELSE, or ENDIF) in the source program will not be assembled.
- The ELSEIF or \_ELSEIF control instruction is checked for true/false status only when the conditions of all the conditional assembly control instructions described before this ELSEIF or \_ELSEIF control instruction are not satisfied (i.e. the evaluated values are false).  
If the evaluated value of the conditional expression or the switch name specified by the ELSEIF or \_ELSEIF control instruction (i.e. ELSEIF or \_ELSEIF condition) is true, source statements described after this ELSEIF or \_ELSEIF control instruction until the appearance of the next conditional assembly control instruction (ELSEIF/ \_ELSEIF, ELSE, or ENDIF) in the source program will be assembled. For subsequent assembly processing, the assembler will proceed to the statement next to the ENDIF control instruction.  
If the ELSEIF or \_ELSEIF condition is false, source statements described after this ELSEIF or \_ELSEIF control instruction until the appearance of the next conditional assembly control instruction (ELSEIF/ \_ELSEIF, ELSE, or ENDIF) in the source program will not be assembled.
- If the conditions of all the IF/\_IF and ELSEIF/\_ELSEIF control instructions described before the ELSE control instruction are not satisfied (i.e., all the switch names are false), source statements described after this ELSE control instruction until the appearance of the ENDIF control instruction in the source program will be assembled.
- The ENDIF control instruction indicates to the assembler the termination of source statements subject to conditional assembly.

**[Use]**

- With these conditional assembly control instructions, source statements subject to assembly can be changed without major modifications to the source program.
- If a statement for debugging that becomes necessary only during the program development is described in a source program, whether or not the debugging statement should be assembled (translated into machine language) can be specified by setting switches for conditional assembly.

**[Description]**

- The IF and ELSEIF control instructions are used for true/false condition judgment with switch name(s), whereas the \_IF and \_ELSEIF control instructions are used for true/false condition judgment with a conditional expression. Both IF/ELSEIF and \_IF/\_ELSEIF may be used in combination. In other words, ELSEIF/\_ELSEIF may be used in a pair with IF or \_IF and ENDIF.
- Describe absolute expression for a conditional expression.
- The rules of describing switch names are the same as the conventions of symbol description (for details, see "(3) Symbol field" ).  
However, the maximum number of characters that can be recognized as a switch name is always 31.
- If the two or more switch names are to be specified with the IF or ELSEIF control instruction, delimit each switch name with a colon ( : ).  
Up to five switch names can be used per module
- When two or more switch names have been specified with the IF or ELSEIF control instruction, the IF or ELSEIF condition is judged to be satisfied if one of the switch name values is true.
- The value of each switch name to be specified with the IF or ELSEIF control instruction must be defined with the SET/RESET control instruction.  
Therefore, if the value of the switch name specified with the IF or ELSEIF control instruction is not set in the source module with the SET or RESET control instruction in advance, it is assumed to be reset.
- If the specified switch name or conditional expression contains an illegal description, the assembler will output an error message and determine that the evaluated value is false.
- When describing the IF or \_IF control instruction, the IF or \_IF control instruction must always be paired with the ENDIF control instruction.
- If an IF-ENDIF block is described in a macro body and control is transferred back from the macro at that level by EXITM processing, the assembler will force the IF level to return to that level at the entry of the macro body. In this case, no error occurs.
- Description of an IF-ENDIF block in another IF-ENDIF block is referred to as nesting of IF control instructions. Nesting of IF control instructions is allowed up to 8 levels.
- In conditional assembly, object codes will not be generated for statements not assembled, but these statements will be output without change on the assembly list. If you do not wish to output these statements, use the \$NOCOND control instruction.

**[Application example]**

```
text0
$   IF ( SW1 : SW2 )           ; (1)
    text1
$   ELSEIF ( SW3 )           ; (2)
    text2
$   ELSEIF ( SW4 )           ; (3)
    text3
$   ELSE                       ; (4)
    text4
$   ENDIF                     ; (5)
    :
    END
```

- (1) The values of switch names "SW1", "SW2", and "SW3" have been set to true or false with the SET or RESET control instruction described in "text0".  
If the value of switch name "SW1" or "SW2" is true, statements in "text1" will be assembled and statements in "text2", "text3", and "text4" will not be assembled.  
If the values of switch names "SW1" and "SW2" are false, statements in "text1" will not be assembled and statements after (2) will be conditionally assembled.
- (2) If the values of switch names "SW1" and "SW2" in (1) are false and the value of switch name "SW3" is true, statements in "text2" will be assembled and statements in "text1", "text3", and "text4" will not be assembled.
- (3) If the values of switch names "SW1" and "SW2" in (1) and "SW3" in (2) are false and the value of switch statements in "text4" will be assembled and statements in "text1", "text2", and "text3" will not be will not be assembled.
- (4) If the values of switch names "SW1" and "SW2" in (1), "SW3" in (2), and "SW4" in (3) are all false, statements in "text4" will be assembled and statements in "text1", "text2", and "text3" will not be assembled.
- (5) This instruction indicates the end of the source statement range for conditional assembly.

**\_ELSEIF**

Sets conditions in order to limit the assembly target source statements.

**[Description Format]**

```
[Δ] $ [Δ] _IFΔconditional-expression
      :
[Δ] $ [Δ] _ELSEIFΔconditional-expression
      :
[Δ] $ [Δ] ELSE
      :
[Δ] $ [Δ] ENDIF
```

**[Function]**

- The control instructions set the conditions to limit source statements subject to assembly. Source statements described between the IF or \_IF control instruction and the ENDIF control instruction are subject to conditional assembly.
- If the evaluated value of the conditional expression or the switch name specified by the IF or \_IF control instruction (i.e., IF or \_IF condition) is true (other than 00H), source statements described after this IF or \_IF control instruction until the appearance of the next conditional assembly control instruction (ELSEIF/ \_ELSEIF, ELSE, or ENDIF) in the source program will be assembled. For subsequent assembly processing, the assembler will proceed to the statement next to the ENDIF control instruction.  
If the IF or \_IF condition is false (00H), source statements described after this IF or \_IF control instruction until the appearance of the next conditional assembly control instruction (ELSEIF/ \_ELSEIF, ELSE, or ENDIF) in the source program will not be assembled.
- The ELSEIF or \_ELSEIF control instruction is checked for true/false status only when the conditions of all the conditional assembly control instructions described before this ELSEIF or \_ELSEIF control instruction are not satisfied (i.e. the evaluated values are false).  
If the evaluated value of the conditional expression or the switch name specified by the ELSEIF or \_ELSEIF control instruction (i.e. ELSEIF or \_ELSEIF condition) is true, source statements described after this ELSEIF or \_ELSEIF control instruction until the appearance of the next conditional assembly control instruction (ELSEIF/ \_ELSEIF, ELSE, or ENDIF) in the source program will be assembled. For subsequent assembly processing, the assembler will proceed to the statement next to the ENDIF control instruction.  
If the ELSEIF or \_ELSEIF condition is false, source statements described after this ELSEIF or \_ELSEIF control instruction until the appearance of the next conditional assembly control instruction (ELSEIF/ \_ELSEIF, ELSE, or ENDIF) in the source program will not be assembled.
- If the conditions of all the IF/\_IF and ELSEIF/\_ELSEIF control instructions described before the ELSE control instruction are not satisfied (i.e., all the switch names are false), source statements described after this ELSE control instruction until the appearance of the ENDIF control instruction in the source program will be assembled.
- The ENDIF control instruction indicates to the assembler the termination of source statements subject to conditional assembly.

**[Use]**

- With these conditional assembly control instructions, source statements subject to assembly can be changed without major modifications to the source program.
- If a statement for debugging that becomes necessary only during the program development is described in a source program, whether or not the debugging statement should be assembled (translated into machine language) can be specified by setting switches for conditional assembly.

**[Description]**

- The IF and ELSEIF control instructions are used for true/false condition judgment with switch name(s), whereas the \_IF and \_ELSEIF control instructions are used for true/false condition judgment with a conditional expression. Both IF/ELSEIF and \_IF/\_ELSEIF may be used in combination. In other words, ELSEIF/\_ELSEIF may be used in a pair with IF or \_IF and ENDIF.
- Describe absolute expression for a conditional expression.
- The rules of describing switch names are the same as the conventions of symbol description (for details, see "(3) Symbol field" ).

However, the maximum number of characters that can be recognized as a switch name is always 31.

- If the two or more switch names are to be specified with the IF or ELSEIF control instruction, delimit each switch name with a colon ( : ).  
Up to five switch names can be used per module
- When two or more switch names have been specified with the IF or ELSEIF control instruction, the IF or ELSEIF condition is judged to be satisfied if one of the switch name values is true.
- The value of each switch name to be specified with the IF or ELSEIF control instruction must be defined with the SET/RESET control instruction.  
Therefore, if the value of the switch name specified with the IF or ELSEIF control instruction is not set in the source module with the SET or RESET control instruction in advance, it is assumed to be reset.
- If the specified switch name or conditional expression contains an illegal description, the assembler will output an error message and determine that the evaluated value is false.
- When describing the IF or \_IF control instruction, the IF or \_IF control instruction must always be paired with the ENDIF control instruction.
- If an IF-ENDIF block is described in a macro body and control is transferred back from the macro at that level by EXITM processing, the assembler will force the IF level to return to that level at the entry of the macro body. In this case, no error occurs.
- Description of an IF-ENDIF block in another IF-ENDIF block is referred to as nesting of IF control instructions. Nesting of IF control instructions is allowed up to 8 levels.
- In conditional assembly, object codes will not be generated for statements not assembled, but these statements will be output without change on the assembly list. If you do not wish to output these statements, use the \$NOCOND control instruction.

**[Application example]**

```

text0
$   _IF ( SYMA )           ; (1)
      text1
$   _ELSEIF ( SYMB = SYMC ) ; (2)
      text2
$   ENDIF                 ; (3)
      :
      END

```

- (1) The value of switch name "SYMA" has been defined with the EQU or SET directive described in "text0". If the symbol name "SYMA" is true (not "0" ), statements in "text1" will be assembled and "text2" will not be assembled.
- (2) If the value of the symbol name "SYMA" is "0", and "SYMB" and "SYMC" have the same value, statements in "text2" will be assembled.
- (3) This instruction indicates the end of the source statement range for conditional assembly.

**ELSE**

Sets conditions in order to limit the assembly target source statements.

**[Description Format]**

```
[Δ] $ [Δ] IF [Δ] ( [Δ] switch-name [ [Δ] : [Δ] switch-name ] ... [Δ] )
or [Δ] $ [Δ] _IF conditional-expression
:
[Δ] $ [Δ] ELSEIF [Δ] ( [Δ] switch-name [ [Δ] : [Δ] switch-name ] ... [Δ] )
or [Δ] $ [Δ] _ELSEIF conditional-expression
:
[Δ] $ [Δ] ELSE
:
[Δ] $ [Δ] ENDIF
```

**[Function]**

- The control instructions set the conditions to limit source statements subject to assembly. Source statements described between the IF or \_IF control instruction and the ENDIF control instruction are subject to conditional assembly.
- If the evaluated value of the conditional expression or the switch name specified by the IF or \_IF control instruction (i.e., IF or \_IF condition) is true (other than 00H), source statements described after this IF or \_IF control instruction until the appearance of the next conditional assembly control instruction (ELSEIF/ \_ELSEIF, ELSE, or ENDIF) in the source program will be assembled. For subsequent assembly processing, the assembler will proceed to the statement next to the ENDIF control instruction.  
If the IF or \_IF condition is false (00H), source statements described after this IF or \_IF control instruction until the appearance of the next conditional assembly control instruction (ELSEIF/ \_ELSEIF, ELSE, or ENDIF) in the source program will not be assembled.
- The ELSEIF or \_ELSEIF control instruction is checked for true/false status only when the conditions of all the conditional assembly control instructions described before this ELSEIF or \_ELSEIF control instruction are not satisfied (i.e. the evaluated values are false).  
If the evaluated value of the conditional expression or the switch name specified by the ELSEIF or \_ELSEIF control instruction (i.e. ELSEIF or \_ELSEIF condition) is true, source statements described after this ELSEIF or \_ELSEIF control instruction until the appearance of the next conditional assembly control instruction (ELSEIF/ \_ELSEIF, ELSE, or ENDIF) in the source program will be assembled. For subsequent assembly processing, the assembler will proceed to the statement next to the ENDIF control instruction.  
If the ELSEIF or \_ELSEIF condition is false, source statements described after this ELSEIF or \_ELSEIF control instruction until the appearance of the next conditional assembly control instruction (ELSEIF/ \_ELSEIF, ELSE, or ENDIF) in the source program will not be assembled.
- If the conditions of all the IF/\_IF and ELSEIF/\_ELSEIF control instructions described before the ELSE control instruction are not satisfied (i.e., all the switch names are false), source statements described after this ELSE control instruction until the appearance of the ENDIF control instruction in the source program will be assembled.
- The ENDIF control instruction indicates to the assembler the termination of source statements subject to conditional assembly.



**[Use]**

- With these conditional assembly control instructions, source statements subject to assembly can be changed without major modifications to the source program.
- If a statement for debugging that becomes necessary only during the program development is described in a source program, whether or not the debugging statement should be assembled (translated into machine language) can be specified by setting switches for conditional assembly.

**[Description]**

- The IF and ELSEIF control instructions are used for true/false condition judgment with switch name(s), whereas the \_IF and \_ELSEIF control instructions are used for true/false condition judgment with a conditional expression. Both IF/ELSEIF and \_IF/\_ELSEIF may be used in combination. In other words, ELSEIF/\_ELSEIF may be used in a pair with IF or \_IF and ENDIF.
- Describe absolute expression for a conditional expression.
- The rules of describing switch names are the same as the conventions of symbol description (for details, see "(3) Symbol field" ).  
However, the maximum number of characters that can be recognized as a switch name is always 31.
- If the two or more switch names are to be specified with the IF or ELSEIF control instruction, delimit each switch name with a colon ( : ).  
Up to five switch names can be used per module
- When two or more switch names have been specified with the IF or ELSEIF control instruction, the IF or ELSEIF condition is judged to be satisfied if one of the switch name values is true.
- The value of each switch name to be specified with the IF or ELSEIF control instruction must be defined with the SET/RESET control instruction.  
Therefore, if the value of the switch name specified with the IF or ELSEIF control instruction is not set in the source module with the SET or RESET control instruction in advance, it is assumed to be reset.
- If the specified switch name or conditional expression contains an illegal description, the assembler will output an error message and determine that the evaluated value is false.
- When describing the IF or \_IF control instruction, the IF or \_IF control instruction must always be paired with the ENDIF control instruction.
- If an IF-ENDIF block is described in a macro body and control is transferred back from the macro at that level by EXITM processing, the assembler will force the IF level to return to that level at the entry of the macro body. In this case, no error occurs.
- Description of an IF-ENDIF block in another IF-ENDIF block is referred to as nesting of IF control instructions. Nesting of IF control instructions is allowed up to 8 levels.
- In conditional assembly, object codes will not be generated for statements not assembled, but these statements will be output without change on the assembly list. If you do not wish to output these statements, use the \$NOCOND control instruction.

**[Application example]**

- Example 1

```

text0
$   IF ( SW1 )           ; (1)
      text1
$   ELSE                 ; (2)
      text2
$   ENENDIF             ; (3)
      :
      END

```

(1) The value of switch name "SW1" has been set to true or false with the SET or RESET control instruction described in "text0".

If the value of switch name "SW1" is true, statements in "text1" will be assembled and statements in "text2" will not be assembled.

(2) If the value of switch name "SW1" in (1) is false, statements in "text1" will not be assembled and statements in "text2" will be assembled.

(3) This instruction indicates the end of the source statement range for conditional assembly.

- Example 2

```

text0
$   IF ( SW1 : SW2 )     ; (1)
      text1
$   ELSEIF ( SW3 )       ; (2)
      text2
$   ELSEIF ( SW4 )       ; (3)
      text3
$   ELSE                 ; (4)
      text4
$   ENENDIF             ; (5)
      :
      END

```

(1) The values of switch names "SW1", "SW2", and "SW3" have been set to true or false with the SET or RESET control instruction described in "text0".

If the value of switch name "SW1" or "SW2" is true, statements in "text1" will be assembled and statements in "text2", "text3", and "text4" will not be assembled.

If the values of switch names "SW1" and "SW2" are false, statements in "text1" will not be assembled and statements after (2) will be conditionally assembled.

(2) If the values of switch names "SW1" and "SW2" in (1) are false and the value of switch name "SW3" is true, statements in "text2" will be assembled and statements in "text1", "text3", and "text4" will not be assembled.

- (3) If the values of switch names "SW1" and "SW2" in (1) and "SW3" in (2) are false and the value of switch statements in "text4" will be assembled and statements in "text1", "text2", and "text3" will not be will not be assembled.
- (4) If the values of switch names "SW1" and "SW2" in (1), "SW3" in (2), and "SW4" in (3) are all false, statements in "text4" will be assembled and statements in "text1", "text2", and "text3" will not be assembled.
- (5) This instruction indicates the end of the source statement range for conditional assembly.

**ENDIF**

Sets conditions in order to limit the assembly target source statements.

**[Description Format]**

```
[Δ] $ [Δ] IF [Δ] ( [Δ] switch-name [ [Δ] : [Δ] switch-name ] ... [Δ] )
or [Δ] $ [Δ] _IFΔconditional-expression
:
[Δ] $ [Δ] ELSEIF [Δ] ( [Δ] switch-name [ [Δ] : [Δ] switch-name ] ... [Δ] )
or [Δ] $ [Δ] _ELSEIFΔconditional-expression
:
[Δ] $ [Δ] ELSE
:
[Δ] $ [Δ] ENDIF
```

**[Function]**

- The control instructions set the conditions to limit source statements subject to assembly. Source statements described between the IF or \_IF control instruction and the ENDIF control instruction are subject to conditional assembly.
- If the evaluated value of the conditional expression or the switch name specified by the IF or \_IF control instruction (i.e., IF or \_IF condition) is true (other than 00H), source statements described after this IF or \_IF control instruction until the appearance of the next conditional assembly control instruction (ELSEIF/ \_ELSEIF, ELSE, or ENDIF) in the source program will be assembled. For subsequent assembly processing, the assembler will proceed to the statement next to the ENDIF control instruction.  
If the IF or \_IF condition is false (00H), source statements described after this IF or \_IF control instruction until the appearance of the next conditional assembly control instruction (ELSEIF/ \_ELSEIF, ELSE, or ENDIF) in the source program will not be assembled.
- The ELSEIF or \_ELSEIF control instruction is checked for true/false status only when the conditions of all the conditional assembly control instructions described before this ELSEIF or \_ELSEIF control instruction are not satisfied (i.e. the evaluated values are false).  
If the evaluated value of the conditional expression or the switch name specified by the ELSEIF or \_ELSEIF control instruction (i.e. ELSEIF or \_ELSEIF condition) is true, source statements described after this ELSEIF or \_ELSEIF control instruction until the appearance of the next conditional assembly control instruction (ELSEIF/ \_ELSEIF, ELSE, or ENDIF) in the source program will be assembled. For subsequent assembly processing, the assembler will proceed to the statement next to the ENDIF control instruction.  
If the ELSEIF or \_ELSEIF condition is false, source statements described after this ELSEIF or \_ELSEIF control instruction until the appearance of the next conditional assembly control instruction (ELSEIF/ \_ELSEIF, ELSE, or ENDIF) in the source program will not be assembled.
- If the conditions of all the IF/\_IF and ELSEIF/\_ELSEIF control instructions described before the ELSE control instruction are not satisfied (i.e., all the switch names are false), source statements described after this ELSE control instruction until the appearance of the ENDIF control instruction in the source program will be assembled.
- The ENDIF control instruction indicates to the assembler the termination of source statements subject to conditional assembly.

**[Use]**

- With these conditional assembly control instructions, source statements subject to assembly can be changed without major modifications to the source program.
- If a statement for debugging that becomes necessary only during the program development is described in a source program, whether or not the debugging statement should be assembled (translated into machine language) can be specified by setting switches for conditional assembly.

**[Description]**

- The IF and ELSEIF control instructions are used for true/false condition judgment with switch name(s), whereas the \_IF and \_ELSEIF control instructions are used for true/false condition judgment with a conditional expression. Both IF/ELSEIF and \_IF/\_ELSEIF may be used in combination. In other words, ELSEIF/\_ELSEIF may be used in a pair with IF or \_IF and ENDIF.
- Describe absolute expression for a conditional expression.
- The rules of describing switch names are the same as the conventions of symbol description (for details, see "(3) Symbol field" ).

However, the maximum number of characters that can be recognized as a switch name is always 31.

- If the two or more switch names are to be specified with the IF or ELSEIF control instruction, delimit each switch name with a colon ( : ).  
Up to five switch names can be used per module
- When two or more switch names have been specified with the IF or ELSEIF control instruction, the IF or ELSEIF condition is judged to be satisfied if one of the switch name values is true.
- The value of each switch name to be specified with the IF or ELSEIF control instruction must be defined with the SET/RESET control instruction.  
Therefore, if the value of the switch name specified with the IF or ELSEIF control instruction is not set in the source module with the SET or RESET control instruction in advance, it is assumed to be reset.
- If the specified switch name or conditional expression contains an illegal description, the assembler will output an error message and determine that the evaluated value is false.
- When describing the IF or \_IF control instruction, the IF or \_IF control instruction must always be paired with the ENDIF control instruction.
- If an IF-ENDIF block is described in a macro body and control is transferred back from the macro at that level by EXITM processing, the assembler will force the IF level to return to that level at the entry of the macro body. In this case, no error occurs.
- Description of an IF-ENDIF block in another IF-ENDIF block is referred to as nesting of IF control instructions. Nesting of IF control instructions is allowed up to 8 levels.
- In conditional assembly, object codes will not be generated for statements not assembled, but these statements will be output without change on the assembly list. If you do not wish to output these statements, use the \$NOCOND control instruction.

**[Application example]**

- Example 1

```

        text0
$      IF ( SW1 )          ; (1)
                text1
$      ENDIF              ; (2)
        :
        END

```

- (1) If the value of switch name "SW1" is true, statements in "text1" will be assembled.  
If the value of switch name "SW1" is false, statements in "text1" will not be assembled.  
The value of switch name "SW1" has been set to true or false with the SET or RESET control instruction described in "text0".
- (2) This instruction indicates the end of the source statement range for conditional assembly.

- Example 2

```

text0
$   IF ( SW1 )           ; (1)
      text1
$   ELSE                 ; (2)
      text2
$   ENDIF                ; (3)
      :
      END

```

- (1) The value of switch name "SW1" has been set to true or false with the SET or RESET control instruction described in "text0".  
If the value of switch name "SW1" is true, statements in "text1" will be assembled and statements in "text2" will not be assembled.
- (2) If the value of switch name "SW1" in (1) is false, statements in "text1" will not be assembled and statements in "text2" will be assembled.
- (3) This instruction indicates the end of the source statement range for conditional assembly.

- Example 3

```

text0
$   IF ( SW1 : SW2 )    ; (1)
      text1
$   ELSEIF ( SW3 )     ; (2)
      text2
$   ELSEIF ( SW4 )     ; (3)
      text3
$   ELSE                ; (4)
      text4
$   ENDIF              ; (5)
      :
      END

```

- (1) The values of switch names "SW1", "SW2", and "SW3" have been set to true or false with the SET or RESET control instruction described in "text0".  
If the value of switch name "SW1" or "SW2" is true, statements in "text1" will be assembled and statements in "text2", "text3", and "text4" will not be assembled.

If the values of switch names "SW1" and "SW2" are false, statements in "text1" will not be assembled and statements after (2) will be conditionally assembled.

- (2) If the values of switch names "SW1" and "SW2" in (1) are false and the value of switch name "SW3" is true, statements in "text2" will be assembled and statements in "text1", "text3", and "text4" will not be assembled.
- (3) If the values of switch names "SW1" and "SW2" in (1) and "SW3" in (2) are false and the value of switch statements in "text4" will be assembled and statements in "text1", "text2", and "text3" will not be will not be assembled.
- (4) If the values of switch names "SW1" and "SW2" in (1), "SW3" in (2), and "SW4" in (3) are all false, statements in "text4" will be assembled and statements in "text1", "text2", and "text3" will not be assembled.
- (5) This instruction indicates the end of the source statement range for conditional assembly.

- Example 4

```

text0
$   _IF ( SYMA )           ; (1)
      text1
$   _ELSEIF ( SYMB = SYMC ) ; (2)
      text2
$   ENDIF                 ; (3)
      :
      END

```

- (1) The value of switch name "SYMA" has been defined with the EQU or SET directive described in "text0". If the symbol name "SYMA" is true (not "0" ), statements in "text1" will be assembled and "text2" will not be assembled.
- (2) If the value of the symbol name "SYMA" is "0", and "SYMB" and "SYMC" have the same value, statements in "text2" will be assembled.
- (3) This instruction indicates the end of the source statement range for conditional assembly.

**SET**

Sets value for switch name specified by IF/ELSEIF control instruction.

**[Description Format]**

```
[Δ] $ [Δ] SET [Δ] ( [Δ] switch-name [ [Δ] : [Δ] switch-name ] ... [Δ] )
```

**[Function]**

- The SET control instructions give a value to each switch name to be specified with the IF or ELSEIF control instruction.
- The SET control instruction gives a true value (OFFH) to each switch name specified in its operand.

**[Use]**

- Describe the SET control instruction to give a true value (OFFH) to each switch name to be specified with the IF or ELSEIF control instruction.

**[Description]**

- With the SET and RESET control instructions, at least one switch name must be described.  
The conventions for describing switch names are the same as the conventions for describing symbols (see "[\(3\) Symbol field](#)").  
However, the maximum number of characters that can be recognized as a switch name is always 31.
- The specified switch name(s) may be the same as user-defined symbol(s) other than reserved words and other switch names.
- If two or more switch names are to be specified with the SET or RESET control instruction, delimit each switch name with a colon ( : ). Up to 1,000 switch names can be used per module.
- A switch name once set to "true" with the SET control instruction can be changed to "false" with the RESET control instruction, and vice versa.
- A switch name to be specified with the IF or ELSEIF control instruction must be defined at least once with the SET or RESET control instruction in the source module before describing the IF or ELSEIF control instruction.
- Switch names will not be output to a cross-reference list.



**[Application example]**

```
$      SET ( SW1 )          ; (1)
      :
$      IF ( SW1 )          ; (2)
      text1
$      ENDIF              ; (3)
      :
$      RESET ( SW1 : SW2 ) ; (4)
      :
$      IF ( SW1 )          ; (5)
      text2
$      ELSEIF ( SW2 )     ; (6)
      text3
$      ELSE                ; (7)
      text4
$      ENDIF              ; (8)
      :
      END
```

- (1) This instruction gives a true value (0FFH) to switch name "SW1".
- (2) Because the true value has been given to switch name "SW1" in (1) above, statements in "text1" will be assembled.
- (3) This instruction indicates the end of the source statement range for conditional assembly that starts from (2).
- (4) This instruction gives a false value (00H) to switch names "SW1" and "SW2", respectively.
- (5) Because the false value has been given to switch name "SW1" in (4) above, statements in "text2" will not be assembled.
- (6) Because the false value has also been given to switch name "SW2" in (4) above, statements in "text3" will not be assembled.
- (7) Because both switch names "SW1" and "SW2" are false in (5) and (6) above, statements in "text4" will be assembled.
- (8) This instruction indicates the end of the source statement range for conditional assembly that starts from (5).

**RESET**

Sets value for switch name specified by IF/ELSEIF control instruction.

**[Description Format]**

```
[Δ] $ [Δ] RESET [Δ] ( [Δ] switch-name [ [Δ] : [Δ] switch-name ] ... [Δ] )
```

**[Function]**

- The RESET control instructions give a value to each switch name to be specified with the IF or ELSEIF control instruction.
- The RESET control instruction gives a false value (00H) to each switch name specified in its operand.

**[Use]**

- Describe the RESET control instruction to give a false value (00H) to each switch name to be specified with the IF or ELSEIF control instruction.

**[Description]**

- With the SET and RESET control instructions, at least one switch name must be described.  
The conventions for describing switch names are the same as the conventions for describing symbols (see "(3) [Symbol field](#)").  
However, the maximum number of characters that can be recognized as a switch name is always 31.
- The specified switch name(s) may be the same as user-defined symbol(s) other than reserved words and other switch names.
- If two or more switch names are to be specified with the SET or RESET control instruction, delimit each switch name with a colon ( : ). Up to 1,000 switch names can be used per module.
- A switch name once set to "true" with the SET control instruction can be changed to "false" with the RESET control instruction, and vice versa.
- A switch name to be specified with the IF or ELSEIF control instruction must be defined at least once with the SET or RESET control instruction in the source module before describing the IF or ELSEIF control instruction.
- Switch names will not be output to a cross-reference list.

**[Application example]**

```
$      SET ( SW1 )          ; (1)
      :
$      IF ( SW1 )          ; (2)
      text1
$      ENDIF              ; (3)
      :
$      RESET ( SW1 : SW2 ) ; (4)
      :
$      IF ( SW1 )          ; (5)
      text2
$      ELSEIF ( SW2 )     ; (6)
      text3
$      ELSE                ; (7)
      text4
$      ENDIF              ; (8)
      :
      END
```

- (1) This instruction gives a true value (0FFH) to switch name "SW1".
- (2) Because the true value has been given to switch name "SW1" in (1) above, statements in "text1" will be assembled.
- (3) This instruction indicates the end of the source statement range for conditional assembly that starts from (2).
- (4) This instruction gives a false value (00H) to switch names "SW1" and "SW2", respectively.
- (5) Because the false value has been given to switch name "SW1" in (4) above, statements in "text2" will not be assembled.
- (6) Because the false value has also been given to switch name "SW2" in (4) above, statements in "text3" will not be assembled.
- (7) Because both switch names "SW1" and "SW2" are false in (5) and (6) above, statements in "text4" will be assembled.
- (8) This instruction indicates the end of the source statement range for conditional assembly that starts from (5).

#### 4.3.8 Kanji code control instruction

This is a control instruction which specifies which character code to use to interpret kanji characters described in the comment.

The following kanji code control instructions are available.

Control Instruction	Overview
KANJICODE	Interprets Kanji character code for specified Kanji characters described in the comment.

**KANJICODE**

Interprets Kanji character code for specified Kanji characters described in the comment.

**[Description Format]**

```
[Δ] $ [Δ] KANJICODE [Δ] kanji-code
```

**[Default Assumption]**

\$KANJICODE SJIS

**[Function]**

- Interprets Kanji character code for specified Kanji characters described in the comment.
- A kanji cord can describe SJIS/EUC/NONE.
  - SJIS : Interpreted as a Shift JIS code.
  - EUC : Interpreted as a EUC code.
  - NONE : Not interpreted as a kanji.

**[Use]**

- Use to specify the interpretation of the kanji code (2-byte code) of the kanji (2-byte character) in the comment line.

**[Description]**

- The KANJICODE control instruction can be described only in the header section of a source module file.
- If two or more KANJICODE control instructions are specified in the header section of a source module file at the same time, only the last specified control instruction will become valid.
- Kanji code specification stops may also be specified with the assembler option (-zs/-ze/-zn) in the startup command line of the assembler.
- If the control instruction specification (KANJICODE) in the source module differs from the specification (-zs/-ze/-zn) in the startup command line, the specification in the command line will take precedence over that in the source module.
- Even when the assembler option (-zs/-ze/-zn) has been specified in the startup command line, the assembler performs a syntax check on the KANJICODE control instruction.

#### 4.3.9 Other control instructions

The control instructions shown below are special control instructions output by an upper level program such as C compiler.

- \$TOL\_INF
- \$DGS
- \$DGL

## 4.4 Macros

This section explains how to use macros.

Macros are very useful when you need to use a series of statements repeatedly in a source program.

### 4.4.1 Overview

Macros make it easy to repeat a series of statements over and over again in a source program.

A macro contains a series of instructions in a macro body, which is defined between MACRO and ENDM directives.

These instructions are inserted into the source program at any location that references the macro.

Macros make it easier to write source programs. They are different from subroutines.

The difference between macros and subroutines is explained below. For effective use, select either a macro or a subroutine according to the specific purpose.

#### (1) Subroutines

- Subroutines handle processing that must be repeated many times in a program. A subroutine is converted into machine language once by the assembler.
- To use a subroutine, simply call it with a subroutine call instruction. (Usually you will also need to set the arguments of the subroutine before calling it, and adjust for them afterwards.)  
Effective use of subroutines enables program memory to be used with high efficiency.
- Subroutines are also important in structured programming. Dividing the program into functional blocks clarifies the overall structure of the program and makes it easier to understand. There are benefits for design, coding, and maintenance.

#### (2) Macros

- The basic function of macros is to replace a series of instructions with a macro name.  
A macro is defined as a series of instruction between MACRO and ENDM directives. When the macro name appears in the source code, the instructions are inserted at that location. The assembler replaces any formal parameters of the macro with actual parameters and converts the instructions into machine language.
- Macros can have parameters.  
For example, if there are instruction groups that are the same in processing procedure but are different in the data to be described in the operand, define a macro by assigning formal parameter(s) to the data. By describing the macro name and the actual parameter(s) at macro reference time, the assembler can cope with various instruction groups that differ only in part of the statement description.

Subroutines are used mainly to reduce memory requirements and clarify the structure of programs. Macros are used to make programs easier to describe and understand.

### 4.4.2 Using macros

#### (1) Macro definitions

Use the MACRO and ENDM directives to define macros.

**(a) Format**

Symbol field	Mnemonic field	Operand field	Comment field
<i>macro-name</i>	MACRO	[ <i>formal-parameter</i> [, ... ]]	[; <i>comment</i> ]
	:		
	ENDM		[; <i>comment</i> ]

**(b) Function**

Define a macro, assigning the macro name specified in the symbol field to the series of statements (called the macro body) between the MACRO directive and the ENDM directive

**(c) Example**

```
ADMAC  MACRO  PARA1, PARA2
        MOV   A, #PARA1
        ADD   A, #PARA2
        ENDM
```

The above example shows a simple example that adds the two values PARA1 and PARA2, and stores the result in register A. The macro is named ADMAC. PARA1 and PARA2 are formal parameters.

For details, see "[4.2.8 Macro directives](#)".

**(2) Referencing macros**

To reference an already defined macro, specify the macro name in the mnemonic field.

**(a) Format**

Symbol field	Mnemonic field	Operand field	Comment field
[ <i>label</i> :]	<i>macro-name</i>	[ <i>actual-parameter</i> [, ... ]]	[; <i>comment</i> ]

**(b) Function**

Reference the macro body to which the specified name has been assigned.

**(c) Use**

Use the above format to reference a macro body.

**(d) Explanation**

- The macro name specified in the mnemonic field must have been defined before the macro reference.
  - Delimit actual parameters with commas ( , ). Up to 16 actual parameters can be specified, provided that they all appear in the same line.
  - Space characters cannot appear in an actual parameter string.
  - If an actual parameter string contains a comma ( , ), semicolon ( ; ), blank, or a tab, enclose the string in single quotation marks ( ' ).
  - Formal parameter are converted to actual parameters from the left, in the order that they occur in the macro definition.
- The number of actual parameters must match the number of formal parameters. If it does not, a warning is issued.



**(e) Example**

```

NAME     SAMPLE
ADMAC   MACRO  PARA1, PARA2
          MOV   A, #PARA1
          ADD   A, #PARA2
        ENDM

        CSEG
        :
ADMAC   10H, 20H
        :
        END

```

The already defined macro "ADMAC" is referenced.  
10H and 20H are actual parameters.

**(3) Macro expansion**

The assembler processes a macro as follows:

- When it encounters a macro name, the assembler inserts the corresponding macro body at the location of the macro name.
- The inserted macro body is then assembled in the same way as other statements.

**(4) Example**

When the macro shown above in "(2) Referencing macros" is referenced, it is expanded as shown below.

```

NAME     SAMPLE

        ; Macro definition
ADMAC   MACRO  PARA1, PARA2
          MOV   A, #PARA1
          ADD   A, #PARA2
        ENDM

        ; Source code
        CSEG
        :

        ; Macro expansion
ADMAC   10H, 20H           ; (a)
MOV     A, #10H
ADD     A, #20H
        ; Source code
        :
        END

```

- (a) The macro body is inserted when the macro name is referenced.  
In the macro body, formal parameters are replaced by actual parameters.

#### 4.4.3 Symbols in macros

Two types of symbols can be defined in macros: global symbols and local symbols.

##### (1) Global symbols

- A global symbol is a symbol that can be referenced from any statement in a source program.  
Therefore, if a macro that defines a global symbol is referenced more than once when expanding a series of statements, a double definition error will occur.
- Symbols not defined with the LOCAL directive are global symbols.

##### (2) Local symbols

- A local symbol is a symbol defined with the LOCAL directive (see "4.2.8 Macro directives" ).
- A local symbol can be referenced only within the macro that declares it as LOCAL.
- No local symbol can be referenced from outside the macro that declares it

<Application example>

```

NAME      SAMPLE
          ; Macro definition
MAC1      MACRO
          LOCAL  LLAB          ; (a)
LLAB :
          :
GLAB :
          BR     LLAB          ; (b)
          BR     GLAB          ; (c)
          ENDM
          :
          ; Source code
REF1 : MAC1                    ; (d) <- Macro reference
          :
          BR     LLAB          ; (e) <- Error
          BR     GLAB          ; (f)
          :
REF2 : MAC1                    ; (g) <- Macro reference
          :
          END

```

- (a) This LOCAL directive defines label "LLAB" as a local symbol.
- (b) This BR instruction references local symbol "LLAB" in macro "MAC1".
- (c) This BR instruction references global symbol "GLAB" in macro "MAC1".
- (d) This statement references macro "MAC1".

- (e) This BR instruction references local symbol "LLAB" from outside the definition of macro "MAC1". This causes an error when the source program is assembled.
- (f) This BR instruction references global symbol "GLAB" from outside the definition of macro "MAC1".
- (g) This statement references macro "MAC1". The same macro is referenced twice.

<Assemble list for the above application example>

```

NAME      SAMPLE
:
REF1 :  MAC1
        ; Macro expansion
??RA0000 :
:
GLAB :                                <- Error
BR      ??RA0000
BR      GLAB
        ; Source code
:
BR      !LLAB                        <- Error
BR      !GLAB
:
REF2 :  MAC1
        ; Macro expansion
??RA0001 :
:
GLAB :                                <- Error
BR      ??RA0001
BR      GLAB
        ; Source code
:
END

```

Macro MAC1 defines the global symbol GLAB.

Macro MAC1 is referenced twice. An error occurs when the macro is expanded the second time, because the global symbol GLAB is defined twice.

#### 4.4.4 Macro operators

There are two macro operators: "&" (ampersand) and ", " (single quotation mark).

##### (1) & (Concatenation)

- The ampersand "&" concatenates one character string to another within a macro body.

At macro expansion time, the character string on the left of the ampersand is concatenated to the character string on the right of the sign. The "&" itself disappears after concatenating the strings.

- At macro definition time, strings before and after "&" in symbols are recognized as local symbols and formal parameters. At macro expansion time, strings before and after the "&" in the symbol are evaluated as the local symbols and formal parameters, and concatenated into single symbols.
- The "&" sign enclosed in a pair of single quotation marks is simply handled as data.
- Two "&" signs in succession are handled as a single "&" sign.

Following is an application example.

**(a) Macro definition**

```

MAC      MACRO   P
LAB&P :                               <- Formal parameter P is recognized
        D&B     10H
        DB      'P'
        DB      P
        DB      '&P'
        ENDM

```

**(b) Macro reference**

```

        MAC     1H
LAB1H :
        DB     10H    <- D&B has been concatenated to DB
        DB     'P'
        DB     1H
        DB     '&P'   <- Quoted '&' is simply data

```

**(2) ' (Single quotation mark)**

- If a character string enclosed by a pair of single quotation marks appears at the beginning of an actual parameter in a macro reference line or an IRP directive, or if it appears after a delimiting character, the character string is interpreted as an actual parameter. The character string is passed as a actual parameter without the enclosing single quotation marks.
- If a character string enclosed by a pair of single quotation marks appears in a macro body, it is simply handled as data.
- To use a single quotation mark as a single quotation mark in text, write the single quotation mark twice in succession.

<Application example>

```

        NAME    SAMP
MAC1    MACRO   P
        IRP     Q, <P>
            MOV  A, #Q
        ENDM
ENDM

MAC1    '10, 20, 30'

```

When the source code in the above example is assembled, macro MAC1 is expanded as shown below.

```

IRP    Q, <10, 20, 30>
      MOV A, #Q
ENDM

      MOV    A, #10      ; IRP expansion
      MOV    A, #20      ; IRP expansion
      MOV    A, #30      ; IRP expansion

```

#### 4.5 Reserved Words

Reserved words are character strings reserved in advance by the assembler. They include machine language instructions, directives, control instructions, operators, register names, and sfr symbols. Reserved words cannot be used for other than the intended purposes.

The following tables explain where reserved words can appear in source code statements and list the words reserved by the assembler.

**Table 4-22. Fields Where Reserved Words Can Appear**

Field	Explanation
Symbol field	No reserved words can appear in this field.
Mnemonic field	Only machine language instructions and directives can appear in this field.
Operand field	Only operators, sfr symbols, and register names can appear in this field.
Comment field	All reserved words can appear in this field.

**Table 4-23. List of Reserved Words**

Type	Reserved Word
Operators	AND, BANKNUM, BITPOS, DATAPOS, EQ (=), GE (>=), GT (>), HIGH, LE (<=), LOW, LT (<), MASK, MOD, NE (<>), NOT, OR, SHL, SHR, XOR
Directives	AT, BASE, BASEP, BR, BSEG, CALLT0, CSEG, DB, DBIT, DS, DSEG, DSPRAM, DW, END, ENDM, ENDS, EQU, EXITM, EXTBIT, EXTRN, FIXED, IHRAM, IRP, IXRAM, LOCAL, LRAM, MACRO, MIRRORP, NAME, OPT_BYTE, ORG, PAGE64KP, PUBLIC, REPT, SADDR, SADDRP, SECUR_ID, SET, UNIT, UNITP
Control instructions	COND, NOCOND, DEBUG, NODEBUG, DEBUGA [DG], NODEBUGA [NODG], EJECT [EJ], FORMFEED, NOFORMFEED, GEN, NOGEN, IF, _IF, ELSEIF, _ELSEIF, ELSE, ENDIF, INCLUDE [IC], KANJI-CODE, LENGTH, LIST [LI], NOLIST [NOLI], PROCESSOR [PC], SET, RESET, SUBTITLE [ST], SYMLIST, NOSYMLIST, TAB, TITLE [TT], WIDTH, XREF[XR], NOXREF [NOXR]
Other	DGL, DGS, SFR, SFRP, TOL_INF

**Remark** Items in brackets following control instructions indicate the abbreviated format.

See the user's manual of the target device for a list of sfr names, a list of interrupt request sources, and lists of machine language instructions and register names.

## 4.6 Instructions

This section explains the functions of 78K0 microcontroller instructions.

### 4.6.1 Memory space

#### (1) Memory space

The mapping of program memory differs for different 78K0 microcontrollers, depending on the amount of internal memory in the device. See the user's manual of the target microcontroller for detailed information about memory map address spaces.

#### (2) Internal program memory (internal ROM) space

The address space of 78K0 microcontrollers includes internal ROM, which is used to store programs, tables, and other constant data. Normally these areas are addressed with the program counter (PC). See the user's manual of the target microcontroller for detailed information about the internal ROM space.

##### (a) Vector table area

The 64 bytes at [0000H to 003FH] are reserved for a vector table. The vector table contains the branch start addresses of routines that are called on  $\overline{\text{RESET}}$  input and interrupt requests. The lower 8 bits of the 16-bit addresses are stored at an even address, and the higher 8 bits are stored at an odd address. See the user's manual of the target microcontroller for detailed information about vector table.

##### (b) CALLT instruction table area

The 64 bytes at [0040H to 007FH] are used to store the entry addresses of subroutines that can be called with the 1-byte CALLT instruction.

##### (c) CALLF instruction entry area

The area [0800H to 0FFFH] stores the addresses of subroutines that can be called directly with the 2-byte CALLF cal instruction.

#### (3) Internal data memory (internal RAM) space

78K0 microcontrollers are equipped with the following types of internal RAM. See the user's manual of the target microcontroller for detailed information about internal RAM.

##### (a) High-speed internal RAM

78K0 microcontrollers are equipped with high-speed internal RAM.

The 32 bytes from 0FEE0H to 0FEFFH in this area are assigned to four general-purpose register banks, each comprising eight 8-bit registers.

High-speed internal RAM can also be used as stack memory.

##### (b) Buffer RAM

Some 78K0 microcontrollers have internal RAM I/O buffers. These RAM buffers are used to store I/O data for serial interface channel 1 (3-wire serial, multiple I/O modes with master/slave transmit/receive capabilities).

When these 3-wire serial capabilities are not needed, then the buffer RAM can be used as normal RAM.

##### (c) VFD display RAM

Some 78K0 microcontrollers have RAM assigned to VFD display functions. VFD display RAM can also be used as normal RAM.

**(d) Internal extended RAM**

Some 78K0 microcontrollers have internal extended RAM.

**(e) LCD display RAM**

Some 78K0 microcontrollers have RAM assigned to LCD display functions. LCD display RAM can also be used as normal RAM.

**(4) Special function register (SFR) area**

0FF00H to 0FFFFH is assigned to special function registers for on-chip peripheral hardware.

See the user's manual of the target microcontroller for more information about the special function registers.

**Caution** Do not access any address in the SFR area to which no special function register has been assigned. The CPU may lock up if an unassigned address is accessed by mistake.

**(5) External memory space**

The external memory space is space that can be accessed by setting the memory expansion mode register. It can be used to store programs or table data, or assigned to peripheral devices.

See the user's manuals of 78K0 microcontrollers for more information about which microcontrollers are able to utilize external memory.

**(6) IEBus™ register area**

IEBus registers are assigned in the IEBus register area. They are used to control the IEBus controller.

See the user's manuals of 78K0 microcontrollers for more information about which microcontrollers are equipped with IEBus controllers.

**4.6.2 Registers****(1) Control registers**

Control registers are registers with special functions for controlling the program sequence, program status, and stack memory. They include the program counter, the program status word, and the stack pointer.

**(a) Program counter (PC)**

The program counter is a 16-bit register that holds the address of the next program to be executed.

In normal operation, the program counter is incremented automatically according to the number of bytes of the next instruction fetched for execution. To execute a branch instruction, a value is set in the program counter, for example by transferring immediate data or the contents of another register.

RESET input sets the program counter to the reset vector table values at addresses 0000H and 0001H.

**Figure 4-8. Configuration of Program Counter**

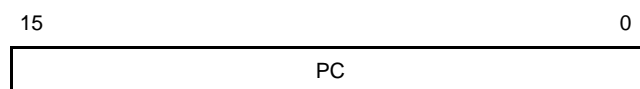
**(b) Program status word (PSW)**

The program status word is an 8-bit register consisting of flags that are set and reset by instruction execution.

The program status word is automatically saved on the stack when an interrupt request occurs and a PUSH PSW instruction is executed, and is automatically restored when an RETB or RETI instruction and a POP PSW instruction are executed.

RESET input sets the PSW to 02H.

Figure 4-9. Configuration of Program Status Word

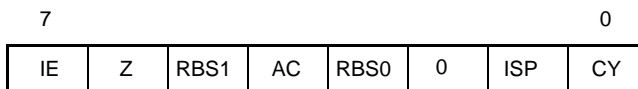

- Interrupt enable flag (IE)  
This flag controls interrupt request acknowledgement by the CPU.  
When IE = 0, interrupts are disabled (DI), and interrupts other than non-maskable interrupts are all disabled.  
When IE = 1, interrupts are enabled (EI), and interrupt request acknowledgement is controlled by the interrupt mask flags for the in-service priority flag (ISP), various interrupt sources, and by the priority specification flags.  
This flag is reset (0) by execution of the DI instruction or by interrupt request acknowledgment. It is set (1) by execution of the EI instruction.
- Zero flag (Z)  
This flag is set (1) when the result of an operation is zero. It is reset (0) in all other cases.
- Register bank selection flags (RBS0,RBS1)  
These are two 1-bit flags used to select one of the 4 register banks.  
The 2 bits of information in these flags indicate the bank selected by execution of an SBL RBn instruction.
- Auxiliary carry flag (AC)  
This flag is set (1) if an operation has a carry from bit 3 or a borrow to bit 3. It is reset (0) in all other cases.
- In-service priority flags (ISP0 and ISP1)  
These flags manage the priority of acknowledgeable maskable vectored interrupts. When ISP is 0, acknowledgment is disabled for vectored interrupt requests with priorities lower than the ISP0 and ISP1 values, as specified by the priority specification flag registers (PR). Actual acknowledgment for interrupt requests is controlled by the state of the interrupt enable flag (IE).
- Carry flag (CY)  
This flag stores overflow or underflow on execution of an add/subtract instruction. It stores the shift-out value on execution of a rotate instruction, and functions as a bit accumulator during execution of bit manipulation instructions.

**(c) Stack pointer (SP)**

This is a 16-bit register that holds the start address of the stack. The stack can be located in only internal high-speed RAM.

Figure 4-10. Configuration of Stack Pointer



SP is decremented before write (save) to the stack and is incremented after read (restored) from the stack. The following figure shows the data saved/restored by stack operations.

**Caution** The contents of the stack pointer are undefined after RESET generation. Be sure to initialize SP before using the stack.



Figure 4-11. Data Saved to Stack Memory

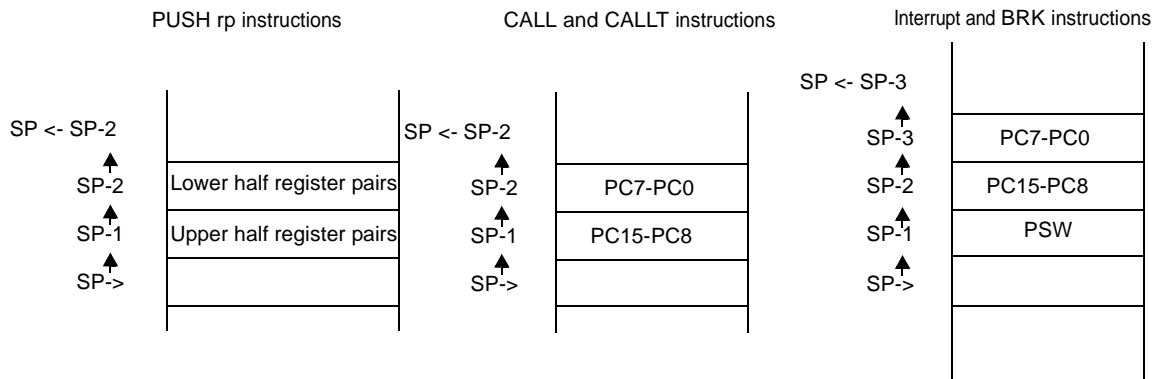
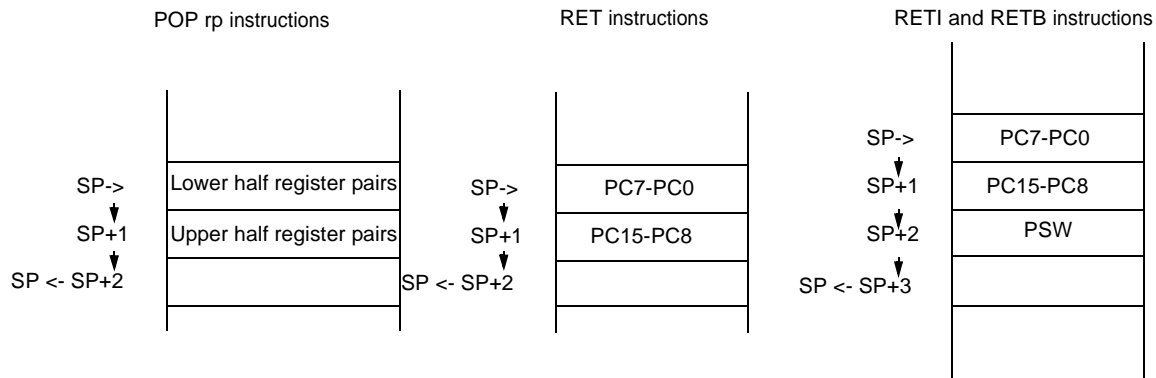

Figure 4-12. Data Restored to Stack Memory



**(2) General registers**

General-purpose registers are mapped to the addresses FFEE0H to FFEFFH in data memory. There are four general-purpose register banks, each bank consisting of eight 8-bit registers (X, A, C, B, E, D, L, and H).

Each register can be used as an 8-bit register, and pairs of 8-bit registers can be used as 16-bit registers (AX, BC, DE, and HL).

General-purpose registers can be specified by their function names (X, A, C, B, E, D, L, H, AX, BC, DE, and HL) or by their absolute names (R0 to R7 and RP0 to RP3).

The register bank to be used for instruction execution is set by the CPU control instruction SEL RBn. The 4-bank configuration enables switching between the registers used for normal processing and registers used by interrupts, which can increase program efficiency.

Table 4-24. General-Purpose Register Absolute Address Correspondence Table

Bank Name	Register		Absolute Address
	Function Name	Absolute Name	
BANK0	H	R7	FEFFH
	L	R6	FEFEH
	D	R5	FEFDH
	E	R4	FEFCH
	B	R3	FEFBH
	C	R2	FEFAH
	A	R1	FEF9H
	X	R0	FEF8H
BANK1	H	R7	FEF7H
	L	R6	FEF6H
	D	R5	FEF5H
	E	R4	FEF4H
	B	R3	FEF3H
	C	R2	FEF2H
	A	R1	FEF1H
	X	R0	FEF0H
BANK2	H	R7	FEEFH
	L	R6	EEEEH
	D	R5	FEEDH
	E	R4	FEECH
	B	R3	FEEBH
	C	R2	FEEAH
	A	R1	FEE9H
	X	R0	FEF8H
BANK3	H	R7	FEE7H
	L	R6	FEE6H
	D	R5	FEE5H
	E	R4	FEE4H
	B	R3	FEE3H
	C	R2	FEE2H
	A	R1	FEE1H
	X	R0	FEE0H

Figure 4-13. General-Purpose Register Configuration

(a) Function name

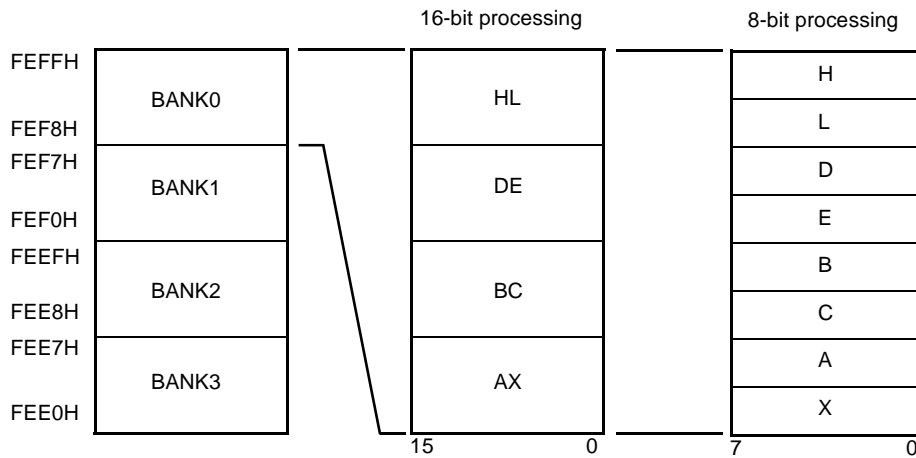

(b) Absolute name

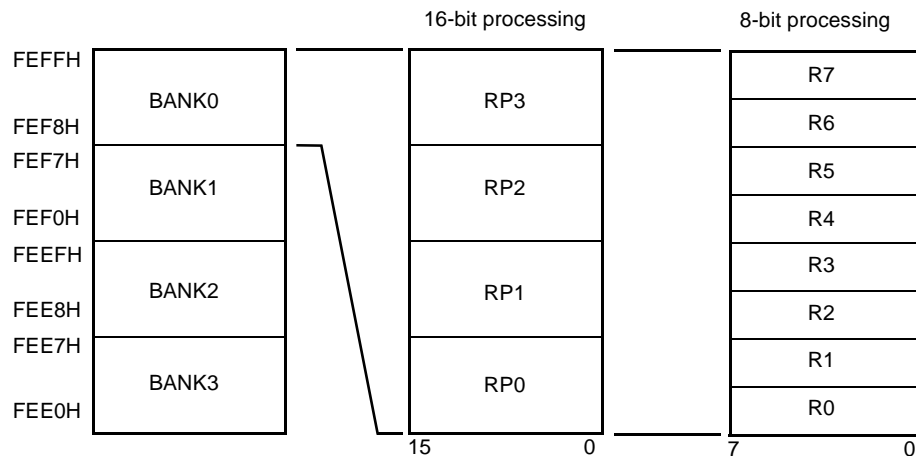

(3) Special function registers (SFR)

Unlike general-purpose registers, each SFR has a special function.

SFRs are allocated in the area 0FFF00H to 0FFFFFFH.

SFRs can be manipulated like general-purpose registers, using arithmetic, transfer, and bit manipulation instructions. The operation bit unit (1, 8, or 16) depends on the SFR type.

The following explains how to specify SFRs, for each bit unit size.

- 1-bit operations

Use the SFR name reserved by the assembler, and a 1-bit operation operand (sfr.bit). Addresses can also be specified.

- 8-bit operations

Use the SFR name reserved by the assembler, and an 8-bit operation operand (sfr). Addresses can also be specified.

- 16-bit operations

Use the SFR name reserved by the assembler, and a 16-bit operation operand (sfrp). Addresses can also be specified. When specifying an address, specify an even address.

See the user's manuals of 78K0 microcontrollers for more information about special function registers.

**Caution** Do not access any address in the SFR area to which no special function register has been assigned. The CPU may lock up if an unassigned address is accessed by mistake.

4.6.3 Addressing

(1) Addressing of instruction addresses

The instruction address is determined by the value in the program counter (PC). Normally the program counter is incremented automatically by the number of bytes in the instruction that is fetched to be executed next (+1 for each byte). But as explained below, a branch destination address is set in the program counter when a branch is executed. (See "4.6.5 Explanation of instructions" for details about each instruction.)

(a) Relative addressing

The value obtained by adding 8-bit immediate data (displacement value: *jdisp8*) of an instruction code to the start address of the following instruction is transferred to the program counter (PC) and branched. The displacement value is treated as signed two's complement data (-128 to +127) and bit 7 becomes a sign bit. In other words, in relative addressing, the value is relatively transferred to the range between -128 and +127 from the start address of the following instruction.

This function is carried out when the "BR \$addr16" instruction or a conditional branch instruction is executed.

Figure 4-14. How Relative Addressing Works

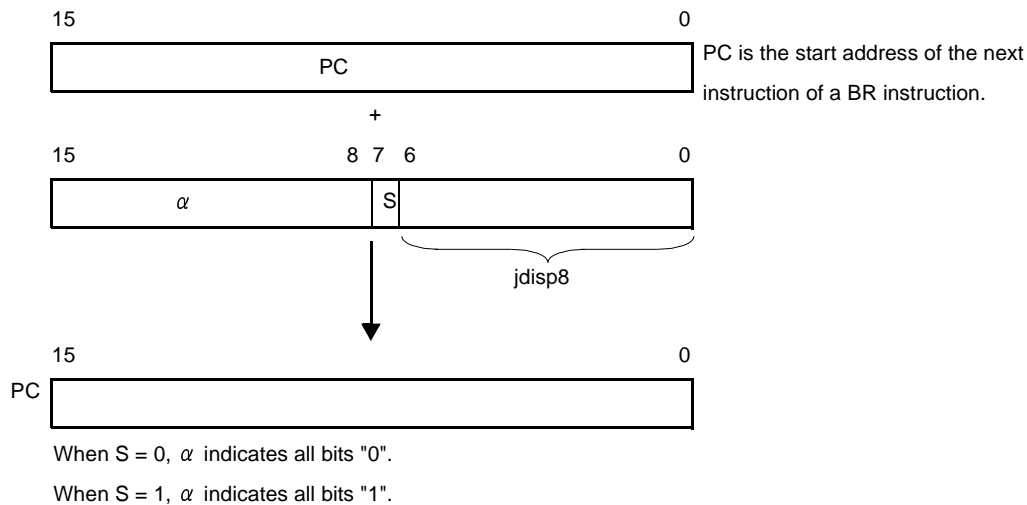

(b) Immediate addressing

Immediate data from machine language is transferred to the program counter (PC), and execution branches to that address.

Immediate addressing is applied when a CALL !addr16, BR !addr16, or CALLF !addr11 instruction is executed. The CALL !addr16 and BR !addr16 instructions branch to any location in memory. The CALLF !addr11 instruction branches to a location in the range 0800H to 0FFFH.

Figure 4-15. Example of CALL !addr16, BR !addr16 Instruction

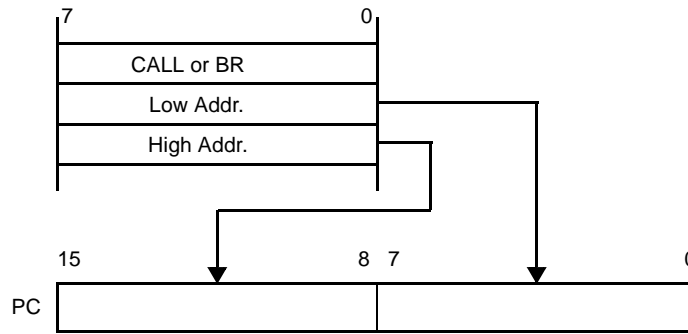
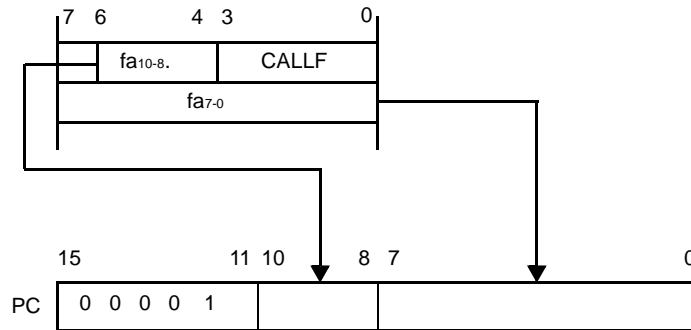

Figure 4-16. Example of CALLF !addr11 Instruction



**(c) Table indirect addressing**

Table indirect addressing uses the immediate data in bits 1 to 5 of the op-code specify a table address in the CALLT table. The location addressed by the entry at that table address (the branch destination) is transferred to the program counter, and execution branches.

Table indirect addressing is applied when the CALLT[addr5] instruction is executed. The CALLT instruction references the addresses stored in the memory table at 40H to 7FH. It can branch to anywhere in memory space.

Figure 4-17. How Table Indirect Addressing Works

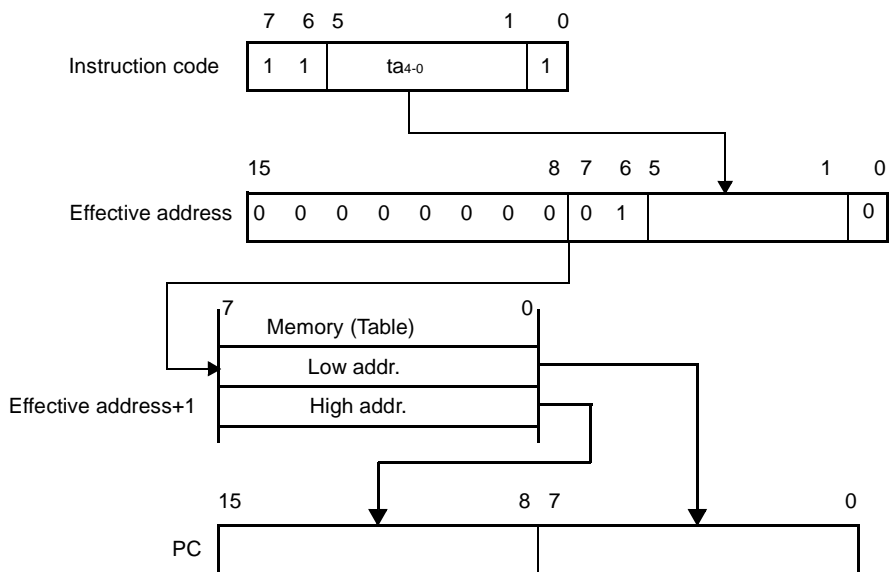

**(d) Register addressing**

Register addressing transfers the contents of a register pair (AX) specified by an instruction word to the program counter (PC). Execution branches.

Register addressing is applied when the BR AX instruction is executed.

Figure 4-18. Outline of Register Addressing

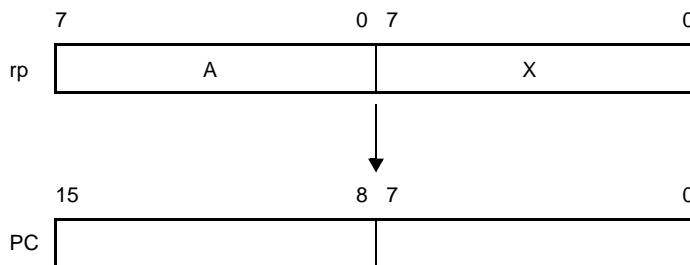

**(2) Operand address addressing**

Operand addressing specifies an operand to designate the register or memory location that is operated on by an instruction. Several types of operand address addressing are listed below.

**(a) Implied addressing**

Implied addressing automatically specifies one of the general-purpose accumulator registers (A or AX). In the machine language for 78K0 microcontrollers, the following instructions use implied addressing.

Instruction	Register to Be Specified by Implied Addressing
MULU	A register for multiplicand and AX register for product storage
DIVUW	AX register for dividend and quotient storage
ADJBA/ADJBS	A register for storage of numeric values targeted for decimal correction
ROR4/ROL4	A register for storage of digit data that undergoes digit rotation

Because these instructions use the accumulator automatically, they have no special operand format. In the case of the MULU X instruction, the product of registers A and X is obtained by an 8-bit x 8-bit multiplication and stored in register AX. Registers A and AX are specified by implied addressing.

**(b) Register addressing**

Register addressing accesses a general-purpose register as an operand. The accessed general-purpose register is specified by the register bank selection flags (RBS0 and RBS1), or by a register specification code (Rn or RPn) in the OP code.

Register addressing is applied when an instruction with the following operand format is executed. When an 8-bit register is specified, one of the eight registers is specified by 3 bits in the instruction code.

The operand format is shown below.

Format	Description
r	X, A, C, B, E, D, L, H
rp	AX, BC, DE, HL

r and rp can be specified as a function name (X, A, C, B, E, D, L, H, AX, BC, DE, HL) or an absolute name (R0 to R7, and RP0 to RP3).

**Figure 4-19. MOV A, C; Example of Register C as r**

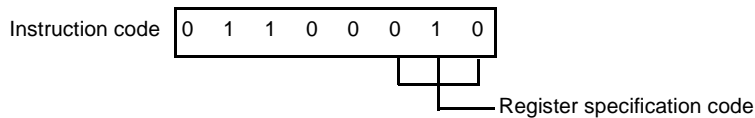

**Figure 4-20. INCW DE; Example of Register Pair DE as p**

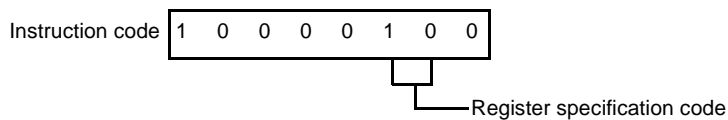

**(c) Direct addressing**

Direct addressing uses immediate data in the instruction word as an operand address to directly specify the target address.

The operand format is shown below.

Identifier	Description
addr16	Label or 16-bit immediate data

**Figure 4-21. MOV A, !FE00H; Example of FE00H as !addr16**

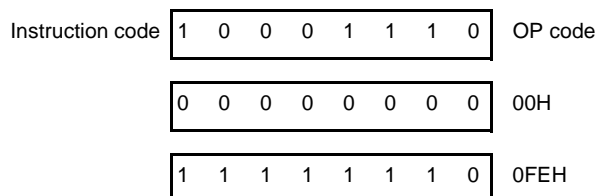
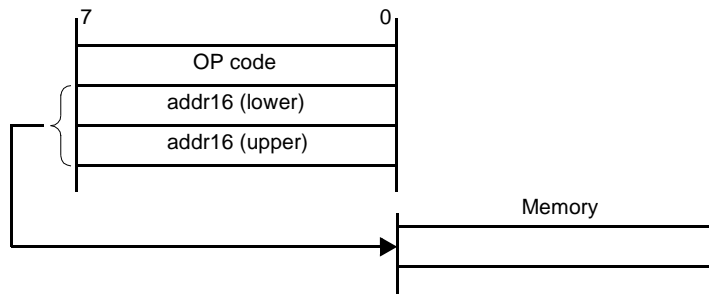

Figure 4-22. Outline of Direct Addressing



**(d) Short direct addressing**

Short direct addressing directly specifies a target address in a fixed memory space using 8-bit data in the instruction word.

The fixed memory space to which direct addressing is applied is the 256-byte space from 0FE20H to 0FF1FH. High-speed RAM is installed at 0FE20H to 0FEFFH, and special function registers (SFR) are mapped to 0FF00H to 0FF1FH.

The SFR space to which short direct addressing is applied (0FF00H to 0FF1FH) is only one part of the entire SFR area, but it contains ports that are frequently accessed by programs as well as the compare and capture registers of timer and event counters. These SFR addresses can be manipulated using short and fast instructions.

When 8-bit immediate data is in the range 20H to FFH, bit 8 of the effective address is set to 0. When it is in the range 00H to 1FH, bit 8 is set to 1. For an illustration, see "Figure 4-24. How Short Direct Addressing Works".

The operand format is shown below.

Identifier	Description
saddr	Label or 0FE20H to 0FF1FH immediate data
saddrp	Label or 0FE20H to 0FF1FH immediate data (even address only)

Figure 4-23. MOV FE30H, #50H; Example of FE30H as saddr Address, and 50H as Immediate Data

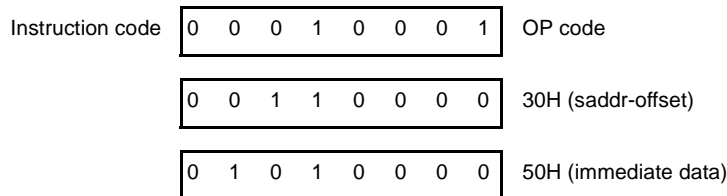
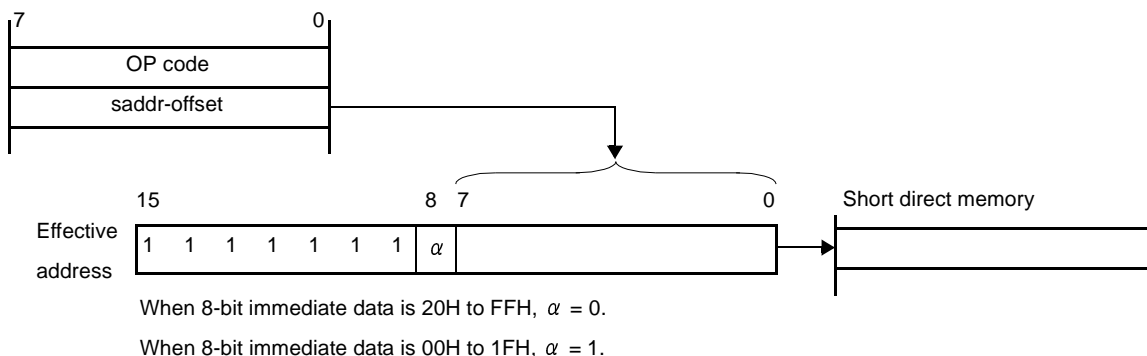



Figure 4-24. How Short Direct Addressing Works



**(e) Special function register (SFR) addressing**

Special function register addressing directly specifies the target SFR addresses using 8-bit immediate data in the instruction word.

This type of addressing is applied to the 240-byte space in the ranges 0FF00H to 0FFCFH and 0FFE0H to 0FFFFH. SFR registers mapped to the range 0FF00H to 0FF1FH can also be accessed by short direct addressing.

The operand format is shown below.

Identifier	Description
sfr	Special function register name
sfrp	16-bit-manipulatable special function register name (even address only)

Figure 4-25. MOV PM0, A; Example of PM0 as SFR Name

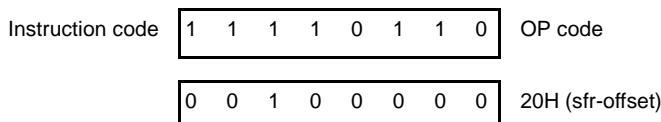
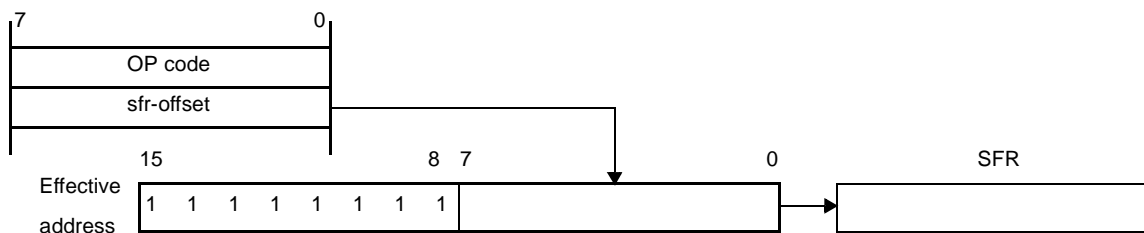

Figure 4-26. Outline of SFR Addressing



**(f) Register indirect addressing**

Register indirect addressing addresses memory with register pair contents specified as an operand. The register pair to be accessed is specified by the register bank selection flags (RBS0 and RBS1) and the register pair specification in instruction codes.

The operand format is shown below.

Identifier	Description
-	[DE], [HL]

Figure 4-27. MOV A, [DE]; Example of Access by Register Pair [DE]

Instruction code 

1	0	0	0	0	1	0	1
---	---	---	---	---	---	---	---

Figure 4-28. Outline of Register Indirect Addressing

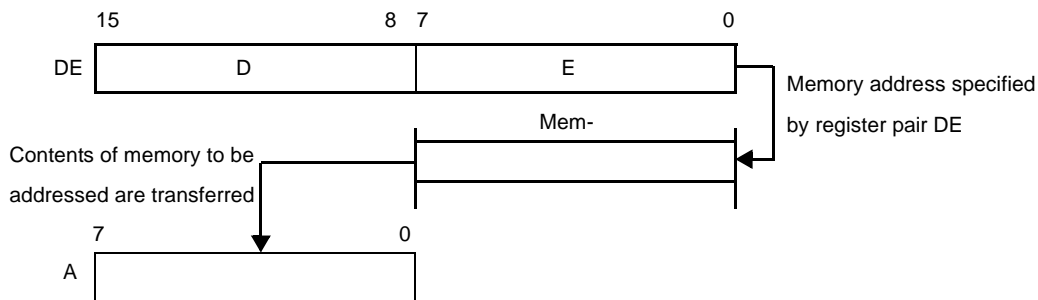

**(g) Based addressing**

Based addressing adds 8-bit immediate data (an offset) to the contents of the HL register pair (the base), and uses the sum to access memory. The bank selection flags (RBS0,RBS1) specify the bank of the HL register. In the addition, the offset data is expanded to 16 bits as a positive number. Overflow from bit 16 is ignored. This type of addressing can access the entire memory space. The operand format is shown below.

Identifier	Description
-	[HL + byte]

Figure 4-29. MOV A, [HL + 10H]; Example of 10H as Offset Byte

Instruction code 

1	0	1	0	1	1	1	0
---	---	---	---	---	---	---	---

0	0	0	1	0	0	0	0
---	---	---	---	---	---	---	---

**(h) Based indexed addressing**

Based indexed addressing adds an offset to the contents of the HL register (the base), and uses the sum to access memory. The offset is the contents of the B register or the C register, as specified by the instruction word. The HL and B or C registers that are actually accessed are the ones in the bank selected by the bank selection flags (RBS0,RBS1). In the addition, the contents of the B or C register is expanded to 16 bits as a positive number. Overflow from bit 16 is ignored. This type of addressing can access the entire memory space. The operand format is shown below.

Identifier	Description
-	[HL + B], [HL + C]

Figure 4-30. MOV A, [HL + B] ; Example of B as Offset

Instruction code 

1	0	1	0	1	0	1	1
---	---	---	---	---	---	---	---

(i) Stack addressing

Stack addressing accesses the stack indirectly using the contents of the stack pointer (SP). This type of addressing is employed automatically when the PUSH, POP, subroutine call, and return instructions are executed, and when registers are saved and restored upon generation of an interrupt request. Stack addressing is applied only to the internal high-speed RAM area.

Figure 4-31. Example of PUSH DE

Instruction code 

1	0	1	1	0	1	0	1
---	---	---	---	---	---	---	---

4.6.4 Instruction set

This chapter lists the instructions of the 78K0 microcontroller instruction set. These instructions are common to all microcontrollers in the 78K0 microcontroller.

(1) Expressive form of the operand and description method

The operands in the "Operands" field of each instruction are shown in the representation for that type of operand. (For details, see the assembler specifications.) When there are two or more ways to specify an operand in source code, select one of them. Alphabetic characters written by a capital letter, the symbols #, !, \$, [ ] are keywords and should be written just as they appear. Symbols have the following meanings.

#	Immediate data specification
!	absolute address specification
\$	relative address specification
[ ]	Indirect address specificatio

Specify immediate data with an appropriate value or label. When specifying a label, be sure to include the #, !, \$, [ ] symbol.

For register operands, r and rp can be replaced by register function names (X, A, C, etc.) or register absolute names (R0, R1, R2, etc., as shown in parentheses in the following table).

Table 4-25. Operand Type Representations and Source Code Formats

Format	Description
r	X(R0), A(R1), C(R2), B(R3), E(R4), D(R5), L(R6), H(R7)
rp	AX(RP0), BC(RP1), DE(RP2), HL(RP3)
sfr	Special-function register name <sup>Note</sup>
sfrp	Special-function register name (even addresses only of register supporting 16-bit operations <sup>Note</sup> )
saddr	0FE20H to 0FF1FH : Immediate data or label
saddrp	0FE20H to 0FF1FH : Immediate data or labels (even addresses only)

Format	Description
addr16	0000H to 0FFFFH : Immediate data or label (even addresses only for 16-bit data transfer instructions)
addr11	0800H to -0FFFH : Immediate data or label
addr5	0040H to 007FH : Immediate data or label (even addresses only)
word	16-bit immediate data or label
byte	8-bit immediate data or label
bit	3-bit immediate data or label
RBn	RB0, RB1, RB2, RB3

**Note** The range 0FFD0H to 0FFDFH cannot be accessed.

**Remark** See the user's manual of the target microprocessor for SFR names.

## (2) Operation field symbols

The "Operation" field uses the following symbols to designate the operation that occurs when the instruction is executed.

**Table 4-26. Operation Field Symbols**

Symbol	Function
A	A register:8-bit accumulator
X	X register
B	B register
C	C register
D	D register
E	E register
H	H register
L	L register
AX	AX register pair:16-bit accumulator
BC	BC register pair
DE	DE register pair
HL	HL register pair
PC	Program counter
SP	Stack pointer
PSW	Program status word
CY	Carry flag
AC	Auxiliary carry flag
Z	Zero flag
RBS	Register bank selection flag
IE	Interrupt request enable flag
NMIS	Nonmaskable interrupt service flag

Symbol	Function
()	Memory contents indicated by address or register contents in parentheses
XH, XL	16-bit registers: high-order 8 bits, low-order 8 bits
^	Logical AND
v	Logical OR
∨	Exclusive OR
—	Inverted data
addr16	16-bit immediate data
jdisp8	Signed 8-bit data (displacement value)

**(3) Flag field symbols**

The "Flag" field uses the following symbols to designate flag changes that occur when the instruction is executed.

**Table 4-27. Flag Field Symbols**

Symbol	Flag Change
(Blank)	Unchanged
0	Cleared to 0
1	Set to 1
x	Set or cleared according to the result
R	Previously saved value is restored

**(4) Clock numbers**

One instruction clock is equal to one CPU clock ( $f_{CPU}$ ), as selected with the processor control register (PCC).

(5) Instructions listed by type of addressing

(a) 8-bit instructions

MOV, XCH, ADD, ADDC, SUB, SUBC, AND, OR, XOR, CMP, MULU, DIVUW, INC, DEC, ROR, ROL, RORC, ROLC, ROR4, ROL4, PUSH, POP, DBNZ

Table 4-28. Instructions Listed by Type of Addressing (8-bit Instructions)

		2nd Operand													
		#byte	A	r <sup>Note</sup>	sfr	saddr	!addr16	PSW	[DE]	[HL]	[HL + byte] [HL + B] [HL + C]	\$addr16	1	None	
1st Operand	A	ADD ADDC SUB SUBC AND OR XOR CMP		MOV XCH ADD ADDC SUB SUBC AND OR XOR CMP	MOV XCH	MOV XCH ADD ADDC SUB SUBC AND OR XOR CMP	MOV XCH ADD ADDC SUB SUBC AND OR XOR CMP	MOV XCH	MOV XCH	MOV XCH ADD ADDC SUB SUBC AND OR XOR CMP	MOV XCH ADD ADDC SUB SUBC AND OR XOR CMP		ROR ROL RORC ROLC		
	r	MOV ADD ADDC SUB SUBC AND OR XOR CMP												INC DEC	
	B, C											DBNZ			
	sfr	MOV	MOV												
	saddr	MOV ADD ADDC SUB SUBC AND OR XOR CMP	MOV										DBNZ		INC DEC
	!addr16		MOV												

		2nd Operand												
		#byte	A	r <sup>Note</sup>	sfr	saddr	!addr16	PSW	[DE]	[HL]	[HL + byte] [HL + B] [HL + C]	\$addr16	1	None
PSW	MOV	MOV												PUSH POP
		MOV												
		MOV												ROR4 ROL4
		MOV												
	X													MULU
	C													DIVUW

**Note** Except r=A

**(b) 16-bit instructions**

MOVW, XCHW, ADDW, SUBW, CMPW, PUSH, POP, INCW, DECW

**Table 4-29. Instructions Listed by Type of Addressing (16-bit Instructions)**

		2nd Operand							
		#word	AX	rp <sup>Note</sup>	sfrp	saddrp	!addr16	SP	None
1st Operand	AX	ADDW SUBW CMPW		MOVW XCHW	MOVW	MOVW	MOVW	MOVW	
	rp	MOVW	MOVW Note						INCW DECW PUSH POP
	sfrp	MOVW	MOVW						
	saddrp	MOVW	MOVW						
	!addr16		MOVW						
	SP	MOVW	MOVW						

**Note** Only when rp = BC, DE, HL

(c) Bit manipulation instructions

MOV1, AND1, OR1, XOR1, SET1, CLR1, NOT1, BT, BF, BTCLR

Table 4-30. Instructions Listed by Type of Addressing (Bit Manipulation Instructions)

		2nd Operand							
		A.bit	sfr.bit	saddr.bit	PSW.bit	[HL].bit	CY	\$addr16	
1 st O p e r a n d	A.bit						MOV1	BT BF BTCLR	SET1 CLR1
	sfr.bit						MOV1	BT BF BTCLR	SET1 CLR1
	saddr.bit						MOV1	BT BF BTCLR	SET1 CLR1
	PSW.bit						MOV1	BT BF BTCLR	SET1 CLR1
	[HL].bit						MOV1	BT BF BTCLR	SET1 CLR1
	CY	MOV1 AND1 OR1 XOR1	MOV1 AND1 OR1 XOR1	MOV1 AND1 OR1 XOR1	MOV1 AND1 OR1 XOR1	MOV1 AND1 OR1 XOR1			SET1 CLR1 NOT1

(d) Call instructions/branch instructions

CALL, CALLF, CALLT, BR, BC, BNC, BZ, BNZ, BT, BF, BTCLR, DBNZ

Table 4-31. Instructions Listed by Type of Addressing (Call Instructions/Branch Instructions)

		2nd Operand					
		AX	!addr16	!addr11	[addr5]	\$addr16	
1 st O p e r a n d	Basic Instructions	BR	CALL BR	CALLF	CALLT	BR BC BNC BZ BNZ	
	Compound Instructions					BT BF BTCLR DBNZ	

(e) Other instructions

ADJBA, ADJBS, BRK, RET, RETI, RETB, SEL, NOP, EI, DI, HALT, STOP



4.6.5 Explanation of instructions

This section explains the instructions of 78K0 microcontrollers. All operands for a mnemonic are explained at the same time for that mnemonic.

Table 4-32. Assembly Language Instruction List

Function	Instruction
8-bit data transmission instructions	MOV, XCH
16-bit data transmission instructions	MOVW, XCHW
8-bit operation instructions	ADD, ADDC, SUB, SUBC, AND, OR, XOR, CMP
16-bit operation instructions	ADDW, SUBW, CMPW
Multiplication/division instructions	MULU, DIVUW
Increment/decrement instructions	INC, DEC, INCW, DECW
Rotate instructions	ROR, ROL, RORC, ROLC, ROR4, ROL4
BCD adjust Instructions	ADJBA, ADJBS
Bit manipulation instructions	MOV1, AND1, OR1, XOR1, SET1, CLR1, NOT1
Call return instructions	CALL, CALLF, CALLT, BRK, RET, RETI, RETB
Stack manipulation instructions	PUSH, POP, MOVW
Unconditional branch instruction	BR
Conditional branch instructions	BC, BNC, BZ, BNZ, BT, BF, BTCLR, DBNZ
CPU control instructions	SEL, NOP, EI, DI, HALT, STOP

The following information explains the individual instructions.  
 See the user's manual of the target microcontroller for instruction byte size.  
 All instructions are common to all the 78K0 microcontrollers.

**[Instruction format]**

Shows the basic written format of the instruction.

**[Operation]**

The instruction operation is shown by using the code address.

**[Operand]**

The operand that can be specified with this instruction is shown. Please see "(2) Operation field symbols" for descriptions of each operand.

**[Flag]**

Indicates the flag operation that changes by instruction execution.

Each flag operation symbol is shown in the conventions.

Symbol	Description
Blank	Unchanged
0	Cleared to 0
1	Set to 1
x	Set or cleared according to the result
R	Previously saved value is restored

**[Description]**

Describes the instruction operation in detail.

**[Description example]**

Description example of an instruction is indicated.

**(1) 8-bit data transmission instructions**

The following 8-bit data transmission instructions are available.

Instruction	Overview
MOV	Byte data transfer
XCH	Byte data exchange

**MOV**

Byte data transfer

**[Instruction format]**

MOV dst, src

**[Operation]**

dst &lt;- src

**[Operand]**

Operand (dst, src)
r, #byte
saddr, #byte
sfr, #byte
!addr16, #byte
A, r <sup>Note</sup>
r, A <sup>Note</sup>
A, saddr
saddr, A
A, sfr
sfr, A
A, !addr16
!addr16, A
PSW, #byte
A, PSW
PSW, A
A, [DE]
[DE], A
A, [HL]
[HL], A
A, [HL+byte]
[HL+byte], A
A, [HL+B]
[HL+B], A
A, [HL+C]
[HL+C], A

**Note** Except r = A.

**[Flag]**

**(1) PSW, #byte and PSW, A operands**

Z	AC	CY
x	x	x

x : Set or cleared according to the result

**(2) All other operand combinations**

Z	AC	CY

Blank : Unchanged

**[Description]**

- The contents of the source operand (src) specified by the 2nd operand are transferred to the destination operand (dst) specified by the 1st operand.
- No interrupts are acknowledged between the MOV PSW, #byte instruction/MOV PSW, A instruction and the next instruction.

**[Description example]**

```
MOV    A, #4DH    ; (1)
```

**(1) 4DH is transferred to the A register.**

**XCH**

Byte data exchange

**[Instruction format]**

XCH dst, src

**[Operation]**

dst <--> src

**[Operand]**

Operand (dst, src)
A, r <sup>Note</sup>
A, saddr
A, sfr
A, !addr16
A, [DE]
A, [HL]
A, [HL + byte]
A, [HL + B]
A, [HL + C]

**Note** Except r = A.

**[Flag]**

Z	AC	CY

Blank : Unchanged

**[Description]**

- The 1st and 2nd operand contents are exchanged.

**[Description example]**

```
XCH    A, 0FEBCH    ; (1)
```

(1) The A register contents and address 0FEBCH contents are exchanged.

**(2) 16-bit data transmission instructions**

The following 16-bit data transmission instructions are available.

Instruction	Overview
MOVW	Word data transfer
XCHW	Word data exchange

**MOVW**

Word data transfer

**[Instruction format]**

MOVW dst, src

**[Operation]**

dst <- src

**[Operand]**

Operand (dst, src)
rp, #word
saddrp, #word
sfrp, #word
AX, saddrp
saddrp, AX
AX, sfrp
sfrp, AX
AX, rp <sup>Note</sup>
rp, AX <sup>Note</sup>
AX, !addr16
!addr16, AX

**Note** Only when rp = BC, DE or HL

**[Flag]**

Z	AC	CY

Blank : Unchanged

**[Description]**

- The contents of the source operand (src) specified by the 2nd operand are transferred to the destination operand (dst) specified by the 1st operand.

**[Description example]**

```
MOVW    AX, HL    ; (1)
```

(1) The HL register contents are transferred to the AX register.



**[Cautions]**

- Only an even address can be specified. An odd address cannot be specified.

**XCHW**

Word data exchange

**[Instruction format]**

XCHW dst, src

**[Operation]**

dst <--> src

**[Operand]**

Operand (dst, src)
AX, rp <sup>Note</sup>

**Note** Only when rp = BC, DE or HL

**[Flag]**

Z	AC	CY

Blank : Unchanged

**[Description]**

- The 1st and 2nd operand contents are exchanged.

**[Description example]**

```
XCHW AX, BC ; (1)
```

(1) The memory contents of the AX register are exchanged with those of the BC register.

**(3) 8-bit operation instructions**

The following 8-bit operation instructions are available.

Instruction	Overview
<a href="#">ADD</a>	Byte data addition
<a href="#">ADDC</a>	Byte data addition including carry
<a href="#">SUB</a>	Byte data subtraction
<a href="#">SUBC</a>	Byte data subtraction including carry
<a href="#">AND</a>	Byte data AND operation
<a href="#">OR</a>	Byte data OR operation
<a href="#">XOR</a>	Byte data exclusive OR operation
<a href="#">CMP</a>	Byte data comparison

**ADD**

Byte data addition

**[Instruction format]**

ADD dst, src

**[Operation]**

dst, CY <- dst + src

**[Operand]**

Operand (dst, src)
A, #byte
saddr, #byte
A, r <sup>Note</sup>
r, A
A, saddr
A, !addr16
A, [HL]
A, [HL+byte]
A, [HL+B]
A, [HL+C]

**Note** Except r = A.

**[Flag]**

Z	AC	CY
x	x	x

x : Set or cleared according to the result

**[Description]**

- The destination operand (dst) specified by the 1st operand is added to the source operand (src) specified by the 2nd operand and the result is stored in the CY flag and the destination operand (dst).
- If the addition result shows that dst is 0, the Z flag is set (1). In all other cases, the Z flag is cleared (0).
- If the addition generates a carry out of bit 7, the CY flag is set (1). In all other cases, the CY flag is cleared (0).
- If the addition generates a carry for bit 4 out of bit 3, the AC flag is set (1). In all other cases, the AC flag is cleared (0).

**[Description example]**

ADD      CR10, #56H      ;    (1)
-----------------------------------

(1) 56H is added to the CR10 register and the result is stored in the CR10 register.

**ADDC**

Byte data addition including carry

**[Instruction format]**

ADDC dst, src

**[Operation]**

dst, CY <- dst + src + CY

**[Operand]**

Operand (dst, src)
A, #byte
saddr, #byte
A, r <sup>Note</sup>
r, A
A, saddr
A, !addr16
A, [HL]
A, [HL+byte]
A, [HL+B]
A, [HL+C]

**Note** Except r = A.

**[Flag]**

Z	AC	CY
x	x	x

x : Set or cleared according to the result

**[Description]**

- The destination operand (dst) specified by the 1st operand, the source operand (src) specified by the 2nd operand and the CY flag are added and the result is stored in the destination operand (dst) and the CY flag. The CY flag is added to the least significant bit. This instruction is mainly used to add two or more bytes.
- If the addition result shows that dst is 0, the Z flag is set (1). In all other cases, the Z flag is cleared (0).
- If the addition generates a carry out of bit 7, the CY flag is set (1). In all other cases, the CY flag is cleared (0).
- If the addition generates a carry for bit 4 out of bit 3, the AC flag is set (1). In all other cases, the AC flag is cleared (0).

**[Description example]**

ADDC    A, [HL+B]            ;    (1)
---------------------------------------

- (1) The A register contents and the contents at address (HL register + (B register) ) and the CY flag are added and the result is stored in the A register.

**SUB**

Byte data subtraction

**[Instruction format]**

SUB dst, src

**[Operation]**

dst, CY <- dst - src

**[Operand]**

Operand (dst, src)
A, #byte
saddr, #byte
A, r <sup>Note</sup>
r, A
A, saddr
A, !addr16
A, [HL]
A, [HL+byte]
A, [HL+B]
A, [HL+C]

**Note** Except r = A.

**[Flag]**

Z	AC	CY
x	x	x

x : Set or cleared according to the result

**[Description]**

- The source operand (src) specified by the 2nd operand is subtracted from the destination operand (dst) specified by the 1st operand and the result is stored in the destination operand (dst) and the CY flag. The destination operand can be cleared to 0 by equalizing the source operand (src) and the destination operand (dst).
- If the subtraction shows that dst is 0, the Z flag is set (1). In all other cases, the Z flag is cleared (0).
- If the subtraction generates a borrow out of bit 7, the CY flag is set (1). In all other cases, the CY flag is cleared (0).
- If the subtraction generates a borrow for bit 3 out of bit 4, the AC flag is set (1). In all other cases, the AC flag is cleared (0).



**[Description example]**

SUB     D, A                   ;   (1)
--

- (1) The A register is subtracted from the D register and the result is stored in the D register.

**SUBC**

Byte data subtraction including carry

**[Instruction format]**

SUBC dst, src

**[Operation]**

dst, CY <- dst - src - CY

**[Operand]**

Operand (dst, src)
A, #byte
saddr, #byte
A, r <sup>Note</sup>
r, A
A, saddr
A, !addr16
A, [HL]
A, [HL+byte]
A, [HL+B]
A, [HL+C]

**Note** Except r = A.

**[Flag]**

Z	AC	CY
x	x	x

x : Set or cleared according to the result

**[Description]**

- The source operand (src) specified by the 2nd operand and the CY flag are subtracted from the destination operand (dst) specified by the 1st operand and the result is stored in the destination operand (dst).  
The CY flag is subtracted from the least significant bit. This instruction is mainly used for subtraction of two or more bytes.
- If the subtraction shows that dst is 0, the Z flag is set (1). In all other cases, the Z flag is cleared (0).
- If the subtraction generates a borrow out of bit 7, the CY flag is set (1). In all other cases, the CY flag is cleared (0).
- If the subtraction generates a borrow for bit 3 out of bit 4, the AC flag is set (1). In all other cases, the AC flag is cleared (0).

**[Description example]**

SUBC    A, [HL]                    ;    (1)
---

- (1) The (HL register) address contents and the CY flag are subtracted from the A register and the result is stored in the A register.

**AND**

Byte data AND operation

**[Instruction format]**

AND dst, src

**[Operation]**

dst <- dst ^ src

**[Operand]**

Operand (dst, src)
A, #byte
saddr, #byte
A, r <sup>Note</sup>
r, A
A, saddr
A, !addr16
A, [HL]
A, [HL+byte]
A, [HL+B]
A, [HL+C]

**Note** Except r = A.

**[Flag]**

Z	AC	CY
x		

Blank : Unchanged

x : Set or cleared according to the result

**[Description]**

- Bit-wise logical product is obtained from the destination operand (dst) specified by the 1st operand and the source operand (src) specified by the 2nd operand and the result is stored in the destination operand (dst).
- If the logical product shows that all bits are 0, the Z flag is set (1). In all other cases, the Z flag is cleared (0).

**[Description example]**

AND      0FEBAH, #11011100B      ; (1)
--

- (1) Bit-wise logical product of 0FEBAH contents and 11011100B is obtained and the result is stored at 0FEBAH.

**OR**

Byte data OR operation

**[Instruction format]**

OR dst, src

**[Operation]**

dst <- dst v src

**[Operand]**

Operand (dst, src)
A, #byte
saddr, #byte
A, r <sup>Note</sup>
r, A
A, saddr
A, !addr16
A, [HL]
A, [HL+byte]
A, [HL+B]
A, [HL+C]

**Note** Except r = A.

**[Flag]**

Z	AC	CY
x		

Blank : Unchanged

x : Set or cleared according to the result

**[Description]**

- The bit-wise logical sum is obtained from the destination operand (dst) specified by the 1st operand and the source operand (src) specified by the 2nd operand and the result is stored in the destination operand (dst).
- If the logical sum shows that all bits are 0, the Z flag is set (1). In all other cases, the Z flag is cleared (0).

**[Description example]**

OR	A, 0FE98H	;	(1)
----	-----------	---	-----

(1) The bit-wise logical sum of the A register and 0FE98H is obtained and the result is stored in the A register.

**XOR**

Byte data exclusive OR operation

**[Instruction format]**

XOR dst, src

**[Operation]**

dst <- dst  $\vee$  src

**[Operand]**

Operand (dst, src)
A, #byte
saddr, #byte
A, r <sup>Note</sup>
r, A
A, saddr
A, !addr16
A, [HL]
A, [HL+byte]
A, [HL+B]
A, [HL+C]

**Note** Except r = A.

**[Flag]**

Z	AC	CY
x		

Blank : Unchanged

x : Set or cleared according to the result

**[Description]**

- The bit-wise exclusive logical sum is obtained from the destination operand (dst) specified by the 1st operand and the source operand (src) specified by the 2nd operand and the result is stored in the destination operand (dst). Logical negation of all bits of the destination operand (dst) is possible by selecting #0FFH for the source operand (src) with this instruction.
- If the exclusive logical sum shows that all bits are 0, the Z flag is set (1). In all other cases, the Z flag is cleared (0).



**[Description example]**

XOR     A, L             ;   (1)
----------------------------------

- (1) The bit-wise exclusive logical sum of the A and L registers is obtained and the result is stored in the A register.

**CMP**

Byte data comparison

**[Instruction format]**

CMP dst, src

**[Operation]**

dst - src

**[Operand]**

Operand (dst, src)
A, #byte
saddr, #byte
A, r <sup>Note</sup>
r, A
A, saddr
A, !addr16
A, [HL]
A, [HL+byte]
A, [HL+B]
A, [HL+C]

**Note** Except r = A.

**[Flag]**

Z	AC	CY
x	x	x

x : Set or cleared according to the result

**[Description]**

- The source operand (src) specified by the 2nd operand is subtracted from the destination operand (dst) specified by the 1st operand.  
The subtraction result is not stored anywhere and only the Z, AC and CY flags are changed.
- If the subtraction result is 0, the Z flag is set (1). In all other cases, the Z flag is cleared (0).
- If the subtraction generates a borrow out of bit 7, the CY flag is set (1). In all other cases, the CY flag is cleared (0).
- If the subtraction generates a borrow for bit 3 out of bit 4, the AC flag is set (1). In all other cases, the AC flag is cleared (0).

**[Description example]**

CMP	0FE38H, #38H	;	(1)
-----	--------------	---	-----

- (1) 38H is subtracted from the contents at address 0FE38H and only the flags are changed (comparison of contents at address 0FE38H and the immediate data).

**(4) 16-bit operation instructions**

The following 16-bit operation instructions are available.

Instruction	Overview
<a href="#">ADDW</a>	Word data addition
<a href="#">SUBW</a>	Word data subtraction
<a href="#">CMPW</a>	Word data comparison

**ADDW**

Word data addition

**[Instruction format]**

ADDW dst, src

**[Operation]**

dst, CY <- dst + src

**[Operand]**

Operand (dst, src)
AX, #word

**[Flag]**

Z	AC	CY
x	x	x

x : Set or cleared according to the result

**[Description]**

- The destination operand (dst) specified by the 1st operand is added to the source operand (src) specified by the 2nd operand and the result is stored in the destination operand (dst).
- If the addition result shows that dst is 0, the Z flag is set (1). In all other cases, the Z flag is cleared (0).
- If the addition generates a carry out of bit 15, the CY flag is set (1). In all other cases, the CY flag is cleared (0).
- As a result of addition, the AC flag becomes undefined.

**[Description example]**

```
ADDW AX, #ABCDH ; (1)
```

(1) ABCDH is added to the AX register and the result is stored in the AX register.

**SUBW**

Word data subtraction

**[Instruction format]**

SUBW dst, src

**[Operation]**

dst, CY <- dst - src

**[Operand]**

Operand (dst, src)
AX, #word

**[Flag]**

Z	AC	CY
x	x	x

x : Set or cleared according to the result

**[Description]**

- The source operand (src) specified by the 2nd operand is subtracted from the destination operand (dst) specified by the 1st operand and the result is stored in the destination operand (dst) and the CY flag.  
The destination operand can be cleared to 0 by equalizing the source operand (src) and the destination operand (dst).
- If the subtraction shows that dst is 0, the Z flag is set (1). In all other cases, the Z flag is cleared (0).
- If the subtraction generates a borrow out of bit 15, the CY flag is set (1). In all other cases, the CY flag is cleared (0).
- As a result of subtraction, the AC flag becomes undefined.

**[Description example]**

```
SUBW AX, #ABCDH ; (1)
```

**(1) ABCDH is subtracted from the AX register contents and the result is stored in the AX register.**

**CMPW**

Word data comparison

**[Instruction format]**

CMPW dst, src

**[Operation]**

dst - src

**[Operand]**

Operand (dst, src)
AX, #word

**[Flag]**

Z	AC	CY
x	x	x

x : Set or cleared according to the result

**[Description]**

- The source operand (src) specified by the 2nd operand is subtracted from the destination operand (dst) specified by the 1st operand.  
The subtraction result is not stored anywhere and only the Z, AC and CY flags are changed.
- If the subtraction result is 0, the Z flag is set (1). In all other cases, the Z flag is cleared (0).
- If the subtraction generates a borrow out of bit 15, the CY flag is set (1). In all other cases, the CY flag is cleared (0).
- As a result of subtraction, the AC flag becomes undefined.

**[Description example]**

```
CMPW AX, #ABCDH ; (1)
```

**(1) ABCDH is subtracted from the AX register and only the flags are changed.  
(comparison of the AX register and the immediate data)**

**(5) Multiplication/division instructions**

The following multiply and division instructions are available.

Instruction	Overview
MULU	Unsigned data multiplication
DIVUW	The following multiplication and division instructions are supported.



**MULU**

Unsigned data multiplication

**[Instruction format]**

MULU src

**[Operation]**

AX <- A x src

**[Operand]**

Operand (src)
X

**[Flag]**

Z	AC	CY

Blank : Unchanged

**[Description]**

- The A register contents and the source operand (src) data are multiplied as unsigned data and the result is stored in the AX register.

**[Description example]**

```
MULU X ; (1)
```

- (1) The A register contents and the X register contents are multiplied and the result is stored in the AX register.

**DIVUW**

The following multiplication and division instructions are supported.

**[Instruction format]**

DIVUW dst

**[Operation]**

AX (quotient), dst (remainder) <- AX ÷ dst

**[Operand]**

Operand (src)
C

**[Flag]**

Z	AC	CY

Blank : Unchanged

**[Description]**

- The AX register contents are divided by the destination operand (dst) contents and the quotient and the remainder are stored in the AX register and the destination operand (dst), respectively.
- Division is executed using the AX register and destination operand (dst) contents as unsigned data.
- However, when the destination operand (dst) is 0, the X register contents are stored in the C register and AX becomes 0FFFFH.

**[Description example]**

```
DIVUW C ; (1)
```

- (1) The AX register contents are divided by the C register contents and the quotient and the remainder are stored in the AX register and the C register, respectively.

**(6) Increment/decrement instructions**

The following increment/decrement instructions are available.

Instruction	Overview
<a href="#">INC</a>	Byte data increment
<a href="#">DEC</a>	Byte data decrement
<a href="#">INCW</a>	Word data increment
<a href="#">DECW</a>	Word data decrement

**INC**

Byte data increment

**[Instruction format]**

INC dst

**[Operation]**

dst <- dst + 1

**[Operand]**

Operand (src)
r
saddr

**[Flag]**

Z	AC	CY
x	x	

Blank : Unchanged

x : Set or cleared according to the result

**[Description]**

- The destination operand (dst) contents are incremented by only one.
- If the increment result is 0, the Z flag is set (1). In all other cases, the Z flag is cleared (0).
- If the increment generates a carry for bit 4 out of bit 3, the AC flag is set (1). In all other cases, the AC flag is cleared (0).
- Because this instruction is frequently used for increment of a counter for repeated operations and an indexed addressing offset register, the CY flag contents are not changed (to hold the CY flag contents in multiple-byte operation).

**[Description example]**

```
INC    B            ; (1)
```

(1) The B register is incremented.

**DEC**

Byte data decrement

**[Instruction format]**

DEC dst

**[Operation]**

dst <- dst - 1

**[Operand]**

Operand (src)
r
saddr

**[Flag]**

Z	AC	CY
x	x	

Blank : Unchanged

x : Set or cleared according to the result

**[Description]**

- The destination operand (dst) contents are decremented by only one.
- If the decrement result is 0, the Z flag is set (1). In all other cases, the Z flag is cleared (0).
- If the decrement generates a carry for bit 3 out of bit 4, the AC flag is set (1). In all other cases, the AC flag is cleared (0).
- Because this instruction is frequently used for a counter for repeated operations and an indexed addressing offset register, the CY flag contents are not changed (to hold the CY flag contents in multiple-byte operation).
- If dst is the B or C register or saddr, and it is not desired to change the AC and CY flag contents, the DBNZ instruction can be used.

**[Description example]**

```
DEC    0FE92H    ; (1)
```

(1) The contents at address 0FE92H are decremented.

**INCW**

Word data increment

**[Instruction format]**

INCW dst

**[Operation]**

dst <- dst + 1

**[Operand]**

Operand (src)
rp

**[Flag]**

Z	AC	CY

Blank : Unchanged

**[Description]**

- The destination operand (dst) contents are incremented by only one.
- Because this instruction is frequently used for increment of a register (pointer) used for addressing, the Z, AC and CY flag contents are not changed.

**[Description example]**

```
INCW HL ; (1)
```

**(1) The HL register is incremented.**

**DECW**

Word data decrement

**[Instruction format]**

DECW dst

**[Operation]**

dst <- dst - 1

**[Operand]**

Operand (src)
rp

**[Flag]**

Z	AC	CY

Blank : Unchanged

**[Description]**

- The destination operand (dst) contents are decremented by only one.
- Because this instruction is frequently used for decrement of a register (pointer) used for addressing, the Z, AC and CY flag contents are not changed.

**[Description example]**

```
DECW DE ; (1)
```

(1) The DE register is decremented.

**(7) Rotate instructions**

The following rotation instructions are available.

Instruction	Overview
ROR	Byte data rotation to the right
ROL	Byte data rotation to the left
RORC	Byte data rotation to the right with carry
ROLC	Byte data rotation to the left with carry
ROR4	Right Digit Rotation
ROL4	Left Digit Rotation



**ROR**

Byte data rotation to the right

**[Instruction format]**

ROR dst, cnt

**[Operation]**

(CY, dst<sub>7</sub> ← dst<sub>0</sub>, dst<sub>m-1</sub> ← dst<sub>m</sub>) x one time

**[Operand]**

Operand (dst, cnt)
A, 1

**[Flag]**

Z	AC	CY
		x

Blank : Unchanged

x : Set or cleared according to the result

**[Description]**

- The destination operand (dst) contents specified by the 1st operand are rotated to the right just once.
- The LSB (bit 0) contents are simultaneously rotated to the MSB (bit 7) and transferred to the CY flag.

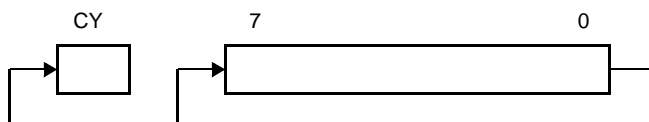

**[Description example]**

```
ROR    A, 1    ; (1)
```

(1) The A register contents are rotated to the right by one bit.

**ROL**

Byte data rotation to the left

**[Instruction format]**

ROL dst, cnt

**[Operation]**

(CY, dst<sub>0</sub> <- dst<sub>7</sub>, dst<sub>m+1</sub> <- dst<sub>m</sub>) x one time

**[Operand]**

Operand (dst, cnt)
A, 1

**[Flag]**

Z	AC	CY
		x

Blank : Unchanged

x : Set or cleared according to the result

**[Description]**

- The destination operand (dst) contents specified by the 1st operand are rotated to the left just once.
- The MSB (bit 7) contents are simultaneously rotated to the LSB (bit 0) and transferred to the CY flag.

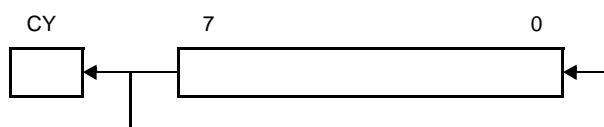

**[Description example]**

```
ROL    A, 1    ; (1)
```

(1) The A register contents are rotated to the left by one bit.

**RORC**

Byte data rotation to the right with carry

**[Instruction format]**

RORC dst, cnt

**[Operation]**

(CY ← dst<sub>0</sub>, dst<sub>7</sub> ← CY, dst<sub>m-1</sub> ← dst<sub>m</sub>) x one time

**[Operand]**

Operand (dst, cnt)
A, 1

**[Flag]**

Z	AC	CY
		x

Blank : Unchanged

x : Set or cleared according to the result

**[Description]**

- The destination operand (dst) contents specified by the 1st operand are rotated just once to the right with carry.

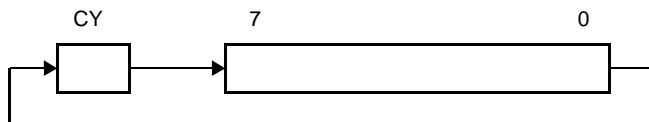

**[Description example]**

```
RORC A, 1 ; (1)
```

(1) The A register contents are rotated to the right by one bit including the CY flag.

**ROLC**

Byte data rotation to the left with carry

**[Instruction format]**

ROLC dst, cnt

**[Operation]**

(CY ← dst<sub>7</sub>, dst<sub>0</sub> ← CY, dst<sub>m+1</sub> ← dst<sub>m</sub>) x one time

**[Operand]**

Operand (dst, cnt)
A, 1

**[Flag]**

Z	AC	CY
		x

Blank : Unchanged

x : Set or cleared according to the result

**[Description]**

- The destination operand (dst) contents specified by the 1st operand are rotated just once to the left with carry.

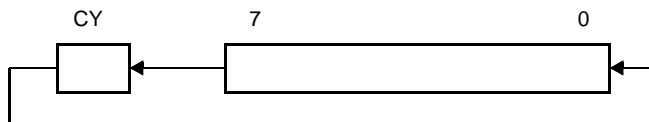

**[Description example]**

```
ROLC A, 1 ; (1)
```

(1) The A register contents are rotated to the left by one bit including the CY flag.

**ROR4**

Right Digit Rotation

**[Instruction format]**

ROR4 dst

**[Operation]**

$A_{3-0} \leftarrow (dst)_{3-0}, (dst)_{7-4} \leftarrow A_{3-0}, (dst)_{3-0} \leftarrow (dst)_{7-4}$

**[Operand]**

Operand (dst)
[HL] <sup>Note</sup>

**Note** Specify an area other than the SFR area as operand [HL].

**[Flag]**

Z	AC	CY

Blank : Unchanged

**[Description]**

- The lower 4 bits of the A register and the 2-digit data (4-bit data) of the destination operand (dst) are rotated to the right.

The higher 4 bits of the A register remain unchanged.

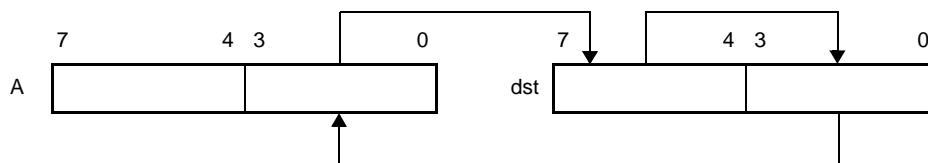

**[Description example]**

ROR4 [HL] ; (1)

(1) Rightward digit rotation is executed with the memory contents specified by the A and HL registers.

	A				(HL)			
	7	4	3	0	7	4	3	0
Before execution	1	0	1	0	0	0	1	1
After execution	1	0	1	0	0	0	1	1

**ROL4**

Left Digit Rotation

**[Instruction format]**

ROL4 dst

**[Operation]**

$A_{3-0} \leftarrow (dst)_{7-4}, (dst)_{3-0} \leftarrow A_{3-0}, (dst)_{7-4} \leftarrow (dst)_{3-0}$

**[Operand]**

Operand (dst)
[HL] <sup>Note</sup>

**Note** Specify an area other than the SFR area as operand [HL].

**[Flag]**

Z	AC	CY

Blank : Unchanged

**[Description]**

- The lower 4 bits of the A register and the 2-digit data (4-bit data) of the destination operand (dst) are rotated to the left.

The higher 4 bits of the A register remain unchanged.

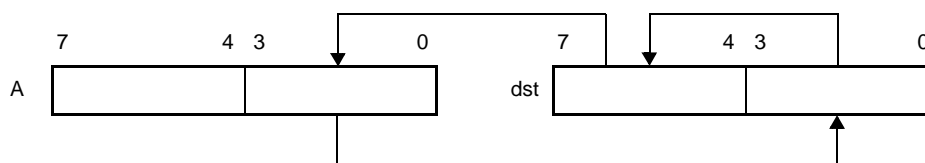

**[Description example]**

```
ROL4 [HL] ; (1)
```

(1) Leftward digit rotation is executed with the memory contents specified by the A and HL registers.

	A	(HL)
	7      4 3      0	7      4 3      0
Before execution	0 0 0 1   0 0 1 0	0 1 0 0   1 0 0 0
After execution	0 0 0 1   0 1 0 0	1 0 0 0   0 0 1 0

**(8) BCD adjust Instructions**

The following BCD adjust instructions are available.

Instruction	Overview
<a href="#">ADJBA</a>	Decimal adjustment of addition result
<a href="#">ADJBS</a>	Decimal adjustment of subtraction result

**ADJBA**

Decimal adjustment of addition results

**[Instruction format]**

ADJBA

**[Operation]**

Decimal Adjust Accumulator for Addition

**[Operand]**

None

**[Flag]**

Z	AC	CY
x	x	x

x : Set or cleared according to the result

**[Description]**

- The A register, CY flag and AC flag are decimally adjusted from their contents.  
This instruction carries out an operation having meaning only when the BCD (binary coded decimal) data is added and the addition result is stored in the A register (in all other cases, the instruction carries out an operation having no meaning). See the table below for the adjustment method.
- If the adjustment result shows that the A register contents are 0, the Z flag is set (1). In all other cases, the Z flag is cleared (0).

Condition		Operation
A <sub>3-0</sub> <= 9 AC = 0	A <sub>7-4</sub> <= 9 and CY = 0	A <- A, CY <- 0, AC <- 0
	A <sub>7-4</sub> >= 10 or CY = 1	A <- A + 01100000B, CY <- 1, AC <- 0
A <sub>3-0</sub> >= 10 AC = 0	A <sub>7-4</sub> < 9 and CY = 0	A <- A + 00000110B, CY <- 0, AC <- 1
	A <sub>7-4</sub> >= 9 or CY = 1	A <- A + 01100110B, CY <- 1, AC <- 1
AC = 1	A <sub>7-4</sub> <= 9 and CY = 0	A <- A + 00000110B, CY <- 0, AC <- 0
	A <sub>7-4</sub> >= 10 or CY = 1	A <- A + 01100110B, CY <- 1, AC <- 0



**ADJBS**

Decimal adjustment of subtraction result

**[Instruction format]**

ADJBSt

**[Operation]**

Decimal Adjust Accumulator for Subtraction

**[Operand]**

None

**[Flag]**

Z	AC	CY
x	x	x

x : Set or cleared according to the result

**[Description]**

- The A register, CY flag and AC flag are decimally adjusted from their contents. This instruction carries out an operation having meaning only when the BCD (binary coded decimal) data is subtracted and the subtraction result is stored in the A register (in all other cases, the instruction carries out an operation having no meaning). See the table below for the adjustment method.
- If the adjustment result shows that the A register contents are 0, the Z flag is set (1). In all other cases, the Z flag is cleared (0).

Condition		Operation
AC = 0	CY = 0	$A \leftarrow A, CY \leftarrow 0, AC \leftarrow 0$
	CY = 1	$A \leftarrow A + 01100000B, CY \leftarrow 1, AC \leftarrow 0$
AC = 1	CY = 0	$A \leftarrow A + 00000110B, CY \leftarrow 0, AC \leftarrow 0$
	CY = 1	$A \leftarrow A + 01100110B, CY \leftarrow 1, AC \leftarrow 0$

**(9) Bit manipulation instructions**

The following bit manipulation instructions are available.

Instruction	Overview
<a href="#">MOV1</a>	1-bit data transfer
<a href="#">AND1</a>	1-bit data AND operation
<a href="#">OR1</a>	1-bit data OR operation
<a href="#">XOR1</a>	1-bit data exclusive OR operation
<a href="#">SET1</a>	1-bit data set
<a href="#">CLR1</a>	1-bit data clear
<a href="#">NOT1</a>	1-bit data logical negation

**MOV1**

1-bit data transfer

**[Instruction format]**

MOV1 dst, src

**[Operation]**

dst <- src

**[Operand]**

Operand (dst, src)
CY, saddr.bit
CY, sfr.bit
CY, A.bit
CY, PSW.bit
CY, [HL].bit
saddr.bit, CY
sfr.bit, CY
A.bit, CY
PSW.bit, CY
[HL].bit, CY

**[Flag]**

**(1) dst = CY**

Z	AC	CY
		x

Blank : Unchanged

x : Set or cleared according to the result

**(2) dst = PSW.bit**

Z	AC	CY
x	x	

Blank : Unchanged

x : Set or cleared according to the result

**(3) All other operand combinations**

Z	AC	CY

Blank : Unchanged

**[Description]**

- Bit data of the source operand (src) specified by the 2nd operand is transferred to the destination operand (dst) specified by the 1st operand.
- When the destination operand (dst) is CY or PSW.bit, only the corresponding flag is changed.

**[Description example]**

```
MOV1    P3.4, CY    ; (1)
```

- (1) The CY flag contents are transferred to bit 4 of port 3.**

**AND1**

1-bit data AND operation

**[Instruction format]**

AND1 dst, src

**[Operation]**

dst <- dst ^ src

**[Operand]**

Operand (dst, src)
CY, saddr.bit
CY, sfr.bit
CY, A.bit
CY, PSW.bit
CY, [HL].bit

**[Flag]**

Z	AC	CY
		x

Blank : Unchanged  
 x : Set or cleared according to the result

**[Description]**

- Logical product of bit data of the destination operand (dst) specified by the 1st operand and the source operand (src) specified by the 2nd operand is obtained and the result is stored in the destination operand (dst).
- The operation result is stored in the CY flag (because of the destination operand (dst) ).

**[Description example]**

```
AND1    CY, 0FE7FH.3    ; (1)
```

(1) Logical product of 0FE7FH bit 3 and the CY flag is obtained and the result is stored in the CY flag.

**OR1**

1-bit data OR operation

**[Instruction format]**

OR1 dst, src

**[Operation]**

dst <- dst v src

**[Operand]**

Operand (dst, src)
CY, saddr.bit
CY, sfr.bit
CY, A.bit
CY, PSW.bit
CY, [HL].bit

**[Flag]**

Z	AC	CY
		x

Blank : Unchanged

x : Set or cleared according to the result

**[Description]**

- The logical sum of bit data of the destination operand (dst) specified by the 1st operand and the source operand (src) specified by the 2nd operand is obtained and the result is stored in the destination operand (dst).
- The operation result is stored in the CY flag (because of the destination operand (dst) ).

**[Description example]**

```
OR1    CY, P2.5    ; (1)
```

(1) The logical sum of port 2 bit 5 and the CY flag is obtained and the result is stored in the CY flag.

**XOR1**

1-bit data exclusive OR operation

**[Instruction format]**

XOR1 dst, src

**[Operation]**

dst <- dst ∨ src

**[Operand]**

Operand (dst, src)
CY, saddr.bit
CY, sfr.bit
CY, A.bit
CY, PSW.bit
CY, [HL].bit

**[Flag]**

Z	AC	CY
		x

Blank : Unchanged  
 x : Set or cleared according to the result

**[Description]**

- The exclusive logical sum of bit data of the destination operand (dst) specified by the 1st operand and the source operand (src) specified by the 2nd operand is obtained and the result is stored in the destination operand (dst).
- The operation result is stored in the CY flag (because of the destination operand (dst) ).

**[Description example]**

```
XOR1 CY, A.7 ; (1)
```

(1) The exclusive logical sum of the A register bit 7 and the CY flag is obtained and the result is stored in the CY flag.

**SET1**

1-bit data set

**[Instruction format]**

SET1 dst

**[Operation]**

dst <- 1

**[Operand]**

Operand (dst)
saddr.bit
sfr.bit
A.bit
PSW.bit
[HL].bit
CY

**[Flag]**

**(1) dst = PSW.bit**

Z	AC	CY
x	x	x

x : Set or cleared according to the result

**(2) dst = CY**

Z	AC	CY
		1

Blank : Unchanged

1 : Set to 1

**(3) All other operand combinations**

Z	AC	CY

Blank : Unchanged



**[Description]**

- The destination operand (dst) is set (1).
- When the destination operand (dst) is CY or PSW.bit, only the corresponding flag is set (1).

**[Description example]**

```
SET1    0FE55H.1    ; (1)
```

**(1) Bit 1 of 0FE55H is set (1).**

**CLR1**

1-bit data clear

**[Instruction format]**

CLR1 dst

**[Operation]**

dst <- 0

**[Operand]**

Operand (dst)
saddr.bit
sfr.bit
A.bit
PSW.bit
[HL].bit
CY

**[Flag]**

**(1) dst = PSW.bit**

Z	AC	CY
x	x	x

x : Set or cleared according to the result

**(2) dst = CY**

Z	AC	CY
		0

Blank : Unchanged

0 : Cleared to 0

**(3) All other operand combinations**

Z	AC	CY

Blank : Unchanged

**[Description]**

- The destination operand (dst) is cleared (0).
- When the destination operand (dst) is CY or PSW.bit, only the corresponding flag is cleared (0).

**[Description example]**

```
CLR1    P3.7    ; (1)
```

**(1) Bit 7 of port 3 is cleared (0).**

**NOT1**

1-bit data logical negation

**[Instruction format]**

NOT1 dst

**[Operation]**

dst ←  $\overline{\text{dst}}$

**[Operand]**

Operand (dst)
CY

**[Flag]**

Z	AC	CY
		x

Blank : Unchanged

x : Set or cleared according to the result

**[Description]**

- The CY flag is inverted.

**[Description example]**

NOT1 CY ; (1)

(1) The CY flag is inverted.

**(10) Call return instructions**

The following call return instructions are available.

Instruction	Overview
CALL	Subroutine call (16-bit direct)
CALLF	Subroutine call (11-bit direct specification)
CALLT	Subroutine call (call table reference)
BRK	Software vector interrupt
RET	Return from subroutine
RETI	Return from hardware vector interrupt
RETB	Return from software vectored interrupt

**CALL**

Subroutine call (16-bit direct)

**[Instruction format]**

CALL target

**[Operation]**

$(SP - 1) \leftarrow (PC + 3)_H,$

$(SP - 2) \leftarrow (PC + 3)_L,$

$SP \leftarrow SP - 2,$

$PC \leftarrow \text{target}$

**[Operand]**

Operand (target)
!addr16

**[Flag]**

Z	AC	CY

Blank : Unchanged

**[Description]**

- This is a subroutine call with a 16-bit absolute address or a register indirect address.
- The start address (PC+3) of the next instruction is saved in the stack and is branched to the address specified by the target operand (target).

**[Description example]**

```
CALL    !3059H    ; (1)
```

**(1) Subroutine call to 3059H**

**CALLF**

Subroutine call (11-bit direct specification)

**[Instruction format]**

CALLF [addr5]

**[Operation]**

(SP - 1) <- (PC + 2)<sub>H</sub>,  
 (SP - 2) <- (PC + 2)<sub>L</sub>,  
 SP <- SP - 2  
 PC <- target

**[Operand]**

Operand (target)
!addr11

**[Flag]**

Z	AC	CY

Blank : Unchanged

**[Description]**

- This is a subroutine call which can only be branched to addresses 0800H to 0FFFH.
- The start address (PC + 2) of the next instruction is saved in the stack and is branched in the range of addresses 0800H to 0FFFH.
- Only the lower 11 bits of an address are specified (with the higher 5 bits fixed to 00001B).
- The program size can be compressed by locating the subroutine at 0800H to 0FFFH and using this instruction. If the program is in the external memory, the execution time can be decreased.

**[Description example]**

```
CALLF !0C2AH ; (1)
```

(1) Subroutine call to 0C2AH

**CALLT**

Subroutine call (call table reference)

**[Instruction format]**

CALLT [addr5]

**[Operation]**

(SP - 1) <- (PC + 1)<sub>H</sub>,  
 (SP - 2) <- (PC + 1)<sub>L</sub>,  
 SP <- SP - 2  
 PC<sub>H</sub> <- (00000000, addr5 + 1),  
 PC<sub>L</sub> <- (00000000, addr5),

**[Operand]**

Operand ([addr5])
[addr5]

**[Flag]**

Z	AC	CY

Blank : Unchanged

**[Description]**

- This is a subroutine call for call table reference.
- The start address (PC+1) of the next instruction is saved in the stack and is branched to the address indicated with the word data of a call table (with the higher 8 bits of the address fixed to 00000000B, and the lower 5 bits indicated with addr5).

**[Description example]**

```
CALLT [40H] ; (1)
```

(1) Subroutine call to the word data addresses 0040H and 0041H.



**BRK**

Software vector interrupt

**[Instruction format]**

BRK

**[Operation]**

(SP - 1) <- PSW,  
 (SP - 2) <- (PC + 1)<sub>H</sub>,  
 (SP - 3) <- (PC + 1)<sub>L</sub>,  
 IE <- 0  
 SP <- SP - 3,  
 PC<sub>H</sub> <- (3FH),  
 PC<sub>L</sub> <- (3EH),

**[Operand]**

None

**[Flag]**

Z	AC	CY

Blank : Unchanged

**[Description]**

- This is a software interrupt instruction.
- PSW and the next instruction address (PC+1) are saved to the stack. After that, the IE flag is cleared (0) and the saved data is branched to the address indicated with the word data at the vector address (0007EH, 003EH). Because the IE flag is cleared (0), the subsequent maskable vectored interrupts are disabled.
- The RETB instruction is used to return from the software vectored interrupt generated with this instruction.

**RET**

Return from subroutine

**[Instruction format]**

RET

**[Operation]**

PC<sub>L</sub> ← (SP),  
 PC<sub>H</sub> ← (SP + 1),  
 SP ← SP + 2,

**[Operand]**

None

**[Flag]**

Z	AC	CY

Blank : Unchanged

**[Description]**

- This is a return instruction from the subroutine call made with the CALLCALLF, and CALLT instructions.
- The word data saved to the stack returns to the PC, and the program returns from the subroutine.

**RETI**

Return from hardware vector interrupt

**[Instruction format]**

RETI

**[Operation]**

PC<sub>L</sub> <- (SP),  
 PC<sub>H</sub> <- (SP + 1),  
 PSW <- (SP + 2),  
 SP <- SP + 3  
 NMIS <- 0

**[Operand]**

None

**[Flag]**

Z	AC	CY
R	R	R

R : Previously saved value is restored

**[Description]**

- This is a return instruction from the vectored interrupt.
- The data saved to the stack returns to the PC and the PSW, and the program returns from the interrupt servicing routine.
- This instruction cannot be used for return from the software interrupt with the BRK instruction.
- None of interrupts are acknowledged between this instruction and the next instruction to be executed.
- The NMIS flag is set to 1 by the non-maskable interrupt acceptance, and cleared to 0 by the RETI instruction.

**[Cautions]**

- Any interrupt (including non-maskable interrupts) is not accepted because the NMIS flag is not cleared to 0 when returning from the non-maskable interrupt processing by the instructions other than the RETI instruction.

**RETB**

Return from software vectored interrupt

**[Instruction format]**

RETB

**[Operation]**

$PC_L \leftarrow (SP),$   
 $PC_H \leftarrow (SP + 1),$   
 $PSW \leftarrow (SP + 2),$   
 $SP \leftarrow SP + 3$

**[Operand]**

None

**[Flag]**

Z	AC	CY
R	R	R

R : Previously saved value is restored

**[Description]**

- This is a return instruction from the software interrupt generated with the BRK instruction.
- The data saved in the stack returns to the PC and the PSW, and the program returns from the interrupt servicing routine.
- None of interrupts are acknowledged between this instruction and the next instruction to be executed.

**(11) Stack manipulation instructions**

The following stack manipulation instructions are available.

Instruction	Overview
PUSH	Push
POP	Pop
MOVW	Stck pointer and word data transfer

**PUSH**

Push

**[Instruction format]**

PUSH src

**[Operation]**

- (1) **src = rp**  
 (SP - 1) <- rpH,  
 (SP - 2) <- rpL,  
 SP <- SP - 2
  
- (2) **src = PSW**  
 (SP - 1) <- PSW,  
 (SP - 2) <- 00H,  
 SP <- SP - 2

**[Operand]**

Operand (src)
PSW
rp

**[Flag]**

Z	AC	CY

Blank : Unchanged

**[Description]**

- The data of the register specified by the source operand (src) is saved to the stack.

**[Description example]**

```
PUSH    AX                ; (1)
```

(1) **AX register contents are saved to the stack.**

**POP**

Pop

**[Instruction format]**

POP dst

**[Operation]**

**(1) dst = rp**

rpL <- (SP),  
 rpH <- (SP + 1),  
 SP <- SP + 2

**(2) dst = PSW**

PSW <- (SP + 1),  
 SP <- SP + 2

**[Operand]**

Operand (dst)
PSW
rp

**[Flag]**

**(1) dst = rp**

Z	AC	CY

Blank : Unchanged

**(2) dst = PSW**

Z	AC	CY
R	R	R

R : Previously saved value is restored

**[Description]**

- Data is returned from the stack to the register specified by the destination operand (dst).
- When the operand is PSW, each flag is replaced with stack data.
- None of interrupts are acknowledged between the POP PSW instruction and the subsequent instruction.

**[Description example]**

POP	AX	;	(1)
-----	----	---	-----

(1) The stack data is returned to the AX register.



**MOVW**

Stack pointer and word data transfer

**[Instruction format]**

MOVW dst, src

**[Operation]**

dst <- src

**[Operand]**

Operand (dst, src)
SP, #word
SP, AX
AX, SP

**[Flag]**

Z	AC	CY

Blank : Unchanged

**[Description]**

- This is an instruction to manipulate the stack pointer contents.
- The source operand (src) specified by the 2nd operand is stored in the destination operand (dst) specified by the 1st operand.

**[Description example]**

```
MOVW SP, #FE1FH ; (1)
```

(1) FE1FH is stored in the stack pointer.

**(12) Unconditional branch instruction**

The following unconditional branch instructions are available

Instruction	Overview
BR	Unconditional branch

**BR**

Unconditional branch

**[Instruction format]**

BR target

**[Operation]**

PC <- target

**[Operand]**

Operand (target)
!addr16
AX
\$addr16

**[Flag]**

Z	AC	CY

Blank : Unchanged

**[Description]**

- This is an instruction to branch unconditionally.
- The word data of the target address operand (target) is transferred to PC and branched.

**[Description example]**

BR     AX                     ;   (1)

(1) The AX register contents are branched as the address.

**(13) Conditional branch instructions**

The following conditional branch instructions are available.

Instruction	Overview
BC	Conditional branch with carry flag (CY = 1)
BNC	Conditional branch with carry flag (CY = 0)
BZ	Conditional branch with zero flag (Z = 1)
BNZ	Conditional branch with zero flag (Z = 0)
BT	Conditional branch by bit test (byte data bit = 1)
BF	Conditional branch by bit test (byte data bit = 0)
BTCLR	Conditional branch and clear by bit test (byte data bit = 1)
DBNZ	Conditional loop (R1 $\neq$ 0)

**BC**

Conditional branch with carry flag (CY = 1)

**[Instruction format]**

BC \$addr16

**[Operation]**

PC <- PC + 2 + jdisp8 if CY = 1

**[Operand]**

Operand (\$addr16)
\$addr16

**[Flag]**

Z	AC	CY

Blank : Unchanged

**[Description]**

- When CY = 1, data is branched to the address specified by the operand.
- When CY = 0, no processing is carried out and the subsequent instruction is executed.

**[Description example]**

BC	\$300H	;	(1)
----	--------	---	-----

- (1) When CY = 1, data is branched to 0300H (with the start of this instruction set in the range of addresses 027FH to 037EH).

**BNC**

Conditional branch with carry flag (CY = 0)

**[Instruction format]**

BNC \$addr16

**[Operation]**

PC <- PC + 2 + jdisp8 if CY = 0

**[Operand]**

Operand (\$addr16)
\$addr16

**[Flag]**

Z	AC	CY

Blank : Unchanged

**[Description]**

- When CY = 0, data is branched to the address specified by the operand.
- When CY = 1, no processing is carried out and the subsequent instruction is executed.

**[Description example]**

```
BNC    $300H    ; (1)
```

- (1) When CY = 0, data is branched to 0300H (with the start of this instruction set in the range of addresses 027FH to 037EH).

**BZ**

Conditional branch with zero flag (Z = 1)

**[Instruction format]**

BZ \$addr16

**[Operation]**

PC <- PC + 2 + jdisp8 if Z = 1

**[Operand]**

Operand (\$addr16)
\$addr16

**[Flag]**

Z	AC	CY

Blank : Unchanged

**[Description]**

- When Z = 1, data is branched to the address specified by the operand.
- When Z = 0, no processing is carried out and the subsequent instruction is executed.

**[Description example]**

```
DEC B
BZ    $3C5H    ; (1)
```

**(1) When the B register is 0, data is branched to 03C5H (with the start of this instruction set in the range of addresses 0344H to 0443H).**

**BNZ**

Conditional branch with zero flag (Z = 0)

**[Instruction format]**

BNZ \$addr16

**[Operation]**

PC <- PC + 2 + jdisp8 if Z = 0

**[Operand]**

Operand (\$addr16)
\$addr16

**[Flag]**

Z	AC	CY

Blank : Unchanged

**[Description]**

- When Z = 0, data is branched to the address specified by the operand.
- When Z = 1, no processing is carried out and the subsequent instruction is executed.

**[Description example]**

```
CMP    A, #55H
BNZ    $0A39H    ; (1)
```

(1) If the A register is not 0055H, data is branched to 0A39H (with the start of this instruction set in the range of addresses 09B8H to 0AB7H).



**BT**

Conditional branch by bit test (byte data bit = 1)

**[Instruction format]**

BT bit, \$addr16

**[Operation]**

PC <- PC + b + jdisp8 if bit = 1

**[Operand]**

Operand (bit, \$addr16)	b (Number of Bytes)
saddr.bit, \$addr16	3
sfr.bit, \$addr16	4
A.bit, \$addr16	3
PSW.bit, \$addr16	3
[HL].bit, \$addr16	3

**[Flag]**

Z	AC	CY

Blank : Unchanged

**[Description]**

- If the 1st operand (bit) contents have been set (1), data is branched to the address specified by the 2nd operand (\$addr16).  
If the 1st operand (bit) contents have not been set (1), no processing is carried out and the subsequent instruction is executed.

**[Description example]**

```
BT    0FE47H.3, $55CH    ; (1)
```

**(1) When bit 3 at address 0FE47H is 1, data is branched to 055CH (with the start of this instruction set in the range of addresses 04DAH to 05D9H).**

**BF**

Conditional branch by bit test (byte data bit = 0)

**[Instruction format]**

BF bit, \$addr16

**[Operation]**

PC <- PC + b + jdisp8 if bit = 0

**[Operand]**

Operand (bit, \$addr16)	b (Number of Bytes)
saddr.bit, \$addr16	4
sfr.bit, \$addr16	4
A.bit, \$addr16	3
PSW.bit, \$addr16	4
[HL].bit, \$addr16	3

**[Flag]**

Z	AC	CY

Blank : Unchanged

**[Description]**

- If the 1st operand (bit) contents have been cleared (0), data is branched to the address specified by the 2nd operand (\$addr16).
- If the 1st operand (bit) contents have not been cleared (0), no processing is carried out and the subsequent instruction is executed.

**[Description example]**

```
BF    P2.2, $1549H    ; (1)
```

(1) When bit 2 of port 2 is 0, data is branched to address 1549H (with the start of this instruction set in the range of addresses 14C6H to 15C5H).

**BTCLR**

Conditional branch and clear by bit test (byte data bit = 1)

**[Instruction format]**

BTCLR bit, \$addr16

**[Operation]**

PC <- PC + b + jdisp8 if bit = 1, then bit <- 0

**[Operand]**

Operand (bit, \$addr16)	b (Number of Bytes)
saddr.bit, \$addr16	4
sfr.bit, \$addr16	4
A.bit, \$addr16	3
PSW.bit, \$addr16	4
[HL].bit, \$addr16	3

**[Flag]**

**(1) bit = PSW.bit**

Z	AC	CY
x	x	x

x : Set or cleared according to the result

**(2) All other operand combinations**

Z	AC	CY

Blank : Unchanged

**[Description]**

- If the 1st operand (bit) contents have been set (1), they are cleared (0) and branched to the address specified by the 2nd operand.
- If the 1st operand (bit) contents have not been set (1), no processing is carried out and the subsequent instruction is executed.
- When the 1st operand (bit) is PSW.bit, the corresponding flag contents are cleared (0).

**[Description example]**

```
BTCLR PSW.0, $356H ; (1)
```

- (1) When bit 0 (CY flag) of PSW is 1, the CY flag is cleared to 0 and branched to address 0356H (with the start of this instruction set in the range of addresses 02D4H to 03D3H).

**DBNZ**

Conditional Loop (R1 ≠ 0)

**[Instruction format]**

DBNZ dst, \$addr16

**[Operation]**

dst <- dst - 1,  
then PC <- PC + b+ jdisp16 if dst R1≠ 0

**[Operand]**

Operand (dst, \$addr16)	b (Number of Bytes)
B, \$addr16	2
C, \$addr16	2
saddr, \$addr16	3

**[Flag]**

Z	AC	CY

Blank : Unchanged

**[Description]**

- One is subtracted from the destination operand (dst) contents specified by the 1st operand and the subtraction result is stored in the destination operand (dst).
- If the subtraction result is not 0, data is branched to the address indicated with the 2nd operand (\$addr16). When the subtraction result is 0, no processing is carried out and the subsequent instruction is executed.
- The flag remains unchanged.

**[Description example]**

```
DBNZ    B, $1215H        ; (1)
```

**(1) The B register contents are decremented. If the result is not 0, data is branched to 1215H (with the start of this instruction set in the range of addresses 1194H to 1293H).**

**(14) CPU control instructions**

The following CPU control instructions are available.

Instruction	Overview
SEL	Register bank selection
NOP	No operation
EI	Interrupt enabled
DI	Interrupt disabled
HALT	Halt mode set
STOP	Stop mode set

**SEL**

Register bank selection

**[Instruction format]**

SEL RBn

**[Operation]**

RBS0, RBS1 <- n ; (n = 0 to 3)

**[Operand]**

Operand (RBn)
RBn

**[Flag]**

Z	AC	CY

Blank : Unchanged

**[Description]**

- The register bank specified by the operand (RBn) is made a register bank for use by the next and subsequent instructions.
- RBn ranges from RB0 to RB3.

**[Description example]**

SEL RB2 ; (1)

(1) Register bank 2 is selected as the register bank for use by the next and subsequent instructions.

**NOP**

No operation

**[Instruction format]**

NOP

**[Operation]**

no operation

**[Operand]**

None

**[Flag]**

Z	AC	CY

Blank : Unchanged

**[Description]**

- Only the time is consumed without processing.



EI

Interrupt enabled

**[Instruction format]**

EI

**[Operation]**

IE <- 1

**[Operand]**

None

**[Flag]**

Z	AC	CY

Blank : Unchanged

**[Description]**

- The maskable interrupt acknowledgeable status is set (by setting the interrupt enable flag (IE) to (1) ).
- No interrupts are acknowledged between this instruction and the next instruction.
- If this instruction is executed, vectored interrupt acknowledgment from another source can be disabled. For details, see the description of interrupt functions in the user's manual for each product.

**DI**

Interrupt disabled

**[Instruction format]**

DI

**[Operation]**

IE <- 0

**[Operand]**

None

**[Flag]**

Z	AC	CY

Blank : Unchanged

**[Description]**

- Maskable interrupt acknowledgment by vectored interrupt is disabled (with the interrupt enable flag (IE) cleared (0)).
- No interrupts are acknowledged between this instruction and the next instruction.
- For details of interrupt servicing, see the description of interrupt functions in the user's manual for each product.

**HALT**

Halt mode set

**[Instruction format]**

HALT

**[Operation]**

Set HALT Mode

**[Operand]**

None

**[Flag]**

Z	AC	CY

Blank : Unchanged

**[Description]**

- This instruction is used to set the HALT mode to stop the CPU operation clock. The total power consumption of the system can be decreased with intermittent operation by combining this mode with the normal operation mode.

**STOP**

Stop mode set

**[Instruction format]**

STOP

**[Operation]**

Set STOP Mode

**[Operand]**

None

**[Flag]**

Z	AC	CY

Blank : Unchanged

**[Description]**

- This instruction is used to set the STOP mode to stop the main system clock oscillator and to stop the whole system. Power consumption can be minimized to only leakage current.

## CHAPTER 5 LINK DIRECTIVE SPECIFICATION

This chapter explains the necessary items for link directives and how to write a directive file.

## 5.1 Coding Method

This section explains coding method of link directives.

### 5.1.1 Link directives

Link directives (referred to as directives from here on) are a group of commands for performing various directions during linking such as input files for the linker, useable memory areas, and segment location.

There are the following two kinds of directives.

Directive Type	Purpose
<a href="#">Memory directive</a>	<ul style="list-style-type: none"> <li>- Declares a installed memory address.</li> <li>- Divides memory into a number of areas and specifies the memory area.               <ul style="list-style-type: none"> <li>CALLT area</li> <li>Internal ROM</li> <li>External ROM</li> <li>SADDR</li> <li>Internal RAM other than SADDR</li> </ul> </li> </ul>
<a href="#">Segment location directive</a>	<ul style="list-style-type: none"> <li>- Specifies a segment location.</li> <li>- Specifies the following contents for each segment.               <ul style="list-style-type: none"> <li>Absolute address</li> <li>Specify only the memory area</li> </ul> </li> </ul>

Create a file (directive file) containing directives using a text editor and specify the -d option when starting the linker. The linker will read the directive file and perform link processing while it interprets the file.

#### (1) Directive file

The format for specifying directives in the directive file is shown next.

- Memory directive

```
MEMORY memory-area-name: (start-address-value, size) [ /memory-space-name]
```

- Segment Allocation Directives

```
MERGE segment-name: [ ATΔ(Δstart-addressΔ) ] [ =memory-area-name-specification ] [ /memory-space-name ]
MERGE segment-name: [ merge-attribute ] [ =memory-area-name-specification ] [ /memory-space-name ]
```

In addition, multiple directives can be specified in a single directive file.

For details about each directive, see "(2) [Memory directive](#)" and "(3) [Segment location directive](#)".

#### (a) Symbols

There is a distinction between uppercase and lowercase in the segment name, memory area name, and memory space name.

**(b) Numerical values**

When specifying numerical constants for the items in each directive, they can be specified as decimal or hexadecimal numbers.

Specifying numbers is the same as in source code, for hexadecimal numbers attach an "H" to the end of the number. Also, when the first digit is A - F, add a "0" to the beginning of the number.

Examples are shown below.

```
23H , 0FC80H
```

**(c) Comments**

When ";" or "#" is specified in a directive file, the text from that character to the line feed (LF) is treated as a comment. In addition, if the directive file ends before a line feed appears, the text up to the end of the file is treated as a comment.

Examples are shown below.

The underlined portions are comments.

```
; DIRECTIVE FILE FOR 78F051144  
MEMORY MEM1 : ( 01000H, 1000H ) #SECOND MEMORY AREA
```

**(2) Memory directive**

The memory directive is a directive to define a memory area (the address of memory to implement and its name). The defined memory area can be referenced by the segment location directive using this name (memory area name).

Up to 100 memory areas can be defined, including the memory area defined by default.

The syntax is shown below.

```
MEMORY $\Delta$ memory-area-name $\Delta$ : $\Delta$ ( $\Delta$ start-address $\Delta$ , $\Delta$ size $\Delta$ ) [ $\Delta$ memory-space-name]
```

**(a) Memory area name**

Specifies the name of the memory area to define.

Conditions when specifying are as follows.

- Characters that can be used in the memory area name are A - Z, a - z, 0 - 9, \_, ?, @.
- However, 0 - 9 cannot be used as the first character of the memory area name.
- Uppercase and lowercase characters are distinguished as separate characters.
- Uppercase and lowercase characters can be mixed together.
- The length of the memory area name is a maximum of 31 characters.
- 32characters or more will result in an error.
- There must be a only a single memory area name for each one throughout all memory spaces.

Attaching the same memory area name to differing memory areas, when the memory space is the same or when it is different, is not permitted.

Figure 5-1. Example of Memory Area Name that Cannot Be Specified

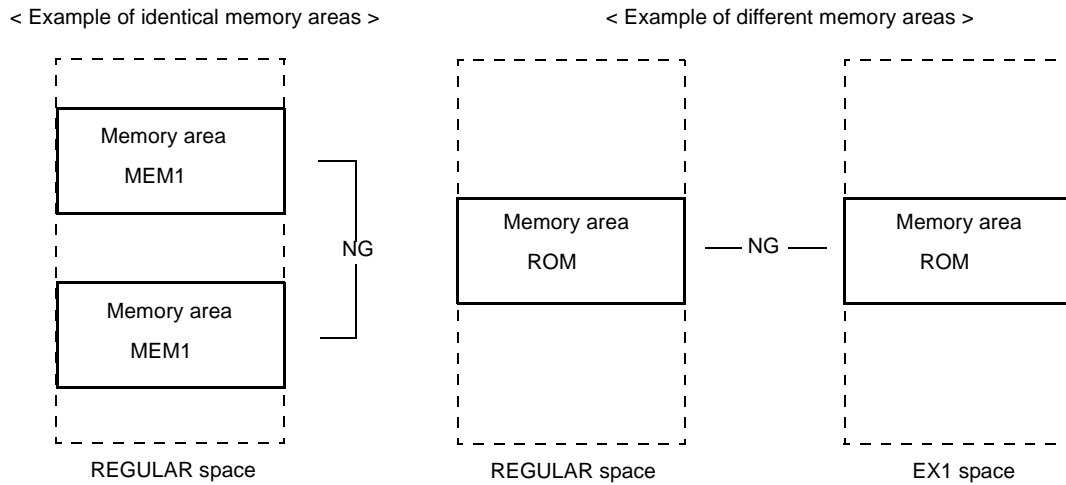
**(b) Start address**

Specifies the start address of the memory area to define.  
Write as a numerical constant between 0H - 0FFFFFFH.

**(c) Size**

Specifies the size of the memory area to define.  
Conditions when specifying are as follows.

- A numerical constant 1 or greater.
  - When re-specifying the size of the memory area the linker defines by default, there is a restriction in the range that can be defined.
- For the size of the memory area defined by default for each device and the range it can be redefined, see each device file's "Notes on Use".

**(d) Memory area name**

There are 16 memory space names, which divide memory space into partitions of 64 KB each.

REGULAR, EX1, EX2, EX3, EX4, EX5, EX6, EX7, EX8, EX9, EX10, EX11, EX12, EX13, EX14, EX15

When assigning memory segments, memory space names are used to specify where the segment should be assigned.

Conditions when specifying are shown next.

- The memory space name is specified in all uppercase.
- When the memory space name is omitted, the linker will consider REGULAR to have been specified.
- If the memory space name is omitted after "/" is written, an error occurs.

The function is shown below.

- The memory area with the name specified by the memory area name is defined in the specified memory space.
- 1 memory area can be defined with 1 memory directive.
- There can be multiple memory directives themselves. When there multiple definitions in the specified order an error will result.
- The default memory area is valid so long as the same memory area is not redefined by a memory directive. When memory directives are omitted, the linker specifies only the default memory area for each device.

- When not using the default memory space and using it with a different area name, set the default area name's size to "0".

A usage example is shown below.

- Defines memory space (EX1) address 0H to 1FFH as memory area ROMA.

```
MEMORY ROMA : ( 0H, 200H ) / EX1
```

### (3) Segment location directive

The segment location directive is a directive which places a specified segment in a specified memory area or places it at specific address.

The syntax is shown below.

```
MERGEΔsegment-nameΔ:Δ[ATΔ(Δstart-addressΔ)] [Δ=Δmemory-area-name] [Δ/Δmemory-space-name]
MERGEΔsegment-nameΔ:Δ[merge-attribute] [Δ=Δmemory-area-name] [Δ/Δmemory-space-name]
```

#### (a) Segment name

The segment name contained in the object module file input to the linker.

- A segment name other than the input segment cannot be specified.
- The segment name must be specified as specified in the assembler source.

#### (b) Start address

Allocates the segment at the area specified by the "start address".

- The reserved word AT must be specified in all uppercase or lowercase characters. It cannot mix uppercase and lowercase characters.
- The start address is specified as a numerical constant.

Figure 5-2. Specified Start Address and Segment Location

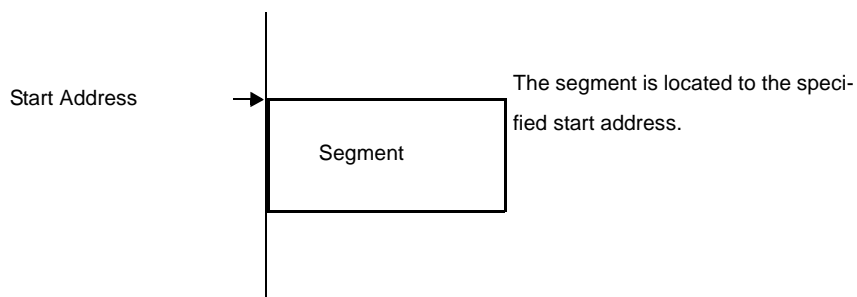

- Cautions 1.** When locating a segment according to the specified start address, if the range of the memory area where it is being located is exceeded, an error will result.
- 2.** The start address cannot be specified by a link directive for segments specified a location address by the segment directive AT assignment or the ORG directive.



**(c) Merge attribute**

When there are multiple segments with the same name in the source, specify in the directive "COMPLETE" to error without merging or "SEQUENT (default)" to merge.

SEQUENT	Merge sequentially in the order the segments appear so as to not leave free space. BSEG is merged in bit units in the order the segments appear.
COMPLETE	An error will occur if there are multiple segments with the same name.

Examples are shown below.

```
MERGE DSEG1 : COMPLETE = RAM
```

**(d) Memory area name**

The memory space name specifies a memory space to locate a segment.

- Memory name specifications are limited to the following 16 memory space names.  
REGULAR, EX1, EX2, EX3, EX4, EX5, EX6, EX7, EX8, EX9, EX10, EX11, EX12, EX13, EX14, EX15
- The memory space name is specified in all uppercase.
- When the memory space name is omitted, the linker will consider REGULAR to have been specified.

Segment location is shown next.

Memory Area	Memory Space	Segment Location
Not specified	Not specified	The memory area located in REGULAR space at the default
No specification	Memory space name	Any area in the specified memory space
Memory Area Name	Not specified	The specified memory area in REGULAR space
Memory area name	Memory space name	The specified memory area in the specified memory space

This table emphasizes declaring the memory area which will be the target for the segment location. In addition, if "AT(start address)" is specified when the actual location address is decided, the segment will be located from that address.

For example, for a segment with a relocation attribute of "CSEG FIXEDBASE", if memory name "EX1REGULAR" is specified, the segment will be located so that it takes up position within 800H - 0FFFH.

Notes are shown below.

- Input segments that are not specified with the segment location directive have their location address determined according to the relocation attribute specified with the segment definition directive during assembly.
- If a segment doesn't exist that is specified as a segment name, an error will result.
- If multiple segment location directives are specified for the same segment, an error will result.

## 5.2 Reserved Words

Reserved words for use in the directive file are shown next.

Reserved words in the directive file cannot be used for other purposes (segment names, memory area names, etc.).

Reserved Words	Explanation
MEMORY	Specifies the memory directives
MERGE	Specifies the segment location directive
AT	Specifies the location attribute (start address) of the segment location directive
SEQUENT	Specifies the merge attribute (merges a segment) of the segment location directive
COMPLETE	Specifies the merge attribute (does not merge a segment) of the segment location directive

**Caution** Reserved words can be specified in uppercase or lowercase. However, it cannot mix uppercase and lowercase characters.

**Example** MEMORY : Acceptable  
memory : Acceptable  
Memory : Not acceptable

## 5.3 Coding Examples

Link directive coding examples are shown next.

### 5.3.1 When specifying link directive

- An address is allocated for segment SEG1 with a segment type, relocation attribute of "CSEG UNIT".  
The declared memory area is as follows.

```
MEMORY ROM : ( 0000H, 1000H )
MEMORY MEM1 : ( 1000H, 2000H )
MEMORY RAM : ( 0FE00H, 200H )
```

- When allocating input segment SEG1 to 500H inside area ROM (see the following diagram(1) ).

```
MERGE SEG1 : AT ( 500H )
```

- When allocating input segment SEG1 inside memory area MEM1 (see the following diagram(2) ).

```
MERGE SEG1 : = MEM1
```

- When input segment SEG1 is assigned to 1500H in memory area MEM1 (see (3) in the following figure)

```
MERGE SEG1 : AT (1500H)=MEM178
```

Figure 5-3. Example Allocations of Input Segment SEG1

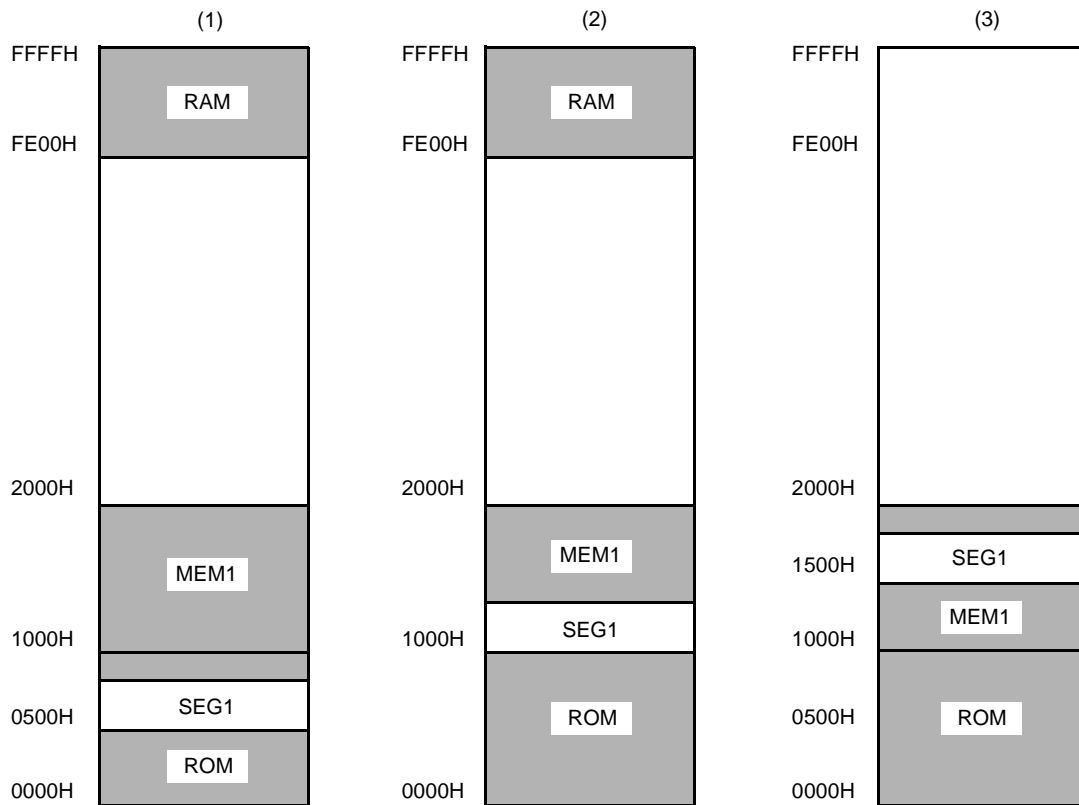

5.3.2 When using the compiler

This section explains how to create a link directive file when using the compiler. Create the file matched to the actual target system and specify the created file with the -d option when linking.

Additionally, be aware of the following cautions when creating the file.

- 78K0 C compiler may use a portion of the short direct address area (saddr area) for specific purposes as shown next.

Specifically, in the case of the normal model, this area is the 40 bytes from 0FEB8H to 0FEDFH. If the static model has been specified with the -sm [n] option, part of the saddr area (0FED0H to 0FEDFH) is used as a common area.

(1) Normal model

- (a) Runtime library arguments [0FEB8H to 0FEBFH]
- (b) norec function arguments and auto variables [0FEC0H to 0FECFH]
- (c) register variables, if the -qr option has been specified [0FED0H to 0FEDFH]
- (d) Standard library work area ( (b) and part of (c) )

**Caution** When the user is not using the standard library, area (d) is not used.

(2) Static model

- (a) Common area [0FED0H to 0FEDFH]

The following shows an example changing the RAM size with a link directive file (lk78k0.dr).

When changing the memory size, be careful so that the memory does not overlap with other areas. When making changes, see the memory map of the target device to use.

	Start	address	size	
memory RAM :	(	0FB00h,	00320h )	-> Make this size bigger.
memory SDR :	(	0FE20h,	00098h )	(Also change the start address as necessary.)
merge @@INIS :	=	SDR		-> Specifying the segment location.
merge @@DATS :	=	SDR		-> Specifying the segment location.
merge @@BITS :	=	SDR		-> Specifying the segment location.

When you want to change location of a segment, add the merge statement.. When the function to change the compiler output section name is used, segments can be located individually (for details see "[Changing compiler output section name \(#pragma section ...\)](#)").

The result of changing the segment location, when there is insufficient memory to locate the segment, change the corresponding memory statement.

## CHAPTER 6 FUNCTION SPECIFICATION

In the C language there are no commands to perform input/output with external (peripheral) devices or equipment. This is because the designers of the C language designed it to keep its functions to a minimum. However, input/output operations are necessary in the development of actual systems. For this reason, library functions for performing input/output operations have been prepared in 78K0 C compiler.

This chapter explains the library functions that 78K0 C compiler has and the functions that can be used with the simulator.

### 6.1 Distribution Libraries

The libraries distributed with 78K0 C compiler are described below.

When using the standard library inside an application, include the relevant header files and use the library functions.

The runtime library is a portion of the standard library, but the routines are called by 78K0 C compiler automatically, they are not functions described in C or assembly language source code.

**Table 6-1. Distribution Libraries**

Library Type	Included Functions
Standard library	<ul style="list-style-type: none"> <li>- Character/String Functions</li> <li>- Program Control Functions</li> <li>- Special Functions</li> <li>- Input and Output Functions</li> <li>- Utility Functions</li> <li>- String and Memory Functions</li> <li>- Mathematical Functions</li> <li>- Diagnostic Function</li> </ul>
Runtime library	<ul style="list-style-type: none"> <li>- Increment</li> <li>- Decrement</li> <li>- Sign reverse</li> <li>- 1's complement</li> <li>- Logical negation</li> <li>- Multiplication</li> <li>- Divide</li> <li>- Remainder arithmetic</li> <li>- Addition</li> <li>- Subtract</li> <li>- Left shift</li> <li>- Right shift</li> <li>- Compare</li> <li>- Bit AND</li> <li>- Bit OR</li> <li>- Bit XOR</li> <li>- Logical AND</li> <li>- Logical OR</li> <li>- Conversion from floating point</li> <li>- Conversion to floating point</li> <li>- Conversion from bit</li> <li>- Startup routine</li> </ul>

Library Type	Included Functions
	<ul style="list-style-type: none"> <li>- Pre- and post-processing of function</li> <li>- Bank function</li> <li>- BCD-type conversion</li> <li>- Auxiliary</li> </ul>

**6.1.1 Standard library**

This section shows the functions included in the standard library.  
 The standard library is fully supported when the -zf option is specified.

**(1) Character/String Functions**

Function Name	Purpose	Header File	Re-entrant
isalpha	Judges if a character is an alphabetic character (A to Z, a to z)	ctype.h	OK
isupper	Judges if a character is an uppercase alphabetic character (A to Z)	ctype.h	OK
islower	Judges if a character is a lowercase alphabetic character (a to z)	ctype.h	OK
isdigit	Judges if a character is a numeric (0 to 9)	ctype.h	OK
isalnum	Judges if a character is an alphanumeric character (0 to 9, A to Z, a to z)	ctype.h	OK
isxdigit	Judges if a character is a hexadecimal numbers (0 to 9, A to F, a to f)	ctype.h	OK
isspace	Judges if a character is a whitespace character (whitespace, tab, carriage return, line feed, vertical, tab, form feed)	ctype.h	OK
ispunct	Judges if a character is a printable character other than a whitespace character or alphanumeric character	ctype.h	OK
isprint	Judges if a character is a printable character	ctype.h	OK
isgraph	Judges if a character is a printable character other than whitespace	ctype.h	OK
iscntrl	Judges if a character is a control character	ctype.h	OK
isascii	Judges if a character is an ASCII code	ctype.h	OK
toupper	Converts a lowercase alphabetic character to uppercase	ctype.h	OK
tolower	Converts an uppercase alphabetic character to lowercase	ctype.h	OK
toascii	Converts the input to an ASCII code	ctype.h	OK
_toupper	Subtracts "a" from the input character and adds "A"	ctype.h	OK
toup		ctype.h	OK
_tolower	Subtracts "A" from the input character and adds "a"	ctype.h	OK
tolow		ctype.h	OK

OK : Re-entrant

**(2) Program Control Functions**

Function Name	Purpose	Header File	Re-entrant
setjmp	Saves the environment at the time of the call	setjmp.h	NG
longjmp	Restores the environment saved with setjmp	setjmp.h	NG

NG : Not re-entrant

### (3) Special Functions

Function Name	Purpose	Header File	Re-entrant
<a href="#">va_start</a> (normal model only)	Settings for processing variable arguments	stdarg.h	OK
<a href="#">va_starttop</a> (normal model only)	Settings for processing variable arguments	stdarg.h	OK
<a href="#">va_arg</a> (normal model only)	Processes variable arguments	stdarg.h	OK
<a href="#">va_end</a> (normal model only)	Indicates the end of processing variable arguments	stdarg.h	OK

OK : Re-entrant

### (4) Input and Output Functions

Function Name	Purpose	Header File	Re-entrant
<a href="#">sprintf</a> (normal model only)	Writes data to a string according to a format	stdio.h	Δ
<a href="#">sscanf</a> (normal model only)	Reads data from the input string according to a format	stdio.h	Δ
<a href="#">printf</a> (normal model only)	Outputs data to SFR according to a format	stdio.h	Δ
<a href="#">scanf</a> (normal model only)	Reads data from SFR according to a format	stdio.h	Δ
<a href="#">vprintf</a> (normal model only)	Outputs data to SFR according to a format	stdio.h	Δ
<a href="#">vsprintf</a> (normal model only)	Writes data to a string according to a format	stdio.h	Δ
<a href="#">getchar</a>	Reads one character from SFR	stdio.h	OK
<a href="#">gets</a>	Reads a string	stdio.h	OK
<a href="#">putchar</a>	Outputs one character to SFR	stdio.h	OK
<a href="#">puts</a>	Outputs a string	stdio.h	OK

OK : Re-entrant

Δ : Functions that do not support floating point are re-entrant

### (5) Utility Functions

Function Name	Purpose	Header File	Re-entrant
<a href="#">atoi</a>	Converts a decimal integer string to int	stdlib.h	OK
<a href="#">atol</a>	Converts a decimal integer string to long	stdlib.h	OK
<a href="#">strtol</a>	Converts a string to long	stdlib.h	OK

Function Name	Purpose	Header File	Re-entrant
<a href="#">strtoul</a>	Converts a string to unsigned long	stdlib.h	OK
<a href="#">calloc</a>	Allocates an array's region and initializes it to zero	stdlib.h	OK
<a href="#">free</a>	Releases a block of allocated memory	stdlib.h	OK
<a href="#">malloc</a>	Allocates a block	stdlib.h	OK
<a href="#">realloc</a>	Re-allocates a block	stdlib.h	OK
<a href="#">abort</a>	Abnormally terminates the program	stdlib.h	OK
<a href="#">atexit</a>	Registers a function to be called at normal termination	stdlib.h	NG
<a href="#">exit</a>	Terminates the program	stdlib.h	NG
<a href="#">abs</a>	Obtains the absolute value of an int type value	stdlib.h	OK
<a href="#">labs</a>	Obtains the absolute value of a long type value	stdlib.h	OK
<a href="#">div (normal model only)</a>	Performs int type division, obtains the quotient and remainder	stdlib.h	NG
<a href="#">ldiv (normal model only)</a>	Performs long type division, obtains the quotient and remainder	stdlib.h	NG
<a href="#">brk</a>	Sets the break value	stdlib.h	NG
<a href="#">sbrk</a>	Increases/decreases the break value	stdlib.h	NG
<a href="#">atof</a>	Converts a decimal integer string to double	stdlib.h	NG
<a href="#">strtod (normal model only)</a>	Converts a string to double	stdlib.h	NG
<a href="#">itoa</a>	Converts int to a string	stdlib.h	OK
<a href="#">ltoa (normal model only)</a>	Converts long to a string	stdlib.h	OK
<a href="#">ultoa (normal model only)</a>	Converts unsigned long to a string	stdlib.h	OK
<a href="#">rand</a>	Generates a pseudo-random number	stdlib.h	NG
<a href="#">srand</a>	Initializes the pseudo-random number generator state	stdlib.h	NG
<a href="#">bsearch (normal model only)</a>	Binary search	stdlib.h	OK
<a href="#">qsort (normal model only)</a>	Quick sort	stdlib.h	OK
<a href="#">strbrk</a>	Sets the break value	stdlib.h	OK
<a href="#">strsbrk</a>	Increases/decreases the break value	stdlib.h	OK
<a href="#">strtoa</a>	Converts int to a string	stdlib.h	OK
<a href="#">strltoa (normal model only)</a>	Converts long to a string	stdlib.h	OK
<a href="#">strultoa (normal model only)</a>	Converts unsigned long to a string	stdlib.h	OK

OK : Re-entrant

NG : Not re-entrant



## (6) String and Memory Functions

Function Name	Purpose	Header File	Re-entrant
<a href="#">memcpy</a>	Copies a buffer for the specified number of characters	string.h	OK
<a href="#">memmove</a>	Copies a buffer for the specified number of characters	string.h	OK
<a href="#">strcpy</a>	Copies a string	string.h	OK
<a href="#">strncpy</a>	Copies the specified number of characters from the start of a string	string.h	OK
<a href="#">strcat</a>	Appends a string to a string	string.h	OK
<a href="#">strncat</a>	Appends the specified number of characters of a string to a string	string.h	OK
<a href="#">memcmp</a>	Compares the specified number of characters of two buffers	string.h	OK
<a href="#">strcmp</a>	Compares two strings	string.h	OK
<a href="#">strncmp</a>	Compares the specified number of characters of two strings	string.h	OK
<a href="#">memchr</a>	Searches for the specified string in the specified number of characters of a buffer	string.h	OK
<a href="#">strchr</a>	Searches for the specified character from within a string and returns the location of the first occurrence	string.h	OK
<a href="#">strrchr</a>	Searches for the specified character from within a string and returns the location of the last occurrence	string.h	OK
<a href="#">strspn</a>	Obtains the length from the start of a segment composed of only the characters included in the specified string within the string being searched	string.h	OK
<a href="#">strcspn</a>	Obtains the length from the start of a segment composed of characters other than those included in the specified string within the string being searched	string.h	OK
<a href="#">strpbrk</a>	Obtains the position of the first occurrence of any character in the specified string within the string being searched	string.h	OK
<a href="#">strstr</a>	Obtains the position of the first occurrence of the specified string within the string being searched	string.h	OK
<a href="#">strtok</a>	Decomposing character string into a string consisting of characters other than delimiters.	string.h	NG
<a href="#">memset</a>	Initializes the specified number of characters of a buffer with the specified character	string.h	OK
<a href="#">strerror</a>	Returns a pointer to the area that stores the error message string which corresponds to the specified error number	string.h	OK
<a href="#">strlen</a>	Obtains the length of a string	string.h	OK
<a href="#">strcoll</a>	Compares two strings based on region specific information	string.h	OK
<a href="#">strxfrm</a>	Transforms a string based on region specific information	string.h	OK

OK : Re-entrant

NG : Not re-entrant

## (7) Mathematical Functions

Function Name	Purpose	Header File	Re-entrant
<a href="#">acos</a> (normal model only)	Finds acos	math.h	NG
<a href="#">asin</a> (normal model only)	Finds asin	math.h	NG
<a href="#">atan</a> (normal model only)	Finds atan	math.h	NG
<a href="#">atan2</a> (normal model only)	Finds atan2	math.h	NG
<a href="#">cos</a> (normal model only)	Finds cos	math.h	NG
<a href="#">sin</a> (normal model only)	Finds sin	math.h	NG
<a href="#">tan</a> (normal model only)	Finds tan	math.h	NG
<a href="#">cosh</a> (normal model only)	Finds cosh	math.h	NG
<a href="#">sinh</a> (normal model only)	Finds sinh	math.h	NG
<a href="#">tanh</a> (normal model only)	Finds tanh	math.h	NG
<a href="#">exp</a> (normal model only)	Finds the exponential function	math.h	NG
<a href="#">frexp</a> (normal model only)	Finds mantissa and exponent part	math.h	NG
<a href="#">ldexp</a> (normal model only)	Finds $x * 2^{exp}$	math.h	NG
<a href="#">log</a> (normal model only)	Finds the natural logarithm	math.h	NG
<a href="#">log10</a> (normal model only)	Finds the base 10 logarithm	math.h	NG
<a href="#">modf</a> (normal model only)	Finds the decimal and integer parts	math.h	NG
<a href="#">pow</a> (normal model only)	Finds yth power of x	math.h	NG
<a href="#">sqrt</a> (normal model only)	Finds the square root	math.h	NG
<a href="#">ceil</a> (normal model only)	Finds the smallest integer not smaller than x	math.h	NG
<a href="#">fabs</a> (normal model only)	Finds the absolute value of floating point number x	math.h	NG
<a href="#">floor</a> (normal model only)	Finds the largest integer not larger than x	math.h	NG

Function Name	Purpose	Header File	Re-entrant
fmod (normal model only)	Finds the remainder of x/y	math.h	NG
matherr (normal model only)	Obtains the exception processing for the library handling floating point numbers	math.h	NG
acosf (normal model only)	Finds acos	math.h	NG
asinf (normal model only)	Finds asin	math.h	NG
atanf (normal model only)	Finds atan	math.h	NG
atan2f (normal model only)	Finds atan of y/x	math.h	NG
cosf (normal model only)	Finds cos	math.h	NG
sinf (normal model only)	Finds sin	math.h	NG
tanf (normal model only)	Finds tan	math.h	NG
coshf (normal model only)	Finds cosh	math.h	NG
sinhf (normal model only)	Finds sinh	math.h	NG
tanhf (normal model only)	Finds tanh	math.h	NG
expf (normal model only)	Finds the exponential function	math.h	NG
frexpf (normal model only)	Finds mantissa and exponent part	math.h	NG
ldexpf (normal model only)	Finds $x * 2 ^ \text{exp}$	math.h	NG
logf (normal model only)	Finds the natural logarithm	math.h	NG
log10f (normal model only)	Finds the base 10 logarithm	math.h	NG
modff (normal model only)	Finds the decimal and integer parts	math.h	NG
powf (normal model only)	Finds yth power of x	math.h	NG
sqrtf (normal model only)	Finds the square root	math.h	NG
ceilf (normal model only)	Finds the smallest integer not smaller than x	math.h	NG
fabsf (normal model only)	Finds the absolute value of floating point number x	math.h	NG

Function Name	Purpose	Header File	Re-entrant
<a href="#">floorf (normal model only)</a>	Finds the largest integer not larger than x	math.h	NG
<a href="#">fmodf (normal model only)</a>	Finds the remainder of x/y	math.h	NG

NG : Not re-entrant

### (8) Diagnostic Function

Function Name	Purpose	Header File	Re-entrant
<a href="#">__assertfail (normal model only)</a>	Supports the assert macro	assert.h	OK

OK : Re-entrant

### 6.1.2 Runtime library

This section shows the functions included in the runtime library.

These operation instructions are called in a format with @@ attached to the beginning of the function name. However, cstart, cstarte, cprep, and cdisp are called in a format with @\_ attached to the beginning of the function name.

In addition, operations that do not appear in the tables below have no library support. The compiler performs inline expansion.

long addition/subtraction, and/or/xor, and shift may also undergo inline expansion.

#### (1) Increment

Function Name	Supported Model		Function
	Normal Model	Static Model	
lsinc	OK	-	Increments signed long
luinc	OK	-	Increments unsigned long
finc	OK	-	Increments float

#### (2) Decrement

Function Name	Supported Model		Function
	Normal Model	Static Model	
lsdec	OK	-	Decrements signed long
ludec	OK	-	Decrements unsigned long
fdec	OK	-	Decrements float

#### (3) Sign reverse

Function Name	Supported Model		Function
	Normal Model	Static Model	
lsrev	OK	-	Reverses the sign of signed long

Function Name	Supported Model		Function
	Normal Model	Static Model	
lrev	OK	-	Reverses the sign of unsigned long
frev	OK	-	Reverses the sign of float

**(4) 1's complement**

Function Name	Supported Model		Function
	Normal Model	Static Model	
lscm	OK	-	Obtains 1's complement of signed long
lucom	OK	-	Obtains 1's complement of unsigned long

**(5) Logical negation**

Function Name	Supported Model		Function
	Normal Model	Static Model	
lsnot	OK	-	Negates signed long
lunot	OK	-	Negates unsigned long
fnot	OK	-	Negates float

**(6) Multiplication**

Function Name	Supported Model		Function
	Normal Model	Static Model	
csmul	OK	OK	Performs multiplication between signed char data
cumul	OK	OK	Performs multiplication between unsigned char data
ismul	OK	OK	Performs multiplication between signed int data
iumul	OK	OK	Performs multiplication between unsigned int data
lsmul	OK	-	Performs multiplication between signed long data
lumul	OK	-	Performs multiplication between unsigned long data
fmul	OK	-	Performs multiplication between float data

**(7) Divide**

Function Name	Supported Model		Function
	Normal Model	Static Model	
csdiv	OK	OK	Performs division between signed char data
cudiv	OK	OK	Performs division between unsigned char data
isdiv	OK	OK	Performs division between signed int data
iudiv	OK	OK	Performs division between unsigned int data
lsdiv	OK	-	Performs division between signed long data

Function Name	Supported Model		Function
	Normal Model	Static Model	
ludiv	OK	-	Performs division between unsigned long data
fdiv	OK	-	Performs division between float data

**(8) Remainder arithmetic**

Function Name	Supported Model		Function
	Normal Model	Static Model	
csrem	OK	OK	Obtains remainder after division between signed char data
curem	OK	OK	Obtains remainder after division between unsigned char data
isrem	OK	OK	Obtains remainder after division between signed int data
iurem	OK	OK	Obtains remainder after division between unsigned int data
lsrem	OK	-	Obtains remainder after division between signed long data
lurem	OK	-	Obtains remainder after division between unsigned long data

**(9) Addition**

Function Name	Supported Model		Function
	Normal Model	Static Model	
lsadd	OK	-	Performs addition between signed long data
luadd	OK	-	Performs addition between unsigned long data
fadd	OK	-	Performs addition between float data

**(10) Subtract**

Function Name	Supported Model		Function
	Normal Model	Static Model	
lssub	OK	-	Performs subtraction between signed long data
lusub	OK	-	Performs subtraction between unsigned long data
fsub	OK	-	Performs subtraction between float data

**(11) Left shift**

Function Name	Supported Model		Function
	Normal Model	Static Model	
lslsh	OK	-	Shifts signed long data to the left

Function Name	Supported Model		Function
	Normal Model	Static Model	
lulsh	OK	-	Shifts unsigned long data to the left

**(12) Right shift**

Function Name	Supported Model		Function
	Normal Model	Static Model	
lsrsh	OK	-	Shifts signed long data to the right
lursh	OK	-	Shifts unsigned long data to the right

**(13) Compare**

Function Name	Supported Model		Function
	Normal Model	Static Model	
cscmp	OK	OK	Compares signed char data
iscmp	OK	OK	Compares signed int data
lscmp	OK	-	Compares signed long data
lucmp	OK	-	Compares unsigned long data
fcmp	OK	-	Compares float data

**(14) Bit AND**

Function Name	Supported Model		Function
	Normal Model	Static Model	
lsband	OK	-	Performs an AND operation between signed long data
luband	OK	-	Performs an AND operation between unsigned long data

**(15) Bit OR**

Function Name	Supported Model		Function
	Normal Model	Static Model	
lsbor	OK	-	Performs an OR operation between signed long data
lubor	OK	-	Performs an OR operation between unsigned long data

**(16)Bit XOR**

Function Name	Supported Model		Function
	Normal Model	Static Model	
lsbxor	OK	-	Performs an XOR operation between signed long data
lubxor	OK	-	Performs an XOR operation between unsigned long data

**(17)Logical AND**

Function Name	Supported Model		Function
	Normal Model	Static Model	
fand	OK	-	Performs a logical AND operation between two float data

**(18)Logical OR**

Function Name	Supported Model		Function
	Normal Model	Static Model	
for	OK	-	Performs a logical OR operation between two float data

**(19)Conversion from floating point**

Function Name	Supported Model		Function
	Normal Model	Static Model	
ftols	OK	-	Converts from float to signed long
ftolu	OK	-	Converts from float to unsigned long

**(20)Conversion to floating point**

Function Name	Supported Model		Function
	Normal Model	Static Model	
lstof	OK	-	Converts from signed long to float
lutof	OK	-	Converts from unsigned long to float

**(21)Conversion from bit**

Function Name	Supported Model		Function
	Normal Model	Static Model	
btol	OK	-	Converts from bit to long



(22) Startup routine

Function Name	Supported Model		Function
	Normal Model	Static Model	
cstart	OK	OK	<p>Startup module</p> <ul style="list-style-type: none"> <li>- After an area (2 * 32 bytes) where a function that will be registered is reserved with the atexit function, sets the beginning label name to <code>__FNCTBL</code>.</li> <li>- Reserve a break area (32 bytes), sets the beginning label name to <code>__MEMTOP</code>, and then sets the next label name of the area to <code>__MEMBTM</code>.</li> <li>- Define the segment in the reset vector table as follows, and set the beginning address of the startup module.</li> </ul> <pre> @@VECT00 CSEG AT 0000H DW      __cstart                     </pre> <ul style="list-style-type: none"> <li>- Set the register bank to RB0.</li> <li>- Set 0 to the variable <code>__errno</code> to which the error number is input.</li> <li>- Set the variable <code>__FNCENT</code>, to which the number of functions registered by the atexit function is input, to 0.</li> <li>- Set the address of <code>__MEMTOP</code> to the variable <code>__BRKADR</code> as the initial break value.</li> <li>- Set 1 as the initial value for the variable <code>__SEED</code>, which is the source of pseudo random numbers for the rand function.</li> <li>- Perform copy processing of initialized data and execute 0 clear of external data without an initial value.</li> <li>- Call the main function (user program).</li> <li>- Call the exit function by parameter 0.</li> </ul>

(23) Pre- and post-processing of function

Function Name	Supported Model		Function
	Normal Model	Static Model	
cprep	OK	-	Pre-processing of function
cdisp	-	OK	Post-processing of function
cprep2	-	OK	Pre-processing of function (including the saddr area for register variables)
cdisp2	-	OK	Post-processing of function (including the saddr area for register variables)
nrcp2	-	OK	For copying arguments
nrcp3	-	OK	For copying arguments
krcp2	-	OK	For copying arguments
krcp3	-	OK	For copying arguments

Function Name	Supported Model		Function
	Normal Model	Static Model	
nkrc3	-	OK	For copying arguments
nrip2	-	OK	For copying arguments
nrip3	-	OK	For copying arguments
krip2	-	OK	For copying arguments
krip3	-	OK	For copying arguments
nkri31	-	OK	For copying arguments
nkri32	-	OK	For copying arguments
krsb	-	OK	For copying arguments
krlb	-	OK	For copying arguments
krsw	-	OK	For copying arguments
krlw	-	OK	For copying arguments
nrsave	-	OK	For saving _@NRATxx
nrload	-	OK	For restoring _@NRATxx
krs02	-	OK	For saving _@KREGxx
krs04	-	OK	For saving _@KREGxx
krs04i	-	OK	For saving _@KREGxx
krs06	-	OK	For saving _@KREGxx
krs06i	-	OK	For saving _@KREGxx
krs08	-	OK	For saving _@KREGxx
krs08i	-	OK	For saving _@KREGxx
krs10	-	OK	For saving _@KREGxx
krs10i	-	OK	For saving _@KREGxx
krs12	-	OK	For saving _@KREGxx
krs12i	-	OK	For saving _@KREGxx
krs14	-	OK	For saving _@KREGxx
krs14i	-	OK	For saving _@KREGxx
krs16	-	OK	For saving _@KREGxx
krs16i	-	OK	For saving _@KREGxx
krsn04	-	OK	For saving _@KREGxx
krsn06	-	OK	For saving _@KREGxx
krsn08	-	OK	For saving _@KREGxx
krsn10	-	OK	For saving _@KREGxx
krsn12	-	OK	For saving _@KREGxx
krsn16	-	OK	For saving _@KREGxx
krsp04	-	OK	For saving _@KREGxx
krsp06	-	OK	For saving _@KREGxx

Function Name	Supported Model		Function
	Normal Model	Static Model	
krsp08	-	OK	For saving _@KREGxx
krsp10	-	OK	For saving _@KREGxx
krsp12	-	OK	For saving _@KREGxx
krsp14	-	OK	For saving _@KREGxx
kr102	-	OK	For restoring _@KREGxx
kr104	-	OK	For restoring _@KREGxx
kr104i	-	OK	For restoring _@KREGxx
kr106	-	OK	For restoring _@KREGxx
kr106i	-	OK	For restoring _@KREGxx
kr108	-	OK	For restoring _@KREGxx
kr108i	-	OK	For restoring _@KREGxx
kr110	-	OK	For restoring _@KREGxx
kr110i	-	OK	For restoring _@KREGxx
kr112	-	OK	For restoring _@KREGxx
kr112i	-	OK	For restoring _@KREGxx
kr114	-	OK	For restoring _@KREGxx
kr114i	-	OK	For restoring _@KREGxx
kr116	-	OK	For restoring _@KREGxx
kr116i	-	OK	For restoring _@KREGxx
kr1n04	-	OK	For restoring _@KREGxx
kr1n06	-	OK	For restoring _@KREGxx
kr1n08	-	OK	For restoring _@KREGxx
kr1n10	-	OK	For restoring _@KREGxx
kr1n12	-	OK	For restoring _@KREGxx
kr1n16	-	OK	For restoring _@KREGxx
kr1p04	-	OK	For restoring _@KREGxx
kr1p06	-	OK	For restoring _@KREGxx
kr1p08	-	OK	For restoring _@KREGxx
kr1p10	-	OK	For restoring _@KREGxx
kr1p12	-	OK	For restoring _@KREGxx
kr1p14	-	OK	For restoring _@KREGxx
hdwinit	OK	OK	Performs initialization processing of peripheral evices (sfr) immediately after CPU reset.

**(24) Bank function**

Function Name	Supported Model		Function
	Normal Model	Static Model	
bcall	OK	-	Calls the bank function
bcals	OK	-	Calls the bank function

**(25) BCD-type conversion**

Function Name	Supported Model		Function
	Normal Model	Static Model	
bcdtob	OK	OK	Converts 1-byte bcd to 1-byte binary
btobcd	OK	OK	Converts 1-byte binary to 2-byte bcd
bcdtow	OK	OK	Converts 2-byte bcd to 2-byte binary
wtobcd	OK	OK	Converts 2-byte binary to 2-byte bcd
bbcd	OK	OK	Converts 1-byte binary to 1-byte bcd

**(26) Auxiliary**

Function Name	Supported Model		Function
	Normal Model	Static Model	
mulu	OK	OK	mulu instruction-compatible
mulue	OK	OK	mulu instruction-compatible
divuw	OK	OK	divuw instruction-compatible
divuwe	OK	OK	divuw instruction-compatible
addwbc	OK	OK	For replacing the fixed-type instruction pattern
clra0	OK	OK	For replacing the fixed-type instruction pattern
clra1	OK	OK	For replacing the fixed-type instruction pattern
clrx0	OK	OK	For replacing the fixed-type instruction pattern
clrax0	OK	OK	For replacing the fixed-type instruction pattern
clrax1	-	OK	For replacing the fixed-type instruction pattern
clrbc0	OK	-	For replacing the fixed-type instruction pattern
clrbc1	OK	-	For replacing the fixed-type instruction pattern
cmpa0	OK	OK	For replacing the fixed-type instruction pattern
cmpa1	OK	OK	For replacing the fixed-type instruction pattern
cmpc0	OK	-	For replacing the fixed-type instruction pattern
cmpax1	OK	OK	For replacing the fixed-type instruction pattern
ctoi	OK	OK	For replacing the fixed-type instruction pattern
uctoi	-	OK	For replacing the fixed-type instruction pattern
maxde	OK	OK	For replacing the fixed-type instruction pattern

Function Name	Supported Model		Function
	Normal Model	Static Model	
mdeax	OK	OK	For replacing the fixed-type instruction pattern
incde	OK	OK	For replacing the fixed-type instruction pattern
decde	OK	OK	For replacing the fixed-type instruction pattern
maxhl	OK	OK	For replacing the fixed-type instruction pattern
mhlax	OK	OK	For replacing the fixed-type instruction pattern
incl	-	OK	For replacing the fixed-type instruction pattern
dechl	-	OK	For replacing the fixed-type instruction pattern
shl4	-	OK	For replacing the fixed-type instruction pattern
shr4	-	OK	For replacing the fixed-type instruction pattern
swap4	-	OK	For replacing the fixed-type instruction pattern
tableh	OK	OK	For replacing the fixed-type instruction pattern
apdech	-	OK	For replacing the fixed-type instruction pattern
apinch	-	OK	For replacing the fixed-type instruction pattern
incwhl	-	OK	For replacing the fixed-type instruction pattern
decwhl	-	OK	For replacing the fixed-type instruction pattern
dellab	OK	-	For replacing the fixed-type instruction pattern
dell03	OK	-	For replacing the fixed-type instruction pattern
della4	OK	-	For replacing the fixed-type instruction pattern
delsab	OK	-	For replacing the fixed-type instruction pattern
dels03	OK	-	For replacing the fixed-type instruction pattern
hlllab	OK	-	For replacing the fixed-type instruction pattern
hlll03	OK	-	For replacing the fixed-type instruction pattern
hllla4	OK	-	For replacing the fixed-type instruction pattern
hllsab	OK	-	For replacing the fixed-type instruction pattern
hlls03	OK	-	For replacing the fixed-type instruction pattern
dn2in	OK	-	For replacing the fixed-type instruction pattern
dn2de	OK	-	For replacing the fixed-type instruction pattern
dn4in	OK	-	For replacing the fixed-type instruction pattern
dn4ip	OK	-	For replacing the fixed-type instruction pattern
dn4de	OK	-	For replacing the fixed-type instruction pattern
dn4dp	OK	-	For replacing the fixed-type instruction pattern
_inha	OK	-	For replacing the fixed-type instruction pattern
_inah	OK	-	For replacing the fixed-type instruction pattern
_lnha	OK	-	For replacing the fixed-type instruction pattern
_lnh0	OK	-	For replacing the fixed-type instruction pattern
_lnh4	OK	-	For replacing the fixed-type instruction pattern

Function Name	Supported Model		Function
	Normal Model	Static Model	
_lnah	OK	-	For replacing the fixed-type instruction pattern
_ln0h	OK	-	For replacing the fixed-type instruction pattern
_hn1in	OK	-	For replacing the fixed-type instruction pattern
_hn1de	OK	-	For replacing the fixed-type instruction pattern
_hn2in	OK	-	For replacing the fixed-type instruction pattern
_hn2de	OK	-	For replacing the fixed-type instruction pattern
_hn4in	OK	-	For replacing the fixed-type instruction pattern
_hn4ip	OK	-	For replacing the fixed-type instruction pattern
_hn4de	OK	-	For replacing the fixed-type instruction pattern
_hn4dp	OK	-	For replacing the fixed-type instruction pattern

## 6.2 Interface Between Functions

Library functions are used with function calls. Function calls are done with the call instruction. Arguments are passed on the stack, return values are passed by registers.

However, if possible in the normal model, the first argument is also passed by registers. In the static model, all arguments are passed by register.

### 6.2.1 Arguments

When the Pascal function call interface option `-zr` is specified, and arguments are passed on the stack, the arguments are removed from the stack by the called function.

In the static model, all arguments are passed by register.

Up to a maximum of 3 arguments, totaling 6 bytes in size, can be passed. Passing of float, double, and structure arguments is not supported.

The function interface (passing arguments, storing return values) for the standard library is the same as that of regular functions.

For details see "[3.4.2 Ordinary function call interface](#)".

### 6.2.2 Return values

Return values are a minimum of 16 bits and are stored in 16-bit units from the low-order bits from register BC to DE. When returning a structure, the structure's starting address is stored in BC. Pointers are returned in BC.

For details see "[3.4.1 Return values](#)".

### 6.2.3 Saving registers used by separate libraries

Libraries that use HL (normal model), DE (static model) save registers that use those to the stack.

Libraries that use the `saddr` area save the `saddr` area to use to the stack.

The work area used by libraries also use the stack area.

#### (1) When the `-zr` option is not specified

Arguments are passed and values returned as described below.

The following show the function to call.

```
"long func ( int a, long b, char *c );"
```

**(a) Push arguments on the stack (function call source)**

The arguments are pushed onto the stack in the order c, b in the high-order 16 bits, b in the low-order 16 bits. a is passed in the AX register.

**(b) Call func with the call instruction (function call source)**

After b in the low-order 16 bits, the return address is pushed onto the stack, control moves to the function func.

**(c) Save the registers to use in the function (function call target)**

When using HL, HL is pushed onto the stack.

**(d) Push the first argument passed by the register onto the stack (function call target)**

**(e) Perform processing for the function func, store the return value in a register (function call target)**

The low-order 16 bits of the return value "long" are stored in BC, the high-order 16 bits are stored in DE.

**(f) Restore the stored first argument (function call target)**

**(g) Restore the saved registers (function call target)**

**(h) Return control to the calling function with the ret instruction (function call target)**

**(i) Clear the arguments off the stack (function call source)**

The number of bytes (2-byte units) of the arguments is added to the stack pointer. 6 is added to the stack pointer.

Figure 6-1. Stack Area During Function Call

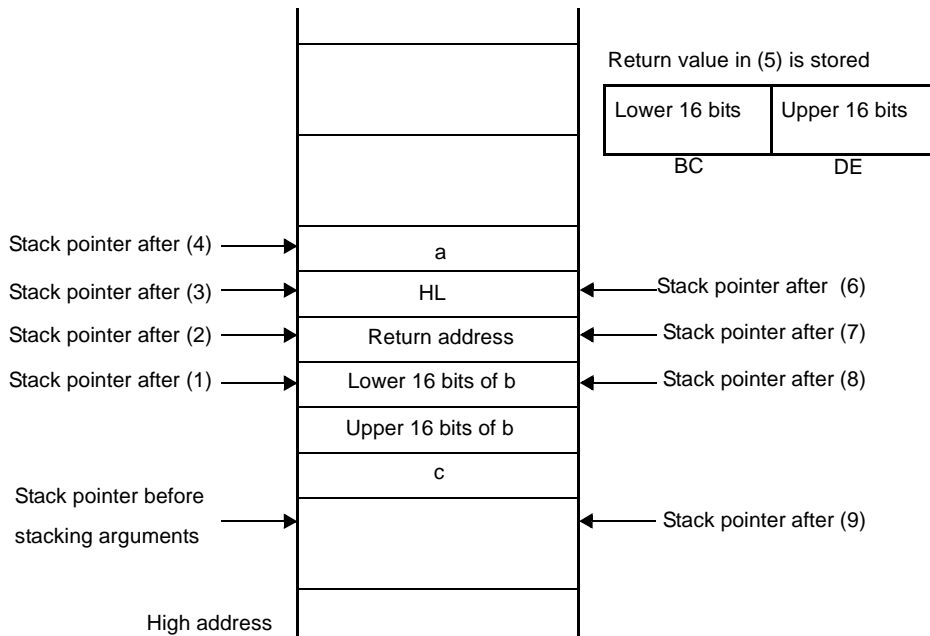

**(2) When the -zr option is specified**

When the -zr option is specified, arguments are passed and values are returned as described below. This example describes the procedure from the viewpoint of the calling side.

```
"long func ( int a, long b, char *c ); "
```

**(a) Place the arguments on the stack. (calling side)**

The high-order bits of c and b are placed on the stack, followed by the low-order 16 bits of b. a is passed in AX.

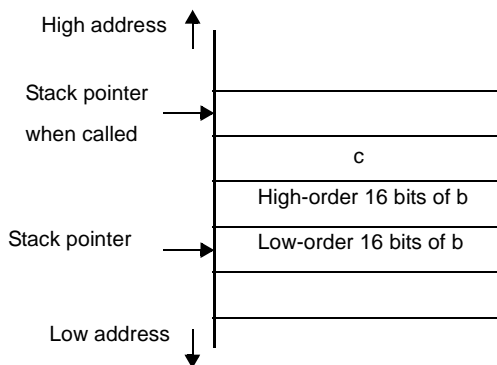

**(b) Call func with the call instruction. (calling side)**

Control is passed to function func with the stack in the state shown below.

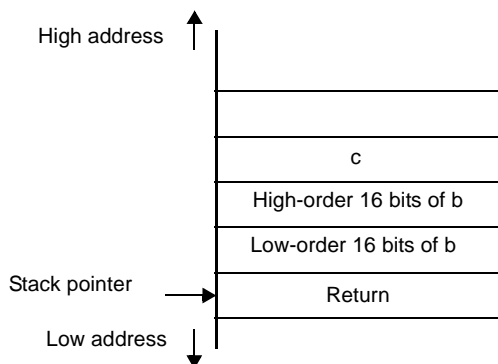

**(c) Save registers used in the function. (called side)**

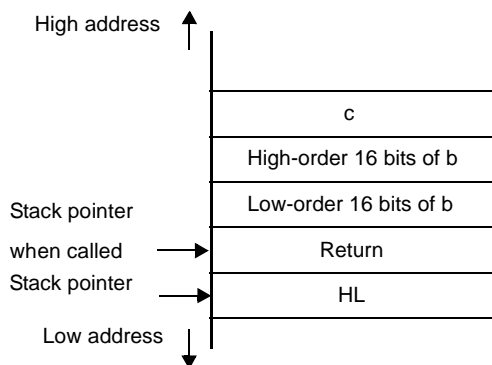



(d) The first argument was passed by register. Place it on the stack.

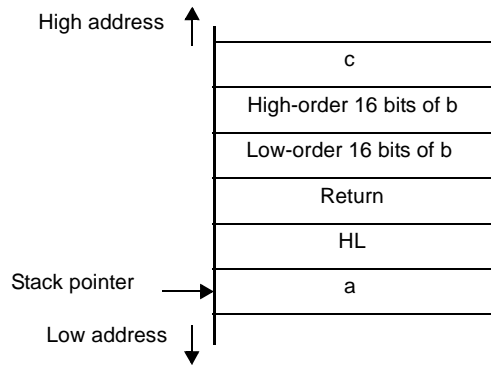

(e) Perform the processing of function func, and store the return value in a register. (called side)

The return value is a long. Store the low-order 16 bits in BC and the high-order 16 bits in DE.

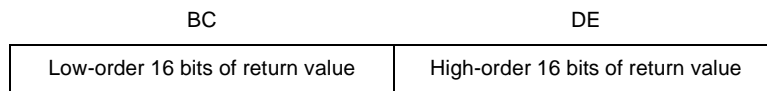

(f) Restore the saved first argument. (called side)

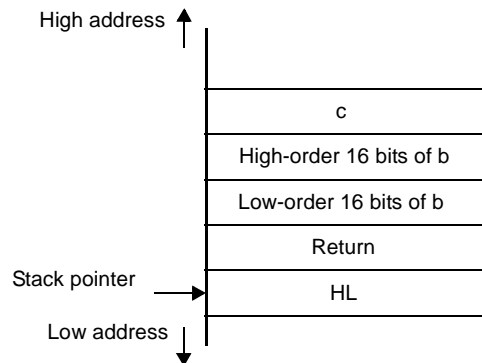

(g) Restore the saved registers. (called side)

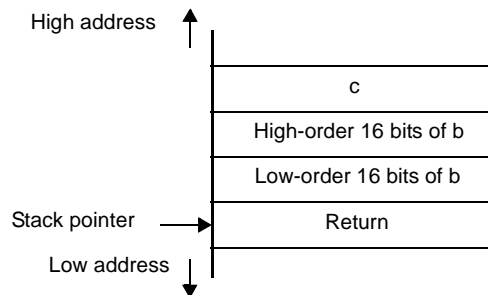

- (h) Store the return address in a register and remove the arguments from the stack by moving the stack pointer to where it was before storing the arguments. (called side)

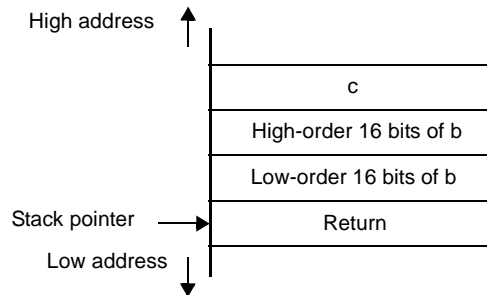

- (i) Put the return address that was saved in a register back on the stack. (called side)

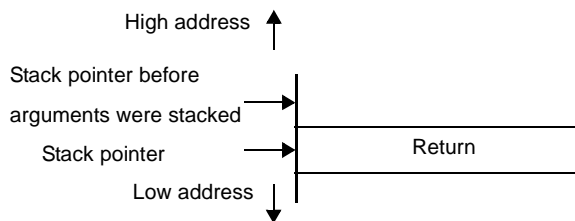

- (j) Execute the ret instruction to return control to the calling side. (called side)

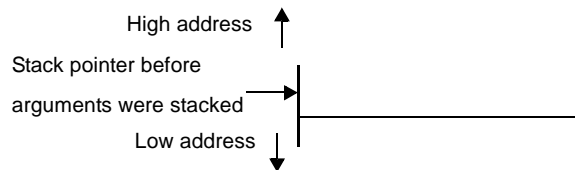

**6.2.4 Bank area restrictions**

Function pointers are 4 bytes in size when the bank function (-mf) is used. Consequently, the following limitations apply to functions that use function pointers and addresses.

**(1) Functions that use pointers**

```
sprintf , sscanf , printf , scanf , vsprintf , vsprintf
```

Normal operation is not guaranteed when a function pointer is passed as an argument.

**(2) Functions that handle addresses**

```
setjmp
```

Information in the selected bank cannot be saved.

Do not use setjmp from functions allocated to a bank area.

Normal operation by longjmp is not guaranteed, because bank information cannot be restored.

**(3) Functions that use function pointers as arguments**

```
bsearch , qsort , atexit
```

Four-byte function pointers cannot be used.

Do not use these functions when the bank function (-mf) is used.

**6.3 Header Files**

There are 13 header files in 78K0 C compiler and they define and declare the standard library functions, type names, and macro names.

78K0 C compiler header files are shown next.

Header File Name	Function
<a href="#">ctype.h</a>	Define character and string functions
<a href="#">setjmp.h</a>	Define program control functions
<a href="#">stdarg.h (normal model only)</a>	Define special functions
<a href="#">stdio.h</a>	Define I/O functions.
<a href="#">stdlib.h</a>	Define character and string functions, memory functions, program control functions, mathematical functions, and special functions
<a href="#">string.h</a>	Define character and string functions, memory functions, and special functions
<a href="#">error.h</a>	Includes errno.h
<a href="#">errno.h</a>	Declare variables, define macro names
<a href="#">limits.h</a>	Define macro names
<a href="#">stddef.h</a>	Declare type name, Define macro names
<a href="#">math.h (normal model only)</a>	Define mathematics function
<a href="#">float.h</a>	Define macro names
<a href="#">assert.h (normal model only)</a>	Define diagnostic function

**Caution** Supported functions differ according to the memory model (normal model or static model). The behavior of some functions is affected by the -zi and -zl options. A warning to the effect that a function is not correctly prototyped is issued for functions that do not behave correctly because of the -zi or -zl option setting.

**6.3.1 ctype.h**

ctype.h defines character/string functions.

In ctype.h, the following functions are defined.

However, when compiler option -za (the option to turn off non-ANSI compliant functions and turn on a portion of ANSI compliant functions) is specified, \_toupper and \_tolower are not defined, in their place tolow and toup are defined. When -za is not specified, tolow and toup are not defined. The functions declared also vary depending on the options and specific model.

Function Name	Existence of -zi, or -zl Specification							
	Normal Model				Static Model			
	None	zi	zl	zi zl	None	zi	zl	zi zl
isalpha	OK	OK	OK	OK	OK	NG	OK	NG
isupper	OK	OK	OK	OK	OK	NG	OK	NG
islower	OK	OK	OK	OK	OK	NG	OK	NG
isdigit	OK	OK	OK	OK	OK	NG	OK	NG
isalnum	OK	OK	OK	OK	OK	NG	OK	NG
isxdigit	OK	OK	OK	OK	OK	NG	OK	NG
isspace	OK	OK	OK	OK	OK	NG	OK	NG
ispunct	OK	OK	OK	OK	OK	NG	OK	NG
isprint	OK	OK	OK	OK	OK	NG	OK	NG
isgraph	OK	OK	OK	OK	OK	NG	OK	NG
iscntrl	OK	OK	OK	OK	OK	NG	OK	NG
isascii	OK	OK	OK	OK	OK	NG	OK	NG
toupper	OK	OK	OK	OK	OK	NG	OK	NG
tolower	OK	OK	OK	OK	OK	NG	OK	NG
toascii	OK	OK	OK	OK	OK	NG	OK	NG
_toupper	OK	OK	OK	OK	OK	NG	OK	NG
toup	OK	OK	OK	OK	OK	NG	OK	NG
_tolower	OK	OK	OK	OK	OK	NG	OK	NG
tolow	OK	OK	OK	OK	OK	NG	OK	NG

OK : Supported  
 NG : Not supported

### 6.3.2 setjmp.h

setjmp.h defines program control functions.

In setjmp.h, the following functions are defined. In addition, the functions declared also vary depending on the options and specific model.

Function Name	Existence of -zi, or -zl Specification							
	Normal Model				Static Model			
	None	zi	zl	zi zl	None	zi	zl	zi zl
setjmp	OK	OK	OK	OK	OK	NG	OK	NG
longjmp	OK	OK	OK	OK	OK	NG	OK	NG

OK : Supported  
 NG: Not supported

setjmp.h declares the following objects.

- Declaration of the int array type "jmp\_buf"
- Normal model

```
typedef int    jmp_buf[11]
```

- Static model

```
typedef int    jmp_buf[3]
```

### 6.3.3 stdarg.h (normal model only)

stdarg.h defines special functions.

In stdarg.h, the following functions are defined.

Function Name	Existence of -zi, or -zl Specification			
	Normal Model			
	None	zi	zl	zi zl
va_arg	OK	OK	OK	OK
va_start	Δ	Δ	Δ	Δ
va_starttop	Δ	Δ	Δ	Δ
va_end	OK	OK	OK	OK

OK : Supported

Δ : Supported, but with limitations

In stdarg.h, the following object is defined.

- Declaration of the pointer type "va\_list" to char

```
typedef char    *va_list ;
```

### 6.3.4 stdio.h

stdio.h defines input/output functions. In stdio.h, the following functions are defined.

However, the functions declared vary depending on the options and specific model

Function Name	Existence of -zi, or -zl Specification							
	Normal Model				Static Model			
	None	zi	zl	zi zl	None	zi	zl	zi zl
sprintf	OK	-	OK	-	NG	NG	NG	NG
sscanf	OK	-	OK	-	NG	NG	NG	NG

Function Name	Existence of -zi, or -zl Specification							
	Normal Model				Static Model			
	None	zi	zl	zi zl	None	zi	zl	zi zl
printf	OK	-	OK	-	NG	NG	NG	NG
scanf	OK	-	OK	-	NG	NG	NG	NG
vprintf	OK	-	OK	-	NG	NG	NG	NG
vsprintf	OK	-	OK	-	NG	NG	NG	NG
getchar	OK	OK	OK	OK	OK	NG	OK	NG
gets	OK	OK	OK	OK	OK	OK	OK	OK
putchar	OK	OK	OK	OK	OK	NG	OK	NG
puts	OK	OK	OK	OK	OK	NG	OK	NG

- OK : Supported
- NG : Not supported
- : Normal operation not guaranteed

The following macro name is declared.

```
#define EOF      ( -1 )
```

**6.3.5 stdlib.h**

stdlib.h defines character/string functions, memory functions, program control, math functions, and special functions. In stdlib.h, the following functions are defined.

However, when compiler option -za (the option to turn off non-ANSI compliant functions and turn on a portion of ANSI compliant functions) is specified, brk, sbrk, itoa, ltoa, and ultoa are not defined, in their place strbrk, strsrbrk, strittoa, strtlttoa, and strulttoa are defined. When -za is not specified, these functions are not defined.

Function Name	Existence of -zi, or -zl Specification							
	Normal Model				Static Model			
	None	zi	zl	zi zl	None	zi	zl	zi zl
atoi	OK	-	OK	-	OK	NG	OK	NG
atol	OK	OK	-	-	NG	NG	NG	NG
strtol	OK	OK	-	-	NG	NG	NG	NG
strtoul	OK	OK	-	-	NG	NG	NG	NG
calloc	OK	OK	OK	OK	OK	NG	OK	NG
free	OK	OK	OK	OK	OK	NG	OK	NG
malloc	OK	OK	OK	OK	OK	NG	OK	NG
realloc	OK	OK	OK	OK	OK	NG	OK	NG
abort	OK	OK	OK	OK	OK	OK	OK	OK
atexit	OK	OK	OK	OK	OK	NG	OK	NG
exit	OK	OK	OK	OK	OK	NG	OK	NG

Function Name	Existence of -zi, or -zl Specification							
	Normal Model				Static Model			
	None	zi	zl	zi zl	None	zi	zl	zi zl
abs	OK	OK	OK	OK	OK	NG	OK	NG
labs	OK	OK	-	-	NG	NG	NG	NG
div	OK	NG	OK	NG	NG	NG	NG	NG
ldiv	OK	OK	NG	NG	NG	NG	NG	NG
brk	OK	OK	OK	OK	OK	NG	OK	NG
sbrk	OK	OK	OK	OK	OK	NG	OK	NG
atof	OK	OK	OK	OK	NG	NG	NG	NG
strtod	OK	OK	OK	OK	NG	NG	NG	NG
itoa	OK	OK	OK	OK	OK	NG	OK	NG
ltoa	OK	OK	NG	NG	NG	NG	NG	NG
ultoa	OK	OK	NG	NG	NG	NG	NG	NG
rand	OK	-	OK	-	NG	NG	NG	NG
srand	OK	OK	OK	OK	NG	NG	NG	NG
bsearch	OK	OK	OK	OK	NG	NG	NG	NG
qsort	OK	OK	OK	OK	NG	NG	NG	NG
strbrk	OK	OK	OK	OK	OK	NG	OK	NG
strsbrk	OK	OK	OK	OK	OK	NG	OK	NG
strtoa	OK	OK	OK	OK	OK	NG	OK	NG
strltoa	OK	OK	NG	NG	NG	NG	NG	NG
strultoa	OK	OK	NG	NG	NG	NG	NG	NG

- OK : Supported
- NG : Not supported
- : Normal operation not guaranteed

In stdlib.h, the following objects are declared.

- Declaration of the structure type "div\_t" with int members "quot" and "rem" (except static model).

```
typedef struct {
    int    quot ;
    int    rem ;
} div_t ;
```

- Declaration of structure "ldiv\_t" with long int members "quot" and "rem" (except for static model, and normal model when -zl option is specified).

```
typedef struct {
    long int    quot ;
    long int    rem ;
} ldiv_t ;
```

- Definition of the macro name "RAND\_MAX"

```
#define RAND_MAX    32767
```

- Macro name declarations

```
#define EXIT_SUCCESS    0
#define EXIT_FAILURE    1
```

**6.3.6 string.h**

string.h defines character/string functions, memory functions, and special functions.

In string.h, the following functions are defined.

However, the functions declared vary depending on the options and specific model.

Function Name	Existence of -zi, or -zl Specification							
	Normal Model				Static Model			
	None	zi	zl	zi zl	None	zi	zl	zi zl
memcpy	OK	OK	OK	OK	OK	NG	OK	NG
memmove	OK	OK	OK	OK	OK	NG	OK	NG
strcpy	OK	OK	OK	OK	OK	OK	OK	OK
strncpy	OK	OK	OK	OK	OK	NG	OK	NG
strcat	OK	OK	OK	OK	OK	OK	OK	OK
strncat	OK	OK	OK	OK	OK	NG	OK	NG
memcmp	OK	-	OK	-	OK	NG	OK	NG
strcmp	OK	-	OK	-	OK	NG	OK	NG
strncmp	OK	-	OK	-	OK	NG	OK	NG
memchr	OK	OK	OK	OK	OK	NG	OK	NG
strchr	OK	OK	OK	OK	OK	NG	OK	NG
strrchr	OK	OK	OK	OK	OK	NG	OK	NG
strspn	OK	-	OK	-	OK	NG	OK	NG
strcspn	OK	-	OK	-	OK	NG	OK	NG
strpbrk	OK	OK	OK	OK	OK	OK	OK	OK
strstr	OK	OK	OK	OK	OK	OK	OK	OK
strtok	OK	OK	OK	OK	OK	OK	OK	OK



Function Name	Existence of -zi, or -zl Specification							
	Normal Model				Static Model			
	None	zi	zl	zi zl	None	zi	zl	zi zl
memset	OK	OK	OK	OK	OK	NG	OK	NG
strerror	OK	OK	OK	OK	OK	NG	OK	NG
strlen	OK	-	OK	-	OK	NG	OK	NG
strcoll	OK	-	OK	-	OK	NG	OK	NG
strxfrm	OK	-	OK	-	OK	NG	OK	NG

OK : Supported

NG: Not supported

- : Normal operation not guaranteed

### 6.3.7 error.h

error.h includes errno.h.

### 6.3.8 errno.h

The following objects are declared or defined

- Definition of the macro names "EDOM", "ERANGE", "ENOMEM"

```
#define EDOM 1
#define ERANGE 2
#define ENOMEM 3
```

- eclaration of the external variable "errno" of the volatile int type

```
extern volatile int errno ;
```

### 6.3.9 limits.h

In limits.h, the following macro names are defined.

```
#define CHAR_BIT 8
#define CHAR_MAX +127
#define CHAR_MIN -128
#define INT_MAX +32767
#define INT_MIN -32768
#define LONG_MAX +2147483647
#define LONG_MIN -2147483648

#define SCHAR_MAX +127
#define SCHAR_MIN -128
#define SHRT_MAX +32767
#define SHRT_MIN -32768
```

```
#define UCHAR_MAX      255U
#define UINT_MAX       65535U
#define ULONG_MAX      4294967295U
#define USHRT_MAX      65535U

#define SINT_MAX       +32767
#define SINT_MIN       -32768
#define SSHRT_MAX      +32767
#define SSHRT_MIN      -32768
```

However, when the `-qu` option is specified, which considers an unmodified char as an unsigned char, `CHAR_MAX` and `CHAR_MIN` are declared in the following manner by the macro `__CHAR_UNSIGNED__` declared by the compiler.

```
#define CHAR_MAX      ( 255U )
#define CHAR_MIN      ( 0 )
```

When the compiler `-zi` option (int and short types are regarded as char types, and unsigned int and unsigned short types are regarded as unsigned char types) is specified, then `INT_MAX`, `INT_MIN`, `SHRT_MAX`, `SHRT_MIN`, `SINT_MAX`, `SINT_MIN`, `SSHRT_MAX`, `SSHRT_MIN`, `UINT_MAX`, and `USHRT_MAX` are declared as follows, via the `__FROM_INT_TO_CHAR__` macro defined by the compiler.

```
#define INT_MAX        CHAR_MAX
#define INT_MIN        CHAR_MIN
#define SHRT_MAX       CHAR_MAX
#define SHRT_MIN       CHAR_MIN
#define SINT_MAXS      CHAR_MAX
#define SINT_MINS      CHAR_MIN
#define SSHRT_MAXS     CHAR_MAX
#define SSHRT_MINS     CHAR_MIN
#define UINT_MAX       UCHAR_MAX
#define USHRT_MAX      UCHAR_MIN
```

When the compiler `-zl` option (long type is regarded as int type, and unsigned long type is regarded as unsigned int type) is specified, then `LONG_MAX`, `LONG_MIN`, and `ULONG_MAX` are declared as follows, via the `__FROM_LONG_TO_INT__` macro defined by the compiler.

```
#define LONG_MAX      ( +32767 )
#define LONG_MIN      ( -32768 )
#define ULONG_MAX     ( 65535U )
```

### 6.3.10 `stdint.h`

In `stdint.h`, the following objects are declared or defined.

- Declaration of the int type "ptrdiff\_t"

```
typedef int    ptrdiff_t ;
```

- Declaration of the unsigned int type "size\_t"

```
typedef unsigned int    size_t ;
```

- Definition of the macro name "NULL"

```
#define NULL    ( void * ) 0 ;
```

- Definition of the macro name "offsetof"

```
#define offsetof ( type, member )    ( (size_t) & ( ( (type*)0) -> member) )
```

**Remark** `offsetof ( type, member-designator )`

Expands to a general integer constant expression of type `size_t`, and that value is the offset value in bytes from the start of the structure (specified by the type) to the structure member (specified by the member designator).

When the member specifier has been declared as static type `t`;, the result of evaluating expression `&( t.member specifier)` must be an address constant. When the specified member is a bit field, there is no guarantee of the operation.

**6.3.11 math.h (normal model only)**

In `math.h`, the following functions are defined

Function Name	Existence of -zi, or -zl Specification			
	Normal Model			
	None	zi	zl	zi zl
acos	OK	OK	OK	OK
asin	OK	OK	OK	OK
atan	OK	OK	OK	OK
atan2	OK	OK	OK	OK
cos	OK	OK	OK	OK
sin	OK	OK	OK	OK
tan	OK	OK	OK	OK
cosh	OK	OK	OK	OK
sinh	OK	OK	OK	OK
tanh	OK	OK	OK	OK
exp	OK	OK	OK	OK
frexp	OK	OK	OK	OK
ldexp	OK	OK	OK	OK
log	OK	OK	OK	OK
log10	OK	OK	OK	OK
modf	OK	OK	OK	OK

Function Name	Existence of -zi, or -zl Specification			
	Normal Model			
	None	zi	zl	zi zl
pow	OK	OK	OK	OK
sqrt	OK	OK	OK	OK
ceil	OK	OK	OK	OK
fabs	OK	OK	OK	OK
floor	OK	OK	OK	OK
fmod	OK	OK	OK	OK
matherr	OK	NG	OK	NG
acosf	OK	OK	OK	OK
asinf	OK	OK	OK	OK
atanf	OK	OK	OK	OK
atan2f	OK	OK	OK	OK
cosf	OK	OK	OK	OK
sinf	OK	OK	OK	OK
tanf	OK	OK	OK	OK
coshf	OK	OK	OK	OK
sinhf	OK	OK	OK	OK
tanhf	OK	OK	OK	OK
expf	OK	OK	OK	OK
frexpf	OK	OK	OK	OK
ldexpf	OK	OK	OK	OK
logf	OK	OK	OK	OK
log10f	OK	OK	OK	OK
modff	OK	OK	OK	OK
powf	OK	OK	OK	OK
sqrtf	OK	OK	OK	OK
ceilf	OK	OK	OK	OK
fabsf	OK	OK	OK	OK
floorf	OK	OK	OK	OK
fmodf	OK	OK	OK	OK

OK : Supported

NG : Not supported

The following objects are defined.

- Definition of the macro name "HUGE\_VAL"

```
#define HUGE_VAL      DBL_MAX
```

### 6.3.12 float.h

In float.h, the following objects are defined.

The macros defined are split according to the macro `__DOUBLE_IS_32BITS__` which is declared by the compiler when the size of the double type is 32 bits.

```
#ifndef _FLOAT_H

#define FLT_ROUNDS      1
#define FLT_RADIX      2

#ifdef __DOUBLE_IS_32BITS__
#define FLT_MANT_DIG    24
#define DBL_MANT_DIG    24
#define LDBL_MANT_DIG   24

#define FLT_DIG         6
#define DBL_DIG         6
#define LDBL_DIG       6

#define FLT_MIN_EXP     -125
#define DBL_MIN_EXP     -125
#define LDBL_MIN_EXP    -125

#define FLT_MIN_10_EXP  -37
#define DBL_MIN_10_EXP  -37
#define LDBL_MIN_10_EXP -37

#define FLT_MAX_EXP     +128
#define DBL_MAX_EXP     +128
#define LDBL_MAX_EXP    +128

#define FLT_MAX_10_EXP  +38
#define DBL_MAX_10_EXP  +38
#define LDBL_MAX_10_EXP +38

#define FLT_MAX         3.40282347E+38F
#define DBL_MAX         3.40282347E+38F
#define LDBL_MAX        3.40282347E+38F

#endif

#endif
```

```
#define FLT_EPSILON      1.19209290E-07F
#define DBL_EPSILON      1.19209290E-07F

#define LDBL_EPSILON     1.19209290E-07F

#define FLT_MIN          1.17549435E-38F
#define DBL_MIN          1.17549435E-38F
#define LDBL_MIN         1.17549435E-38F

/* __DOUBLE_IS_32BITS__ */
#define FLT_MANT_DIG     24
#define DBL_MANT_DIG     53
#define LDBL_MANT_DIG    53

#define FLT_DIG          6
#define DBL_DIG          15
#define LDBL_DIG         15

#define FLT_MIN_EXP      -125
#define DBL_MIN_EXP      -1021
#define LDBL_MIN_EXP     -1021

#define FLT_MIN_10_EXP   -37
#define DBL_MIN_10_EXP   -307
#define LDBL_MIN_10_EXP  -307

#define FLT_MAX_EXP      +128
#define DBL_MAX_EXP      +1024
#define LDBL_MAX_EXP     +1024

#define FLT_MAX_10_EXP   +38
#define DBL_MAX_10_EXP   +308
#define LDBL_MAX_10_EXP  +308

#define FLT_MAX          3.40282347E+38F
#define DBL_MAX          1.7976931348623157E+308
#define LDBL_MAX         1.7976931348623157E+308

#define FLT_EPSILON      1.19209290E-07F
#define DBL_EPSILON      2.2204460492503131E-016
#define LDBL_EPSILON     2.2204460492503131E-016

#define FLT_MIN          1.17549435E-38F
#define DBL_MIN          2.225073858507201E-308
#define LDBL_MIN         2.225073858507201E-308

#endif /* __DOUBLE_IS_32BITS__ */
```

```
#define _FLOAT_H
#endif /* !_FLOAT_H */
```

**6.3.13 assert.h (normal model only)**

In assert.h, the following functions are defined.

Function Name	Existence of -zi, or -zl Specification			
	Normal Model			
	None	zi	zl	zi zl
__assertfail	OK	OK	OK	OK

OK : Supported

In assert.h, the following objects are defined.

```
#ifdef NDEBUG
#define assert ( p ) ( ( void ) 0 )
#else
extern int __assertfail ( char *__msg, char *__cond, char *__file, int __line );
#define assert ( p ) ( ( p ) ? ( void ) 0 : ( void ) __assertfail (
    "Assertion failed : %s, file %s, line %d\n",
    #p, __FILE__, __LINE__ ) )
#endif /* NDEBUG */
```

However, the assert.h header file references one more macro, NDEBUG, which is not defined in the assert.h header file. If NDEBUG is defined as a macro when assert.h is included in the source file, the assert macro is simply defined as shown next, and \_\_assertfail is also not defined.

```
#define assert ( p ) ( ( void ) 0 )
```

**6.4 Re-entrant (Normal Model Only)**

Re-entrant is a state where it is possible for a function called by a program to be successively called by another program.

The 78K0 C compiler standard library takes re-entrantability into consideration and does not use static areas. Therefore, the data in the memory area used by the function is not damaged by a call from another program.

However, be careful as the following functions are not re-entrant.

- Functions that cannot be made re-entrant

```
setjmp, longjmp, atexit, exit
```

- Functions that use the area acquired by the startup routine

```
div, ldiv, brk, sbrk, rand, srand, strtok
```

- Functions that deals with floating point numbers

<code>sprintf, sscanf, printf, scanf, vprintf, vsprintf<sup>Note</sup></code> <code>atof, strtod, all math functions</code>
--

**Note** Of `sprintf`, `sscanf`, `printf`, `scanf`, `vprintf`, and `vsprintf`, functions that do not support floating point are re-entrant.



## 6.5 Character/String Functions

The following functions are available as character/string functions.

Function Name	Purpose
<a href="#">isalpha</a>	Judges if a character is an alphabetic character (A to Z, a to z)
<a href="#">isupper</a>	Judges if a character is an uppercase alphabetic character (A to Z)
<a href="#">islower</a>	Judges if a character is a lowercase alphabetic character (a to z)
<a href="#">isdigit</a>	Judges if a character is a numeric (0 to 9)
<a href="#">isalnum</a>	Judges if a character is an alphanumeric character (0 to 9, A to Z, a to z)
<a href="#">isxdigit</a>	Judges if a character is a hexadecimal numbers (0 to 9, A to F, a to f)
<a href="#">isspace</a>	Judges if a character is a whitespace character (whitespace, tab, carriage return, line feed, vertical, tab, form feed)
<a href="#">ispunct</a>	Judges if a character is a printable character other than a whitespace character or alphanumeric character
<a href="#">isprint</a>	Judges if a character is a printable character
<a href="#">isgraph</a>	Judges if a character is a printable character other than whitespace
<a href="#">iscntrl</a>	Judges if a character is a control character
<a href="#">isascii</a>	Judges if a character is an ASCII code
<a href="#">toupper</a>	Converts a lowercase alphabetic character to uppercase
<a href="#">tolower</a>	Converts an uppercase alphabetic character to lowercase
<a href="#">toascii</a>	Converts the input to an ASCII code
<a href="#">_toupper</a>	Subtracts "a" from the input character and adds "A"
<a href="#">toup</a>	
<a href="#">_tolower</a>	Subtracts "A" from the input character and adds "a"
<a href="#">towl</a>	

**isalpha**

Judges if *c* is an alphabetic character (A to Z, a to z)

**[Syntax]**

```
#include <ctype.h>
int isalpha (int c) ;
```

**[Argument(s)/Return value]**

Argument	Return Value
<i>c</i> : Character to be judged	If character <i>c</i> is included in alphabetic character (A to Z or a to z) : 1 If character <i>c</i> is not included in alphabetic character (A to Z or a to z) : 0

**[Description]**

- If character *c* is included in alphabetic character (A to Z or a to z), 1 is returned.  
In other cases, 0 is returned.

**isupper**

Judges if *c* is an uppercase alphabetic character (A to Z)

**[Syntax]**

```
#include <ctype.h>
int isupper (int c) ;
```

**[Argument(s)/Return value]**

Argument	Return Value
<i>c</i> : Character to be judged	If character <i>c</i> is included in the uppercase letters (A to Z) : 1 If character <i>c</i> is not included in the uppercase letters (A to Z) : 0

**[Description]**

- If character *c* is included in uppercase letters character (A to Z), 1 is returned.  
In other cases, 0 is returned.

**islower**

Judges if *c* is an lowercase alphabetic character (a to z)

**[Syntax]**

```
#include <ctype.h>
int islower (int c) ;
```

**[Argument(s)/Return value]**

Argument	Return Value
<i>c</i> : Character to be judged	If character <i>c</i> is included in the lowercase letters (a to z) : 1 If character <i>c</i> is not included in the lowercase letters (a to z) : 0

**[Description]**

- If character *c* is included in the lowercase letters (a to z) , 1 is returned.  
In other cases, 0 is returned.

**isdigit**

Judges if *c* is a numeric (0 to 9)

**[Syntax]**

```
#include <ctype.h>
int isdigit (int c) ;
```

**[Argument(s)/Return value]**

Argument	Return Value
<i>c</i> : Character to be judged	If character <i>c</i> is included in the numeric characters (0 to 9) : 1 If character <i>c</i> is not included in the numeric characters (0 to 9) : 0

**[Description]**

- If character *c* is included in the numeric characters (0 to 9) , 1 is returned.  
In other cases, 0 is returned.

**isalnum**

Judges if *c* is an alphanumeric character (0 to 9, A to Z, a to z)

**[Syntax]**

```
#include <ctype.h>
int isalnum (int c) ;
```

**[Argument(s)/Return value]**

Argument	Return Value
<p><i>c</i> :</p> <p>Character to be judged</p>	<p>If character <i>c</i> is included in the alphanumeric characters (0 to 9 and A to Z or a to z) :</p> <p style="text-align: center;">1</p> <p>If character <i>c</i> is not included in the alphanumeric characters (0 to 9 and A to Z or a to z) :</p> <p style="text-align: center;">0</p>

**[Description]**

- If character *c* is included in the alphanumeric characters (0 to 9 and A to Z or a to z) , 1 is returned.
- In other cases, 0 is returned.

**isxdigit**

Judges if *c* is a hexadecimal numbers (0 to 9, A to F, a to f)

**[Syntax]**

```
#include <ctype.h>
int isxdigit (int c) ;
```

**[Argument(s)/Return value]**

Argument	Return Value
<p><i>c</i> :</p> <p>Character to be judged</p>	<p>If character <i>c</i> is included in the hexadecimal numbers (0 to 9 and A to F or a to f) :</p> <p style="text-align: center;">1</p> <p>If character <i>c</i> is not included in the hexadecimal numbers (0 to 9 and A to F or a to f) :</p> <p style="text-align: center;">0</p>

**[Description]**

- If character *c* is included in the hexadecimal numbers (0 to 9 and A to F or a to f), 1 is returned.
- In other cases, 0 is returned.

**isspace**

Judges if *c* is a whitespace character (space, tab, carriage return, line feed, vertical, tab, form feed)

**[Syntax]**

```
#include <ctype.h>
int isspace (int c) ;
```

**[Argument(s)/Return value]**

Argument	Return Value
<i>c</i> : Character to be judged	If character <i>c</i> is included in the whitespace characters : 1 If character <i>c</i> is not included in the whitespace characters : 0

**[Description]**

- If character *c* is included in the whitespace characters (space, tab, carriage return, line feed, vertical, tab, form feed), 1 is returned.
- In other cases, 0 is returned.



**ispunct**

Judges if *c* is a printable character other than a whitespace character or alphanumeric character

**[Syntax]**

```
#include <ctype.h>
int ispunct (int c) ;
```

**[Argument(s)/Return value]**

Argument	Return Value
<p><i>c</i> :</p> <p>Character to be judged</p>	<p>If character <i>c</i> is included in the printable characters except whitespace and alphanumeric characters :</p> <p style="text-align: center;">1</p> <p>If character <i>c</i> is not included in the printable characters except whitespace and alphanumeric characters :</p> <p style="text-align: center;">0</p>

**[Description]**

- If character *c* is included in the printable characters except whitespace and alphanumeric characters, 1 is returned. In other cases, 0 is returned.

**isprint**

Judges if *c* is a character is a printable character

**[Syntax]**

```
#include <ctype.h>
int isprint (int c) ;
```

**[Argument(s)/Return value]**

Argument	Return Value
<i>c</i> : Character to be judged	If character <i>c</i> is included in the printable characters : 1 If character <i>c</i> is not included in the printable characters : 0

**[Description]**

- If character *c* is included in the printable characters, 1 is returned.  
In other cases, 0 is returned.

**isgraph**

Judges if *c* is a printable character other than whitespace

**[Syntax]**

```
#include <ctype.h>
int isgraph (int c) ;
```

**[Argument(s)/Return value]**

Argument	Return Value
<p><i>c</i> :</p> <p>Character to be judged</p>	<p>If character <i>c</i> is included in the printable nonblank characters :</p> <p style="padding-left: 40px;">1</p> <p>If character <i>c</i> is not included in the printable nonblank characters :</p> <p style="padding-left: 40px;">0</p>

**[Description]**

- If character *c* is included in the printable nonblank character, 1 is returned.
- In other cases, 0 is returned.

**iscntrl**

Judges if *c* is a control character

**[Syntax]**

```
#include <ctype.h>
int iscntrl (int c) ;
```

**[Argument(s)/Return value]**

Argument	Return Value
<i>c</i> : Character to be judged	If character <i>c</i> is included in the control characters : 1 If character <i>c</i> is not included in the control characters : 0

**[Description]**

- If character *c* is included in the control characters , 1 is returned.  
In other cases, 0 is returned.

**isascii**

Judges if *c* is an ASCII code

**[Syntax]**

```
#include <ctype.h>
int isascii(int c);
```

**[Argument(s)/Return value]**

Argument	Return Value
<i>c</i> : Character to be judged	If character <i>c</i> is included in the ASCII code set : 1 If character <i>c</i> is not included in the ASCII code set : 0

**[Description]**

- If character *c* is included in the ASCII code set , 1 is returned.  
In other cases, 0 is returned.

**toupper**

Converts a lowercase alphabetic character to uppercase

**[Syntax]**

```
#include <ctype.h>
int toupper (int c) ;
```

**[Argument(s)/Return value]**

Argument	Return Value
<code>c</code> : Character to be converted	If <code>c</code> is a convertible character : uppercase equivalent of <code>c</code>  If not convertible : <code>c</code>

**[Description]**

- The `toupper` function checks to see if the argument is a lowercase letter and if so converts the letter to its uppercase equivalent.

**tolower**

Converts an uppercase alphabetic character to lowercase

**[Syntax]**

```
#include <ctype.h>
int tolower (int c) ;
```

**[Argument(s)/Return value]**

Argument	Return Value
<code>c</code> : Character to be converted	If <code>c</code> is a convertible character : lowercase equivalent of <code>c</code>  If not convertible : <code>c</code>

**[Description]**

- The `tolower` function checks to see if the argument is a uppercase letter and if so converts the letter to its lowercase equivalent.

**toascii**

Converts the input to an ASCII code

**[Syntax]**

```
#include <ctype.h>
int toascii (int c) ;
```

**[Argument(s)/Return value]**

Argument	Return Value
<p><i>c</i> :</p> <p>Character to be converted</p>	<p>Value obtained by converting the bits outside the ASCII code range of "c" to 0.</p>

**[Description]**

- The toascii function converts the bits (bits 7 to 15) of "c" outside the ASCII code range of "c" (bits 0 to 6) to "0" and returns the converted bit value.



**\_toupper**

Subtracts "a" from "c" and adds "A" to the result  
(\_toupper is exactly the same as toupper)

**Remark** a: Lowercase; A: Uppercase

**[Syntax]**

```
#include <ctype.h>
int _toupper (int c) ;
```

**[Argument(s)/Return value]**

Argument	Return Value
c : Character to be converted	Value obtained by adding "A" to the result of subtraction "c" - "a"

**Remark** a: Lowercase; A: Uppercase

**[Description]**

- The \_toupper function is similar to toupper except that it does not test to see if the argument is a lowercase letter.

**toup**

Subtracts "a" from "c" and adds "A" to the result  
(\_toupper is exactly the same as toup)

**Remark** a: Lowercase; A: Uppercase

**[Syntax]**

```
#include <ctype.h>
int toup (int c) ;
```

**[Argument(s)/Return value]**

Argument	Return Value
c : Character to be converted	Value obtained by adding "A" to the result of subtraction "c" - "a"

**Remark** a: Lowercase; A: Uppercase

**[Description]**

- The toup function is similar to \_toupper except that it tests to see if the argument is a lowercase letter.

**\_tolower**

Subtracts "A" from "c" and adds "a" to the result  
(\_tolower is exactly the same as the tolow)

**Remark** a: Lowercase; A: Uppercase

**[Syntax]**

```
#include <ctype.h>
int _tolower (int c) ;
```

**[Argument(s)/Return value]**

Argument	Return Value
c : Character to be converted	Value obtained by adding "a" to the result of subtraction "c" - "A"

**Remark** a: Lowercase; A: Uppercase

**[Description]**

- The \_tolower function is similar to tolow, except it does not test to see if the argument is an uppercase letter.

**tolower**

Subtracts "A" from "c" and adds "a" to the result  
(\_tolower is exactly the same as the tolow)

**Remark** a: Lowercase; A: Uppercase

**[Syntax]**

```
#include <ctype.h>
int tolow (int c);
```

**[Argument(s)/Return value]**

Argument	Return Value
c : Character to be converted	Value obtained by adding "a" to the result of subtraction "c" - "A"

**Remark** a: Lowercase; A: Uppercase

**[Description]**

- The tolow function is similar to \_tolower, except it tests to see if the argument is an uppercase letter.

## 6.6 Program Control Functions

The following program control functions are available.

Function Name	Purpose
<a href="#">setjmp</a>	Saves the environment at the time of the call
<a href="#">longjmp</a>	Restores the environment saved with setjmp

**setjmp**

Saves the environment at the time of the call

**[Syntax]**

```
#include <setjmp.h>
int setjmp (jmp_buf env) ;
```

**[Argument(s)/Return value]**

Argument	Return Value
<i>env</i> : Array to which environment information is to be saved	If called directly : 0 If returning from the corresponding longjmp : Value given by " <i>val</i> " or 1 if " <i>val</i> " is 0.

**[Description]**

- The setjmp, when called directly, saves saddr area, SP, and the return address of the function that are used as HL register (normal model), DE register (static model) or register variables to *env* and returns 0.

**longjmp**

Restores the environment saved with setjmp

**[Syntax]**

```
#include <setjmp.h>
void longjmp (jmp_buf env , int val) ;
```

**[Argument(s)/Return value]**

Argument	Return Value
<i>env</i> : Array to which environment information was saved by setjmp  <i>val</i> : Return value to setjmp	longjmp will not return because program execution resumes at statement next to setjmp that saved environment to " <i>env</i> ".

**[Description]**

- The longjmp restores the saved environment to *env* (HL register (normal model), DE register (static model), saddr area and SP that are used as register variables). Program execution continues as if the corresponding setjmp returns *val* (however, if *val* is 0, 1 is returned).

## 6.7 Special Functions

The following special functions are available.

Function Name	Purpose
<a href="#">va_start (normal model only)</a>	Settings for processing variable arguments
<a href="#">va_starttop (normal model only)</a>	Settings for processing variable arguments
<a href="#">va_arg (normal model only)</a>	Processes variable arguments
<a href="#">va_end (normal model only)</a>	Indicates the end of processing variable arguments



**va\_start (normal model only)**

Settings for processing variable arguments (macro)

**[Syntax]**

```
#include <stdarg.h>
void va_start (va_list ap , parmN );
```

**Remark** va\_list is defined as typedef by stdarg.h.

**[Argument(s)/Return value]**

Argument	Return Value
<p><i>ap</i> :</p> <p>Variable to be initialized so as to be used in va_arg and va_end</p> <p><i>parmN</i> :</p> <p>The argument before variable argument</p>	<p>None</p>

**[Description]**

- In the va\_start macro, its argument *ap* must be a va\_list type (char\* type) object.
- A pointer to the next argument of *parmN* is stored in *ap*.
- *parmN* is the name of the last (right-most) parameter specified in the function's prototype.
- If *parmN* has the register storage class, proper operation of this function is not guaranteed.
- If *parmN* is the first argument, this function may not operate normally (use va\_starttop instead).

**va\_starttop (normal model only)**

Settings for processing variable arguments (macro)

**[Syntax]**

```
#include <stdarg.h>
void va_starttop (va_list ap , parmN) ;
```

**Remark** va\_list is defined as typedef by stdarg.h.

**[Argument(s)/Return value]**

Argument	Return Value
<p><i>ap</i> :</p> <p>Variable to be initialized so as to be used in va_arg and va_end</p> <p><i>parmN</i> :</p> <p>The argument before variable argument</p>	<p>None</p>

**[Description]**

- *ap* must be a va\_list type object.
- A pointer to the next argument of *parmN* is stored in *ap*.
- *parmN* is the name of the right-most and first parameter specified in the function's prototype.
- If *parmN* has the register storage class, this function may not operate normally.
- If *parmN* is an argument other than the first argument, this function may not operate normally.

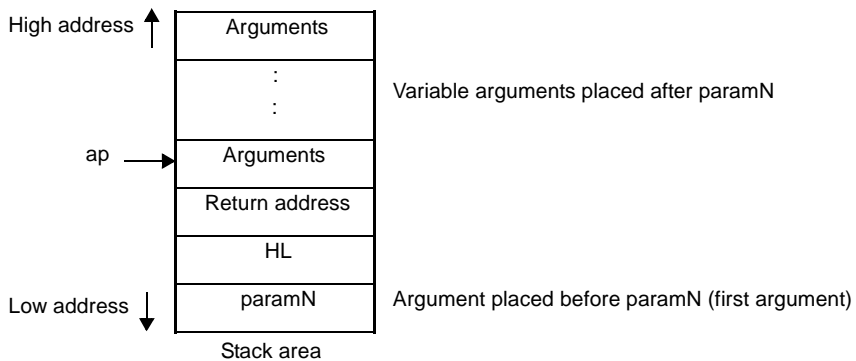

**va\_arg (normal model only)**

Processes variable arguments (macro)

**[Syntax]**

```
#include <stdarg.h>
type va_arg (va_list ap , type) ;
```

**Remark** va\_list is defined as typedef by stdarg.h.

**[Argument(s)/Return value]**

Argument	Return Value
<p><i>ap</i> :</p> <p>Variable to process an argument list</p> <p>type :</p> <p>Type to point the relevant place of variable argument (type is a type of variable length; for example, int type if described as va_arg (va_list ap, int) or long type if described as va_arg (va_list ap, long) )</p>	<p>Normal case :</p> <p>Value in the relevant place of variable argument</p> <p>If <i>ap</i> is a null pointer :</p> <p>0</p>

**[Description]**

- In the va\_arg macro, its argument *ap* must be the same as the va\_list type object initialized with va\_start (no guarantee for the other normal operation).
- va\_arg returns value in the relevant place of variable arguments as a type of type.  
The relevant place is the first of variable arguments immediately after va\_start and next proceeded in each va\_arg.
- If the argument pointer *ap* is a null pointer, the va\_arg returns 0 (of type type).

**va\_end (normal model only)**

Indicates the end of processing variable arguments (macro)

**[Syntax]**

```
#include <stdarg.h>
void va_end (va_list ap) ;
```

**Remark** va\_list is defined as typedef by stdarg.h.

**[Argument(s)/Return value]**

Argument	Return Value
<i>ap</i> : Variable to process the variable number of arguments	None

**[Description]**

- The va\_end macro sets a null pointer in the argument pointer *ap* to inform the macro processor that all the parameters in the variable argument list have been processed.

## 6.8 Input and Output Functions

The following input and output functions are available.

Function Name	Purpose
<a href="#">sprintf (normal model only)</a>	Writes data to a string according to a format
<a href="#">sscanf (normal model only)</a>	Reads data from the input string according to a format
<a href="#">printf (normal model only)</a>	Outputs data to SFR according to a format
<a href="#">scanf (normal model only)</a>	Reads data from SFR according to a format
<a href="#">vprintf (normal model only)</a>	Outputs data to SFR according to a format
<a href="#">vsprintf (normal model only)</a>	Writes data to a string according to a format
<a href="#">getchar</a>	Reads one character from SFR
<a href="#">gets</a>	Reads a string
<a href="#">putchar</a>	Outputs one character to SFR
<a href="#">puts</a>	Outputs a string

**sprintf (normal model only)**

Writes data to a string according to a format

**[Syntax]**

```
#include <stdio.h>
int sprintf (char *s , const char *format , ... ) ;
```

**[Argument(s)/Return value]**

Argument	Return Value
<p><i>s</i> :</p> <p>Pointer to the string into which the output is to be written</p> <p><i>format</i> :</p> <p>Pointer to the string which indicates format commands</p> <p>... :</p> <p>Zero or more arguments to be converted</p>	<p>Number of characters written in <i>s</i> (Terminating null character is not counted.)</p>

**[Description]**

- If there are fewer actual arguments than the formats, the proper operation is not guaranteed. In the case that the formats are run out despite the actual arguments still remain, the excess actual arguments are only evaluated and ignored.
- `sprintf` converts zero or more arguments that follow *format* according to the format command specified by *format* and writes (copies) them into the string *s*.
- Zero or more format commands may be used. Ordinary characters (other than format commands that begin with a % character) are output as is to the string *s*. Each format command takes zero or more arguments that follow *format* and outputs them to the string *s*.
- Each format command begins with a % character and is followed by these:

**(1) Zero or more flags (to be explained later) that modify the meaning of the format command****(2) Optional decimal integer which specify a minimum field width**

If the output width after the conversion is less than this minimum field width, this specifier pads the output with blanks or zeros on its left. (If the left-justifying flag "-" (minus) sign follows %, zeros are padded out to the right of the output.) The default padding is done with spaces. If the output is to be padded with 0s, place a 0 before the field width specifier. If the number or string is greater than the minimum field width, it will be printed in full even by overrunning the minimum.

- Optional precision (number of decimal places) specification (.integer)
  - With d, i, o, u, x, and X type specifiers, the minimum number of digits is specified.
  - With s type specifier, the maximum number of characters (maximum field width) is specified.
  - The number of digits to be output following the decimal point is specified for e, E, and f conversions. The number of maximum effective digits is specified for g and G conversions.
  - This precision specification must be made in the form of (.integer). If the integer part is omitted, 0 is assumed to have been specified.
  - The amount of padding resulting from this precision specification takes precedence over the padding by the field width specification.

- Optional h, l and L modifiers

The h modifier instructs the sprintf function to perform the d, i, o, u, x, or X type conversion that follows this modifier on short int or unsigned short int type. The h modifier instructs the sprintf function to perform the n type conversion that follows this modifier on a pointer to short int type.

The l modifier instructs the sprintf function to perform the d, i, o, u, x, or X type conversion that follows this modifier on long int or unsigned long int type. The h modifier instructs the sprintf function to perform the n type conversion that follows this modifier on a pointer to long int type.

For other type specifiers, the h, l or L modifier is ignored.

- Character that specifies the conversion (to be explained later)

In the minimum field width or precision (number of decimal places) specification, \* may be used in place of an integer string. In this case, the integer value will be given by the int argument (before the argument to be converted).

Any negative field width resulting from this will be interpreted as a positive field that follows the - (minus) flag. All negative precision will be ignored.

The following flags are used to modify a format command:

Flag	Contents
-	The result of a conversion is left-justified within the field.
+	The result of a signed conversion always begins with a + or - sign.
space	If the result of a signed conversion has no sign, space is prefixed to the output. If the + (plus) flag and space flag are specified at the same time, the space flag will be ignored.
#	The result is converted in the "assignment form". In the o type conversion, precision is increased so that the first digit becomes 0. In the x or X type conversion, 0x or 0X is prefixed to a nonzero result. In the e, E, and f type conversions, a decimal point is forcibly inserted to all the output values (in the default without #, a decimal point is displayed only when there is a value to follow). In the g and G type conversions, a decimal point is forcibly inserted to all the output values, and truncation of 0 to follow will not be allowed (in the default without #, a decimal point is displayed only when there is a value to follow. The 0 to follow will be truncated). In all the other conversions, the # flag is ignored.
0	The result is left padded with zeros instead of spaces. The 0 flag is ignored when it is specified together with the "-" flag. The 0 flag is ignored in d, i, o, u, x, and X conversions when the precision is specified.

The format codes for output conversion specifications are as follows:

Format Code	Contents
d, i	Converts int argument to signed decimal format.
o	Converts int argument to signed decimal format.
u	Converts int argument to unsigned octal format.
x	Converts int argument to unsigned hexadecimal format (with lowercase letters abcdef).
X	Converts int argument to unsigned hexadecimal format (with uppercase letters ABCDEF).

With d, i, o, u, x and X type specifiers, the minimum number of digits (minimum field width) of the result is specified. If the output is shorter than the minimum field width, it is padded with zeros.

If no precision is specified, 1 is assumed to have been specified.

Nothing will appear if 0 is converted with 0 precision.

Precision Code	Contents
f	Converts double argument as a signed value with [-] <i>ddd.dddd</i> format. <i>ddd</i> is one or more decimal number(s). The number of digits before the decimal point is determined by the absolute value of the number, and the number of digits after the decimal point is determined by the required precision. When the precision is omitted, it is interpreted as 6.
e	Converts double argument as a signed value with [-] <i>d.ddd e [sign] ddd</i> format. <i>d</i> is 1 decimal number, and <i>ddd</i> is one or more decimal number(s). <i>ddd</i> is exactly a 3- digit decimal number, and the sign is + or -. When the precision is omitted, it is interpreted as 6.
E	The same format as that of e except E is added instead of e before the exponent.
g	Uses whichever shorter method of f or e format when converting double argument based on the specified precision. e format is used only when the exponent of the value is smaller than -4 or larger than the specified number by precision. The following 0 are truncated, and the decimal point is displayed only when one or more numbers follow.
G	The same format as that of g except E is added instead of e before the exponent.
c	Converts int argument to unsigned char and writes the result as a single character.
s	The associated argument is a pointer to a string of characters and the characters in the string are written up to the terminating null character (but not included in the output). If precision is specified, the characters exceeding the maximum field width will be truncated off the end. When the precision is not specified or larger than the array, the array must include a null character.
p	The associated argument is a pointer to void and the pointer value is displayed in unsigned hexadecimal 4 digits (with 0s prefixed to less than a 4-digit pointer value). The large model is displayed in unsigned hexadecimal 8 digits (with 0 padded in dominance 2-digits and 0s prefixed to less than a 6-digit pointer value). The precision specification if any will be ignored.
n	The associated argument is an integer pointer into which the number of characters written thus far in the string "s" is placed. No conversion is performed.
%	Prints a % sign. The associated argument is not converted (but the flag and minimum field width specifications are effective).

- Operations for invalid conversion specifiers are not guaranteed.
  - When the actual argument is a union or a structure, or the pointer to indicate them (except the character type array in % s conversion or the pointer in % p conversion), operations are not guaranteed.
  - The conversion result will not be truncated even when there is no field width or the field width is small. In other words, when the number of characters of the conversion result are larger than the field width, the field is extended to the width that includes the conversion result.
  - The formats of the special output character string in %f, %e, %E, %g, %G conversions are shown below.
    - non-numeric -> "(NaN)"
    - +∞ -> "(+INF)"
    - ∞ -> "(-INF)"
- printf writes a null character at the end of the string s. (This character is included in the return value count.)



The syntax of *format* commands is illustrated below.

Figure 6-2. Syntax of *format* Commands

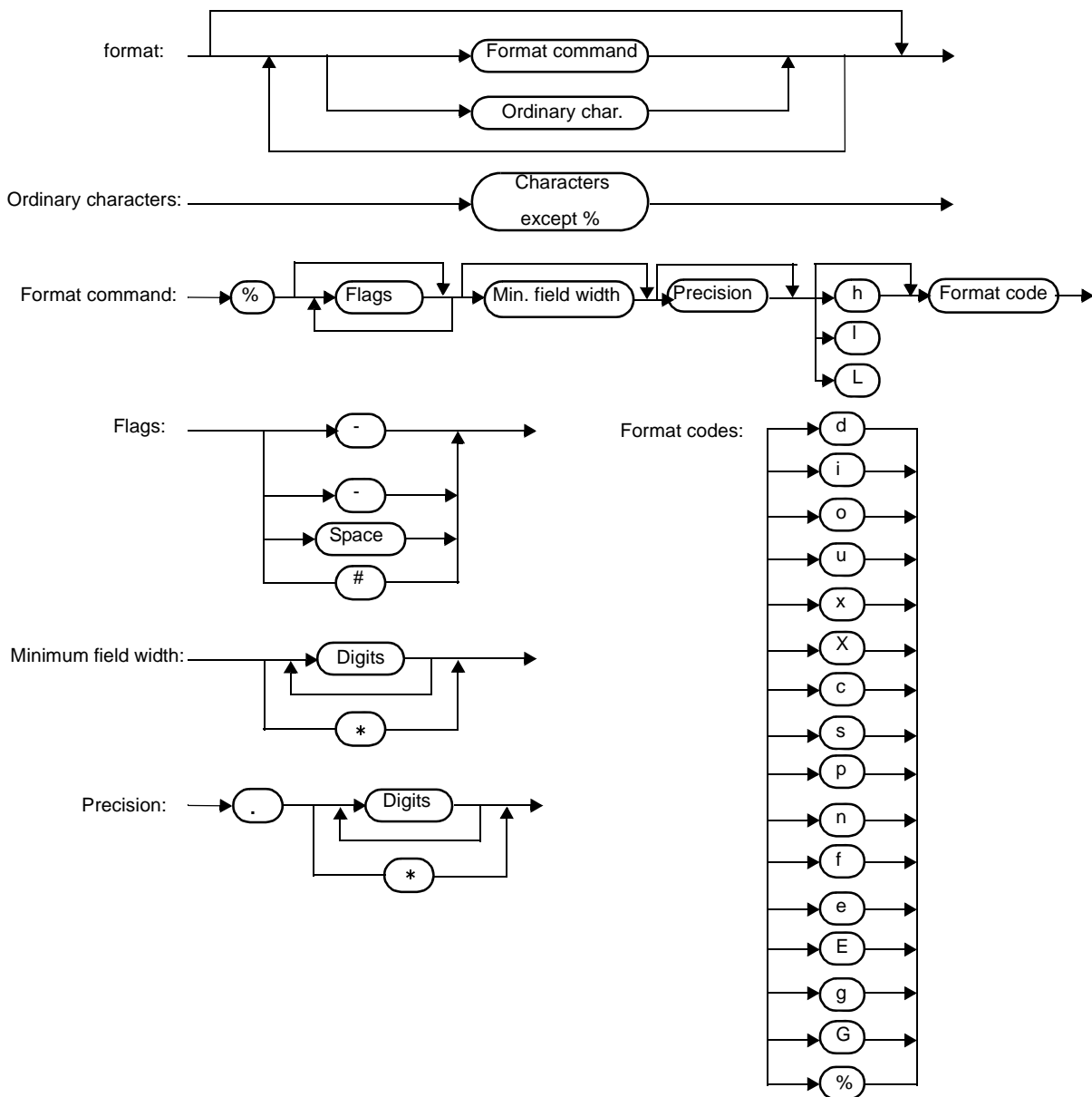

**sscanf (normal model only)**

Reads data from the input string according to a format

**[Syntax]**

```
#include <stdio.h>
int sscanf (const char *s , const char *format , ... ) ;
```

**[Argument(s)/Return value]**

Argument	Return Value
<p><i>s</i> :</p> <p>Pointer to the input string</p> <p><i>format</i> :</p> <p>Pointer to the string which indicates the input format commands</p> <p>... :</p> <p>Pointer to object in which converted values are to be stored, and zero or more arguments</p>	<p>If the string <i>s</i> is empty:</p> <p>-1</p> <p>If the string <i>s</i> is not empty :</p> <p>Number of assigned input data items</p>

**[Description]**

- sscanf inputs data from the string pointed to by *s*. The string pointed to by *format* specifies the input string allowed for input.
- Zero or more arguments after *format* are used as pointers to an object. *format* specifies how data is to be converted from the input string.
- If there are insufficient arguments to match the format commands pointed to by *format*, proper operation by the compiler is not guaranteed. For excessive arguments, expression evaluation will be performed but no data will be input.
- The control string pointed to by *format* consists of zero or more format commands which are classified into the following 3 types:
  - 1 : Whitespace characters (one or more characters for which isspace becomes true)
  - 2 : Non-whitespace characters (other than %)
  - 3 : Format specifiers
- Each format specifier begins with the % character and is followed by these:

**(1) Optional \* character which suppresses assignment of data to the corresponding argument**

**(2) Optional decimal integer which specifies a maximum field width**

**(3) Optional h, l or L modifier which indicates the object size on the receiving side**

If *h* precedes the *d*, *i*, *o*, or *x* format specifier, the argument is a pointer to not int but short int. If *l* precedes any of these format specifiers, the argument is a pointer to long int.

Likewise, if *h* precedes the *u* format specifier, the argument is a pointer to unsigned short int. If *l* precedes the *u* format specifier, the argument is a pointer to unsigned long int.

If *l* precedes the conversion specifier *e*, *E*, *f*, *g*, *G*, the argument is a pointer to double (a pointer to float in default without *l*). If *L* precedes, it is ignored.

**Remark** Conversion specifier: character to indicate the type of corresponding conversion (to be mentioned later)

- sscanf executes the format commands in "*format*" in sequence and if any format command fails, the function will terminate.

- (1) A white-space character in the control string causes sscanf to read any number (including zero) of whitespace character up to the first non-white-space character (which will not be read). This white-space character command fails if it does not encounter any non-white-space character.
- (2) A non-white-space character causes sscanf to read and discard a matching character. This command fails if the specified character is not found.
- (3) The format commands define a collection of input streams for each type specifier (to be detailed later). The format commands are executed according to the following steps:
  - (a) The input white-space characters (specified by isspace) are skipped over, except when the type specifier is [, c, or n.
  - (b) The input data items are read from the string "s", except when the type specifier is n. The input data items are defined as the longest input stream of the first partial stream of the string indicated by the type specifier (but up to the maximum field width if so specified). The character next to the input data items is interpreted as not have been read. If the length of the input data items is 0, the format command execution fails.
  - (c) The input data items (number of input characters with the type specifier n) are converted to the type specified by the type specifier except the type specifier %. If the input data items do not match with the specified type, the command execution fails. Unless assignment is suppressed by \*, the result of the conversion is stored in the object pointed to by the first argument which follows "*format*" and has not yet received the result of the conversion.

The following type specifiers are available:

Conversion Specifier	Contents
d	Converts a decimal integer (which may be signed). The corresponding argument must be a pointer to an integer.
l	Converts an integer (which may be signed). If a number is preceded by 0x or 0X, the number is interpreted as a hexadecimal integer. If a number is preceded by 0, the number is interpreted as an octal integer. Other numbers are regarded as decimal integers. The corresponding argument must be a pointer to an integer.
o	Converts an octal integer (which may be signed). The corresponding argument must be a pointer to an integer.
u	Converts an unsigned decimal integer. The corresponding argument must be a pointer to an unsigned integer.
x	Converts a hexadecimal integer (which may be signed).

Conversion Specifier	Contents
e, E, f, g, G	<p>Floating point value consists of optional sign (+ or -), one or more consecutive decimal number(s) including decimal point, optional exponent (e or E), and the following optional signed integer value.</p> <p>When overflow occurs as a result of conversion, or when underflow occurs with the conversion result <math>\pm \infty</math>, non-normalized number or <math>\pm 0</math> becomes the conversion result.</p> <p>The corresponding argument is a pointer to float.</p>
s	<p>Input a character string consisting of a non-blank character string.</p> <p>The corresponding argument is a pointer to an integer. 0x or 0X can be allocated at the first hexadecimal integer.</p> <p>The corresponding argument must be a pointer an array that has sufficient size to accommodate this character string and a null terminator.</p> <p>The null terminator will be automatically added.</p>
[	<p>Inputs a character string consisting of expected character groups (called a scanset).</p> <p>The corresponding argument must be a pointer to the first character of an array that has sufficient size to accommodate this character string and a null terminator.</p> <p>The null terminator will be automatically added.</p> <p>The format commands continue from this character up to the closing square bracket ( ) ). The character string (called a scanlist) enclosed in the square brackets constitutes a scanset except when the character immediately after the opening square bracket is a circumflex ( ^ ). When the character is a circumflex, all the characters other than a scanlist between the circumflex and the closing square bracket constitute a scanset. However, when a scanlist begins with [ ] or [ ^ ], this closing square bracket is contained in the scanlist and the next closing square list becomes the end of the scanlist.</p> <p>A hyphen (-) at other than the left or right end of a scanlist is interpreted as the punctuation mark for hyphenation if the character at the left of the range specifying hyphen (-) is not smaller than the right-hand character in ASCII code value.</p>
c	<p>Inputs a character string consisting of the number of characters specified by the field width. (If the field width specification is omitted, 1 is assumed.)</p> <p>The corresponding argument must be a pointer to the first character of an array that has sufficient size to accommodate this character string.</p> <p>The null terminator will not be added.</p>
p	<p>Reads an unsigned hexadecimal integer.</p> <p>The corresponding argument must be a pointer to void pointer.</p>
n	<p>Receives no input from the string s.</p> <p>The corresponding argument must be a pointer to an integer. The number of characters that are read thus far by this function from the string "s" is stored in the object that is pointed to by this pointer.</p> <p>The %n format command is not included in the return value assignment count.</p>
%	<p>Reads a % sign.</p> <p>Neither conversion nor assignment takes place.</p>

If a format specification is invalid, the format command execution fails.

If a null terminator appears in the input stream, sscanf will terminate.

If an overflow occurs in an integer conversion (with the d, i, o, u, x, or p format specifier), high-order bits will be truncated depending on the number of bits of the data type after the conversion.

The syntax of *format* commands is illustrated below.

Figure 6-3. Syntax of *format* Commands

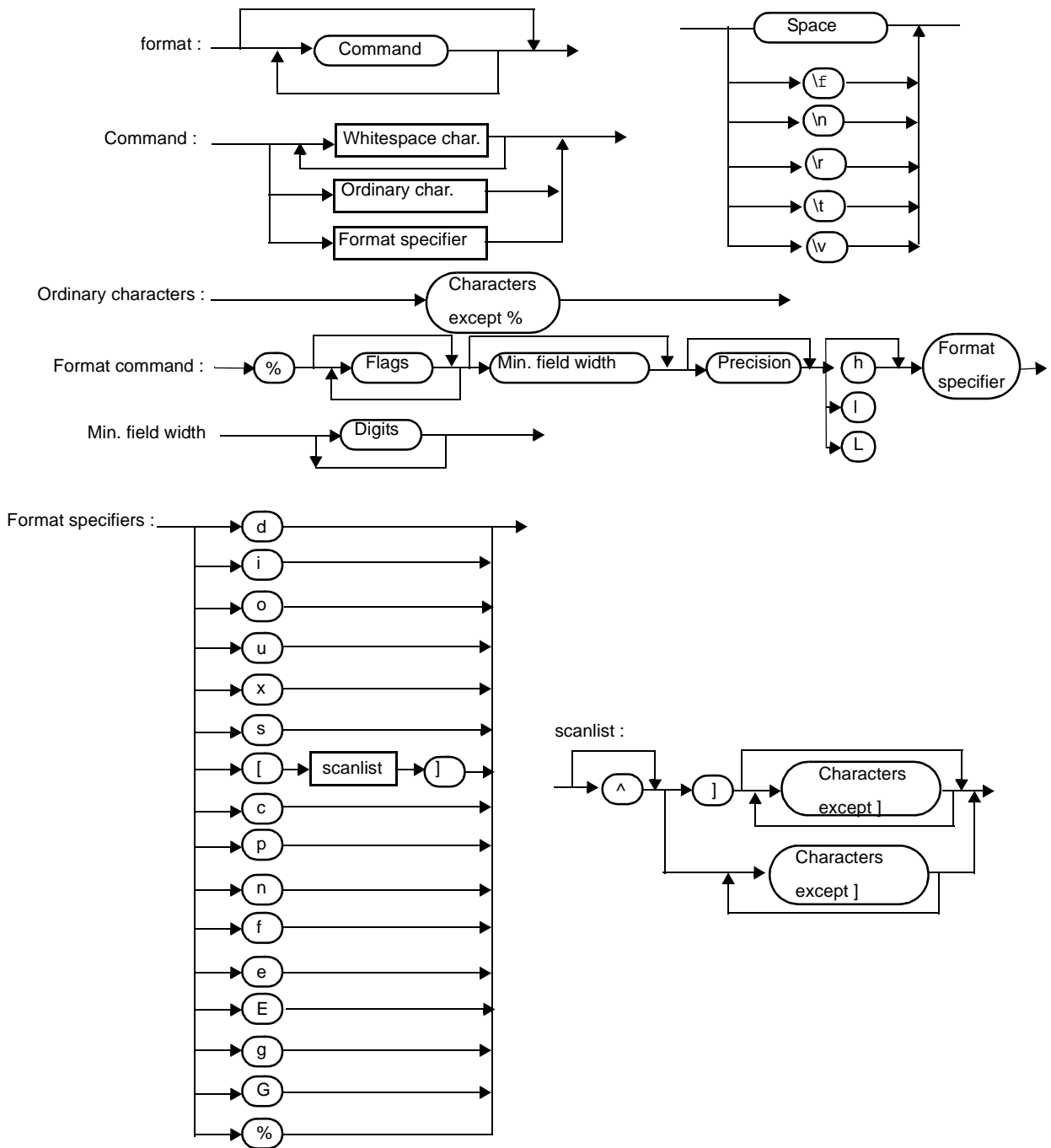

**printf (normal model only)**

Outputs data to SFR according to a format

**[Syntax]**

```
#include <stdio.h>
int printf (const char *format , ...);
```

**[Argument(s)/Return value]**

Argument	Return Value
<i>format</i> : Pointer to the character string that indicates the output  ... : 0 or more arguments to be converted	Number of character output to s (the null character at the end is not counted)

**[Description]**

- (0 or more) arguments following the *format* are converted and output using the putchar function, according to the output conversion specification specified in the *format*.
- The output conversion specification is 0 or more directives. Normal characters (other than the conversion specification starting with %) are output as is using the putchar function. The conversion specification is output using the putchar function by fetching and converting the following (0 or more) arguments.
- Each conversion specification is the same as that of the sprintf function.

**scanf (normal model only)**

Reads data from SFR according to a format

**[Syntax]**

```
#include <stdio.h>
int scanf (const char *format , ...);
```

**[Argument(s)/Return value]**

Argument	Return Value
<i>format</i> : Pointer to the character string to indicate input conversion specification  ... : Pointer (0 or more) argument to the object to assign the converted value	When the character string <i>s</i> is not null : Number of input items assigned

**[Description]**

- Performs input using getchar function. Specifies input string permitted by the character string *format* indicates. Uses the argument after the *format* as the pointer to an object. *format* specifies how the conversion is performed by the input string.
- When there are not enough arguments for the *format*, normal operation is not guaranteed. When the argument is excessive, the expression will be evaluated but not input.
- *format* consists of 0 or more directives. The directives are as follows.
  - 1 : One or more null character (character that makes isspace true)
  - 2 : Normal character (other than %)
  - 3 : Conversion indication
- If a conversion ends with a input character which conflicts with the input character, the conflicting input character is rounded down. The conversion indication is the same as that of the sscanf function.

**vprintf (normal model only)**

Outputs data to SFR according to a format

**[Syntax]**

```
#include <stdio.h>
int vprintf (const char *format , va_list p) ;
```

**[Argument(s)/Return value]**

Argument	Return Value
<i>format</i> : Pointer to the character string that indicates output conversion specification	Number of output characters (the null character at the end is not counted)
<i>p</i> : Pointer to the argument list	

**[Description]**

- The argument that the pointer of the argument list indicates is converted and output using putchar function according to the output conversion specification specified by the *format*.
- Each conversion specification is the same as that of sprintf function.



**vsprintf (normal model only)**

Writes data to a string according to a format

**[Syntax]**

```
#include <stdio.h>
int vsprintf (char *s , const char *format , va_list p) ;
```

**[Argument(s)/Return value]**

Argument	Return Value
<p><i>s</i> :</p> <p>Pointer to the character string that writes the output</p> <p><i>format</i> :</p> <p>Pointer to the character string that indicates output conversion specification</p> <p><i>p</i> :</p> <p>Pointer to the argument list</p>	<p>Number of characters output to <i>s</i> (the null character at the end is not counted)</p>

**[Description]**

- Writes out the argument that the pointer of argument list indicates to the character strings which *s* indicates according to the output conversion specification specified by *format*.
- The output specification is the same as that of *sprintf* function.

**getchar**

Reads one character from SFR

**[Syntax]**

```
#include <stdio.h>
int getchar (void) ;
```

**[Argument(s)/Return value]**

Argument	Return Value
None	A character read from SFR

**[Description]**

- Returns the value read from SFR symbol P0 (port 0).
- Error check related to reading is not performed.
- To change SFR to read, it is necessary either that the source be changed to be re-registered to the library or that the user create a new getchar function.

**gets**

Reads a string

**[Syntax]**

```
#include <stdio.h>
char *gets (char *s) ;
```

**[Argument(s)/Return value]**

Argument	Return Value
<p>s :</p> <p>Pointer to input character string</p>	<p>Normal :</p> <p>s</p> <p>If the end of the file is detected without reading a character :</p> <p>Null pointer</p>

**[Description]**

- Reads a character string using the getchar function and stores in the array that s indicates.
- When the end of the file is detected (getchar function returns -1) or when a line feed character is read, the reading of a character string ends. The line feed character read is abandoned, and a null character is written at the end of the character stored in the array in the end.
- When the return value is normal, it returns s.
- When the end of the file is detected and no character is read in the array, the contents of the array remains unchanged, and a null pointer is returned.

**putchar**

Outputs one character to SFR

**[Syntax]**

```
#include <stdio.h>
int putchar (int c);
```

**[Argument(s)/Return value]**

Argument	Return Value
<p><i>c</i> :</p> <p>Character to be output</p>	<p>Character to have been output</p>

**[Description]**

- Writes the character specified by *c* to the SFR symbol P0 (port 0) (converted to unsigned char type).
- Error check related to writing is not performed.
- To change SFR to write, it is necessary either that the source is changed and re-registered to the library or the user create a new putchar function.

**puts**

Outputs a string

**[Syntax]**

```
#include <stdio.h>
int puts (const char *s) ;
```

**[Argument(s)/Return value]**

Argument	Return Value
<b>s :</b> Pointer to an output character string	Normal : 0 When putchar function returns -1 : -1

**[Description]**

- Writes the character string indicated by *s* using putchar function, a line feed character is added at the end of the output.
- Writing of the null character at the end of the character string is not performed.
- When the return value is normal, 0 is returned, and when putchar function returns -1, -1 is returned.

## 6.9 Utility Functions

The following utility functions are available.

Function Name	Purpose
<a href="#">atoi</a>	Converts a decimal integer string to int
<a href="#">atol</a>	Converts a decimal integer string to long
<a href="#">strtol</a>	Converts a string to long
<a href="#">strtoul</a>	Converts a string to unsigned long
<a href="#">calloc</a>	Allocates an array's region and initializes it to zero
<a href="#">free</a>	Releases a block of allocated memory
<a href="#">malloc</a>	Allocates a block
<a href="#">realloc</a>	Re-allocates a block
<a href="#">abort</a>	Abnormally terminates the program
<a href="#">atexit</a>	Registers a function to be called at normal termination
<a href="#">exit</a>	Terminates the program
<a href="#">abs</a>	Obtains the absolute value of an int type value
<a href="#">labs</a>	Obtains the absolute value of a long type value
<a href="#">div (normal model only)</a>	Performs int type division, obtains the quotient and remainder
<a href="#">ldiv (normal model only)</a>	Performs long type division, obtains the quotient and remainder
<a href="#">brk</a>	Sets the break value
<a href="#">sbrk</a>	Increases/decreases the break value
<a href="#">atof</a>	Converts a decimal integer string to double
<a href="#">strtod (normal model only)</a>	Converts a string to double
<a href="#">itoa</a>	Converts int to a string
<a href="#">ltoa (normal model only)</a>	Converts long to a string
<a href="#">ultoa (normal model only)</a>	Converts unsigned long to a string
<a href="#">rand</a>	Generates a pseudo-random number
<a href="#">srand</a>	Initializes the pseudo-random number generator state
<a href="#">bsearch (normal model only)</a>	Binary search
<a href="#">qsort (normal model only)</a>	Quick sort
<a href="#">strbrk</a>	Sets the break value
<a href="#">strsbrk</a>	Increases/decreases the break value
<a href="#">strtoa</a>	Converts int to a string
<a href="#">strltoa (normal model only)</a>	Converts long to a string
<a href="#">strultoa (normal model only)</a>	Converts unsigned long to a string

**atoi**

Converts a decimal integer string to int

**[Syntax]**

```
#include <stdlib.h>
int atoi (const char *nptr) ;
```

**[Argument(s)/Return value]**

Argument	Return Value
<p><i>nptr</i> :</p> <p>String to be converted</p>	<p>If converted properly :</p> <p>int value</p> <p>If positive overflow occurs :</p> <p>INT_MAX (32,767)</p> <p>If negative overflow occurs :</p> <p>INT_MIN (-32,768)</p> <p>If the string is invalid :</p> <p>0</p>

**[Description]**

- The atoi function converts the first part of the string pointed to by pointer *nptr* to an int value. The atoi function skips over zero or more white-space characters (for which isspace becomes true) from the beginning of the string and converts the string from the character next to the skipped white-spaces to an integer (until other than digits or a null character appears in the string). If no digits to convert is found in the string, the function returns 0.
- If an overflow occurs, the function returns INT\_MAX (32,767) for positive overflow and INT\_MIN (-32,768) for negative overflow.

**atol**

Converts a decimal integer string to long

**[Syntax]**

```
#include <stdlib.h>
long int atol (const char *nptr) ;
```

**[Argument(s)/Return value]**

Argument	Return Value
<p><i>nptr</i> :</p> <p>String to be converted</p>	<p>If converted properly :</p> <p>long int value</p> <p>If positive overflow occurs :</p> <p>LONG_MAX (2,147,483,647)</p> <p>If negative overflow occurs :</p> <p>LONG_MIN (-2,147,483,648)</p> <p>If the string is invalid :</p> <p>0</p>

**[Description]**

- The atol function converts the first part of the string pointed to by pointer *nptr* to a long int value. The atol function skips over zero or more white-space characters (for which isspace becomes true) from the beginning of the string and converts the string from the character next to the skipped white-spaces to an integer (until other than digits or null character appears in the string). If no digits to convert is found in the string, the function returns 0.
- If an overflow occurs, the function returns LONG\_MAX (2,147,483,647) for positive overflow and LONG\_MIN (-2,147,483,648) for negative overflow.



**strtol**

Converts a string to long

**[Syntax]**

```
#include <stdlib.h>
long int strtol (const char *nptr , char **endptr , int base) ;
```

**[Argument(s)/Return value]**

Argument	Return Value
<i>nptr</i> : String to be converted	If converted properly : long int value
<i>endptr</i> : Pointer storing pointer pointing to unrecognizable block	If positive overflow occurs : LONG_MAX (2,147,483,647)
<i>base</i> : Base for number represented in the string	If negative overflow occurs : LONG_MIN (-2,147,483,648)
	If not converted : 0

**[Description]**

- The strtol function decomposes the string pointed by pointer *nptr* into the following 3 parts:

- (1) **String of whitespace characters that may be empty (to be specified by isspace)**
- (2) **Integer representation by the *base* determined by the value of *base***
- (3) **String of one or more characters that cannot be recognized (including null terminators)**

**Remark** The strtol function converts the part (2) of the string into an integer and returns this integer value.

- A *base* of 0 indicates that the *base* should be determined from the leading digits of the string. A leading 0x or 0X indicates a hexadecimal number; a leading 0 indicates an octal number; otherwise, the number is interpreted as decimal. (In this case, the number may be signed).
- If the *base* is 2 to 36, the set of letters from a to z or A to Z which can be part of a number (and which may be signed) with any of these bases are taken to represent 10 to 35.  
A leading 0x or 0X is ignored if the *base* is 16.
- If *endptr* is not a null pointer, a pointer to the part (3) of the string is stored in the object pointed to by *endptr*.
- If the correct value causes an overflow, the function returns LONG\_MAX (2,147,483,647) for the positive overflow or LONG\_MIN (-2,147,483,648) for the negative overflow depending on the sign and sets errno to ERANGE (2).
- If the string (2) is empty or the first non-white-space character of the string (ii) is not appropriate for an integer with the given *base*, the function performs no conversion and returns 0. In this case, the value of the string *nptr* is stored in the object pointed to by *endptr* (if it is not a null string). This holds true with the bases 0 and 2 to 36.

**strtoul**

Converts a string to unsigned long

**[Syntax]**

```
#include <stdlib.h>
unsigned long int strtoul (const char *nptr , char **endptr , int base) ;
```

**[Argument(s)/Return value]**

Argument	Return Value
<i>nptr</i> : String to be converted	If converted properly : unsigned long
<i>endptr</i> : Pointer storing pointer pointing to unrecognizable block	If overflow occurs : ULONG_MAX (4,294,967,295U)
<i>base</i> : Base for number represented in the string	If not converted : 0

**[Description]**

- The strtoul function decomposes the string pointed by pointer *nptr* into the following 3 parts:

- (1) **String of white-space characters that may be empty (to be specified by isspace)**
- (2) **Integer representation by the *base* determined by the value of *base***
- (3) **String of one or more characters that cannot be recognized (including null terminators)**

**Remark** The strtoul function converts the part (2) of the string into a unsigned integer and returns this unsigned integer value.

- A *base* of 0 indicates that the *base* should be determined from the leading digits of the string. A leading 0x or 0X indicates a hexadecimal number; a leading 0 indicates an octal number; otherwise, the number is interpreted as decimal.
- If the *base* is 2 to 36, the set of letters from a to z or A to Z which can be part of a number (and which may be signed) with any of these bases are taken to represent 10 to 35. A leading 0x or 0X is ignored if the *base* is 16.
- If *endptr* is not a null pointer, a pointer to the part (3) of the string is stored in the object pointed to by *endptr*.
- If the correct value causes an overflow, the function returns ULONG\_MAX (4,294,967,295U) and sets errno to ERANGE (2).
- If the string (2) is empty or the first non-white-space character of the string (2) is not appropriate for an integer with the given *base*, the function performs no conversion and returns 0. In this case, the value of the string *nptr* is stored in the object pointed to by *endptr* (if it is not a null string). This holds true with the bases 0 and 2 to 36.

**calloc**

Allocates an array's region and initializes it to zero

**[Syntax]**

```
#include <stdlib.h>
void * calloc (size_t nmemb , size_t size );
```

**[Argument(s)/Return value]**

Argument	Return Value
<i>nmemb</i> : Number of members in the array	If the requested size is allocated : Pointer to the beginning of the allocated area
<i>size</i> : Size of each member	If the requested size is not allocated : Null pointer

**[Description]**

- The calloc function allocates an area for an array consisting of n number of members (specified by *nmemb*), each of which has the number of bytes specified by *size* and initializes the area (array members) to zero.
- Returns the pointer to the beginning of the allocated area if the requested *size* is allocated.
- Returns the null pointer if the requested *size* is not allocated.
- The memory allocation will start from a break value and the address next to the allocated space will become a new break value. See "brk" for break value setting with the memory function brk.

**free**

Releases a block of allocated memory

**[Syntax]**

```
#include <stdlib.h>
void free (void *ptr) ;
```

**[Argument(s)/Return value]**

Argument	Return Value
<i>ptr</i> : Pointer to the beginning of block to be released	None

**[Description]**

- The free function releases the allocated space (before a break value) pointed to by *ptr*. (The malloc, calloc, or realloc called after the free will give you the space that was freed earlier.)
- If *ptr* does not point to the allocated space, the free will take no action. (Freeing the allocated space is performed by setting *ptr* as a new break value.)

**malloc**

Allocates a block

**[Syntax]**

```
#include <stdlib.h>
void *malloc (size_t size) ;
```

**[Argument(s)/Return value]**

Argument	Return Value
<i>size</i> : Size of memory block to be allocated	If the requested size is allocated : Pointer to the beginning of the allocated area  If the requested size is not allocated : Null pointer

**[Description]**

- The malloc function allocates a block of memory for the number of bytes specified by *size* and returns a pointer to the first byte of the allocated area.
- If memory cannot be allocated, the function returns a null pointer.
- This memory allocation will start from a break value and the address next to the allocated area will become a new break value. See "[brk](#)" for break value setting with the memory function brk.

**realloc**

Re-allocates a block

**[Syntax]**

```
#include <stdlib.h>
void * realloc (void *ptr , size_t size) ;
```

**[Argument(s)/Return value]**

Argument	Return Value
<p><i>ptr</i> :</p> <p>Pointer to the beginning of block previously allocated</p> <p><i>size</i> :</p> <p>New size to be given to this block</p>	<p>If the requested size is reallocated :</p> <p>Pointer to the beginning of the reallocated space</p> <p>If <i>ptr</i> is a null pointer :</p> <p>Pointer to the beginning of the allocated space</p> <p>If the requested <i>size</i> is not reallocated or "<i>ptr</i>" is not a null pointer :</p> <p>Null pointer</p>

**[Description]**

- The realloc function changes the size of the allocated space (before a break value) pointed to by *ptr* to that specified by *size*. If the value of *size* is greater than the size of the allocated space, the contents of the allocated space up to the original size will remain unchanged. The realloc function allocates only for the increased space. If the value of *size* is less than the size of the allocated space, the function will free the reduced space of the allocated space.
- If *ptr* is a null pointer, the realloc function will newly allocate a block of memory of the specified *size* (same as malloc).
- If *ptr* does not point to the block of memory previously allocated or if no memory can be allocated, the function executes nothing and returns a null pointer.
- Reallocation will be performed by setting the address of *ptr* plus the number of bytes specified by *size* as a new break value.

**abort**

Abnormally terminates the program

**[Syntax]**

```
#include <stdlib.h>
void abort (void) ;
```

**[Argument(s)/Return value]**

Argument	Return Value
None	No return to its caller.

**[Description]**

- The abort function loops and can never return to its caller.
- The user must create the abort processing routine.

**atexit**

Registers a function to be called at normal termination

**[Syntax]**

```
#include <stdlib.h>
int atexit (void (*func) (void) );
```

**[Argument(s)/Return value]**

Argument	Return Value
<i>func</i> : Pointer to function to be registered	If function is registered as wrap-up function : 0 If function cannot be registered : 1

**[Description]**

- The atexit function registers the wrap-up function pointed to by *func* so that it is called without argument upon normal program termination by calling exit or returning from main.
- Up to 32 wrap-up functions may be established. If the wrap-up function can be registered, atexit returns 0. If no more wrap-up function can be registered because 32 wrap-up functions have already been registered, the function returns 1.



**exit**

Terminates the program

**[Syntax]**

```
#include <stdlib.h>
void exit (int status );
```

**[Argument(s)/Return value]**

Argument	Return Value
<i>status</i> : Status value indicating termination	exit can never return.

**[Description]**

- The exit function causes immediate, normal termination of a program.
- This function calls the wrap-up functions in the reverse of the order in which they were registered with atexit.
- The exit function loops and can never return to its caller.
- The user must create the exit processing routine.

**abs**

Obtains the absolute value of an int type value

**[Syntax]**

```
#include <stdlib.h>
int abs (int j) ;
```

**[Argument(s)/Return value]**

Argument	Return Value
<i>j</i> : Any signed integer for which absolute value is to be obtained	If <i>j</i> falls within $-32,767 \leq j \leq 32,767$ : Absolute value of <i>j</i> If <i>j</i> is $-32,768$ : $-32,768$ (0x8000)

**[Description]**

- The abs returns the absolute value of its int type argument.
- If *j* is  $-32,768$ , the function returns  $-32,768$ .

**labs**

Obtains the absolute value of a long type value

**[Syntax]**

```
#include <stdlib.h>
long int labs (long int j) ;
```

**[Argument(s)/Return value]**

Argument	Return Value
<i>j</i> : Any signed integer for which absolute value is to be obtained	If <i>j</i> falls within $-2,147,483,647 \leq j \leq 2,147,483,647$ : Absolute value of <i>j</i> If the value of <i>j</i> is $-2,147,483,648$ : -2147483,648 (0x80000000)

**[Description]**

- The labs returns the absolute value of its long type argument.
- If the value of *j* is  $-2,147,483,648$ , the function returns  $-2,147,483,648$ .

**div (normal model only)**

Performs int type division, obtains the quotient and remainder

**[Syntax]**

```
#include <stdlib.h>
div_t div (int numer , int denom) ;
```

**[Argument(s)/Return value]**

Argument	Return Value
<i>numer</i> : Numerator of the division  <i>denom</i> : Denominator of the division	Quotient to the quot element and the remainder to the rem element of div_t type member

**[Description]**

- The div function performs the integer division of numerator divided by denominator.
- The absolute value of quotient is defined as the largest integer not greater than the absolute value of *numer* divided by the absolute value of *denom*. The remainder always has the same sign as the result of the division (plus if *numer* and *denom* have the same sign; otherwise minus).
- The remainder is the value of  $numer - denom * quotient$ .
- If *denom* is 0, the quotient becomes 0 and the remainder becomes *numer*.
- If *numer* is -32,768 and *denom* is -1, the quotient becomes -32,768 and the remainder becomes 0.

**ldiv (normal model only)**

Performs long type division, obtains the quotient and remainder

**[Syntax]**

```
#include <stdlib.h>
ldiv_t ldiv (long int numer , long int denom) ;
```

**[Argument(s)/Return value]**

Argument	Return Value
<i>numer</i> : Numerator of the division  <i>denom</i> : Denominator of the division	Quotient to the quot element and the remainder to the rem element of ldiv_t type member

**[Description]**

- The ldiv function performs the long integer division of numerator divided by denominator.
- The absolute value of quotient is defined as the largest long int type integer not greater than the absolute value of *numer* divided by the absolute value of *denom*. The remainder always has the same sign as the result of the division (plus if *numer* and *denom* have the same sign; otherwise minus).
- The remainder is the value of  $numer - denom * quotient$ .
- If *denom* is 0, the quotient becomes 0 and the remainder becomes *numer*.
- If *numer* is -2,147,483,648 and *denom* is -1, the quotient becomes -2,147,483,648 and the remainder becomes 0.

**brk**

Sets the break value

**[Syntax]**

```
#include <stdlib.h>
int brk (char *endds);
```

**[Argument(s)/Return value]**

Argument	Return Value
<i>endds</i> : Break value to be set block to be released	If converted properly : 0  If break value cannot be changed : -1

**[Description]**

- The brk function sets the value given by *endds* as a break value (the address next to the end address of an allocated block of memory).
- If *endds* is outside the permissible address range, the function sets no break value and sets *errno* to ENOMEM (3).

**sbrk**

Increases/decreases the break value

**[Syntax]**

```
#include <stdlib.h>
char *sbrk (int incr );
```

**[Argument(s)/Return value]**

Argument	Return Value
<i>incr</i> : Value (bytes) by which set break value is to be incremented/decremented.	If converted properly : Old break value If old break value cannot be incremented or decremented : -1

**[Description]**

- The sbrk function increments or decrements the set break value by the number of bytes specified by *incr*. (Increment or decrement is determined by the plus or minus sign of *incr*.)
- If the incremented or decremented break value is outside the permissible address range, the function does not change the original break value and sets errno to ENOMEM (3).

**atof**

Converts a decimal integer string to double

**[Syntax]**

```
#include <stdlib.h>
double atof (const char *nptr) ;
```

**[Argument(s)/Return value]**

Argument	Return Value
<p><i>nptr</i> :</p> <p>String to be converted</p>	<p>If converted properly :</p> <p>Converted value</p> <p>If positive overflow occurs :</p> <p>HUGE_VAL (with sign of overflowed value)</p> <p>If negative overflow occurs :</p> <p>0</p> <p>If the string is invalid :</p> <p>0</p>

**[Description]**

- The atof function converts the string pointed to by pointer *nptr* to a double value.  
 The atof function skips over zero or more whitespace characters (for which isspace becomes true) from the beginning of the string and converts the string from the character next to the skipped whitespaces to a floating point number (until other than digits or a null character appears in the string).
- A floating point number is returned when converted properly.
- If an overflow occurs on conversion, HUGE\_VAL with the sign of the overflowed value is returned and ERANGE is set to errno.
- If valid digits are deleted due to an underflow or an overflow, a non-normalized number and +0 are returned respectively, and ERANGE is set to errno.
- If conversion cannot be performed, 0 is returned.



**strtod (normal model only)**

Converts a string to double

**[Syntax]**

```
#include <stdlib.h>
double strtod (const char *nptr , char **endptr) ;
```

**[Argument(s)/Return value]**

Argument	Return Value
<i>nptr</i> : String to be converted	If converted properly : Converted value
<i>endptr</i> : Pointer storing pointer pointing to unrecognizable block	If positive overflow occurs : HUGE_VAL (with sign of overflowed value)
	If negative overflow occurs : 0
	If the string is invalid : 0

**[Description]**

- The strtod function converts the string pointed to by pointer *nptr* to a double value.  
 The strtod function skips over zero or more white-space characters (for which isspace becomes true) from the beginning of the string and converts the string from the character next to the skipped white-spaces to a floating-point number (until other than digits or null character appears in the string).
- A floating-point number is returned when converted properly.
- If an overflow occurs on conversion, HUGE\_VAL with the sign of the overflowed value is returned and ERANGE is set to errno.
- If valid digits are deleted due to an underflow or an overflow, a non-normalized number and +0 are returned respectively, and ERANGE is set to errno. In addition, *endptr* stores a pointer for next character string at that time.
- If conversion cannot be performed, 0 is returned.

**itoa**

Converts int to a string

**[Syntax]**

```
#include <stdlib.h>
char *itoa (int value , char *string , int radix) ;
```

**[Argument(s)/Return value]**

Argument	Return Value
<i>value</i> : String to which integer is to be converted	If converted properly : Pointer to the converted string  If not converted properly : Null pointer
<i>string</i> : Pointer to the conversion result	
<i>radix</i> : Base of output string	

**[Description]**

- The itoa, ltoa, and ultoa functions all convert the integer value specified by *value* to its string equivalent which is terminated with a null character and store the result in the area pointed to by "*string*".
- The *base* of the output string is determined by *radix*, which must be in the range 2 through 36. Each function performs conversion based on the specified *radix* and returns a pointer to the converted string. If the specified *radix* is outside the range 2 through 36, the function performs no conversion and returns a null pointer.

**ltoa (normal model only)**

Converts long to a string

**[Syntax]**

```
#include <stdlib.h>
char *ltoa (long value , char *string , int radix) ;
```

**[Argument(s)/Return value]**

Argument	Return Value
<i>value</i> : String to which integer is to be converted	If converted properly : Pointer to the converted string  If not converted properly : Null pointer
<i>string</i> : Pointer to the conversion result	
<i>radix</i> : Base of output string	

**[Description]**

- The itoa, ltoa, and ultoa functions all convert the integer value specified by *value* to its string equivalent which is terminated with a null character and store the result in the area pointed to by "*string*".
- The *base* of the output string is determined by *radix*, which must be in the range 2 through 36. Each function performs conversion based on the specified *radix* and returns a pointer to the converted string. If the specified *radix* is outside the range 2 through 36, the function performs no conversion and returns a null pointer.

**ultoa (normal model only)**

Converts unsigned long to a string

**[Syntax]**

```
#include <stdlib.h>
char *ultoa (unsigned long value , char *string , int radix ) ;
```

**[Argument(s)/Return value]**

Argument	Return Value
<i>value</i> : String to which integer is to be converted	If converted properly : Pointer to the converted string  If not converted properly : Null pointer
<i>string</i> : Pointer to the conversion result	
<i>radix</i> : Base of output string	

**[Description]**

- The itoa, ltoa, and ultoa functions all convert the integer value specified by *value* to its string equivalent which is terminated with a null character and store the result in the area pointed to by "*string*".
- The *base* of the output string is determined by *radix*, which must be in the range 2 through 36. Each function performs conversion based on the specified *radix* and returns a pointer to the converted string. If the specified *radix* is outside the range 2 through 36, the function performs no conversion and returns a null pointer.

**rand**

Generates a pseudo-random number

**[Syntax]**

```
#include <stdlib.h>  
int rand (void) ;
```

**[Argument(s)/Return value]**

Argument	Return Value
None	Pseudorandom integer in the range of 0 to RAND_MAX

**[Description]**

- Each time the rand function is called, it returns a pseudorandom integer in the range of 0 to RAND\_MAX.

**srand**

Initializes the pseudo-random number generator state

**[Syntax]**

```
#include <stdlib.h>
void srand (unsigned int seed );
```

**[Argument(s)/Return value]**

Argument	Return Value
<i>seed</i> : Starting value for pseudorandom number generator	None

**[Description]**

- The *srand* function sets a starting value for a sequence of random numbers. *seed* is used to set a starting point for a progression of random numbers that is a return value when *rand* is called. If the same *seed* value is used, the sequence of pseudorandom numbers is the same when *srand* is called again.
- Calling *rand* before *srand* is used to set a *seed* is the same as calling *rand* after *srand* has been called with *seed* = 1. (The default *seed* is 1.)

**bsearch (normal model only)**

Binary search

**[Syntax]**

```
#include <stdlib.h>
void *bsearch (const void *key , const void *base , size_t nmemb , size_t size ,
              int (*compare) (const void *, const void *) ) ;
```

**[Argument(s)/Return value]**

Argument	Return Value
<p><i>key</i> :</p> <p>Pointer to key for which search is made</p> <p><i>base</i> :</p> <p>Pointer to sorted array which contains information to search</p> <p><i>nmemb</i> :</p> <p>Number of array elements</p> <p><i>size</i> :</p> <p>Size of an array</p> <p><i>compare</i> :</p> <p>Pointer to function used to compare 2 keys</p>	<p>If the array contains the key :</p> <p>Pointer to the first member that matches "<i>key</i>"</p> <p>If the key is not contained in the array :</p> <p>Null pointer</p>

**[Description]**

- The bsearch function performs a binary search on the sorted array pointed to by *base* and returns a pointer to the first member that matches the key pointed to by *key*. The array pointed to by *base* must be an array which consists of *nmemb* number of members each of which has the size specified by *size* and must have been sorted in ascending order.
- The function pointed to by *compare* takes 2 arguments (*key* as the 1st argument and array element as the 2nd argument), compares the 2 arguments, and returns:
  - Negative value if the 1st argument is less than the 2nd argument
  - 0 if both arguments are equal
  - Positive integer if the 1st argument is greater than the 2nd argument
- When the -zr option is specified, the function passed as an argument to the bsearch function must be a pascal function.

**qsort (normal model only)**

Quick sort

**[Syntax]**

```
#include <stdlib.h>
void qsort (void *base , size_t nmemb , size_t size , int (*compare) (const void * , const void * ) );
```

**[Argument(s)/Return value]**

Argument	Return Value
<i>base</i> : Pointer to array to be sorted <i>nmemb</i> : Number of members in the array <i>size</i> : Size of an array member <i>compare</i> : Pointer to function used to compare 2 keys	None

**[Description]**

- The qsort function sorts the members of the array pointed to by *base* in ascending order.  
 The array pointed to by *base* consists of *nmemb* number of members each of that has the size specified by *size*.
- The function pointed to by *compare* takes 2 arguments (array elements 1 and 2), compares the 2 arguments, and returns:
  - The array element 1 as the 1st argument and array element 2 as the 2nd argument
    - Negative value if the 1st argument is less than the 2nd argument
    - 0 if both arguments are equal
    - Positive integer if the 1st argument is greater than the 2nd argument
- If the 2 array elements are equal, the element nearest to the top of the array will be sorted first.
- When the -zr option is specified, the function passed as an argument to the qsort function must be a pascal function.



**strbrk**

Sets the break value

**[Syntax]**

```
#include <stdlib.h>
int strbrk (char *ends) ;
```

**[Argument(s)/Return value]**

Argument	Return Value
<i>ends</i> : Break value to set	Normal : 0 When a break value cannot be changed : -1

**[Description]**

- Sets the value given by *ends* to the break value (the address following the address at the end of the area to be allocated).
- When *ends* is out of the permissible range, the break value is not changed. ENOMEM(3) is set to *errno* and -1 is returned.

**strsbrk**

Increases/decreases the break value

**[Syntax]**

```
#include <stdlib.h>
char *strsbrk (int incr ;
```

**[Argument(s)/Return value]**

Argument	Return Value
<i>incr</i> : Amount to increase/decrease a break value	Normal : Old break value When a break value cannot be increased/decreased : -1

**[Description]**

- *incr* byte increases/decreases a break value (depending on the sign of *incr*).
- When the break value is out of the permissible range after increasing/decreasing, a break value is not changed. ENOMEM(3) is set to *errno*, and -1 is returned.

**stritoa**

Converts int to a string

**[Syntax]**

```
#include <stdlib.h>
char *stritoa (int value , char *string , int radix ) ;
```

**[Argument(s)/Return value]**

Argument	Return Value
<i>value</i> : String to be converted  <i>string</i> : Pointer to the conversion result  <i>radix</i> : Radix to specify	Normal : Pointer to the converted character string  Others : Null pointer

**[Description]**

- Converts the specified numeric value *value* to the character string that ends with a null character, and the result will be stored to the area specified with *string*. The conversion is performed by the *radix* specified, and the pointer to the converted character string will be returned.
- *radix* must be the value range between 2 to 36. In other cases, the conversion is not performed and a null pointer is returned.

**strltoa (normal model only)**

Converts long to a string

**[Syntax]**

```
#include <stdlib.h>
char *strltoa (long value , char *string , int radix) ;
```

**[Argument(s)/Return value]**

Argument	Return Value
<p><i>value</i> :</p> <p style="padding-left: 20px;">String to be converted</p> <p><i>string</i> :</p> <p style="padding-left: 20px;">Pointer to the conversion result</p> <p><i>radix</i> :</p> <p style="padding-left: 20px;">Radix to specify</p>	<p>Normal :</p> <p style="padding-left: 20px;">Pointer to the converted character string</p> <p>Others :</p> <p style="padding-left: 20px;">Null pointer</p>

**[Description]**

- Converts the specified numeric value *value* to the character string that ends with a null character, and the result will be stored to the area specified with *string*. The conversion is performed by the *radix* specified, and the pointer to the converted character string will be returned.
- *radix* must be the value range between 2 to 36. In other cases, the conversion is not performed and a null pointer is returned.

**strultoa (normal model only)**

Converts unsigned long to a string

**[Syntax]**

```
#include <stdlib.h>
char *strultoa (unsigned long value , char *string , int radix ) ;
```

**[Argument(s)/Return value]**

Argument	Return Value
<i>value</i> : String to be converted  <i>string</i> : Pointer to the conversion result  <i>radix</i> : Radix to specify	Normal : Pointer to the converted character string  Others : Null pointer

**[Description]**

- Converts the specified numeric value *value* to the character string that ends with a null character, and the result will be stored to the area specified with *string*. The conversion is performed by the *radix* specified, and the pointer to the converted character string will be returned.
- *radix* must be the value range between 2 to 36. In other cases, the conversion is not performed and a null pointer is returned.

### 6.10 String and Memory Functions

The following character string and memory functions are available.

Function Name	Purpose
<a href="#">memcpy</a>	Copies a buffer for the specified number of characters
<a href="#">memmove</a>	Copies a buffer for the specified number of characters
<a href="#">strcpy</a>	Copies a string
<a href="#">strncpy</a>	Copies the specified number of characters from the start of a string
<a href="#">strcat</a>	Appends a string to a string
<a href="#">strncat</a>	Appends the specified number of characters of a string to a string
<a href="#">memcmp</a>	Compares the specified number of characters of two buffers
<a href="#">strcmp</a>	Compares two strings
<a href="#">strncmp</a>	Compares the specified number of characters of two strings
<a href="#">memchr</a>	Searches for the specified string in the specified number of characters of a buffer
<a href="#">strchr</a>	Searches for the specified character from within a string and returns the location of the first occurrence
<a href="#">strrchr</a>	Searches for the specified character from within a string and returns the location of the last occurrence
<a href="#">strspn</a>	Obtains the length from the start of a segment composed of only the characters included in the specified string within the string being searched
<a href="#">strcspn</a>	Obtains the length from the start of a segment composed of characters other than those included in the specified string within the string being searched
<a href="#">strpbrk</a>	Obtains the position of the first occurrence of any character in the specified string within the string being searched
<a href="#">strstr</a>	Obtains the position of the first occurrence of the specified string within the string being searched
<a href="#">strtok</a>	Decomposing character string into a string consisting of characters other than delimiters.
<a href="#">memset</a>	Initializes the specified number of characters of a buffer with the specified character
<a href="#">strerror</a>	Returns a pointer to the area that stores the error message string which corresponds to the specified error number
<a href="#">strlen</a>	Obtains the length of a string
<a href="#">strcoll</a>	Compares two strings based on region specific information
<a href="#">strxfrm</a>	Transforms a string based on region specific information

**memcpy**

Copies a buffer for the specified number of characters

**[Syntax]**

```
#include <string.h>
void *memcpy (void *s1, const void *s2 , size_t n) ;
```

**[Argument(s)/Return value]**

Argument	Return Value
<i>s1</i> : Pointer to object into which data is to be copied	Value of <i>s1</i>
<i>s2</i> : Pointer to object containing data to be copied	
<i>n</i> : Number of characters to be copied	

**[Description]**

- The memcpy function copies *n* number of consecutive bytes from the object pointed to by *s2* to the object pointed to by *s1*.
- If  $s2 < s1 < s2 + n$  (*s1* and *s2* overlap), the memory copy operation by memcpy is not guaranteed (because copying starts in sequence from the beginning of the area).

**memmove**

Copies a buffer for the specified number of characters (Even if the buffer overlaps, the function performs memory copying properly)

**[Syntax]**

```
#include <string.h>
void *memmove (void *s1 , const void *s2 , size_t n) ;
```

**[Argument(s)/Return value]**

Argument	Return Value
<p><i>s1</i> : Pointer to object into which data is to be copied</p> <p><i>s2</i> : Pointer to object containing data to be copied</p> <p><i>n</i> : Number of characters to be copied</p>	<p>Value of <i>s1</i></p>

**[Description]**

- The memmove function also copies *n* number of consecutive bytes from the object pointed to by *s2* to the object pointed to by *s1*.
- Even if *s1* and *s2* overlap, the function performs memory copying properly.



**strcpy**

Copies a string

**[Syntax]**

```
#include <string.h>
char *strcpy (char *s1 , const char *s2) ;
```

**[Argument(s)/Return value]**

Argument	Return Value
<p><i>s1</i> :</p> <p>Pointer to copy destination array</p> <p><i>s2</i> :</p> <p>Pointer to copy source array</p>	<p>Value of <i>s1</i></p>

**[Description]**

- The strcpy function copies the contents of the character string pointed to by *s2* to the array pointed to by *s1* (including the terminating character).
- If  $s2 < s1 < (s2 + \text{Character length to be copied})$ , the behavior of strcpy is not guaranteed (as copying starts in sequence from the beginning, not from the specified string).

**strncpy**

Copies the specified number of characters from the start of a string

**[Syntax]**

```
#include <string.h>
char *strncpy (char *s1 , const char *s2 , size_t n) ;
```

**[Argument(s)/Return value]**

Argument	Return Value
<p><i>s1</i> : Pointer to copy destination array</p> <p><i>s2</i> : Pointer to copy source array</p> <p><i>n</i> : Number of characters to be copied</p>	<p>Value of <i>s1</i></p>

**[Description]**

- The strncpy function copies up to the characters specified by *n* from the string pointed to by *s2* to the array pointed to by *s1*.
- If  $s2 < s1 < (s2 + \text{Character length to be copied or minimum value of } s2 + n - 1)$ , the behavior of strncpy is not guaranteed (as copying starts in sequence from the beginning, not from the specified string).
- If the string pointed to by *s2* is shorter than *n* characters, then it is copied up to the terminating null character. If it is longer than *n* characters, then *n* characters are copied but the concluding null character is not copied.

**strcat**

Appends a string to a string

**[Syntax]**

```
#include <string.h>
char *strcat (char *s1 , const char *s2) ;
```

**[Argument(s)/Return value]**

Argument	Return Value
<p><i>s1</i> :</p> <p>Pointer to a string to which a copy of another string (<i>s2</i>) is to be concatenated</p> <p><i>s2</i> :</p> <p>Pointer to a string, copy of which is to be concatenated to another string (<i>s1</i>)</p>	<p>Value of <i>s1</i></p>

**[Description]**

- The strcat function concatenates a copy of the string pointed to by *s2* (including the null terminator) to the string pointed to by *s1*. The null terminator originally ending *s1* is overwritten by the first character of *s2*.
- When copying is performed between objects overlapping each other, the operation is not guaranteed.

**strncat**

Appends the specified number of characters of a string to a string

**[Syntax]**

```
#include <string.h>
char *strncat (char *s1 , const char *s2 , size_t n) ;
```

**[Argument(s)/Return value]**

Argument	Return Value
<p><i>s1</i> :</p> <p>Pointer to a string to which a copy of another string (<i>s2</i>) is to be concatenated</p> <p><i>s2</i> :</p> <p>Pointer to a string, copy of which is to be concatenated to another string (<i>s1</i>)</p> <p><i>n</i> :</p> <p>Number of characters to be concatenated</p>	<p>Value of <i>s1</i></p>

**[Description]**

- The strncat function concatenates not more than the characters specified by *n* of the string pointed to by *s2* (excluding the null terminator) to the string pointed to by *s1*. The null terminator originally ending *s1* is overwritten by the first character of *s2*.
- If the string pointed to by *s2* has fewer characters than specified by *n*, the strncat function concatenates the string including the null terminator. If there are more characters than specified by *n*, the *n* character section is concatenated starting from the top.
- The null terminator must always be concatenated.
- When copying is performed between objects overlapping each other, the operation is not guaranteed.

**memcmp**

Compares the specified number of characters of two buffers

**[Syntax]**

```
#include <string.h>
int memcmp (const void *s1 , const void *s2 , size_t n) ;
```

**[Argument(s)/Return value]**

Argument	Return Value
<i>s1</i> : Pointers to 2 data objects to be compared <i>s2</i> : Pointers to 2 data objects to be compared <i>n</i> : Number of characters to compare	If the <i>n</i> characters of both <i>s1</i> and <i>s2</i> are compared and found to be the same : 0 If the <i>n</i> characters of both <i>s1</i> and <i>s2</i> are compared and found to be different : Value differences that converted the initial differing characters into int ( <i>s1</i> letters - <i>s2</i> letters )

**[Description]**

- The memcmp function uses the *n* characters to compare the objects indicated by both *s1* and *s2*.
- The memcmp function returns 0, when the *n* characters of both *s1* and *s2* are compared and found to be the same.
- The memcmp function returns the value differences (*s1* letters - *s2* letters) that converted the initial differing characters into int if, the *n* characters of both *s1* and *s2* are compared and found to be different.

**strcmp**

Compares two strings

**[Syntax]**

```
#include <string.h>
int strcmp (const char *s1 , const char *s2) ;
```

**[Argument(s)/Return value]**

Argument	Return Value
<i>s1</i> : Pointer to one string to be compared	If <i>s1</i> is equal to <i>s2</i> : 0
<i>s2</i> : Pointer to the other string to be compared	If <i>s1</i> is less than or greater than <i>s2</i> : Value differences that converted the initial differing characters into int ( <i>s1</i> letters - <i>s2</i> letters)

**[Description]**

- The strcmp function uses to compare the character strings indicated by both *s1* and *s2*.
- If *s1* is equal to *s2*, the function returns 0. If *s1* is less than or greater than *s2*, the strcmp function returns the value differences (*s1* letters - *s2* letters) that converted the initial differing characters into int.

**strncmp**

Compares the specified number of characters of two strings

**[Syntax]**

```
#include <string.h>
int strncmp (const char *s1 , const char *s2 , size_t n) ;
```

**[Argument(s)/Return value]**

Argument	Return Value
<i>s1</i> : Pointer to one string to be compared <i>s2</i> : Pointer to the other string to be compared <i>n</i> : Number of characters to compare	If the <i>n</i> characters of both <i>s1</i> and <i>s2</i> are compared and found to be the same : 0 If the <i>n</i> characters of both <i>s1</i> and <i>s2</i> are compared and found to be different : Value differences that converted the initial differing characters into int ( <i>s1</i> letters - <i>s2</i> letters)

**[Description]**

- The strncmp function uses the *n* characters to compare the objects indicated by both *s1* and *s2*.
- The strncmp function returns 0, when the *n* characters of both *s1* and *s2* are compared and found to be the same. The strncmp function returns the value differences (*s1* letters - *s2* letters) that converted the initial differing characters into int if, the *n* characters of both *s1* and *s2* are compared and found to be different.

**memchr**

Searches for the specified string in the specified number of characters of a buffer

**[Syntax]**

```
#include <string.h>
void *memchr (const void *s , int c , size_t n) ;
```

**[Argument(s)/Return value]**

Argument	Return Value
<p><i>s</i> : Pointer to objects in memory subject to search</p> <p><i>c</i> : Character to be searched</p> <p><i>n</i> : Number of bytes to be searched</p>	<p>If <i>c</i> is found : Pointer to the first occurrence of <i>c</i></p> <p>If <i>c</i> is not found : Null pointer</p>

**[Description]**

- The memchr function first converts the character specified by *c* to unsigned char and then returns a pointer to the first occurrence of this character within the *n* number of bytes from the beginning of the object pointed to by *s*.
- If the character is not found, the function returns a null pointer.



**strchr**

Searches for the specified character from within a string and returns the location of the first occurrence

**[Syntax]**

```
#include <string.h>
char *strchr (const char *s , int c) ;
```

**[Argument(s)/Return value]**

Argument	Return Value
<b>s :</b> Pointer to string to be searched	If <b>c</b> is found in <b>s</b> : Pointer indicating the first occurrence of <b>c</b> in string <b>s</b>
<b>c :</b> Character specified for search	If <b>c</b> is not found in <b>s</b> : Null pointer

**[Description]**

- The strchr function searches the string pointed to by **s** for the character specified by **c** and returns a pointer to the first occurrence of **c** (converted to char type) in the string.
- The null terminator is regarded as part of the string.
- If the specified character is not found in the string, the function returns a null pointer.

**strchr**

Searches for the specified character from within a string and returns the location of the last occurrence

**[Syntax]**

```
#include <string.h>
char *strchr (const char *s , int c) ;
```

**[Argument(s)/Return value]**

Argument	Return Value
<p><i>s</i> :</p> <p>Pointer to string to be searched</p>	<p>If <i>c</i> is found in <i>s</i> :</p> <p>Pointer indicating the last occurrence of <i>c</i> in string <i>s</i></p>
<p><i>c</i> :</p> <p>Character specified for searches</p>	<p>If <i>c</i> is not found in <i>s</i> :</p> <p>Null pointer</p>

**[Description]**

- The strchr function searches the string pointed to by *s* for the character specified by *c* and returns a pointer to the last occurrence of *c* (converted to char type) in the string.
- The null terminator is regarded as part of the string.
- If no match is found, the function returns a null pointer.

**strspn**

Obtains the length from the start of a segment composed of only the characters included in the specified string within the string being searched

**[Syntax]**

```
#include <string.h>
size_t strspn (const char *s1 , const char *s2) ;
```

**[Argument(s)/Return value]**

Argument	Return Value
<i>s1</i> : Pointer to string to be searched  <i>s2</i> : Pointer to string whose characters are specified for match	Length of substring of the string <i>s1</i> that is made up of only those characters contained in the string <i>s2</i>

**[Description]**

- The strspn function returns the length of the substring of the string pointed to by *s1* that is made up of only those characters contained in the string pointed to by *s2*. In other words, this function returns the index of the first character in the string *s1* that does not match any of the characters in the string *s2*.
- The null terminator of *s2* is not regarded as part of *s2*.

**strcspn**

Obtains the length from the start of a segment composed of characters other than those included in the specified string within the string being searched

**[Syntax]**

```
#include <string.h>
size_t strcspn (const char *s1 , const char *s2) ;
```

**[Argument(s)/Return value]**

Argument	Return Value
<i>s1</i> : Pointer to string to be searched  <i>s2</i> : Pointer to string whose characters are specified for match	Length of substring of the string <i>s1</i> that is made up of only those characters not contained in the <i>s2</i>

**[Description]**

- The strcspn function returns the length of the substring of the string pointed to by *s1* that is made up of only those characters not contained in the string pointed to by *s2*. In other words, this function returns the index of the first character in the string *s1* that matches any of the characters in the string *s2*.
- The null terminator of *s2* is not regarded as part of *s2*.

**strpbrk**

Obtains the position of the first occurrence of any character in the specified string within the string being searched

**[Syntax]**

```
#include <string.h>
char *strpbrk (const char *s1 , const char *s2) ;
```

**[Argument(s)/Return value]**

Argument	Return Value
<p><i>s1</i> :</p> <p style="padding-left: 20px;">Pointer to string to be searched</p> <p><i>s2</i> :</p> <p style="padding-left: 20px;">Pointer to string whose characters are specified for match</p>	<p>If any match is found :</p> <p style="padding-left: 20px;">Pointer to the first character in the string <i>s1</i> that matches any character in the string <i>s2</i></p> <p>If no match is found :</p> <p style="padding-left: 20px;">Null pointer</p>

**[Description]**

- The strpbrk function returns a pointer to the first character in the string pointed to by *s1* that matches any character in the string pointed to by *s2*.
- If none of the characters in the string *s2* is found in the string *s1*, the function returns a null pointer.

**strstr**

Obtains the position of the first occurrence of the specified string within the string being searched

**[Syntax]**

```
#include <string.h>
char *strstr (const char *s1 , const char *s2) ;
```

**[Argument(s)/Return value]**

Argument	Return Value
<p><i>s1</i> :</p> <p>Pointer to string to be searched</p> <p><i>s2</i> :</p> <p>Pointer to specified string</p>	<p>If <i>s2</i> is found in <i>s1</i> :</p> <p>Pointer to the first appearance in the string <i>s1</i> of the string <i>s2</i></p> <p>If <i>s2</i> is not found in <i>s1</i> :</p> <p>Null pointer</p> <p>If <i>s2</i> is a null string :</p> <p>Value of <i>s1</i></p>

**[Description]**

- The strstr function returns a pointer to the first appearance in the string pointed to by *s1* of the string pointed to by *s2* (except the null terminator of *s2*).
- If the string *s2* is not found in the string *s1*, the function returns a null pointer.
- If the string *s2* is a null string, the function returns the value of *s1*.

**strtok**

Obtains the length of a string

**[Syntax]**

```
#include <string.h>
char *strtok (char *s1 , const char *s2) ;
```

**[Argument(s)/Return value]**

Argument	Return Value
<p><i>s1</i> :</p> <p>Pointer to string from which tokens are to be obtained or null pointer</p> <p><i>s2</i> :</p> <p>Pointer to string containing delimiters of token</p>	<p>If it is found :</p> <p>Pointer to the first character of a token</p> <p>If there is no token to return :</p> <p>Null pointer</p>

**[Description]**

- A token is a string consisting of characters other than delimiters in the string to be specified.
- If *s1* is a null pointer, the string pointed to by the saved pointer in the previous strtok call will be decomposed. However, if the saved pointer is a null pointer, the function returns a null pointer without doing anything.
- If *s1* is not a null pointer, the string pointed to by *s1* will be decomposed.
- The strtok function searches the string pointed to by *s1* for any character not contained in the string pointed to by *s2*. If no character is found, the function changes the saved pointer to a null pointer and returns it. If any character is found, the character becomes the first character of a token.
- If the first character of a token is found, the function searches for any characters contained in the string *s2* after the first character of the token. If none of the characters is found, the function changes the saved pointer to a null pointer. If any of the characters is found, the character is overwritten by a null character and a pointer to the next character becomes a pointer to be saved.
- The function returns a pointer to the first character of the token.

**memset**

Initializes the specified number of characters of a buffer with the specified character

**[Syntax]**

```
#include <string.h>
void *memset (void *s , int c , size_t n) ;
```

**[Argument(s)/Return value]**

Argument	Return Value
<p><i>s</i> : Pointer to object in memory to be initialized</p> <p><i>c</i> : Character whose value is to be assigned to each byte</p> <p><i>n</i> : Number of bytes to be initialized</p>	<p>Value of <i>s</i></p>

**[Description]**

- The memset function first converts the character specified by *c* to unsigned char and then assigns the value of this character to the *n* number of bytes from the beginning of the object pointed to by *s*.



**strerror**

Returns a pointer to the area that stores the error message string which corresponds to the specified error number

**[Syntax]**

```
#include <string.h>
char *strerror (int errnum) ;
```

**[Argument(s)/Return value]**

Argument	Return Value
<i>errnum</i> : Error number	If message associated with error number exists : Pointer to string describing error message If no message associated with error number exists : Null pointer

**[Description]**

- The `strerror` function returns the following values associated with the value of *errnum*.

Value of <i>errnum</i>	Return Value
0	Pointer to the string "Error 0"
1 (EDOM)	Pointer to the string "Argument too large"
2 (ERANGE)	Pointer to the string "Result too large"
3 (ENOMEM)	Pointer to the string "Not enough memory"
Others	Null pointer

- Error message strings are allocated in a far area, so the return value is always a far pointer. This is why there are no `strerror_n/strerror_f` functions.

**strlen**

Obtains the length of a string

**[Syntax]**

```
#include <string.h>
size_t strlen (const char *s) ;
```

**[Argument(s)/Return value]**

Argument	Return Value
s : Pointer to character string	Length of string s

**[Description]**

- The strlen function returns the length of the null terminated string pointed to by s.

**strcoll**

Compares two strings based on region specific information

**[Syntax]**

```
#include <string.h>
int strcoll (const char *s1 , const char *s2) ;
```

**[Argument(s)/Return value]**

Argument	Return Value
<p><i>s1</i> : Pointer to comparison character string</p> <p><i>s2</i> : Pointer to comparison character string</p>	<p>When character strings <i>s1</i> and <i>s2</i> are equal : 0</p> <p>When character strings <i>s1</i> and <i>s2</i> are different : The difference between the values whose first different characters are converted to int (character of <i>s1</i> - character of <i>s2</i>)</p>

**[Description]**

- The 78K0 C compiler does not support operations specific to cultural sphere.  
The operations are the same as that of strcmp.

**strxfrm**

Transforms a string based on region specific information

**[Syntax]**

```
#include <string.h>
size_t strxfrm (char *s1 , const char *s2 , size_t n) ;
```

**[Argument(s)/Return value]**

Argument	Return Value
<p><i>s1</i> :</p> <p>Pointer to a compared character string</p> <p><i>s2</i> :</p> <p>Pointer to a compared character string</p> <p><i>n</i> :</p> <p>Maximum number of characters to <i>s1</i></p>	<p>Returns the length of the character string of the result of the conversion (does not include a character string to indicate the end).</p> <p>If the returned value is <i>n</i> or more, the contents of the array indicated by <i>s1</i> is undefined.</p>

**[Description]**

- The 78K0 C compiler does not support operations specific to cultural sphere.

The operations are the same as those of the following functions.

```
strncpy (s1 , s2 , c) ;
return (strlen (s2) ) ;
```

### 6.11 Mathematical Functions

The following mathematical functions are available.

Function Name	Purpose
<a href="#">acos (normal model only)</a>	Finds acos
<a href="#">asin (normal model only)</a>	Finds asin
<a href="#">atan (normal model only)</a>	Finds atan
<a href="#">atan2 (normal model only)</a>	Finds atan2
<a href="#">cos (normal model only)</a>	Finds cos
<a href="#">sin (normal model only)</a>	Finds sin
<a href="#">tan (normal model only)</a>	Finds tan
<a href="#">cosh (normal model only)</a>	Finds cosh
<a href="#">sinh (normal model only)</a>	Finds sinh
<a href="#">tanh (normal model only)</a>	Finds tanh
<a href="#">exp (normal model only)</a>	Finds the exponential function
<a href="#">frexp (normal model only)</a>	Finds mantissa and exponent part
<a href="#">ldexp (normal model only)</a>	Finds $x * 2 ^ \text{exp}$
<a href="#">log (normal model only)</a>	Finds the natural logarithm
<a href="#">log10 (normal model only)</a>	Finds the base 10 logarithm
<a href="#">modf (normal model only)</a>	Finds the decimal and integer parts
<a href="#">pow (normal model only)</a>	Finds yth power of x
<a href="#">sqrt (normal model only)</a>	Finds the square root
<a href="#">ceil (normal model only)</a>	Finds the smallest integer not smaller than x
<a href="#">fabs (normal model only)</a>	Finds the absolute value of floating point number x
<a href="#">floor (normal model only)</a>	Finds the largest integer not larger than x
<a href="#">fmod (normal model only)</a>	Finds the remainder of x/y
<a href="#">matherr (normal model only)</a>	Obtains the exception processing for the library handling floating point numbers
<a href="#">acosf (normal model only)</a>	Finds acos
<a href="#">asinf (normal model only)</a>	Finds asin
<a href="#">atanf (normal model only)</a>	Finds atan
<a href="#">atan2f (normal model only)</a>	Finds atan of y/x
<a href="#">cosf (normal model only)</a>	Finds cos
<a href="#">sinf (normal model only)</a>	Finds sin
<a href="#">tanf (normal model only)</a>	Finds tan
<a href="#">coshf (normal model only)</a>	Finds cosh
<a href="#">sinhf (normal model only)</a>	Finds sinh
<a href="#">tanhf (normal model only)</a>	Finds tanh
<a href="#">expf (normal model only)</a>	Finds the exponential function
<a href="#">frexpf (normal model only)</a>	Finds mantissa and exponent part

Function Name	Purpose
ldexpf (normal model only)	Finds $x * 2 ^ \text{exp}$
logf (normal model only)	Finds the natural logarithm
log10f (normal model only)	Finds the base 10 logarithm
modff (normal model only)	Finds the decimal and integer parts
powf (normal model only)	Finds yth power of x
squref (normal model only)	Finds the square root
ceilf (normal model only)	Finds the smallest integer not smaller than x
fabsf (normal model only)	Finds the absolute value of floating point number x
floorf (normal model only)	Finds the largest integer not larger than x
fmodf (normal model only)	Finds the remainder of x/y

**acos (normal model only)**

Finds acos

**[Syntax]**

```
#include <math.h>
double acos (double x) ;
```

**[Argument(s)/Return value]**

Argument	Return Value
<p><i>x</i> :</p> <p>Numeric value to perform operation</p>	<p>When <math>-1 \leq x \leq 1</math> :</p> <p>acos of <i>x</i></p> <p>When <math>x &lt; -1, 1 &lt; x, x = \text{NaN}</math> :</p> <p>NaN</p>

**[Description]**

- Calculates acos of *x* (range between 0 and  $\pi$ ).
- In the case of the definition area error of  $x < -1, 1 < x$ , NaN is returned and EDOM is set.
- When *x* is non-numeric, NaN is returned.

**asin (normal model only)**

Finds asin

**[Syntax]**

```
#include <math.h>
double asin (double x) ;
```

**[Argument(s)/Return value]**

Argument	Return Value
<p><i>x</i> :</p> <p>Numeric value to perform operation</p>	<p>When <math>-1 \leq x \leq 1</math> :</p> <p>asin of <i>x</i></p> <p>When <math>x &lt; -1, 1 &lt; x, x = \text{NaN}</math> :</p> <p>NaN</p> <p>When <math>x = -0</math> :</p> <p>-0</p> <p>When underflow occurs :</p> <p>Non-normalized number</p>

**[Description]**

- Calculates asin (range between  $-\pi/2$  and  $+\pi/2$ ) of *x*.
- In the case of area error of  $x < -1, 1 < x$ , NaN is returned and EDOM is set to errno.
- When *x* is non-numeric, NaN is returned.
- When *x* is -0, -0 is returned.
- If underflow occurs as a result of conversion, a non-normalized number is returned.



**atan (normal model only)**

Finds atan

**[Syntax]**

```
#include <math.h>
double atan (double x) ;
```

**[Argument(s)/Return value]**

Argument	Return Value
<p><i>x</i> :</p> <p>Numeric value to perform operation</p>	<p>Normal :</p> <p>atan of <i>x</i></p> <p>When <i>x</i> = NaN :</p> <p>NaN</p> <p>When <i>x</i> = -0 :</p> <p>-0</p> <p>When underflow occurs :</p> <p>Non-normalized number</p>

**[Description]**

- Calculates atan (range between  $-\pi/2$  and  $+\pi/2$ ) of *x*.
- When *x* is non-numeric, NaN is returned.
- When *x* is -0, -0 is returned.
- If underflow occurs as a result of conversion, a non-normalized number is returned.

**atan2 (normal model only)**

Finds atan of y/x

**[Syntax]**

```
#include <math.h>
double atan2 (double y , double x) ;
```

**[Argument(s)/Return value]**

Argument	Return Value
<p><b>x :</b> Numeric value to perform operation</p> <p><b>y :</b> Numeric value to perform operation</p>	<p>Normal : atan of y/x</p> <p>When both x and y are 0 or y/x is the value that cannot be expressed, or either x or y is NaN and both x and y are <math>\pm \infty</math> : NaN</p> <p>When underflow occurs : Non-normalized number</p>

**[Description]**

- atan (range between  $-\pi$  and  $+\pi$ ) of y/x is calculated.
- When both x and y are 0 or y/x is the value that cannot be expressed, or when both x and y are infinite, NaN is returned and EDOM is set to errno.
- If either x or y is non-numeric, NaN is returned.
- If underflow occurs as a result of operation, non-normalized number is returned.

**cos (normal model only)**

Finds cos

**[Syntax]**

```
#include <math.h>
double cos (double x) ;
```

**[Argument(s)/Return value]**

Argument	Return Value
<p><i>x</i> :</p> <p>Numeric value to perform operation</p>	<p>Normal :</p> <p>cos of <i>x</i></p> <p>When <i>x</i> = NaN, when <i>x</i> is infinite :</p> <p>NaN</p>

**[Description]**

- Calculates cos of *x*.
- If *x* is non-numeric, NaN is returned.
- If *x* is infinite, NaN is returned and EDOM is set to errno.
- If the absolute value of *x* is extremely large, the result of an operation becomes an almost meaningless value.

**sin (normal model only)**

Finds sin

**[Syntax]**

```
#include <math.h>
double sin (double x) ;
```

**[Argument(s)/Return value]**

Argument	Return Value
<p><i>x</i> :</p> <p>Numeric value to perform operation</p>	<p>Normal :</p> <p>sin of <i>x</i></p> <p>When <i>x</i> = NaN, when <i>x</i> is infinite :</p> <p>NaN</p> <p>When underflow occurs :</p> <p>Non-normalized number</p>

**[Description]**

- Calculates sin of *x*.
- If *x* is non-numeric, NaN is returned.
- If *x* is infinite, NaN is returned and EDOM is set to errno.
- If underflow occurs as a result of operation, a non-normalized number is returned.
- If the absolute value of *x* is extremely large, the result of an operation becomes an almost meaningless value.

**tan (normal model only)**

Finds tan

**[Syntax]**

```
#include <math.h>
double tan (double x) ;
```

**[Argument(s)/Return value]**

Argument	Return Value
<p><i>x</i> :</p> <p>Numeric value to perform operation</p>	<p>Normal :</p> <p>tan of <i>x</i></p> <p>When <math>x = \text{NaN}</math>, <math>x = \pm \infty</math> :</p> <p>NaN</p> <p>When underflow occurs :</p> <p>Non-normalized number</p>

**[Description]**

- Calculates tan of *x*.
- If *x* is non-numeric, NaN is returned.
- If *x* is infinite, NaN is returned and EDOM is set to errno.
- If underflow occurs as a result of operation, a non-normalized number is returned.
- If the absolute value of *x* is extremely large, the result of an operation becomes an almost meaningless value.

**cosh (normal model only)**

Finds cosh

**[Syntax]**

```
#include <math.h>
double cosh (double x) ;
```

**[Argument(s)/Return value]**

Argument	Return Value
<p><i>x</i> :</p> <p>Numeric value to perform operation</p>	<p>Normal :</p> <p>cosh of <i>x</i></p> <p>When <i>x</i> = NaN :</p> <p>NaN</p> <p>When <i>x</i> = ± ∞:</p> <p>+∞</p> <p>When overflow occurs</p> <p>HUGE_VAL (with the sign of the overflown value)</p>

**[Description]**

- Calculates cosh of *x*.
- If *x* is non-numeric, NaN is returned.
- If *x* is infinite, a positive infinite value is returned.
- If overflow occurs as a result of operation, HUGE\_VAL with a positive sign is returned, and ERANGE is set to errno.

**sinh (normal model only)**

Finds sinh

**[Syntax]**

```
#include <math.h>
double sinh (double x);
```

**[Argument(s)/Return value]**

Argument	Return Value
<p><i>x</i> :</p> <p>Numeric value to perform operation</p>	<p>Normal :</p> <p>sinh of <i>x</i></p> <p>When <i>x</i> = NaN :</p> <p>NaN</p> <p>When <i>x</i> = <math>\pm \infty</math> :</p> <p><math>\pm \infty</math></p> <p>When overflow occurs :</p> <p>HUGE_VAL (with the sign of the overflowed value)</p> <p>When underflow occurs :</p> <p><math>\pm 0</math></p>

**[Description]**

- Calculates sinh of *x*.
- If *x* is non-numeric, NaN is returned.
- If *x* is  $\pm \infty$ ,  $\pm \infty$  is returned.
- If overflow occurs as a result of operation, HUGE\_VAL with the sign of the overflowed value is returned, and ERANGE is set to errno.
- If underflow occurs as a result of operation, +0 is returned.

**tanh (normal model only)**

Finds tanh

**[Syntax]**

```
#include <math.h>
double tanh (double x) ;
```

**[Argument(s)/Return value]**

Argument	Return Value
<p><i>x</i> :</p> <p>Numeric value to perform operation</p>	<p>Normal :</p> <p style="padding-left: 20px;">tanh of <i>x</i></p> <p>When <math>x = \text{NaN}</math> :</p> <p style="padding-left: 20px;">NaN</p> <p>When <math>x = \pm \infty</math> :</p> <p style="padding-left: 20px;"><math>\pm 1</math></p> <p>When underflow occurs :</p> <p style="padding-left: 20px;"><math>\pm 0</math></p>

**[Description]**

- Calculates tanh of *x*.
- If *x* is non-numeric, NaN is returned.
- If *x* is  $\pm \infty$ ,  $\pm 1$  is returned.
- If underflow occurs as a result of operation,  $\pm 0$  is returned.



**exp (normal model only)**

Finds the exponential function

**[Syntax]**

```
#include <math.h>
double exp (double x) ;
```

**[Argument(s)/Return value]**

Argument	Return Value
<p><i>x</i> :</p> <p>Numeric value to perform operation</p>	<p>Normal :</p> <p>Exponent function of <i>x</i></p> <p>When <i>x</i> = NaN :</p> <p>NaN</p> <p>When <i>x</i> = ±∞ :</p> <p>±∞</p> <p>When underflow occurs :</p> <p>Non-normalized number</p> <p>When annihilation of valid digits occurs due to underflow :</p> <p>+0</p> <p>When overflow occurs :</p> <p>HUGE_VQAL (with positive sign)</p>

**[Description]s**

- Calculates exponent function of *x*.
- If *x* is non-numeric, NaN is returned.
- If *x* is ±∞, ±∞ is returned.
- If underflow occurs as a result of operation, non-normalized number is returned.
- If annihilation of valid digits due to underflow occurs as a result of operation, +0 is returned.
- If overflow occurs as a result of operation, HUGE\_VAL with a positive sign is returned and ERANGE is set to errno.

**frexp (normal model only)**

Finds mantissa and exponent part

**[Syntax]**

```
#include <math.h>
double frexp (double x , int *exp) ;
```

**[Argument(s)/Return value]**

Argument	Return Value
<p><i>x</i> :</p> <p>Numeric value to perform operation</p> <p><i>exp</i> :</p> <p>Pointer to store exponent part</p>	<p>Normal :</p> <p>Mantissa of <i>x</i></p> <p>When <math>x = \text{NaN}</math>, <math>x = \pm \infty</math> :</p> <p>NaN</p> <p>When <math>x = \pm 0</math> :</p> <p><math>\pm 0</math></p>

**[Description]**

- Divide a floating point number *x* to mantissa *m* and exponent *n* such as  $x = m * 2 ^ n$  and returns mantissa *m*.
- Exponent *n* is stored where the pointer *exp* indicates. The absolute value of *m*, however, is 0.5 or more and less than 1.0.
- If *x* is non-numeric, NaN is returned and the value of *\*exp* is 0.
- If *x* is infinite, NaN is returned, and EDOM is set to *errno* with the value of *\*exp* as 0.
- If *x* is  $\pm 0$ ,  $\pm 0$  is returned and the value of *\*exp* is 0.

**ldexp (normal model only)**

Finds  $x * 2^{exp}$

**[Syntax]**

```
#include <math.h>
double ldexp (double x , int exp) ;
```

**[Argument(s)/Return value]**

Argument	Return Value
<p><i>x</i> : Numeric value to perform operation</p> <p><i>exp</i> : Exponentiation</p>	<p>Normal : <math>x * 2^{exp}</math></p> <p>When <math>x = \text{NaN}</math> : NaN</p> <p>When <math>x = \pm \infty</math> : <math>\pm \infty</math></p> <p>When <math>x = \pm 0</math> : <math>\pm 0</math></p> <p>When overflow occurs : HUGE_VAL (with the sign of the overflowed value)</p> <p>When underflow occurs : Non-normalized number</p> <p>When annihilation of valid digits occurs due to underflow : <math>\pm 0</math></p>

**[Description]**

- Calculates  $x * 2^{exp}$ .
- If  $x$  is non-numeric, NaN is returned.
- If  $x$  is  $\pm \infty$ ,  $\pm \infty$  is returned.
- If  $x$  is  $\pm 0$ ,  $\pm 0$  is returned.
- If overflow occurs as a result of operation, HUGE\_VAL with the overflowed value is returned and ERANGE is set to errno.
- If underflow occurs as a result of operation, non-normalized number is returned.
- If annihilation of valid digits due to underflow occurs as a result of operation,  $\pm 0$  is returned.

**log (normal model only)**

Finds the natural logarithm

**[Syntax]**

```
#include <math.h>
double log (double x) ;
```

**[Argument(s)/Return value]**

Argument	Return Value
<p><i>x</i> :</p> <p>Numeric value to perform operation</p>	<p>Normal :</p> <p>Natural logarithm of <i>x</i></p> <p>When <math>x \leq 0</math> :</p> <p><b>HUGE_VAL</b> (with negative sign)</p> <p>When <math>x = \text{NaN}</math> :</p> <p>NaN</p> <p>When <math>x</math> is infinite :</p> <p><math>+\infty</math></p>

**[Description]**

- Finds natural logarithm of *x*.
- In the case of area error of  $x < 0$ , HUGE\_VAL with a negative sign is returned, EDOM is set to errno.
- If  $x = 0$ , HUGE\_VAL with a negative sign is returned, and ERANGE is set to errno.
- If *x* is non-numeric, NaN is returned.
- If  $x$  is  $+\infty$ ,  $+\infty$  is returned.

**log10 (normal model only)**

Finds the base 10 logarithm

**[Syntax]**

```
#include <math.h>
double log10 (double x);
```

**[Argument(s)/Return value]**

Argument	Return Value
<p><b>x :</b> Numeric value to perform operation</p>	<p>Normal : ithm with 10 of x as the base</p> <p>When <math>x \leq 0</math> : HUGE_VAL HUGE_VAL (with negative sign)</p> <p>When <math>x = \text{NaN}</math> : NaN</p> <p>When <math>x</math> is infinite : <math>+\infty</math></p>

**[Description]**

- Finds logarithm with 10 of x as the base.
- In the case of area error of  $x < 0$ , HUGE\_VAL with a negative sign is returned, EDOM is set to errno.
- If  $x = 0$ , HUGE\_VAL with a negative sign is returned, and ERANGE is set to errno.
- If x is non-numeric, NaN is returned.
- If x is  $+\infty$ ,  $+\infty$  is returned.

**modf (normal model only)**

Finds the decimal and integer parts

**[Syntax]**

```
#include <math.h>
double modf (double x , double *iptr) ;
```

**[Argument(s)/Return value]**

Argument	Return Value
<p><i>x</i> :</p> <p>Numeric value to perform operation</p> <p><i>iptr</i> :</p> <p>Pointer to integer part</p>	<p>Normal :</p> <p>Fraction part of <i>x</i></p> <p>When <i>x</i> is non-numeric or infinite :</p> <p>NaN</p> <p>When <i>x</i> is <math>\pm 0</math> :</p> <p><math>\pm 0</math></p>

**[Description]**

- Divides a floating point number *x* to fraction part and integer part
- Returns fraction part with the same sign as that of *x*, and stores the integer part to the location indicated by the pointer *iptr*.
- If *x* is non-numeric, NaN is returned and stored to the location indicated by the pointer *iptr*.
- If *x* is infinite, NaN is returned and stored to the location indicated by the pointer *iptr*, and EDOM is set to errno.
- If  $x = \pm 0$ ,  $\pm 0$  is stored to the location indicated by the pointer *iptr*.

**pow (normal model only)**

Finds yth power of x

**[Syntax]**

```
#include <math.h>
double pow (double x , double y) ;
```

**[Argument(s)/Return value]**

Argument	Return Value
<p><b>x :</b> Numeric value to perform operation</p> <p><b>y :</b> Multiplier</p>	<p>Normal : <math>x^y</math></p> <p>Either when <math>x = \text{NaN}</math> or <math>y = \text{NaN}</math>,  <math>x = +\infty</math> and <math>y = 0</math>,  <math>x &lt; 0</math> and <math>y \neq \text{integer}</math>,  <math>x &lt; 0</math> and <math>y = \pm \infty</math>,  <math>x = 0</math> and <math>y \leq 0</math> :</p> <p>NaN</p> <p>When overflow occurs : HUGE_VAL (with the sign of overflown value)</p> <p>When underflow occurs : Non-normalized number</p> <p>When annihilation of valid digits occurs due to underflow : <math>\pm 0</math></p>

**[Description]**

- Calculates  $x^y$ .
- When  $x = \text{NaN}$  or  $y = \text{NaN}$ , NaN is returned.
- Either when  $x = \pm \infty$  and  $y = 0$ ,  $x < 0$  and  $y \neq \text{integer}$ ,  $x < 0$  and  $y = \pm \infty$  or  $x = 0$  and  $y \leq 0$ , NaN is returned and EDOM is set to errno.
- If overflow occurs as a result of operation, HUGE\_VAL with the sign of overflown value is returned, and ERANGE is set to errno.
- If underflow occurs, a non-normalized number is returned.
- If annihilation of valid digits occurs due to underflow,  $\pm 0$  is returned.

**sqrt (normal model only)**

Finds the square root

**[Syntax]**

```
#include <math.h>
double sqrt (double x) ;
```

**[Argument(s)/Return value]**

Argument	Return Value
<p><i>x</i> :</p> <p>Numeric value to perform operation</p>	<p>When <math>x \geq 0</math> :</p> <p>Square root of <math>x</math></p> <p>When <math>x &lt; 0</math> :</p> <p>0</p> <p>When <math>x = \text{NaN}</math> :</p> <p>NaN</p> <p>When <math>x = \pm 0</math> :</p> <p><math>\pm 0</math></p>

**[Description]**

- Calculates the square root of  $x$ .
- In the case of area error of  $x < 0$ , 0 is returned and EDOM is set to errno.
- If  $x$  is non-numeric, NaN is returned.
- If  $x$  is  $\pm 0$ ,  $\pm 0$  is returned.



**ceil (normal model only)**

Finds the smallest integer not smaller than x

**[Syntax]**

```
#include <math.h>
double ceil (double x) ;
```

**[Argument(s)/Return value]**

Argument	Return Value
<p>x :</p> <p>Numeric value to perform operation</p>	<p>Normal :</p> <p>The minimum integer no less than x</p> <p>When x is non-numeric or when x is infinite :</p> <p>NaN</p> <p>When x = -0 :</p> <p>+0</p> <p>When the minimum integer no less than x cannot be expressed :</p> <p>x</p>

**[Description]**

- Finds the minimum integer no less than x.
- If x is non-numeric, NaN is returned.
- If x is infinite, NaN is returned and EDOM is set to errno.
- If x is -0, +0 is returned.
- If the minimum integer no less than x cannot be expressed, x is returned.

**fabs (normal model only)**

Finds the absolute value of floating point number  $x$

**[Syntax]**

```
#include <math.h>
double fabs (double  $x$ );
```

**[Argument(s)/Return value]**

Argument	Return Value
$x$ : Numeric value to find the absolute value	Normal : Absolute value of $x$ When $x = \text{NaN}$ : NaN When $x = -0$ : +0

**[Description]**

- Finds the absolute value of  $x$ .
- If  $x$  is non-numeric, NaN is returned.
- If  $x$  is  $-0$ ,  $+0$  is returned.

**floor (normal model only)**

Finds the largest integer not larger than x

**[Syntax]**

```
#include <math.h>
double floor (double x) ;
```

**[Argument(s)/Return value]**

Argument	Return Value
<p>x :</p> <p>Numeric value to perform operation</p>	<p>Normal :</p> <p>The maximum integer no more than x</p> <p>When x is non-numeric or when x is infinite :</p> <p>NaN</p> <p>When x = -0 :</p> <p>+0</p> <p>When the maximum integer no more than x cannot be expressed :</p> <p>x</p>

**[Description]**

- Finds the maximum integer no more than x.
- If x is non-numeric, NaN is returned.
- If x is infinite, NaN is returned and EDOM is set to errno.
- If x is -0, +0 is returned.
- If the maximum integer no more than x cannot be expressed, x is returned.

**fmod (normal model only)**

Finds the remainder of x/y

**[Syntax]**

```
#include <math.h>
double fmod (double x , double y)
```

**[Argument(s)/Return value]**

Argument	Return Value
<p><b>x :</b> Numeric value to perform operation</p> <p><b>y :</b> Numeric value to perform operation</p>	<p>Normal : Remainder of x/y</p> <p>When x is non-numeric or y is non-numeric, when y is <math>\pm 0</math>, when x is <math>\pm \infty</math> : NaN</p> <p>When <math>x \neq \infty</math> and <math>y = \pm \infty</math> : x</p>

**[Description]**

- Calculates the remainder of x/y expressed with  $x - i * y$ . i is an integer.
- If  $y \neq 0$ , the return value has the same sign as that of x and the absolute value is less than that of y.
- If x is non-numeric or y is non-numeric, NaN is returned.
- If y is  $\pm 0$  or  $x = \pm \infty$ , NaN is returned and EDOM is set to errno.
- If y is infinite, x is returned unless x is infinite.

**matherr (normal model only)**

Obtains the exception processing for the library handling floating point numbers

**[Syntax]**

```
#include <math.h>
void matherr (struct exception *x) ;
```

**[Argument(s)/Return value]**

Argument	Return Value
<pre>struct exception {     int    type ;     char   *name ; }  type :     Numeric value to indicate arithmetic exception name :     Function name</pre>	<p>None</p>

**[Description]**

- When an exception is generated, matherr is automatically called in the standard library and run-time library that deal with floating-point numbers.
  - When called from the standard library, EDOM and ERANGE are set to errno.
- The following shows the relationship between the arithmetic exception type and errno.

Type	Arithmetic Exception	Value Set to errno
1	Underflow	ERANGE
2	Annihilation	ERANGE
3	Overflow	ERANGE
4	Zero division	EDOM
5	Inoperable	EDOM

Original error processing can be performed by changing or creating matherr.

- The argument is always a near pointer, because it points to an exception structure in internal RAM. This is why there are no matherr\_n/matherr\_f functions.

**acosf (normal model only)**

Finds acos

**[Syntax]**

```
#include <math.h>
float acosf (float x) ;
```

**[Argument(s)/Return value]**

Argument	Return Value
<p><i>x</i> :</p> <p>Numeric value to perform operation</p>	<p>When <math>-1 \leq x \leq 1</math> :</p> <p>acos of <i>x</i></p> <p>When <math>x &lt; -1, 1 &lt; x, x = \text{NaN}</math> :</p> <p>NaN</p>

**[Description]**

- Calculates acos (range between 0 and  $\pi$ ) of *x*.
- In the case of definition area error of  $x < -1, 1 < x$ , NaN is returned and EDOM is set to errno.
- If *x* is non-numeric, NaN is returned.

**asinf (normal model only)**

Finds asin

**[Syntax]**

```
#include <math.h>
float asinf (float x);
```

**[Argument(s)/Return value]**

Argument	Return Value
<p><i>x</i> :</p> <p>Numeric value to perform operation</p>	<p>When <math>-1 \leq x \leq 1</math> :</p> <p style="padding-left: 20px;">asin of <i>x</i></p> <p>When <math>x &lt; -1, 1 &lt; x, x = \text{NaN}</math> :</p> <p style="padding-left: 20px;">NaN</p> <p>When <math>x = -0</math> :</p> <p style="padding-left: 20px;">-0</p> <p>When underflow occurs :</p> <p style="padding-left: 20px;">Non-normalized number</p>

**[Description]**

- Calculates asin (range between  $-\pi/2$  and  $+\pi/2$ ) of *x*.
- In the case of definition area error of  $x < -1, 1 < x$ , NaN is returned and EDOM is set to errno.
- If *x* is non-numeric, NaN is returned.
- If  $x = -0$ , -0 is returned.
- If underflow occurs as a result of operation, a non-normalized number is returned.

**atanf (normal model only)**

Finds atan

**[Syntax]**

```
#include <math.h>
float atanf (float x);
```

**[Argument(s)/Return value]**

Argument	Return Value
<p><i>x</i> :</p> <p>Numeric value to perform operation</p>	<p>Normal :</p> <p>atan of <i>x</i></p> <p>When <i>x</i> = NaN :</p> <p>NaN</p> <p>When <i>x</i> = -0 :</p> <p>-0</p> <p>When underflow occurs :</p> <p>Non-normalized number</p>

**[Description]**

- Calculates atan (range between  $-\pi/2$  and  $+\pi/2$ ) of *x*.
- If *x* is non-numeric, NaN is returned.
- If *x* = -0, -0 is returned.
- If underflow occurs as a result of operation, a non-normalized number is returned.



**atan2f (normal model only)**

Finds atan of y/x

**[Syntax]**

```
#include <math.h>
float atan2f (float y , float x) ;
```

**[Argument(s)/Return value]**

Argument	Return Value
<p><b>x :</b> Numeric value to perform operation</p> <p><b>y :</b> Numeric value to perform operation</p>	<p>Normal : atan of y/x</p> <p>When both x and y are 0 or a value whose y/ x cannot be expressed, or either x or y is NaN, both x and y are infinite : NaN</p> <p>When underflow occurs : Non-normalized number</p>

**[Description]**

- Calculates atan (range between  $-\pi$  and  $+\pi$ ) of y/x.
- When both x and y are 0 or the value whose y/x cannot be expressed, or when both x and y are infinite, NaN is returned and EDOM is set to errno.
- When either x or y is non-numeric, NaN is returned.
- If underflow occurs as a result of operation, a non-normalized number is returned.

**cosf (normal model only)**

Finds cos

**[Syntax]**

```
#include <math.h>
float cosf (float x) ;
```

**[Argument(s)/Return value]**

Argument	Return Value
<p><i>x</i> :</p> <p>Numeric value to perform operation</p>	<p>Normal :</p> <p>cos of <i>x</i></p> <p>When <i>x</i> = NaN, <i>x</i> is infinite :</p> <p>NaN</p>

**[Description]**

- Calculates cos of *x*.
- If *x* is non-numeric, NaN is returned.
- If *x* is infinite, NaN is returned and EDOM is set to errno.
- If the absolute value of *x* is extremely large, the result of an operation becomes an almost meaningless value.

**sinf (normal model only)**

Finds sin

**[Syntax]**

```
#include <math.h>
float sinf (float x);
```

**[Argument(s)/Return value]**

Argument	Return Value
<p><i>x</i> :</p> <p>Numeric value to perform operation</p>	<p>Normal :</p> <p>sin of <i>x</i></p> <p>When <i>x</i> = NaN, <i>x</i> is infinite :</p> <p>NaN</p> <p>When underflow occurs :</p> <p>Non-normalized number</p>

**[Description]**

- Calculates sin of *x*.
- If *x* is non-numeric, NaN is returned.
- If *x* is infinite, NaN is returned and EDOM is set to errno.
- If underflow occurs as a result of operation, a non-normalized number is returned.
- If the absolute value of *x* is extremely large, the result of an operation becomes an almost meaningless value.

**tanf (normal model only)**

Finds tan

**[Syntax]**

```
#include <math.h>
float tanf (float x);
```

**[Argument(s)/Return value]**

Argument	Return Value
<p><i>x</i> :</p> <p>Numeric value to perform operation</p>	<p>Normal :</p> <p>tan of <i>x</i></p> <p>When <i>x</i> = NaN, <i>x</i> is infinite :</p> <p>NaN</p> <p>When underflow occurs :</p> <p>Non-normalized number</p>

**[Description]**

- Calculates tan of *x*.
- If *x* is non-numeric, NaN is returned.
- If *x* is infinite, NaN is returned and EDOM is set to errno.
- If underflow occurs as a result of operation, a non-normalized number is returned.
- If the absolute value of *x* is extremely large, the result of an operation becomes an almost meaningless value.

**coshf (normal model only)**

Finds cosh

**[Syntax]**

```
#include <math.h>
float coshf (float x) ;
```

**[Argument(s)/Return value]**

Argument	Return Value
<p><i>x</i> :</p> <p>Numeric value to perform operation</p>	<p>Normal :</p> <p>cosh of <i>x</i></p> <p>When <i>x</i> = NaN :</p> <p>NaN</p> <p>When <i>x</i> is infinite :</p> <p>+∞</p> <p>When overflow occurs :</p> <p>HUGE_VAL (with positive sign)</p>

**[Description]**

- Calculates cosh of *x*.
- If *x* is non-numeric, NaN is returned.
- If *x* is infinite, positive infinite value is returned.
- If overflow occurs as a result of operation, HUGE\_VAL with a positive sign is returned and ERANGE is set to errno.

**sinhf (normal model only)**

Finds sinh

**[Syntax]**

```
#include <math.h>
float sinhf (float x) ;
```

**[Argument(s)/Return value]**

Argument	Return Value
<p><i>x</i> :</p> <p>Numeric value to perform operation</p>	<p>Normal :</p> <p>sinh of <i>x</i></p> <p>When <i>x</i> = NaN :</p> <p>NaN</p> <p>When <i>x</i> = <math>\pm \infty</math> :</p> <p><math>\pm \infty</math></p> <p>When overflow occurs :</p> <p>HUGE_VAL (with a sign of the overflowed value)</p> <p>When underflow occurs :</p> <p><math>\pm 0</math></p>

**[Description]**

- Calculates sinh of *x*.
- If *x* is non-numeric, NaN is returned.
- If *x* is  $\pm \infty$ ,  $\pm \infty$  is returned.
- If overflow occurs as a result of operation, HUGE\_VAL with the sign of overflowed value is returned and ERANGE is set to errno.
- If underflow occurs as a result of operation,  $\pm 0$  is returned.

**tanhf (normal model only)**

Finds tanh

**[Syntax]**

```
#include <math.h>
float tanhf (float x);
```

**[Argument(s)/Return value]**

Argument	Return Value
<p><math>x</math> :</p> <p>Numeric value to perform operation</p>	<p>Normal :</p> <p>tanh of <math>x</math></p> <p>When <math>x = \text{NaN}</math> :</p> <p>NaN</p> <p>When <math>x = \pm \infty</math> :</p> <p><math>\pm 1</math></p> <p>When underflow occurs :</p> <p><math>\pm 0</math></p>

**[Description]**

- Calculates tanh of  $x$ .
- If  $x$  is non-numeric, NaN is returned.
- If  $x$  is  $\pm \infty$ ,  $\pm 1$  is returned.
- If underflow occurs as a result of operation,  $\pm 0$  is returned.

**expf (normal model only)**

Finds the exponential function

**[Syntax]**

```
#include <math.h>
float expf (float x) ;
```

**[Argument(s)/Return value]**

Argument	Return Value
<p><i>x</i> :</p> <p>Numeric value to perform operation</p>	<p>Normal :</p> <p>Exponent function of <i>x</i></p> <p>When <i>x</i> = NaN :</p> <p>NaN</p> <p>When <i>x</i> = ±∞ :</p> <p>±∞</p> <p>When overflow occurs :</p> <p>HUGE_VQAL (with positive sign)</p> <p>When underflow occurs :</p> <p>Non-normalized number</p> <p>When annihilation of valid digits occurs due to underflow :</p> <p>+0</p>

**[Description]**

- Calculates exponent function of *x*.
- If *x* is non-numeric, NaN is returned.
- If *x* is ±∞, ±∞ is returned.
- If overflow occurs as a result of operation, HUGE\_VAL with a positive sign is returned and ERANGE is set to errno.
- If underflow occurs as a result of operation, non-normalized number is returned.
- If annihilation of effective digits occurs due to underflow as a result of operation, +0 is returned.



**frexpf (normal model only)**

Finds mantissa and exponent part

**[Syntax]**

```
#include <math.h>
float frexpf (float x , int *exp) ;
```

**[Argument(s)/Return value]**

Argument	Return Value
<p><i>x</i> :</p> <p>Numeric value to perform operation</p> <p><i>exp</i> :</p> <p>Pointer to store exponent part</p>	<p>Normal :</p> <p>Mantissa of <i>x</i></p> <p>When <math>x = \text{NaN}</math>, <math>x = \pm \infty</math> :</p> <p>NaN</p> <p>When <math>x = \pm 0</math> :</p> <p><math>\pm 0</math></p>

**[Description]**

- Divides a floating-point number *x* to mantissa *m* and exponent *n* such as  $x = m * 2 ^ n$  and returns mantissa *m*.
- Exponent *n* is stored in where the pointer *exp* indicates. The absolute value of *m*, however, is 0.5 or more and less than 1.0.
- If *x* is non-numeric, NaN is returned and the value of \**exp* is 0.
- If *x* is  $\pm \infty$ , NaN is returned, and EDOM is set to *errno* with the value of \**exp* as 0.
- If *x* is  $\pm 0$ ,  $\pm 0$  is returned and the value of \**exp* is 0.

**ldexpf (normal model only)**

Finds  $x * 2^{exp}$

**[Syntax]**

```
#include <math.h>
float ldexpf (float x , int exp) ;
```

**[Argument(s)/Return value]**

Argument	Return Value
<p><i>x</i> : Numeric value to perform operation</p> <p><i>exp</i> : Exponentiation</p>	<p>Normal : <math>x * 2^{exp}</math></p> <p>When <math>x = \text{NaN}</math> : NaN</p> <p>When <math>x = \pm \infty</math> : <math>\pm \infty</math></p> <p>When <math>x = \pm 0</math> : <math>\pm 0</math></p> <p>When overflow occurs : HUGE_VAL (with the sign of overflown value)</p> <p>When underflow occurs : Non-normalized number</p> <p>When annihilation of valid digits occurs due to underflow : <math>\pm 0</math></p>

**[Description]**

- Calculates  $x * 2^{exp}$ .
- If  $x$  is non-numeric, NaN is returned. If  $x$  is  $\pm \infty$ ,  $\pm \infty$  is returned. If  $x$  is  $\pm 0$ ,  $\pm 0$  is returned.
- If overflow occurs as a result of operation, HUGE\_VAL with the sign of overflown value is returned and ERANGE is set to errno.
- If underflow occurs as a result of operation, non-normalized number is returned .
- If annihilation of valid digits due to underflow occurs as a result of operation,  $\pm 0$  is returned.

**logf (normal model only)**

Finds the natural logarithm

**[Syntax]**

```
#include <math.h>
float logf (float x) ;
```

**[Argument(s)/Return value]**

Argument	Return Value
<p><b>x :</b> Numeric value to perform operation</p>	<p>Normal : Natural logarithm of x</p> <p>When <math>x \leq 0</math> : HUGE_VAL (with negative sign)</p> <p>When <math>x = \text{NaN}</math> : NaN</p> <p>When <math>x</math> is infinite : <math>+\infty</math></p>

**[Description]**

- Finds natural logarithm of x.
- In the case of area error of  $x < 0$ , HUGE\_VAL with a negative sign is returned, and EDOM is set to errno.
- If  $x = 0$ , HUGE\_VAL with a negative sign is returned, and ERANGE is set to errno.
- If x is non-numeric, NaN is returned.
- If x is  $+\infty$ ,  $+\infty$  is returned.

**log10f (normal model only)**

Finds the base 10 logarithm

**[Syntax]**

```
#include <math.h>
float log10f (float x) ;
```

**[Argument(s)/Return value]**

Argument	Return Value
<p><b>x :</b> Numeric value to perform operation</p>	<p>Normal : Logarithm with 10 of x as the base</p> <p>When <math>x \leq 0</math> : HUGE_VAL (with negative sign)</p> <p>When <math>x = \text{NaN}</math> : NaN</p> <p>When <math>x = +\infty</math> : <math>+\infty</math></p>

**[Description]**

- Finds logarithm with 10 of x as the base.
- In the case of area error of  $x < 0$ , HUGE\_VAL with a negative sign is returned, and EDOM is set to errno.
- If  $x = 0$ , HUGE\_VAL with a negative sign is returned, and ERANGE is set to errno.
- If x is non-numeric, NaN is returned.
- If x is  $+\infty$ ,  $+\infty$  is returned.

**modff (normal model only)**

Finds the decimal and integer parts

**[Syntax]**

```
#include <math.h>
float modff (float x , float *iptr );
```

**[Argument(s)/Return value]**

Argument	Return Value
<p><i>x</i> :</p> <p>Numeric value to perform operation</p> <p><i>iptr</i> :</p> <p>Pointer to integer part</p>	<p>Normal :</p> <p>Fraction part of <i>x</i></p> <p>When <i>x</i> = NaN, <i>x</i> is infinite :</p> <p>NaN</p> <p>When <i>x</i> = ± 0 :</p> <p>± 0</p>

**[Description]**

- Divides a floating point number *x* to fraction part and integer part.
- Returns fraction part with the same sign as that of *x*, and stores integer part to location indicated by the pointer *iptr*.
- If *x* is non-numeric, NaN is returned and stored location indicated by the pointer *iptr*.
- If *x* is infinite, NaN is returned and stored location indicated by the pointer *iptr*, and EDOM is set to errno.
- If *x* = ± 0, ± 0 is returned and stored location indicated by the pointer *iptr*.

**powf (normal model only)**

Finds yth power of x

**[Syntax]**

```
#include <math.h>
float powf (float x , float y) ;
```

**[Argument(s)/Return value]**

Argument	Return Value
<p><b>x :</b> Numeric value to perform operation</p> <p><b>y :</b> Multiplier</p>	<p>Normal :</p> <p style="padding-left: 20px;"><math>x^y</math></p> <p>Either when</p> <p style="padding-left: 20px;"><math>x = \text{NaN}</math> or <math>y = \text{NaN}</math></p> <p style="padding-left: 20px;"><math>x = +\infty</math> and <math>y = 0</math></p> <p style="padding-left: 20px;"><math>x &lt; 0</math> and <math>y \neq \text{integer}</math>,</p> <p style="padding-left: 20px;"><math>x &lt; 0</math> and <math>y = \pm \infty</math></p> <p style="padding-left: 20px;"><math>x = 0</math> and <math>y \leq 0</math> :</p> <p style="padding-left: 40px;">NaN</p> <p>When overflow occurs :</p> <p style="padding-left: 40px;">HUGE_VAL (with the sign of overflown value)</p> <p>When underflow occurs :</p> <p style="padding-left: 40px;">Non-normalized number</p> <p>When annihilation of valid digits occurs due to underflow :</p> <p style="padding-left: 40px;"><math>\pm 0</math></p>

**[Description]**

- Calculates  $x^y$ .
- When  $x = \text{NaN}$  or  $y = \text{NaN}$ , NaN is returned.
- Either when  $x = +\infty$  and  $y = 0$ ,  $x < 0$  and  $y \neq \text{integer}$ ,  $x < 0$  and  $y = \pm \infty$ , or  $x = 0$  and  $y \leq 0$ , NaN is returned and EDOM is set to errno.
- If overflow occurs as a result of operation, HUGE\_VAL with the sign of overflown value is returned, and ERANGE is set to errno.
- If underflow occurs, a non-normalized number is returned.
- If annihilation of valid digits occurs due to underflow,  $\pm 0$  is returned.

**sqrtf (normal model only)**

Finds the square root

**[Syntax]**

```
#include <math.h>
float sqrtf (float x) ;
```

**[Argument(s)/Return value]**

Argument	Return Value
<p><i>x</i> :</p> <p>Numeric value to perform operation</p>	<p>When <math>x \geq 0</math> :</p> <p>Square root of <math>x</math></p> <p>When <math>x &lt; 0</math> :</p> <p>0</p> <p>When <math>x = \text{NaN}</math> :</p> <p>NaN</p> <p>When <math>x = \pm 0</math> :</p> <p><math>\pm 0</math></p>

**[Description]**

- Calculates the square root of  $x$ .
- In the case of area error of  $x < 0$ , 0 is returned and EDOM is set to errno.
- If  $x$  is non-numeric, NaN is returned.
- If  $x$  is  $\pm 0$ ,  $\pm 0$  is returned.

**ceilf (normal model only)**

Finds the smallest integer not smaller than  $x$

**[Syntax]**

```
#include <math.h>
float ceilf (float x) ;
```

**[Argument(s)/Return value]**

Argument	Return Value
<p><math>x</math> :</p> <p>Numeric value to perform operation</p>	<p>Normal :</p> <p>The minimum integer no less than <math>x</math></p> <p>When <math>x = \text{NaN}</math>, <math>x</math> is infinite :</p> <p>NaN</p> <p>When <math>x = -0</math> :</p> <p>+0</p> <p>When the minimum integer no less than <math>x</math> cannot be expressed :</p> <p><math>x</math></p>

**[Description]**

- Finds the minimum integer no less than  $x$ .
- If  $x$  is non-numeric, NaN is returned.
- If  $x$  is -0, +0 is returned.
- If  $x$  is infinite, NaN is returned and EDOM is set to errno.
- If the minimum integer no less than  $x$  cannot be expressed,  $x$  is returned.



**fabsf (normal model only)**

Finds the absolute value of floating point number x

**[Syntax]**

```
#include <math.h>
float fabsf (float x) ;
```

**[Argument(s)/Return value]**

Argument	Return Value
x : Numeric value to find the absolute value	Normal : Absolute value of x When x is non-numeric : NaN When x = -0 : +0

**[Description]**

- Finds the absolute value of x.
- If x is non-numeric, NaN is returned.
- If x is -0, +0 is returned.

**floorf (normal model only)**

Finds the largest integer not larger than x

**[Syntax]**

```
#include <math.h>
float floorf (float x) ;
```

**[Argument(s)/Return value]**

Argument	Return Value
<p>x :</p> <p>Numeric value to perform operation</p>	<p>Normal :</p> <p>The maximum integer no more than x</p> <p>When x = NaN, x is infinite :</p> <p>NaN</p> <p>When x = -0 :</p> <p>+0</p> <p>When the maximum integer no more than x cannot be expressed :</p> <p>x</p>

**[Description]**

- Finds the maximum integer no more than x.
- If x is non-numeric, NaN is returned.
- If x is infinite, NaN is returned and EDOM is set to errno.
- If x is -0, +0 is returned.
- If the maximum integer no more than x cannot be expressed, x is returned.

**fmodf (normal model only)**

Finds the remainder of x/y

**[Syntax]**

```
#include <math.h>
float fmodf (float x , float y) ;
```

**[Argument(s)/Return value]**

Argument	Return Value
<p><b>x :</b> Numeric value to perform operation</p> <p><b>y :</b> Numeric value to perform operation</p>	<p>Normal : Remainder of x/y</p> <p>When <math>y</math> is <math>\pm 0</math> or <math>x</math> is <math>\pm \infty</math>, When <math>x</math> is non-numeric or <math>y</math> is non-numeric : NaN</p> <p>When <math>x \neq \infty</math> and <math>y = \pm \infty</math> : <math>x</math></p>

**[Description]**

- Calculates the remainder of x/y expressed with  $x - i * y$ .  $i$  is an integer.
- If  $y \neq 0$ , the return value has the same sign as that of  $x$  and the absolute value is less than  $y$ .
- If  $y$  is  $\pm 0$  or  $x = \pm \infty$ , NaN is returned and EDOM is set to errno.
- If  $x$  is non-numeric or  $y$  is non-numeric, NaN is returned.
- If  $y$  is infinite,  $x$  is returned unless  $x$  is infinite.

### 6.12 Diagnostic Function

The following diagnostic function is available.

Function Name	Purpose
<a href="#">__assertfail (normal model only)</a>	Supports the assert macro

**\_\_assertfail (normal model only)**

Supports the assert macro

**[Syntax]**

```
#include <assert.h>
int __assertfail (char * __msg , char * __cond , char * __file , int __line) ;
```

**[Argument(s)/Return value]**

Argument	Return Value
<p><b>__msg :</b> Pointer to character string to indicate output conversion specification to be passed to printf function</p> <p><b>__cond :</b> Actual argument of assert macro</p> <p><b>__file :</b> Source file name</p> <p><b>__line :</b> Source line number</p>	Undefined

**[Description]**

- A \_\_assertfail function receives information from assert macro (see [6.3.13 assert.h \(normal model only\)](#)), calls printf function, outputs information, and calls abort function.
- An assert macro adds diagnostic function to a program.

When an assert macro is executed, if p is false (equal to 0), an assert macro passes information related to the specific call that has brought the false value (actual argument text, source file name, and source line number are included in the information. The other two are the values of macro `__FILE__` and `__LINE__`, respectively) to `__assertfail` function.

**6.13 Library Stack Consumption List**

This section explains the number of stacks consumed for each function in the libraries.

**6.13.1 Standard libraries**

The number of stacks consumed for each standard library stack function is displayed in the tables below.

**(1) ctype.h**

Function Name	Normal Model	Static Model
isalpha	0	0
isupper	0	0
islower	0	0
isdigit	0	0
isalnum	0	0
isxdigit	0	0
isspace	0	0
ispunct	0	0
isprint	0	0
isgraph	0	0
iscntrl	0	0
isascii	0	0
toupper	0	0
tolower	0	0
toascii	0	0
_toupper	0	0
toup	0	0
_tolower	0	0
tolow	0	0

**(2) setjmp.h**

Function Name	Normal Model	Static Model
setjmp	4	4
longjmp	2	2

**(3) stdarg.h (normal model only)**

Function Name	Normal Model	Static Model
va_arg	0	-
va_start	0	-
va_starttop	0	-

Function Name	Normal Model	Static Model
va_end	0	-

**(4) stdio.h**

Function Name	Normal Model	Static Model
sprintf	52 (72) <sup>Note</sup>	-
sscanf	290 (304) <sup>Note</sup>	-
printf	54 (72) <sup>Note</sup>	-
scanf	294 (304) <sup>Note</sup>	-
vprintf	52 (72) <sup>Note</sup>	-
vsprintf	52 (72) <sup>Note</sup>	-
getchar	0	0
gets	6	6
putchar	0	0
puts	4	4

**Note** Values in parentheses are for when the version that supports floating-point numbers is used.

**(5) stdlib.h**

Function Name	Normal Model	Static Model
atoi	4	2
atol	10	-
strtol	18	-
strtoul	18	-
calloc	14	14
free	8	8
malloc	6	6
realloc	10	12
abort	0	0
atexit	0	0
exit	2 + n <sup>Note 1</sup>	2 + n <sup>Note 1</sup>
abs	0	0
labs	6 (3) <sup>Note 2</sup>	-
div	2	-
ldiv	14	-
brk	0	0
sbrk	4	4
atof	35	-

Function Name	Normal Model	Static Model
strtod	35	-
itoa	10	10
ltoa	16	-
ultoa	16	-
rand	14 (15) <sup>Note 2</sup>	-
srand	0	-
bsearch	32 + n <sup>Note 3</sup>	-
qsort	16 + n <sup>Note 4</sup>	-
strbrk	0	0
strsbrk	4	4
strtoa	10	10
strltoa	16	-
strultoa	16	-

- Notes**
1. n is the total stack consumption among external functions registered by the atexit function.
  2. Values in the parentheses are for when a multiplier/divider is used.
  3. n is the stack consumption of external functions called from bsearch.
  4. n is (20+ (stack consumption of external functions called from qsort) ) - (1 + (number of recursive calls) ).

#### (6) string.h

Function Name	Normal Model	Static Model
memcpy	4	6
memmove	4	6
strcpy	2	4
strncpy	4	6
strcat	2	4
strncat	4	6
memcmp	2	4
strcmp	2	2
strncmp	2	4
memchr	2	2
strchr	4	0
strrchr	6	6
strspn	4	4
strcspn	4	4
stpbrk	6	6
strstr	4	4
strtok	4	4



Function Name	Normal Model	Static Model
memset	4	4
strerror	0	0
strlen	0	0
strcoll	2	2
strxfrm	4	4

**(7) math.h (normal model only)**

Function Name	Normal Model	Static Model
acos	22	-
asin	22	-
atan	22	-
atan2	23	-
cos	24 (34) <sup>Note</sup>	-
sin	24 (34) <sup>Note</sup>	-
tan	28 (34) <sup>Note</sup>	-
cosh	24	-
sinh	27	-
tanh	32	-
exp	24	-
frexp	2 (10) <sup>Note</sup>	-
ldexp	2 (10) <sup>Note</sup>	-
log	24 (34) <sup>Note</sup>	-
log10	22 (32) <sup>Note</sup>	-
modf	2 (10) <sup>Note</sup>	-
pow	26 (36) <sup>Note</sup>	-
sqrt	16	-
ceil	2 (10) <sup>Note</sup>	-
fabs	0	-
floor	2 (10) <sup>Note</sup>	-
fmod	2 (10) <sup>Note</sup>	-
matherr	0	-
acosf	22	-
asinf	22	-
atanf	22	-
atan2f	23	-
cosf	24 (34) <sup>Note</sup>	-
sinf	24 (34) <sup>Note</sup>	-

Function Name	Normal Model	Static Model
tanf	28 (34) <sup>Note</sup>	-
coshf	24	-
sinhf	27	-
tanhf	32	-
expf	24	-
frexpf	2 (10) <sup>Note</sup>	-
ldexpf	2 (10) <sup>Note</sup>	-
logf	24 (34) <sup>Note</sup>	-
log10f	22 (32) <sup>Note</sup>	-
modff	2 (10) <sup>Note</sup>	-
powf	26 (36) <sup>Note</sup>	-
sqrtf	16	-
ceilf	2 (10) <sup>Note</sup>	-
fabsf	0	-
floorf	2 (10) <sup>Note</sup>	-
fmodf	2 (10) <sup>Note</sup>	-

**Note** Values in parentheses are for when an operation exception occurs.

#### (8) assert.h (normal model only)

Function Name	Normal Model	Static Model
__assertfail	64 (82) <sup>Note</sup>	-

**Note** Values in parentheses are for when the printf version that supports floating-point numbers is used.

### 6.13.2 Runtime libraries

The number of stacks consumed for each runtime library function is shown in the tables below.

#### (1) Increment

Function Name	Normal Model	Static Model
lsinc	0	-
luinc	0	-
finc	16 (26) <sup>Note</sup>	-

**Note** Values in parentheses are for when a math exception occurs (when the matherr function supplied with the compiler is used).

**(2) Decrement**

Function Name	Normal Model	Static Model
lsdec	0	-
ludec	0	-
fdec	16 (26) <sup>Note</sup>	-

**Note** Values in parentheses are for when a math exception occurs (when the matherr function supplied with the compiler is used).

**(3) Sign reverse**

Function Name	Normal Model	Static Model
lsrev	0	-
lurev	0	-
frev	0	-

**(4) 1's complement**

Function Name	Normal Model	Static Model
lscm	0	-
lucom	0	-

**(5) Logical NOT**

Function Name	Normal Model	Static Model
lsnot	0	-
lunot	0	-
fnot	0	-

**(6) Multiply**

Function Name	Normal Model	Static Model
csmul	2 <sup>Note 1</sup>	2 <sup>Note 1</sup>
cumul	2 <sup>Note 1</sup>	2 <sup>Note 1</sup>
ismul	6 (1) <sup>Note 1</sup>	6 (1) <sup>Note 1</sup>
iumul	6 (1) <sup>Note 1</sup>	6 (1) <sup>Note 1</sup>
lsmul	6 (7) <sup>Note 1</sup>	-
lumul	6 (7) <sup>Note 1</sup>	-
fmul	10 (20) <sup>Note 2</sup>	-

**Notes 1.** Values in the parentheses are for when a multiplier/divider is used.  
**2.** Values in parentheses are for when an operation exception occurs .

**(7) Divide**

Function Name	Normal Model	Static Model
csdiv	8	8
cudiv	2	2
isdiv	10 (3) <sup>Note 1</sup>	12 (3) <sup>Note 1</sup>
iudiv	6 (1) <sup>Note 1</sup>	6 (1) <sup>Note 1</sup>
lsdiv	10	-
ludiv	6	-
fdiv	10 (20) <sup>Note 2</sup>	-

- Notes 1.** Values in parentheses are for when integrated multiplier/divider is used.  
**2.** Values in parentheses are for when a math exception occurs (when the matherr function supplied with the compiler is used).

**(8) Remainder**

Function Name	Normal Model	Static Model
csrem	8	10
curem	2	4
isrem	10 (3) <sup>Note</sup>	12 (3) <sup>Note</sup>
iurem	6 (1) <sup>Note</sup>	6 (1) <sup>Note</sup>
lsrem	10	-
lurem	6	-

**Note** Values in parentheses are for when integrated multiplier/divider is used.

**(9) Add**

Function Name	Normal Model	Static Model
lsadd	0	-
luadd	0	-
fadd	10 (20) <sup>Note</sup>	-

**Note** Values in parentheses are for when an operation exception occurs.

**(10) Subtract**

Function Name	Normal Model	Static Model
lssub	0	-
lusub	0	-
fsub	10 (20) <sup>Note</sup>	-

**Note** Values in parentheses are for when an operation exception occurs.

**(11) Shift left**

Function Name	Normal Model	Static Model
lslsh	2	-
lulshF	2	-

**(12) Shift right**

Function Name	Normal Model	Static Model
lsrsh	2	-
lursh	2	-

**(13) Compare**

Function Name	Normal Model	Static Model
cscmp	0	2
iscmp	2	2
lscmp	2	-
lucmp	2	-
fcmp	4 (16) <sup>Note</sup>	-

**Note** Values in parentheses are for when an operation exception occurs.

**(14) Bit AND**

Function Name	Normal Model	Static Model
lsband	0	-
luband	0	-

**(15) Bit OR**

Function Name	Normal Model	Static Model
lsbor	0	-
lubor	0	-

**(16) Bit XOR**

Function Name	Normal Model	Static Model
lsbxor	0	-
lubxor	0	-

**(17) Logical AND**

Function Name	Normal Model	Static Model
fand	0	-

**(18) Logical OR**

Function Name	Normal Model	Static Model
for	0	-

**(19) Conversion from floating point number**

Function Name	Normal Model	Static Model
ftols	8	-
ftolu	8	-

**(20) Conversion to floating point number**

Function Name	Normal Model	Static Model
lstof	12 (22) <sup>Note</sup>	-
lutof	12 (22) <sup>Note</sup>	-

**Note** Values in parentheses are for when a math exception occurs (when the matherr function supplied with the compiler is used).

**(21) Conversion from bit**

Function Name	Normal Model	Static Model
btol	0	-

**(22) Startup routine**

Function Name	Normal Model	Static Model
cstart	2	2

**(23) Pre- and post-processing of function**

Function Name	Normal Model	Static Model
cprep	2 + n <sup>Note</sup>	-
cdisp	0	-
cprep2	Size of automatic variable + register variable	-
cdisp2	0	-
nrcp2	-	0

Function Name	Normal Model	Static Model
nrcp3	-	0
krcp2	-	0
krcp3	-	0
nkrc3	-	0
nrip2	-	0
nrip3	-	0
krip2	-	0
krip3	-	0
nkri31	-	0
nkri32	-	0
nrsave	-	8
nrload	-	0
krs02	-	2
krs04	-	4
krs04i	-	4
krs06	-	6
krs06i	-	6
krs08	-	8
krs08i	-	8
krs10	-	10
krs10i	-	10
krs12	-	12
krs12i	-	12
krs14	-	14
krs14i	-	14
krs16	-	16
krs16i	-	16
krl02	-	0
krl04	-	0
krl04i	-	0
krl06	-	0
krl06i	-	0
krl08	-	0
krl08i	-	0
krl10	-	0
krl10i	-	0
krl12	-	0

Function Name	Normal Model	Static Model
kr12i	-	0
kr14	-	0
kr14i	-	0
kr16	-	0
kr16i	-	0
hdwinit	0	0

**Note** n is a size of the secured automatic variable.

#### (24) Bank function

Function Name	Normal Model	Static Model
bcall	6	-
bcals	6	-

#### (25) BCD-type conversion

Function Name	Normal Model	Static Model
bcdtob	4	4
btobcd	4	4
bcdtow	4	4
wtobcd	6	6
bbcd	4	4

#### (26) Auxiliary

Function Name	Normal Model	Static Model
mulu	4	4
mulue	4	4
divuw	6	6
divuwe	6	6
addwbc	0	0
clra0	0	0
clra1	0	0
clrx0	0	0
clrax0	0	0
clrax1	-	0
clrbc0	0	-
clrbc1	0	-
cmpa0	0	0



Function Name	Normal Model	Static Model
cmpa1	0	0
cmpc0	0	-
cmpax1	0	0
ctoi	0	0
uctoi	0	0
maxde	0	0
mdeax	0	0
incde	0	0
decde	0	0
maxhl	0	0
mhlax	0	0
incl	0	0
dechl	0	0
shl4	0	0
shr4	0	0
swap4	0	0
tableh	0	0
apdech	0	0
apinch	0	0
incwhl	0	0
decwhl	0	0
dellab	0	-
dell03	0	-
della4	0	-
delsab	0	-
dels03	0	-
hlllab	0	-
hlll03	0	-
hllla4	0	-
hllsab	0	-
hlls03	0	-
dn2in	0	-
dn2de	0	-
dn4in	0	-
dn4ip	2	-
dn4de	0	-
dn4dp	2	-

Function Name	Normal Model	Static Model
_inha	11	-
_inah	11	-
_lnha	11	-
_lnh0	11	-
_lnh4	11	-
_lnah	11	-
_ln0h	11	-
_hn1in	11	-
_hn1de	11	-
_hn2in	11	-
_hn2de	11	-
_hn4in	11	-
_hn4ip	11	-
_hn4de	11	-
_hn4dp	11	-

#### 6.14 List of Maximum Interrupt Disabled Times for Libraries

For libraries that use a multiplier/divider, a period of time during which an interrupt is disabled is provided in order that the contents of the operation are not destroyed during an interrupt.

The maximum interrupt disabled times for libraries that use a multiplier/divider are shown below.

No periods during which an interrupt is disabled are provided for libraries that do not use a multiplier/divider.

**Table 6-2. Maximum Interrupt Disabled Time (Number of Clocks) for Libraries**

Classification	Function Name	Model supported		Remark
		Normal Model	Static Model	
Multiplication	@@ismul	75	73	Performs multiplication between signed int data
	@@iumul	75	73	Performs multiplication between unsigned int data
	@@lsmul	85	-	Performs multiplication between signed long data
	@@lumul	85	-	Performs multiplication between unsigned long data
Division	@@isdiv	107	105	Performs division between signed int data
	@@iudiv	85	83	Performs division between unsigned int data
Remainder	@@isrem	107	105	Obtains remainder after division between signed int data
	@@iurem	85	83	Obtains remainder after division between unsigned int data

Classification	Function Name	Model supported		Remark
		Normal Model	Static Model	
stdlib.h	div	183	-	
	rand	85	-	@ @lumul is used.
	qsort	75	73	@ @iumul is used.

### 6.15 Batch Files for Update of Startup Routine and Library Functions

The 78K0 C compiler provides batch files for updating a portion of the standard library functions and the startup routine. The batch files in the bat folder are shown in the table below.

**Table 6-3. Batch Files for Updating Library Functions**

Batch File	Application
mkstup.bat	Updates the startup routine (cstart*.asm). When changing the startup routine, perform assembly using this batch file.
reprom.bat	Updates the firmware ROMization termination routine (rom.asm). When changing rom.asm, update the library using this batch file.
repgetc.bat	Updates the getchar function. The default assumption sets P0 of the SFR to the input port. When it is necessary to change this setting, change the defined value of EQU of PORT in getchar.asm and update the library using this batch file.
repputc.bat	Updates the putchar function. The default assumption sets P0 of the SFR to the output port. When it is necessary to change this setting, change the defined value of EQU of PORT in getchar.asm and update the library using this batch file.
repputcs.bat	Updates the putchar function to SM78K0 for C compiler-compatibility. When it is necessary to check the output of the putchar function using the SM78K0 for C compiler, update the library using this batch file.
repselo.bat	Saves/restores the reserved area of the compiler (_@KREGxx) as part of the save/restore processing of the setjmp and longjmp functions (the default assumption is to not save/restore). Update the library using this batch file when the -qr option is specified.
repselon.bat	Does not save/restore the reserved area of the compiler (_@KREGxx) as part of the save/ restore processing of the setjmp and longjmp functions (the default assumption is to not save/ restore). Update the library using this batch file when the -qr option is not specified.
repvect.bat	Updates the address value setting processing of the branch table of the interrupt vector table allocated in the flash area (vect*.asm). The default assumption sets the top address of the flash area branch table to 2000H. When it is necessary to change this setting, change the defined value of EQU of ITBLTOP in vect.inc and update the library using this batch file.

Batch File	Application												
repmudiu.bat	<p>Updates the standard library (div) and runtime libraries (@@ismul, @@iumul, @@lsmul, @@lumul, @@isdiv, @@iudiv, @@isrem, @@iurem) in the multiplier/divider library.</p> <p>By default, the library is designed to work with devices in which multiplier/divider SFR registers are assigned to the following addresses.</p> <p>If you are using a device that assigns multiplier/divider SFR registers to different addresses, specify the device and use this batch file to update the library.</p> <table border="1" data-bbox="475 539 1343 786"> <thead> <tr> <th>SFR Name</th> <th>Address</th> </tr> </thead> <tbody> <tr> <td>SDR0</td> <td>0FF60H</td> </tr> <tr> <td>MDA0L</td> <td>0FF62H</td> </tr> <tr> <td>MDA0H</td> <td>0FF64H</td> </tr> <tr> <td>MDB0</td> <td>0FF66H</td> </tr> <tr> <td>DMUC0</td> <td>0FF68H</td> </tr> </tbody> </table>	SFR Name	Address	SDR0	0FF60H	MDA0L	0FF62H	MDA0H	0FF64H	MDB0	0FF66H	DMUC0	0FF68H
SFR Name	Address												
SDR0	0FF60H												
MDA0L	0FF62H												
MDA0H	0FF64H												
MDB0	0FF66H												
DMUC0	0FF68H												

**6.15.1 Using batch files**

Use the batch files in the subfolder bat.

Because these files are the batch files used to activate the assembler and librarian, the assembler etc. bundled to CubeSuite are necessary. Before using the batch files, set the folder that contains the 78K0 assembler execution format file using the environment variable PATH.

Create a subfolder (lib) of the same level as bat for the batch files and put the post-assembly files in this subfolder. When a C startup routine or library is installed in a subfolder lib that is the same level as bat, these files are overwritten.

Files assembled with the batch files are output to Src\cc78k0\lib. Copy these files to the lib78k0 directory before linking.

To use the batch files, move the current folder to the subfolder bat and execute each batch file. To perform execution, the following parameters are necessary.

Product type = chiptype (classification of target chip)

F051144 : uPD78F051144etc.

The following is an illustration of how to use each batch file.

**(1) Startup routine**

```
mkstup chiptype
```

Example below.

```
mkstup F051144
```

**(2) Firmware ROMization routine update**

```
reprom chiptype multiply/divide instruction existence
```

Example below.

```
reprom F051144 use
```

**(3) getchar function updat**

```
regetc chitype multiply/divide instruction existence
```

Example below.

```
regetc F051144 use
```

**(4) putcharfunction update**

```
reputc chitype multiply/divide instruction existence
```

Example below.

```
reputc F051144 use
```

**(5) putchar function (SM78K0-supporting) update**

```
reputcs chitype multiply/divide instruction existence
```

Example below.

```
reputcs F051144 use
```

**(6) setjmp/longjmp function update (with restore/save processing)**

```
repselo chitype multiply/divide instruction existence
```

Example below.

```
repselo F051144 use
```

**(7) setjmp/longjmp function update (without restore/save processing)**

```
repselon chitype multiply/divide instruction existence
```

Example below.

```
repselon F051144 use
```

**(8) Interrupt vector table update**

```
repvect chiptype multiply/divide instruction existence
```

Example below.

```
repvect F051144 use
```

**(9) Multiplication and division use library update**

```
repmudiu.bat chiptype
```

Example below.

```
repmudiu.bat F051144
```

CHAPTER 7 STARTUP

This chapter explains the startup routine.

7.1 Function Overview

To execute a C language program, a program is needed to handle ROMization for inclusion in the system and to start the user program (main function). This program is called the startup routine.

To execute a user program, a startup routine must be created for that program. The CA78K0 provides standard startup routine object files, which carry out the processing required before program execution, and the startup routine source files (assembly source), which the user can adapt to the system. By linking the startup routine object file to the user program, an executable program can be created without requiring the user to write an original execution preprocessing routine.

This chapter describes the contents and uses of the startup routine and explains how to adapt it for your system.

7.2 File Organization

The files related to a startup routine are stored in the folder Src\cc78k0 of the C compiler package.

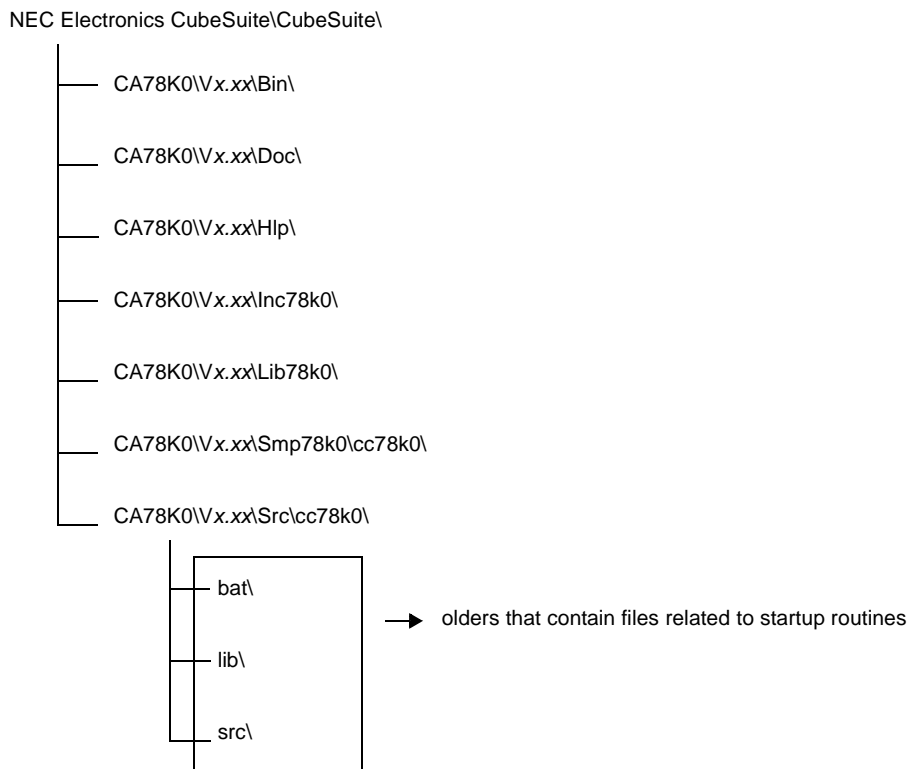

The contents of the folders under Src\cc78k0 are shown next.

7.2.1 "bat" folder contents

Batch file in this folder cannot be used in the IDE.

Use these batch files only when a source file, such as for the startup routine, must be modified.

Table 7-1. "bat" Folder Contents

Batch File Name	Explanation
mkstup.bat	Assemble batch file for startup routine
reprom.bat	Batch file for updating rom.asm <sup>Note 1</sup>
repgetc.bat	Batch file for updating getchar.asm
repputc.bat	Batch file for updating putchar.asm
repputcs.bat	Batch file for updating _putchar.asm
repselo.bat	Batch file for updating setjmp.asm and longjmp.asm (the compiler reserved area is saved) <sup>Note 2</sup>
repselon.bat	Batch file for updating setjmp.asm, longjmp.asm (the compiler reserved area is not saved) <sup>Note 2</sup>
repvect.bat	Batch file for updating vect*.asm
repmudiu.bat	Batch file for updating the multiplier/divider library

- Notes 1.** Since ROMization routines are in the library, the library is also updated by this batch file.
- 2.** setjmp and longjmp functions that save the compiler reserved area (saddr area secured for KREGxx, etc.), and setjmp and longjmp functions that do not save the compiler reserved area (only registers are saved) are created.

7.2.2 "lib" folder contents

The lib folder contains the object files that were assembled from the source files of the startup routine and libraries. These object files can be linked with programs for any 78K0 target device. If code modifications are not especially needed, link the default object files as is. The object files are overwritten when batch file mkstup.bat, which is provided by the CA78K0, is executed.

Table 7-2. "lib" folder Contents

File Name			File Role
Normal	Boot Area	Flash Area	
cl00.lib cl00r.lib cl00sm.lib cl00f.lib	cl00.lib cl00r.lib cl00sm.lib cl00f.lib	cl00e.lib cl00re.lib cl00sme.lib cl00fe.lib	Library (runtime and standard libraries) <sup>Note 1</sup> (without multiply/divide instruction)
cl0.lib cl0r.lib cl0sm.lib cl0f.lib cl0x.lib cl0xr.lib cl0xsm.lib	cl0.lib cl0r.lib cl0sm.lib cl0f.lib cl0x.lib cl0xr.lib cl0xsm.lib	cl0e.lib cl0re.lib cl0sme.lib cl0fe.lib cl0xe.lib cl0xre.lib cl0xsme.lib	Library (runtime and standard libraries) <sup>Note 1</sup> (with multiply/divide instruction)



File Name			File Role
Normal	Boot Area	Flash Area	
s0.rel	s0b.rel	s0e.rel	Object files for startup routines <sup>Note 2</sup>
s0l.rel	s0lb.rel	s0le.rel	
s0sm.rel	s0smb.rel	s0sme.rel	
s0sml.rel	s0smlb.rel	s0smle.rel	

**Notes 1.** The rule for naming libraries is given below.

```
lib78k0\c10<mul/div><model><float><pascal><flash>.lib
```

<mul/div>

None : Multiplier/divider not used  
x : Multiplier/divider used

<model>

None : Normal model  
sm : Static model

<float>

None : Standard library and runtime library (floating point library is not used)  
f : For floating point library

<pascal>

None : When normal function interface is used  
r : When pascal function interface is used (when compile option -zr is specified)

<flash>

None : For normal/boot area  
e : For flash memory area

**2.** The rule for naming startup routines is given below.

```
lib78k0\s0<model><lib><flash>.rel
```

<model>

None : Normal model  
sm : Static model

<lib>

None : When standard library functions are not used  
l : When standard library functions are used

<flash>

None : Normal  
b : For boot area  
e : For flash memory area

The 78K0 C compiler libraries are compatible with the following multiplier/divider devices.

However, if an interrupt occurs while computation is in progress, some of the computation results are disabled from being interrupted so that they are not corrupted.

See "6.14 List of Maximum Interrupt Disabled Times for Libraries" regarding library functions and interrupt disable times.

The special function registers is given below.

Function	Reserved Words	Addresses	Size
Remainder data register 0	SDR0	FF60H	16 bit
Multiplication/division data register A0	MDA0H, MDA0L	FF64H, FF62H	16 bit x 2
Multiplication/division data register B0	MDB0	FF66H	16 bit
Multiplier/divider control register 0	DMUC0	FF68H	8 bit

- Register configuration when multiplying

$$\begin{matrix} < \text{Multiplier A} > & & < \text{Multiplier B} > & & < \text{Product} > \\ \text{MDA0 (bits 15 to 0)} \times \text{MDB0 (bits 15 to 0)} = & & & & & \text{MDA0 (bits 31 to 0)} \end{matrix}$$

- Register configuration when dividing

$$\begin{matrix} < \text{Dividend} > & & < \text{Divisor} > & & < \text{Quotient} > & & < \text{Remainder} > \\ \text{MDA0 (bits 31 to 0)} \div \text{MDB0 (bits 15 to 0)} = & & & & & \text{MDA0 (bits 31 to 0)} \dots \text{SDR0 (bits 15 to 0)} \end{matrix}$$

- Multiplier/Divider control register 0

7	6	5	4	3	2	1	0
DMUE	0	0	0	0	0	0	DMUSEL0

DMUE : Stopping of calculating operations (0) / starting (1)

DMUSEL0 : Division mode (0) / multiplication mode (1)

**Remark** For a bit number enclosed in a square, the bit name is defined as a reserved word in the 78K0 assembler, and is defined as an sfr variable using the #pragma sfr directive in the 78K0 C compiler.

### 7.2.3 "src" folder contents

The src folder contains the assembler source files of the startup routines, ROM routines, error processing routines, and standard library functions (a portion). If the source must be modified to conform to the system, the object files for linking can be created by modifying this assembler source and using a batch file in the bat folder to assemble.

**Table 7-3. "src" Folder Contents**

Startup Routine Source File Name	Explanation
cstart.asm <sup>Note</sup>	Source file for startup routine (when standard library is used)
cstartn.asm <sup>Note</sup>	Source file for startup routine (when standard library is not used)
rom.asm	Source file for ROMization routine
_putchar.asm	_putchar function
putchar.asm	putchar function
getchar.asm	getchar function
longjmp.asm	longjmp function

Startup Routine Source File Name	Explanation
setjmp.asm	setjmp function
vectxx.asm	Vector source for each interrupt (xx : vector address)
def.inc	For setting library according to type
macro.inc	Macro definition for each typical pattern
vect.inc	Start address of flash memory area branch table
library.inc	Selection of library assigned to boot area explicitly
xdiv.asm	div function (with multiplier/divider used)
ximul.asm	@ @ismul, @ @iumul function (with multiplier/divider used)
xlmul.asm	@ @ismul, @ @lumul function (with multiplier/divider used)
xisdiv.asm	@ @isdiv function (with multiplier/divider used)
xiudiv.asm	@ @iudiv function (with multiplier/divider used)
xisrem.asm	@ @isrem function (with multiplier/divider used)
xiurem.asm	@ @iurem function (with multiplier/divider used)

**Note** A file name with "n" added is a startup routine that does not have standard library processing. Use only if the standard library will not be used. Additionally, boot area startup routines are named cstartb\*.asm, and flash area startup routines are named cstarte\*.asm.

### 7.3 Batch File Description

This section explains batch file.

#### 7.3.1 Batch files for creating startup routines

The mkstup.bat in the bat folder is used to create the object file of a startup routine.

The assembler in the CA78K0 is required for mkstup.bat. Therefore, if PATH is not specified, specify it before running the batch file.

How to use this file is described next.

- Execute the following command line in the Src\cc78k0\bat folder containing mkstup.bat.

```
mkstup device-typeNote
```

**Note** See the user's manual of the target device or "Device File Operating Precautions".

An example of use is described next.

- This example creates a startup routine to use when the target device is the uPD78F051144.

```
mkstup F051144
```

The mkstup.bat batch file stores the new startup routine so as to overwrite the object files of the startup routine in the lib folder at the same level as the bat folder.

The startup routine that is required to link object files is output to each folder.

The names of the object files created in lib are shown below.

lib    ——— s0.rel  
                  s0b.rel  
                  s0e.rel  
                  s0l.rel  
                  s0lb.rel  
                  s0le.rel  
                  s0sm.rel  
                  s0smb.rel  
                  s0sme.rel  
                  s0sml.rel  
                  s0smlb.rel  
                  s0smle.rel

## 7.4 Startup Routines

This section explains startup routines.

### 7.4.1 Overview of startup routines

A startup routine makes the preparations needed to execute the C source program written by the user. By linking it to a user program, a load module file that achieves the objective of the program can be created.

#### (1) Function

Memory initialization, ROMization for inclusion in a system, and the entry and exit processes for the C source program are performed.

##### - ROMization

The initial values of the external variables, static variables, and sreg variables defined in the C source program are located in ROM. However, the variable values cannot be rewritten; only placed in ROM as is. Therefore, the initial values located in ROM must be copied to RAM. This process is called ROMization. When a program is written to ROM, it can be run by a microcontroller.

#### (2) Configuration

The figure below shows the programs related to the startup routines and their configurations.

Figure 7-1. Programs Related to Startup Routines and Their Configurations

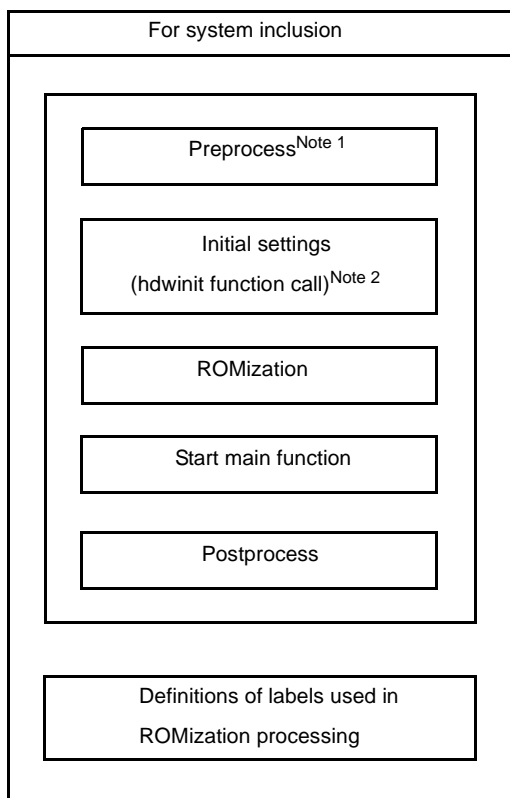

- Notes 1.** If the standard library is used, the processing related to the library is performed first. Startup routine source files that do not have an "n" appended at the end of their file names are processed in relation to the standard library. Files with the appended "n" are not processed.
- 2.** The hdwinit function is a function created as necessary by the user as a function to initialize peripheral devices (sfr). By creating the hdwinit function, the timing of the initial settings can be accelerated (the initial settings can be made in the main function). If the user does not create the hdwinit function, the process returns without doing anything.

cstart.asm and cstartn.asm have nearly identical contents.  
 The table below shows the differences between cstart.asm and cstartn.asm.

Type of Startup Routine	Uses Library Processing
cstart.asm	Yes
cstartn.asm	No

**(3) Uses of startup routines**

The table below lists the names of the object files for the source files provided by the CA78K0.

File Type	Source File	Object File
Startup routine	cstart*.asm <sup>Note 1, 2</sup>	s0*.rel <sup>Note 2, 3</sup>
ROMization file	rom.asm	Included in library

- Notes 1.** \*: If the standard library is not used, "n" is added. If the standard library is used, "n" is not added.

2. \*: "b" is added for boot area startup routines, and "e" for flash area startup routines.
3. \*: If a fixed area in the standard library is used, "l" is added.

**Remark** rom.asm defines the label indicating the final address of the data copied by ROMization.  
The object file generated from rom.asm is included in the library.

#### 7.4.2 Startup routine preprocessing

Sample program (cstart.asm) preprocessing will now be explained.

**Remark** cstart is called in the format with @\_ added to its head.

```

NAME      @cstart

$INCLUDE ( def.inc )                ; (1)
$INCLUDE ( macro.inc )              ; (2)

BRKSW     EQU    1    ; brk, sbrk, calloc, free, malloc, realloc function use
EXITSW    EQU    1    ; exit, atexit  function use
$_IF ( _STATIC )
RANDSW    EQU    0    ; rand, srand  function use
DIVSW     EQU    0    ; div          function use
LDIVSW    EQU    0    ; ldiv         function use
FLOATSW   EQU    0    ; floating point variables use
$ELSE
RANDSW    EQU    1    ; rand, srand  function use
DIVSW     EQU    1    ; div          function use
LDIVSW    EQU    1    ; ldiv         function use
FLOATSW   EQU    1    ; floating point variables use
$ENDIF
STRTOKSW  EQU    1    ; strtok      function use

PUBLIC    @_cstart, @_cend          ; (3)

$_IF ( BRKSW )
PUBLIC    @_BRKADR, @_MEMTOP, @_MEMBTM
:
$ENDIF

EXTRN    _main, _@STBEG, _hdwinit   ; (4)
$_IF ( EXITSW )
EXTRN    _exit
$ENDIF

EXTRN    _?R_INIT, _?R_INIS, _?DATA, _?DATS ; (5)
@@DATA   DSEG    UNITP              ; (6)

$_IF ( EXITSW )
_@FNCTBL :    DS    2 * 32

```

```

_@FNCENT :      DS      2
:
_@MEMTOP :      DS      32
_@MEMBTM :
$ENDIF

```

**(1) Including include files**

def.inc -> For settings according to the library type.  
macro.inc -> Macro definitions for typical patterns.

**(2) Library switch**

If the standard libraries listed in the comments are not used, by changing the EQU definition to 0, the space secured for the processing of unused libraries and for use by the library can be conserved. The default is set to use everything (In a startup routine without library processing, this processing is not performed).

**(3) Symbol definitions**

The symbols used when using the standard library are defined.

**(4) External reference declaration of symbol for stack resolution**

The public symbol (\_@STBEG) for stack resolution is an external reference declaration.

\_@STBEG has the value of the last address in the stack area + 1.

\_@STBEG is automatically generated by specifying the symbol generation option (-s) for stack resolution in the linker. Therefore, always specify the -s option when linking. In this case, specify the name of the area used in the stack. If the name of the area is omitted, the RAM area is used, but the stack area can be located anywhere by creating a link directive file. For memory mapping, see the user's manual of the target device.

An example of a link directive file is shown below. The link directive file is a text file created by the user in an ordinary editor (for details about the description method, see "7.6 Coding Examples").

**Example** When -sSTACK is specified in linking

Create lk78k0.dr (link directive file). Since ROM and RAM are allocated by default operations by referencing the memory map of the target device, it is not necessary to specify ROM and RAM allocations unless they need to be changed.

For link directives, see lk78k0.dr in the Smp78k0\CA78K0 folder.

```

                First address  Size
                |              |
memory SDR      : ( 0FE20h, 00098h )
memory STACK    : ( xxxxxh, xxxh )  <- Specify the first address and size here, then
                                         specify lk78k0.dr by the -d linker option.
                                         (Example: -dlk78k0.dr)

merge @@INIS    : = SDR
merge @@DATS    : = SDR
merge @@BITS    : = SDR

```

**(5) External reference declaration of labels for ROMization processing**

The labels for ROMization processing are defined in the postprocessing section.

**(6) Securing area for standard library**

The area used when using the standard library is secured.

**7.4.3 Startup routine initial settings**

The initial settings for a sample program (cstart.asm) will now be explained.

```

@@VECT00      CSEG      AT      0                      ; (1)
              DW      @_cstart

@LCODE CSEG
_@cstart :
              SEL      RB0                      ; (2)
              MOVW     SP, #_@STBEG             ; SP <-stack begin address ; (3)
              CALL     !_hdwinit                ; (4)
              :
$_IF ( BRKSW OR EXITSW OR RANDSW OR FLOATSW )
              MOVW     AX, #0
$ENDIF
              :

```

**(1) Reset vector setting**

The segment of the reset vector table is defined as follows. The first entry address of the startup routine is set.

```

@@VECT00      CSEG      AT      0000H
              DW      @_cstart

```

**(2) Register bank setting**

Register bank RB0 is set as the work register bank.

**(3) Stack pointer (SP) setting**

\_@STBEG is set in the stack pointer.

\_@STBEG is automatically generated by specifying the symbol generation option (-s) for stack resolution in the linker.

**(4) Hardware initialization function call**

The hdwinit function is created when needed by the user as the function for initializing peripheral devices (SFR).

By creating this function, initial settings can be made to match the user's objectives.

If the user does not create the hdwinit function, the process returns without doing anything.

**(5) ROMization processing**

The ROMization processing in cstart.asm will now be described.

```

; *****
; ROM DATA COPY
; *****
; copy external variables having initial value
              MOVW     HL, #_@R_INIT

```



```

        MOVW    DE, #_@INIT
LINIT1 :
        MOVW    AX, HL
        CMPW    AX, #_?R_INIT
        BZ      $LINIT2
        MOV     A, [HL]
        MOV     [DE], A
        INCW    HL
        INCW    DE
        BR      $LINIT1
LINIT2 :
        MOVW    HL, #_@DATA
; copy external variables which doesn't have initial value
LDATA1 :
        :

```

In ROMization processing, the initial values of the external variables and the sreg variables stored in ROM are copied to RAM. The variables to be processed have the 4 types (a) to (d) shown in the following example.

```

char    c = 1 ;           (a)External variable with initial value
int     i ;              (b)External variable without initial valueNote
__sreg  int    si = 0 ;   (c)sreg variable with initial value
__sreg  char   sc ;      (d)sreg variable without initial valueNote

void main ( void ) {
        :
}

```

**Note** External variables without initial value and sreg variables without initial value are not copied, and zeros are written directly to RAM.

- The figure below shows ROMization processing for external variable (a) with an initial value. The initial value of the variable (a) is placed in the @@R\_INIT segment of ROM by the 78K0 C compiler. The ROMization processing copies this value to the @@INIT segment in RAM (the same processes are performed for the variable (c) ).

Figure 7-2. ROMization Processing for External Variable with Initial Value

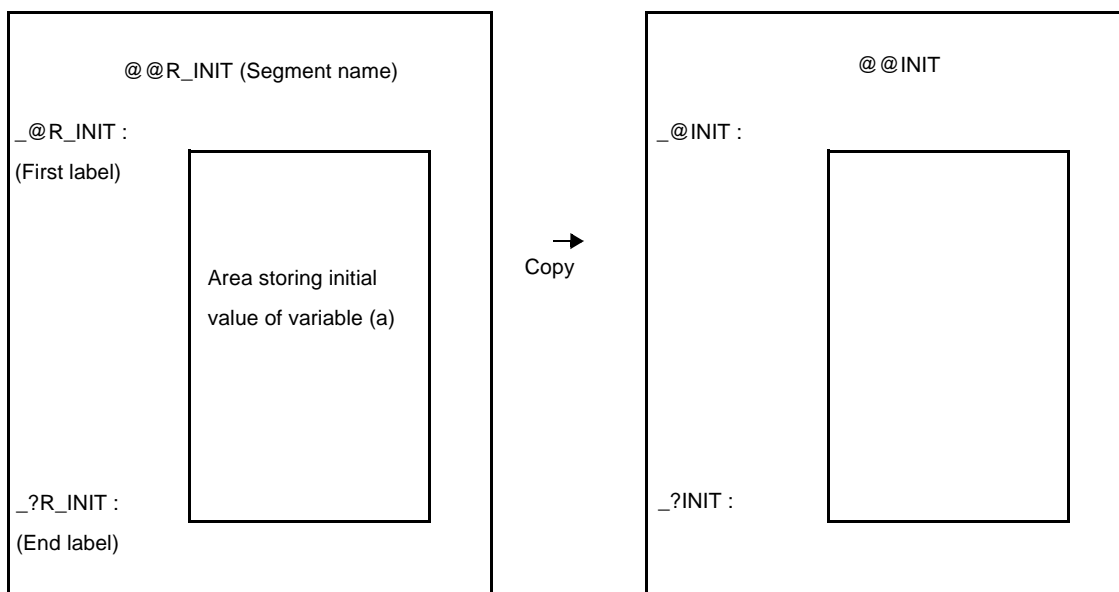

- The first and end labels in the @@R\_INIT segment are defined by \_@R\_INIT and \_?R\_INIT. The first and end labels in the @@INIT segment are defined by \_@INIT and \_?INIT.
- The variables (b) and (d) are not copied, but zeros are written directly in the predetermined segment in RAM. The table below shows the segment names of the ROM areas where the variables (a) to (c) are placed, and the first and end labels of the initial values in each segment.

Variable Type	Segment	First Label	End Label
External variable with initial value (a)	@@R_INIT	_@R_INIT	_?R_INIT
sreg variable with initial value(c)	@@R_INIS	_@R_INIS	_?R_INIS

The table below shows the segment names of the RAM areas where the variables (a) to (d) are placed, and the first and end labels of the initial values in each segment.

Variable Type	Segment	First Label	End Label
External variable with initial value (a)	@@INIT	_@INIT	_?INIT
External variable without initial value (b)	@@DATA	_@DATA	_?DATA
sreg variable with initial value (c)	@@INIS	_@INIS	_?INIS
sreg variable without initial value (d)	@@DATS	_@DATS	_?DATS

#### 7.4.4 Startup routine main function startup and postprocessing

Starting the main function and postprocessing in a sample program (cstart.asm) will now be described.

```

CALL    !_main          ; main ( );          ; (1)
$_IF ( EXITSW )
    MOVW    AX, #0
    CALL    !_exit      ; exit ( 0 );      ; (2)
$ENDIF
    BR     $$
;
_@cend :
; (3)
@@R_INIT CSEG    UNITP
_@R_INIT :
@@R_INIS CSEG    UNITP
_@R_INIS :
@@INIT   DSEG    UNITP
_@INIT   :
@@DATA   DSEG    UNITP
_@DATA   :
@@INIS   DSEG    SADDRP
_@INIS   :
@@DATS   DSEG    SADDRP
_@DATS   :
@@CALT   CSEG    CALLT0
@@CALF   CSEG    FIXED
@@CNST   CSEG    UNITP
@@BITS   BSEG
;
    END

```

##### (1) Starting the main function

The main function is called.

##### (2) Starting the exit function

When exit processing is needed, the exit function is called.

##### (3) Definitions of segments and labels used in ROMization processing

The segments and labels used for each variable (1) to (4) (see "[\(5\) ROMization processing](#)") in ROMization processing are defined. A segment indicates the area that stores the initial value of each variable. A label indicates the first address in each segment.

The ROMization processing file rom.asm will now be described. The rom.asm relocatable object file is in the library.

```

NAME    @rom
;
PUBLIC  _?R_INIT, _?R_INIS
PUBLIC  _?INIT, _?DATA, _?INIS, _?DATS
;
@@R_INIT    CSEG    UNITP                ; (4)
_?R_INIT :
@@R_INIS    CSEG    UNITP
_?R_INIS :
@@INIT      DSEG    UNITP
_?INIT :
@@DATA      DSEG    UNITP
_?DATA :
@@INIS      DSEG    SADDRP
_?INIS :
@@DATS      DSEG    SADDRP
_?DATS :
;
END
    
```

**(4) Definition of labels used in ROMization processing**

The labels used for each variable (1) to (4) (see "(5) ROMization processing") in ROMization processing are defined. These labels indicate the last address of the segment storing the initial value of each variable.

If multiple user libraries exist and mutual references exist between the object module files belonging to these libraries, do not change the module names "@rom" and "@rome" of the CA78K0 terminal module.

If the terminal module name is changed, it may not link in the end.

**7.5 ROMization Processing in Startup Module for Flash Area**

The startup modules for flash differ with the ordinary startup modules as follows.

**Table 7-4. ROM Area Section for Initialization Data**

Variable Type	Segment	First Label	End Label
External variable with initial value (a)	@ER_INIT CSEG UNITP	E@R_INIT	E?R_INIT
sreg variable with initial value (c)	@ER_INIS CSEG UNITP	E@R_INIS	E?R_INIS

**Table 7-5. RAM Area Section of Copy Destination**

Variable Type	Segment	First Label	End Label
External variable with initial value (a)	@EINIT DSEG UNITP	E@INIT	E?INIT
External variable without initial value (b)	@EDATA DSEG UNITP	E@DATA	E?DATA
sreg variable with initial value (c)	@EINIS DSEG SADDRP	E@INIS	E?INIS
sreg variable without initial value (d)	@EDATS DSEG SADDRP	E@DATS	E?DATS

- In the startup module, the following labels are added at the head of each segment in ROM area and RAM area.  
E@R\_INIT, E@R\_INIS, E@INIT, E@DATA, E@INIS, E@DATS
- In the terminal module, the following labels are added at the terminal of each segment in ROM area and RAM area.  
E?R\_INIT, E?R\_INIS, E?INIT, E?DATA, E?INIS, E?DATS
- The startup module copies the contents from the first label address of each segment in ROM area to the end label address -1, to the area from the first label address of each segment in RAM area
- Zeros are embedded from E@DATA to E?DATA, and from E@DATS to E?DATS.

## 7.6 Coding Examples

The startup routines provided by the CA78K0 can be revised to match the target system actually being used. The essential points about revising these files are explained in this section.

### 7.6.1 When revising startup routine

The essential points about revising a startup routine source file will now be explained. After revising, use the batch file mkstup.bat in the Src\cc78k0\bat folder to assemble the revised source file (cstart\*.asm) (\*:alphanumeric symbols).

#### (1) Symbols used in library functions

If the library functions listed in the table below are not used, the symbols corresponding to each function in the startup routine (cstart.asm) can be deleted. However, since the exit function is used in the startup routine, @\_FNCTBL and @\_FNCENT cannot be deleted (if the exit function is deleted, these symbols can be deleted). The symbols in the unused library functions can be deleted by changing the corresponding library switch.

Library Function Name	Symbols Used
brk sbrk malloc calloc realloc free	__errno __@MEMTOP __@MEMBTM __@BRKADR
exit	__@FNCTBL __@FNCENT
rand srand	__@SEED
div	__@DIVR
ldiv	__@LDIVR
strtok	__@TOKPTR
atof strtod Mathematical function Floating-point runtime library	__errno

**(2) Areas that are used for utility functions (block assignments/releases)**

If the size of the area used by a utility function (block assignment/release) is defined by the user, this is set as in the following example.

**Example** If you want to reserve 72 bytes for use by utility functions (block assignments/releases), make the following changes to the initial settings of the startup routine.

**Figure 7-3. Startup Routine Initial Settings Example**

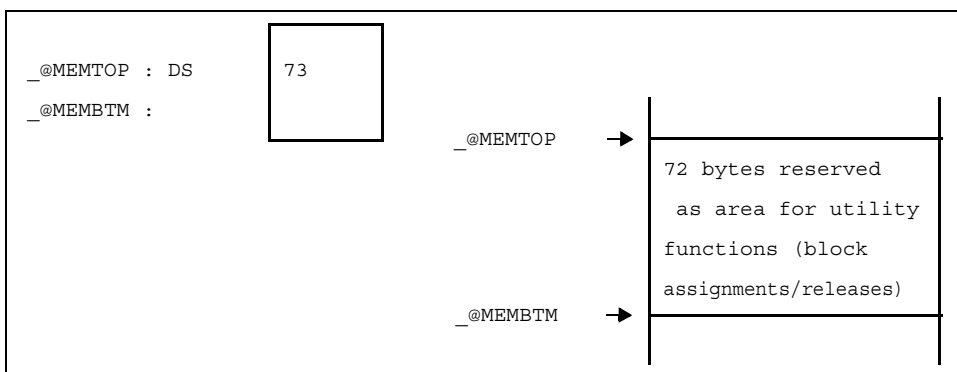

Add one byte to the area size to be secured and then specify the value in the startup routine. In the above example, 73 bytes are secured in the startup routine, but up to 72 bytes can actually be secured for utility functions.

If the specified size is too big to be stored in the RAM area, errors may occur when linking.

In this case, decrease the size specified as shown below, or avoid by correcting the link directive file. For correction of the link directive file, see "5.3.2 When using the compiler".

**Example** To decrease the specified size

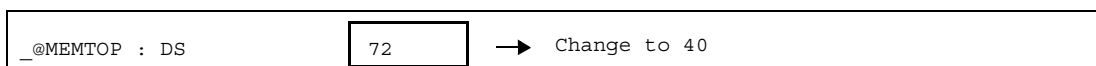

## CHAPTER 8 ROMIZATION

ROMization refers to the process of placing initial values, such as those for initialized external variables, into ROM and then copying them to RAM when the system is executed.

The CA78K0 provides startup routines with built-in program ROMization processing, saving the trouble of writing a routine for romization processing at startup.

For information about the startup routines, see "[7.4 Startup Routines](#)".

The method for performing program ROMization is as follows.

During ROMization the startup routine, object module files and libraries are linked. The startup routine initializes the object program.

**(1) s0\*.rel**

Startup routine (ROMization compatible).

The copy routine for the initialization data is included, and the beginning of the initial data is indicated. The label "\_@cstart" (symbol) is added to the start address.

**(2) c10\*.lib**

Library included with the CA78K0r

The library files of the C compiler include the following library types.

- Runtime library

"@@" is added to the beginning of the symbol for runtime library names. For special libraries cstart, however, "\_@" is added to the beginning of the symbol.

- Standard library

"\_" is added to the beginning of the symbol for standard library names.

**(3) \*.lib**

User-created library

"\_" is added to the beginning of the symbol.

**Caution** The CA78K0 provides several types of startup routines and libraries. See "[CHAPTER 7 STARTUP](#)" regarding startup routines. See "[7.2.2 "lib" folder contents](#)" regarding libraries.

## CHAPTER 9 REFERENCING COMPILER AND ASSEMBLER

This chapter describes how to link a program written in assembly language.

If a function called from a C source program is written in another language, both object modules are linked by the linker. This chapter describes the procedure for calling a program written in another language from a program written in the C language, and the procedure for calling a program written in the C language from a program written in another language.

Using the CA78K0 to interface with another language is described in the following order:

- [Accessing Arguments and Automatic Variables](#)
- [Storing Return Values](#)
- [Calling Assembly Language Routines from C Language](#)
- [Calling C Language Routines from Assembly Language](#)
- [Referencing Variables Defined in C Language](#)
- [Referencing Variables Defined in Assembly Language from C Language](#)
- [Points of Caution for Calling Between C Language Functions and Assembler Functions](#)

## 9.1 Accessing Arguments and Automatic Variables

Methods for accessing 78K0 C compiler arguments and automatic variables are as follows.

### 9.1.1 Normal model

- On the function calling side, register variables are passed in the same way as normal variables. The first argument is passed in the registers shown below, and the second and subsequent arguments are passed on the stack.

Type	Passing Location (First Argument)	Passing Location (Second and Later Arguments)
1-byte, 2-byte data	AX	Stack passing
3-byte, 4-byte data	AX, BC	Stack passing
Floating-point number	AX, BC	Stack passing
Others	Stack passing	Stack passing

**Remark** 1- to 4-byte data includes structures, unions, and pointers.

- The called function side takes the arguments that have been passed by register or on the stack and stores them in locations reserved for that purpose.

Register arguments are copied to registers or saddr areas (`_@KREGxx`). Even when arguments are passed by register, copying is still done because different registers are used on the calling and called sides.

Normal arguments that have been passed by register are placed on the stack by the called function, in order from the last to the first. The minimum unit that can be placed on the stack is 16 bits. Types larger than 16 bits are stored in 16-bit units, beginning from the high-order 16 bits. 8-bit types are expanded to 16 bits. When arguments have been passed on the stack, they are left there.

The called function handles saving and restoration of the registers used to store arguments.

- Depending on option specifications, function arguments and the values of automatic variables declared in functions are stored in registers, in saddr areas, or on the stack. The options and storage locations are shown below. When they are stored on the stack, the HL register is used as the stack frame base pointer.



Function arguments are assigned to saddr areas when they have been declared as register arguments, and also when both the -qv and -qr arguments have been specified.

**Table 9-1. Storage Locations of Arguments and Automatic Variables (Normal Model)**

Option	Argument/auto Variable	Storage Location	Priority Level
-qv (register allocation option)	Declared argument or automatic variable	HL register (only when base pointer is not required)	char type : L, H, in this order int, short, enum type : HL
-qr (saddr allocation option)	register declared argument or automatic variable	HL register (only when base pointer is not required)  Argument : _@KREG12 to 15 [0FEDCH to 0FEDFH]  Automatic variable : _@KREG00 to 11 [0FED0H to 0FEDBH]	Only the number of bytes of the variable or argument is allocated, in order of appearance. Allocated to register as char type :L, H, in this order int, short, enum type : HL
-qrv	Declared argument or automatic variable	HL register (only when base pointer is not required) )  Argument : _@KREG12 to 15 [0FEDCH to 0FEDFH]  Automatic variable : _@KREG00 to 11 [0FED0H to 0FEDBH]	Only the number of bytes of the variable or argument is allocated, in order of appearance. Allocated to register as char type ::L, H, in this order int, short, enum type : HL
Default	Declared argument, automatic variable	Stack frame	Order of appearance

Following is an example function call.

**(1) -qrv option specified**

<C source>

```
void func0 ( register int, int );

void main ( ) {
    func0 ( 0x1234, 0x5678 );
}

void func0 ( register int p1, int p2 ) {
    register int    r ;
    int            a ;
    r = p2 ;
}
```

```

    a = p1 ;
}

```

< Output assembler source >

```

    EXTRN    @_KREG12
    EXTRN    @_KREG13
    EXTRN    @_KREG00
    EXTRN    @_KREG02
    PUBLIC   _func0
    PUBLIC   _main

@@CODE CSEG
_main :
    movw    ax, #05678H    ; 22136
    push    ax                ; Argument passed on stack
    movw    ax, #01234H    ; 4660 ; 1st argument passed on register
    call    !_func0         ; Function call
    pop     ax                ; Argument passed on stack
    ret

_func0 :
    push    hl                ; Save the register for arguments
    xch     a, x
    xch     a, @_KREG12
    xch     a, x
    xch     a, @_KREG13      ; Allocate register argument p1 to @_KREG12
    push    ax                ; Save the saddr area for register arguments
    movw    ax, @_KREG00
    push    ax                ; Save the saddr area for register variables
    movw    ax, @_KREG02
    push    ax                ; Save the saddr area for automatic variables
    movw    ax, sp
    movw    hl, ax
    mov     a, [hl + 10]     ; Argument p2 passed on stack
    xch     a, x
    mov     a, [hl + 11]
    movw    hl, ax          ; Assigned to HL
    movw    ax, hl          ; Argument p2
    movw    @_KREG00, ax    ; r    ; Assigned to register variables r
    movw    ax, @_KREG12    ; p1   ; Register argument p1
    movw    @_KREG02, ax    ; a    ; Assigned to automatic variable a
    pop     ax
    movw    @_KREG02, ax    ; Restore the saddr area for register variables
    pop     ax
    movw    @_KREG00, ax    ; Restore the saddr area for automatic variables
    pop     ax

```

```

movw   _@KREG12, ax           ; Restore the saddr area for register arguments
pop    hl                     ; Restore the register for arguments
ret
END
    
```

**9.1.2 Static model**

- The calling side passes register arguments and normal arguments in the same way.
- Up to a maximum of 3 arguments can be passed. Their total size can be up to 6 bytes. All arguments are passed by register.

Type	Passing Location (First Argument)	Passing Location (Second Argument)	Passing Location (Third Argument)
1-byte data	A	B	H
2-byte data	AX	BC	HL
4-byte data	Allocated to AX and BC, remainder allocated to H or HL		

**Remark** 1- to 4-byte data does not include structures and unions.

- The called function side takes the arguments that have been passed by register and stores them in locations reserved for that purpose.  
Arguments that have been declared as register (register variables) are assigned to registers whenever possible. Normal arguments are stored in a private area reserved for that purpose.
- All register variables are passed by register. But they are still copied by the called function to registers, because the calling and called sides use different registers.
- The called function handles saving and restoration of registers to which arguments and automatic variables are assigned.
- Depending on option specifications, function arguments and the values of automatic variables declared in functions are stored in registers or in private storage. The option and storage locations are shown below. Private storage for functions is static memory that is allocated from RAM for each function.

**Table 9-2. Storage Locations of Arguments and Automatic Variables (Static Model)**

Option	Argument/auto Variable	Storage Location	Priority Level
-qv (register allocation option)	Declared argument or automatic variable	DE register	Arguments : char type : D, E, in this order int, short, enum type : DE Automatic variables : char type : E, D, in this order int, short, enum type : DE
Default	Declared argument, automatic variable	Function-specific area	Arguments are allocated starting from the 1st argument, automatic variables are allocated by order of appearance

Option	Argument/auto Variable	Storage Location	Priority Level
Default	Argument, register variable declared with register	DE register	Only the number of bytes of the variable or argument is allocated, according to the number of times referenced.  Other than the number of bytes of the variable or argument is allocated to the area peculiar to the function.

Following is an example function call.

**(1) -sm, -qv options specified**

<C source>

```

void sub ( );
void func ( register int, char );

void main ( ) {
    func ( 0x1234, 0x56 );
}

void func ( register int p1, char p2 ) {
    register char r ;
    int a ;
    r = p2 ;
    a = p1 ;
    sub ( );
}
    
```

< Output assembler source >

```

        PUBLIC  _func
        PUBLIC  _main
        :
@@DATA  DSEG
?L0005 :      DS      ( 1 )      ; Argument p2
?L0006 :      DS      ( 1 )      ; Register variable r
?L0007 :      DS      ( 2 )      ; Automatic variable a
        :
@@CODE  CSEG
_main :
    mov     b, #056H           ; 86   ; Pass the 2nd argument by register B
    movw   ax, #01234H        ; 4660 ; Pass the 1st argument by register AX
    call   !_func             ; Function call
    ret
_func :
    push   de                 ; Save registers for register arguments
    
```

```

movw   de, ax                ; Allocate register arguments p1 to DE
mov     a, b
mov     !?L0005, a           ; Copy argument p2 to ?L0005
mov     !?L0006, a          ; r      ; Assigned to register variable r
movw   ax, de                ; Register argument p1
movw   !?L0007, ax         ; a      ; Assigned to automatic variable a
call   !_sub
pop     de                   ; Restores the register for register arguments
ret
END

```

## 9.2 Storing Return Values

See "[3.4.1 Return values](#)".

## 9.3 Calling Assembly Language Routines from C Language

This section shows examples of using the normal mode (default) procedures.

When the -qv option, the -qr option, or the -qrv option is specified, storage is according to "[Table 9-1. Storage Locations of Arguments and Automatic Variables \(Normal Model\)](#)". However, when the HL register is not needed as a base pointer (when it is not used), then variables are assigned to HL.

Calling an assembly language routine from the C language is described as follows.

- [Function information file modifications](#)
- [C language function calling procedure](#)
- [Saving data from assembly language routine and returning](#)

### 9.3.1 Function information file modifications

When you want to assign an assembly language routine to a bank area, information about the function must be added to a function information file

Following is an example of a function information file.

#### (1) When sample.asm, which contains function FUNC, is located in BANK2

```

sample.asm := 2 (0) {
    FUNC ;
}

```

9.3.2 C language function calling procedure

The following is a C language program example that calls an assembly language routine.

```
extern int    FUNC ( int, long );    /* Function prototype */

void main ( void ) {
    int      i, j ;
    long     l ;

    l = 0x54321 ;
    i = 1 ;
    j = FUNC ( i, l );              /* Function call */
}
```

In this program example, the interface and control flow with the program that is executing are as follows.

(1) Calling a normal assembly language routine

- (a) Placing the first argument passed from the main function to the FUNC function in the register, and the second and subsequent arguments on the stack.
- (b) Passing control to the FUNC function by using the CALL instruction.

The next figure shows the stack immediately after control moves to the FUNC function in the above program example.

Figure 9-1. Stack Immediately After Function Is Called

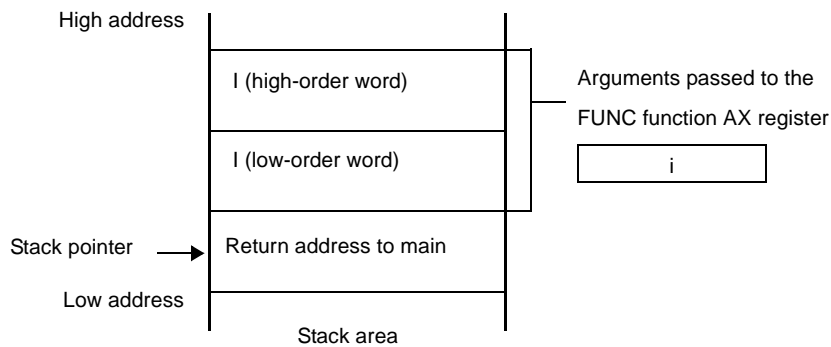

(2) Calling an assembly language routine in a bank area

- (a) Place the first argument passed from function main to function FUNC in a register. Place the second and following arguments on the stack.
- (b) Place the start address of function FUNC and the bank number in registers, and transfer control to function FUNC via the bank function call library.

The next figure shows the stack immediately after control moves to the FUNC function in the above program example.

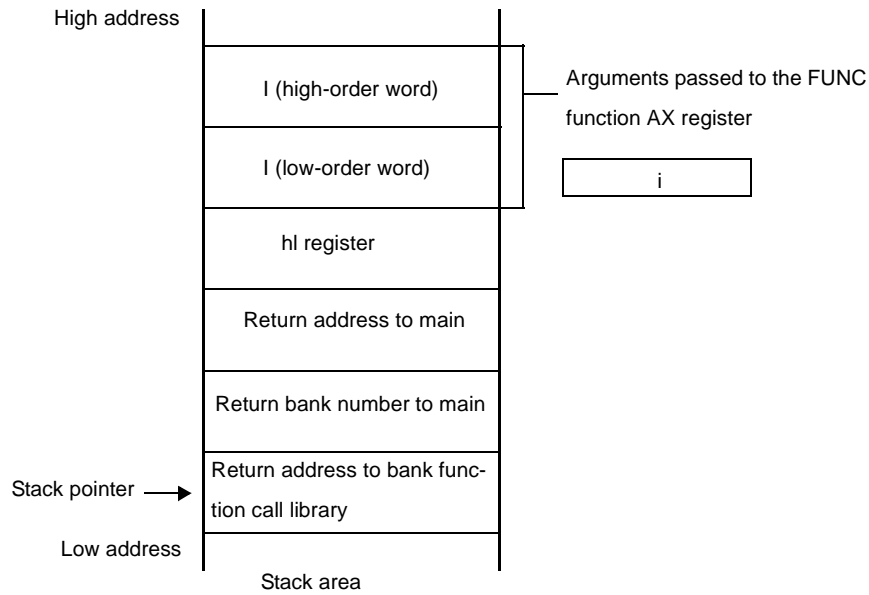

**9.3.3 Saving data from assembly language routine and returning**

The following processing steps are performed in the FUNC function called by the main function.

- (1) Save the base pointer, work register.
- (2) Copy the stack pointer (SP) to the base pointer (HL).
- (3) Perform the processing in the FUNC function.
- (4) Set the return value.
- (5) Restore the saved register.
- (6) Return to the main function

An example of an assembly language program is explained next.

```

$PROCESSOR ( F051144 )

        PUBLIC  _FUNC
        PUBLIC  _DT1
        PUBLIC  _DT2

@@DATA  DSEG    UNITP
_DT1   :  DS      ( 2 )
_DT2   :  DS      ( 4 )

@@CODE  CSEG
    
```

```

_FUNC :
    PUSH    HL                ; save base pointer      (1)
    PUSH    AX
    MOVW    AX, SP            ; copy stack pointer  (2)
    MOVW    HL, AX
    MOV     A, [HL]           ; arg1
    XCH     A, X
    MOV     A, [HL + 1]       ; arg1
    MOVW    !_DT1, AX         ; move 1st argument ( i )
    MOV     A, [HL + 8]       ; arg2 (add 6 to the offset when the argument is in the
                                bank area)
    XCH     A, X
    MOV     A, [HL + 9]       ; arg2 (add 6 to the offset when the argument is in the
                                bank area)
    MOVW    !_DT2 + 2, AX
    MOV     A, [HL + 6]       ; arg2 (add 6 to the offset when the argument is in the
                                bank area)
    XCH     A, X
    MOV     A, [HL + 7]       ; arg2 (add 6 to the offset when the argument is in the
                                bank area)
    MOVW    !_DT2, AX         ; move 2nd argument ( l )
    MOVW    BC, #0AH          ; set return value      (4)
    POP     AX
    POP     HL                ; restore base pointer  (5)
    RET                                ;                          (6)
    END

```

**(1) Saving base pointer and work register**

A label with "\_" is prefixed to the function name written in the C source. Base pointers and work registers are saved with the same name as function names written inside the C source.

After the label is specified, the HL register (base pointer) is saved.

In the case of programs generated by the C compiler, other functions are called without saving the register for register variables. Therefore, if changing the values of these registers for functions that are called, be sure to save the values beforehand. However, if register variables are not used on the call side, saving the work register is not required.

**(2) Copying to base pointer (HL) of stack pointer (SP)**

The stack pointer (SP) changes due to "PUSH, POP" inside functions. Therefore, the stack pointer is copied to register "HL" and used as the base pointer of arguments.

**(3) Basic processing of FUNC function**

After processing steps (1) and (2) are performed, the basic processing of called functions is performed.

**(4) Setting the return value**

If there is a return value, it is set in the "BC" and "DE" registers. If there is no return value, setting is unnecessary.



Figure 9-2. Setting Return Value

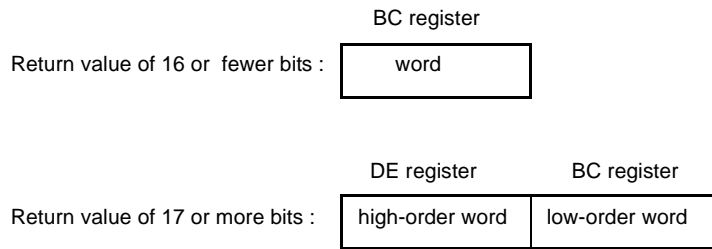

**(5) Restoring the registers**

Restore the saved base pointer and work register.

**(6) Returning to the main function**

Figure 9-3. Returning to Main Function

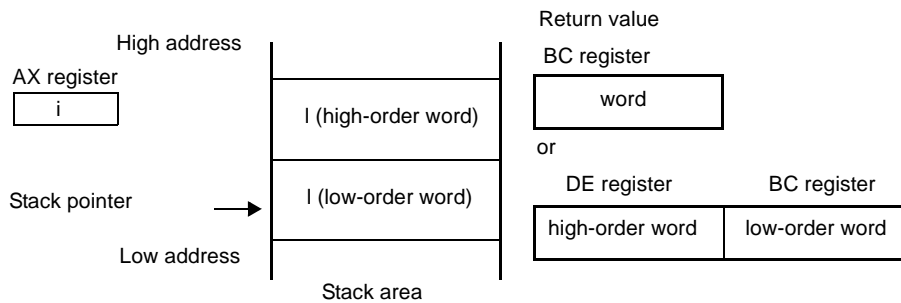

**9.4 Calling C Language Routines from Assembly Language**

This section describes the procedure for calling functions written in C language from assembly language routines.

**9.4.1 Calling C language function from assembly language program**

The procedure for calling a function written in the C language from an assembly language routine is as follows.

**(1) Calling normal C routines**

- (a) Save the C work registers (AX, BC, and DE).
- (b) Place the arguments on the stack.
- (c) Call the C language function.
- (d) Increment the value of the stack pointer (SP) by the number of bytes of arguments.
- (e) Reference the return value of the C language function (in BC or DE and BC).

- This is an example of an assembly language program.

```

$PROCESSOR ( F051144 )

        NAME      FUNC2
        EXTRN     _CSUB
        PUBLIC    _FUNC2

@@CODE  CSEG
_FUNC2 :
        movw     ax, #20H      ; set 2nd argument ( j )
        push    ax            ;
        movw     ax, #21H      ; set 1st argument ( i )
        call    !_CSUB        ; call "CSUB ( i , j )"
        pop     ax            ;
        ret
        END

```

#### <1> Save the C work registers (AX, BC, DE)

C functions use the 3 register pairs AX, BC, and DE as work registers and do not restore them when they return. If the calling side needs the values in these registers, the calling side must save them.

The registers should be saved and restored before and after argument passing code.

If a C function uses the HL register, the C function side always saves it.

#### <2> Load arguments

If there are any arguments, place them on the stack.

The following figure shows how arguments are passed.

Figure 9-4. Argument Passing

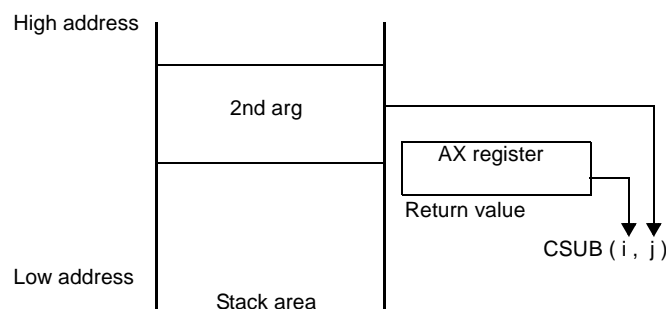

#### <3> Calling a C language function

A CALL instruction calls a C language function. When the C language function is a callt function, it is called by the callt instruction. When it is a callf function, it is called by the callf instruction.

#### <4> Restoring the stack pointer (SP)

The stack pointer is restored by the number of bytes that hold the arguments.

#### <5> Referencing the return value (BC and DE)

The return value from the C language is returned as follows.

Figure 9-5. Referencing Return Values

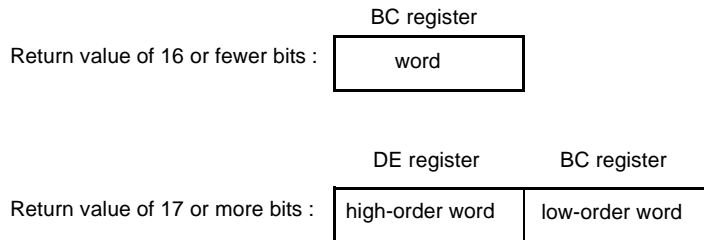
**(2) Calling C routines in bank areas**

- (a) Save the C work registers (AX, BC, DE)**
- (b) Place arguments on the stack**
- (c) Save the HL register, and set the start address of the C function in the HL register**
- (d) Set the bank number of the bank where the C resides in register E**
- (e) Call by executing the bank function call library callt instruction**
- (f) Restore the HL register**
- (g) Adjust the stack pointer (SP) value by the number of argument bytes**
- (h) Reference the value returned by the C function (in BC, or DE and BC)**

- This is an example of an assembly language program.

```

$PROCESSOR ( F051144 )

        NAME      FUNC2
        EXTRN    _CSUB
        PUBLIC   _FUNC2

@@CODE      CSEG
_FUNC2 :
        movw    ax, #20H           ; set 2nd argument ( j )
        push   ax                  ;
        movw    ax, #21H           ; set 1st argument ( i )
        push   hl                  ;
        movw    hl, #_CSUB         ; set 1st argument ( i )
        movw    e, #_BANKNUM _CSUB ; set 1st argument ( i )
        callt  [@@bcall]          ; call "CSUB ( i, j )"
        pop    hl                  ;
        pop    ax                  ;
        ret
        END

```

**<1> Save the work registers (AX, BC, DE)**

C functions use the 3 register pairs AX, BC, and DE as work registers, and do not restore them when they return. The E register is also used when the bank function call library is called.

If the calling side needs these registers, the calling side must save them.

The registers should be saved and restored before and after argument passing code.

Save the HL register after loading arguments

**<2> Load arguments**

If there are any arguments, place them on the stack.

The following figure shows how arguments are passed.

**Figure 9-6. Argument Passing**

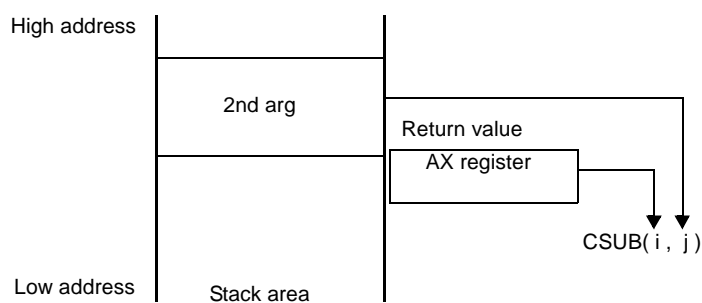
**<3> Save the HL register, and set the start address of the C function**

Save the HL register, and set the start address of the C function, which is used by the bank function call library, in register HL..

**<4> Set the C function bank number**

The bank function call library needs the number of the bank where the C function resides. Set the bank number in E.

**<5> Call the bank function call library**

Call the bank function call library @@bcall with the CALLT instruction.

**<6> Restore the HL register**

Restore the HL register that was saved in <3>.

**<7> Restore the stack pointer (SP)**

Adjust the stack by the number of bytes in the arguments that were loaded.

**<8> Reference the return value (BC, DE)**

C functions return values as follows.

Figure 9-7. Referencing Return Values

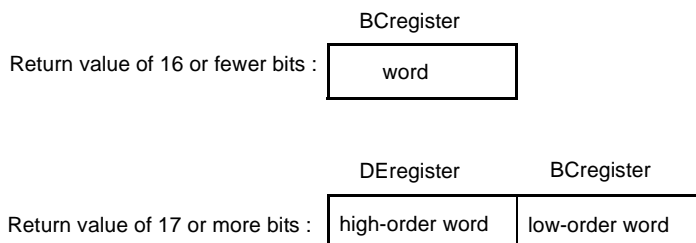

## 9.5 Referencing Variables Defined in C Language

If external variables defined in a C language program are referenced in an assembly language routine, the extern declaration is used.

Underscores "\_" are added to the beginning of the variables defined in the assembly language routine.

A C language program example is shown below.

```
extern void subf ( void );

char    c = 0 ;
int     i = 0 ;

void main ( void ) {
    subf ( );
}
```

The following occurs in the assembler.

```
$PROCESSOR ( F051144 )

        PUBLIC  _subf
        EXTRN   _c
        EXTRN   _i

@@CODE  CSEG
_subf :
        MOV     a, #04H
        MOV     !_c, a
        MOVW    ax, #07H      ; 7
        MOVW    !_i, ax
        RET
        END
```

### 9.6 Referencing Variables Defined in Assembly Language from C Language

Variables defined in assembly language are referenced from the C language in this way.

A C language program example is shown below.

```
extern char    c ;
extern int     i ;

void subf ( void ) {
    c = ' A ' ;
    i = 4 ;
}
```

The following occurs in the 78K0 assembler.

```
NAME      ASMSUB

PUBLIC    _c3
PUBLIC    _i

ABC      DSEG
_c :     DB      0
_i :     DW      0

END
```

### 9.7 Points of Caution for Calling Between C Language Functions and Assembler Functions

- "\_"(underscore)

The 78K0 C compiler adds an underscore "\_" (ASCII code "5FH" ) to external definitions and reference names of the object modules to be output.

In the next C program example, "j = FUNC(i, l);" is taken as "a reference to the external name \_FUNC".

```
extern int     FUNC ( int, long );    /* Function prototype */

void main ( void ) {
    int        i, j ;
    long       l ;

    l = 0x54321;
    i = 1 ;
    j = FUNC ( i, l );                /* Function call */
}
```

The routine name is written as "\_FUNC" in 78K0 assembler.

- Argument positions on the stack

The arguments placed on the stack are placed from the postfix argument to the prefix argument in the direction from the High address to the Low address.

Figure 9-8. Argument Positions on Stack

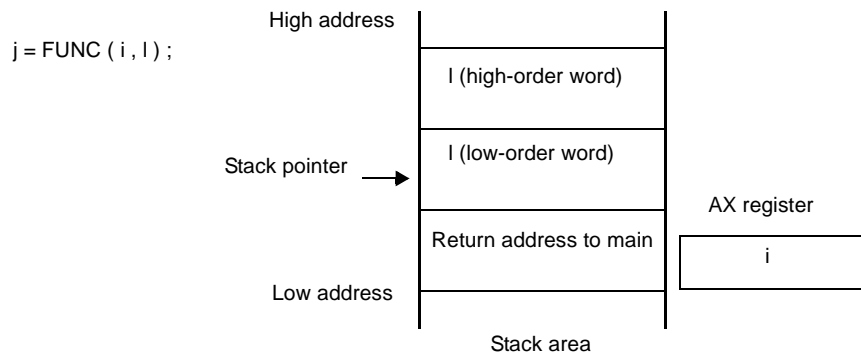

## CHAPTER 10 CAUTIONS

This chapter explains points of caution when coding.

**(1) Kanji code (2-byte code) classification**

To use a source containing SJIS or EUC code, specify sjis or euc for the environmental variable LANG78K, or select SJIS or EUC for the "Kanji Code of Source" option.

If the specified Japanese character encoding scheme differs from the encoding scheme used in the source, an error might occur during building, or some of the code might be incorrectly processed as comments.

**(2) Include files**

Functions (except declarations) defined within include files cannot be expanded in the C source.

If definitions are made within an include file, unwanted effects such as definition lines not being displayed correctly may occur at the time of debugging.

**(3) When outputting assembler source**

When there are assembly language descriptors such as #asm blocks or \_\_asm statements within the C source program, the load module file creation sequence occurs in the order of: compile, assemble, link.

As in cases where there are assembly language descriptors, when assembling by outputting the assembler source first without outputting objects directly with the 78K0 C compiler, observe the following points of caution.

- If it is necessary to define symbols within #asm blocks (the area between #asm and #endasm), or within \_\_asm statements, use symbols of eight characters or less beginning with ?L@ (e.g. ?L@01, ?L@sym, etc.). However, do not define these symbols externally (via PUBLIC declaration). Furthermore, segments cannot be defined within #asm blocks or \_\_asm statements. If symbols beginning with the ?L@ character sequence are not used, a fatal error (F2114) will be output during assembly.
- Always keep all "callf function" definitions together in one group, and keep all "non-callf function" definitions together in another group.  
If you do not define these two function groups as separate groups, a warning (W2717) is issued at assemble time.
- When using variables set to extern in the C source inside of #asm blocks, if there is no reference within other parts written in C then the EXTRN is not generated and a link error occurs. Therefore, the EXTRN should be done within the #asm block when not referencing with C.
- When modifying a segment name with a #pragma section command, do not designate the segment name to be the same as the primary name of the source file name. An error (F2106) will be output during assembly.

**(4) Usable assembler package**

Errors may occur if you not use the assembler bundled to CubeSuite, because of memory bank support..

**(5) Link directive file creation**

When linking objects generated by the 78K0 C compiler, if using a region other than the ROM or RAM memory of the target device, or if you want to specify any address to allocate code or data, create a link directive file and specify linker option-d when linking.

See "[CHAPTER 5 LINK DIRECTIVE SPECIFICATION](#)" or the lk.dr (under the smp folder) included with the C compiler regarding the method for creating link directive files.

**Example** Allocating an initial value null external variable (other than an sreg variable) to external memory in a C source file.



- (a) **Modify the section name used for initial value null external variable at the head of the C source.**

```
#pragma section @@DATA  EXTDATA
:
```

**Caution** To initialize or ROMize the modified segment, do so by modifying the startup routine.

- (b) **Create the lk78k0.dr link directive file.**

```
memory EXTRAM : ( 0F000h, 00200h )
merge  EXTDATA : = EXTRAM
```

Pay attention to the following points when creating link directive files.

- When linking, if using stack resolution symbol creation designation option -s, it is recommended to secure the stack region with the link directive file's memory directive, and explicitly define the name of the secured stack region. If the region name is excluded, RAM memory (except for SFR memory) will be used as the stack region.

**Example** When the link directive file lk78k0.dr has been added to.

```
memory EXTRAM : ( 0F000h, 00200h )
memory STK      : ( 0FB00H, 20H )
merge  EXTDATA : = EXTRAM
```

The command line is as follows.

```
C>lk78k0 s01.rel prime.rel -bc10.lib -sSTK -dlk78k0.dr
```

- When linking to the defined memory region, the following link error may be output.

```
RA78K0 error E3206 : Segment 'xxx' can't allocate to memory-ignored.
```

This means that the specified segment cannot be allocated due to insufficient space in the specified memory region.

The method for dealing with this is divided broadly into the following 3 steps.

- <1> **Investigate the size of the segment that cannot be allocated (see the .map file).**  
**However, depending on the type of segment specified by the error, the method for investigating the segment size differs as follows.**
  - For segments automatically generated at time of compiling  
Investigate the segment size in the map file created from linking.
  - For user-created segments  
Investigate the size of the segment which was not allocated in the assembly list file (.prn).
- <2> **Based on the segment size found above, increase the memory size where the segment will be allocated with the directive file.**
- <3> **Specify option -d for the directive file specification and link.**

**(6) When using the va\_start macro**

Because the offset of the first argument differs depending on the function, operation of the va\_start macro defined in stdarg.h is not guaranteed.

Use the macro accordingly as follows.

- When specifying the first argument, use the va\_starttop macro.

**(7) Referencing SFRs (special function registers) by address constant**

Invalid code is generated when you access a 16-bit SFR by an address constant (it is accessed in 8-bit units).

Instead, use the SFR name. To pass 2 or more arguments, use the va\_start macro.

**(8) Regarding the startup routines and libraries**

- Use the same startup routine and library version offered as the version of the execute form file (cc78k0.exe) being used.

- In floating-point compatible sprintf, vprintf and vsprintf for the, values below the accuracy level of the "%f", "%e", "%E", "%g" and "%G" specified conversion results are rounded down. Additionally, "%f" conversion occurs even if the "%g" and "%G" specified conversion results are above the accuracy level.

In floating-point compatible sscanf and scanf, if no valid character is read at "%f", "%e", "%E", "%g" and "%G" specification then the conversion result will be +0, and if "±" is the only character recognized then the conversion result will be ± 0.

- The atof function, the strtod function, and the math functions do not support the pascal keyword.

Do not use these functions when the -zr compiler option is specified.

**(9) When ROMization is performed**

ROMization is the process of allocating an initial value such as an external variable with an initial value to ROM then copying it to RAM when the system is executed. The 78K0 C compiler by default generates code to be ROMized. Therefore it is necessary to link to a start-up routine that includes ROMization processing when linking.

The CA78K0 offers the following startup routines, all of which include ROMization processing.

If using flash memory self overwrite mode, please see "(3) Uses of startup routines".

When not using C standard library memory	s0.rel
When using C standard library memory	s0l.rel

A usage example is shown below.

The -s option is a stack symbol (\_@STBEG, \_@STEND) automatically generated option.

```
C>lk78k0 s0.rel sample.rel -s -bc10.lib -osample.lmf
```

sample.rel	User programmed object module file
s0.rel	Startup routine
cl0.lib	Runtime library, standard library

- Cautions 1. Be sure to link the startup routine first.**
- 2. When creating user-generated libraries, separate them from the libraries provided by CA78K0, and specify them ahead of the CA78K0 libraries when linking.**
  - 3. Do not add user functions to the CA78K0 libraries**
  - 4. When a floating-point library (cl0\*f.lib) is used, it is also necessary to link to the normal library (cl0\*.lib).**

**Example** When using floating-point compatible `sprintf`, `sscanf`, `printf`, `scanf`, `vprintf` and `vsprintf`.

```
-bmylib.lib -bc10f.lib -bc10.lib
```

**Example** When using `sprintf`, `sscanf`, `printf`, `scanf`, `vprintf` and `vsprintf` not compatible with floating point.

```
-bmylib.lib -bc10.lib -bc10f.lib
```

### (10) Prototype declaration

In a function prototype declaration, if the function type is not specified, an error (E0301, E0701) results.

```
f ( void );      /* E0301 : Syntax error */
                /* E0701 : External definition syntax */
```

In such a case, specify the function type.

```
int    f ( void );
```

### (11) Error message output

Outside the function, if there is a spelling error in the keyword at the beginning of a line, the display position of the error line may be shifted or an improper error may be output.

```
extren int      i ;          /* extern is misspelled. An error does not occur here.*/
/* comment */
void f ( void );
[EOF]                /* Error such as E0712 */
```

### (12) Comment input in the preprocessor directive

If a comment is inserted at the beginning or in the middle of a preprocessor directive in the function form macro row, an error occurs (E0803, E0814, E0821, etc.).

```
/* com1 */    #pragma      sfr                /* E0803 */
/* com2 */    #define      ONE      1        /* E0803 */
#define       /* com3 */    TWO      2        /* E0814 */
#ifdef       /* com4 */    ANSI_C          /* E0814 */

/* com5 */    #endif

#define       SUB ( p1, /* com6 */ p2 ) p2 = p1 /* E0821 */
```

In such a case, insert the comment after the preprocessor directive.

```
#pragma      sfr                               /* com1 */
#define      ONE      1                       /* com2 */
#define      TWO      2                       /* com3 */
#ifdef      ANSI_C                             /* com4 */

#endif                                             /* com5 */
#define      SUB ( p1, p2 ) p2 = p1           /* com6 */
```

### (13) Tag usage for structure, union and enum

In the function prototype declaration, if (structure, union and enum) tags are used before they are defined, a warning occurs if conditions (a) below are met, and an error occurs if conditions (b) below are met.

- (a) If the tag is used to define the pointers to structure and union in the argument declaration, a warning (W0510) occurs when the function is called.

```
void func ( int, struct st );

    struct st {
        char  memb1 ;
        char  memb2 ;
    } st[] = {
        { 1, ' a ' }, { 2, ' b ' }
    };

void caller ( void ) {
    /* W0510 Pointer mismatch */
    func ( sizeof ( st ) / sizeof ( st[0] ), st );
}
```

- (b) If the tag is used to designate structure, union and enum types for the return value declaration and argument statement, an error (E0737) will occur.

```
/* E0737 Undeclared structure/union/enum tag */
void func1 ( int, struct st );
/* E0737 Undeclared structure/union/enum tag */
struct st  func2 ( int );
struct st {
    char  memb1 ;
    char  memb2 ;
};
```

In such a case, first define the structure, union and enum tags.

**(14) Initializing arrays, structures and unions within a function**

Within a function, array, structure and union initialization cannot be performed using other than a static variable address, constant, and character string

```
void f ( void );

void f ( void ) {
    char    *p, *p1, *p2 ;
    char    *ca[3] = { p, p1, p2 };    /* Error( E0750 ) */
}
```

In such a case, enter an assignment statement and substitute it in place of initialization.

```
void f ( void );

void f ( void ) {
    char    *ca[3] ;
    char    *p, *p1, *p2 ;
    ca[0] = p ;  ca[1] = p1 ; ca[2] = p2 ;
}
```

**(15) Structure-returning functions**

When a function returns the structure itself, if an interrupt occurs during return processing of the return value and during interrupt processing the same function is called, the return value after completion of interrupt processing will be invalid.

```
struct  str {
    char    c ;
    int     i ;
    long    l ;
} st ;

struct  str    func ( ) {
    /* Interrupt occurs */
    :
}

void main ( ) {
    st = func ( ) ; /* Interrupt occurs */
}
```

During the processing excerpt above, if the func function is called at the interrupt destination, st may break down.

**(16)Memory initialization directives**

If memory initialization directives DB, DW are input with the data segment (DSEG), the object code will be output, but a warning (W4301) will occur at the object converter. This is because code exists at an address other than the ROM region (the coding region).

If ROM code is called (operations called across processing and tape-out) in this state, an error occurs.

**(17)Memory directives**

The default memory region name of each device cannot be erased.

Set the memory size for default memory names not being used to 0.

However, some segments may be assigned to the default regions, so be careful when modifying region names.

See the user manual of each device regarding default memory region names.

**(18)Segment names**

When inputting a segment name, do not give a segment a name that is the same as the primary name of the source file name. Abort error F2106 will occur at assembly.

**(19)EQU definition of SFR name**

An SFR name can be designated in the operand of an EQU directive, but if the name of an SFR outside the saddr area is designated an assemble error will occur.

**(20)Specifying section start addresses**

The size of a section that specifies a start address with a #pragma section directive is always an even number.

**(21)#line preprocessor directive**

Assembler source code debug information is incorrect when the #line preprocessor directive is used. An error (E2201) occurs if assembler source code containing this directive is assembled.

**Example**

```
#include <stdio.h>

void main (void) {
    int a;
#line 1 " test_line "
    a = 3;
    printf ( "__FILE__ = %s , __LINE__ = %d\n " , __FILE__ , __LINE__ );
}
```

To avoid this error, do one of the following.

- Use the object module file.
- Use the assembler source file without outputting debugging information.

**(22)Romization processing**

When multiple user libraries exist, and there are mutual references between the object muddle files for those user libraries, do not change the module name (@rom) of the end module (rom.asm) of the 78K0 C compiler. If the name is changed, final linking may fail.

## APPENDIX A INDEX

**Symbols**

- #asm - #endasm ... 100
  - #pragma access ... 121
  - #pragma bcd ... 150
  - #pragma BRK ... 117
  - #pragma DI ... 114
  - #pragma directive ... 71
  - #pragma div ... 148
  - #pragma EI ... 114
  - #pragma ext\_func ... 177
  - #pragma ext\_table ... 174
  - #pragma HALT ... 117
  - #pragma hromcall ... 193
  - #pragma inline ... 200
  - #pragma interrupt ... 105
  - #pragma mul ... 146
  - #pragma name ... 143
  - #pragma NOP ... 117
  - #pragma opc ... 161
  - #pragma realregister ... 187
  - #pragma rot ... 144
  - #pragma section ... 131
  - #pragma sfr ... 88
  - #pragma STOP ... 117
  - #pragma vect ... 105
  - ?A00nnnn ... 260
  - ?BSEG ... 260
  - ?CSEG ... 260
  - ?CSEGB0 to 15 ... 260
  - ?CSEGF0 ... 260
  - ?CSEGIX ... 260
  - ?CSEGOB0 ... 260
  - ?CSEGS0 ... 260
  - ?CSEGT0 ... 260
  - ?CSEGUP ... 260
  - ?DSEG ... 260
  - ?DSEGDSP ... 260
  - ?DSEGIH ... 260
  - ?DSEGIX ... 260
  - ?DSEGL ... 260
  - ?DSEGS ... 260
  - ?DSEGSP ... 260
  - ?DSEGUP ... 260
  - \_@BRKADR ... 785
  - \_@DIVR ... 785
  - \_@FNCENT ... 785
  - \_@FNCTBL ... 785
  - \_@LDIVR ... 785
  - \_@MEMBTM ... 785
  - \_@MEMTOP ... 785
  - \_@SEED ... 785
  - \_@STBEG ... 779, 780
  - \_@TOKPTR ... 785
- A**
- abort ... 659
  - abs ... 662
  - absolute address access function ... 73, 121
  - absolute address allocation specification ... 75, 202
  - absolute assembler ... 14
  - absolute segment ... 251, 314
  - absolute term ... 303
  - acos ... 707
  - acosf ... 730
  - ADDRESS ... 260
  - ADDRESS term ... 305
  - aggregate type ... 66
  - alphanumeric characters ... 257
  - alphanumeric characters ... 256
  - AND operator ... 280
  - ANSI ... 68
  - area reservation directives ... 337
  - arithmetic operator ... 270
  - array offset calculation simplification method ... 75, 185
  - array type ... 66
  - asin ... 708

asinf ... 731  
 \_\_asm ... 100  
 ASM statement ... 73, 100  
 assemble target type specification control instruction ...  
     375  
 assemble termination directive ... 372  
 assembler options ... 374  
 assembly language ... 13  
 assembly list control instructions ... 391  
 assert ... 603  
 assert.h ... 758  
 \_\_assertfail ... 753  
 AT ... 566  
 AT relocation attribute ... 317, 321, 325  
 atan ... 709  
 atan2 ... 710  
 atan2f ... 733  
 atanf ... 732  
 atexit ... 660  
 atof ... 668  
 atoi ... 651  
 atol ... 652  
 automatic pascal functionization of function call interface  
     ... 74

**B**

backward reference ... 310  
 bank function ... 74, 153, 159  
 bank function in a constant address ... 74  
 BANK0 AT to BANK15 AT relocation attribute ... 317  
 BANK0 to 15 relocation attribute ... 317  
 BANKNUM operator ... 300  
 BCD operation function ... 74, 150  
 binary ... 262  
 binary constant ... 74, 141  
 BIT ... 261  
 bit field ... 124  
 bit field declaration ... 73, 124, 126  
 bit segment ... 251, 314  
 bit symbol ... 308  
 bit type variable ... 73, 97

BITPOS operator ... 298  
 \_\_boolean ... 97  
 boolean type variable ... 73, 97  
 BR directive ... 355  
 branch instruction automatic selection directives ... 354  
 BRK ... 117  
 brk ... 666  
 bsearch ... 675  
 BSEG directive ... 324  
 byte separation operator ... 293

**C**

C language ... 13  
 \_\_callf ... 119  
 callf function ... 119  
 callf/\_\_callf function ... 73  
 calloc ... 655  
 callt function ... 72, 76  
 callt/\_\_callt ... 76  
 CALLT0 relocation attribute ... 317  
 ceil ... 725  
 ceilf ... 748  
 change from int and short types to char type ... 74, 167  
 change from long type to int type ... 74, 168  
 changing compiler output section name ... 74  
 char type ... 62  
 character set ... 256  
 character string constant ... 263  
 character type ... 66  
 code segment ... 251, 314  
 comment field ... 265, 449  
 compiler output section name is changed ... 131  
 COMPLETE ... 566  
 concatenation ... 447  
 COND control instruction ... 402  
 conditional assembly control instructions ... 414  
 constant ... 262  
 control instructions ... 374  
 cos ... 711  
 cosf ... 734  
 cosh ... 714



coshf ... 737  
 CPU control instruction ... 73, 117  
 cross-reference list output specification control  
   instructions ... 382  
 CSEG directive ... 316  
 cstart\*.asm ... 777  
 cstart.asm ... 774, 777  
 cstartn.asm ... 774, 777  
 ctype.h ... 591, 754

**D**

data insertion function ... 74, 161  
 data segment ... 251, 314  
 DATAPOS operator ... 297  
 DB directive ... 338  
 DBIT directive ... 344  
 DEBUG control instruction ... 378  
 debug information output control instructions ... 377  
 DEBUGA control instruction ... 380  
 decimal ... 262  
 DGL control instruction ... 442  
 DGS control instruction ... 442  
 DI ... 114  
 directive ... 313  
 directive file ... 561  
 \_\_directmap ... 202  
 div ... 664  
 division function ... 74, 148  
 DS directive ... 342  
 DSEG directive ... 320  
 DSPRAM relocation attribute ... 321  
 DW directive ... 340

**E**

EI ... 114  
 EJECT control instruction ... 392  
 ELSE control instruction ... 428  
 \_ELSEIF control instruction ... 425  
 ELSEIF control instruction ... 422  
 END directive ... 373  
 ENDIF control instruction ... 432

ENDM directive ... 370  
 enumeration type ... 63  
 EQ operator ... 284  
 EQU directive ... 331  
 \_errno ... 785  
 errno.h ... 597  
 error.h ... 597  
 EUC ... 103  
 exit ... 661  
 EXITM directive ... 367  
 exp ... 717  
 expf ... 740  
 EXTBIT directive ... 348  
 external reference term ... 303  
 EXTRN directive ... 346

**F**

fabs ... 726  
 fabsf ... 749  
 firmware ROM function ... 75, 181  
 FIXED relocation attribute ... 317  
 \_\_flash ... 181  
 flash area allocation method ... 74, 173  
 flash area branch table ... 74, 174  
 \_\_flashf function ... 75, 197  
 float.h ... 601  
 floating point type ... 63  
 floor ... 727  
 floorf ... 750  
 fmod ... 728  
 fmodf ... 751  
 FORMFEED control instruction ... 409  
 forward reference ... 310  
 free ... 656  
 frexp ... 718  
 frexpf ... 741  
 function of function call from boot area to flash area ...  
   177  
 function type ... 66

**G**

GE operator ... 287  
 GEN control instruction ... 398  
 general register ... 263  
 general register pairs ... 263  
 getchar ... 646  
 gets ... 647  
 global symbol ... 446  
 GT operator ... 286

**H**

HALT ... 117  
 hardware initialization function ... 780  
 hdwinit function ... 777, 780  
 Header File ... 591  
 hexadecimal ... 262  
 HIGH operator ... 294  
 [HL + B] based indexed addressing utilization method ...  
     75, 191  
 how to use the saddr area ... 72  
 how to use the sfr area ... 73

**I**

\_IF control instruction ... 419  
 IF control instruction ... 415  
 IHRAM relocation attribute ... 321  
 INCLUDE control instruction ... 388  
 include control instruction ... 387  
 incomplete type ... 66  
 integer type ... 62  
 \_\_interrupt ... 112  
 interrupt function ... 73, 105, 114  
 interrupt function qualifier ... 73, 112  
 \_\_interrupt\_brk ... 112  
 IRP directive ... 365  
 IRP-ENDM block ... 365  
 isalnum ... 610  
 isalpha ... 606  
 isascii ... 617  
 iscntrl ... 616  
 isgraph ... 615

islower ... 608  
 isprint ... 614  
 ispunct ... 613  
 isspace ... 612  
 isupper ... 607  
 isxdigit ... 611  
 itoa ... 670  
 IXRAM relocation attribute ... 317, 321

**K**

Kanji (2-byte character) ... 73, 103  
 Kanji code control instruction ... 440  
 KANJICODE control instruction ... 441

**L**

label ... 258  
 labs ... 663  
 LANG78K ... 103  
 ldexp ... 719  
 ldexpf ... 742  
 ldiv ... 665  
 LE operator ... 289  
 LENGTH control instruction ... 412  
 library supporting prologue/epilogue ... 75, 216  
 limits.h ... 597  
 link directive ... 561, 567, 779  
 linkage directives ... 345  
 LIST control instruction ... 394  
 LOCAL directive ... 360  
 local symbol ... 446  
 log ... 720  
 log10 ... 721  
 log10f ... 744  
 logf ... 743  
 logic operator ... 278  
 longjmp ... 627  
 LOW operator ... 295  
 LRAM relocation attribute ... 321  
 LT operator ... 288  
 ltoa ... 671

**M**

macro ... 443  
 macro definition ... 443  
 MACRO directive ... 358  
 macro directives ... 357  
 macro expansion ... 445  
 macro name ... 258  
 macro operator ... 447  
 malloc ... 657  
 MASK operator ... 299  
 math.h ... 599, 757  
 matherr ... 729  
 memchr ... 692  
 memcmp ... 689  
 memcpy ... 683  
 memmove ... 684  
 MEMORY ... 566  
 memory directive ... 562  
 memory initialization directives ... 337  
 memory manipulation function ... 75, 200  
 memory model ... 67  
 memory space ... 67  
 memset ... 700  
 MERGE ... 566  
 method of int expansion limitation of argument/return  
     value ... 75, 182  
 mkstup.bat ... 772, 775  
 mnemonic field ... 261, 449  
 MOD operator ... 275  
 modf ... 722  
 modff ... 745  
 modular programming ... 14  
 module header ... 250  
 module name ... 258  
 module name changing function ... 74, 143  
 module tail ... 251  
 MOV ... 472  
 MOVW ... 476  
 multiplication function ... 74, 146

**N**

name ... 258  
 NAME directive ... 353  
 NE operator ... 285  
 noauto function ... 73, 91  
 NOCOND control instruction ... 403  
 NODEBUG control instruction ... 379  
 NODEBUGA control instruction ... 381  
 NOFORMFEED control instruction ... 410  
 NOGEN control instruction ... 400  
 NOLIST control instruction ... 396  
 NONE ... 103  
 NOP ... 117  
 norec function ... 94  
 norec/\_\_leaf function ... 73  
 NOSYMLIST control instruction ... 386  
 NOT operator ... 279  
 NOXREF control instruction ... 384  
 NUMBER ... 260  
 NUMBER term ... 305  
 numeric constant ... 262

**O**

object module name declaration directive ... 352  
 octal ... 262  
 on-chip firmware self-programming subroutine direct call  
     function ... 75, 193  
 \_\_OPC ... 161  
 operand ... 309, 310  
 operand field ... 262, 449  
 operator ... 267  
 OPT\_BYTE relocation attribute ... 317  
 OR operator ... 281  
 ORG directive ... 328  
 other operator ... 301

**P**

\_\_pascal ... 169  
 pascal function ... 74, 169  
 pascal function call interface ... 238  
 peekb ... 121

peekw ... 121  
 pokeb ... 121  
 pokew ... 121  
 pow ... 723  
 powf ... 746  
 printf ... 642  
 PROCESSOR control instruction ... 376  
 PUBLIC directive ... 350  
 putchar ... 648  
 puts ... 649

**Q**

-qe ... 191  
 -ql option ... 76  
 qsort ... 676  
 -qw2 ... 185

**R**

rand ... 673  
 realloc ... 658  
 re-entrant ... 603  
 referencing macro ... 444  
 register ... 78  
 register bank ... 67  
 register bank is specified ... 105  
 register direct reference function ... 75, 187  
 register variable ... 72, 78  
 REGULAR ... 563, 565  
 relocatable assembler ... 14  
 relocatable term ... 303  
 relocation attribute ... 303, 317, 321, 325  
 repgetc.bat ... 772  
 repmudiu.bat ... 772  
 repputc.bat ... 772  
 repputcs.bat ... 772  
 reprom.bat ... 772  
 repselo.bat ... 772  
 repselon.bat ... 772  
 REPT directive ... 363  
 REPT-ENDM block ... 363  
 repvect.bat ... 772

RESET control instruction ... 438  
 reset vector ... 780  
 rolb ... 144  
 rolw ... 144  
 rom.asm ... 777  
 ROMization ... 771, 787  
 ROMization processing ... 780, 784  
 ROMization routine ... 772  
 rorb ... 144  
 row ... 144  
 rotate function ... 74, 144  
 runtime library ... 787

**S**

s0\*.rel ... 777  
 SADDR relocation attribute ... 321  
 SADDRP relocation attribute ... 321  
 saddr 領域利用 ... 72  
 sbrk ... 667  
 scanf ... 643  
 section name related to ROMization ... 137  
 SECUR\_ID relocation attribute ... 317  
 segment ... 251  
 segment definition directive ... 314  
 segment location directive ... 564  
 SEQUENT ... 566  
 SET control instruction ... 436  
 SET directive ... 335  
 setjmp ... 626  
 setjmp.h ... 592, 754  
 sfr area ... 88  
 sfr variable ... 88  
 shift operator ... 290  
 SHL operator ... 292  
 SHR operator ... 291  
 signed integer type ... 63  
 sin ... 712  
 sinf ... 735  
 sinh ... 715  
 sinhf ... 738  
 SJIS ... 103

- source module ... 250
- special characters ... 257, 263
- special function register ... 263
- special operator ... 296
- sprintf ... 634
- sqrt ... 724
- sqrtf ... 747
- srand ... 674
- sreg ... 81
- sscanf ... 638
- stack change specification ... 107
- stack pointer ... 780
- standard library ... 787
- startup ... 771
- startup module ... 784
- startup routine ... 137, 767, 805
- statement ... 256
- static model ... 74, 163
- static model expansion specification ... 75, 205
- stdarg.h ... 593, 754
- stddef.h ... 598
- stdio.h ... 593, 755
- stdlib.h ... 594, 755
- STOP ... 117
- strbrk ... 677
- strcat ... 687
- strchr ... 693
- strcmp ... 690
- strcoll ... 703
- strcpy ... 685
- strcspn ... 696
- strerror ... 701
- string.h ... 596, 756
- strtoa ... 679
- strlen ... 702
- strltoa ... 680
- strncat ... 688
- strncmp ... 691
- strncpy ... 686
- strpbrk ... 697
- strrchr ... 694
- strsbrk ... 678
- strspn ... 695
- strstr ... 698
- strtod ... 669
- strtok ... 699
- strtol ... 653
- strtoul ... 654
- structure type ... 66
- strultoa ... 681
- strxfrm ... 704
- subroutine ... 443
- SUBTITLE control instruction ... 406
- symbol ... 446
- symbol attribute ... 260
- symbol definition directives ... 330
- symbol field ... 449
- SYMLIST control instruction ... 385
  
- T**
- TAB control instruction ... 413
- tan ... 713
- tanf ... 736
- tanh ... 716
- tanhf ... 739
- \_\_temp ... 213
- temporary variable ... 75, 213
- TITLE control instruction ... 404
- toascii ... 620
- TOL\_INF control instruction ... 442
- tolow ... 624
- \_tolower ... 623
- tolower ... 619
- toup ... 622
- toupper ... 618
  
- U**
- ultoa ... 672
- union type ... 66
- UNIT relocation attribute ... 317, 321, 325
- UNITP relocation attribute ... 317, 321
- unsigned integer type ... 63

usage with saddr automatic allocation option for  
arguments/automatic variables ... 72

usage with saddr automatic allocation option of external  
variables/external static variables ... 72

usage with saddr automatic allocation option of internal  
static variables ... 72

use the saddr area ... 81

## V

va\_arg ... 631

va\_end ... 632

va\_start ... 629

va\_starttop ... 630

vprintf ... 644

vsprintf ... 645

## W

WIDTH control instruction ... 411

## X

XCH ... 474

XCHW ... 478

XOR operator ... 282

XREF control instruction ... 383

## Z

-zb ... 182

-zd ... 216

-zf ... 173

-zi ... 167

-zl ... 168

-zm ... 205

-zr ... 172

Revision Record

Rev.	Date	Description	
		Page	Summary
1.00	Jul 01, 2010	-	First Edition issued

---

CubeSuite Ver.1.30  
User's Manual: 78K0 Coding

Publication Date: Rev.1.00 Jul 01, 2010

Published by: Renesas Electronics Corporation

---



**SALES OFFICES****Renesas Electronics Corporation**<http://www.renesas.com>Refer to "<http://www.renesas.com/>" for the latest and detailed information.**Renesas Electronics America Inc.**2880 Scott Boulevard Santa Clara, CA 95050-2554, U.S.A.  
Tel: +1-408-588-6000, Fax: +1-408-588-6130**Renesas Electronics Canada Limited**1101 Nicholson Road, Newmarket, Ontario L3Y 9C3, Canada  
Tel: +1-905-898-5441, Fax: +1-905-898-3220**Renesas Electronics Europe Limited**Dukes Meadow, Millboard Road, Bourne End, Buckinghamshire, SL8 5FH, U.K  
Tel: +44-1628-585-100, Fax: +44-1628-585-900**Renesas Electronics Europe GmbH**Arcadiastrasse 10, 40472 Düsseldorf, Germany  
Tel: +49-211-65030, Fax: +49-211-6503-1327**Renesas Electronics (China) Co., Ltd.**7th Floor, Quantum Plaza, No.27 ZhiChunLu Haidian District, Beijing 100083, P.R.China  
Tel: +86-10-8235-1155, Fax: +86-10-8235-7679**Renesas Electronics (Shanghai) Co., Ltd.**Unit 204, 205, AZIA Center, No.1233 Lujiazui Ring Rd., Pudong District, Shanghai 200120, China  
Tel: +86-21-5877-1818, Fax: +86-21-6887-7858 / -7898**Renesas Electronics Hong Kong Limited**Unit 1601-1613, 16/F., Tower 2, Grand Century Place, 193 Prince Edward Road West, Mongkok, Kowloon, Hong Kong  
Tel: +852-2886-9318, Fax: +852 2886-9022/9044**Renesas Electronics Taiwan Co., Ltd.**7F, No. 363 Fu Shing North Road Taipei, Taiwan  
Tel: +886-2-8175-9600, Fax: +886 2-8175-9670**Renesas Electronics Singapore Pte. Ltd.**1 harbourFront Avenue, #06-10, Keppel Bay Tower, Singapore 098632  
Tel: +65-6213-0200, Fax: +65-6278-8001**Renesas Electronics Malaysia Sdn.Bhd.**Unit 906, Block B, Menara Amcorp, Amcorp Trade Centre, No. 18, Jln Persiaran Barat, 46050 Petaling Jaya, Selangor Darul Ehsan, Malaysia  
Tel: +60-3-7955-9390, Fax: +60-3-7955-9510**Renesas Electronics Korea Co., Ltd.**11F., Samik Lavied' or Bldg., 720-2 Yeoksam-Dong, Kangnam-Ku, Seoul 135-080, Korea  
Tel: +82-2-558-3737, Fax: +82-2-558-5141

CubeSuite Ver.1.30



Renesas Electronics Corporation

R20UT0004EJ0100