

ISL85415EVAL2Z

Wide VIN, Negative VOUT, Synchronous Buck-Boost Regulator up to 500mA
Evaluation Board

AN1934
Rev 1.00
February 8, 2017

Description

The ISL85415EVAL2Z kit is intended for point-of-load applications sourcing from 3V to 31V. The kit is used to demonstrate the performance of the ISL85415 wide VIN, low quiescent current, high efficiency, synchronous buck-boost regulator, in a negative output configuration with up to 500mA output current.

The ISL85415 is offered in a 4mm x 3mm 12 Ld DFN package with 1mm maximum height. The converter occupies 2.418cm² area.

Specifications

This board has been configured and optimized for the following operating conditions:

- $V_{IN} = 3V$ to 31V
- $V_{OUT} = -5V$
- $I_{MAX} = 500mA$ (at $V_{IN} = 31V$)
- Peak efficiency: >85.6% at 250mA, $V_{IN} = 12V$
- Board temperature: +25°C

Related Literature

- For a full list of related documents, visit our website
 - [ISL85415](#) product page

Key Features

- Wide input voltage range, 3V to 31V
- Synchronous operation for high efficiency
- Integrated high-side and low-side NMOS devices
- Programmable switching frequency (fixed or externally synchronized)
- Continuous output current up to 500mA (See [Figure 7](#))
- Internal or external soft-start
- Minimal external components required
- Power-good and enable functions available
- On-board jumper for selecting PFM or forced PWM at light loads
- On-board EN switch

Recommended Equipment

The following materials are recommended to perform testing:

- 0V to 50V power supply with at least 2A source current capability
- Electronic loads capable of sinking current up to 1.5A
- Digital Multimeters (DMMs)
- 100MHz quad-trace oscilloscope

Ordering Information

PART NUMBER	DESCRIPTION
ISL85415EVAL2Z	Wide VIN (3V-31V) Negative VOUT Sync Buck-Boost Integrated FET Regulator up to 500mA

TABLE 1. EXTERNAL COMPONENT SELECTION

V _{OUT} (V)	L ₁ (μH)	C ₅ ,C ₆ (μF)	R ₁ (kΩ)	R ₂ (kΩ)	C ₄ (pF)	R _{FS} (kΩ)	R ₃ (kΩ)	C ₇ (pF)	C ₈ (pF)
-12	47	2x22	90.9	4.75	180	115	49.9	2200	220
-5	22	2x22	90.9	12.4	220	120	20	2200	220
-3.3	22	2x22	90.9	20	220	120	20	2200	220

PCB Layout Guidelines

The ISL85415EVAL2Z PCB layout has been optimized for electrical and thermal performance. Proper layout of the power converter will minimize EMI and noise while ensuring first pass success of the design.

PCB layouts are provided in multiple formats on the Intersil website. In addition, [Figures 3 to 6](#) will clarify the important points in PCB layout. PCB layout of the ISL85415EVAL2Z is quite simple.

A multi-layer printed circuit board with GND plane is recommended. [Figure 3](#) shows the connections of the critical components in the converter. The most critical connections are to tie the PGND pin to the package GND pad and then use vias to directly connect the GND pad to the system GND plane. This connection of the GND pad to system plane insures a low impedance path for all return current, as well as an excellent thermal path to dissipate heat.

With this connection made, place the high frequency MLCC input capacitors C₁, C₂ near the VIN pin and use vias directly at the capacitor pads to tie the capacitors to the system GND plane. Also use vias directly at the C₅, C₆ output capacitor pads to tie the capacitors to the system GND plane. These measures will minimize the high dV/dt and dI/dt loops.

Minimize the PHASE connection by placing L₁ close to the IC and on the same side. Place the BOOT capacitor (C₃) very close to the IC.

Place a 1μF MLCC near the VCC pin and directly connect its return with a via to the system GND plane.

Keep the power components path (L₁, C₁, C₂, C₃, C₅, C₆) separated from the small signal nodes (FB, COMP) and the control components path (FS, SS) by placing the feedback divider close to the FB pin and do not route any feedback components near PHASE or BOOT. If external components are used for SS, COMP, or FS, the same advice applies. Connect these control components and small signal noise components to system GND.

Keep the small signal nodes traces (FB, COMP) as short as possible.

Quick Setup Guide

1. Ensure that the circuit is correctly connected to the supply and loads prior to applying any power.
2. Connect the bias supply to VIN, the plus terminal to VIN (P4), and the negative return to GND (P5).
3. Verify that the position is ON for SW1.
4. Turn on the power supply.
5. Verify the output voltage is -5V for -V_{NEG} (P7).

Evaluating the Other Output Voltages

The ISL85415VAL1Z kit output is preset to -5V, however the output can be adjusted from -3.3V to -12V. The output voltage programming resistor, R₂, will depend on the desired output voltage of the regulator and the value of the feedback resistor R₁, as shown in [Equation 1](#).

$$R_2 = R_1 \left(\frac{0.6}{V_{OUT} - 0.6} \right) \quad (\text{EQ. 1})$$

[Table 1](#) shows the component selection that should be used for the respective V_{OUTS} of -3.3V, -5V and -12V.

The curves in [Figure 7](#) indicate the maximum output current the converter can deliver as a function of the input voltage and the selected output voltage configuration.

[Figures 8, 9, and 10](#) show the efficiency for different input voltage, output voltage and load combinations. [Figures 11, 12, and 13](#) show the output regulation with load while [Figures 14, 15, and 16](#) show the output regulation with input voltage for different output voltages. [Figures 17 to 21](#) show some performance curves of the board during start-up, shutdown, steady state, and load transient.

Frequency Control

The ISL85415 has an FS pin that controls the frequency of operation. Programmable frequency allows for optimization between efficiency and external component size. It also allows low frequency operation for low V_{OUTS} when minimum on time would limit the operation otherwise. Default switching frequency is 500kHz when FS is tied to V_{CC} (R₁₀ = 0). By removing R₁₀, the switching frequency could be changed from 300kHz (R₁₂ = 340k) to 2MHz (R₁₂ = 32.4k). Refer to the [ISL85415](#) datasheet for calculating the value of R₁₀. Do not leave this pin floating.

Disabling/Enabling Function

The ISL85415EVAL2Z evaluation board contains a SW1 switch that enables or disables the part, thus allowing low quiescent current state. [Table 2](#) details this function.

TABLE 2. SWITCH SETTINGS

SW1	ON/OFF CONTROL
ON	Enable V _{OUT}
OFF	Disable V _{OUT}

SYNC Control

The ISL85415EVAL2Z evaluation board has a SYNC pin that allows external synchronization frequency to be applied. Default board configuration has $R_6 = 200k$ to V_{CC} , which defaults to PWM operation mode and also to the pre-selected switching frequency set by R_{12} (see datasheet and previous section [“Frequency Control” on page 2](#) for details). If this pin is tied to

GND the IC will operate in PFM mode. JP1 switch allows to force the PFM or PWM modes.

Soft-Start /COMP Control

R_{15} selects between internal ($R_{15} = 0$) and external soft-start. R_{11} selects between internal ($R_{11} = 0$) and external compensation. Refer to the Pin Description Table (Page 3) of the [ISL85415](#) datasheet.

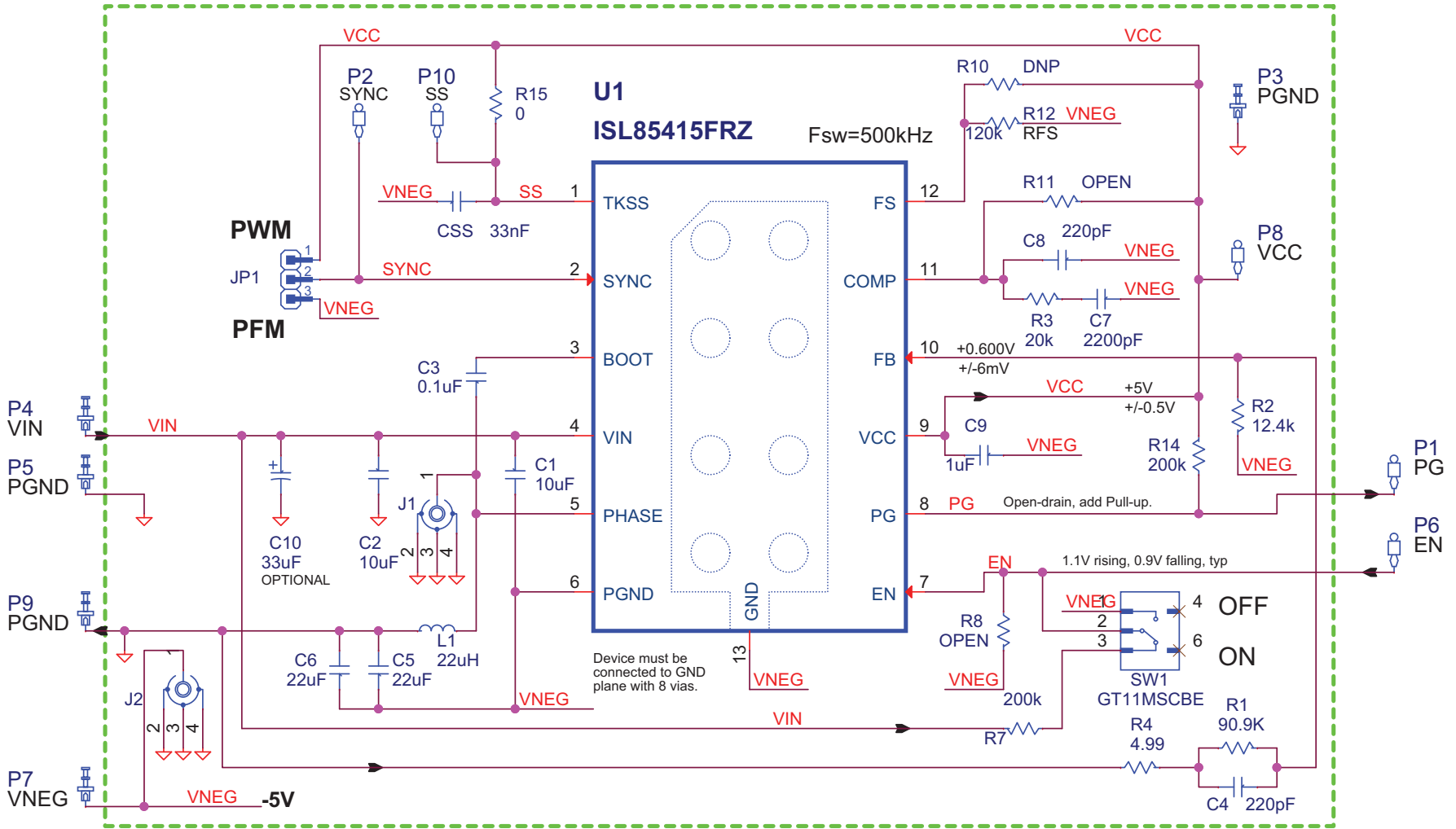

FIGURE 1. FRONT OF EVALUATION BOARD ISL85415EVAL2Z



FIGURE 2. BACK OF EVALUATION BOARD ISL85415EVAL2Z

ISL85415EVAL2Z Schematic



NOTE: The input electrolytic capacitor C₁₀ is optional and it is used to prevent transient voltages when the input test leads have large parasitic inductance. It can be removed if the IC is used in a system application.

ISL85415EVAL2Z Bill of Materials

PART NUMBER	QTY	REF-DES	DESCRIPTION	MANUFACTURER
ISL8541XEVAL2ZREVAPCB	1	N/A	PCB - ISL85415 NEGATIVE VOUT EVALUATION BOARD	Imagineering Inc
EEE-HA1H330UP	1	C10	CAP, SMD, 8mm, 33uF, 50V, 20%, ALUM. ELEC, ROHS	Panasonic
GRM188R71H221JA01D	1	C4, C8	CAP, SMD, 0603, 220pF, 50V, 5%, X7R, ROHS	Murata
06035C104KAT2A	1	C3	CAP, SMD, 0603, 0.1uF, 50V, 10%, X7R, ROHS	AVX
GRM188R61C105KA12D	1	C9	CAP, SMD, 0603, 1uF, 16V, 10%, X5R, ROHS	Murata
GRM188R71H222JA01D	1	C7	CAP, SMD, 0603, 2200pF, 50V, 5%, X7R, ROHS	Murata
C3216X5R1H106K	2	C1,C2	CAP, SMD, 1206, 10uF, 50V, 10%, X5R, ROHS	TDK
ECJ-DV50J226M	1	C5	CAP, SMD, 1206, 22uF, 6.3V, 20%, X5R, ROHS	Panasonic
C1608X5R0J226M	1	C6	CAP, SMD, 0603, 22uF, 6.3V, 20%, X5R, ROHS	TDK
131-4353-00	2	J1,J2	CONN-SCOPE PROBE TEST PT, COMPACT, PCB MNT, ROHS	Tektronix
68000-236HLF	1	JP1	CONN-HEADER, 1x3, BREAKAWY 1X36, 2.54mm, ROHS	Berg/FCI
1514-2	5	P4,P5,P3, P7,P9	CONN-TURRET, TERMINAL POST, TH, ROHS	Keystone
5002	5	P1,P2,P6, P8,P10	CONN-MINI TEST POINT, VERTICAL, WHITE, ROHS	Keystone
RNCF0603DTE4R99	1	R4	RES, SMD, 0603, 4.99Ω, 1/10W, 0.5%, TF, ROHS	Stackpole
CR0603-10W-000T	1	R15	RES, SMD, 0603, 0Ω, 1/10W, TF, ROHS	Venkel
ERJ-PB3D2002V	1	R3	RES, SMD, 0603, 20K, 1/5W,0.5%, TF, ROHS	Panasonic Electronic Components
CR0603-10W-1242FT(PbFREE)	1	R2	RES, SMD, 0603, 12.4K, 1/10W, 1%, TF, ROHS	Venkel
ERJ-3EKF9092V	1	R1	RES, SMD, 0603, 90.9K, 1/10W, 1%, TF, ROHS	Panasonic
CRCW0603120KFKEA	1	R12	RES, SMD, 0603, 120K, 1/10W, 1%, TF, ROHS	Vishay/Dale
GT11MSCBE	1	SW1	SWITCH-TOGGLE, SMD, 6PIN, SPDT, 2POS, ON-ON, ROHS	ITT Industries/ C&K Division
DR73-220-R	1	L1	COIL-PWR INDUCTOR, SMD, 7.6mm, 22uH, 20%, 1.62A, ROHS	Cooper/Coiltronics
ISL85415FRZ	1	U1	IC-500mA BUCK REGULATOR, 12P, DFN, 3X4, ROHS	Intersil
GRM188R71H221JA01D	1	C8	CAP, SMD, 0603, 220pF, 50V, 5%, X7R, ROHS	Murata
	0	R8,R10,R 11	RES, SMD, 0603, DNP-PLACE HOLDER, ROHS	
C0603X7R160-333KNE	1	CSS	CAP, SMD, 0603, 33000pF, 16V, 10%, X7R, ROHS	Venkel
LABEL-RENAME BOARD	1		ISL85415EVAL2Z.	Intersil
CR0603-10W-2003FT	2	R14,R7	RES, SMD, 0603, 200K, 1/10W, 1%, TF, ROHS	Venkel
SPC02SYAN	1	JP1-PWM	CONN-JUMPER, SHORTING, 2PIN, BLACK, GOLD, ROHS	Sullins

ISL85415EVAL2Z Board Layout

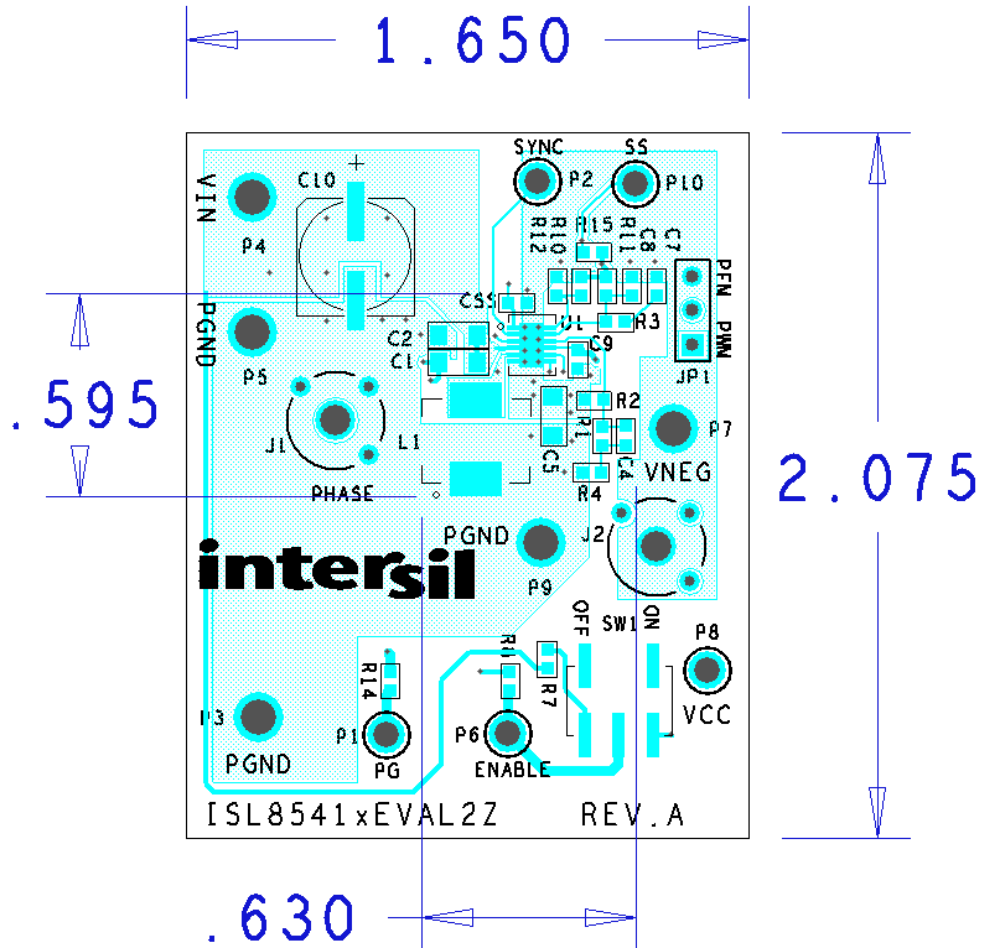

FIGURE 3. TOP

ISL85415EVAL2Z Board Layout (Continued)

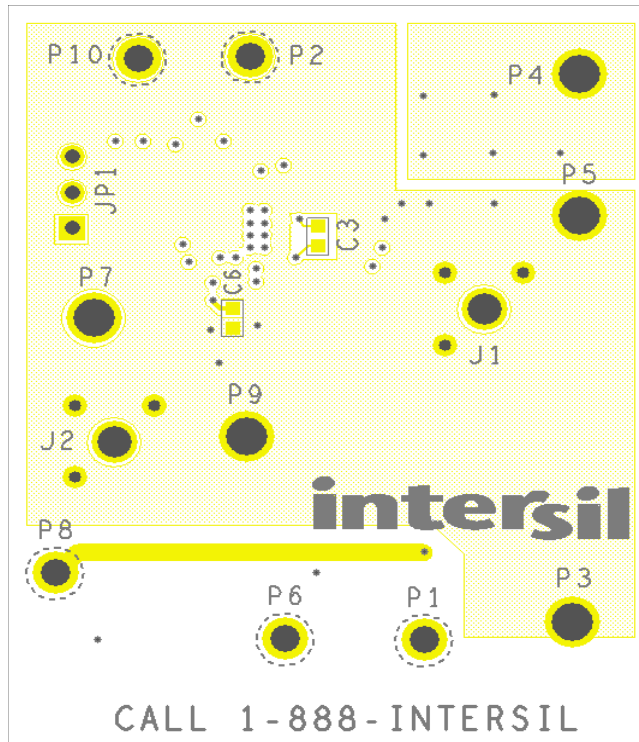

FIGURE 4. BOTTOM

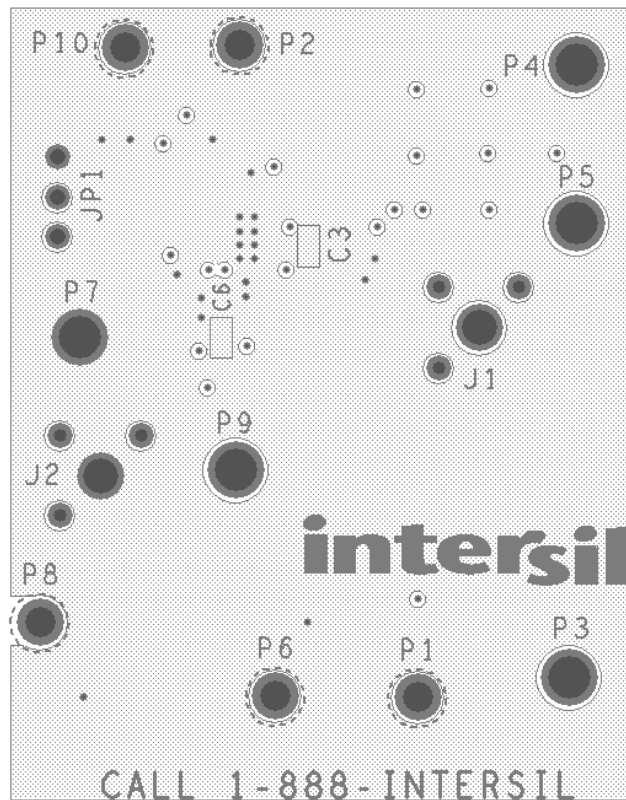

FIGURE 5. LAYER 2

ISL85415EVAL2Z Board Layout (Continued)

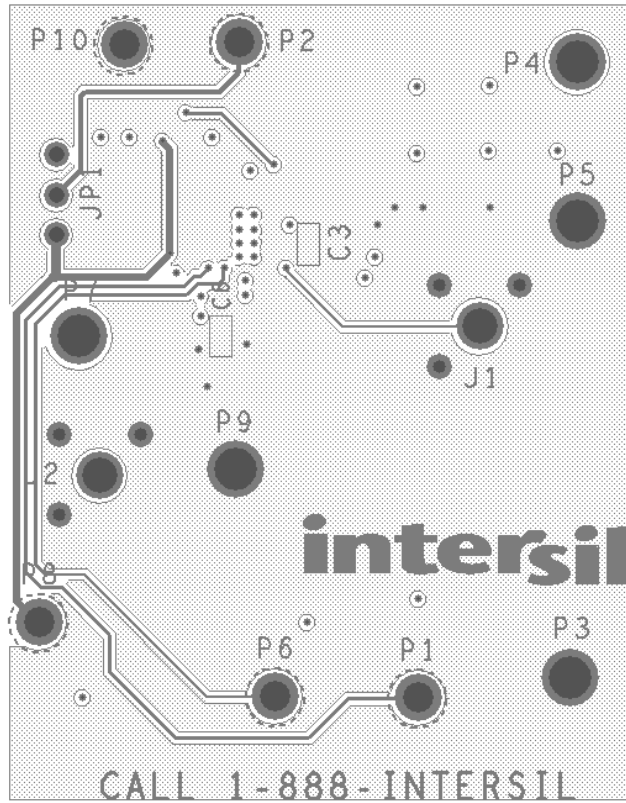

FIGURE 6. LAYER 3

Typical Performance Curves

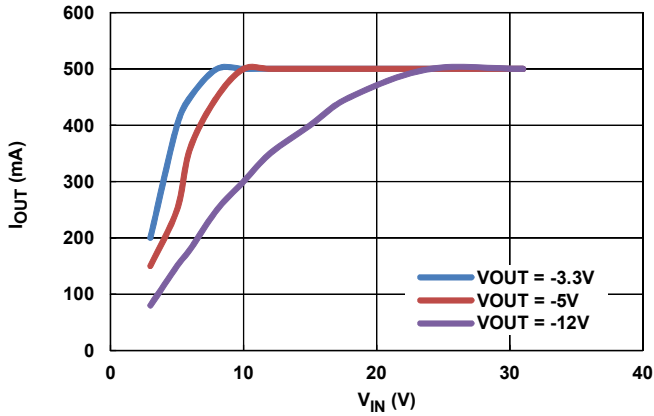

FIGURE 7. MAXIMUM I_{OUT} VS V_{IN} , $-V_{OUT}$

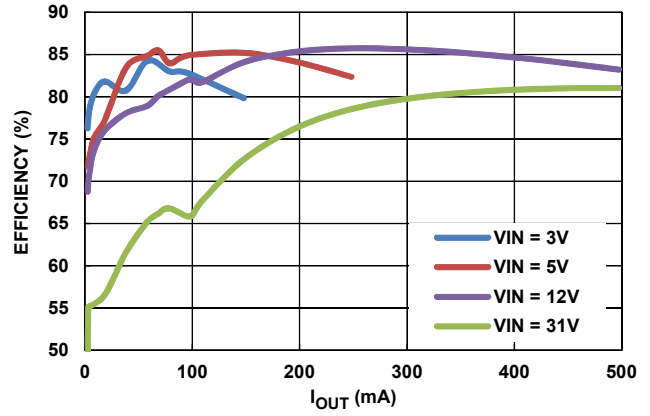

FIGURE 8. PFM EFFICIENCY, $V_{OUT} = -5V$

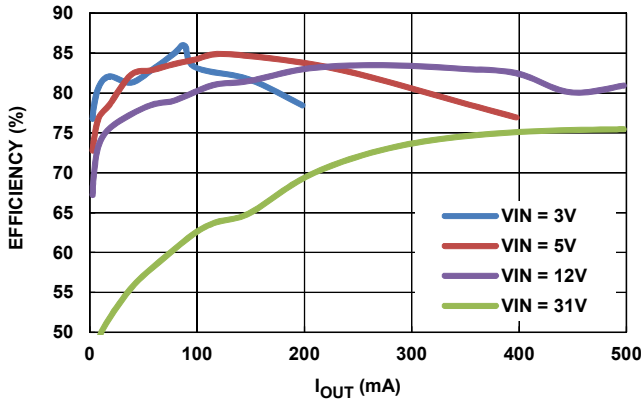

FIGURE 9. PFM EFFICIENCY, $V_{OUT} = -3.3V$

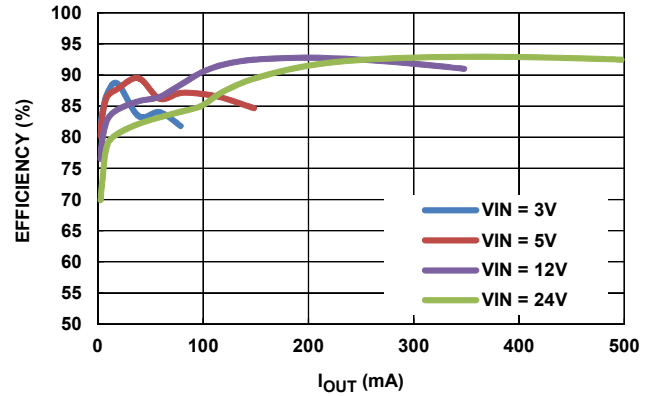

FIGURE 10. PFM EFFICIENCY, $V_{OUT} = -12V$

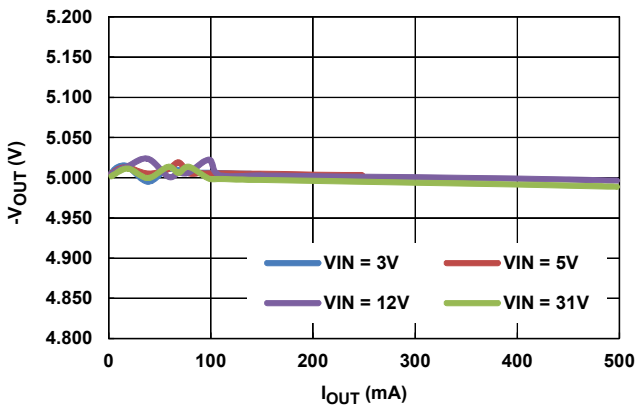

FIGURE 11. PFM LOAD REGULATION, $V_{OUT} = -5V$

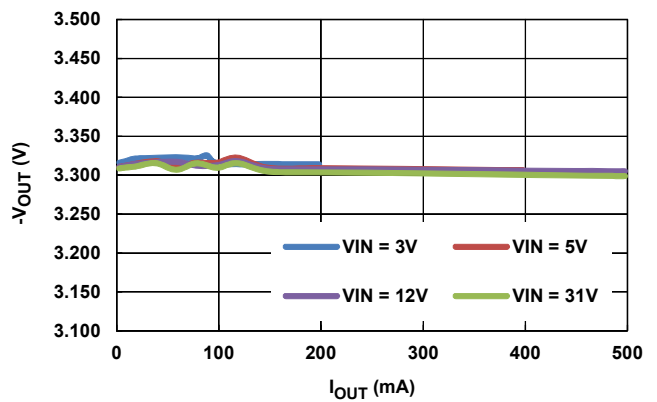

FIGURE 12. PFM LOAD REGULATION, $V_{OUT} = -3.3V$

Typical Performance Curves (Continued)

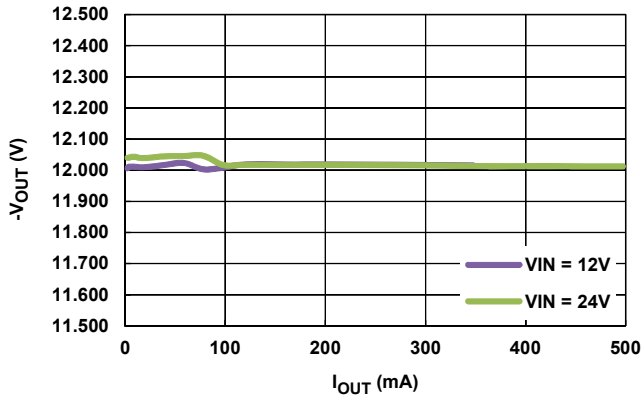

FIGURE 13. PFM LOAD REGULATION, $V_{OUT} = -12V$

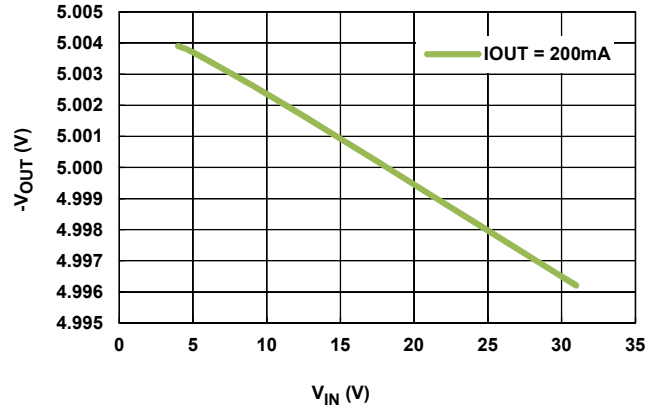

FIGURE 14. PFM LINE REGULATION, $V_{OUT} = -5V$, $I_{OUT} = 200mA$

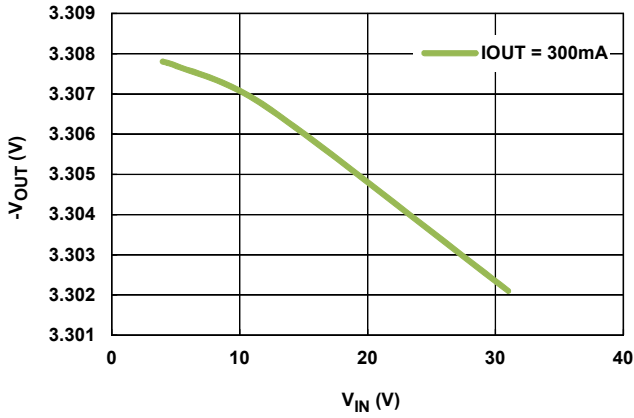

FIGURE 15. PFM LINE REGULATION, $V_{OUT} = -3.3V$, $I_{OUT} = 300mA$

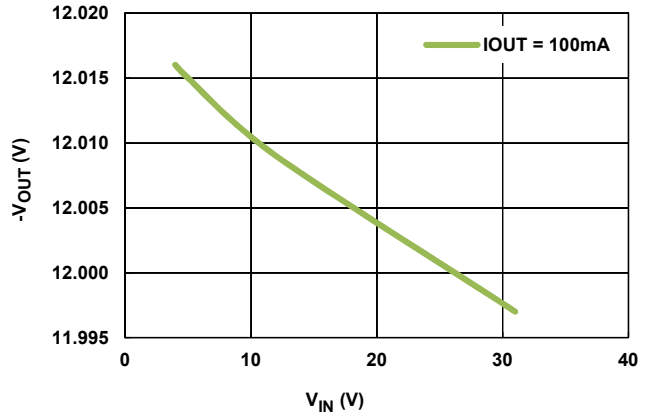

FIGURE 16. PFM LINE REGULATION, $V_{OUT} = -12V$, $I_{OUT} = 100mA$

Typical Performance Curves

$V_{IN} = 24V$, $V_{OUT} = -5V$, MODE = PWM, FSW = 800kHz, $T_A = +25^{\circ}C$

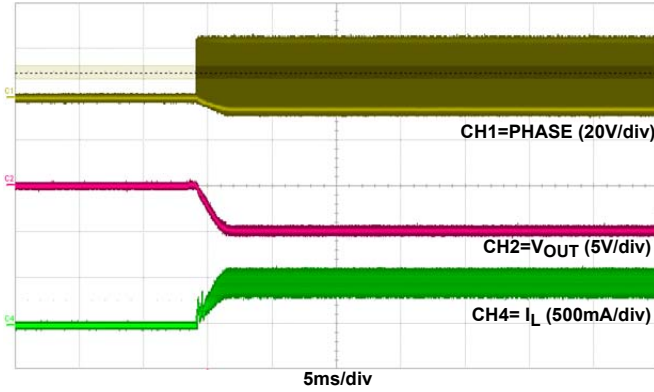

FIGURE 17. STARTUP AT 500MA

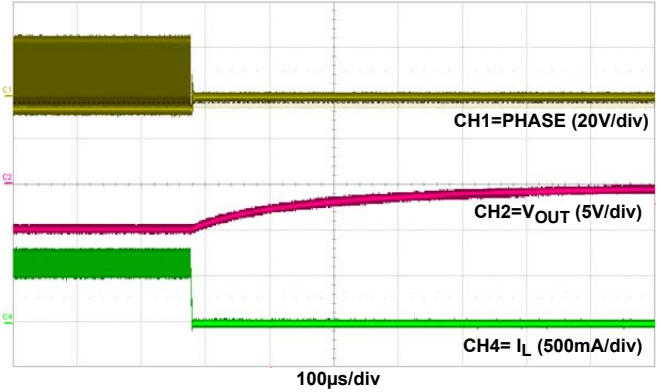

FIGURE 18. SHUTDOWN AT 500MA

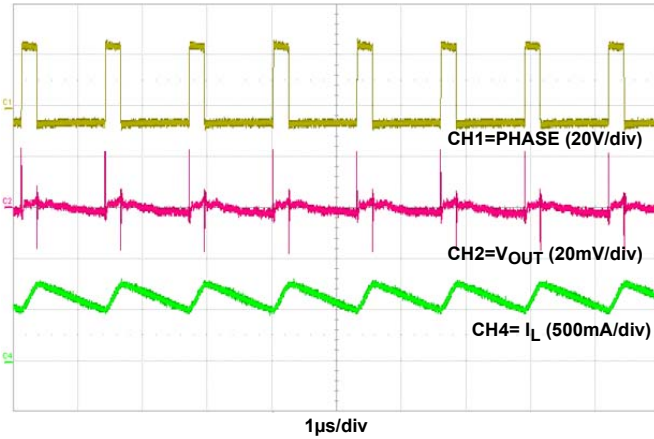

FIGURE 19. STEADY STATE AT 500MA LOAD

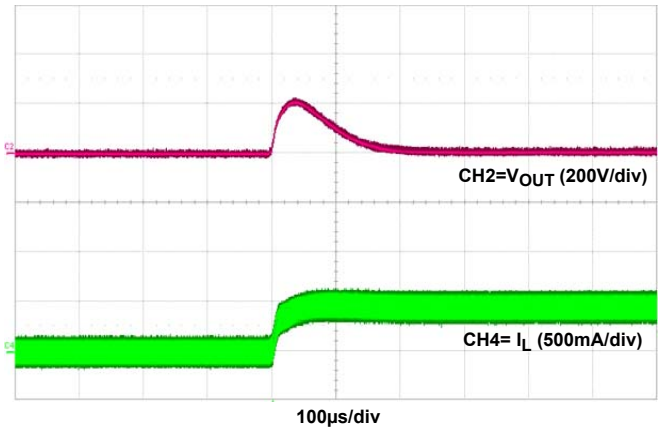

FIGURE 20. LOAD TRANSIENT

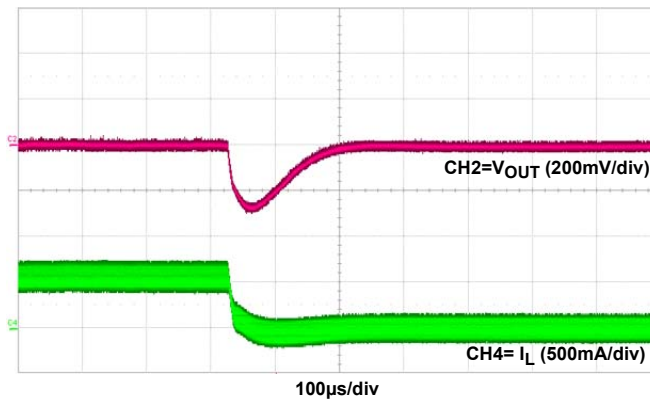

FIGURE 21. LOAD TRANSIENT

Notice

1. Descriptions of circuits, software and other related information in this document are provided only to illustrate the operation of semiconductor products and application examples. You are fully responsible for the incorporation or any other use of the circuits, software, and information in the design of your product or system. Renesas Electronics disclaims any and all liability for any losses and damages incurred by you or third parties arising from the use of these circuits, software, or information.
2. Renesas Electronics hereby expressly disclaims any warranties against and liability for infringement or any other claims involving patents, copyrights, or other intellectual property rights of third parties, by or arising from the use of Renesas Electronics products or technical information described in this document, including but not limited to, the product data, drawings, charts, programs, algorithms, and application examples.
3. No license, express, implied or otherwise, is granted hereby under any patents, copyrights or other intellectual property rights of Renesas Electronics or others.
4. You shall not alter, modify, copy, or reverse engineer any Renesas Electronics product, whether in whole or in part. Renesas Electronics disclaims any and all liability for any losses or damages incurred by you or third parties arising from such alteration, modification, copying or reverse engineering.
5. Renesas Electronics products are classified according to the following two quality grades: "Standard" and "High Quality". The intended applications for each Renesas Electronics product depends on the product's quality grade, as indicated below.
"Standard": Computers; office equipment; communications equipment; test and measurement equipment; audio and visual equipment; home electronic appliances; machine tools; personal electronic equipment; industrial robots; etc.
"High Quality": Transportation equipment (automobiles, trains, ships, etc.); traffic control (traffic lights); large-scale communication equipment; key financial terminal systems; safety control equipment; etc.
Unless expressly designated as a high reliability product or a product for harsh environments in a Renesas Electronics data sheet or other Renesas Electronics document, Renesas Electronics products are not intended or authorized for use in products or systems that may pose a direct threat to human life or bodily injury (artificial life support devices or systems; surgical implantations; etc.), or may cause serious property damage (space system; undersea repeaters; nuclear power control systems; aircraft control systems; key plant systems; military equipment; etc.). Renesas Electronics disclaims any and all liability for any damages or losses incurred by you or any third parties arising from the use of any Renesas Electronics product that is inconsistent with any Renesas Electronics data sheet, user's manual or other Renesas Electronics document.
6. When using Renesas Electronics products, refer to the latest product information (data sheets, user's manuals, application notes, "General Notes for Handling and Using Semiconductor Devices" in the reliability handbook, etc.), and ensure that usage conditions are within the ranges specified by Renesas Electronics with respect to maximum ratings, operating power supply voltage range, heat dissipation characteristics, installation, etc. Renesas Electronics disclaims any and all liability for any malfunctions, failure or accident arising out of the use of Renesas Electronics products outside of such specified ranges.
7. Although Renesas Electronics endeavors to improve the quality and reliability of Renesas Electronics products, semiconductor products have specific characteristics, such as the occurrence of failure at a certain rate and malfunctions under certain use conditions. Unless designated as a high reliability product or a product for harsh environments in a Renesas Electronics data sheet or other Renesas Electronics document, Renesas Electronics products are not subject to radiation resistance design. You are responsible for implementing safety measures to guard against the possibility of bodily injury, injury or damage caused by fire, and/or danger to the public in the event of a failure or malfunction of Renesas Electronics products, such as safety design for hardware and software, including but not limited to redundancy, fire control and malfunction prevention, appropriate treatment for aging degradation or any other appropriate measures. Because the evaluation of microcomputer software alone is very difficult and impractical, you are responsible for evaluating the safety of the final products or systems manufactured by you.
8. Please contact a Renesas Electronics sales office for details as to environmental matters such as the environmental compatibility of each Renesas Electronics product. You are responsible for carefully and sufficiently investigating applicable laws and regulations that regulate the inclusion or use of controlled substances, including without limitation, the EU RoHS Directive, and using Renesas Electronics products in compliance with all these applicable laws and regulations. Renesas Electronics disclaims any and all liability for damages or losses occurring as a result of your noncompliance with applicable laws and regulations.
9. Renesas Electronics products and technologies shall not be used for or incorporated into any products or systems whose manufacture, use, or sale is prohibited under any applicable domestic or foreign laws or regulations. You shall comply with any applicable export control laws and regulations promulgated and administered by the governments of any countries asserting jurisdiction over the parties or transactions.
10. It is the responsibility of the buyer or distributor of Renesas Electronics products, or any other party who distributes, disposes of, or otherwise sells or transfers the product to a third party, to notify such third party in advance of the contents and conditions set forth in this document.
11. This document shall not be reprinted, reproduced or duplicated in any form, in whole or in part, without prior written consent of Renesas Electronics.
12. Please contact a Renesas Electronics sales office if you have any questions regarding the information contained in this document or Renesas Electronics products.
(Note 1) "Renesas Electronics" as used in this document means Renesas Electronics Corporation and also includes its directly or indirectly controlled subsidiaries.
(Note 2) "Renesas Electronics product(s)" means any product developed or manufactured by or for Renesas Electronics.

(Rev.4.0-1 November 2017)



SALES OFFICES

Renesas Electronics Corporation

<http://www.renesas.com>

Refer to "<http://www.renesas.com/>" for the latest and detailed information.

Renesas Electronics America Inc.
1001 Murphy Ranch Road, Milpitas, CA 95035, U.S.A.
Tel: +1-408-432-8888, Fax: +1-408-434-5351

Renesas Electronics Canada Limited
9251 Yonge Street, Suite 8309 Richmond Hill, Ontario Canada L4C 9T3
Tel: +1-905-237-2004

Renesas Electronics Europe Limited
Dukes Meadow, Millboard Road, Bourne End, Buckinghamshire, SL8 5FH, U.K
Tel: +44-1628-651-700, Fax: +44-1628-651-804

Renesas Electronics Europe GmbH
Arcadiastrasse 10, 40472 Düsseldorf, Germany
Tel: +49-211-6503-0, Fax: +49-211-6503-1327

Renesas Electronics (China) Co., Ltd.
Room 1709 Quantum Plaza, No.27 ZhichunLu, Haidian District, Beijing, 100191 P. R. China
Tel: +86-10-8235-1155, Fax: +86-10-8235-7679

Renesas Electronics (Shanghai) Co., Ltd.
Unit 301, Tower A, Central Towers, 555 Langao Road, Putuo District, Shanghai, 200333 P. R. China
Tel: +86-21-2226-0888, Fax: +86-21-2226-0999

Renesas Electronics Hong Kong Limited
Unit 1601-1611, 16/F., Tower 2, Grand Century Place, 193 Prince Edward Road West, Mongkok, Kowloon, Hong Kong
Tel: +852-2265-6688, Fax: +852-2886-9022

Renesas Electronics Taiwan Co., Ltd.
13F, No. 363, Fu Shing North Road, Taipei 10543, Taiwan
Tel: +886-2-8175-9600, Fax: +886-2-8175-9670

Renesas Electronics Singapore Pte. Ltd.
80 Bendemeer Road, Unit #06-02 Hyflux Innovation Centre, Singapore 339949
Tel: +65-6213-0200, Fax: +65-6213-0300

Renesas Electronics Malaysia Sdn.Bhd.
Unit 1207, Block B, Menara Amcorp, Amcorp Trade Centre, No. 18, Jln Persiaran Barat, 46050 Petaling Jaya, Selangor Darul Ehsan, Malaysia
Tel: +60-3-7955-9390, Fax: +60-3-7955-9510

Renesas Electronics India Pvt. Ltd.
No.777C, 100 Feet Road, HAL 2nd Stage, Indiranagar, Bangalore 560 038, India
Tel: +91-80-67208700, Fax: +91-80-67208777

Renesas Electronics Korea Co., Ltd.
17F, KAMCO Yangjae Tower, 262, Gangnam-daero, Gangnam-gu, Seoul, 06265 Korea
Tel: +82-2-558-3737, Fax: +82-2-558-5338