

RL78 MICROCONTROLLERS

The True Low Power Microcontroller Platform



BIG IDEAS
FOR EVERY SPACE

RL78 THE TRUE LOW POWER MICROCONTROLLER PLATFORM

RL78 from Renesas Electronics is an advanced family of general purpose and application specific microcontrollers (MCU's) combining true low power and high performance operation. RL78's innovative Snooze mode allows serial communication and ADC operation in standby, which makes it best in class for battery powered designs.

Why RL78?

- World's best in class performance for an equivalent MCU family
- Scalability of physical size including smart pin layout
- System cost saving features
- Wide voltage operation
- Wide temperature operation
- On board security features
- An extensive ecosystem and more details of RL78 can be found at www.renesas.eu/RL78

CONTENT

Why RL78?_____	02	RL78 with USB_____	22
RL78 Roadmap – A growing family __	03	RL78 Low pin count_____	24
RL78 Low Power Modes _____	04	RL78/G1G – Motor Control_____	26
RL78 Line-Up _____	06	RL78 smart choice for	
RL78 Reducing System Cost _____	07	detector & sensor_____	28
RL78 Applications_____	08	Package Line-up_____	30
Compatibility & Scalability_____	10	RL78 for Motor Control _____	32
RL78 General purpose Line-up_____	11	RL78/G1D Intelligent Bluetooth®	
High Efficiency & Flexibility_____	12	Smart MCUs _____	34
RL78 with advanced peripherals_____	16	RL78 Development Tools and Kits ____	36
RL78 with LCD Drive_____	18	RL78 Part Number Guide _____	38
RL78 Family Overview_____	20	Getting started with	
RL78 Family Peripherals_____	21	RL78 is easy! _____	39

Extensive Ecosystem

- Comprehensive development tools
- 3rd party support
- Free E2 Studio GNU IDE
- Free Applilet peripheral driver

True Low Power

- 46 μ A/MHz Operation¹
- 0.57 μ A (RTC + LVD)
- Unique "Snooze" mode

Broad Scalability

- 10 to 128 pins
- 1 KB to 512 KB Flash
- Compatibility

High Quality & Safety

- Flash memory with ECC
- IEC 60730 Safety functions
- High temperature support
- -40 to 105 °C, -40 to 125 °C

System Cost Reduction

- 64/32 MHz +/- 1% Internal Oscillator
- Data Flash with BGO 1 Million erase cycles²
- Onboard temperature sensor & LVD

High Performance

- Up to 1.6 DMIPS / MHz
- Up to 32 MHz operation
- 1.6 V to 5.5 V operation
- DMA or DTC³
- Event Link Controller
- Direct Transfer Controller

¹ 66 μ A at 32 MHz (NOP instruction)

² Typical value

³ DTC: Direct Transfer Control

RL78 Roadmap – A growing family

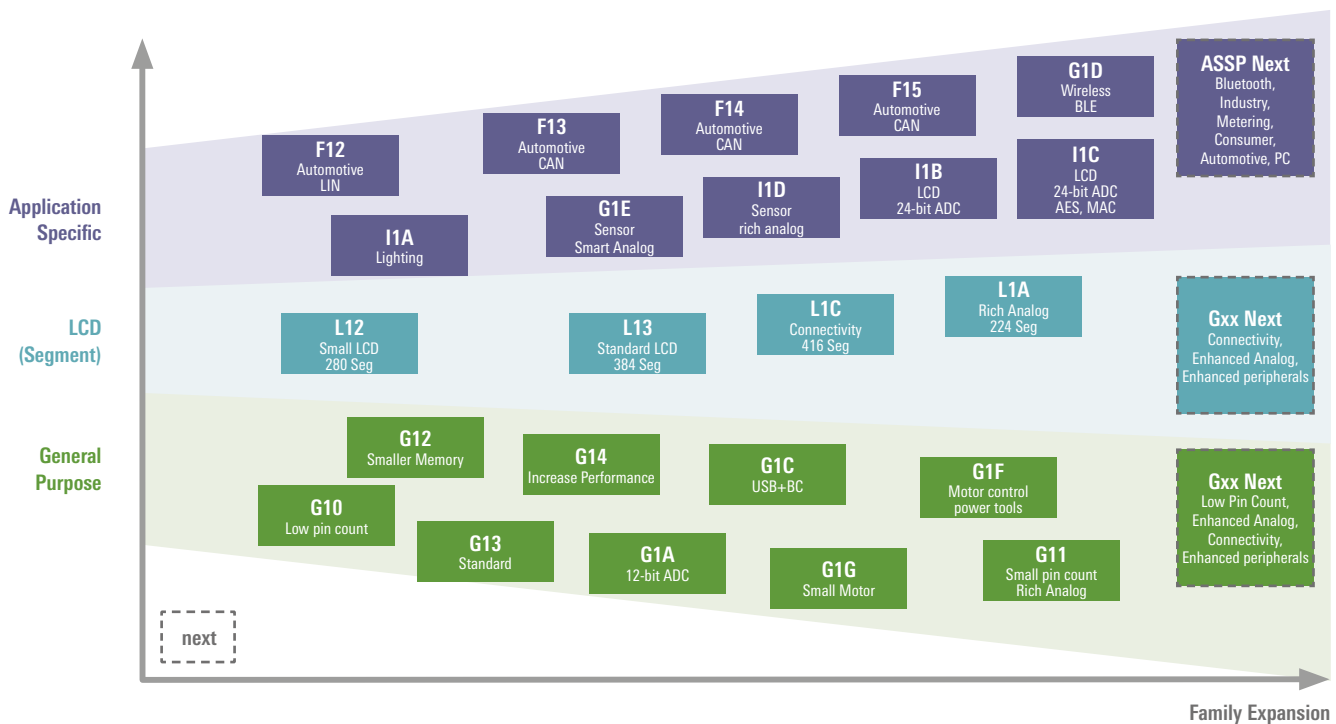

RL78 LOW POWER MODES

RL78 offers multiple power saving modes

- RL78's three low power modes maximise battery life, by offering flexible low power states to minimise CPU run time

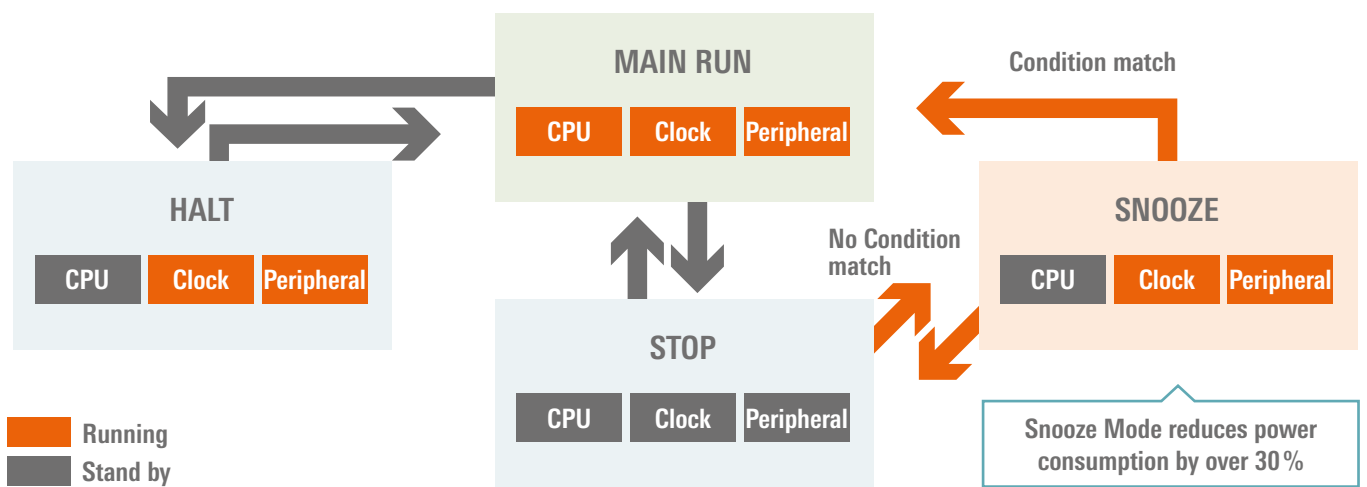

Snooze Mode

- No need to wake up CPU for receiving data
- The unique Snooze Mode allows some peripherals ie. ADC and UART operation whilst in standby modes
- Achieve 1/10th of the power consumption; Snooze mode uses 0.5 mA vs. 5 mA in Run mode (ADC)

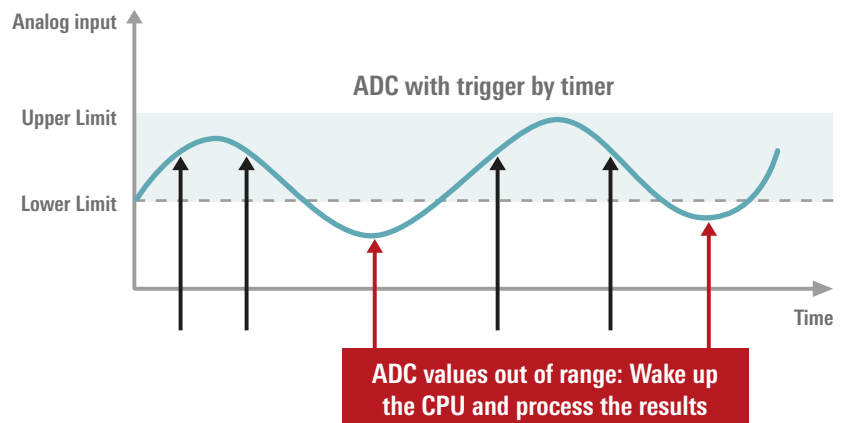

Snooze Mode ADC conversion example

Standby Modes

- Halt mode disables CPU operation saving as much as 80% of total MCU current, whilst allowing fast CPU enable time
- STOP mode achieves lowest power consumption by disabling more CPU functions

RL78 Wide Operating Voltage

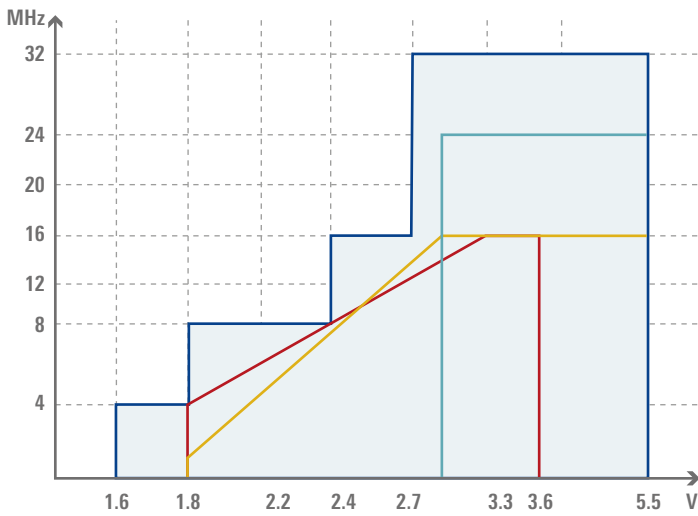

- RL78/G13, G14
- Company A
- Company B
- Company C

Power Consumption Values

Current consumed in Main Run mode ($\mu\text{A}/\text{MHz}$)

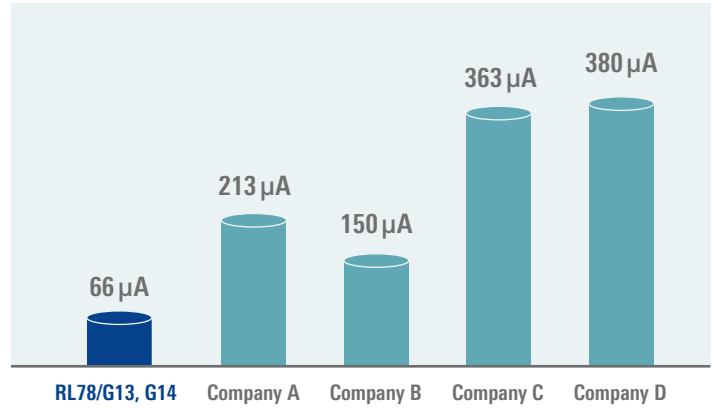

Current consumed in Halt mode (32.768 kHz, RTC + LVD)

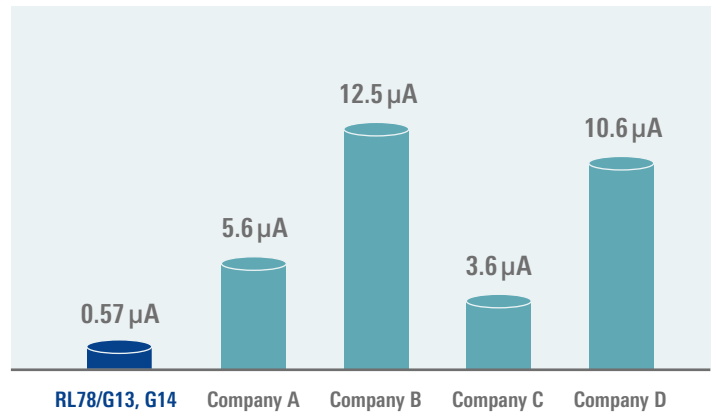

Current consumed in Stop mode (WDT + LVD)

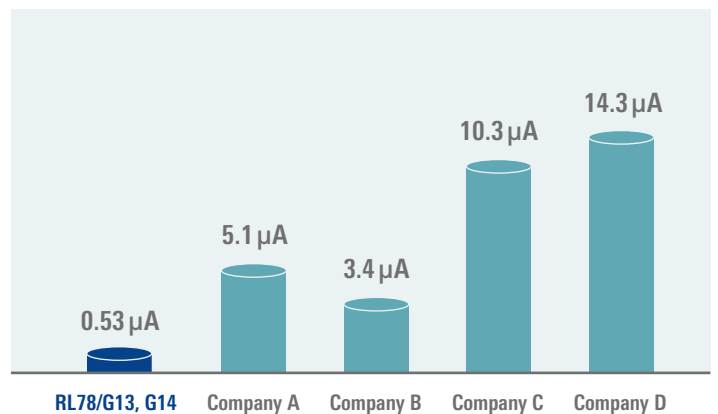

Source: data sheets and actual measurement

RL78 REDUCING SYSTEM COST

High Accuracy On-Chip Oscillator

- High speed On-Chip Oscillator with + / -1% accuracy
 - over temperature and voltage
 - -20 to 85 °C and 1.8 V to 5.5 V
- Two selectable pre-set frequencies
 - 24 MHz and 32 MHz / 64 MHz (*1)
 - 16 MHz, 12 MHz, 8 MHz, 4 MHz, 3 MHz, 2 MHz,
 - 1 MHz by using Divider
- 64 MHz (+ / -1%) available on RL78/G14 family
 - for high speed motor controller drive
- Improved accuracy with correction register

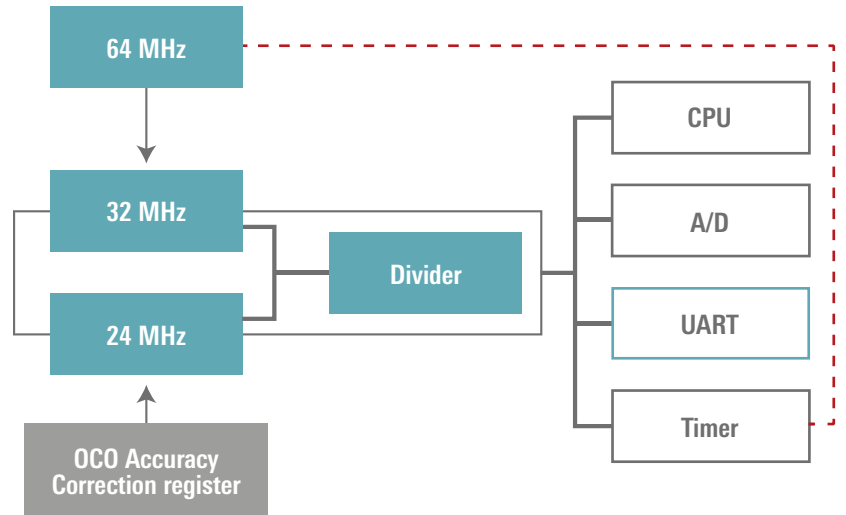

Data Flash

- Up to 8 KB

Rich Analog Features

- High accuracy OpAmp
- Analog Comparator
- Configurable voltage Vref

Integrated Temp Sensor

Integrated low voltage detectors

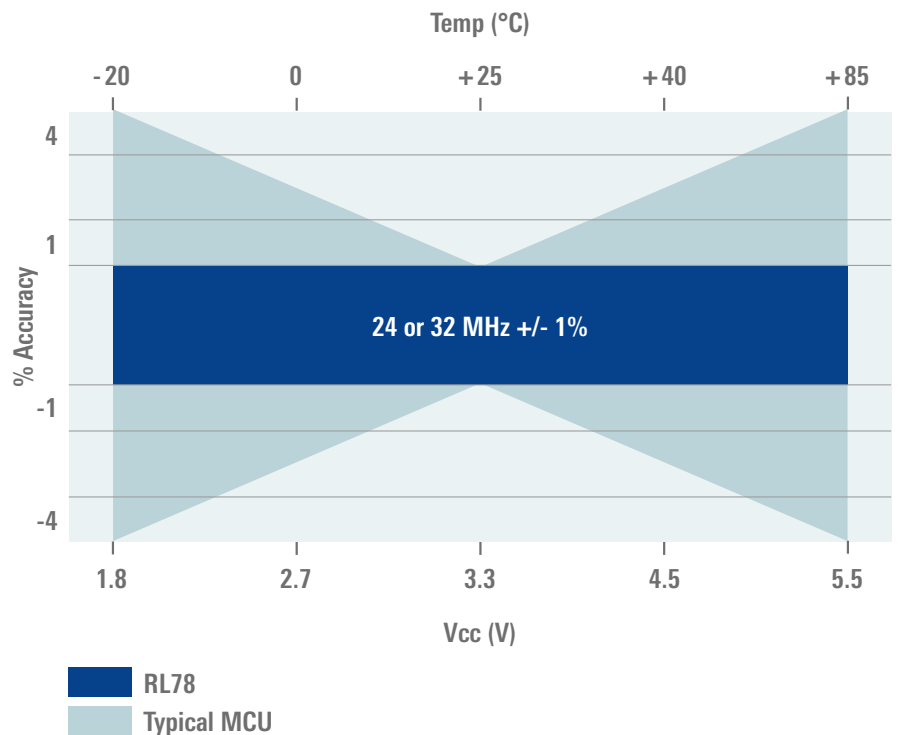

RL78 APPLICATIONS

RL78 offers System Designers key advantages for next generation designs, reducing system power, enhancing integration and providing a cost effective platform approach.

Industrial Automation

- RL78 offers an extensive range of small packages
- RL78 has standard and extended temperature range devices from -40 to +105 °C
- Renesas has a proven track record in IA with complimentary ASIC and ASSP solutions



Lighting

- RL78/I1A offers dedicated DALI and Power Factor control
- RL78's free windows based Applilet software make it easy for designers to turn around a lighting design with little design experience
- RL78/I1A integrates high resolution PWM timers



Consumer

- RL78 MCU's offer a full calendar function
- RL78 has an integrated temperature sensor



Home Automation

- For long battery life, RL78 offers class leading low power including the unique Snooze mode
- Battery operation down to 1.6 V



White Goods

- RL78 offers integrated safety compliance for white goods (IEC 60730)
- RL78 offers high temperature support
- RL78's integrated peripherals make it the ideal choice for cost sensitive white goods



Power Tools

- Renesas is renowned for high quality long life MCU's
- RL78 is available in multiple packages and scalable for the platform design approach



Medical

- When a small package MCU with long product life is required, RL78 is your first choice
- Renesas provides solutions for Tier one Medical manufacturers and is part of the Continua alliance



Motor Control

- RL78/G14 family is ideal for motor control applications with integrated MC timers
- RL78's on chip oscillators with 1% accuracy provide an integrated low cost solution for timing critical applications



Metering

- RL78's low power modes make the MCU ideal to meet industry power consumption requirements
- RL78 is analog rich, ideal for smart metering applications
- Renesas has three decades experience of providing high quality and long product life MCU's within metering



Detectors and Sensors

- RL78/I1D offers high integration features in order to fit with detector and sensor applications
- Fast wake up, rich Analog integration, smart intelligence like DTC, ELC, DOC with lowest power on chip oscillator at 34 μ A
- Ideal device for battery powered products



RL78 GENERAL PURPOSE LINE-UP

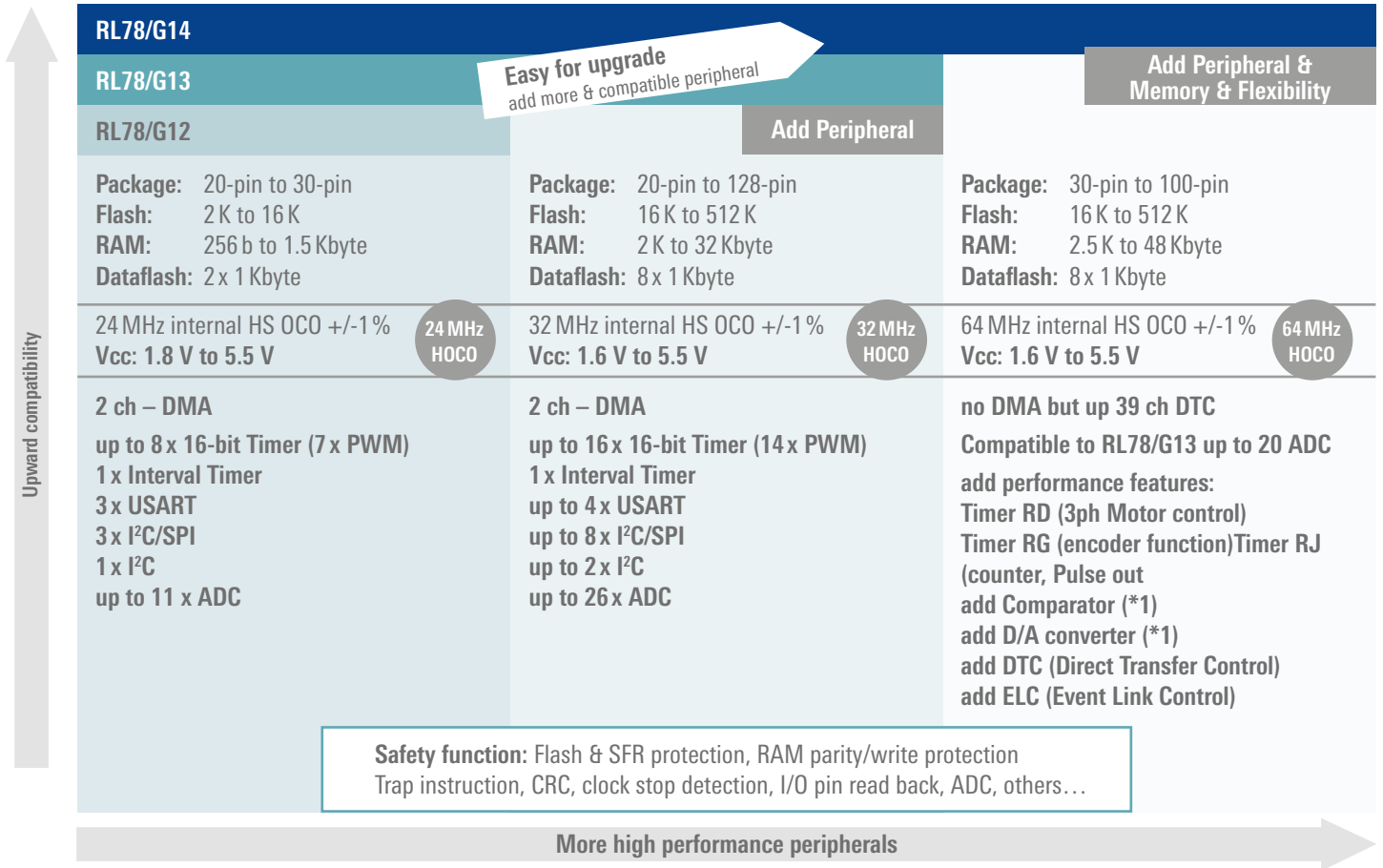

Choose RL78 for your Application

Low Power

- Battery operation down to 1,6V
- Active: down to 46uA@1MHz
- HALT: down to 300nA
- Stop: down 230 nA
- SNOOZE function: ADC and UART operation while standby
- RAM data retention in STOP mode

High Quality and Safety

- Flash memory with ECC
- IEC 60730 Safety functions
- CRC calculation
- RAM/SFR write protection
- Support +105°C and +125°C

Intelligent Peripherals

- Direct Transfer Controller (DTC)
- Direct Memory Access (DMA)
- Direct Operation Controller (DOC) combined with DTC/DMAC enables useful operations without CPU
- Event Link Controller (ELC)

Scalability

- Compatible Line-up
- +1000 devices
- Wide package range: 10pin to 128pin
- Broad memory: 1kB to 512kB

Special Features

- +/-1% 64/32/24MHz OCO (over temp and voltage range)
- 3ph Motor control at 64Mhz
- 24-bit $\Sigma\Delta$ ADC
- LCD Driver
- USB, CAN

Extensive Ecosystem

- Comprehensive development tools
- 3rd party support
- Free E2 Studio GNU IDE
- Quick implementation with free Applilet peripheral driver

HIGH EFFICIENCY

Up to 44 DMIPS performance at 32 MHz

- Unrivalled power consumption / performance ratio (1/3 that of competitors)
- Higher DMIPS rating and lower power consumption than a popular 32-bit competitor technology
- RL78 offers widest operating voltage in its class from 1.6 V to 5.5 V
- 86% instructions executed in 1-2 cycles

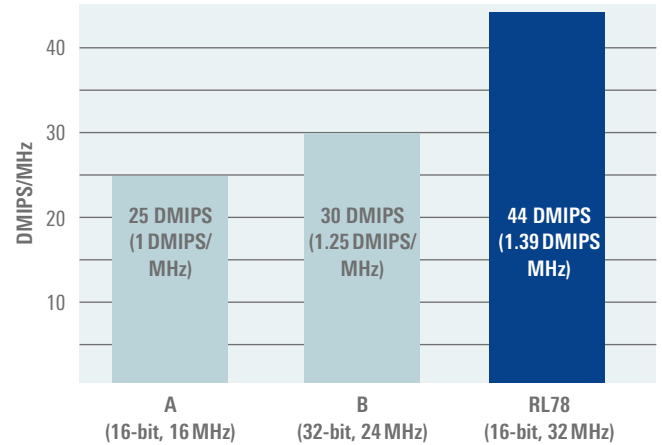

FLEXIBILITY

Peripheral I/O Re-direction (PIOR) capability remaps functions to alternate ports

- Due to layout or peripheral pin sharing constraint, there may be conflicts for existing peripheral I/O pin assignments
- Optimise peripheral pin functionality by easing function bottlenecks on a pin
- PIOR capability can help ease a bottleneck, as shown in this example by remapping to alternate pins

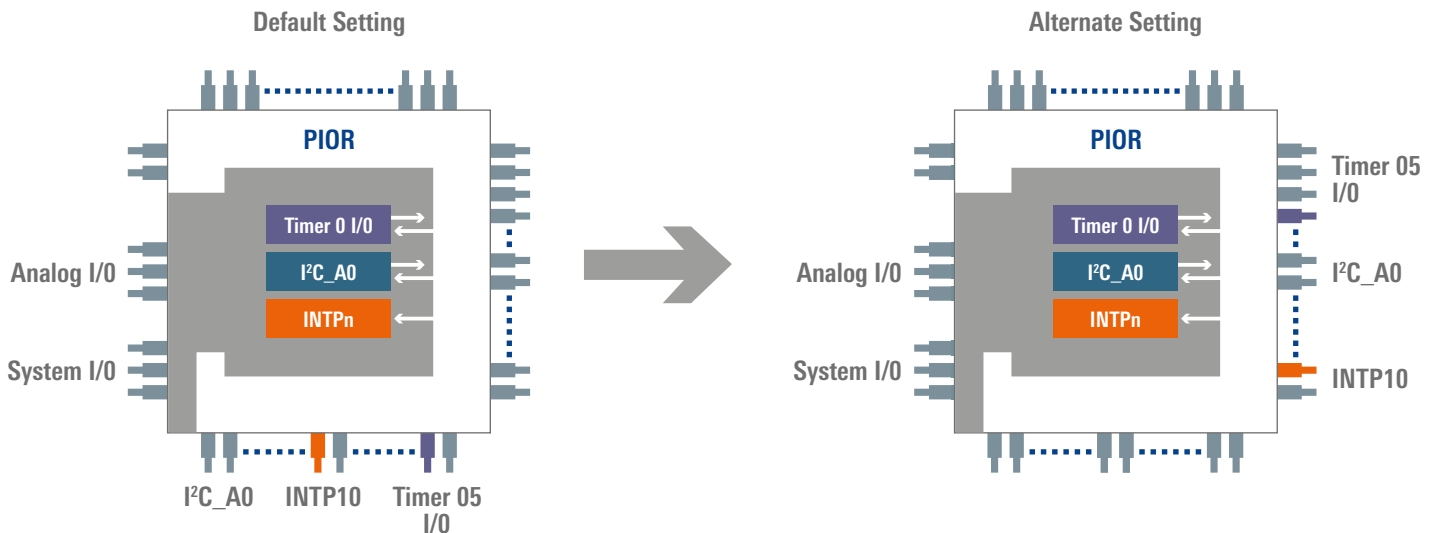

SAFETY FEATURES

Hardware for IEC/UL 60730 compliance

CRC

Two types of CRC hardware

- High-speed CRC (on flash memory)
- CRC peripheral (for application usage)

RAM

Parity/Write Protection

- Parity: Internal reset when parity error generated on Read or Write
- Write Protection:
Select from: ~128 B/~256 B/~512 B

SFR

Write Protection

- Write protection for: Port setting, interrupt setting, clock setting, LVI setting
- RAM Parity setting

CPU

Illegal memory access detection

- Illegal memory access: generates "internal reset"
- Trap instruction "FF" instruction generates "internal reset"

Clock

Stop Detection/Frequency Check

- Stop detection: possible to detect by WWDT
- Frequency check: possible to check by timer function

ADC

Multiple Input Signal selectable

- ADC measurement sources:
 - External ADC input pins
 - External/Internal AVref sources
 - Internal Vref (1.4 V typ.)
 - Temperature sensor

Event Link Controller (ELC)

The ELC is an innovative way to reduce CPU load by direct routing interrupt event signals from one peripheral or module to the others.

- ELC improves real time function by using less interrupts
- Reduces program size
- ELC achieves lower average power consumption

Depending on the RL78 family up to 26 different events are selectable.

- Automatically triggers other peripheral by bypassing the CPU and can be combined with the DTC
- Direct links between the hardware, e.g direct control of I/O and event timers
- Active in low power mode

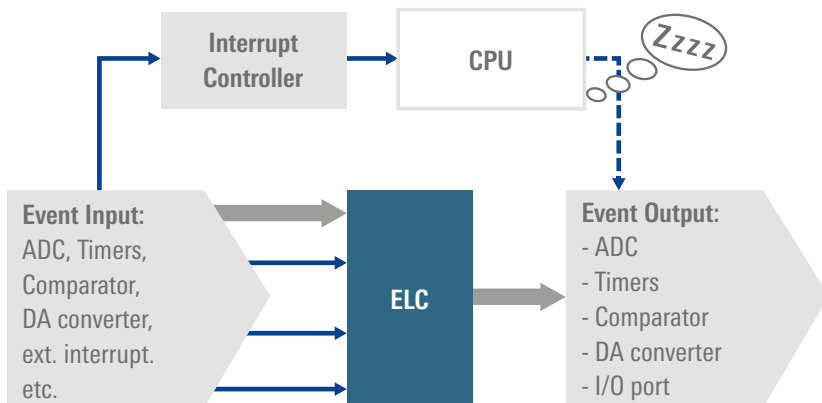
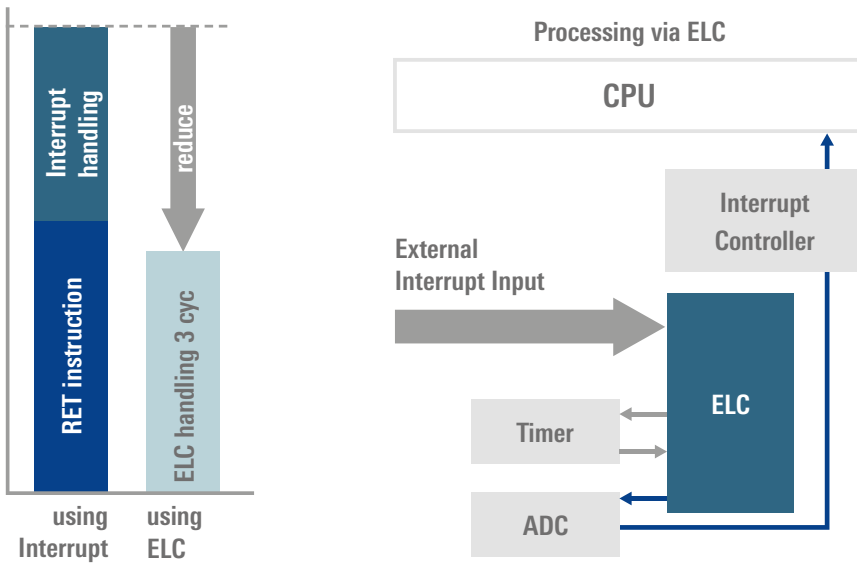

Example

Direct Transfer Controller (DTC) (*1)

The DTC is an excellent feature to reduce the CPU workload and can transfer data between memory and register without CPU intervention.

- Configurable in RAM and not limited by hardware.
- Possible to transfer in Normal, Repeat and Block transfer mode, with selectable block sizes up to 512 bytes and automatic address incrementation
- Flexible selection of up to 39 sources – with priority setting from high to low.

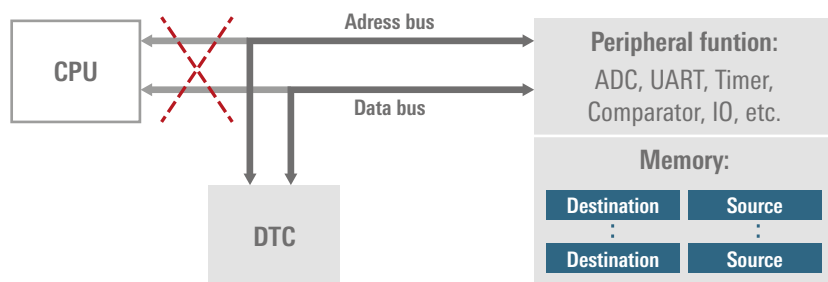

Data Operation Circuit (DOC)

The DOC is another intelligent feature and provides the ability to generate an interrupt from the result of a simple arithmetic operation between two pieces of data:

- automatic 16-bit addition,
- subtraction or
- comparison can be made

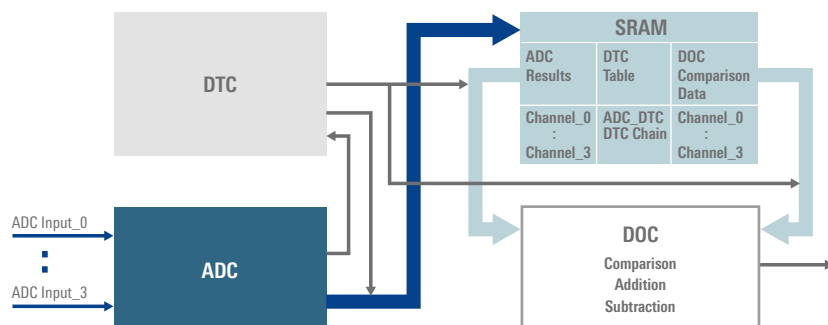

By combining this with DTC/DMAC it allows a wide variety of operations to be managed without CPU intervention. For examples:

- March X function
- SCI address match
- ADC level comparison alarm
- automatic 16-bit addition,
- subtraction or
- comparison can be made

Samples 4 input channels, move with DTC and control with DOC to check for alarm condition without any CPU intervention. No software development is required apart from initialization routine and ISR.

- transfer automatically the ADC result via DTC to SRAM for alarm condition store the threshold level in SRAM
- automatic compare/add/subtraction via DOC to check the alarm condition

RL78 WITH ADVANCED PERIPHERALS

RL78 Series

For applications that require increased performance the best-selling RL78/G13, G1A (12-bit ADC) and G14 series offer the same uncompromised low power RL78 solution but are also peripheral rich. The series offer 16 K to 512 K of on-board Flash, have variants with high precision 12-bit ADC, multiple smart timers and integrated safety functions.

Power Management

- Operating: as low as 66 μ A/MHz, (64 MHz, 32 MHz, 24 MHz)
- Halt: 0.57 mA (RTC + LVD)
- Stop: 220 nA (RAM retained)
- Snooze: 580 μ A (UART), 780 μ A (ADC)

System

- +/- 1% Internal Oscillator (64 MHz, 32 MHz, 24 MHz)
- 16 x 16 Multiplier, 32/32 Divider, Multiply-Accumulate

Timers

- Interval Timer (40 nA)
- Multi-function 16-bit Timer Array Unit (TAU)
- 3ph Motor control Timer RD
- Encoder Timer RJ

Enhanced Analog

- 10-bit ADC conversion time
- 12-bit ADC up to 28 channels
- 2 channel Comparator

Intelligent Features

- Direct Transfer Controller (DTC)
- Event Link Controller (ELC)

Safety

- IEC/UL 60730 Support
- Others: Illegal memory access, guard

Temperature range

- -40 to 105 $^{\circ}$ C

RL78/G14 block diagram

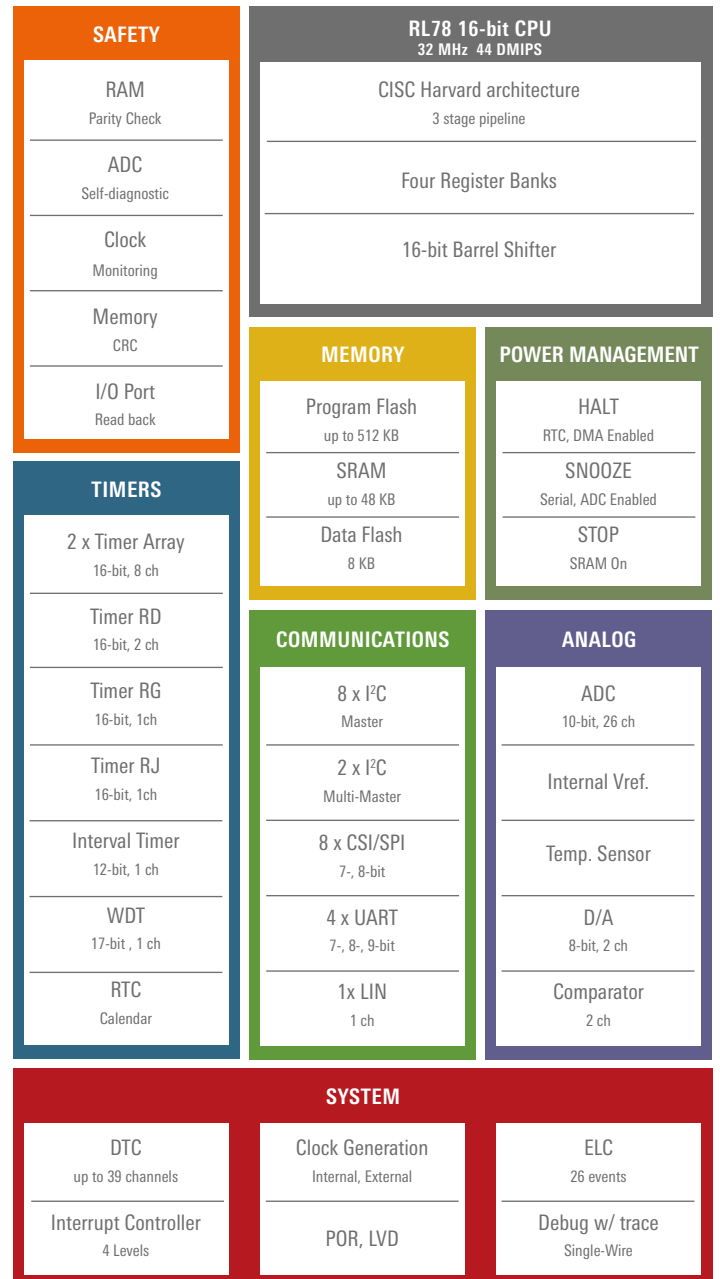

RL78/G14 Motor Control timer RD

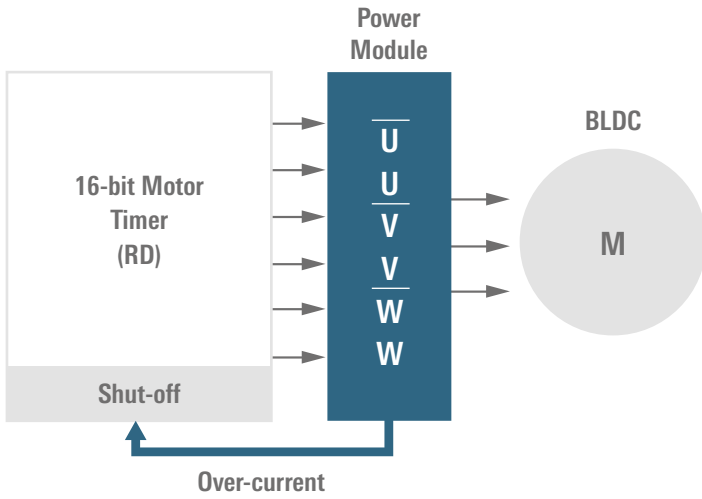

RL78/G1A Line-up (12-bit ADC)

Pin No.		20-36	40	44-48	64
Flash Size (Byte)	64 K	4 K	4 K	4 K	4 K
	48 K	3 K	3 K	3 K	3 K
	32 K	2 K	2 K	2 K	2 K
	16 K	2 K	2 K	2 K	
PKG	LGA: 3 mm	QFN: 5 mm	QFP: 7 mm QFN: 7 mm	QFP: 10 mm BGA: 4 mm	

RL78/G14

Pin No.		20-36	40	44-48	64	80-100	
Flash Size (Byte)	512 K			48 K	48 K	48 K	RAM
	384 K			32 K	32 K	32 K	
	256 K			24 K	24 K	24 K	
	192 K		20 K	:	:	:	
	128 K	16 K	16 K	16 K	16 K	16 K	
	:	:	:	:	4 K		
	16 K	2.5 K	2.5 K	2.5 K			
PKG	SSOP, QFP, QFN, LGA	QFN	QFP, QFN, LGA	QFP, LGA	QFP		

RL78 WITH LCD DRIVE

RL78/LCD Series

The latest devices from the RL78 platform offer integrated LCD drive. The first member in the family with integrated LCD drive to be released is the RL78/L12.

- More segment drive for a smaller package:
- RL78/L12 can drive 35 seg x 8 com or 39 seg x 4 com
- RL78/L13 can drive 47 seg x 8 com or 48 seg x 4 com
- RL78/L1A can drive 41 seg x 8 com or 45 seg x 4 com
- Low power LCD drive, only 0.6 μ A @ 3 V with capacitor split method
- Flexible control method: Split capacitors, capacitive charge pump or external split resistor
- Selectable functions (Seg or I/O) for every segment pin
 - Drive for both A waveform glass and B waveform panel

The RL78/L12 and RL78/L13 are both basic LCD devices with 10bit ADC convert, while the RL78/L1A family has enhanced and rich Analog peripherals such as:

- 12bit A/D converters, 12bit D/A converters, Comparators,
- high accurate rail to rail OPAMPs with switch fabrics

Using in addition the smart features like DTC and ELC a lot of peripherals can be connected internally to reduce CPU workload and can save overall power consumption.

RL78/L12 Block Diagram

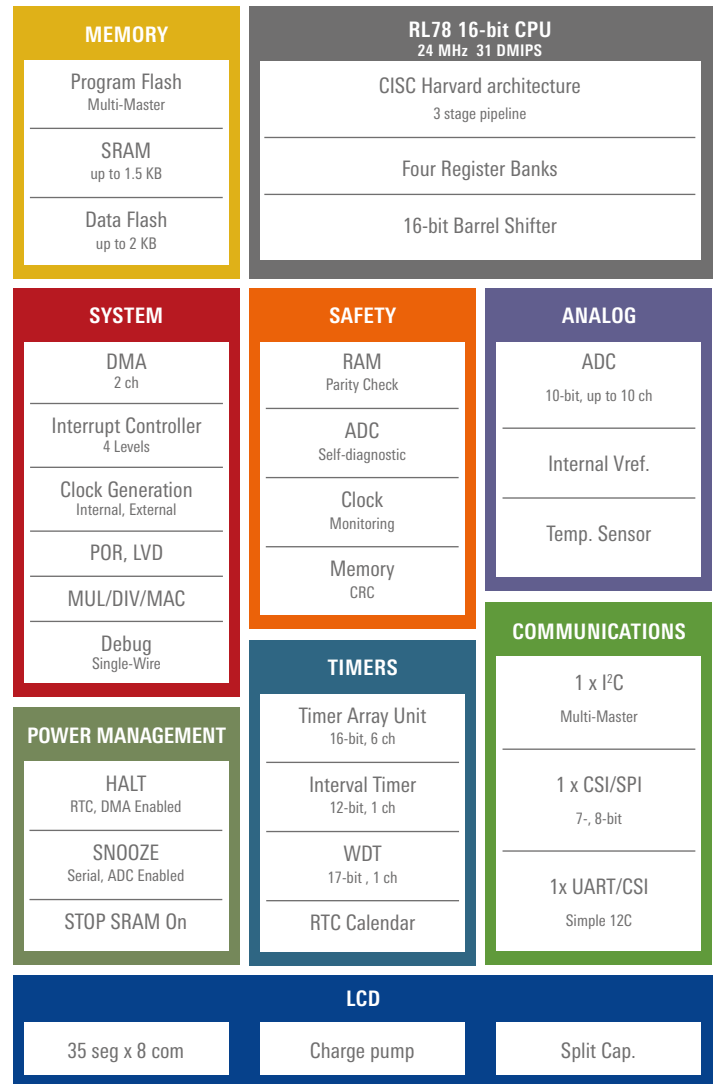

RL78/L1x Line-up

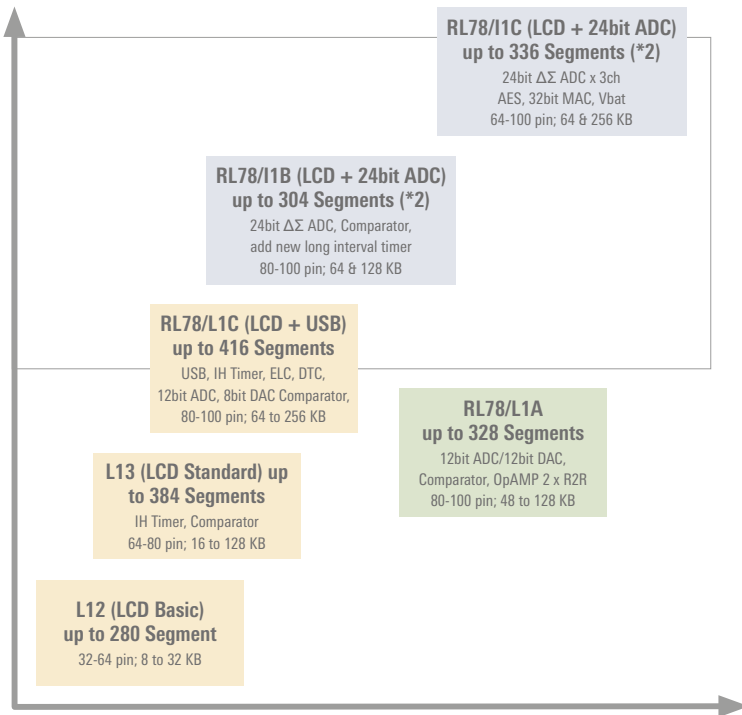

RL78/L1x Applications

- Home Automation: For long battery life and operation down to 1.6V RL78 is the first choice
- Metering: RL78 is analogue rich, ideal for smart metering applications. Renesas has three decades of metering experience
- Medical: RL78 offers true low power consumption and rich features, ideal for portable healthcare devices and Renesas Electronics is an active member of Continua alliance



RL78 FAMILY PERIPHERALS

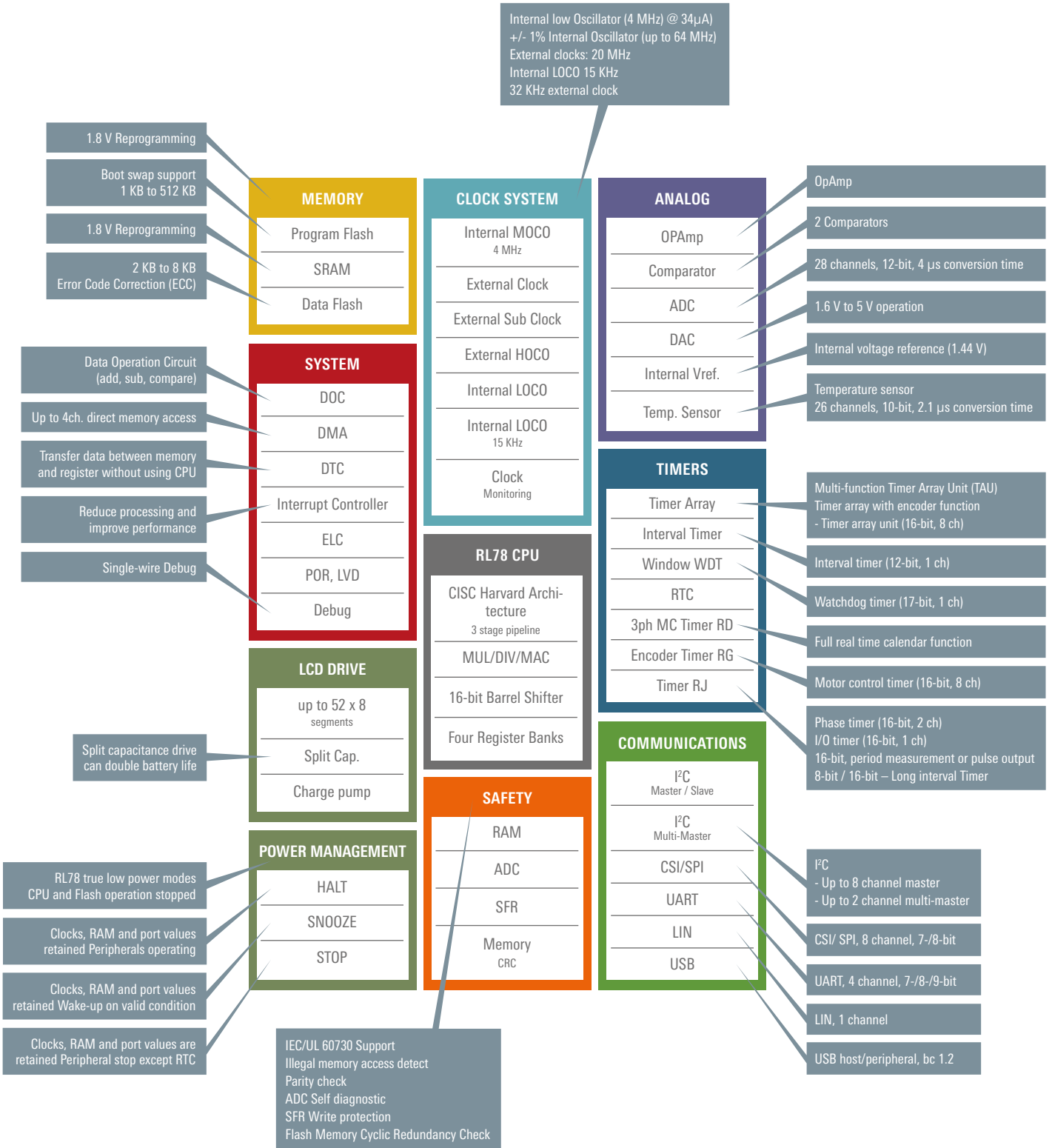

Please refer to RL78 series datasheet for device functionality

RL78 WITH USB



RL78/G1C and RL78/L1C Series

As the RL78 family expands another series of devices, the RL78/G1C and RL78L1C adds USB connectivity. Renesas is one of the pioneers of USB bringing the first USB 2.0 and USB 3.0 ASSP's to market. RL78/G1C family integrates USB 2.0 host and peripheral full speed functionality, while the RL78L1C supports LCD with peripheral function.

USB Compatibility

- Supports USB standard class driver (Host/Peripheral)
- Support class: CDC / HID / MSC / PHD / etc.

USB BC1.2 Compliance

- Allows currents up to 1.5 A to be used during charging

Compact & small & LCD

- Small general purpose or with LCD drive
- 32-pin to 48-pin & 80 to 100-pin

RL78/L1C Block Diagram with LCD & USB

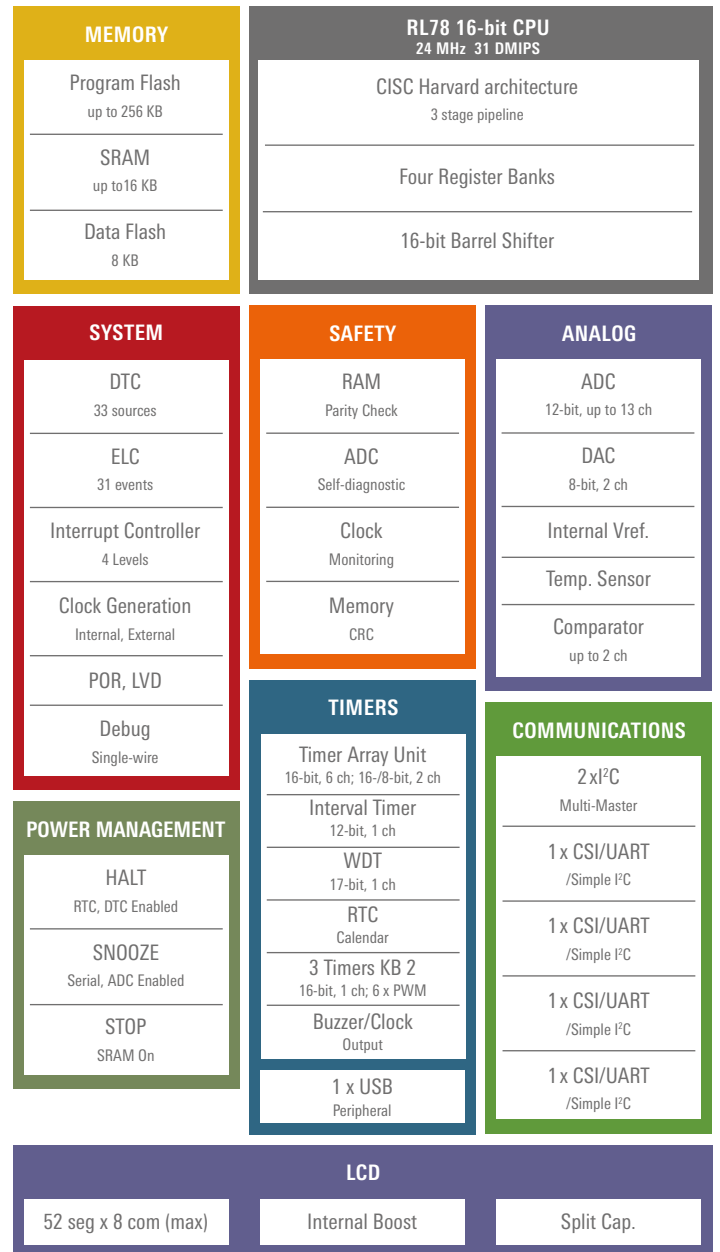

RL78/G1C Block Diagram with USB

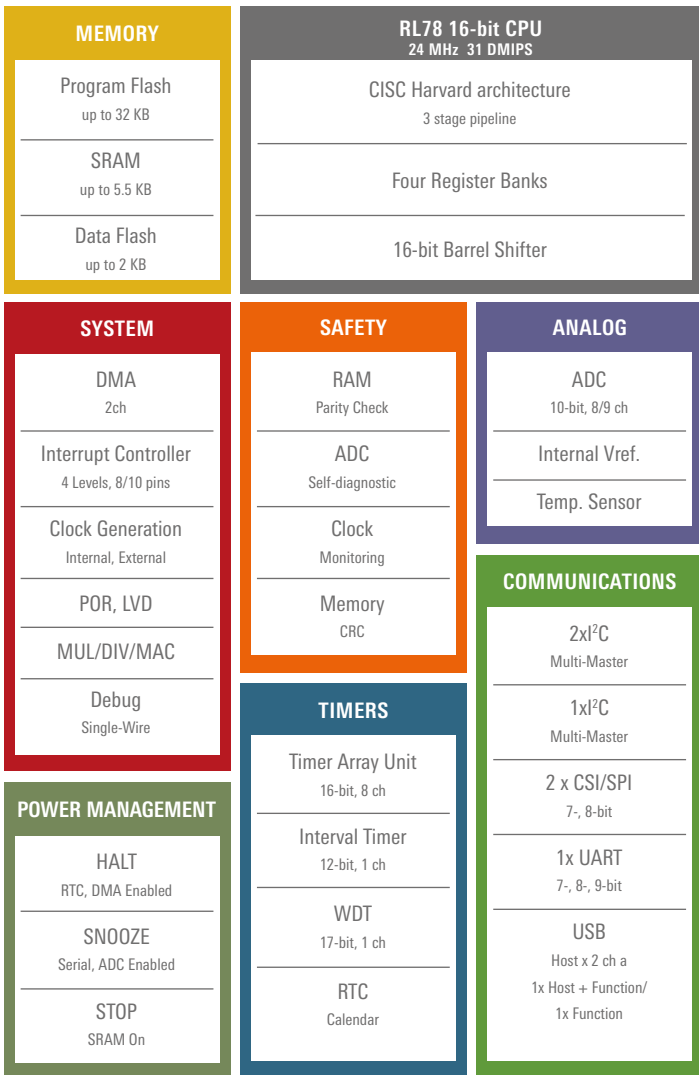

RL78/L1C with LCD & USB

Pin No.	80	100	
Flash Memory/RAM (KB)	256 KB	16 K	16 K
	192 KB	16 K	16 K
	128 KB	12 K	12 K
	96 KB	10 K	10 K
	64 KB	8 K	8 K
PKG	QFP 12 x 12	QFP 14 x 14	

RL78/G1C – with USB

Pin No.	32		48	
256 KB	5.5 K	5.5 K	5.5 K	5.5 K
PKG	QFP 7 x 7 QFN 5 x 5		QFP 7 x 7 QFN 7 x 7	



2 x Host or
1 x Host/Function



1 x only Function

All devices have 2 x 1 K Dataflash

RL78 LOW PIN COUNT

RL78/G10 Series

RL78 family expands its lineup to offer a highly-integrated small, low-pin count 10- and 16-pin SSOP packaged MCUs, optimized for space-constrained, low-cost applications in consumer, industrial, and medical markets. Development is quick and easy due to cost-effective, professional development tools and on-chip debugging capabilities.

Power Management

- Run: 46 μ A/MHz
- Stop: 0,5 μ A (RAM retained) w/SPOR

Low-Pin count in small

- 10-pin 4.4 x 3.6 mm SSOP
- 16-pin 3.4 x 5.0 mm SSOP

Small Flash memory size

- Flash: 1 to 4 KB SRAM: up to 512 B

System intergration & cost reduction

- 20 MHz On-Chip Oscillator +/- 2%
- 15 kHz Low Speed On-Chip Oscillator
- ext. Cer./Crystal OSC up to 20 MHz

Timers

- Multi-function Timer Array Unit (TAU), up to 3 x PWM output
- 12-bit Interval Timer
- Watchdog

Analog

- 8 x channels, 10-bit
- Comparator 1 ch
- Internal Voltage reference

Serial Communication

- CSI/SPI, UART, I²C

RL78/G10 Line-up

Pin No.		10	16
Flash Memory (KB)	4 KB	512	512
	2 KB	256	256
	1 KB	128	128
		SSOP 4.4 x 3.6	SSOP 4.4 x 5.0

RAM size (Byte)

RL78/G10 Block Diagram

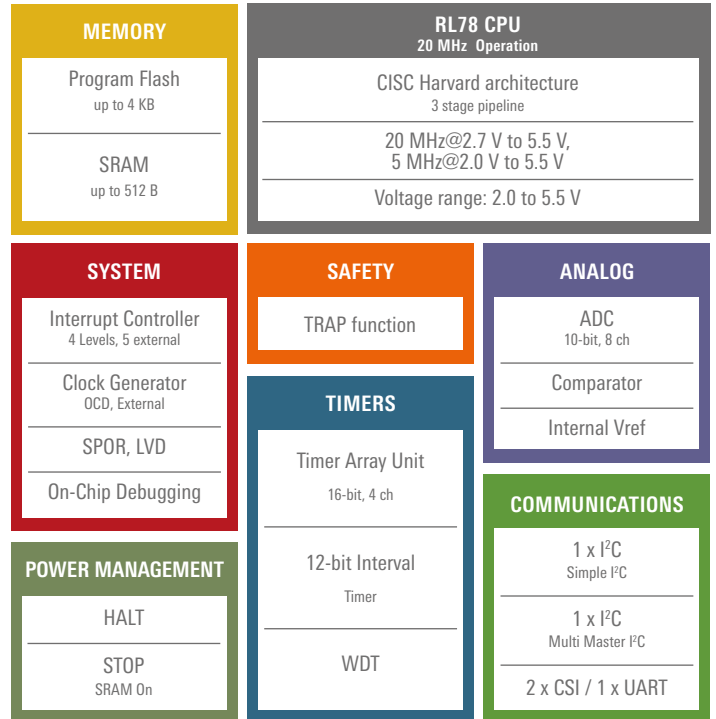

RL78/G11 Series

The RL78/G11 microcontroller line-up concept is based on small packages, in small 16KB flash memory and rich analog peripherals such as A/D converters, D/A converters, comparators and PGA and these are configurable as PGA+ADC+V_{BGR}, PGA+COMP, COMP+DAC/V_{BGR} or PGA+COMP+DAC/V_{BGR}. Using the smart features like DTC and ELC a lot of peripherals can be connected internally to reduce CPU workload and can save overall power consumption. It also supports very low power operation (100 uA @ 1 MHz) and a high speed 4µs wake up.

Power Management

- 1.4 mA @ 24MHz, 5V RUN
- 100 µA @ 1MHz (LP mode)
- 0.65 µA @ HALT mode SUB+LVD:ON
- 0.25 µA @ STOP mode (RAM retention)R

System integration & cost reduction

- 24 MHz (HOCO) High Speed On-Chip Oscillator +/-1 %
- 4 MHz (MOCO) Middle Speed On-Chip Oscillator@34 µA

Intelligent features for smart connection

- Direct Transfer control (DTC), Event Link Controller (ELC), Data Operation Circuit (DOC)

Key Features

- Rich analogue 10bit ADC, Comparator, DAC & PGA
- Timer KB output with 1ph bridge drive (e.g. LED)
- Fast wake up < 4us - Low 16bit interval Timer
- Long interval timer
- Small packages

Temperature & Quality Grade

- Temperature: -40°C to 85°C/105°C
- Consumer & industry application

RL78/G11 Line-up

Pin No.	10	16	20	24	25	
Flash Memory (KB)	32 KB					
	16 KB		1.5 K	1.5 K	1.5 K	
	8 KB					
PKG [mm2]	SSOP 4.4 x 4.6	SSOP 4.4 x 5.0	SSOP 4.4 x 6.5	QFN 4 x 4	LGA 3 x 3	RAM size (Byte)

RL78/G11 Block Diagram

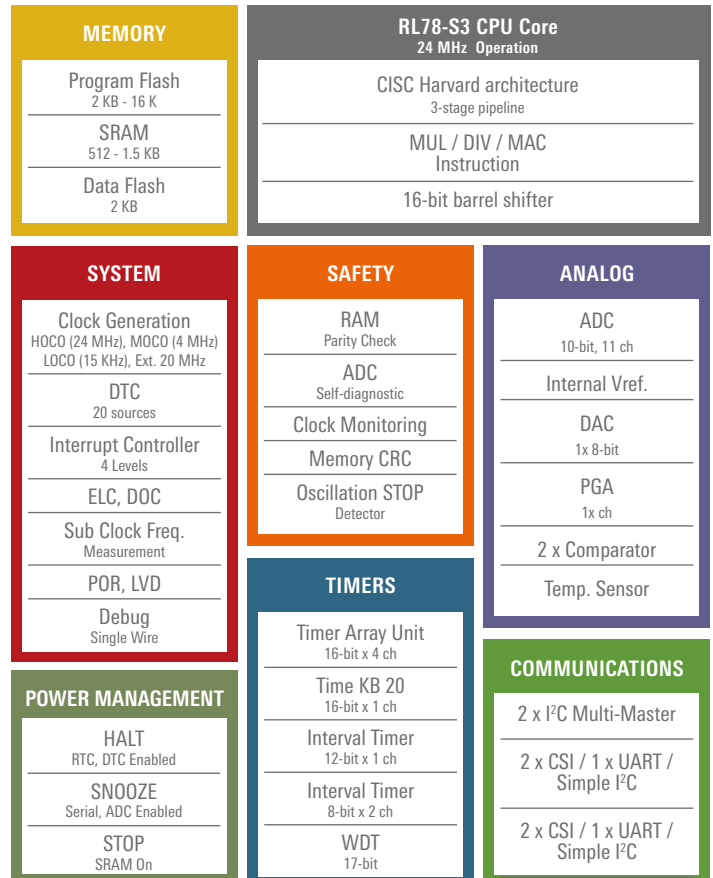

RL78/G1G – MOTOR CONTROL

RL78/G1G Series

In complement to the well know RL78/G14 family, this new RL78/G1G Family has been created to offer a solution for the low end Motor Control (MC) arena. Both families RL78/G14 and RL78/G1G have implemented the same 3ph Motor control Timer RD. Customers can utilize the same Software on all products. While RL78/G14 is suitable for the higher end MC area and can drive Brushless AC, DC and Induction AC (sensored) motors, the RL78/G1G is targeting application which needs small package, small memory at a more cost sensitive level.

Motor control System

- 16-bit CPU core @ 24 MHz with MAC
- 3ph Motor Timer RD with 48 MHz clock
- Quick comparator (70 ns) with PGA (4, 8, 16, 32) to detect over current with forced cutoff
- Small package

Safety IEC60730–1

- ECC, RAM parity Error detection CRC, WDT, ADC self diagnosis
- I/O consistency check
- Register write protection

Analog

- 12 channels x 10-bit ADC

Intelligent Features

- Event Link Controller (ELC)

Power Management

- Vcc: 2.7 to 5.5 V

Temperature range

- -40 to 85 °C

RL78/G1G Line-up

Pin No.		30	32	44
Flash Memory (KB)	16	1.5 K	1.5 K	1.5 K
	8	1.5 K	1.5 K	1.5 K
PKG		SSOP (300 mil)	SSOP (7 x 7) 0.8 mm pitch	QFP (10 x 10) 0.8 mm pitch

Application

Brushless DC – block commutation

- Sensorless – Back EMF
- Sensored – Hall, encoder

Specific embedded peripheral for small motor control system

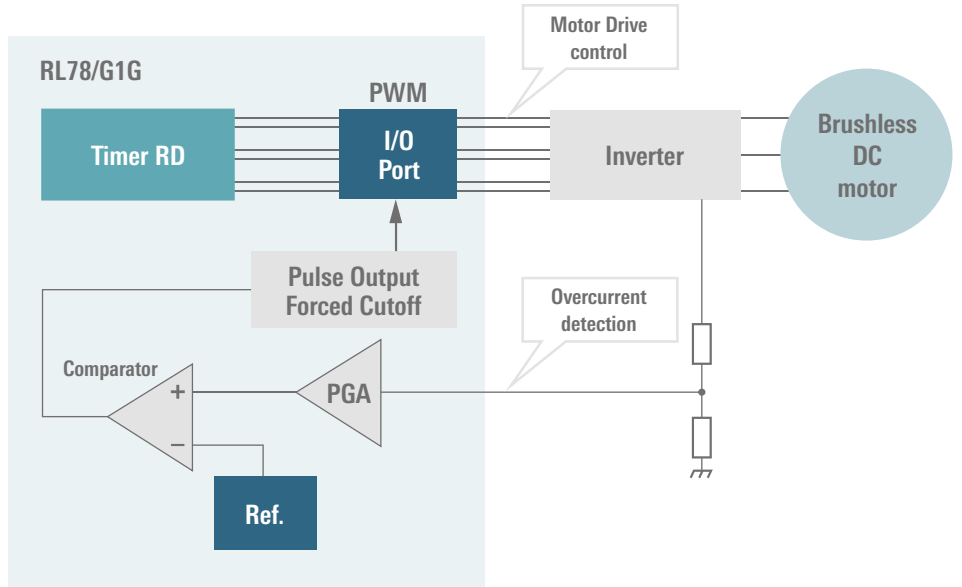

RL78/G10 Block Diagram

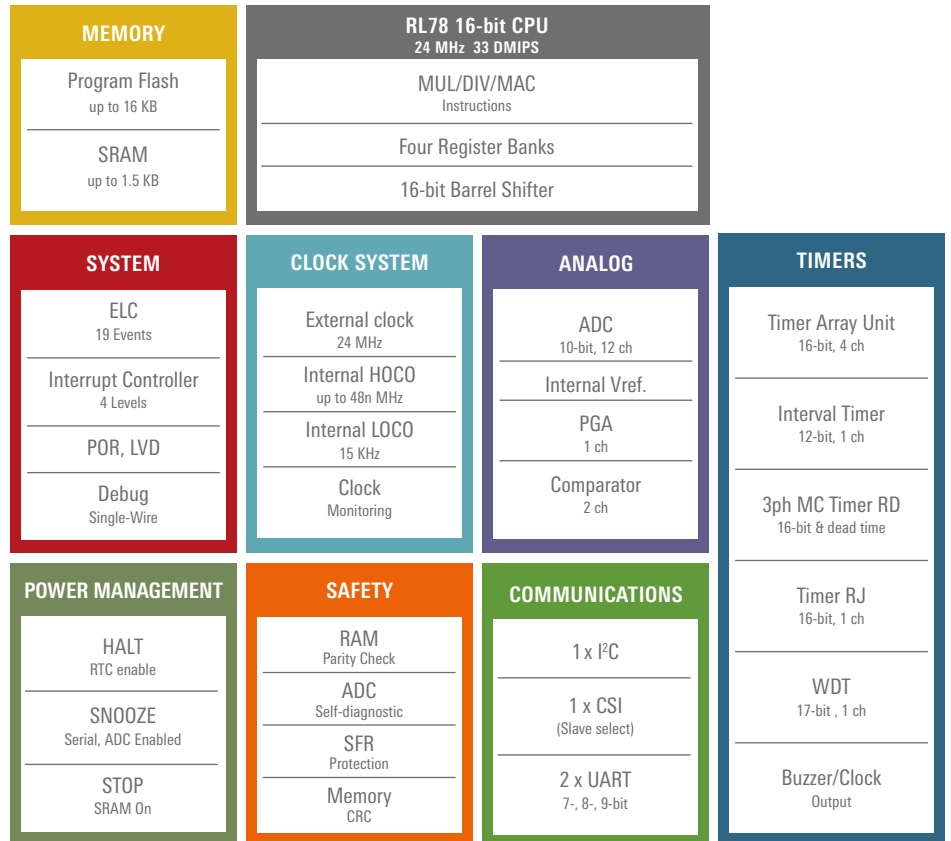

RL78 SMART CHOICE FOR DETECTOR & SENSOR

RL78/I1D

The Building automation arena is on of the fast growing market. These are including for example fire or smoke detectors, alarm system, sensor as part of access control and security system. The RL78/I1D family has specially been designed for such kind of application where lowest power function, enhanced analog features and quick wake up time in small packages are required.

System integration & cost reduction

- 24 MHz (HOCO) High Speed On-Chip Oscillator +/- 1%
- 4 MHz (MOCO) Middle Speed On-Chip Oscillator@34 μ A
- 15 KHz (LOCO) Low Speed On-Chip Oscillator

Low power Timers

- 12-bit Interval Timer (40 nA)
- 16-bit / 2 x 8-bit Interval Timer (100 nA) with prescaler (fIL / 128) to achieve long wake up timings

Enhanced Analog

- 12-bit ADC up to 17 channels
- Op-Amp: up to 4 channels
- Comparator: 2 channels

Intelligent Features

- Direct Transfer Controller (DTC)
- Event Link Controller (ELC)
- Data Operation Circuit (DOC)

Power Management

- Operation: < 150 μ A / MHz
- Stop: 0.2 μ A (RAM retrained)
- Wake up time: < 4 μ s (via MOCO)
- Vcc: 1.6 to 3.6 V

Temperature range

- -40 to 105 $^{\circ}$ C

Example: RL78/I1D intelligent features usage

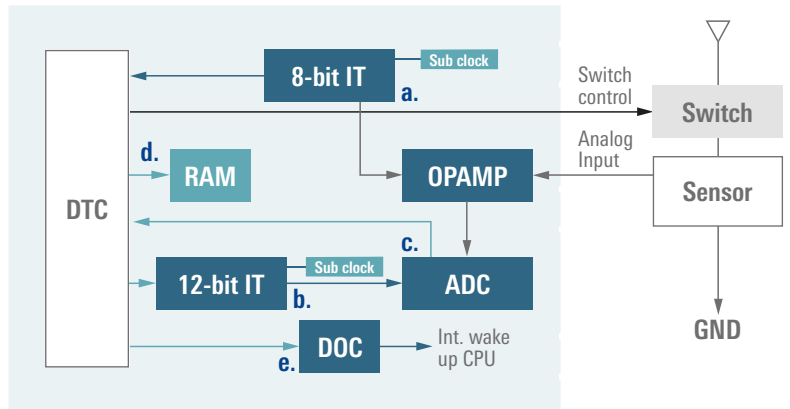

- a.** Switch on Sensor in low power mode
- b.** Delay ADC conversation
- c./d.** Move automatically ADC result via DTC to RAM
- e.** Automatic DOC judgement to wake up RL78/I1D



RL78/I1D Block Diagram

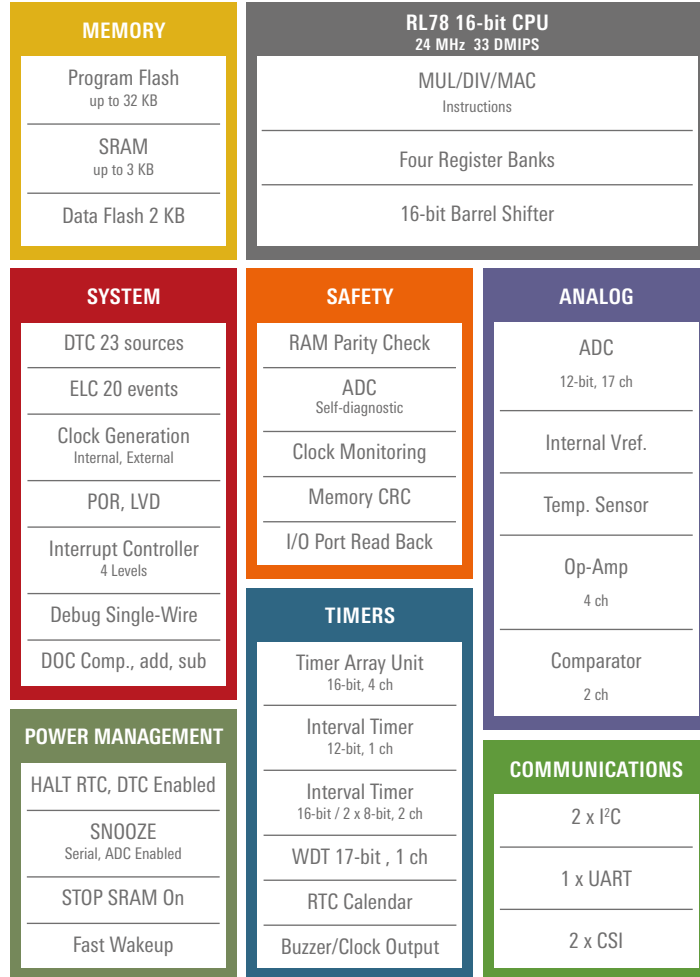

RL78/I1D Line-up

Pin No.	20	24	30	32	32	48	
Flash Memory (KB)	32		3 K*	3 K*	3 K*	3 K*	RAM
	16	2 K	2 K	2 K	2 K	2 K	
	8	0.7 K	0.7 K	0.7 K	*Only 2 KB when self programming function and data flash are used		
PKG	SSOP 6.5 mm	QFN 4 x 4 mm ²	SSOP 7.62 mm	QFN 5 x 5 mm ²	QFN 7 x 7 mm ²	QFN 7 x 7 mm ²	

PACKAGE LINE-UP



10
Pins

10-SSOP (4.4 x 3.6 mm)

Pin count	20-pin
Type	SSOP
Size	4.4 x 3.6 mm
Pitch	0.65 mm
Thickness*	1.40 mm
Used by	RL78/G10



20
Pins

20-SSOP (7.62 mm)

Pin count	20-pin
Type	SSOP
Size	7.62 mm
Pitch	0.65 mm
Thickness*	1.40 mm
Used by	RL78/G13, F12



20
Pins

20-LSSOP (4.4 x 6.5 mm)

Pin count	20-pin
Type	LSSOP
Size	4.4 x 6.5 mm
Pitch	0.65 mm
Thickness*	1.45 mm
Used by	RL78/G12, I1A, I1D



24
Pins

24-WQFN (4 x 4 mm)

Pin count	24-pin
Type	WQFN
Size	4 x 4 mm
Pitch	0.50 mm
Thickness*	0.80 mm
Used by	RL78/G12, G13, I1D



25
Pins

25-FLGA (3 x 3 mm)

Pin count	25-pin
Type	FLGA
Size	3 x 3 mm
Pitch	0.50 mm
Thickness*	0.76 mm
Used by	RL78/G13, G1A

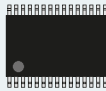

30
Pins

30-SSOP (7.62 mm)

Pin count	30-pin
Type	SSOP
Size	7.62 mm
Pitch	0.65 mm
Thickness*	1.40 mm
Used by	RL78/G12, G13, G14, I1A, I1D



32
Pins

32-LQFP (7 x 7 mm)

Pin count	32-pin
Type	LQFP
Size	7 x 7 mm
Pitch	0.80 mm
Thickness*	1.70 mm
Used by	RL78/G14, I1D



32
Pins

32-VQFN (5 x 6 mm)

Pin count	32-pin
Type	VQFN
Size	5 x 6 mm
Pitch	0.5 mm
Thickness*	0.95 mm
Used by	RL78/I1A



32
Pins

32-WQFN (5 x 5 mm)

Pin count	32-pin
Type	WQFN
Size	5 x 5 mm
Pitch	0.50 mm
Thickness*	0.80 mm
Used by	RL78/G13, G14, G1A, F12, I1D



36
Pins

36-FPLGA (4 x 4 mm)

Pin count	36-pin
Type	FPLGA
Size	4 x 4 mm
Pitch	0.50 mm
Thickness*	0.76 mm
Used by	RL78/G13, G14

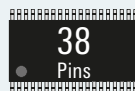

38
Pins

38-SSOP (7.62 mm)

Pin count	38-pin
Type	SSOP
Size	7.62 mm
Pitch	0.65 mm
Thickness*	2.00 mm
Used by	RL78/I1A



40
Pins

40-WQFN (6 x 6 mm)

Pin count	40-pin
Type	WQFN
Size	6 x 6 mm
Pitch	0.50 mm
Thickness*	0.80 mm
Used by	RL78/G13, G14

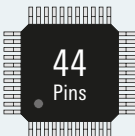

44
Pins

44-LQFP (10 x 10 mm)

Pin count	44-pin
Type	LQFP
Size	10 x 10 mm
Pitch	0.80 mm
Thickness*	1.60 mm
Used by	RL78/G13, G14, L12

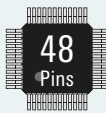

48
Pins

48-LQFP (7 x 7 mm)

Pin count	48-pin
Type	LQFP
Size	7 x 7 mm
Pitch	0.50 mm
Thickness*	1.60 mm
Used by	RL78/G13, G14, G1A, F12, L12, I1D



48
Pins

48-WQFN (7 x 7 mm)

Pin count	48-pin
Type	WQFN
Size	7 x 7 mm
Pitch	0.50 mm
Thickness*	0.80 mm
Used by	RL78/G13, G14, G1A, F12

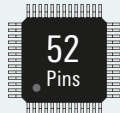

52
Pins

52-LQFP (10 x 10 mm)

Pin count	52-pin
Type	LQFP
Size	10 x 10 mm
Pitch	0.65 mm
Thickness*	1.70 mm
Used by	RL78/G13, G14, L12

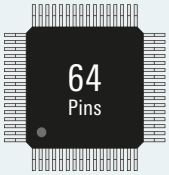

64-LQFP (14 x 14 mm)

Pin count	64-pin
Type	LQFP
Size	14 x 14 mm
Pitch	0.80 mm
Thickness*	1.70 mm
Used by	RL78/G14

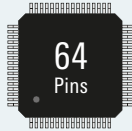

64-LQFP (12 x 12 mm)

Pin count	64-pin
Type	LQFP
Size	12 x 12 mm
Pitch	0.65 mm
Thickness*	1.60 mm
Used by	RL78/G13, G14, L12

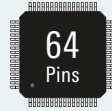

64-LQFP (10 x 10 mm)

Pin count	64-pin
Type	LQFP
Size	10 x 10 mm
Pitch	0.50 mm
Thickness*	1.60 mm
Used by	RL78/G13, G14, G1A, F12, L12



64 Pins

64-FPBGA (4 x 4 mm)

Pin count	64-pin
Type	FPBGA
Size	4 x 4 mm
Pitch	0.40 mm
Thickness*	0.99 mm
Used by	RL78/G13, G1A



64 Pins

64-FLGA (5 x 5 mm)

Pin count	64-pin
Type	FLGA
Size	5 x 5 mm
Pitch	0.50 mm
Thickness*	0.76 mm
Used by	RL78/G14



64 Pins

64-WQFN (8 x 8 mm)

Pin count	64-pin
Type	WQFN
Size	8 x 8 mm
Pitch	0.40 mm
Thickness*	0.80 mm
Used by	RL78/L12

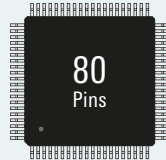

80 Pins

80-LQFP (14 x 14 mm)

Pin count	80-pin
Type	LQFP
Size	14 x 14 mm
Pitch	0.65 mm
Thickness*	1.70 mm
Used by	RL78/G13, G14

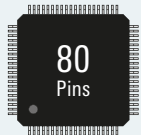

80 Pins

80-LQFP (12 x 12 mm)

Pin count	80-pin
Type	LQFP
Size	12 x 12 mm
Pitch	0.50 mm
Thickness*	1.60 mm
Used by	RL78/G13, G14

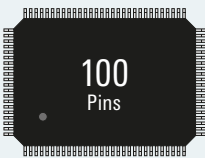

100 Pins

100-LQFP (14 x 20 mm)

Pin count	100-pin
Type	LQFP
Size	14 x 20 mm
Pitch	0.65 mm
Thickness*	1.60 mm
Used by	RL78/G13, G14

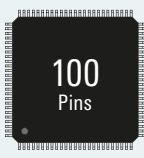

100 Pins

100-LQFP (14 x 14 mm)

Pin count	100-pin
Type	LQFP
Size	14 x 14 mm
Pitch	0.50 mm
Thickness*	1.60 mm
Used by	RL78/G13, G14

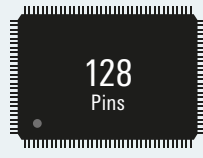

128 Pins

128-LQFP (14 x 20 mm)

Pin count	128-pin
Type	LQFP
Size	14 x 20 mm
Pitch	0.50 mm
Thickness*	1.60 mm
Used by	RL78/G13

* Indicates maximum thickness.

RL78 FOR MOTOR CONTROL

RL78/G1F, G1G and G14 Group

- RL78/G1F, G1G and G14 MCUs integrate the Timer RD motor-control timer, as well as ADC, TAU, SAU, ELC functions
- The devices can drive 5V parts without level shifters
- Compatibility is maintained for common peripherals on RL78/G1F, G1G and G14 MCUs

	G1F	G1G	G14
CPU frequency (max.)	32 MHz	24 MHz	32 MHz
HOCO	+/-1%	+/-2%	+/-1%
VDD	1.6V - 5.5V	2.7V - 5.5V	1.6V - 5.5V
Motor timer	Timer RD (64 MHz)	Timer RD (48 MHz)	Timer RD (64 MHz)
Rotor feedback timer	Timer RX (64 MHz)	–	–
Comparator mask timer	TAU (1 shot)	–	–
2-phase encoder timer	Timer RG	–	Timer RG
DTC	Yes	–	Yes
Comparator	2ch 150 ns max. (8-bit DAC and 1.45V reference)	2ch 150 ns max. (8-bit DAC reference)	2ch ¹ 1.2 us max. (0.76VDD, 0.24VDD, 1.45V reference)
PGA	1 ch	1 ch	–
DAC	2 ch (8-bit)	–	2ch (8-bit) ¹
Pin count	24-64-pin	30-44-pin	30-100-pin
Data Flash	4 KB	–	4 KB
Application examples	<ul style="list-style-type: none"> ■ Power tools ■ White goods 	<ul style="list-style-type: none"> ■ Fans ■ Power tools 	<ul style="list-style-type: none"> ■ White goods ■ RC motor

RL78/G14 motor control kit

- The kit allows evaluations of motor control techniques
- Renesas offers royalty-free motor control software
- The MCUs enable field-oriented sensorless vector control
- These kits implement the 3-shunt detection approach
- RL78/G1x can greatly reduce design time and effort to meet IEC60730 compliance requirements

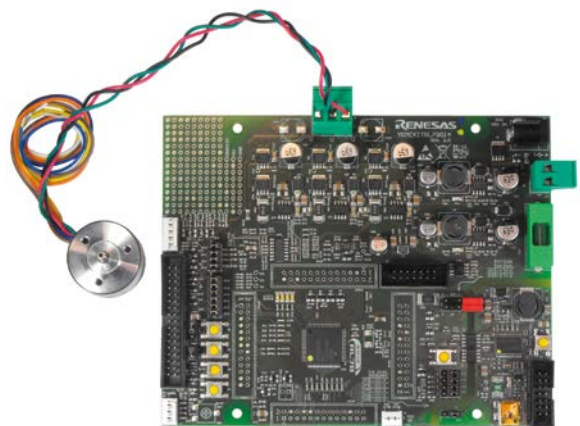

P/N: YRMCKITRL78G14

On-chip motor control features

- Three-phase (6ch) synchronous PWM output timer (Timer RD)
- Over-current protection with PGA and comparator
- Functions for controlling BEMF Brushless DC Motors

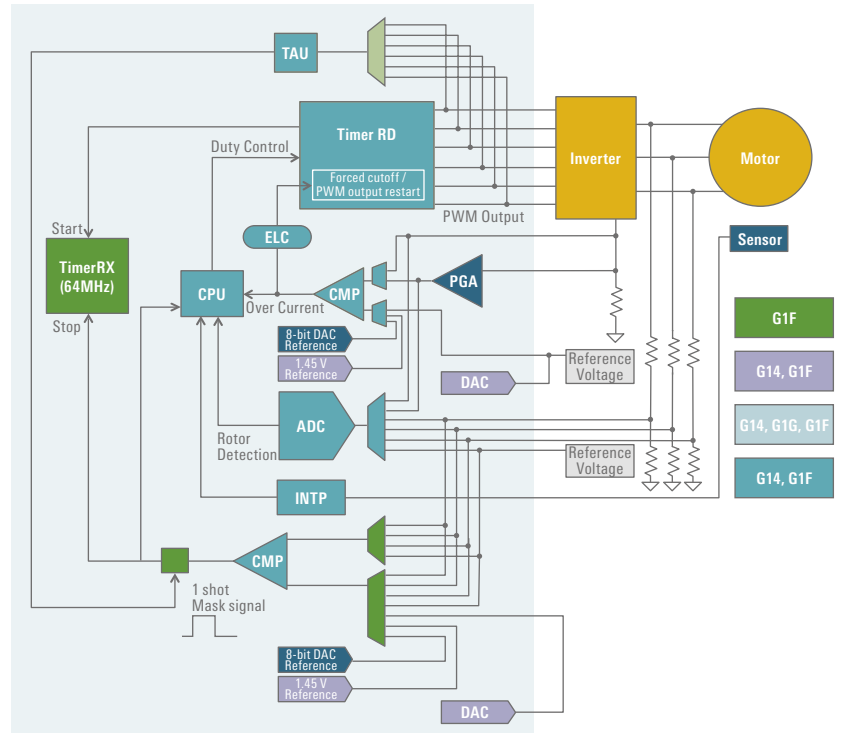

Application notes for motor control

Type	Description	Document No.
Motor Control	V/f Control of Induction Motor (RL78/G14)	R01AN2196EJ0100
	Vector control of permanent magnetic synchronous motor using encoder	R01AN1664EJ0100
	Sensorless vector control of permanent magnetic synchronous motor	R01AN1661EJ0100
	120 degrees conducting control of permanent magnetic synchronous motor with hall sensor	R01AN1659EJ0100
	Sensorless 120 degrees conducting control of permanent magnetic synchronous motor	R01AN1660EJ0100
	Inverter control of the single phase induction motor	R01AN1658EJ0100
	Sensorless 120 degrees conducting control of permanent magnetic synchronous motor	R01AN1387EJ0100
DSP	RL78 Digital Signal Controller Library – Fixed Point and Motor	R01AN1216ES0101
	RL78 Digital Signal Controller Library – Filter	R01AN1665ES0100

RL78/G1D INTELLIGENT BLUETOOTH® SMART MCUS

Low Power RL78 Microcontroller and Bluetooth Low Energy wireless technology increases battery life and accelerates Bluetooth connected device development.



44 DMIPS,
True Low Power



Bluetooth®
SMART

Offering low power consumption and robust system development support, Renesas RL78/G1D chips deliver reliable connectivity for 'Internet of Things (IoT)' products.

RL78/G1D Block Diagram

VDD = 1.6 to 3.6V
Ta = -40 to +85°C

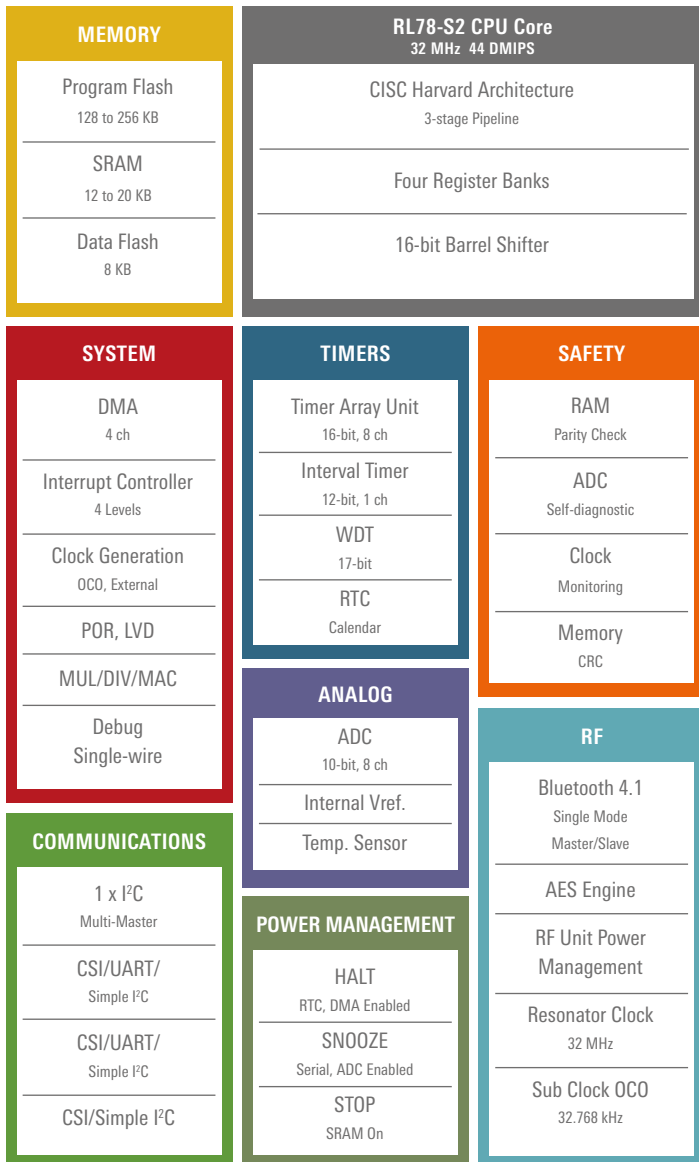

Key Features

- Bluetooth Smart v4.1 connectivity supported in embedded and modem modes
- Peak Tx current of 4.3 mA and peak Rx current of 3.5 mA
- 'RF Adaptable Technology' automatically optimizes power consumption versus communication range
- High integration minimizes BOM cost; Balun, on-chip 32 KHz oscillator
- Industry-leading support tools shorten time to market
- BT SIG qualified stack plus documented test procedure facilitate radio certification
- Firmware-over-the-air (FOTA) capability enables convenient application upgrades in the field

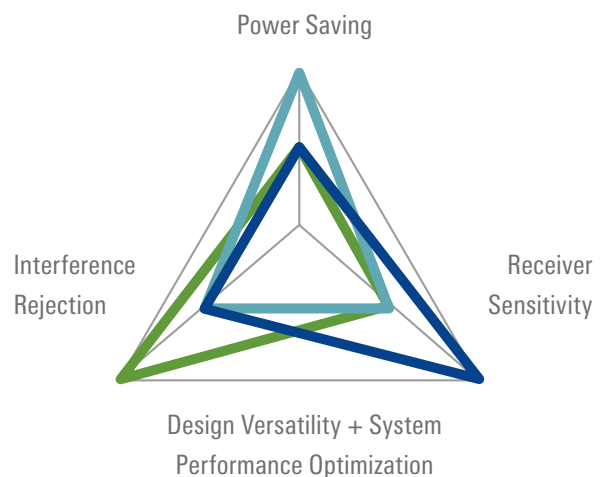

Efficient connection technology.

RL78/G1D MCUs prioritize current consumption at near distances or communication range at far distances.

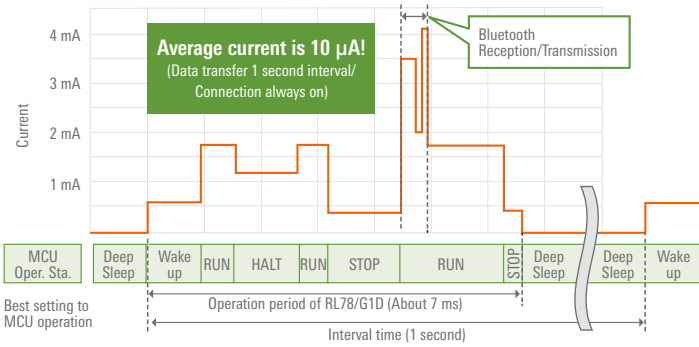

Outstanding Tx/Rx power efficiency.

State-of-the-art radio technology enables reliable communications with low current consumption.

BLE Stack Configuration

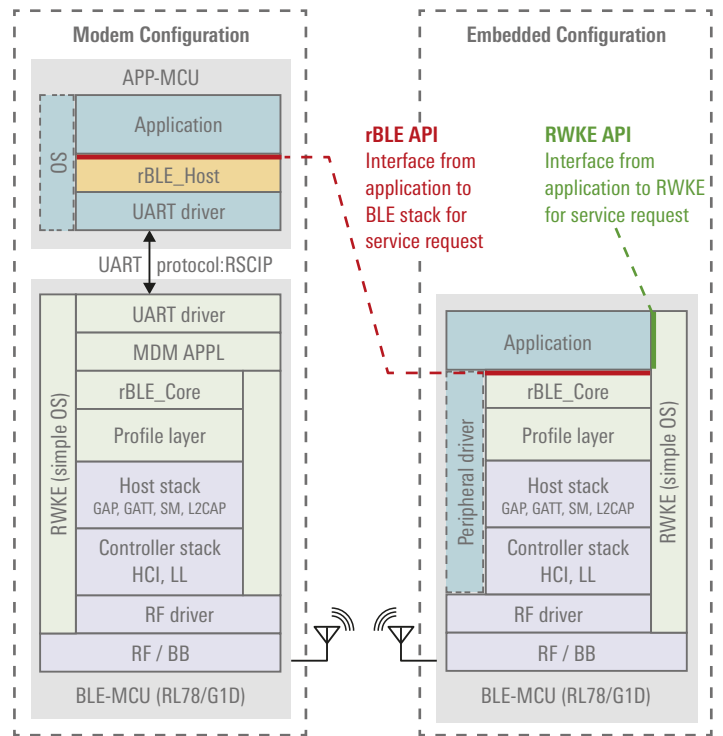

- Customer developed software
- Renesas provided software (Source code)
- Renesas provided software (Binary code)
- Renesas provided software (Binary code)

- ABBREVIATIONS**
- RWKE** - Renesas Wireless Kernel Extension
 - RSCIP** - Renesas Serial Communication Protocol
 - API** - Application Program Interface

Key Applications

- Home and Building Automation: Locks, gateway, security systems
- Industrial Systems: Asset tracking and management systems, remote displays, access control systems
- Retail Operations: Beacons, price tags, payment systems
- Healthcare and Fitness Centers: Blood glucose and pressure meters, weight- scales, activity monitors

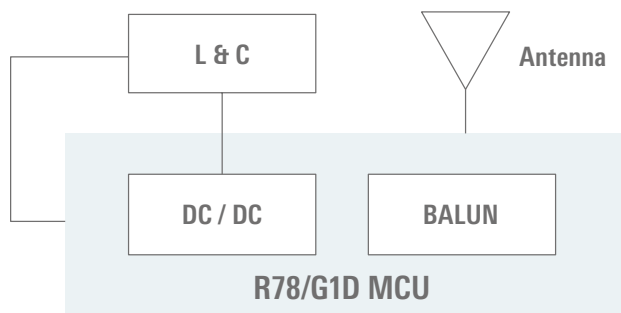

Simplified RF Design.

High level of integration simplifies RF design and reduces BOM count.

The RL78/G1D Group

Pin Count	Package	Fields of Application	Ordering Part Number	Code Flash Memory	Data Flash Memory	RAM
48 pins	Plastic WQFN (6 x 6 mm)	Consumer	R5F11AGGANB	128 KB	8 KB	12 KB
		Industrial	R5F11AGGDNB			
		Consumer	R5F11AGHANB	192 KB	8 KB	16 KB
		Industrial	R5F11AGHDNB			
		Consumer	R5F11AGJANB	256 KB	8 KB	20 KB
		Industrial	R5F11AGJDNB			

RL78 DEVELOPMENT TOOLS AND KITS

Extensive Renesas Development Ecosystem

Renesas Electronics and selected partners offer a comprehensive suite of hardware and software tools for the rapid evaluation and development of embedded systems built with RL78.

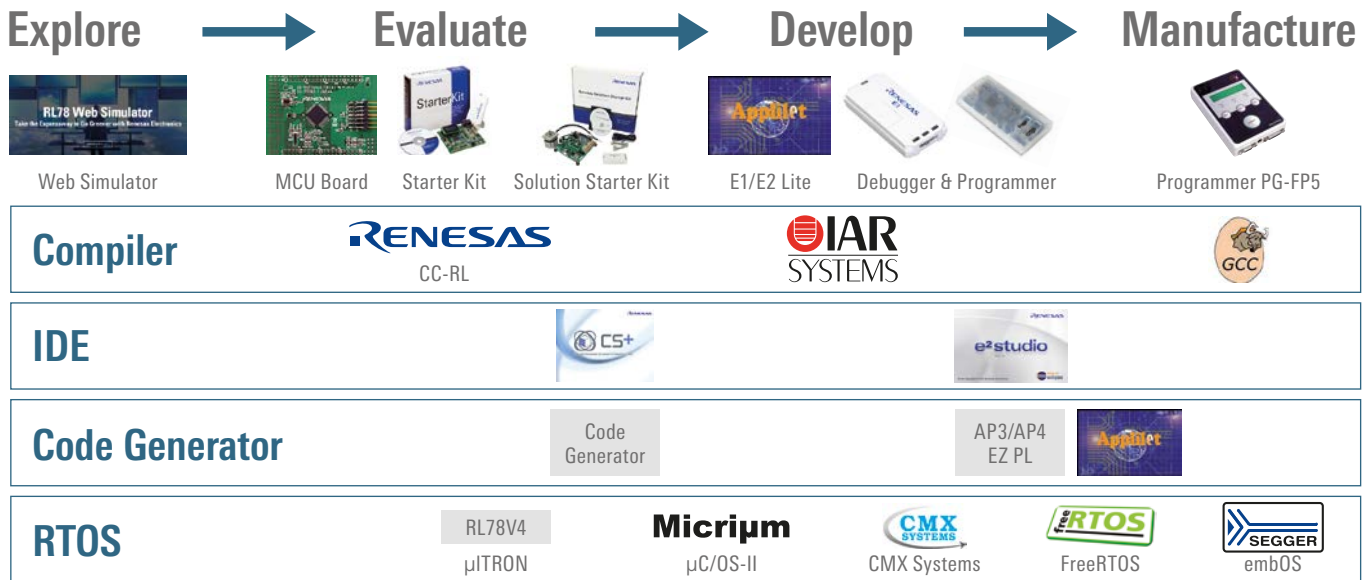

Software Development Tools

e² Studio

- Based on the popular Eclipse open source environment
- Complete IDE based on GNU or IAR compilers
- Powerful project management
- Download free at: www.renesas.com/E2Studio

IAR Embedded Workbench

- Integrated development environment and optimised C++ compiler for RL78
- Project management tools and editor
- Configuration files for all RL78 devices
- Emulator Debugger Support
- Run-time libraries

Applilet

- Renesas software tool generates device driver code to initialize and use on-chip peripherals
- Full code generation for IAR EWRL78
- Integrated project wizard guides user to create a new project
- Download free at: www.renesas.com/applilet

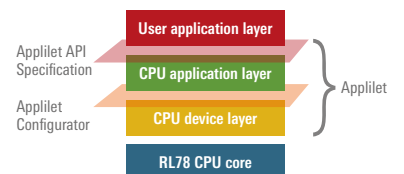

Series	Part Number	Description
RL78/G10	Y-RL78G10-KIT	RL78/G10 kit with E1 debugger
	QB-R5F10Y16-TB	RL78/G10 (10-pin) target board
	RTE510Y470TGB00000R	RL78/G10 (16-pin) target board
RL78/G11	YQB-R5F1057A-TB	RL78/G11 (25-pin) target board
RL78/G12	QB-R5F1026A-TB	RL78/G12 target board
RL78/G13	YRPBRL78G13	Renesas Promotion Board RL78/G13
	R0K50100LC001BE	RSK RL78/G13 CPU Board with LCD Display
	YR0K50100LS000BE	Renesas Starter Kit for RL78/G13 (E1 with IAR compiler)
	QB-R5F100LE-TB	RL78/G13 (64K) target board
	QB-R5F100SL-TB	RL78/G13 (512K) target board
RL78/G14	YRPBRL78G14	Renesas Promotion Board RL78/G14
	R0K50104PC001BE	RSK RL78/G14 CPU Board with LCD Display
	YR0K50104PS000BE	Renesas Starter Kit for RL78/G14 (E1 with E ² Studio)
	QB-R5F104LE-TB	RL78/G14 (64K) target board
	QB-R5F104PJ-TB	RL78/G14 (256K) target board
RL78/G1C	QB-R5F10JGC-TB	RL78/G1C target board
	YR0K5010JGS000BE	Renesas Starter Kit for RL78/G1C (E1 with E ² Studio)
	Y-QB-RL78G1C-ZZZ-EE	ICE (IECUBE) In-Circuit Emulator for RL78/G1C
RL78/I1D	RTE5117GC0TGB00000R	RL78/I1D Target board
	YDETECT-IT-RL78	RL78/I1D Solution kit "Detect It!"
RL78/L12	QB-R5F10RLC-TB	RL78/L12 target board
	YRPBRL78L12	Renesas Promotion Board RL78/L12
	YR0K5010RLS000BE	Renesas Starter Kit for RL78/L12 inc. LCD APP2 (E1 with E ² Studio)
RL78/L13	QB-R5F10WWMG-TB	RL78/L13 target board
	YR0K5010WMS000BE	Renesas Starter Kit for RL78/L13 inc. LCD APP2 (E1 with E ² Studio)
RL78/L1A	YQB-R5F11MPG-TB	RL78/G11 (25-pin) target board
	YRPBRL78L1A	Renesas Promotion Board RL78/L1A
RL78/L1C	QB-R5F110PJ-TB	RL78/L1C target board
	YR0K50110PC000BE	Renesas Starter Kit for RL78/L1C inc. LCD APP2 (E1 with E ² Studio)
RL78/G1G	YQB-R5F11EFA-TB	RL78/G1G Target board
	R0K5011EFS000BE	Renesas Starter Kit with RL78/G1G
RL78/F12	QB-R5F109GE-TB	RL78/F12 target board
	Y-ASK-RL78F12	RL78/F12 Starter Kit (E1 Debugger included)
RL78/F13	QB-R5F10BMG-TB	RL78/F13 target board
RL78/F14	QB-R5F10PPJ-TB	RL78/F14 target board
Renesas Compiler	CC-RL	RL78 Family C Compiler Package (without IDE) or C Compiler and IDE for RL78 Family
IAR Compiler	Y-IAR-EWRL78-FULL	IAR EWRL78 Compiler Stand-alone PC-locked License
	Y-IAR-EWRL78-FULL-MOBILE	IAR EWRL78 Compiler Mobile License (incl. USB HW Dongle)
Hardware tool	YR0E000010KCE0-EE	E1 OCD Debugger & Programmer
	RTE0T0002LKCE00000R	E2 Lite ON chip debugger (supporting RL and RX only)
	Y-PG-FP5-EE	PG-FP5 Flash Programmer

RL78 PART NUMBER GUIDE

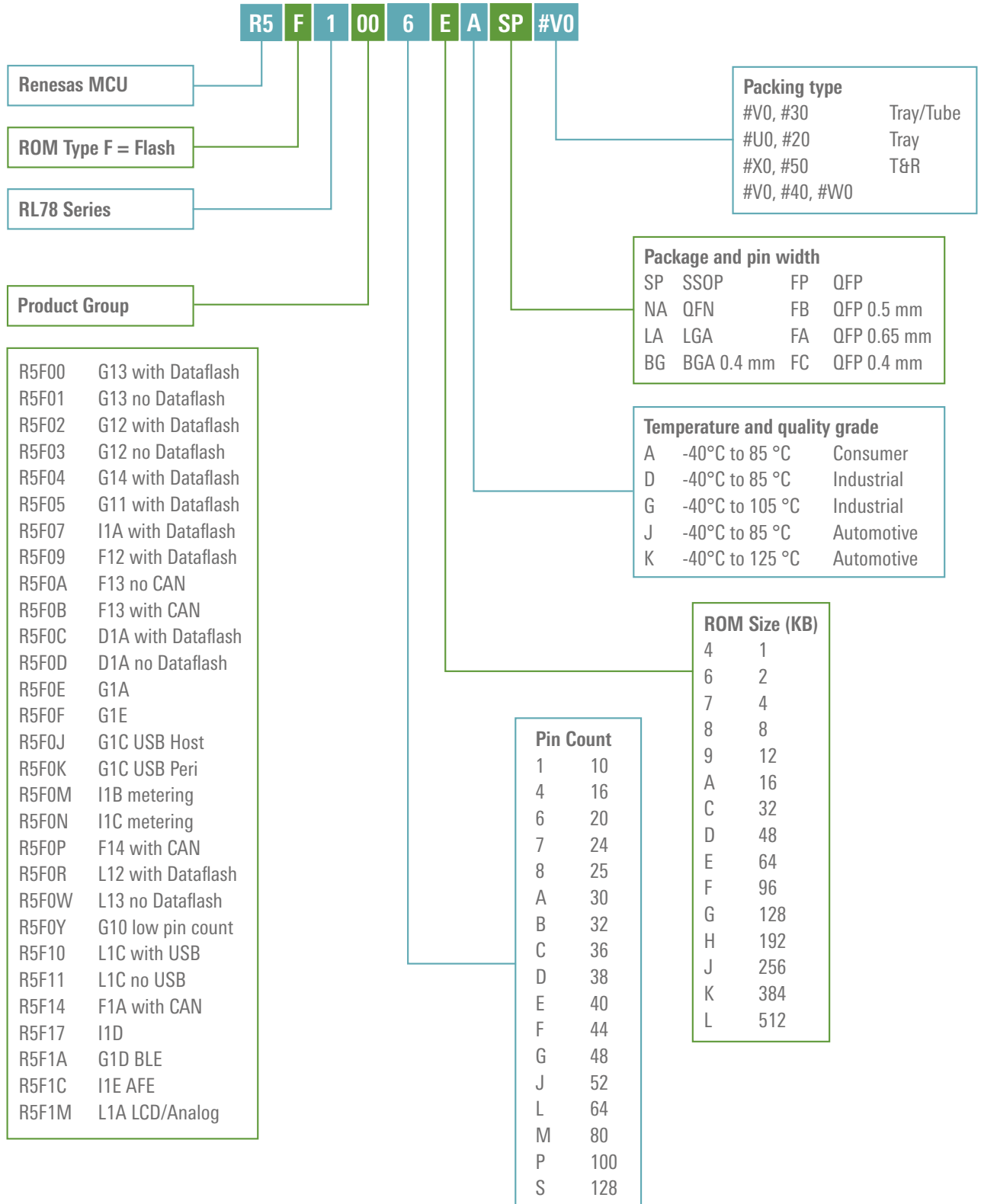

GETTING STARTED WITH RL78 IS EASY!

Renesas Electronics has made embedded design with the RL78 microcontroller family as easy as possible. An extensive ecosystem for RL78 including training, free evaluation boards (Renesas Promotion Boards), low cost starter kits and multiple application notes aid the embedded system designer to develop the World's lowest power designs.

www.renesas.eu/rl78

- Keep up to date with RL78 Family
- RL78 MCU search facility
- Full data & application notes
- Hardware and software guides and free downloads
- Sales and support information

Low Power



RL78 Promotion Board

- Learn about RL78 key features
- A complete GUI based control
- Software examples
- Development environment
- www.renesas.eu/products/mpumcu/rl78/index.jsp



The Renesas Eco System

Online technical community
www.renesasrulz.com

RenesasRulz.com
Think it. Build it. Post it.

Online technical training
www.renesasinteractive.com



Renesas Presents video channel
www.youtube.com/renesaspresents

3rd Party network
www.renesas.eu/alliance



Facebook
www.facebook.com/renesaseurope



Personalised news & services
www.renesas.eu/myrenesas

My Renesas

Latest news
www.twitter.com/renesas_europe



Before purchasing or using any Renesas Electronics products listed herein, please refer to the latest product manual and/or data sheet in advance.

Renesas Electronics Europe

www.renesas.com