

To our customers,

Old Company Name in Catalogs and Other Documents

On April 1st, 2010, NEC Electronics Corporation merged with Renesas Technology Corporation, and Renesas Electronics Corporation took over all the business of both companies. Therefore, although the old company name remains in this document, it is a valid Renesas Electronics document. We appreciate your understanding.

Renesas Electronics website: <http://www.renesas.com>

April 1st, 2010
Renesas Electronics Corporation

Issued by: Renesas Electronics Corporation (<http://www.renesas.com>)

Send any inquiries to <http://www.renesas.com/inquiry>.

Notice

1. All information included in this document is current as of the date this document is issued. Such information, however, is subject to change without any prior notice. Before purchasing or using any Renesas Electronics products listed herein, please confirm the latest product information with a Renesas Electronics sales office. Also, please pay regular and careful attention to additional and different information to be disclosed by Renesas Electronics such as that disclosed through our website.
2. Renesas Electronics does not assume any liability for infringement of patents, copyrights, or other intellectual property rights of third parties by or arising from the use of Renesas Electronics products or technical information described in this document. No license, express, implied or otherwise, is granted hereby under any patents, copyrights or other intellectual property rights of Renesas Electronics or others.
3. You should not alter, modify, copy, or otherwise misappropriate any Renesas Electronics product, whether in whole or in part.
4. Descriptions of circuits, software and other related information in this document are provided only to illustrate the operation of semiconductor products and application examples. You are fully responsible for the incorporation of these circuits, software, and information in the design of your equipment. Renesas Electronics assumes no responsibility for any losses incurred by you or third parties arising from the use of these circuits, software, or information.
5. When exporting the products or technology described in this document, you should comply with the applicable export control laws and regulations and follow the procedures required by such laws and regulations. You should not use Renesas Electronics products or the technology described in this document for any purpose relating to military applications or use by the military, including but not limited to the development of weapons of mass destruction. Renesas Electronics products and technology may not be used for or incorporated into any products or systems whose manufacture, use, or sale is prohibited under any applicable domestic or foreign laws or regulations.
6. Renesas Electronics has used reasonable care in preparing the information included in this document, but Renesas Electronics does not warrant that such information is error free. Renesas Electronics assumes no liability whatsoever for any damages incurred by you resulting from errors in or omissions from the information included herein.
7. Renesas Electronics products are classified according to the following three quality grades: “Standard”, “High Quality”, and “Specific”. The recommended applications for each Renesas Electronics product depends on the product’s quality grade, as indicated below. You must check the quality grade of each Renesas Electronics product before using it in a particular application. You may not use any Renesas Electronics product for any application categorized as “Specific” without the prior written consent of Renesas Electronics. Further, you may not use any Renesas Electronics product for any application for which it is not intended without the prior written consent of Renesas Electronics. Renesas Electronics shall not be in any way liable for any damages or losses incurred by you or third parties arising from the use of any Renesas Electronics product for an application categorized as “Specific” or for which the product is not intended where you have failed to obtain the prior written consent of Renesas Electronics. The quality grade of each Renesas Electronics product is “Standard” unless otherwise expressly specified in a Renesas Electronics data sheets or data books, etc.
 - “Standard”: Computers; office equipment; communications equipment; test and measurement equipment; audio and visual equipment; home electronic appliances; machine tools; personal electronic equipment; and industrial robots.
 - “High Quality”: Transportation equipment (automobiles, trains, ships, etc.); traffic control systems; anti-disaster systems; anti-crime systems; safety equipment; and medical equipment not specifically designed for life support.
 - “Specific”: Aircraft; aerospace equipment; submersible repeaters; nuclear reactor control systems; medical equipment or systems for life support (e.g. artificial life support devices or systems), surgical implantations, or healthcare intervention (e.g. excision, etc.), and any other applications or purposes that pose a direct threat to human life.
8. You should use the Renesas Electronics products described in this document within the range specified by Renesas Electronics, especially with respect to the maximum rating, operating supply voltage range, movement power voltage range, heat radiation characteristics, installation and other product characteristics. Renesas Electronics shall have no liability for malfunctions or damages arising out of the use of Renesas Electronics products beyond such specified ranges.
9. Although Renesas Electronics endeavors to improve the quality and reliability of its products, semiconductor products have specific characteristics such as the occurrence of failure at a certain rate and malfunctions under certain use conditions. Further, Renesas Electronics products are not subject to radiation resistance design. Please be sure to implement safety measures to guard them against the possibility of physical injury, and injury or damage caused by fire in the event of the failure of a Renesas Electronics product, such as safety design for hardware and software including but not limited to redundancy, fire control and malfunction prevention, appropriate treatment for aging degradation or any other appropriate measures. Because the evaluation of microcomputer software alone is very difficult, please evaluate the safety of the final products or system manufactured by you.
10. Please contact a Renesas Electronics sales office for details as to environmental matters such as the environmental compatibility of each Renesas Electronics product. Please use Renesas Electronics products in compliance with all applicable laws and regulations that regulate the inclusion or use of controlled substances, including without limitation, the EU RoHS Directive. Renesas Electronics assumes no liability for damages or losses occurring as a result of your noncompliance with applicable laws and regulations.
11. This document may not be reproduced or duplicated, in any form, in whole or in part, without prior written consent of Renesas Electronics.
12. Please contact a Renesas Electronics sales office if you have any questions regarding the information contained in this document or Renesas Electronics products, or if you have any other inquiries.

(Note 1) “Renesas Electronics” as used in this document means Renesas Electronics Corporation and also includes its majority-owned subsidiaries.

(Note 2) “Renesas Electronics product(s)” means any product developed or manufactured by or for Renesas Electronics.

SH7280 Group

Transmission and Reception of Serial Data by the SCIF in Clock Synchronous Mode (Full-Duplex Communications)

Introduction

This application note describes transmission and reception of serial data by using the clock-synchronous transfer function of the serial communications interface with FIFO (SCIF). This application note is a summary for quick reference of information required in the design of user software.

Target Device

SH7285

Contents

1. Preface.....	2
2. Description of the Sample Application	3
3. Documents for Reference.....	14

1. Preface

1.1 Specifications

This sample application employs the clock-synchronous serial transfer function of the serial communications interface with FIFO (SCIF) to perform data transmission and reception. Figure 1 shows an example of connection for transmission and reception by the SCIF in clock-synchronous mode.

- SCIF3 is used.
- The communications format has a fixed 8-bit data length.
- Interrupts for transmission and reception are used to conduct full-duplex communications on SCIF3. That is, the data-transfer controller (DTC) is activated by the transmit-data-empty interrupt on the transmitting side and the receive-data-full interrupt on the receiving side.
- Once 32 bytes of data have been transmitted and received, each operation for transmission is halted.

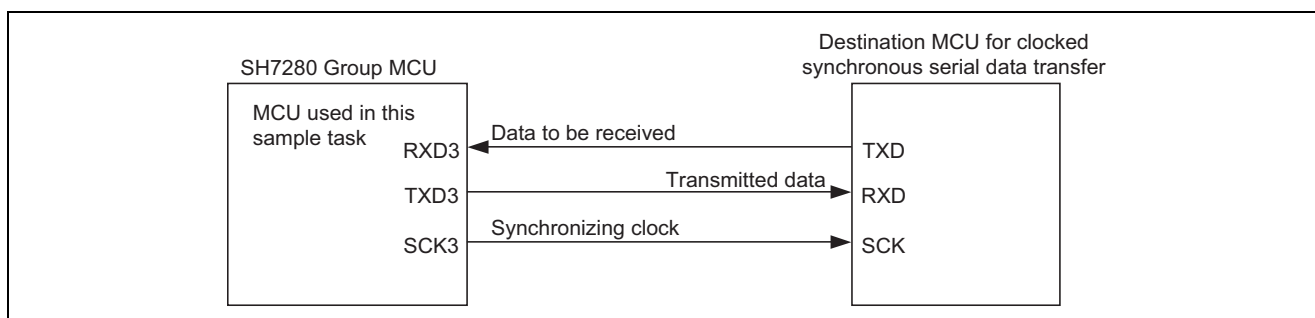

**Figure 1 Connection Example for Transmission and Reception by the SCIF
in Clock-Synchronous Mode**

1.2 Module Used

Serial communications interface with FIFO (SCIF3)

1.3 Applicable Conditions

MCU	SH7285
Operating frequency	Internal clock: 100 MHz
	Bus clock: 50 MHz
	Peripheral clock: 50 MHz
C compiler	SuperH RISC Engine Family C/C++ Compiler Package Ver.9.11 (from Renesas Technology Corp.)

2. Description of the Sample Application

This sample application employs interrupt source of the serial communications interface with FIFO (SCIF), a transmit-FIFO-data-empty interrupt (TXI) and a receive-FIFO-data-full interrupt (RXI) to transmit and receive serial data in clock-synchronous mode. In clock-synchronous mode, the SCIF transmits and receive serial data in synchronization with clock pulses.

2.1 Summary of MCU Module Used

In clock-synchronous mode, the SCIF transmits and receives data in synchronization with clock pulses. This mode is suitable for high-speed serial communications. An internal clock or an external clock from the SCK pin can be selected as the SCIF clock source. When an internal clock has been selected, a synchronizing clock is output from the SCK pin. When an external clock has been selected, a synchronizing clock is input into the SCK pin. The transmitting and receiving sections of the SCIF are independent, so full-duplex communications is possible while sharing the same clock. Both the transmitter and receiver have a 16-stage FIFO buffered structure so that data can be read or written during transmission and reception, which enables high-speed continuous data transfer.

In clock-synchronous serial communications, each data bit is output on the communications line from one falling edge of the serial clock to the next. Data is guaranteed valid at the rising edge of the serial clock.

In each character, the serial data bits are transmitted in order from the LSB (first) to the MSB (last). After output of the MSB, the communications line remains in the state of the MSB.

For details on the SCIF, please refer to the section on serial communications interface with FIFO in the *SH7280 Group Hardware Manual*.

Table 1 gives an overview of serial communications in clock-synchronous mode. Figure 2 shows a block diagram of the SCIF.

Table 1 Overview of Serial Data Communications in Clock-Synchronous Mode

Item	Description
Number of interfaces	1 (SCIF3)
Clock sources	For internal clock: $P\phi$, $P\phi/4$, $P\phi/16$, $P\phi/64$ ($P\phi$: peripheral clock) For external clock: input clock on the SCK3 pin
Data format	Transfer data length: Fixed at 8 bits Order: LSB first and MSB first are selectable
Baud rate	For internal clock: 1 to 500 kbps ($P\phi = 50$ MHz) For external clock: up to 8,333,333.3 bps ($P\phi = 50$ MHz, external input clock of 8.3333 MHz)
Error detection	Overrun error
Interrupt requests	Transmit-FIFO-data-empty interrupt (TXI) Receive-FIFO-data-full interrupt (RXI) Break interrupt (BRI)
Clock sources	Internal and external clocks are selectable <ul style="list-style-type: none"> • Internal clock When the internal clock has been selected, the SCIF operates using the clock from the baud-rate generator and outputs this clock to external devices as the synchronizing clock. • External clock When the external clock has been selected, the SCIF operates on the input synchronizing clock, not using the on-chip baud rate generator.

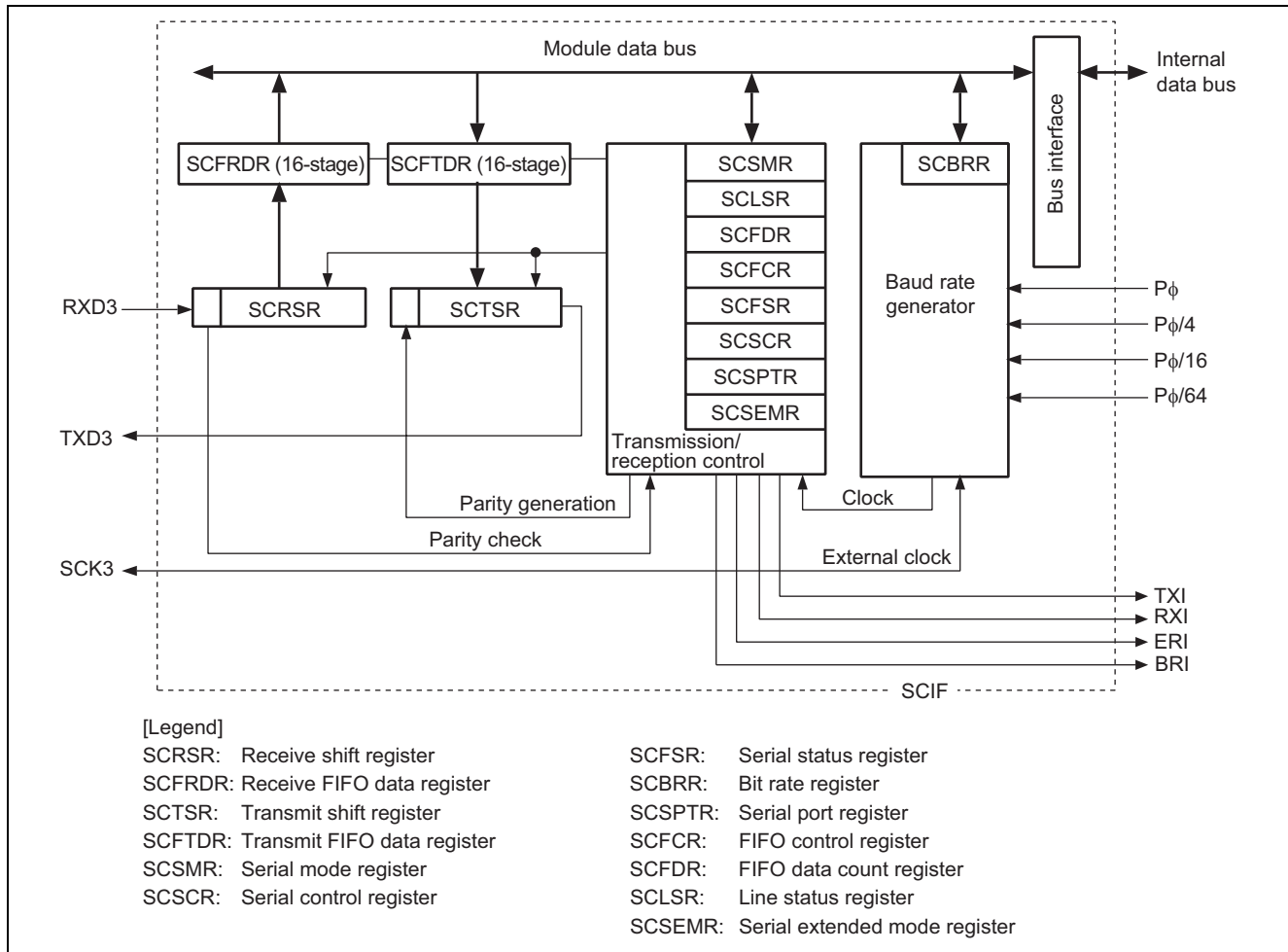

Figure 2 Block Diagram of the SCIF

2.2 Description of the Sample Program

Table 2 gives the settings for SCIF communications function of this sample program, and figure 3 shows the operations in data transmission and reception.

Table 2 Settings for Communications Function of the Sample Program

Item	Description
Module	SCIF3
Communications mode	Clock-synchronous mode
Interrupts	Transmit-FIFO-data-empty interrupt (TXI) Receive-FIFO-data-full interrupt (RXI) Break interrupt (BRI)
Transfer rate	100 kbps
Number of data to be transmitted and received	32 bytes
Data length	8-bit data (fixed)
Bit order	LSB-first
Synchronizing clock	Internal clock/ synchronizing clock on the SCK pin
FIFO data trigger number	Receive FIFO data trigger: 8 Transmit FIFO data trigger: 8
Loop-back test function	Disabled

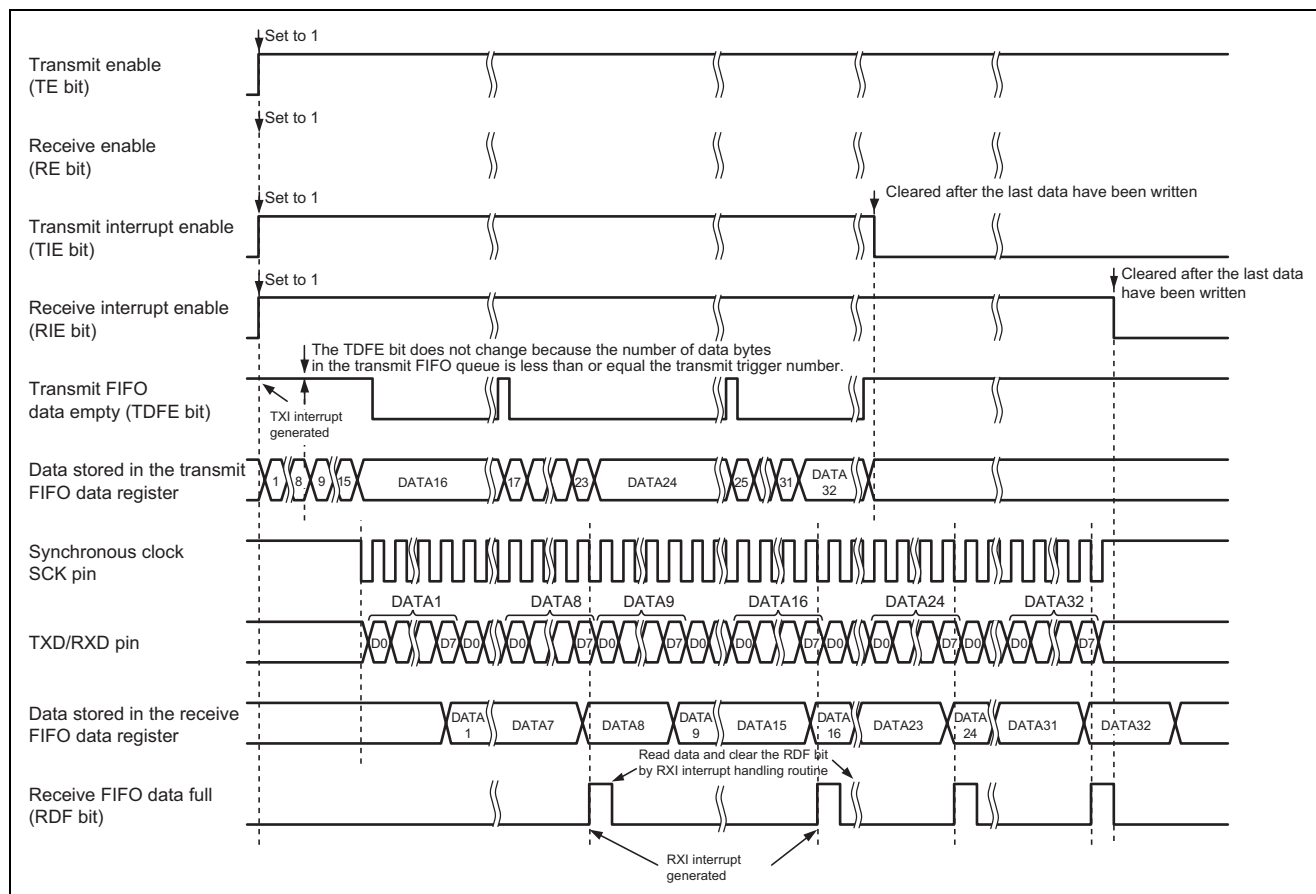

Figure 3 Operations for Data Transmission and Reception

2.3 Procedure for Setting Module Used

This section describes the procedure for setting up SCIF3 for clock-synchronous mode operation.

Figure 4 shows the flow of processing by the sample program, figure 5 shows the flow of settings for release from module-standby mode, figure 6 shows the flow for setting up the pin function controller. Furthermore, figure 7 shows the flow for initialization of data transmission and reception in clock-synchronous mode, figure 8 shows the flow for handling transmit interrupts in clock-synchronous mode, and figure 9 shows the flow for handling receive interrupts in clock-synchronous mode, and figure 10 shows the flow for handling receive error interrupts in clock-synchronous mode. For details on the settings of individual registers, see the *SH7280 Group Hardware Manual*.

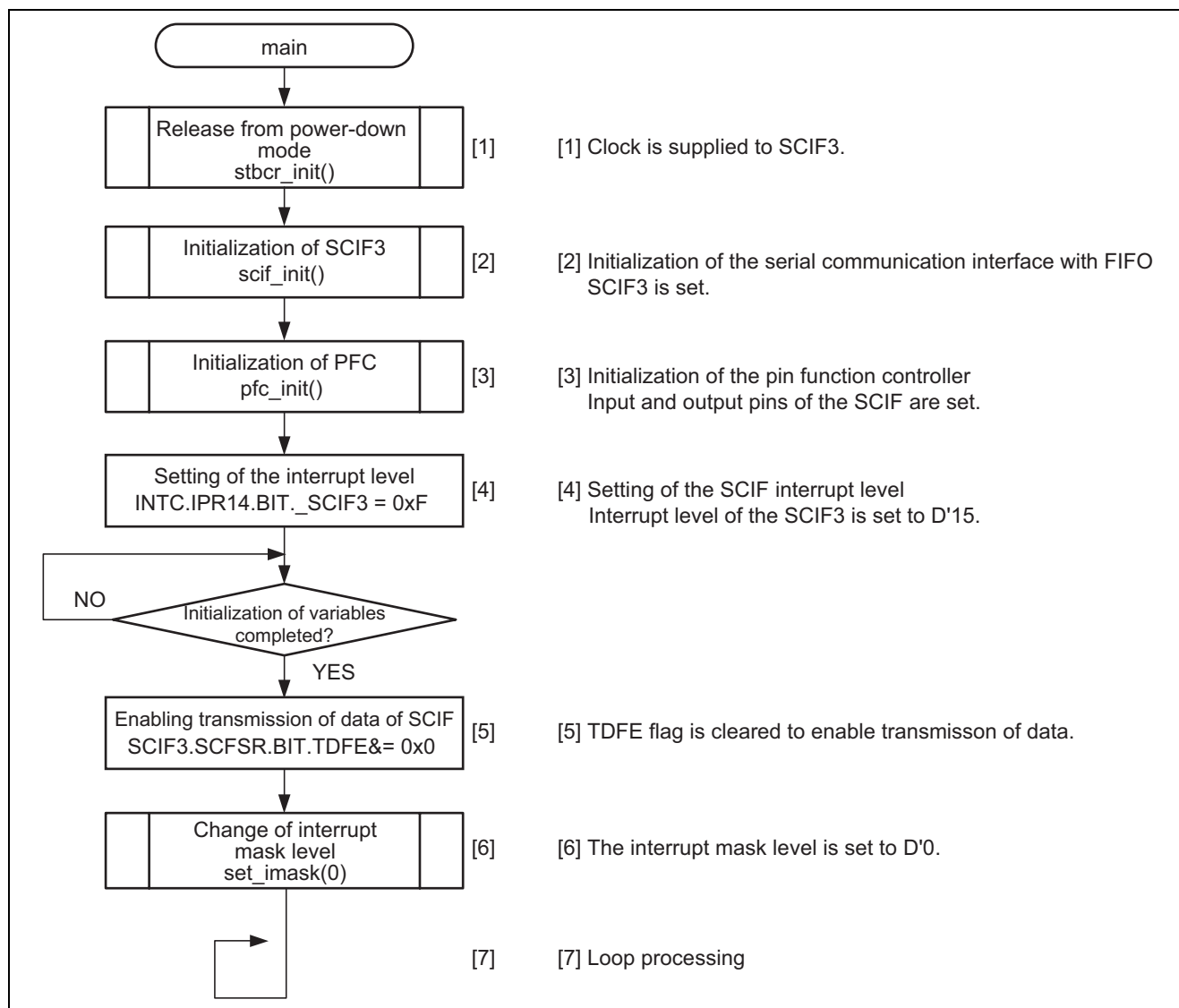

Figure 4 Flow of Processing by the Sample Program

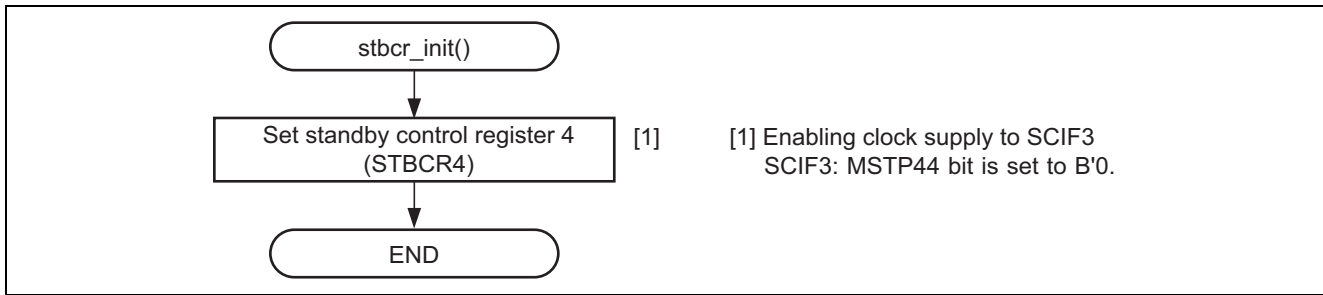

Figure 5 Flow of Settings for Release from Module-Standby Mode

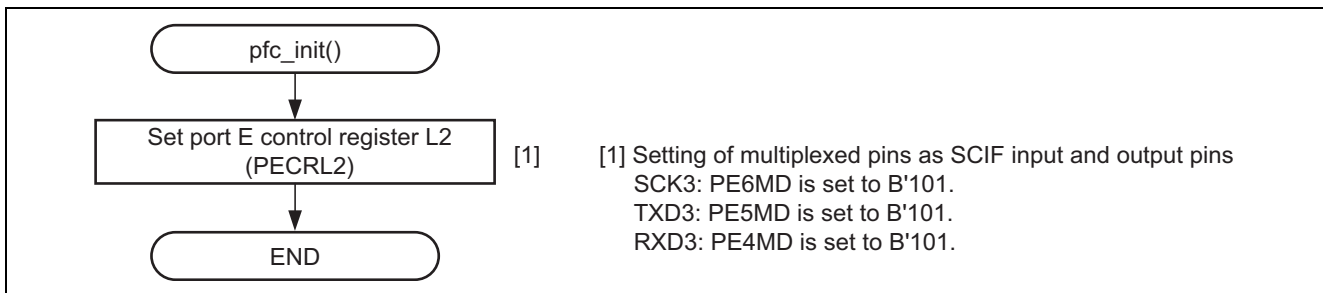

Figure 6 Flow for Setting up the Pin Function Controller

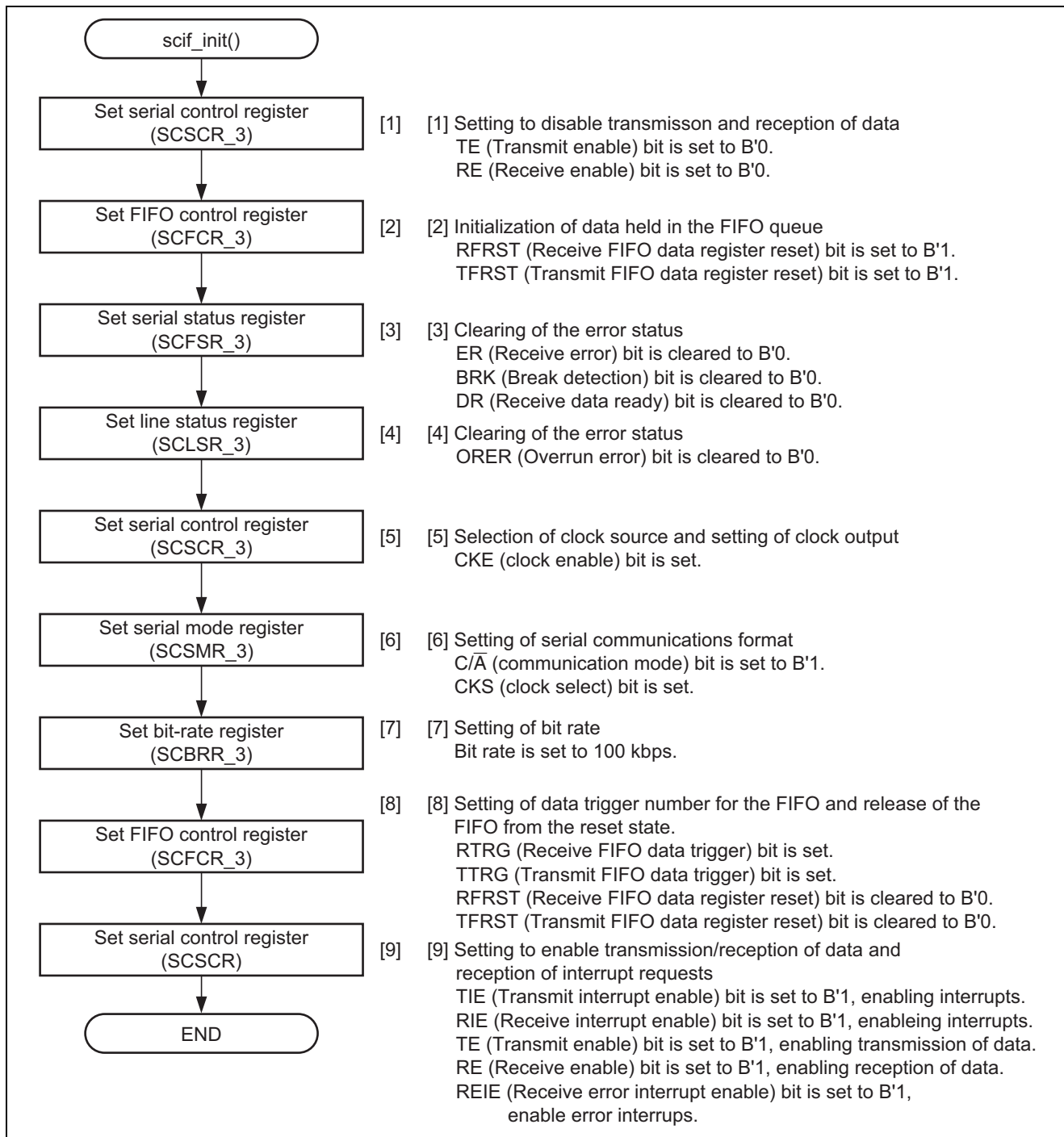

Figure 7 Flow for Initialization of Data Transmission and Reception in Clock-Synchronous Mode

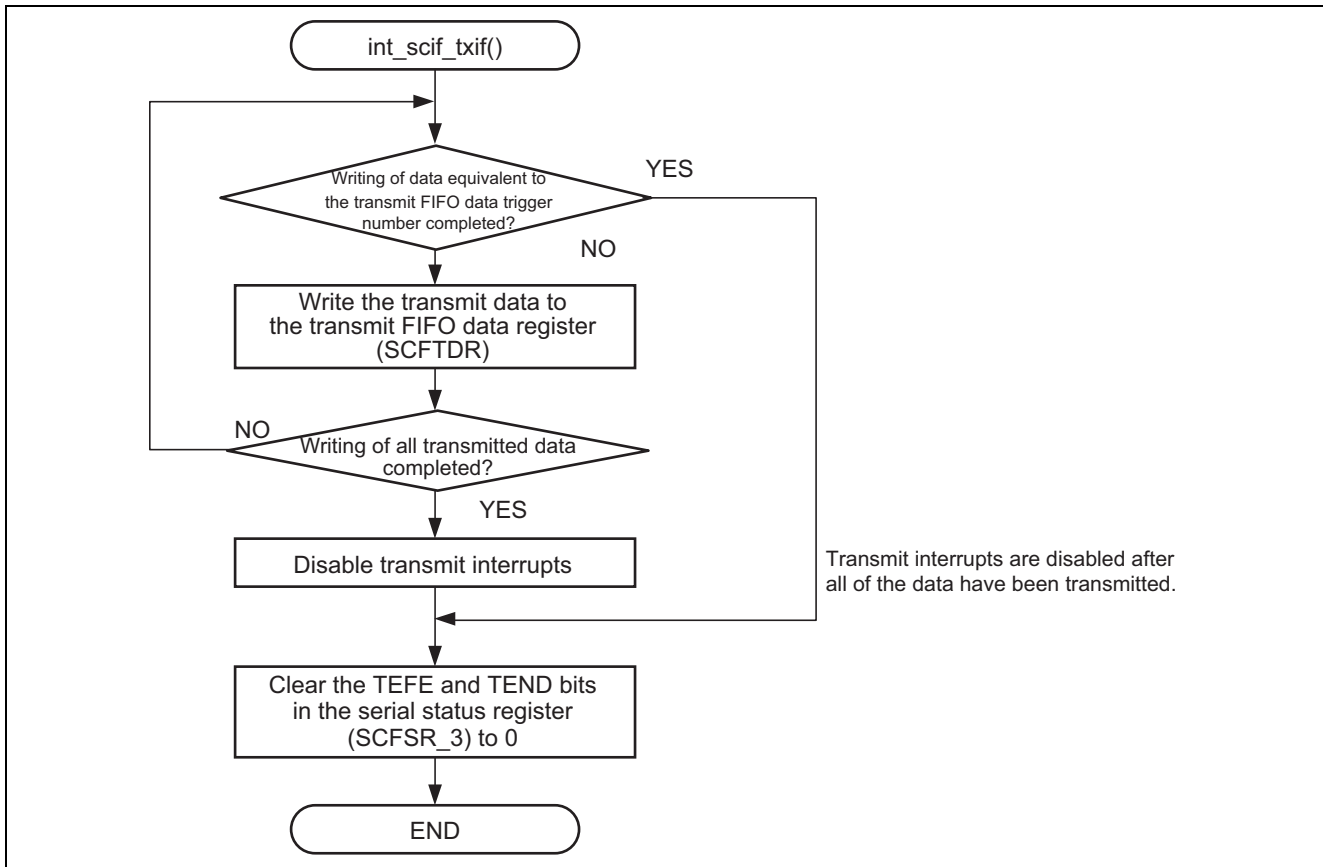

Figure 8 Flow for Handling Transmit Interrupts in Clock-Synchronous Mode

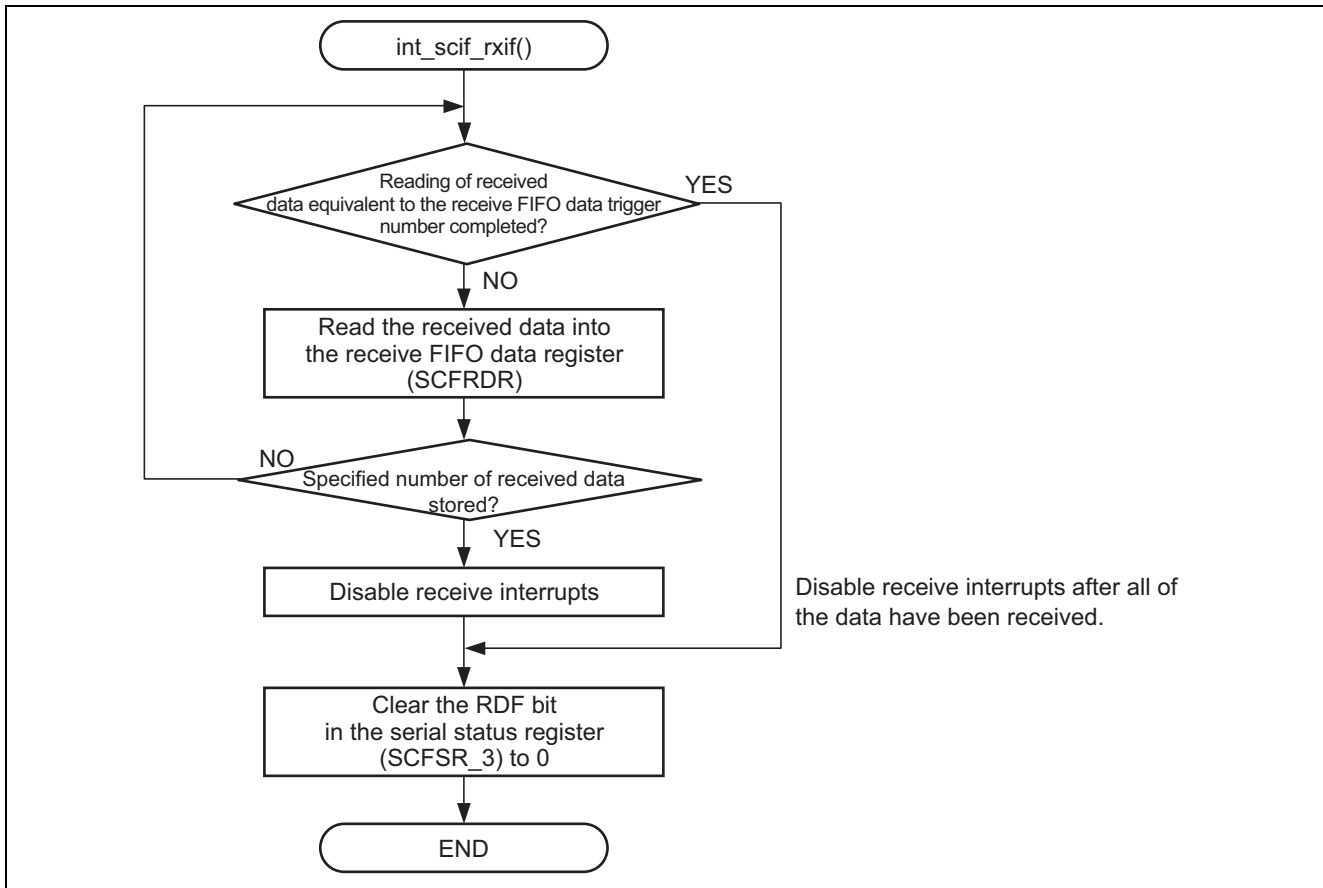

Figure 9 Flow for Handling Receive Interrupts in Clock-Synchronous Mode

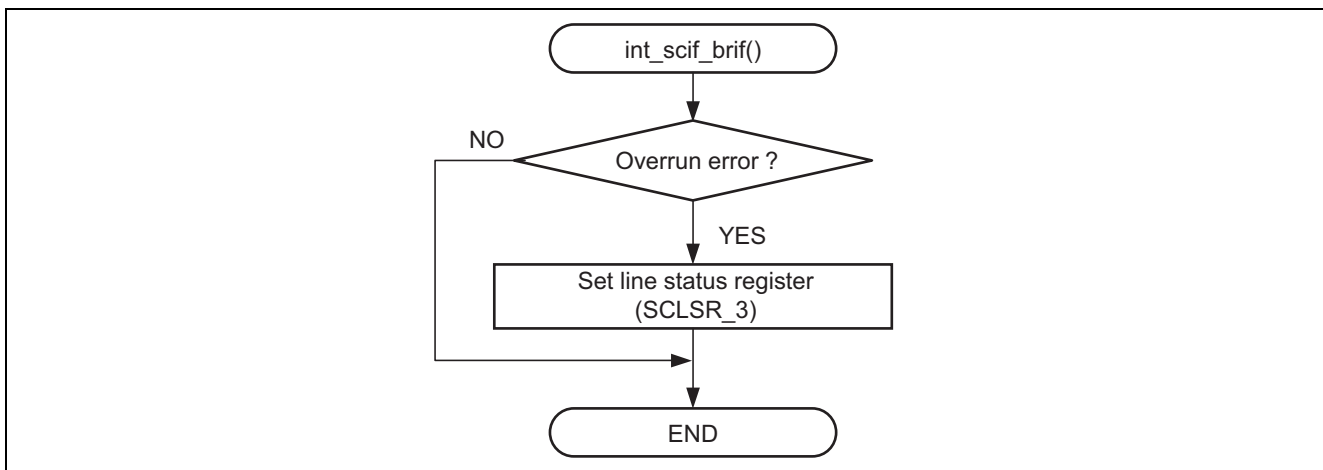

Figure 10 Flow for Handling Receive Error Interrupts in Clock-Synchronous Mode

2.4 Procedure for Processing by the Sample Program

In this sample program, character strings are transmitted and received after initialization of SCIF3 for data reception in clock-synchronous mode.

2.4.1 Clock Pulse Generator (CPG)

Table 3 gives settings for the register of the clock pulse generator in the sample program.

Table 3 Settings for Register in Clock Pulse Generator

Register Name	Address	Setting	Description
Frequency control register (FRQCR)	H'FFFE0010	H'0101	STC [2:0] = B'001: $\times 1/2$ (B ϕ) IFC [2:0] = B'000: $\times 1$ (I ϕ) PFC [2:0] = B'001: $\times 1/2$ (P ϕ)

2.4.2 Standby Control Register

Table 4 gives settings for the standby control register in the sample program.

Table 4 Settings for Standby Control Register

Register Name	Address	Setting	Description
Standby control register 4 (STBCR4)	H'FFFE040C	H'E4	MSTP44 = B'0: SCIF3 operates

2.4.3 Interrupt Controller (INTC)

Table 5 gives settings for the register of the interrupt controller in the sample program.

Table 5 Settings for Register of Interrupt Controller

Register Name	Address	Setting	Description
Interrupt priority register 14 (IPR14)	H'FFFE0C10	H'000F	IPR14 [3:0] = H'F: SCIF3 is at a level 15

2.4.4 Pin Function Controller (PFC)

Table 6 gives settings for the register of the pin function controller in the sample program.

Table 6 Settings for Register of Pin Function Controller

Register Name	Address	Setting	Description
Port E control register L2 (PECRL2)	H'FFFE3A14	H'0555	PE6MD [2:0] = B'101: SCK3 input/output PE5MD [2:0] = B'101: TXD3 output PE4MD [2:0] = B'101: RXD3 input

2.4.5 Serial Communications Interface with FIFO

Table 7 gives settings for the registers of the SCIF in the sample program.

Table 7 Settings for SCIF Register

Register Name	Address	Setting	Description
Serial mode register (SCSMR)	H'FFFE8800	H'0080	C/A = B'1: Clock-synchronous mode CHR = B'0: 8-bit data CKS [1:0] = B'00: P ϕ clock
Bit rate register (SCBRR)	H'FFFE8804	D'124	Clock-synchronous mode Bit rate: 100k (bit/s) * ¹
Serial control register (SCSCR)	H'FFFE8808	H'0002	Initialization RIE = B'0: Disables receive-FIFO-data-full interrupt (RXI), receive-error-interrupt (ERI), and break interrupt (BRI) requests RE = B'0: Disables reception of data REIE = B'0: Disables receive-error-interrupt (ERI) and break interrupt (BRI) requests
			At the time of setting Clock-synchronous mode CKE [1:0] = B'00: Internal clock, SCK pin is used for synchronizing clock output
		H'00FA	When transmitting/receiving operation is enabled TIE = B'1: Enables transmit-FIFO-data-empty interrupt (TXI) request RIE = B'1: Enables receive-FIFO-data-full interrupt (RXI) request TE = B'1: Enables transmission of data RE = B'1: Enables reception of data REIE = B'0: Enables receive-error-interrupt (ERI) and break interrupt (BRI) requests
Serial status register (SCFSR)	H'FFFE8810	H'0060	Initial value TEND = B'1: Transmit end flag TDFE = B'1: Transmit-FIFO-data-empty flag
		H'0000	At the time of setting All flags are cleared to 0.
FIFO control register (SCFCR)	H'FFFE8818	H'0060	Initialization TFRST = B'1: Enables reset operation of transmitted data in the transmit-FIFO-data register RFRST = B'1: Enables reset operation of received data in the receive-FIFO-data register

H'0080	At the time of setting RTRG [1:0] = B'10: 8 number of received data TTRG [1:0] = B'00: 8 number of transmitted data TFRST = B'0: Disables reset operation of transmitted data in the transmit- FIFO-data register RFRST = B'0: Disables reset operation of received data in the receive-FIFO- data register LOOP = B'0: Disables loop back test
--------	--

Note: 1. For details on bit rate settings, see the table of bit rates and SCBRR settings in the section on the serial communication interface with FIFO of the *SH7280 Group Hardware Manual*.

3. Documents for Reference

- Software Manual
SH-2A, SH2A-FPU Software Manual
The most up-to-date version of this document is available on the Renesas Technology Website.
- Hardware Manual
SH7280 Group Hardware Manual
The most up-to-date version of this document is available on the Renesas Technology Website.

Website and Support

Renesas Technology Website

<http://www.renesas.com/>

Inquiries

<http://www.renesas.com/inquiry>

csc@renesas.com

Revision Record

Rev.	Date	Description	
		Page	Summary
1.00	Aug.27.08	—	First edition issued

All trademarks and registered trademarks are the property of their respective owners.

Notes regarding these materials

1. This document is provided for reference purposes only so that Renesas customers may select the appropriate Renesas products for their use. Renesas neither makes warranties or representations with respect to the accuracy or completeness of the information contained in this document nor grants any license to any intellectual property rights or any other rights of Renesas or any third party with respect to the information in this document.
2. Renesas shall have no liability for damages or infringement of any intellectual property or other rights arising out of the use of any information in this document, including, but not limited to, product data, diagrams, charts, programs, algorithms, and application circuit examples.
3. You should not use the products or the technology described in this document for the purpose of military applications such as the development of weapons of mass destruction or for the purpose of any other military use. When exporting the products or technology described herein, you should follow the applicable export control laws and regulations, and procedures required by such laws and regulations.
4. All information included in this document such as product data, diagrams, charts, programs, algorithms, and application circuit examples, is current as of the date this document is issued. Such information, however, is subject to change without any prior notice. Before purchasing or using any Renesas products listed in this document, please confirm the latest product information with a Renesas sales office. Also, please pay regular and careful attention to additional and different information to be disclosed by Renesas such as that disclosed through our website. (<http://www.renesas.com>)
5. Renesas has used reasonable care in compiling the information included in this document, but Renesas assumes no liability whatsoever for any damages incurred as a result of errors or omissions in the information included in this document.
6. When using or otherwise relying on the information in this document, you should evaluate the information in light of the total system before deciding about the applicability of such information to the intended application. Renesas makes no representations, warranties or guaranties regarding the suitability of its products for any particular application and specifically disclaims any liability arising out of the application and use of the information in this document or Renesas products.
7. With the exception of products specified by Renesas as suitable for automobile applications, Renesas products are not designed, manufactured or tested for applications or otherwise in systems the failure or malfunction of which may cause a direct threat to human life or create a risk of human injury or which require especially high quality and reliability such as safety systems, or equipment or systems for transportation and traffic, healthcare, combustion control, aerospace and aeronautics, nuclear power, or undersea communication transmission. If you are considering the use of our products for such purposes, please contact a Renesas sales office beforehand. Renesas shall have no liability for damages arising out of the uses set forth above.
8. Notwithstanding the preceding paragraph, you should not use Renesas products for the purposes listed below:
 - (1) artificial life support devices or systems
 - (2) surgical implantations
 - (3) healthcare intervention (e.g., excision, administration of medication, etc.)
 - (4) any other purposes that pose a direct threat to human life
 Renesas shall have no liability for damages arising out of the uses set forth in the above and purchasers who elect to use Renesas products in any of the foregoing applications shall indemnify and hold harmless Renesas Technology Corp., its affiliated companies and their officers, directors, and employees against any and all damages arising out of such applications.
9. You should use the products described herein within the range specified by Renesas, especially with respect to the maximum rating, operating supply voltage range, movement power voltage range, heat radiation characteristics, installation and other product characteristics. Renesas shall have no liability for malfunctions or damages arising out of the use of Renesas products beyond such specified ranges.
10. Although Renesas endeavors to improve the quality and reliability of its products, IC products have specific characteristics such as the occurrence of failure at a certain rate and malfunctions under certain use conditions. Please be sure to implement safety measures to guard against the possibility of physical injury, and injury or damage caused by fire in the event of the failure of a Renesas product, such as safety design for hardware and software including but not limited to redundancy, fire control and malfunction prevention, appropriate treatment for aging degradation or any other applicable measures. Among others, since the evaluation of microcomputer software alone is very difficult, please evaluate the safety of the final products or system manufactured by you.
11. In case Renesas products listed in this document are detached from the products to which the Renesas products are attached or affixed, the risk of accident such as swallowing by infants and small children is very high. You should implement safety measures so that Renesas products may not be easily detached from your products. Renesas shall have no liability for damages arising out of such detachment.
12. This document may not be reproduced or duplicated, in any form, in whole or in part, without prior written approval from Renesas.
13. Please contact a Renesas sales office if you have any questions regarding the information contained in this document, Renesas semiconductor products, or if you have any other inquiries.