

8

7

6

5

4

3

2

1

REVISIONS				
DCN	REV	DESCRIPTION	DATE	CHANGE BY
	A	INITIAL RELEASE	2010-08-05	K. LEUNG

IDT 89HP0604S(B) 36-QFN SATA EVALUATION BOARD

TABLE OF CONTENTS

89HP0604S, POWER.....2

89HP0604S, SATA CONNECTORS...3

DLP CONTROLLER.....4

SATA-TO-SMA BREAK OUT.....5

89HP0604SB, POWER.....6

89HP0604SB, SATA CONNECTORS..7



CONFIDENTIAL PROPERTY OF INTEGRATED DEVICE TECHNOLOGY, INC.
 6024 SILVER CREEK VALLEY ROAD, SAN JOSE, CA 95138
 COPYRIGHT (C) 2010 IDT

TITLE			
89EBP0604S(B) Eval Board			
SIZE	DRAWING NO.	FAB P/N	REV.
B	P0604S-SATA-EB-001	18-703-000	A
AUTHOR		CHECKED BY	
K. Leung		D. Huang	
Tue Aug 31 12:33:49 2010			SHEET 1 OF 7

8

7

6

5

4

3

2

1

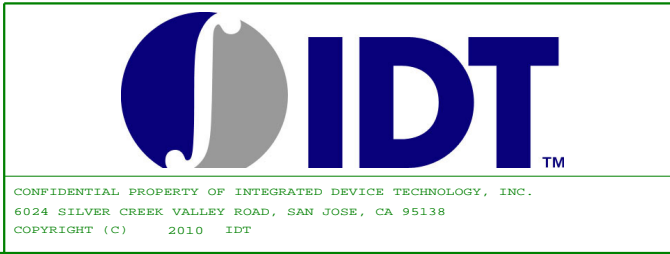
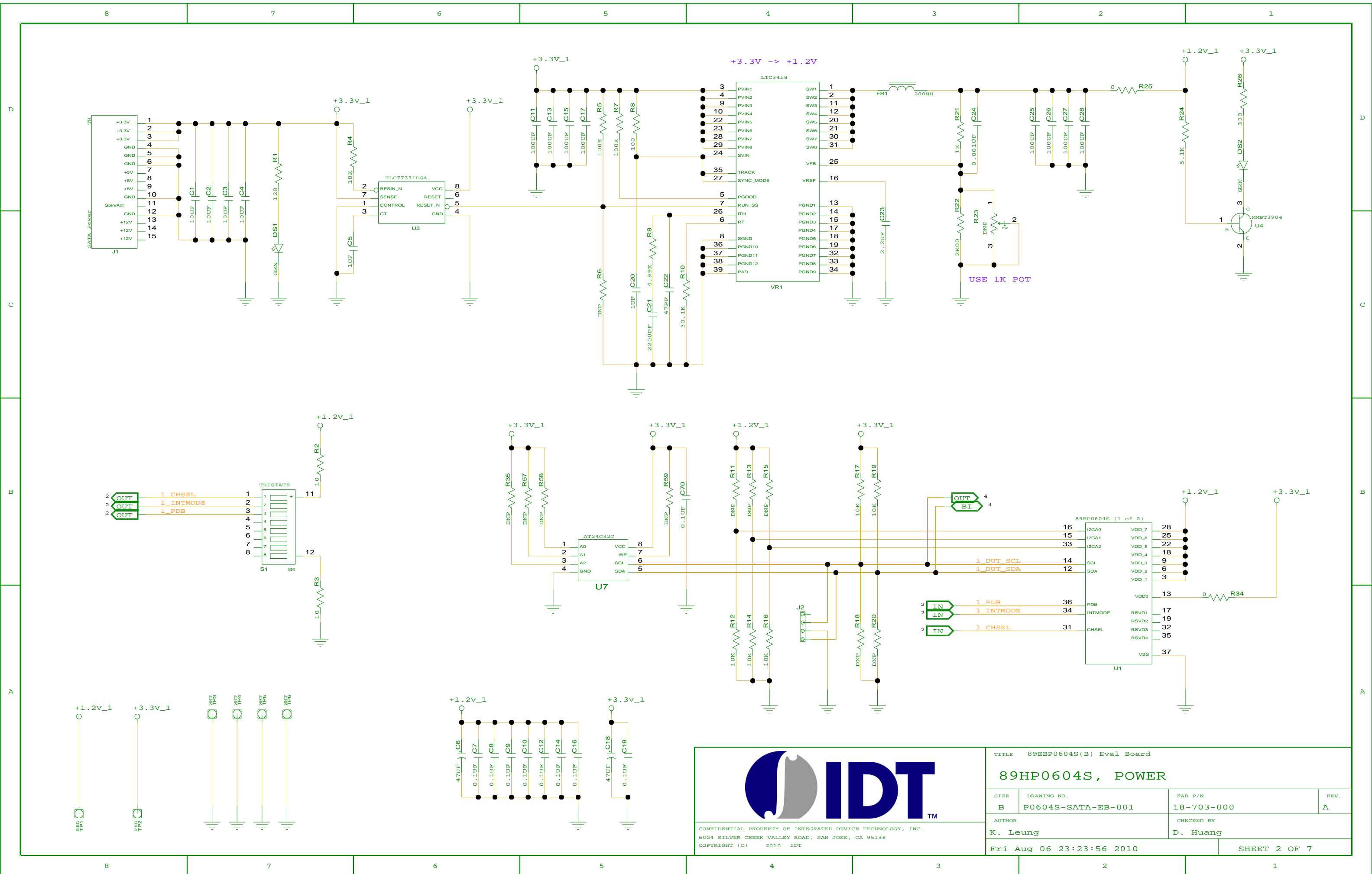

TITLE 89EP0604S(B) Eval Board			
89HP0604S, POWER			
SIZE	DRAWING NO.	FAB P/N	REV.
B	P0604S-SATA-EB-001	18-703-000	A
AUTHOR		CHECKED BY	
K. Leung		D. Huang	
Fri Aug 06 23:23:56 2010			SHEET 2 OF 7

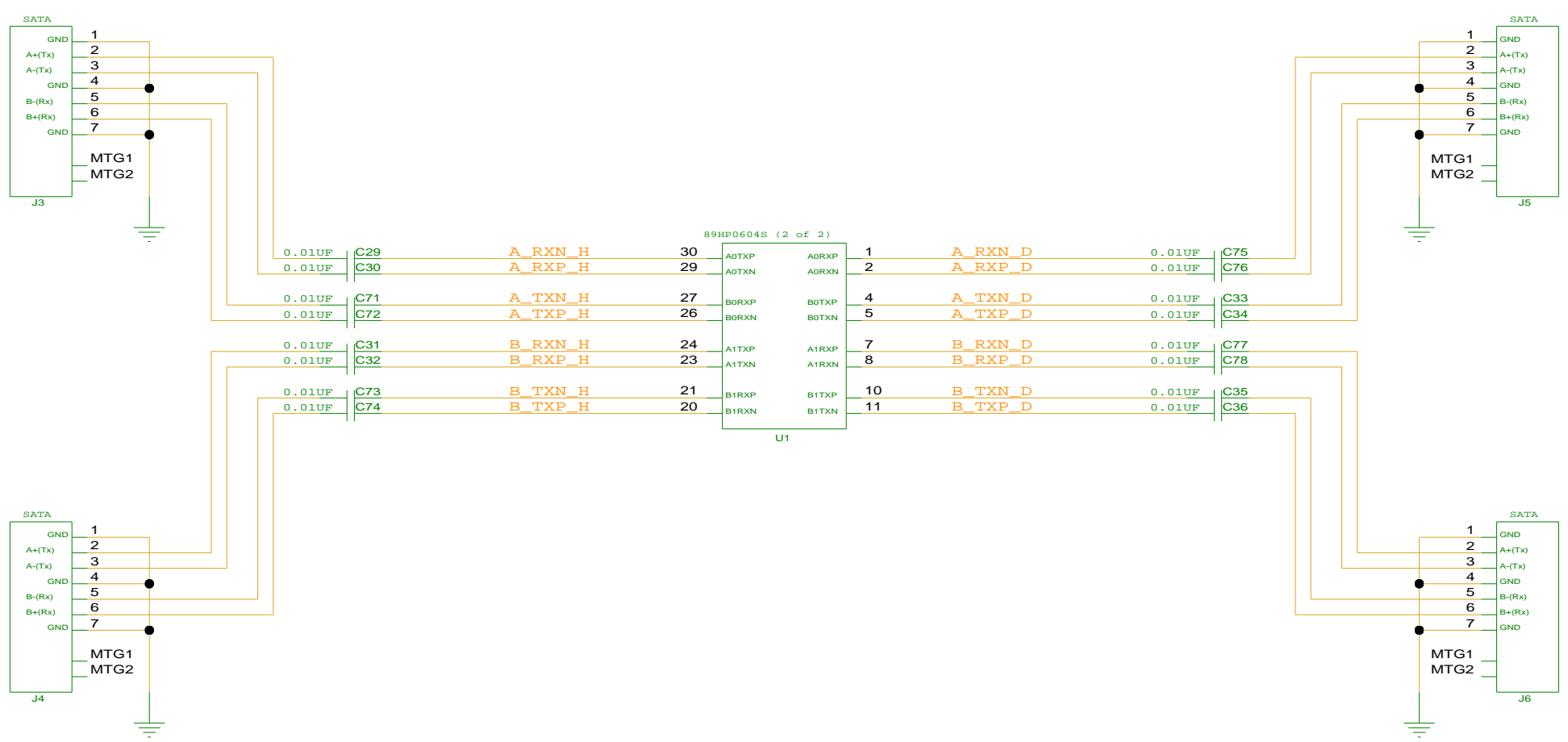

		TITLE 89BP0604S(B) Eval Board 89HP0604S, SATA CONNECTORS		
		SIZE B	DRAWING NO. P0604S-SATA-EB-001	FAB P/N 18-703-000
CONFIDENTIAL PROPERTY OF INTEGRATED DEVICE TECHNOLOGY, INC. 6024 SILVER CREEK VALLEY ROAD, SAN JOSE, CA 95138 COPYRIGHT (C) 2010 IDT		AUTHOR K. Leung	CHECKED BY D. Huang	
Tue Aug 31 12:33:11 2010			SHEET 3 OF 7	

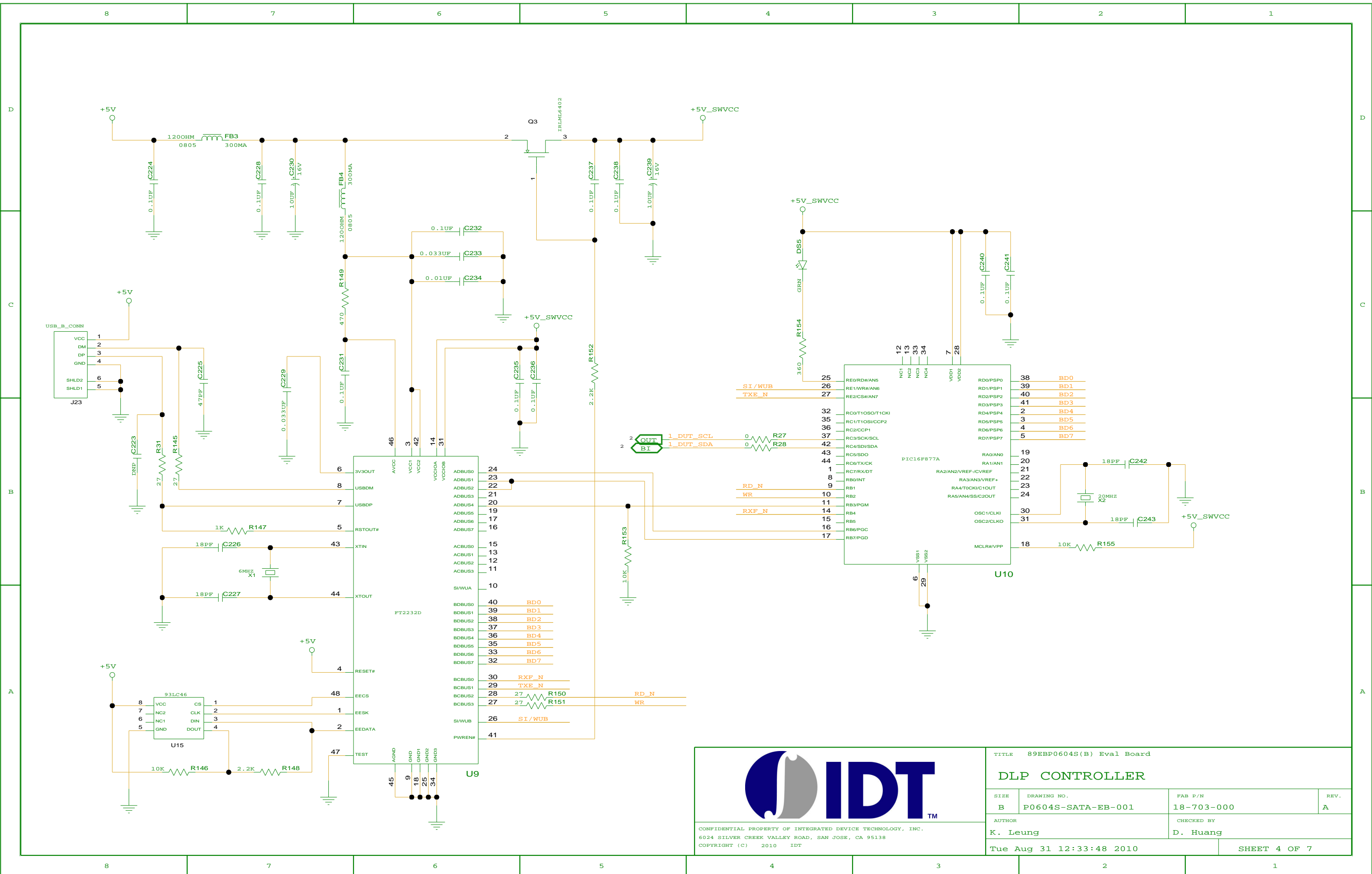

CONFIDENTIAL PROPERTY OF INTEGRATED DEVICE TECHNOLOGY, INC.
 6024 SILVER CREEK VALLEY ROAD, SAN JOSE, CA 95138
 COPYRIGHT (C) 2010 IDT

TITLE 89EP0604S(B) Eval Board			
DLP CONTROLLER			
SIZE	DRAWING NO.	FAB P/N	REV.
B	P0604S-SATA-EB-001	18-703-000	A
AUTHOR		CHECKED BY	
K. Leung		D. Huang	
Tue Aug 31 12:33:48 2010			SHEET 4 OF 7

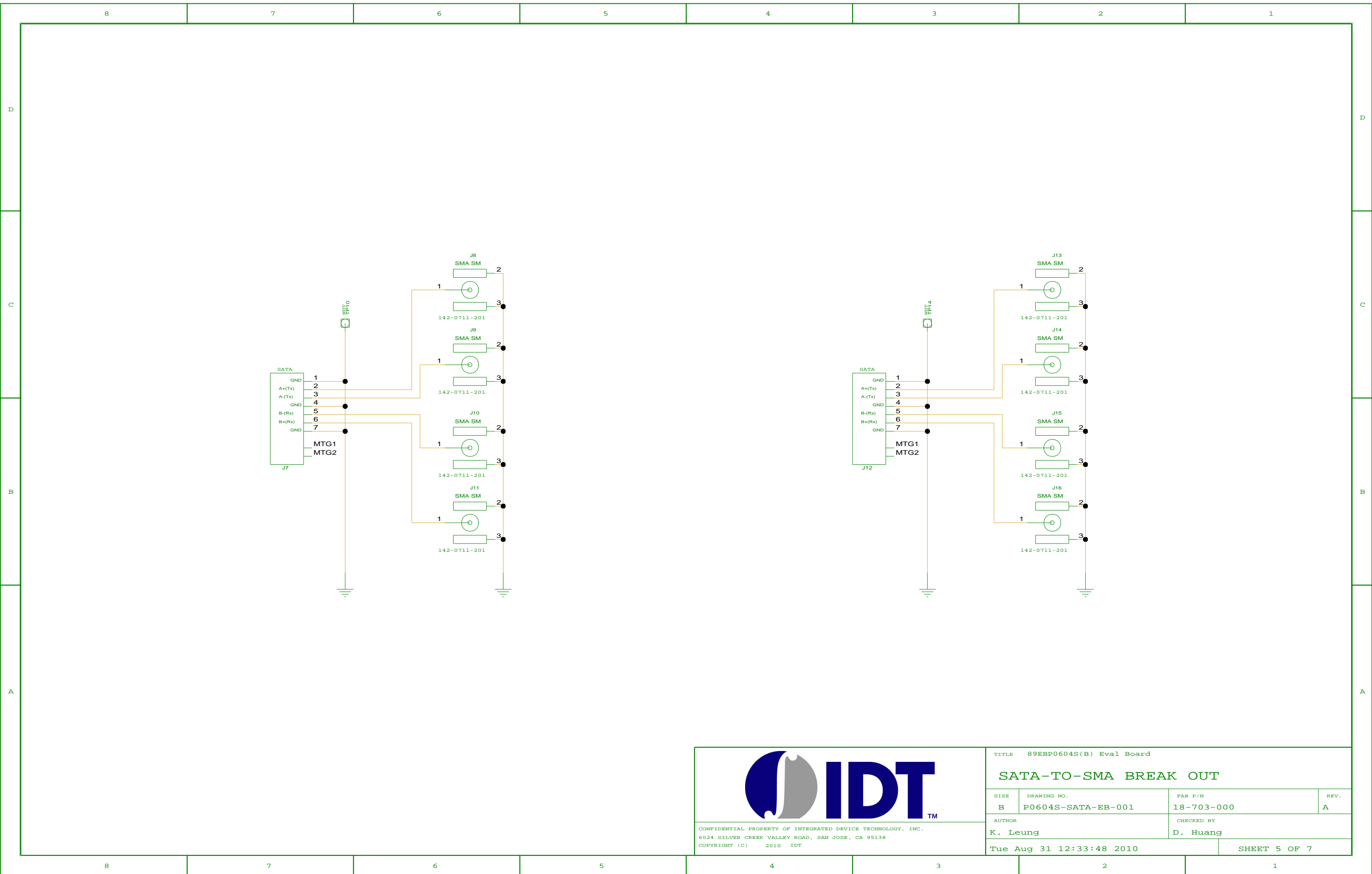

CONFIDENTIAL PROPERTY OF INTEGRATED DEVICE TECHNOLOGY, INC.
 6024 SILVER CREEK VALLEY ROAD, SAN JOSE, CA 95138
 COPYRIGHT (C) 2010 IDT

TITLE 89EBP0604S(B) Eval Board

SATA-TO-SMA BREAK OUT

SIZE B	DRAWING NO. P0604S-SATA-EB-001	FAB P/N 18-703-000	REV. A
-----------	-----------------------------------	-----------------------	-----------

AUTHOR K. Leung	CHECKED BY D. Huang
--------------------	------------------------

Tue Aug 31 12:33:48 2010 SHEET 5 OF 7

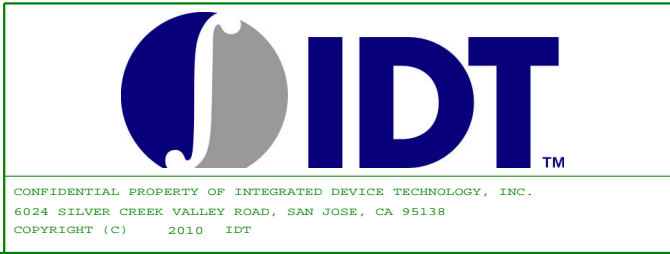
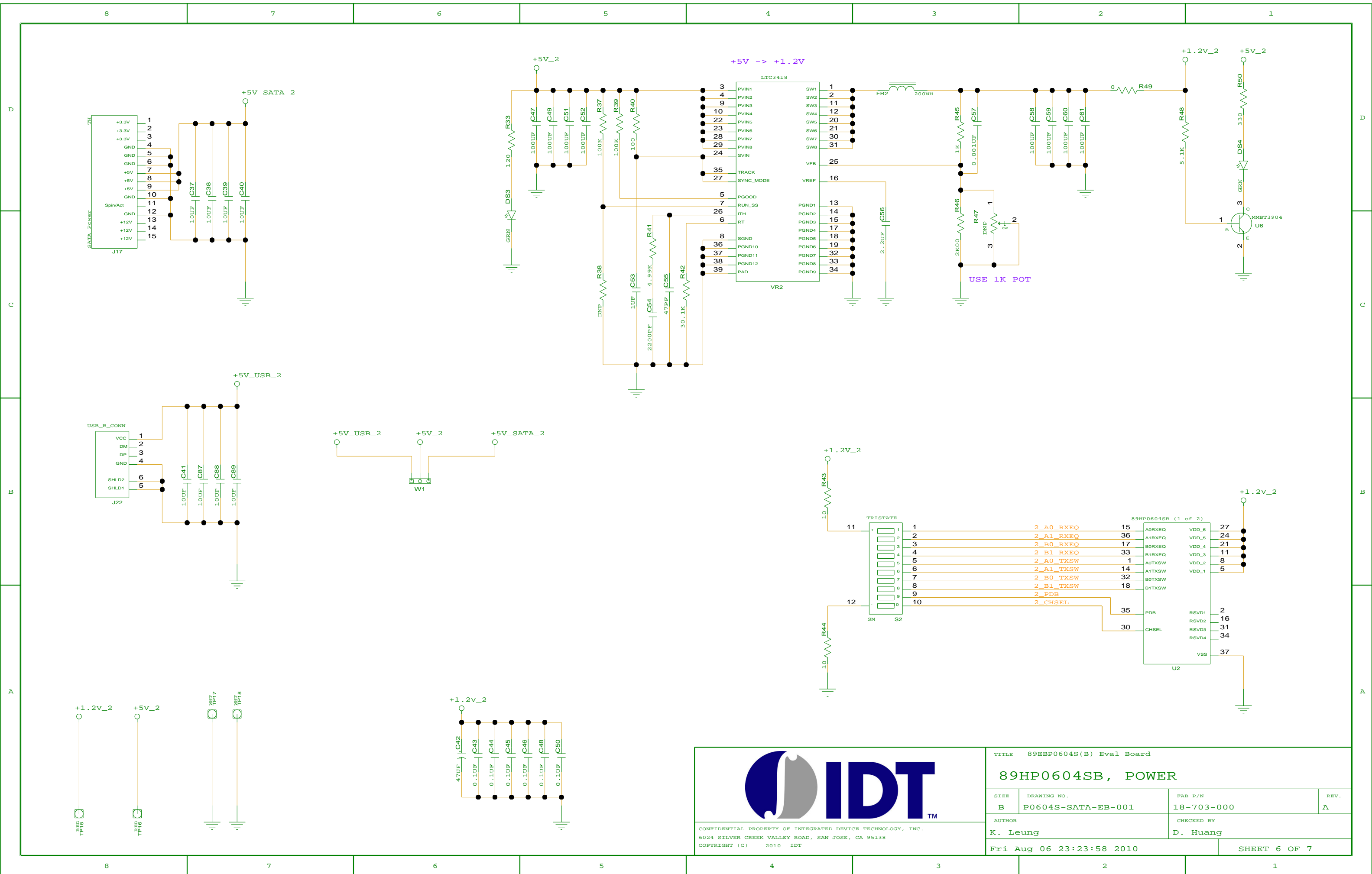

TITLE 89EBP0604S(B) Eval Board			
89HP0604SB, POWER			
SIZE	DRAWING NO.	FAB P/N	REV.
B	P0604S-SATA-EB-001	18-703-000	A
AUTHOR		CHECKED BY	
K. Leung		D. Huang	
Fri Aug 06 23:23:58 2010			SHEET 6 OF 7

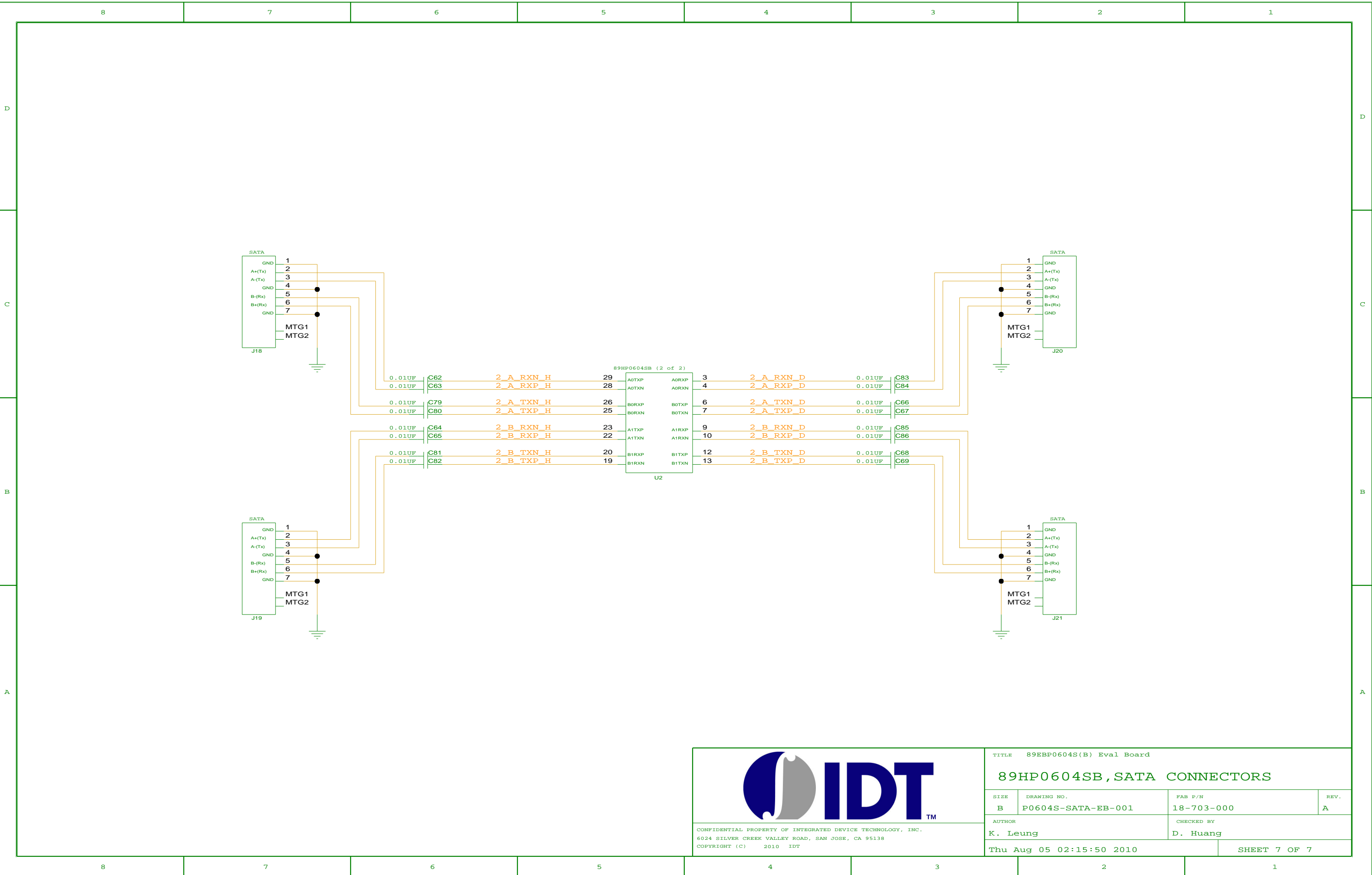

CONFIDENTIAL PROPERTY OF INTEGRATED DEVICE TECHNOLOGY, INC.
 6024 SILVER CREEK VALLEY ROAD, SAN JOSE, CA 95138
 COPYRIGHT (C) 2010 IDT

TITLE 89EBP0604S(B) Eval Board			
89HP0604SB, SATA CONNECTORS			
SIZE	DRAWING NO.	FAB P/N	REV.
B	P0604S-SATA-EB-001	18-703-000	A
AUTHOR		CHECKED BY	
K. Leung		D. Huang	
Thu Aug 05 02:15:50 2010			SHEET 7 OF 7