

Smart Configurator for RZ

R20AN0574ES0100

Rev.1.00

User's Guide

July 31, 2020

Introduction

This application note describes the basic usage of the Smart Configurator for RZ (hereafter called the Smart Configurator)

Target Devices and Compilers

Refer to the following URL for the range of supported devices and compilers:

<https://www.renesas.com/smart-configurator>

Contents

1. Overview	3
1.1 Purpose	3
1.2 Features	3
2. Creating a Smart Configurator project	3
3. Operating the Smart Configurator	4
3.1 Procedure for Operation	4
3.2 File to be saved as Project Information	4
3.3 Window	5
3.3.1 MCU Package view	6
3.3.2 Console view	6
3.3.3 Configuration Problems view	7
3.4 Pin Settings	7
3.4.1 Assigning pins using the MCU Package view	9
3.4.2 Exporting pin settings	10
3.4.3 Importing pin settings	11
3.4.4 Pin filter feature	11
3.5 MCU migration feature	12
4. Generating Source Code	14
4.1 Generating a Source File	14
4.2 Folder Structure and output files	15
5. Generating Report on Smart Configurator	16
5.1 Report on Device Configurations	16
5.2 Configuration of Pin Function List and Pin Number List (in csv Format)	17
5.3 Image of MCU Package (in png format)	17
6. Help	18

7. Documents for Reference..... 18

Website and Support 18

1. Overview

1.1 Purpose

This application note describes the basic usage of the Smart Configurator tool for the RZ device family.

1.2 Features

The Smart Configurator is a utility for configuring pin multiplexing settings, resolving conflicts and generating pin initialization code.

2. Creating a Smart Configurator project

The following describes the procedure for creating a Smart Configurator project.

- (1) Launch the Smart Configurator and select **[File]** → **[New]**.
- (2) Select a device, for example, **R8A77450** from the left panel of the **[New Smart Configuration File]** dialog box.
- (3) Specify a **[File name]** and click **[Finish]** button as shown below.

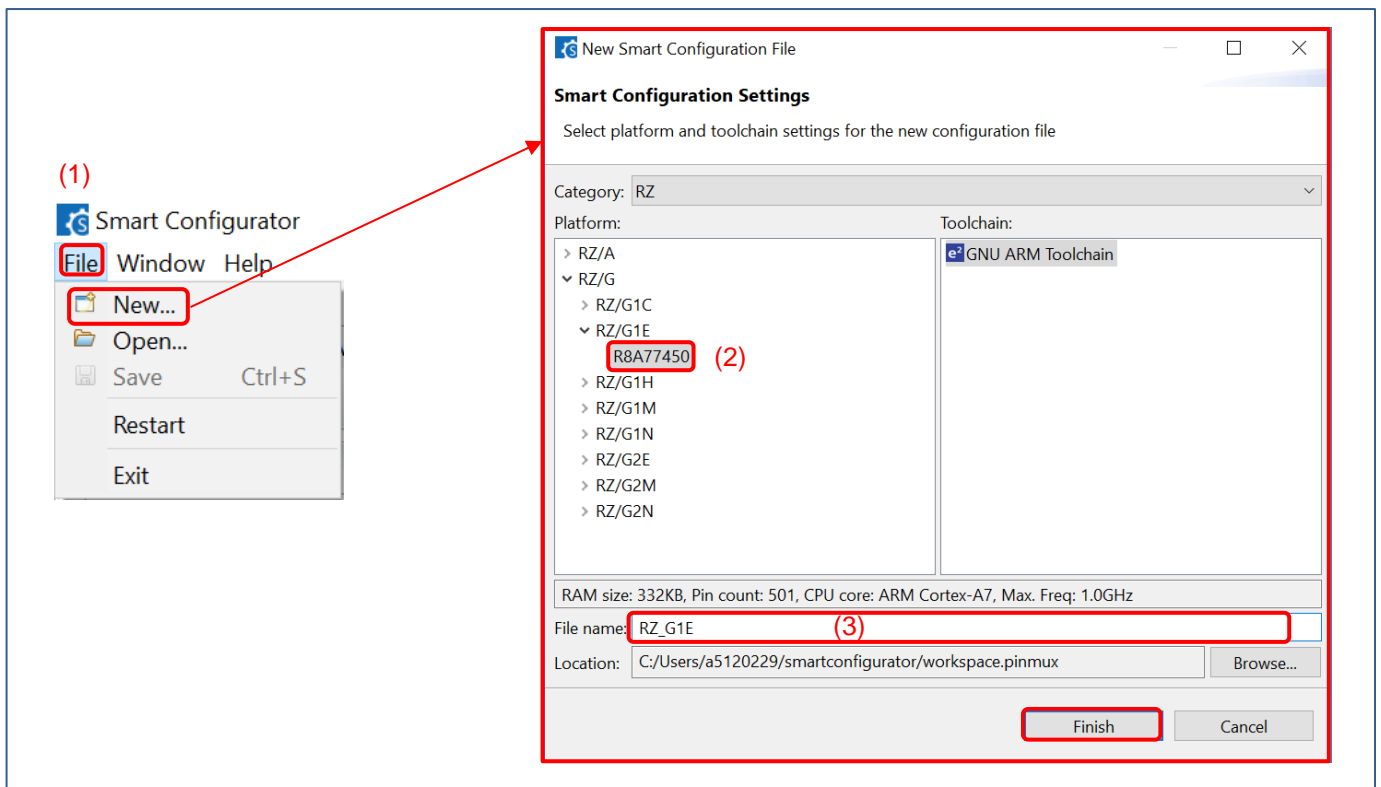

Figure 2-1 Creating a New Smart Configurator File

3. Operating the Smart Configurator

3.1 Procedure for Operation

Figure 3-1 shows the procedure for using the Smart Configurator to set up pin settings, generating source code and report.

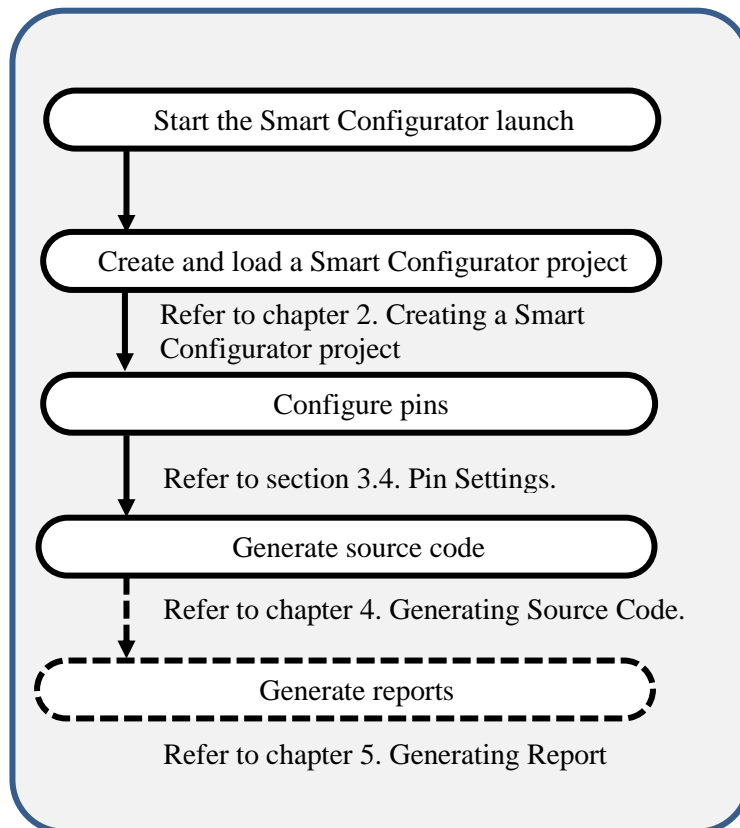

Figure 3-1 Procedure for Operations

3.2 File to be saved as Project Information

The Smart Configurator saves the setting information such as the target MCU for the project, build tool, peripheral modules, and pin functions in a project file (*.sfcg), and refers to this information. The project file from the Smart Configurator is saved in this following format “<project name>.sfcg”.

3.3 Window

The configuration of the Smart Configurator perspective is shown in Figure 3-2 Smart Configurator Perspective.

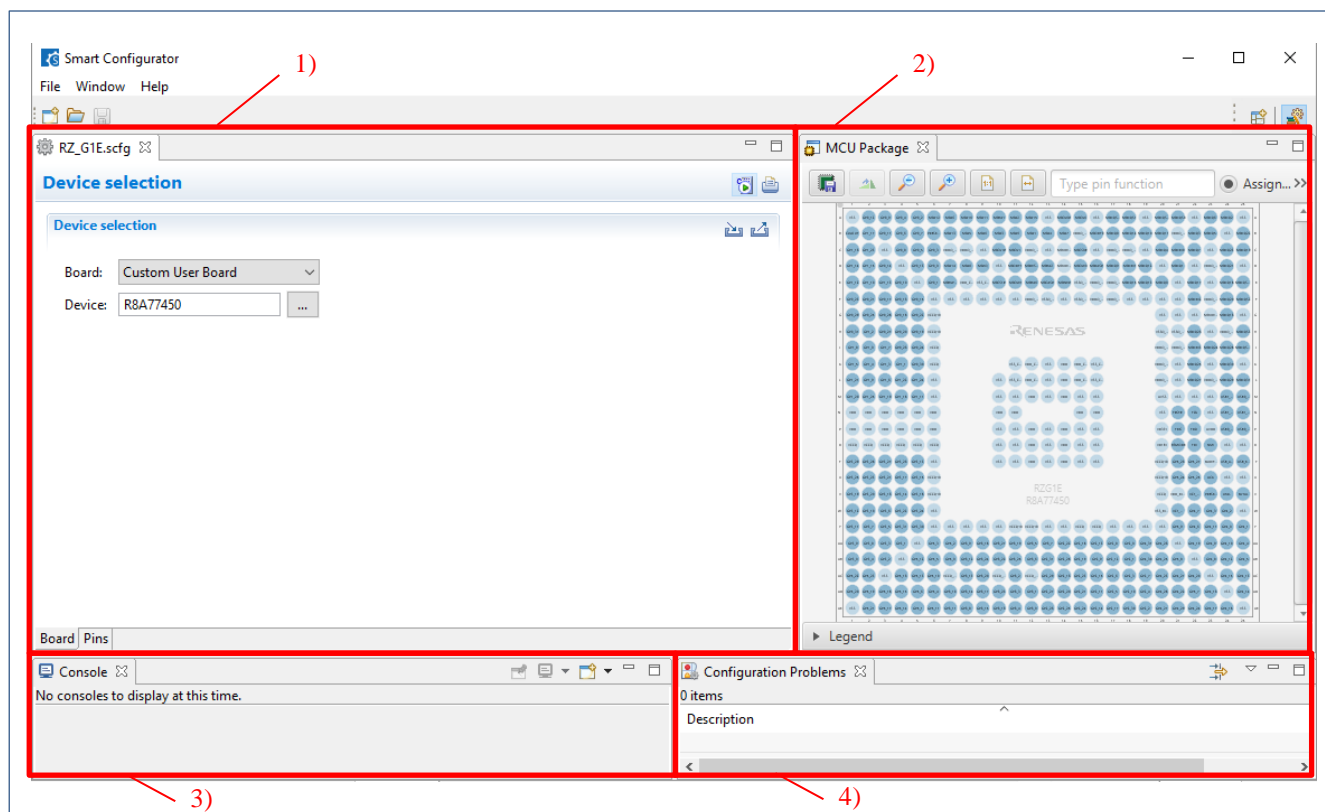

Figure 3-2 Smart Configurator Perspective

- 1) Smart Configurator editor with Board & Pins page
- 2) MCU Package view
- 3) Console view
- 4) Configuration Problems view

3.3.1 MCU Package view

The states of pins are displayed on the figure of the MCU package. The settings of pins can be modified from here.

Two types of package view can be switched between [Assigned] and [Default Board]. [Assigned] displays the assignment status of the pin setting, and [Default Board] displays the initial pin setting information of the board. The initial pin setting information of the board is the pin information of the board selected by [Board:] on the [Board] page (refer to "3.3.4 MCU Package View").

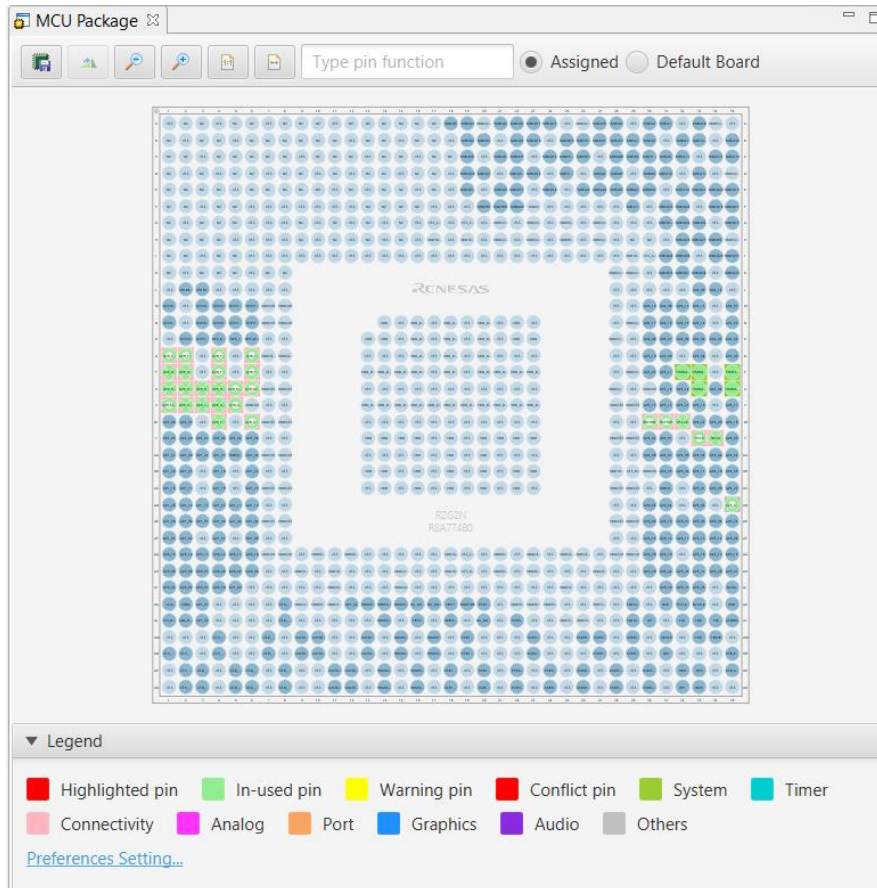

Figure 3-3 MCU Package View

Select [Window] → [Show View] → [Smart Configurator] → [MCU Package] to open the MCU Package View.

3.3.2 Console view

The Console view displays details of changes to the configuration made in the Smart Configurator or MCU Package view.

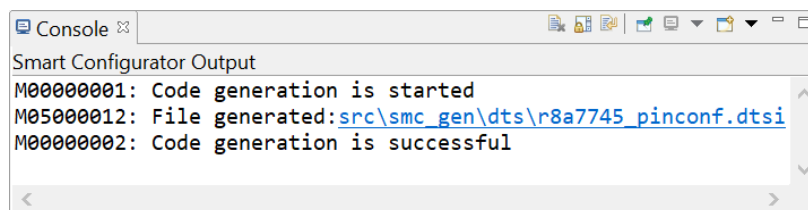

Figure 3-4 Console View

Select [Window] → [Show View] → [General] folder dropdown menu and → [Console] from the [Show View] dialog box in the Smart Configurator to open the Console View.

3.3.3 Configuration Problems view

The Configuration Problems view displays the details if there is any problem related to pin assignment.

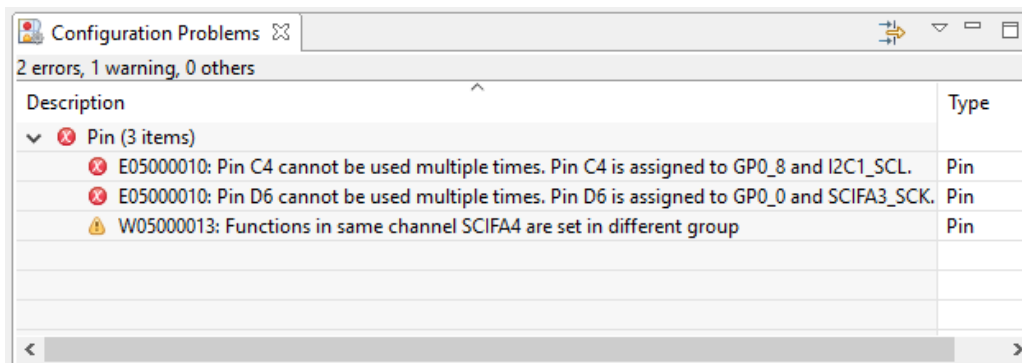

Figure 3-5 Configuration Problems View

Select [Window] → [Show View] → [Smart Configurator] folder dropdown menu and → [Configuration Problems] from the [Show View] dialog box in the Smart Configurator to open the Configuration Problems view.

3.4 Pin Settings

The [Pins] page is used for assigning pin functions. Click on the [Pin Function] and [Pin Number] tabs to switch between the 2 pages. The [Pin Function] list shows the pin functions for each of the peripheral functions, and the [Pin Number] list shows all pins in order of pin number.

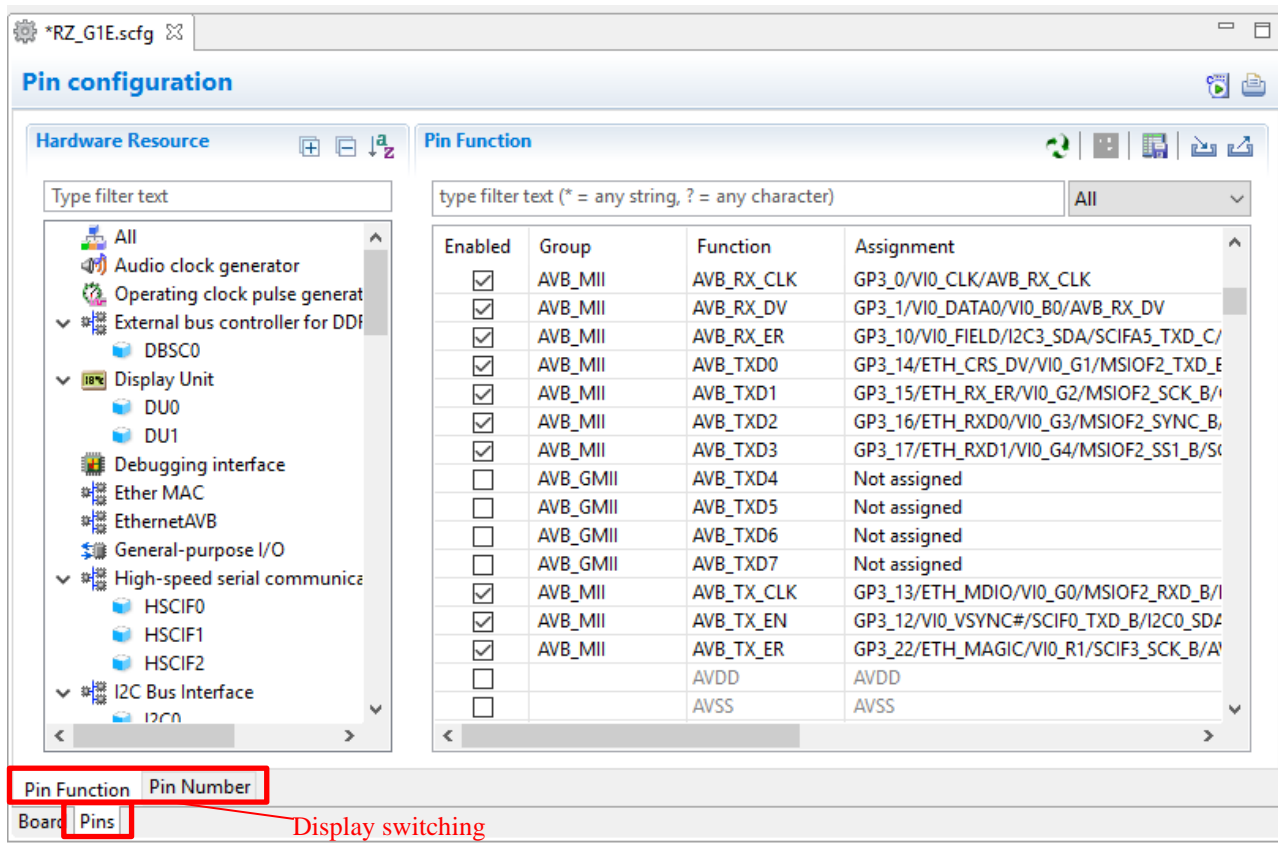

Figure 3-6 [Pins] Page ([Pin Function])

type filter text (* = any string, ? = any character) All

Pin Num...	Pin Name	Function	Direction	Remarks	Comments
A1	VSS	VSS	-	Read only	
A2	GP0_12/D12/HSCIF2_HRTS#/SCIF1_TXD_C/...	Not assigned	None		
A3	GP0_9/D9/HSCIF2_HTX/I2C1_SDA_B	Not assigned	None		
A4	GP0_4/D4/I2C3_SDA_B/SCIF5_TXD_B	Not assigned	None		
A5	GP0_2/D2/SCIFA3_TXD_B	Not assign	None		
A6	M0A12	Not assigned	None		
A7	M0A6	GP0_2	None		
A8	M0A10	D2	None		
A9	M0A11	SCIFA3_TXD_B	None		
A10	M0BA1	Not assigned	None		
A11	M0A2	Not assigned	None		
A12	M0A15	Not assigned	None		
A13	VSS	VSS	-	Read only	
A14	M0CK0#	Not assigned	None		
A15	M0CK0	Not assigned	None		
A16	VSS	VSS	-	Read only	
A17	M0DQS1#	Not assigned	None		
A18	M0DQS1	Not assigned	None		
A19	VSS	VSS	-	Read only	
A20	M0DQS0#	Not assigned	None		
A21	M0DQS0	Not assigned	None		
A22	VSS	VSS	-	Read only	
A23	M0DQ6	Not assigned	None		
A24	M0DQ2	Not assigned	None		

Pin Function Pin Number

Board Pins

Figure 3-7 [Pins] Page ([Pin Number])

When you select a board on the [Board] page, the initial pin setting information of the board is displayed in [Default Function].

3.4.1 Assigning pins using the MCU Package view

The Smart Configurator visualizes the pin assignment in the MCU Package view. You can save the MCU Package view as an image file, rotate it, and zoom in to and out from it.

Follow the procedure below to assign pins in the MCU Package view.

- (1) Zoom in to the view by clicking the  (Zoom in) button or scrolling the view with the mouse wheel.
- (2) Right-click on the target pin.
- (3) Select the signal to be assigned to the pin.
- (4) The color of the pins can be customized through [Preferences Setting...].

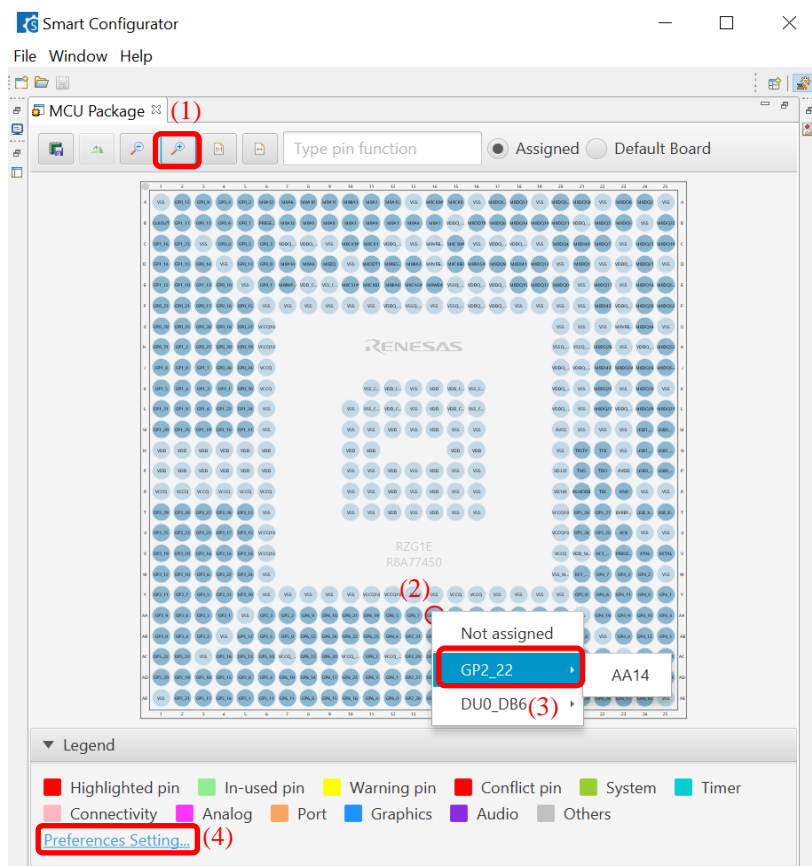



Figure 3-8 Assigning Pins Using the MCU Package View

3.4.2 Exporting pin settings

The pin settings can be exported for later reference. Follow the procedure below to export the pin settings.

- (1) Click on the  (Export pin assignments) button on the [Pins] page.
- (2) Select the output location and specify a name for the file to be exported.

The exported XML file can be imported to another project having the same device part number.

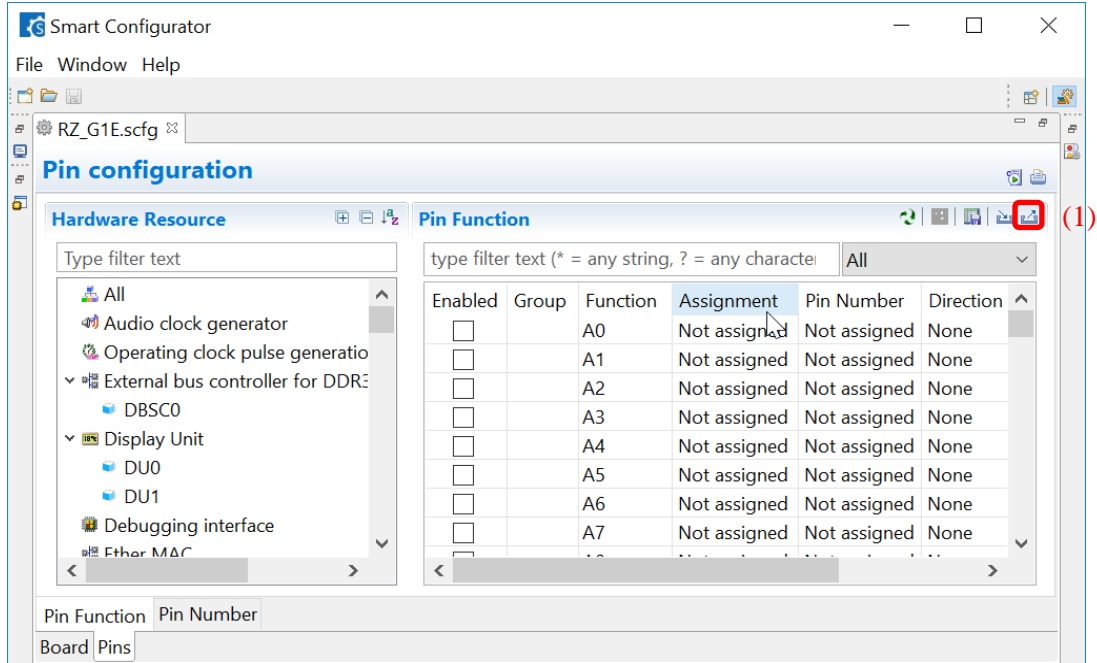



Figure 3-9 Exporting Pin Settings to an XML File

The Smart Configurator can also export the pin settings to a CSV file. Click on the  (Save the list to .csv file) button on the [Pins] page.

3.4.3 Importing pin settings

To import pin settings into the current project, click on the  (Import pin assignments) button and select the XML file that contains the desired pin settings. After the settings specified in this file are imported to the project, the settings will be reflected in the [Pin configuration] page.

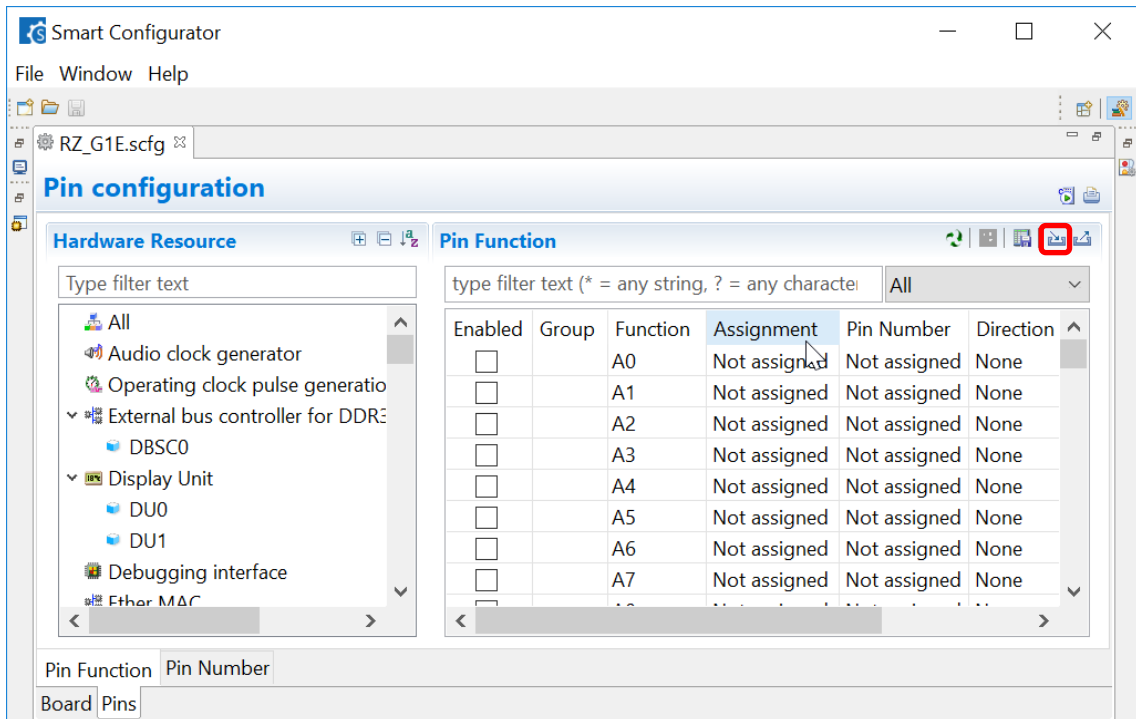

Figure 3-10 Importing Pin Settings from an XML File

3.4.4 Pin filter feature

The filter range on the [Pin Function] tab and [Pin Number] tab on the [Pins] page can be used to filter out pin functions and numbers for easy search.

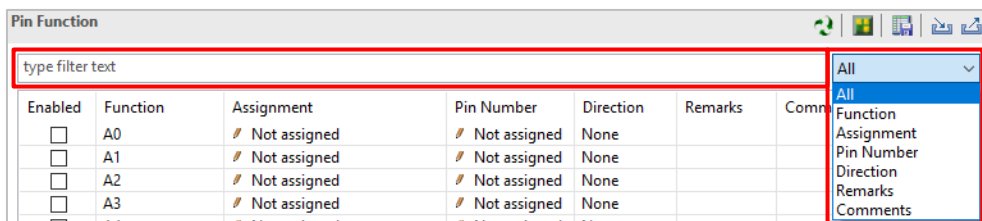

Figure 3-11 Filter for [Pin Function] tab

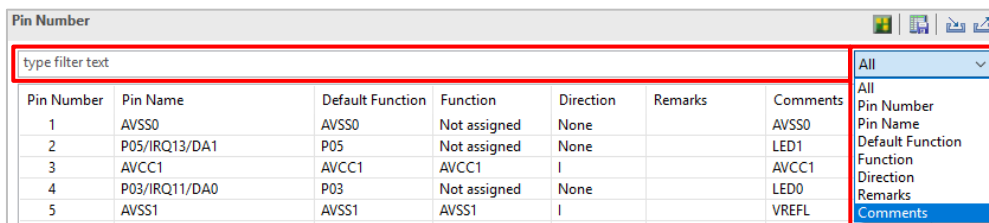

Figure 3-12 Filter for [Pin Number] tab

3.5 MCU migration feature

The MCU migration feature helps to convert user project settings from device A to device B. Conversion of project settings can be done within the same family as follows.

Note: Project settings may change due to device change. It is recommended to back up the smart configurator project file (*.sfcg) before executing the device change.

- (1) Open the [Device Selection] page by clicking on the [Board] tab view.

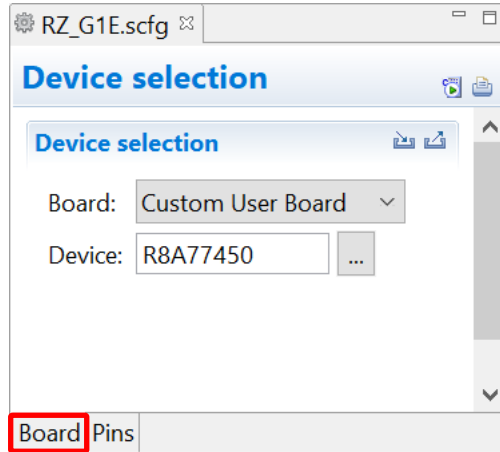



Figure 3-13 [Device Selection]

- (2) Click on this icon  and select the target device from the device dropdown menu list.

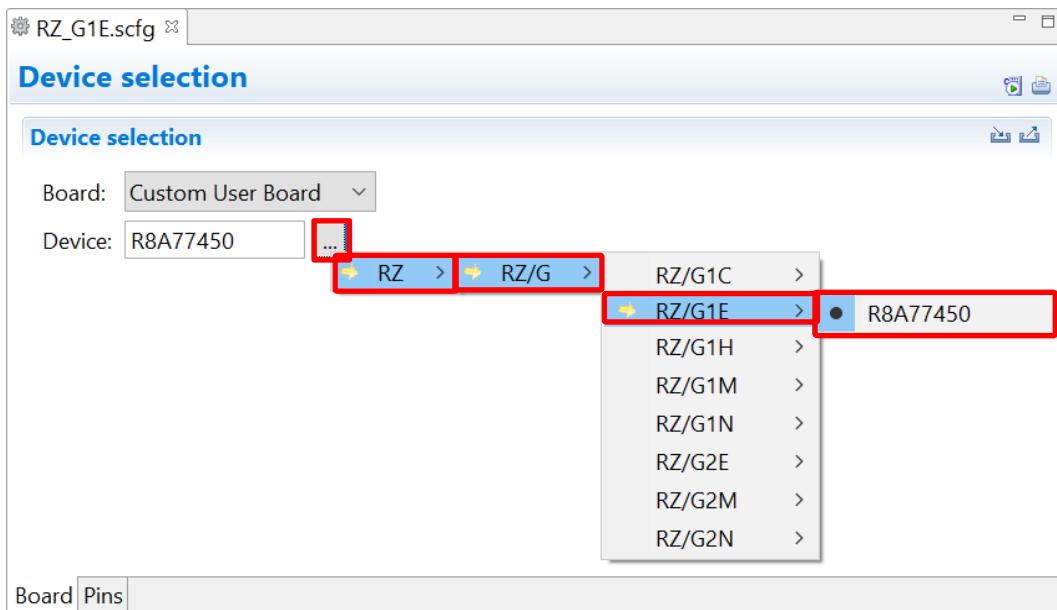

Figure 3-14 Select target device

- (3) Select Save and continue Or Continue to change to another target device. (E.g. change to RZ/G1H).

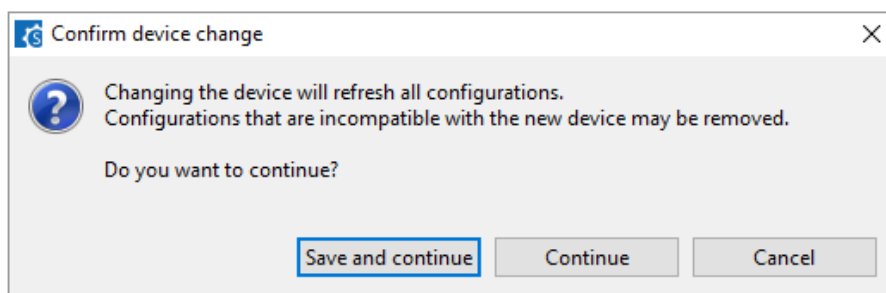

Figure 3-15 Confirm device change

- (4) Migration report will be generated, the report information is displayed in console window.

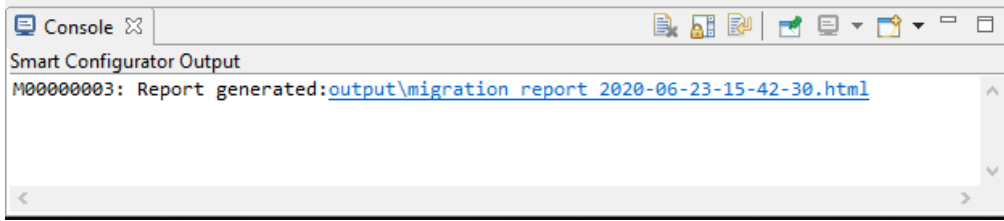

Figure 3-16 Output Migration report

- (5) The migration report can be opened by clicking the hyperlink string in the console window. The reports content will show the pin configuration porting status.

SmartConfigurator MCU migration report

From device: R8A77450.
To device: R8A77420.

1 Pins

The following is a summary table with all pin assignments and their conversion status.

Table 1-1 Pin Migration Status

Function	Pin Number (Before)	Pin Number (After)	Status
AUDIO_CLKOUT	W1 (B)	AK5 (B)	Success
ETH_MAGIC	W4	AF10	Success
DUI_DR7	W22	-	Discarded. Function is not available
DUI_DR3	W23	-	Discarded. Function is not available
DUI_DR2	W24	-	Discarded. Function is not available

Figure 3-17 Migration report content

4. Generating Source Code

4.1 Generating a Source File

Output the source file for the configured details by clicking on the [ (Generate Code)] button in the Smart Configurator view.

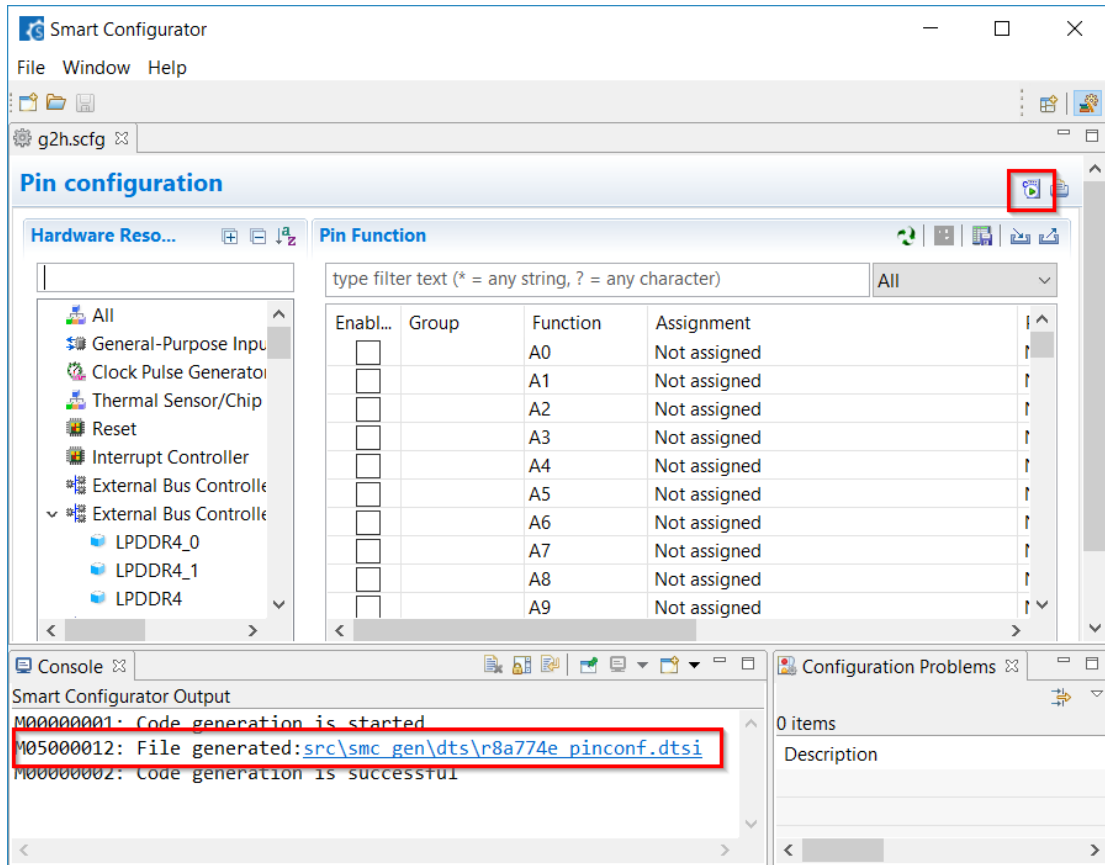

Figure 4-1 Generating a Source File

If a file of the same name exists in the output folder, the existing source code is moved to the folder “/trash/<yyyy-mm-dd-hh-mm-ss>/src/smc_gen/dts/”.

The generated file can be opened directly by clicking on the link of the file from the Console view.

4.2 Folder Structure and output files

Figure 4-2 shows the folders and file output by Smart Configurator. The root folder can be found in “C:\Users\\smartconfigurator\workspace.pinmux\”.

For the RZ/G2x device series, a single *.dtsi file is generated in the device tree syntax for Linux.

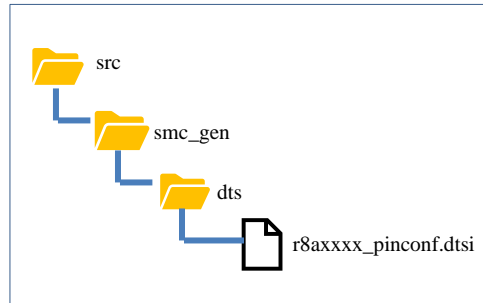

Figure 4-2 Configuration of Generated Files and File Names

Folder	File	Description
src/smc_gen/dts		This folder is always generated. It consists of only r8axxxx_pinconf.dtsi file.
	r8axxxx_pinconf.dtsi	This file is always generated. It represents a set of text files in the Linux kernel source tree that describe the hardware of the RZ/G2 device tree.

The generated source code feature is valid only for the RZ/G2x and RZ/G1x device series. For RZ/A1x device, no *.dtsi file is generated.

5. Generating Report on Smart Configurator

The Smart Configurator generates a report on the configurations that the user works on. Follow the procedure below to generate a report.

5.1 Report on Device Configurations

A report is output by clicking on the  (Generate Report)] button in the Smart Configurator view.

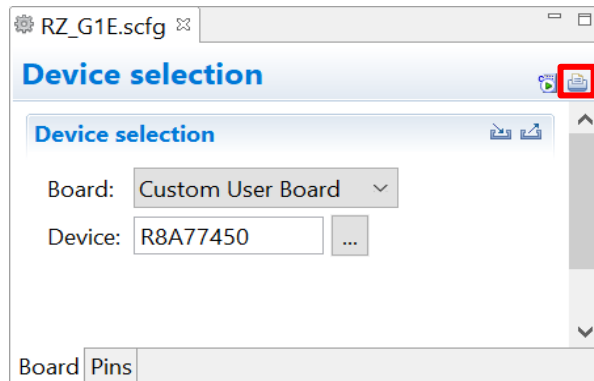

Figure 5-1 Output of a Report on the Configuration (as a Text File)

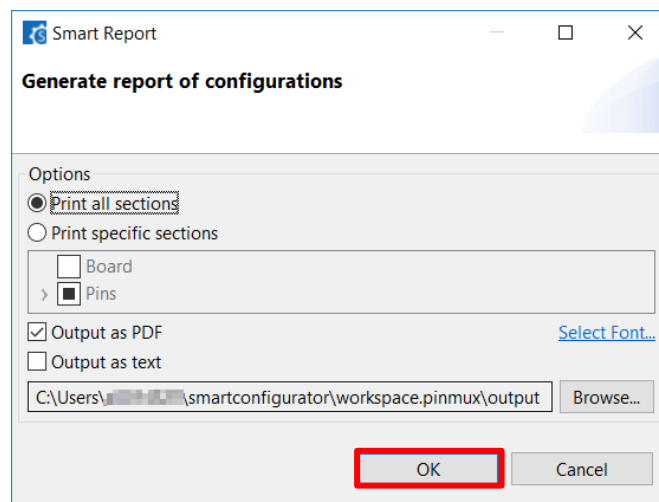

Figure 5-2 Dialog Box for Output of a Report

5.2 Configuration of Pin Function List and Pin Number List (in csv Format)

A list of the configuration of pin functions and pin numbers is output by clicking on the [📄] (Save the list to .csv file) button on the [Pins] page of the Smart Configurator view.

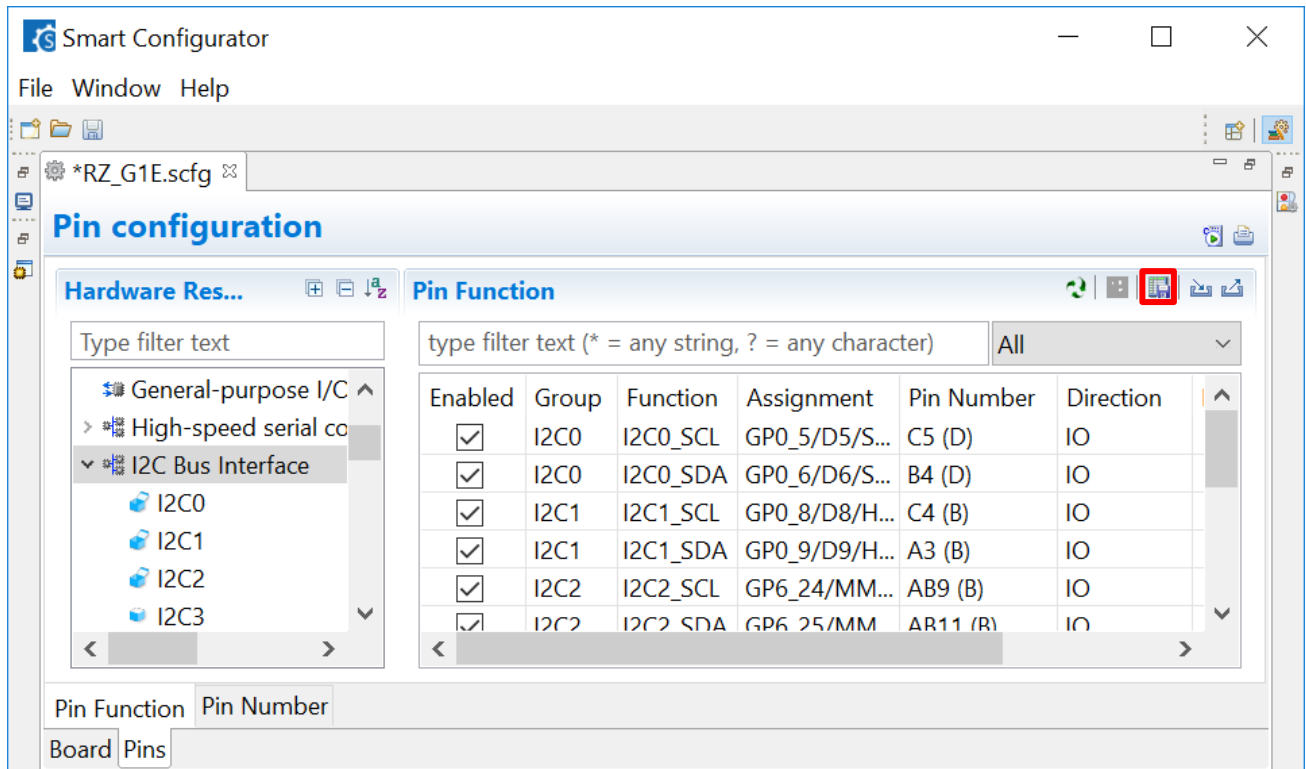

Figure 5-3 Output of a List of Pin Functions or Numbers (in csv Format)

5.3 Image of MCU Package (in png format)

An image of the MCU package is output by clicking on the [🖨️] (Save Package View to external image file) button of the [MCU Package] view.

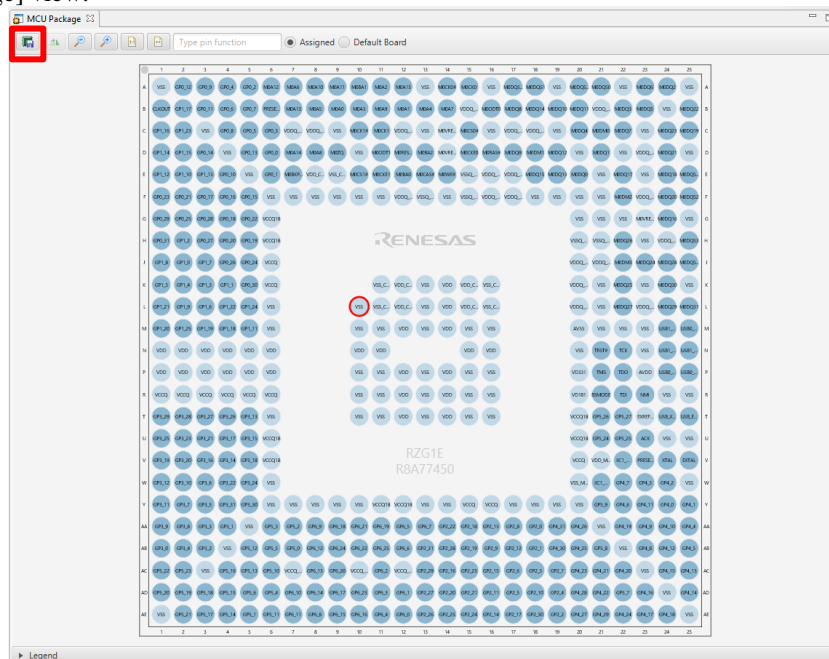

Figure 5-4 Output an image of the MCU Package (in png Format)

6. Help

Refer to the help dropdown menu for detailed information on the Smart Configurator.

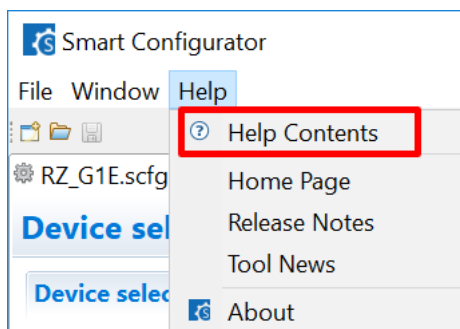

Figure 6-1 Help Menu

7. Documents for Reference

User's Manual: Hardware

Obtain the latest version of the manual from the Renesas Electronics website.

Technical Update/Technical News

Obtain the latest information from the Renesas Electronics website.

Website and Support

Renesas Electronics Website

<http://www.renesas.com/>

Inquiries

<http://www.renesas.com/contact/>

All trademarks and registered trademarks are the property of their respective owners.

1. Handling of Unused Pins

Handle unused pins in accordance with the directions given under Handling of Unused Pins in the manual.

- The input pins of CMOS products are generally in the high-impedance state. In operation with an unused pin in the open-circuit state, extra electromagnetic noise is induced in the vicinity of LSI, an associated shoot-through current flows internally, and malfunctions occur due to the false recognition of the pin state as an input signal become possible. Unused pins should be handled as described under Handling of Unused Pins in the manual.

2. Processing at Power-on

The state of the product is undefined at the moment when power is supplied.

- The states of internal circuits in the LSI are indeterminate and the states of register settings and pins are undefined at the moment when power is supplied.

In a finished product where the reset signal is applied to the external reset pin, the states of pins are not guaranteed from the moment when power is supplied until the reset process is completed.

In a similar way, the states of pins in a product that is reset by an on-chip power-on reset function are not guaranteed from the moment when power is supplied until the power reaches the level at which resetting has been specified.

3. Prohibition of Access to Reserved Addresses

Access to reserved addresses is prohibited.

- The reserved addresses are provided for the possible future expansion of functions. Do not access these addresses; the correct operation of LSI is not guaranteed if they are accessed.

4. Clock Signals

After applying a reset, only release the reset line after the operating clock signal has become stable. When switching the clock signal during program execution, wait until the target clock signal has stabilized.

- When the clock signal is generated with an external resonator (or from an external oscillator) during a reset, ensure that the reset line is only released after full stabilization of the clock signal. Moreover, when switching to a clock signal produced with an external resonator (or by an external oscillator) while program execution is in progress, wait until the target clock signal is stable.

5. Differences between Products

Before changing from one product to another, i.e. to a product with a different part number, confirm that the change will not lead to problems.

- The characteristics of Microprocessing unit or Microcontroller unit products in the same group but having a different part number may differ in terms of the internal memory capacity, layout pattern, and other factors, which can affect the ranges of electrical characteristics, such as characteristic values, operating margins, immunity to noise, and amount of radiated noise. When changing to a product with a different part number, implement a system-evaluation test for the given product.

Notice

1. Descriptions of circuits, software and other related information in this document are provided only to illustrate the operation of semiconductor products and application examples. You are fully responsible for the incorporation of these circuits, software, and information in the design of your equipment. Renesas Electronics assumes no responsibility for any losses incurred by you or third parties arising from the use of these circuits, software, or information.
 2. Renesas Electronics has used reasonable care in preparing the information included in this document, but Renesas Electronics does not warrant that such information is error free. Renesas Electronics assumes no liability whatsoever for any damages incurred by you resulting from errors in or omissions from the information included herein.
 3. Renesas Electronics does not assume any liability for infringement of patents, copyrights, or other intellectual property rights of third parties by or arising from the use of Renesas Electronics products or technical information described in this document. No license, express, implied or otherwise, is granted hereby under any patents, copyrights or other intellectual property rights of Renesas Electronics or others.
 4. You should not alter, modify, copy, or otherwise misappropriate any Renesas Electronics product, whether in whole or in part. Renesas Electronics assumes no responsibility for any losses incurred by you or third parties arising from such alteration, modification, copy or otherwise misappropriation of Renesas Electronics product.
 5. Renesas Electronics products are classified according to the following two quality grades: "Standard" and "High Quality". The recommended applications for each Renesas Electronics product depends on the product's quality grade, as indicated below.
"Standard": Computers; office equipment; communications equipment; test and measurement equipment; audio and visual equipment; home electronic appliances; machine tools; personal electronic equipment; and industrial robots etc.
"High Quality": Transportation equipment (automobiles, trains, ships, etc.); traffic control systems; anti-disaster systems; anti-crime systems; and safety equipment etc.
Renesas Electronics products are neither intended nor authorized for use in products or systems that may pose a direct threat to human life or bodily injury (artificial life support devices or systems, surgical implantations etc.), or may cause serious property damages (nuclear reactor control systems, military equipment etc.). You must check the quality grade of each Renesas Electronics product before using it in a particular application. You may not use any Renesas Electronics product for any application for which it is not intended. Renesas Electronics shall not be in any way liable for any damages or losses incurred by you or third parties arising from the use of any Renesas Electronics product for which the product is not intended by Renesas Electronics.
 6. You should use the Renesas Electronics products described in this document within the range specified by Renesas Electronics, especially with respect to the maximum rating, operating supply voltage range, movement power voltage range, heat radiation characteristics, installation and other product characteristics. Renesas Electronics shall have no liability for malfunctions or damages arising out of the use of Renesas Electronics products beyond such specified ranges.
 7. Although Renesas Electronics endeavors to improve the quality and reliability of its products, semiconductor products have specific characteristics such as the occurrence of failure at a certain rate and malfunctions under certain use conditions. Further, Renesas Electronics products are not subject to radiation resistance design. Please be sure to implement safety measures to guard them against the possibility of physical injury, and injury or damage caused by fire in the event of a failure of a Renesas Electronics product, such as safety design for hardware and software including but not limited to redundancy, fire control and malfunction prevention, appropriate treatment for aging degradation or any other appropriate measures. Because the evaluation of microcomputer software alone is very difficult, please evaluate the safety of the final products or systems manufactured by you.
 8. Please contact a Renesas Electronics sales office for details as to environmental matters such as the environmental compatibility of each Renesas Electronics product. Please use Renesas Electronics products in compliance with all applicable laws and regulations that regulate the inclusion or use of controlled substances, including without limitation, the EU RoHS Directive. Renesas Electronics assumes no liability for damages or losses occurring as a result of your noncompliance with applicable laws and regulations.
 9. Renesas Electronics products and technology may not be used for or incorporated into any products or systems whose manufacture, use, or sale is prohibited under any applicable domestic or foreign laws or regulations. You should not use Renesas Electronics products or technology described in this document for any purpose relating to military applications or use by the military, including but not limited to the development of weapons of mass destruction. When exporting the Renesas Electronics products or technology described in this document, you should comply with the applicable export control laws and regulations and follow the procedures required by such laws and regulations.
 10. It is the responsibility of the buyer or distributor of Renesas Electronics products, who distributes, disposes of, or otherwise places the product with a third party, to notify such third party in advance of the contents and conditions set forth in this document, Renesas Electronics assumes no responsibility for any losses incurred by you or third parties as a result of unauthorized use of Renesas Electronics products.
 11. This document may not be reproduced or duplicated in any form, in whole or in part, without prior written consent of Renesas Electronics.
 12. Please contact a Renesas Electronics sales office if you have any questions regarding the information contained in this document or Renesas Electronics products, or if you have any other inquiries.
- (Note 1) "Renesas Electronics" as used in this document means Renesas Electronics Corporation and also includes its majority-owned subsidiaries.
(Note 2) "Renesas Electronics product(s)" means any product developed or manufactured by or for Renesas Electronics.



SALES OFFICES

Renesas Electronics Corporation

<http://www.renesas.com>

Refer to "<http://www.renesas.com/>" for the latest and detailed information.

Renesas Electronics Corporation

TOYOSU FORESIA, 3-2-24 Toyosu, Koto-ku, Tokyo 135-0061, Japan

Renesas Electronics America Inc. Milpitas Campus

1001 Murphy Ranch Road, Milpitas, CA 95035, U.S.A.
Tel: +1-408-432-8888, Fax: +1-408-434-5351

Renesas Electronics America Inc. San Jose Campus

6024 Silver Creek Valley Road, San Jose, CA 95138, USA
Tel: +1-408-284-8200, Fax: +1-408-284-2775

Renesas Electronics Canada Limited

9251 Yonge Street, Suite 8309 Richmond Hill, Ontario Canada L4C 9T3
Tel: +1-905-237-2004

Renesas Electronics Europe GmbH

Arcadiastrasse 10, 40472 Düsseldorf, Germany
Tel: +49-211-6503-0, Fax: +49-211-6503-1327

Renesas Electronics (China) Co., Ltd.

Room 101-T01, Floor 1, Building 7, Yard No. 7, 8th Street, Shangdi, Haidian District, Beijing 100085, China
Tel: +86-10-8235-1155, Fax: +86-10-8235-7679

Renesas Electronics (Shanghai) Co., Ltd.

Unit 301, Tower A, Central Towers, 555 Langao Road, Putuo District, Shanghai 200333, China
Tel: +86-21-2226-0888, Fax: +86-21-2226-0999

Renesas Electronics Hong Kong Limited

Unit 1601-1611, 16/F., Tower 2, Grand Century Place, 193 Prince Edward Road West, Mongkok, Kowloon, Hong Kong
Tel: +852-2265-6688, Fax: +852-2886-9022

Renesas Electronics Taiwan Co., Ltd.

13F, No. 363, Fu Shing North Road, Taipei 10543, Taiwan
Tel: +886-2-8175-9600, Fax: +886-2-8175-9670

Renesas Electronics Singapore Pte. Ltd.

80 Bendemeer Road, #06-02 Singapore 339949
Tel: +65-6213-0200, Fax: +65-6213-0300

Renesas Electronics Malaysia Sdn.Bhd.

Unit No 3A-1 Level 3A Tower 8 UOA Business Park, No 1 Jalan Pengaturcara U1/51A, Seksyen U1, 40150 Shah Alam, Selangor, Malaysia
Tel: +60-3-5022-1288, Fax: +60-3-5022-1290

Renesas Electronics India Pvt. Ltd.

No.777C, 100 Feet Road, HAL 2nd Stage, Indiranagar, Bangalore 560 038, India
Tel: +91-80-67208700

Renesas Electronics Korea Co., Ltd.

17F, KAMCO Yangjae Tower, 262, Gangnam-daero, Gangnam-gu, Seoul, 06265 Korea
Tel: +82-2-558-3737, Fax: +82-2-558-5338