

# RZ/V2L AI APPLICATIONS DEMO HOW TO USE GUIDE VERSION 1.00

2023/06/30  
RENESAS ELECTRONICS CORPORATION

R11AN0762EJ0100

# CONTENTS

---

- [RZ/V2L AI Applications Demo](#)
- [RZ/V2L AI Applications Demo Contents List](#)
- [Demo File Structure](#)
- [Necessary Equipment and Board Connections](#)
- [SD Card Preparation](#)
- [Install the serial port driver and Tera term](#)
- [Linux Boot Up Preparation](#)
- [Linux Boot Up](#)
- [Demo Execution Method](#)
- [References](#)

# RZ/V2L AI Applications Demo

- AI application: Refer to slide [[AI Applications Demo Contents List](#)].
- This application displays the capture data with AI inference result on HDMI monitor.

On HDMI Monitor

Input: Google Coral Camera/USB Camera  
VGA(640x480) YUYV @30FPS

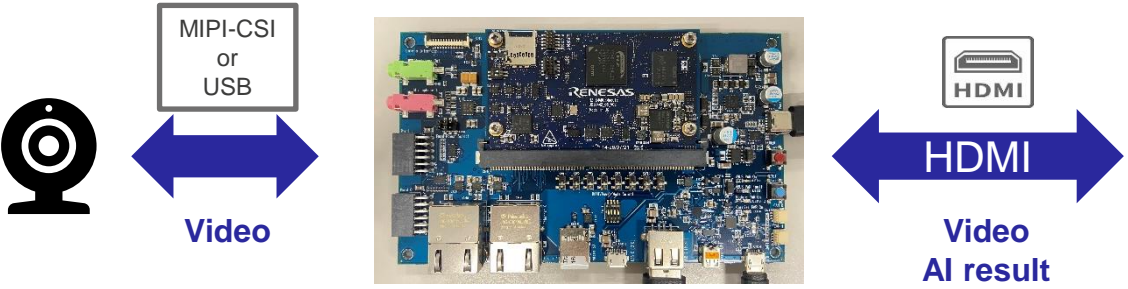

RZ/V2L Evaluation Board Kit

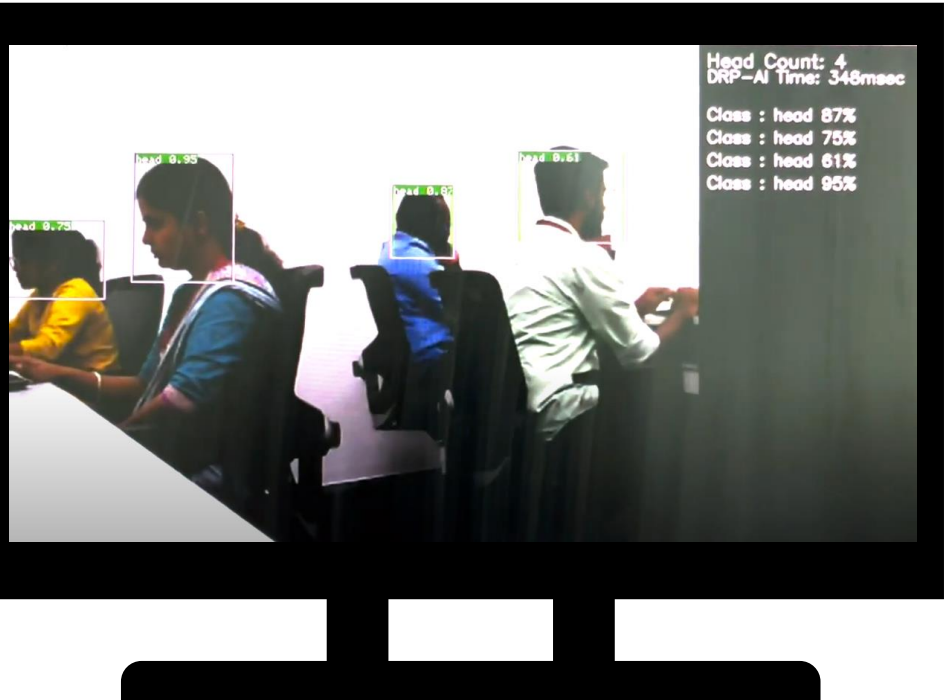

# RZ/V2L AI Applications Demo Contents List

AI Applications details can be found on [Web](#).

To see the source code and more details of each demo, please click the GitHub link in "Source Code and Details" column.

Category	Name	Source Code and Details	Supported Input ([Default])
Agriculture	Defense wild animals for crop	<a href="#">Link</a>	[MIPI Camera]/USB Camera
Smart Building	Elevator passengers Counting	<a href="#">Link</a>	[MIPI Camera]/USB Camera
	Conference Room Usage Monitor	<a href="#">Link</a>	[MIPI Camera]/USB Camera
	Lighting Control	<a href="#">Link</a>	[MIPI Camera]/USB Camera
	Security Area Intrusion Detection	<a href="#">Link</a>	[MIPI Camera]/USB Camera
	Wear management at construction sites	<a href="#">Link</a>	[MIPI Camera]/USB Camera
Smart City	Congestion Detection in Railway Station	<a href="#">Link</a>	[MIPI Camera]/USB Camera
	Prohibited Area Management	<a href="#">Link</a>	[MIPI Camera]/USB Camera
	Distracted driving detection	<a href="#">Link</a>	[MIPI Camera]/USB Camera
	Parking Spot Reservation	<a href="#">Link</a>	[USB Camera]
	Passport check support	<a href="#">Link</a>	[USB Camera]
Healthcare	Physical Condition Monitor	<a href="#">Link</a>	[MIPI Camera]/USB Camera
Smart Home	Air Conditioner Control	<a href="#">Link</a>	[MIPI Camera]/USB Camera
	Pet Detection in Kitchen and Child's Room	<a href="#">Link</a>	[MIPI Camera]/USB Camera
Industrial	Work Area Personnel Management	<a href="#">Link</a>	[MIPI Camera]/USB Camera
	Helmet and safety vest wearing monitor	<a href="#">Link</a>	[MIPI Camera]/USB Camera
Retail	Congestion Detection	<a href="#">Link</a>	[MIPI Camera]/USB Camera
	Staying and flow line monitoring	<a href="#">Link</a>	[USB Camera]

# Demo File Structure

## RTK0EF0166F01000SJ.zip

Folder Name	Folder Content	Description
boot_loader/	bl2_bp-smarc-rzv2l_pmic.srec fip-smarc-rzv2l_pmic.srec Flash_Writer_SCIF_RZV2L_SMARC_PMIC_DDR4_2GB_1PCS.mot	Folder containing boot loader files set.
licenses/	linux_licenses.zip	Linux license information.
	r11an0752ej0100-rzv2l-ai-sdk(Linux License List).pdf	List of Linux license information included in Demo SD card image. Copyright information is not included. Please refer to Open Source Software packages(oss_pkg_rzv2l.7z) to see copyright information.
	oss_pkg_rzv_v1.00.7z	Source code of Open Source Software packages used when building the files in Demo SD card image.
sd_image/	ai_applications_demo.zip	Zip file containing the Demo SD card image.
	r11an0762ej0100-rzv2l.pdf	This document.

Software used:

[RZ/V2L AI Software Development Kit Version 1.00](#)  
[RZ/V DRP-AI TVM v1.0.4](#)

Demo source code:

Refer to slide [[AI Applications Demo Contents List](#)]

# Necessary Equipment and Board Connections

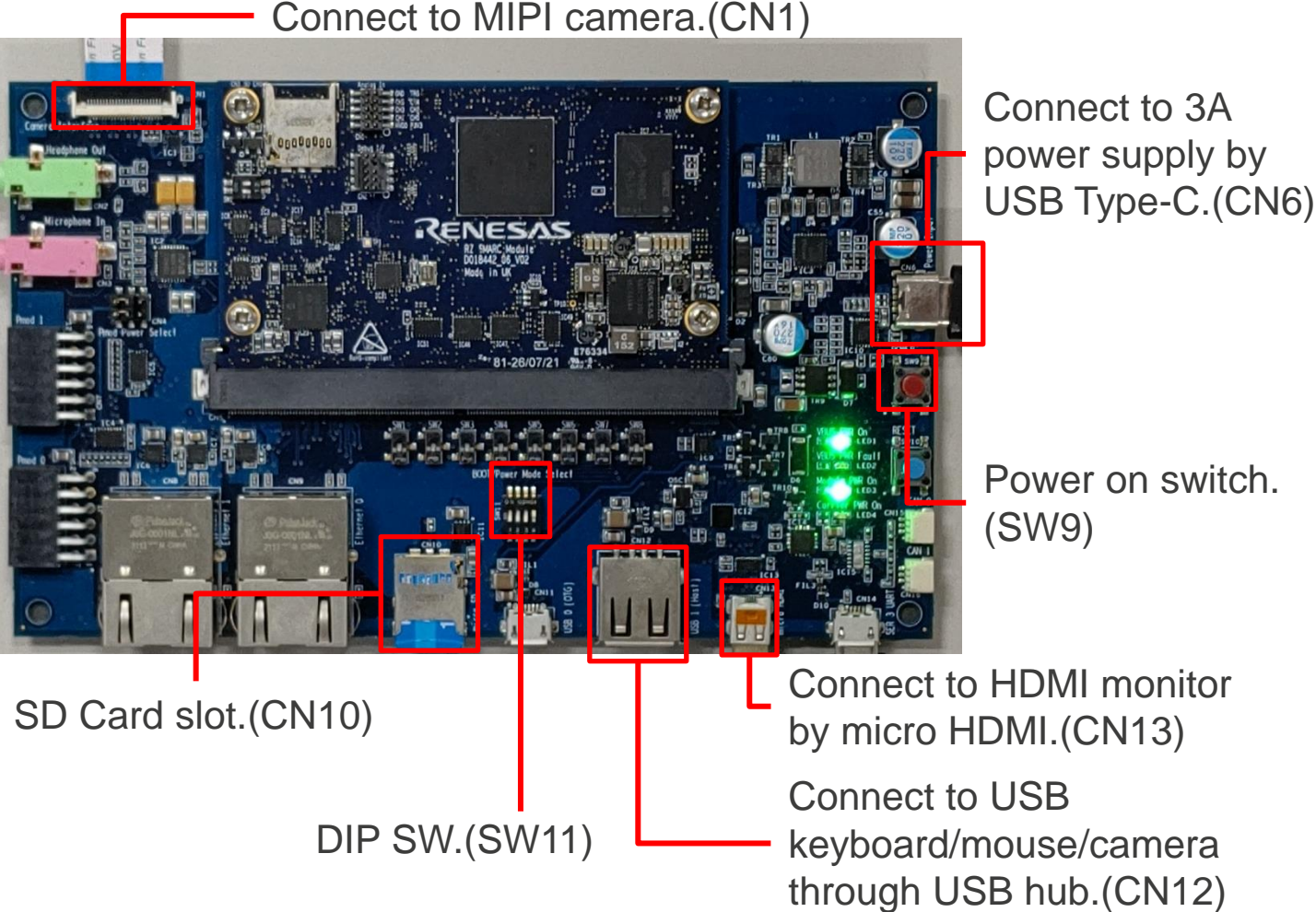

Equipment	Details
RZ/V2L Evaluation Board Kit	Google Coral Camera*1 and MicroUSB to Serial Cable are included.
AC adapter	Power supply to the board.
USB Cable Type-C	Connect AC adapter and the board.
HDMI monitor	Used to display the graphics.
micro HDMI cable	Connect HDMI monitor and the board.
microSD card	Must have over 16GB capacity of blank space.
Linux PC	Used for writing microSD card.
SD card reader	Used for writing microSD card.
Windows PC	Used for the bootloader and u-boot setting.
USB hub	Used to connect USB devices to the board.
USB keyboard	Used for terminal control.
USB mouse	Used for GUI control.
USB camera	<b>Optional.</b> Some applications only support USB camera.

\*1: Note that the CMOS sensor (OV5645) in the camera is no longer available and should not be used for mass production. Any software support provided is for evaluation purposes only.

# SD Card Preparation

(\*) If you want to use windows PC, we have experience with the following Windows applications.  
[Win32 Disk Imager download | SourceForge.net](#)  
[Raspberry Pi OS – Raspberry Pi](#)

Prepare the SD card by running the following commands on your Linux PC(\*). Use the SD card image provided with the demo: (Refer to slide [[Demo File Structure](#)] to check the “sd\_image” folder information).

SD Card must have a least 16GB of memory.

1. Unzip the ai\_applications\_demo.zip file to get the SD card image. (.dd file)
2. Check the SD Card Device Name: run the lsblk command before and after inserting your SD card.

```
$ lsblk
NAME MAJ:MIN RM SIZE RO TYPE MOUNTPOINT
sda 8:0 0 30.9G 0 disk
├─sda1 8:1 0 512M 0 part /boot/efi
├─sda2 8:2 0 1K 0 part
└─sda5 8:5 0 30.3G 0 part /
sr0 11:0 1 1024M 0 rom
```



```
$ lsblk
NAME MAJ:MIN RM SIZE RO TYPE MOUNTPOINT
sda 8:0 0 30.9G 0 disk
├─sda1 8:1 0 512M 0 part /boot/efi
├─sda2 8:2 0 1K 0 part
└─sda5 8:5 0 30.3G 0 part /
sdb 8:16 1 29.7G 0 disk
└─sdb1 8:17 1 29.7G 0 part
sr0 11:0 1 1024M 0 rom
```

3. Using the Device name found above, write the image file into the SD card:

```
$ sudo dd if=<PATH>/ai_applications_demo.dd of=/dev/sdb status=progress
```

Note: Writing the SD card image with the dd command takes time. (Depend on your environment, it takes about 30min.)

# Board Setup

## Install the serial port driver and Tera term

➤ This step uses a Windows PC.

The serial communication between Windows PC and RZ/V2L Evaluation Board Kit requires the following driver.

- <https://ftdichip.com/drivers/vcp-drivers/>

1. Download the software "Virtual COM port (VCP) driver" from the windows version "setup executable" on the download page and extract it.
2. Run the **exe file** extracted to install the serial port driver.

Install the terminal emulator (Tera term) on Windows PC.

- [Tera Term Open Source Project \(osdn.jp\)](#)



# Linux Boot Up Preparation

## Boot Loader 1

➤ This step for boot loader uses a Windows PC.

Please copy following files to your Windows PC.

These files are in the boot\_loader directory that you unpacked on [Prepare the Necessary Files](#).

Note: If you used the previous version, follow this section to update boot loader binary files. (Write only once)

- `Flash_Writer_SCIF_RZV2L_SMARC_PMIC_DDR4_2GB_1PCS.mot`
- `bl2_bp-smarc-rzv2l_pmic.srec`
- `fip-smarc-rzv2l_pmic.srec`

1. Connect PC and Board via USB-Serial.
2. Change SW11 setting (see the right figure) and re-boot the board.

1	2	3	4
OFF	ON	OFF	ON

3. Press the power button(SW9) to turn on the power.  
Note: When turn on the power, press and hold the power button for 1 second.

Flash Write  
(SCIF download mode)

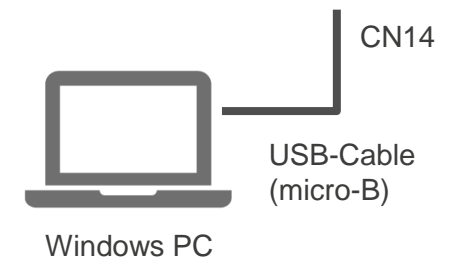
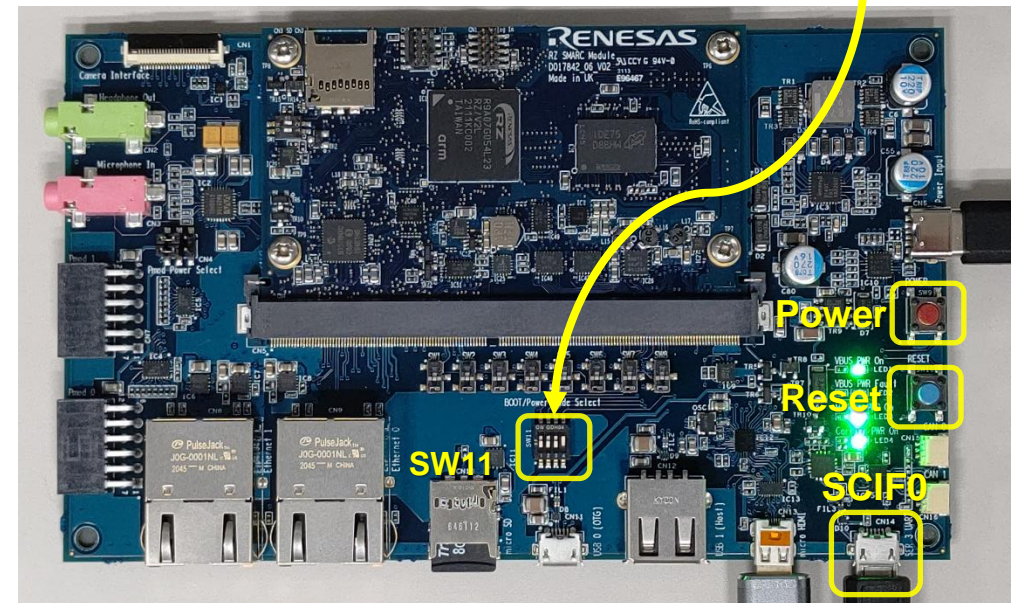
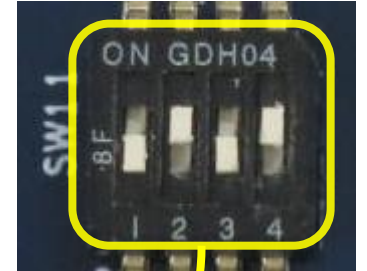

# Linux Boot Up Preparation

## Boot Loader 2

4. Bring up the terminal software and select the “File” > “New Connection” to set the connection on the software.

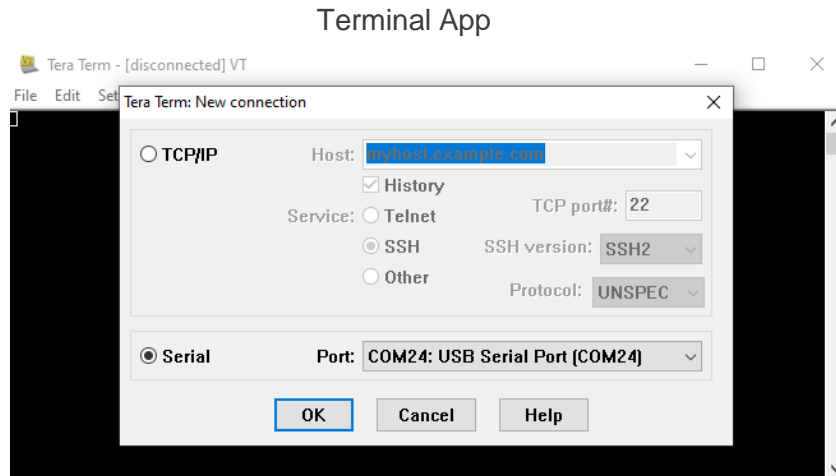

5. Open the configuration windows from the “Setup” and change the setting as follows.

Tera term: Configuration	
<b>Terminal</b>	
New-line	Receive: Auto
	Transmit: CR
<b>Serial port</b>	
Baud rate	: 115200
Data	: 8bit
Parity	: none
Stop	: 1bit
Flow control	: none
Transmit delay	: 0 msec/char

# Linux Boot Up Preparation

## Boot Loader 3

6. When pressed the reset button SW10, the messages below are displayed on the terminal.

```
SCIF Download mode
(C) Renesas Electronics Corp.
-- Load Program to System RAM -----
please send !
```

7. Send a Flash Writer “.mot” as a text (“File”>”Send file...”). Following message will be displayed, when transmitting file succeed.

```
Flash writer for RZ/V2 Series V1.02 Nov.15,2021
Product Code : RZ/V2L
>
```

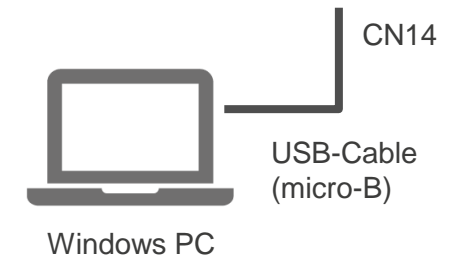
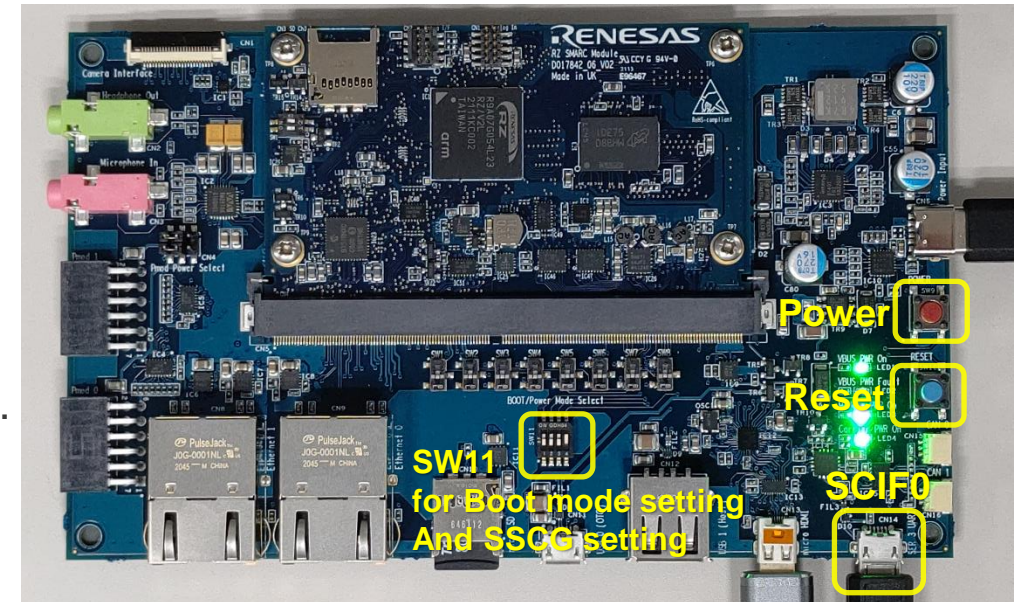

# Linux Boot Up Preparation

## Boot Loader 4

---

8. Input command and address as following steps (yellow character)

```
Flash writer for RZ/V2 Series V1.02 Nov.15,2021
Product Code : RZ/V2L
>XLS2
===== Qspi writing of RZ/G2 Board Command =====
Load Program to Spiflash
Writes to any of SPI address.
Micron : MT25QU512
Program Top Address & Qspi Save Address
===== Please Input Program Top Address =====
Please Input : H'11E00

===== Please Input Qspi Save Address ===
Please Input : H'00000
Work RAM(H'50000000-H'53FFFFFF) Clear....
please send ! ( '.' & CR stop load)
```

9. Send the data of “bl2\_bp-smarc-rzv2l\_pmic.srec” from terminal software after the message “please send !” is shown.

```
SAVE SPI-FLASH.....
===== Qspi Save Information =====
SpiFlashMemory Stat Address : H'00000000
SpiFlashMemory End Address : H'00009A80
=====
```

In case a message to prompt to clear data like above, please enter “y”.

```
SPI Data Clear(H'FF) Check : H'00000000-0000FFFF,Clear OK?(y/n)
```

# Linux Boot Up Preparation

## Boot Loader 5

10. Input command and address as following steps (yellow character)

```
>XLS2
===== Qspi writing of RZ/G2 Board Command =====
Load Program to Spiflash
Writes to any of SPI address.
  Micron : MT25QU512
Program Top Address & Qspi Save Address
===== Please Input Program Top Address =====
  Please Input : H'00000

===== Please Input Qspi Save Address ===
  Please Input : H'1D200
Work RAM(H'50000000-H'53FFFFFF) Clear....
please send ! ( '.' & CR stop load)
```

11. Send the data of “fip-smarc-rzv2l\_pmic.srec” from terminal software after the message “please send !” is shown.

```
SAVE SPI-FLASH.....
===== Qspi Save Information =====
SpiFlashMemory Stat Address : H'0001D200
SpiFlashMemory End Address : H'000CC73F
=====
```

In case a message to prompt to clear data like above, please enter “y”.

```
SPI Data Clear(H'FF) Check : H'00000000-0000FFFF,Clear OK?(y/n)
```

12. After writing two loader files normally, press the power button(SW9) to turn off the power.

# Linux Boot Up Preparation

## Setting U-boot 1

➤ This step for setting U-boot uses a Windows PC.

1. Change SW11 setting (see the right figure) and re-boot the board

1	2	3	4
OFF	OFF	OFF	ON

2. Set microSD card to SD card slot on carry board and turn on the power of the board by pressing the power button(SW9).

3. After turned on the board, keep pressing the ENTER key on the Tera term and U-boot console will be activated.

Note: Step 3 and 4 are required only when switching the booting method.

If you want to run this demo, do it only once.

```
U-Boot 2021.10 (Mar 31 2022 - 03:57:20 +0000)

CPU: Renesas Electronics K rev 14.15
Model: smarc-rzv2l
DRAM: 1.9 GiB
MMC: sd@11c00000: 0, sd@11c10000: 1
Loading Environment from MMC... OK
In: serial@1004b800
Out: serial@1004b800
Err: serial@1004b800
Net: eth0: ethernet@11c20000
Hit any key to stop autoboot: 0
=>
```

Flash Write  
(SCIF download mode)

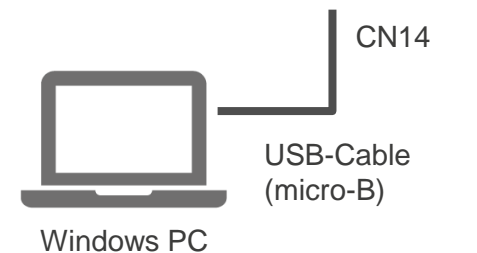
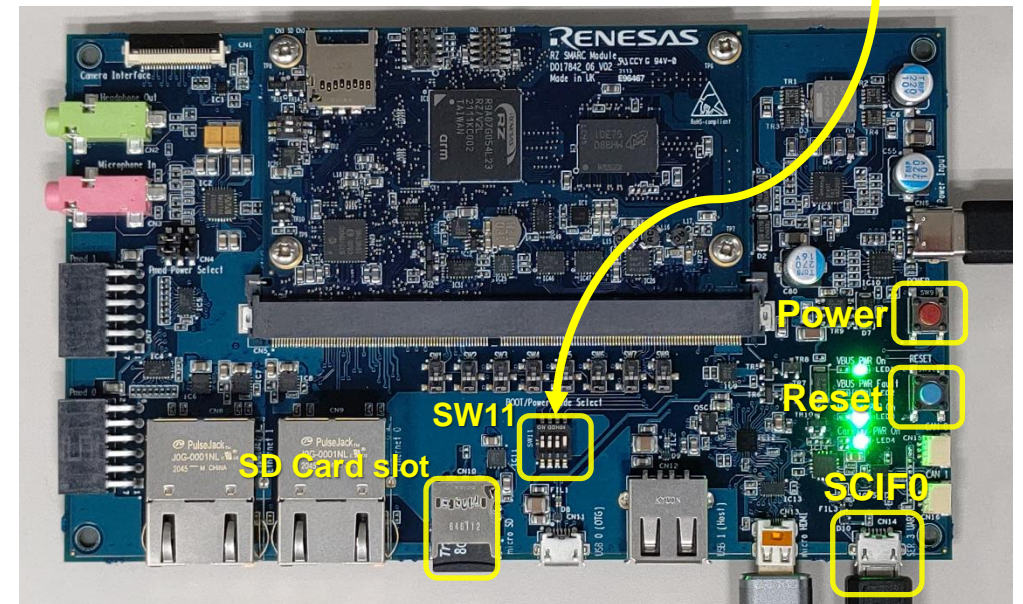
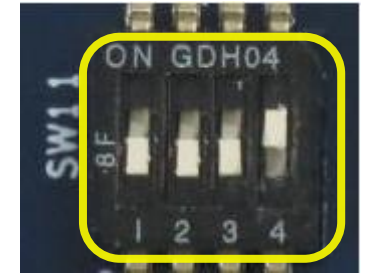

# Linux Boot Up Preparation

## Setting U-boot 2

---

4. Set environment variables using the commands below:

```
=> setenv bootargs 'root=/dev/mmcblk1p2 rootwait'
=> setenv bootcmd 'mmc dev 1;fatload mmc 1:1 0x48080000 Image-smarc-rzv2l.bin; fatload mmc 1:1 0x48000000 Image-r9a07g05412-smarc.dtb; booti 0x48080000 - 0x48000000'
=> saveenv
Saving Environment to MMC... Writing to MMC(0)...OK
=> boot
```

After set “saveenv” command, please set “boot” command to booting the Linux.

5. Check the display of “smarc-rzv2l login:” on the console.

```
Poky (Yocto Project Reference Distro) 3.1.17 smarc-rzv2l ttySC0

BSP: RZV2L/RZV2L-SMARC-EVK/3.0.2
LSI: RZV2L
Version: 3.0.2
smarc-rzv2l login: root
Last login: Sun Sep 20 10:44:25 UTC 2020
root@smarc-rzv2l:~#
```

6. Shutdown the board according to slide [[Shutdown Method](#)].

# Linux Boot Up

- Once procedures in slide [[Linux Boot Up Preparation](#)] are done, users can boot-up the board with the following procedures. (Boot Up Preparation procedures are required only once.)
  - Note that Boot Up procedures does not require Windows PC and USB-Cable (micro-B). Users can detach it from the board.
1. Refer to slide [[Necessary Equipment and Board Connections](#)] to connect RZ/V2L Evaluation Board Kit and other equipment.
  2. Press power button for 1 second to turn on the board.
  3. After the boot-up, desktop screen will be displayed on HDMI monitor as shown in the figure 1.
  4. Click the icon at the top-left corner to open the terminal as shown in the figure 2.

Figure 1

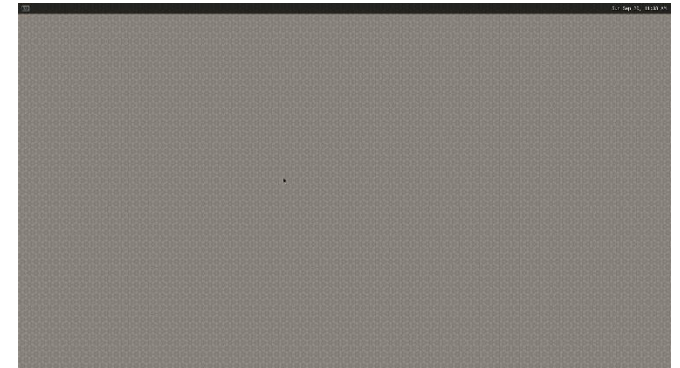
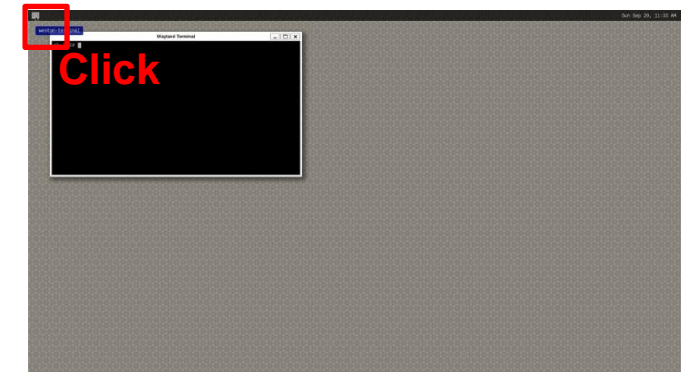

Figure 2





# Demo Execution Method

---

➤ This step must be run on terminal console on HDMI screen.

1. Refer to slide [[Linux Boot Up](#)] to boot up the RZ/V2L Evaluation Board Kit.  
For "**Parking Spot Reservation**" and "**Passport check support**", MIPI camera must not be connected to the board.
2. Refer to slide [[AI Applications Demo Contents List](#)] for available applications.
3. Execute following command to run the demo.

```
# cd /home/root
# ./<category>/<application-name>.sh
```

For example, to run "**Elevator passengers Counting**" application, execute following command.

```
# ./SmartBuilding/Elevator-passengers-Counting.sh
```

Some applications support both MIPI/USB camera input. (Refer to slide [[AI Applications Demo Contents List](#)])  
To use USB camera for those applications, run following command.

```
# ./<category>/<application-name>.sh USB
```

4. On monitor, the application will automatically start.  
For "**Parking Spot Reservation**" and "**Passport check support**", GUI control is required. Refer to slide [[GUI control](#)].
5. To terminate the application, press [Super (Windows key)+Tab] to switch back to terminal window and press [Enter] key.  
If the application does not terminate, press [Ctrl+C] on terminal window.

# Shutdown Method

➤ Run the following procedures to turn off the board.

1. Execute the following commands to shutdown the board.

```
# shutdown -h now
```

2. Check that shutdown procedure runs and ends with following log.

```
[xxxxx.xxxxxx] reboot: Power down
```

3. Press and hold the power button (SW9) for 2 seconds.

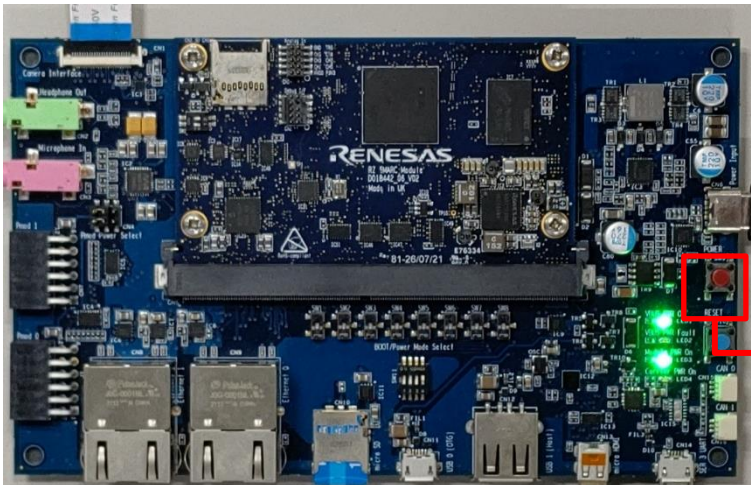

Power switch.  
(SW9)

# REFERENCES

# Tips

---

➤ Linux terminal has the auto-completion functionality.

- Users can type "A"->[Tab] to get the full file/directory name that starts with "A".

```
# cd /home/root
# ./A
```

-> Press [Tab] and yellow characters below are completed automatically if there is only one directory/file starts from "A".

```
# ./Agriculture
```

- Users can press [Tab] for 2 times to get the path suggestion.

```
# cd /home/root
# ./SmartBuilding/
```

-> Press [Tab] for 2 times and following suggestions will be shown.

```
# ./SmartBuilding/
Conference-Room-Usage-Monitor.sh
Elevator-passengers-Counting.sh
Lighting-Control.sh
...
```

# GUI Control

---

➤ Check the link below for each application.

Category	Application Name	Script Name	GUI control
SmartBuilding	Parking Spot Reservation	Parking-Spot-Reservation.sh	<a href="#">Link</a> See "GUI for running the application"
SmartBuilding	Passport check support	Passport-check-support.sh	<a href="#">Link</a> See "GUI for running the application"

# FAQ

---

- **Q:** Cannot type some letters on console. e.g., "~", "\_", etc.
  - **A:** Keyboard setting of RZ/V2L Linux terminal on HDMI monitor is US layout. Please type letters according to the US keyboard layout.

- **Q:** Application failed with following errors.

```
terminate called after throwing an instance of 'cv::Exception'
  what():  OpenCV(4.1.) /usr/src/debug/opencv/4.1.0-r0/git/modules/highgui/src/window.cpp:352: error: (-215:Assertion
failed) size.width>0 && size.height>0 in function 'imshow'

./xxxx/xxxx.sh: line8:  321 Aborted
/$APPNAME
```

- **A:** This error occurs when running "**Parking Spot Reservation**"/"**Passport check support**" with MIPI camera connected to the board. Please detach the MIPI camera, reboot the board and run the application again.

---

[Renesas.com](https://www.renesas.com)