

ZCU670 Unicast Boundary Clock Performance

Introduction

This report shows the results of Unicast Boundary Clock testing with the ZCU670 platform. Test results are compared to ITU-T G.8273.2 Full Time Support and ITU-T G.8273.4 Partial Time Support standards.

Contents

1. Introduction	3
2. Results Summary	3
3. Test Configuration	3
4. G.8273.2: Noise Generation – Standalone	4
4.1 PTP Measurements	5
4.1.1 TIMEERROR Analysis	6
4.1.2 FILTEREDTIMEERROR Analysis	7
4.1.3 CTE Analysis	8
4.1.4 DTE Analysis	9
4.1.5 DTEHF Analysis	10
4.1.6 DTEMTIE Analysis	11
4.1.7 DTETDEV Analysis	12
4.2 1PPS Measurements	13
4.2.1 ONEPPS Analysis	14
4.2.2 FILTEREDTIMEERROR Analysis	15
4.2.3 CTE Analysis	16
4.2.4 DTE Analysis	17
4.2.5 DTEHF Analysis	18
4.2.6 DTEMTIE Analysis	19
4.2.7 DTETDEV Analysis	20
5. G.8273.2: Holdover – Standalone	21
5.1 PTP Measurements	21
5.1.1 TIMEERROR Analysis	22
5.1.2 DTE Analysis	23
5.1.3 DTEMTIE Analysis	24
5.2 1PPS Measurements	25
5.2.1 ONEPPS Analysis	25
5.2.2 MTIE Analysis	26
6. G.8273.2: Noise Generation – External Servo	27
6.1 1PPS Measurements	27
6.1.1 ONEPPS Analysis	28
6.1.2 FILTEREDTIMEERROR Analysis	29
6.1.3 CTE Analysis	30
6.1.4 DTE Analysis	31
6.1.5 DTEHF Analysis	32
6.1.6 DTEMTIE Analysis	33
6.1.7 DTETDEV Analysis	34

7.	G.8273.2: Holdover – External Servo	35
7.1	1PPS Measurements	35
7.1.1	ONEPPS Analysis	36
7.1.2	MTIE Analysis	37
8.	G.8273.4 PTS: Noise Tolerance G.8271.2 PDV Pattern	38
8.1	1PPS Measurements	38
8.1.1	ONEPPS Analysis	39
9.	Configuration Files	40
9.1	TCS File	40
9.2	Ts2phc cfg File	40
9.3	Standalone ptp4l cfg Files	41
9.3.1	Unicast BC	41
9.3.2	Unicast SC (2 Masters)	43
9.4	External Servo ptp4l cfg Files	44
9.4.1	Unicast BC	44
9.4.2	Unicast SC (2 Ports)	46
9.5	Pcm4l json File	47
9.5.1	Write Phase (FTS/G.8273.2)	47
9.5.2	Adaptive Time (PTS/G.8273.4)	49
9.6	Synced cfg File	52
10.	Revision History	53

1. Introduction

This report shows the results of Unicast Boundary Clock testing with the ZCU670 platform. Test results are compared to ITU-T G.8273.2 Full Time Support and ITU-T G.8273.4 Partial Time Support standards. Noise generation tests measure the amount of noise produced at the output of the T-BC when there is an ideal input reference packet timing signal. Holdover performance tests check holdover performance by measuring the phase/time output in the event of the loss of the PTP input to the T-BC. The holdover performance is measured on PTP and 1PPS outputs of the DUT.

2. Results Summary

The table below shows the performance testing summary.

Standard	Configuration	Test Case	Results
G.8273.2	Standalone (ts2phc, ptp4l, synced)	Noise Generation	Pass
		Holdover	Pass
	External Servo (pcm4l, ptp4l, synced)	Noise Generation	Pass
		Holdover	Pass
G.8273.4 PTS	External Servo (pcm4l, ptp4l, synced)	Noise Tolerance – G.8271.2 PTS PDV Pattern	Pass

3. Test Configuration

Device Under Test	ZCU670
Oscillator	Rakon 38.4MHz Onboard MiniOcxo
1pps Source	Symmetricom TP5000
Software Version	4.3.1
PTP4L Version	4.0
Instrument	Paragon Neo
Instrument Serial Number	00036081
Ethernet Interface	10G Optical
CAT Version	28.10.22111.2025 [S] (C)

The ITU-T G.8273.2 and ITU-T G.8273.4 PTS performance testing was completed in the following configuration with Eth1 connected to Port 1 of the Calnex Paragon Neo, and Eth2 connected to Port 2. This configuration is used for both Boundary Clock and Slave Clock tests with two masters.

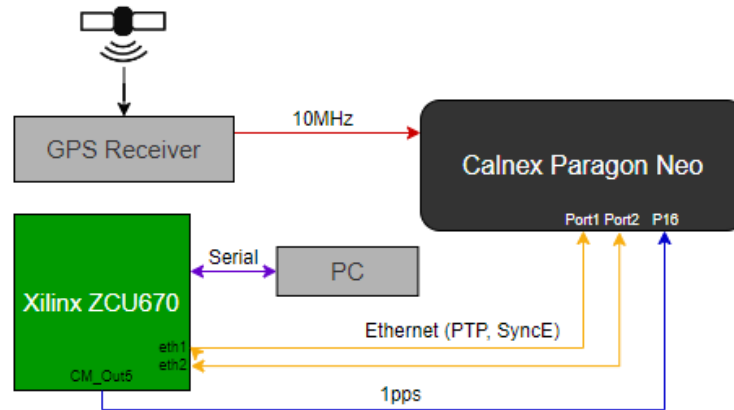

Figure 1. Test Configuration 1

4. G.8273.2: Noise Generation – Standalone

The noise generation of a T-BC represents the amount of noise produced at the output of the T-BC when there is an ideal input reference packet timing signal. The noise generation is measured on both the PTP and 1PPS outputs of the DUT.

In this section, the standalone configuration (ts2phc, ptp4l, synced) is tested for conformance to ITU-T G.8273.2 Section 7.1 Class D. Physical layer assistance (SyncE) is used during this test.

4.1 PTP Measurements

Test Description	Noise Generation
Report Date	24-09-19_08-47-41
Packet Rate (pkt/s)	16
Beginning of Test	9/11/2024 6:25:26 PM
Test Duration	02:48:13
Test Configuration	1

All Mask Results	Pass
Mask TIMEERROR	0.05µs
Mask TIMEERROR Result	Pass
Mask FILTEREDTIMEERROR	0.00 µs
Mask FILTEREDTIMEERROR Result	Pass
Mask CTE	0.01µs
Mask CTE Result	Pass
Mask DTE	0.01µs
Mask DTE Result	Pass
Mask DTEHF	0.07µs
Mask DTEHF Result	Pass
Mask DTEMTIE	G.8273.2 T-BC Class C Dynamic TE LF Const. Temp.
Mask DTEMTIE Result	Pass
Mask DTETDEV	G.8273.2 T-BC Class C Dynamic TE LF Const. Temp.
Mask DTETDEV Result	Pass

4.1.1 TIMEERROR Analysis

Date: 2024-09-11
File: Ptp1588100.CDF
Include Correction Field: True
Packet Selection: False

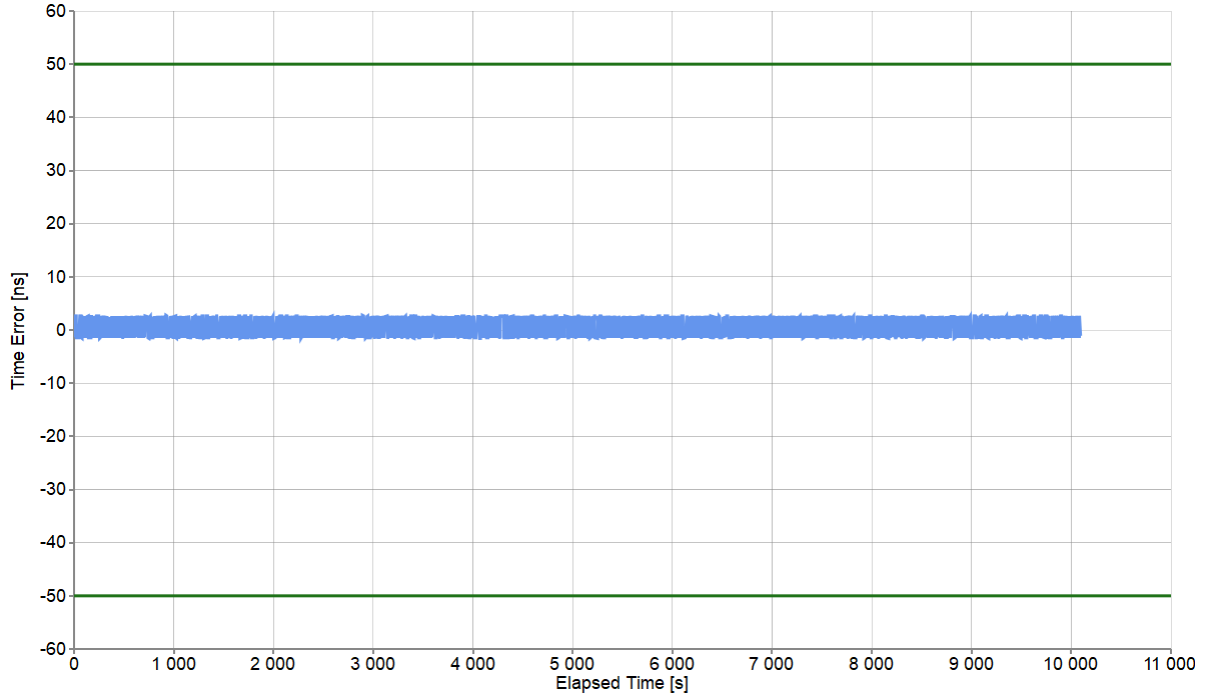

Pk-Pk [ns]	4.375
Mean [ns]	0.389
Min [ns]	-1.593
Max [ns]	2.782

4.1.2 FILTEREDTIMEERROR Analysis

Date: 2024-09-11
File: Ptp1588100.CDF

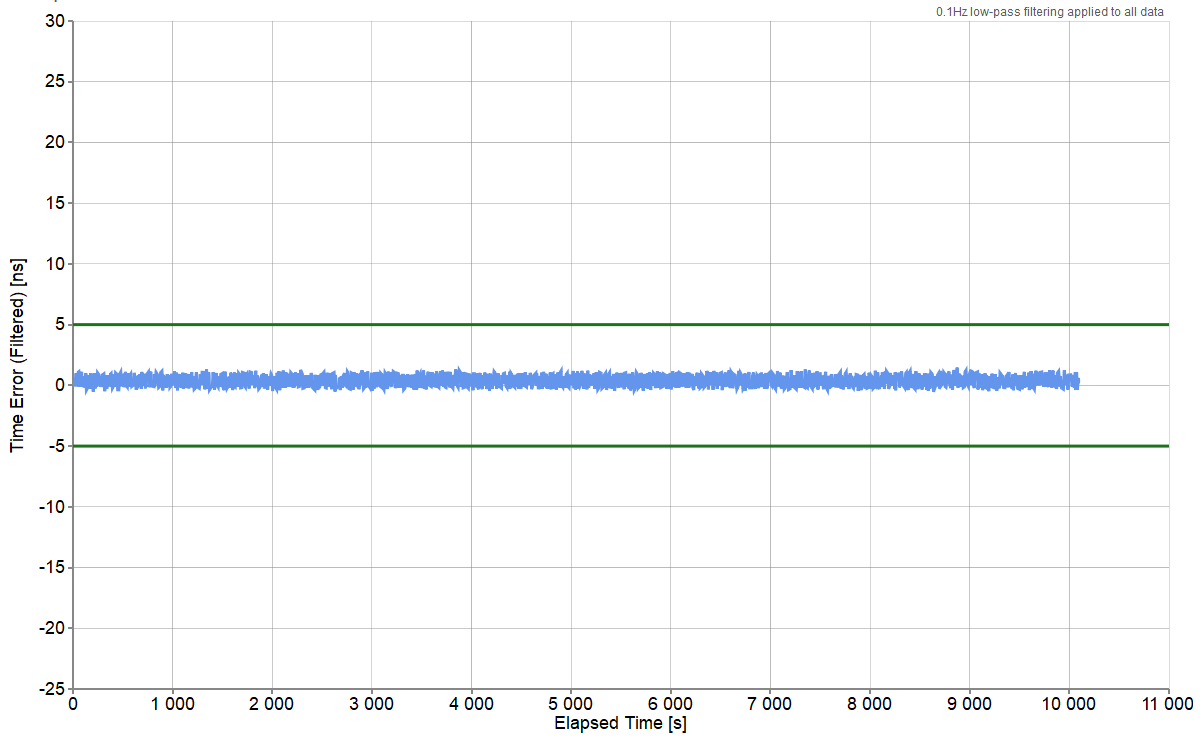

Mean [ns]	0.389
Min [ns]	-0.528
Max [ns]	1.461
Max-Min [ns]	1.989

4.1.3 CTE Analysis

Date: 2024-09-11
 File: Ptp1588100.CDF
 Averaging Period: 1000s

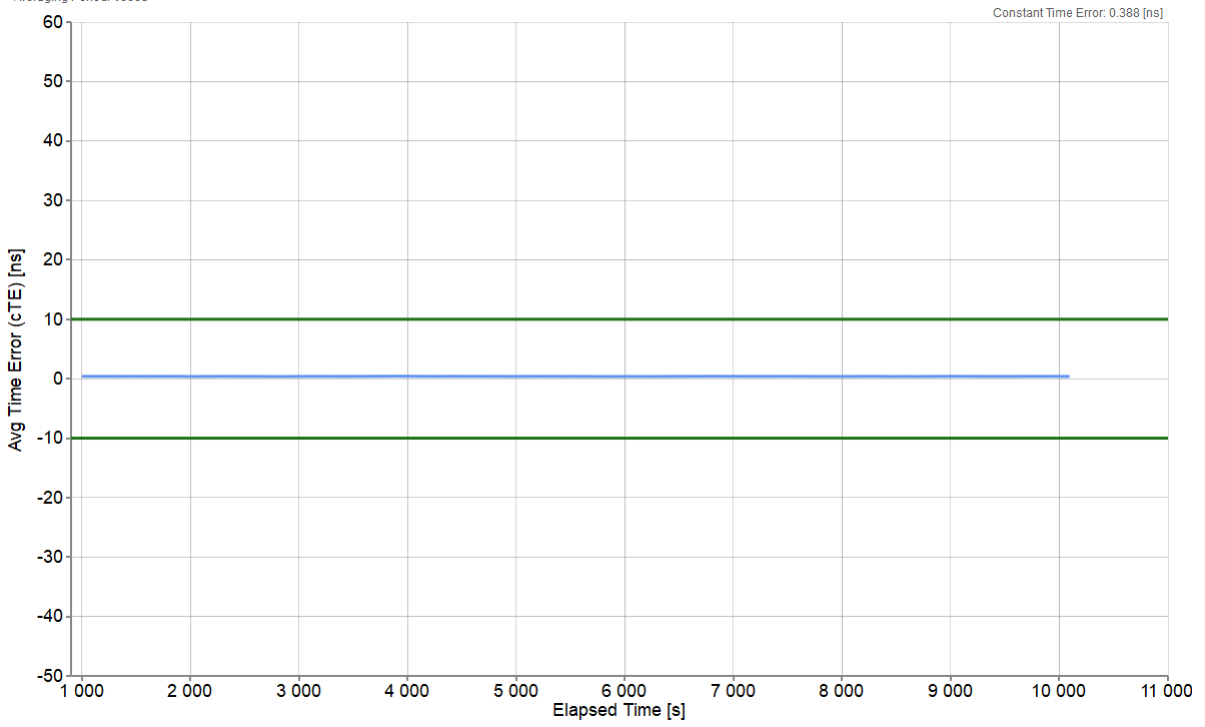

Averaging Time (s)	1000
Constant Time Error [ns]	0.388
Min [ns]	0.361
Max [ns]	0.423
Max-Min [ns]	0.062

4.1.4 DTE Analysis

Date: 2024-09-11
File: Ptp1588100.CDF
Remove Settling: True
Normalization: True

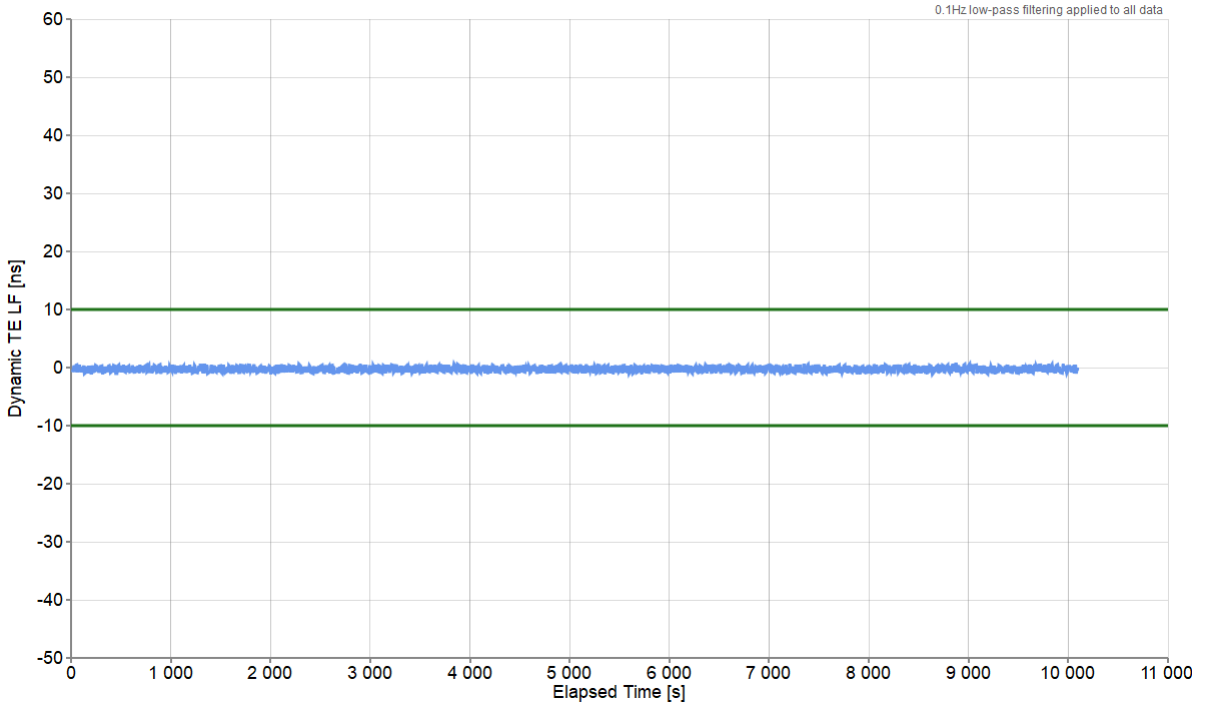

Mean [ns]	-0.268
Min [ns]	-1.186
Max [ns]	0.804
Max-Min [ns]	1.989

4.1.5 DTEHF Analysis

Date: 2024-09-11
File: Ptp1588100.CDF
Normalization: True

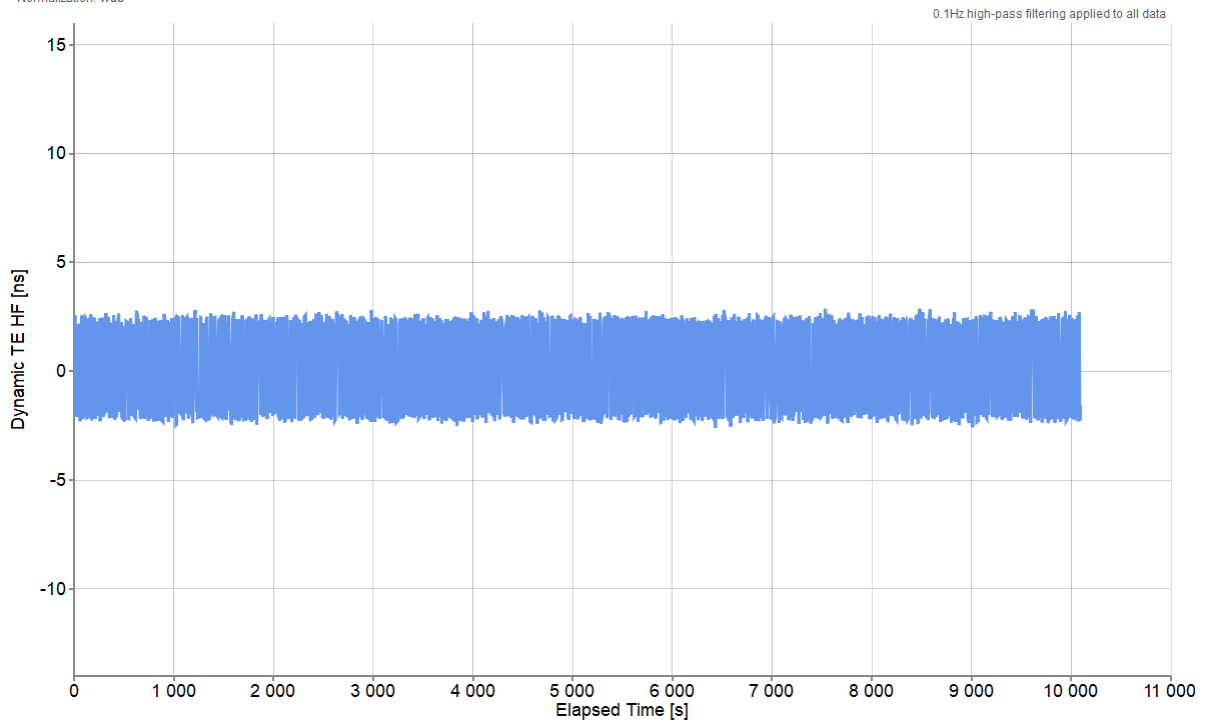

Pk-Pk [ns]	5.473
Mean [ns]	0
Min [ns]	-2.603
Max [ns]	2.87

4.1.6 DTEMTIE Analysis

Date: 2024-09-11
File: Ptp1588100.CDF

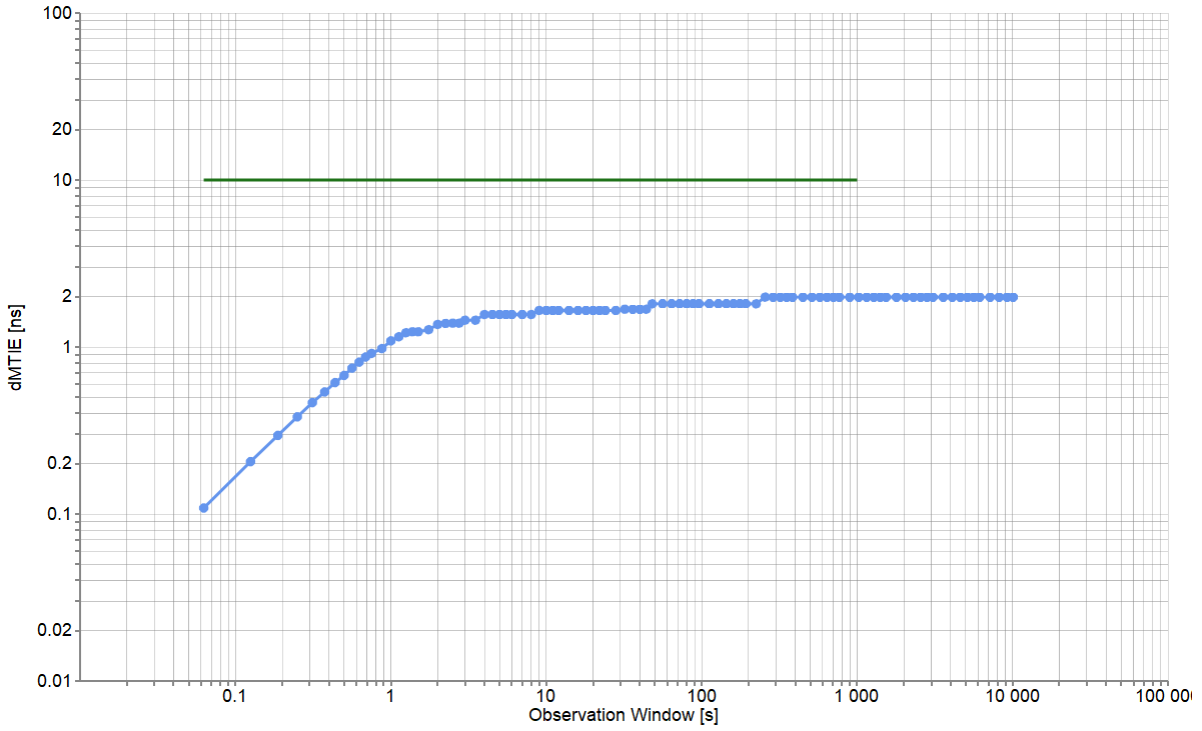

Min [ns]	0.109
Max [ns]	1.989
Max-Min [ns]	1.881

4.1.7 DTETDEV Analysis

Date: 2024-09-11
File: Ptp1588100.CDF

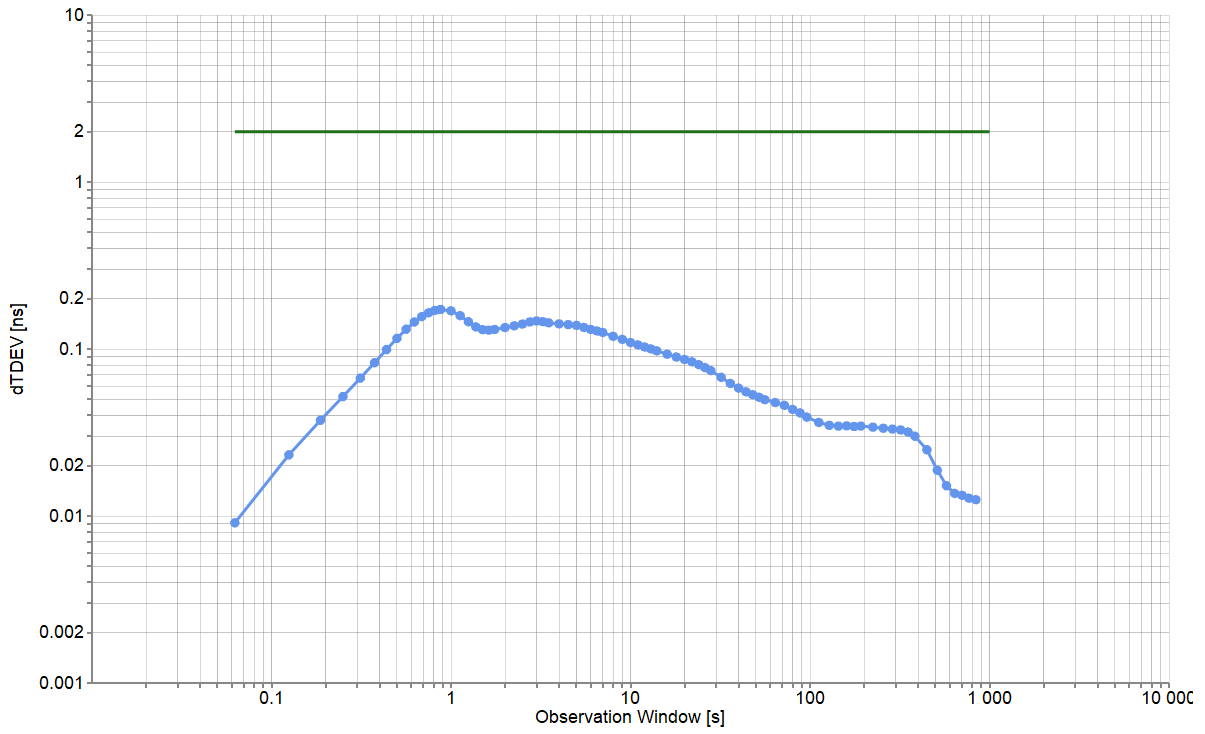

Min [ns]	0.009
Max [ns]	0.173
Max-Min [ns]	0.163

4.2 1PPS Measurements

Test Description	Noise Generation
Report Date	24-09-19_08-47-41
Packet Rate (pkt/s)	16
Beginning of Test	9/11/2024 6:25:26 PM
Test Duration	02:48:12
Test Configuration	1

All Mask Results	Pass
Mask ONEPPS	0.03μs
Mask ONEPPS Result	Pass
Mask FILTEREDTIMEERROR	0.005μs
Mask FILTEREDTIMEERROR Result	Pass
Mask CTE	0.01μs
Mask CTE Result	Pass
Mask DTE	0.01μs
Mask DTE Result	Pass
Mask DTEHF	0.07μs
Mask DTEHF Result	Pass
Mask DTEMTIE	G.8273.2 T-BC Provisional Class D Dynamic TE LF Const. Temp.
Mask DTEMTIE Result	Pass
Mask DTETDEV	G.8273.2 T-BC Provisional Class D Dynamic TE LF Const. Temp.
Mask DTETDEV Result	Pass

4.2.1 ONEPPS Analysis

Offset Removal Applied	Off
Zero Offset	-1.553ns

Date: 2024-09-11
 File: OnePpsAccuracyTod100.CDF
 Offset Removal Applied: False
 Zero Offset: -1.553ns

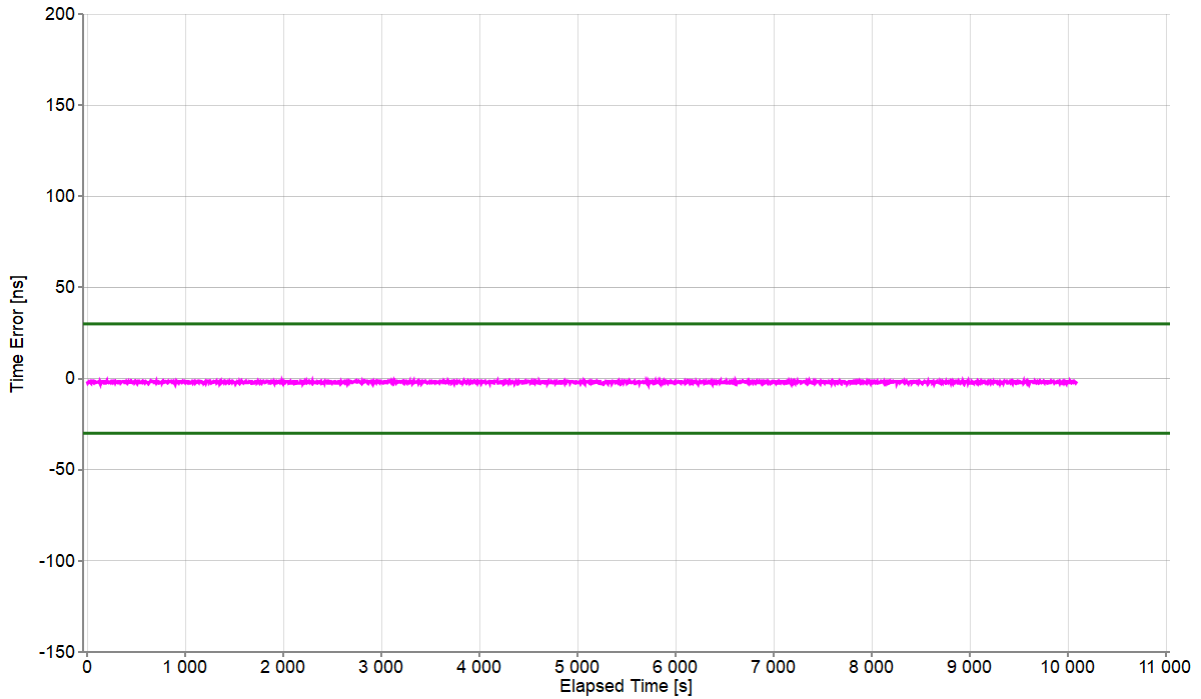

Mean [ns]	-1.908
Min [ns]	-3.303
Max [ns]	-1.053
Max-Min [ns]	2.25

4.2.2 FILTEREDTIMEERROR Analysis

Date: 2024-09-11
 File: OnePpsAccuracyTod100.CDF

0.1Hz low-pass filtering applied to all data

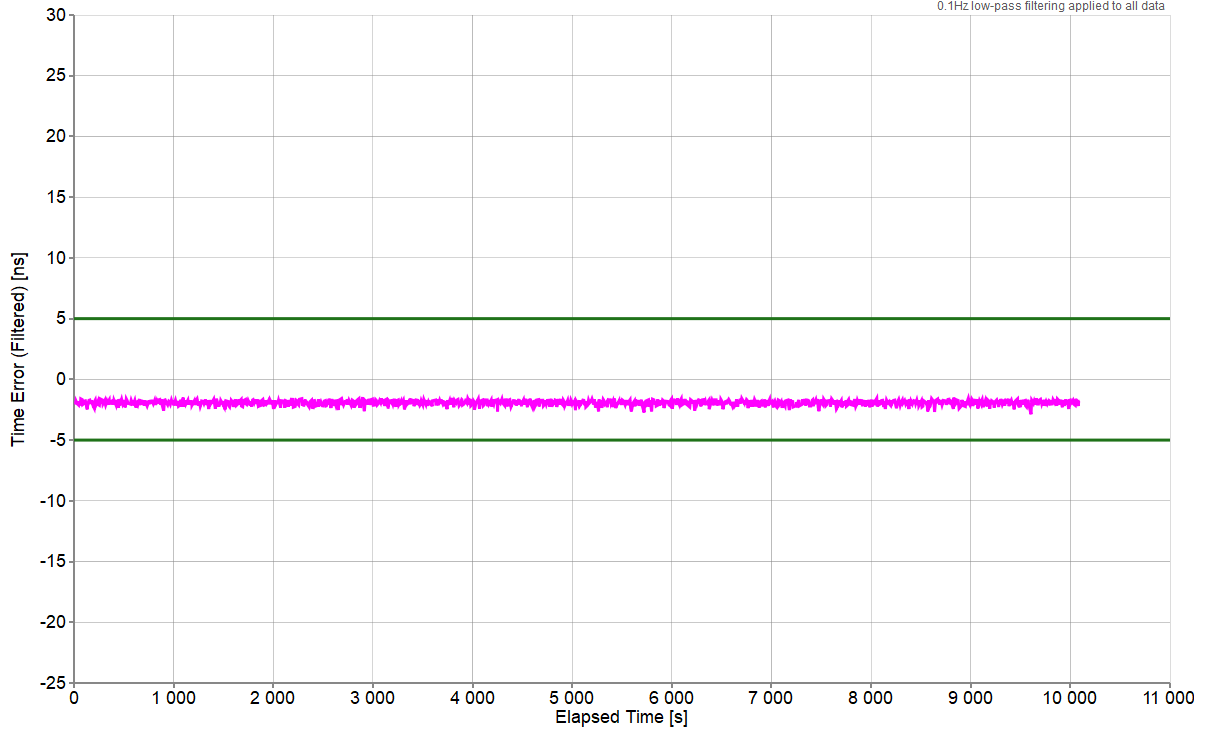

Mean [ns]	-1.908
Min [ns]	-2.871
Max [ns]	-1.465
Max-Min [ns]	1.406

4.2.3 CTE Analysis

Date: 2024-09-11
 File: OnePpsAccuracyTod100.CDF
 Averaging Period: 1000s

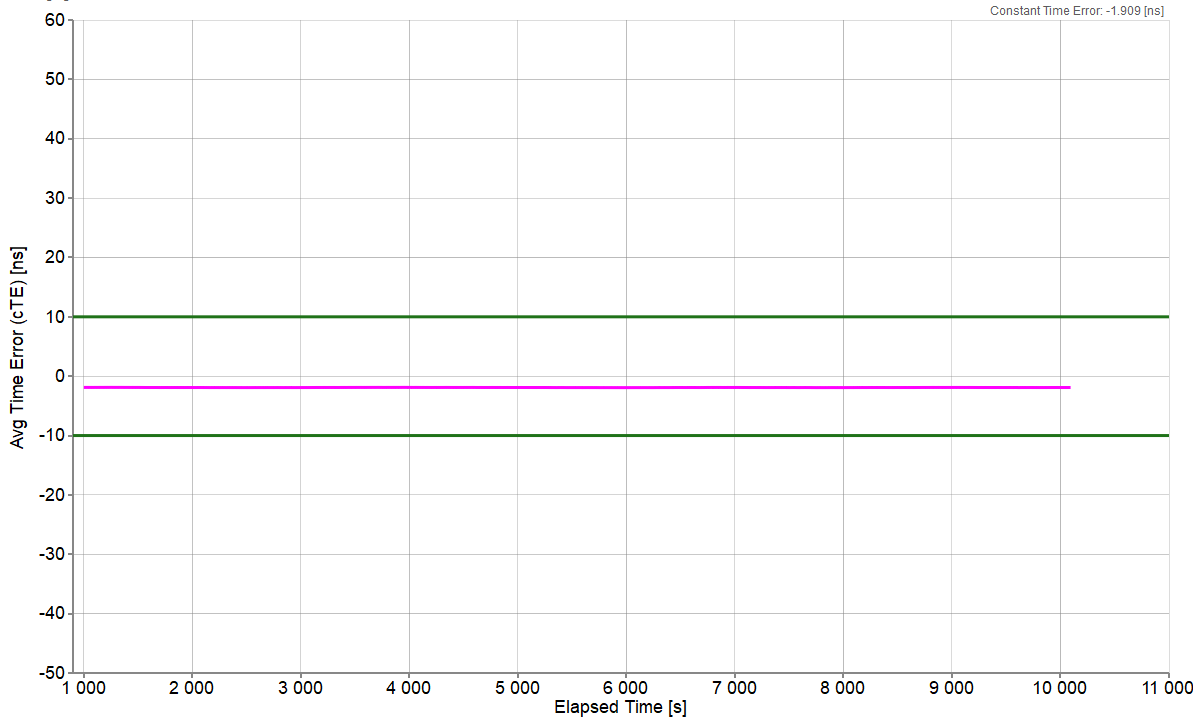

Averaging Time (s)	1000
Constant Time Error [ns]	-1.909
Min [ns]	-1.932
Max [ns]	-1.886
Max-Min [ns]	0.046

4.2.4 DTE Analysis

Date: 2024-09-11
File: OnePpsAccuracyTod100.CDF
Remove Settling: True
Normalization: True

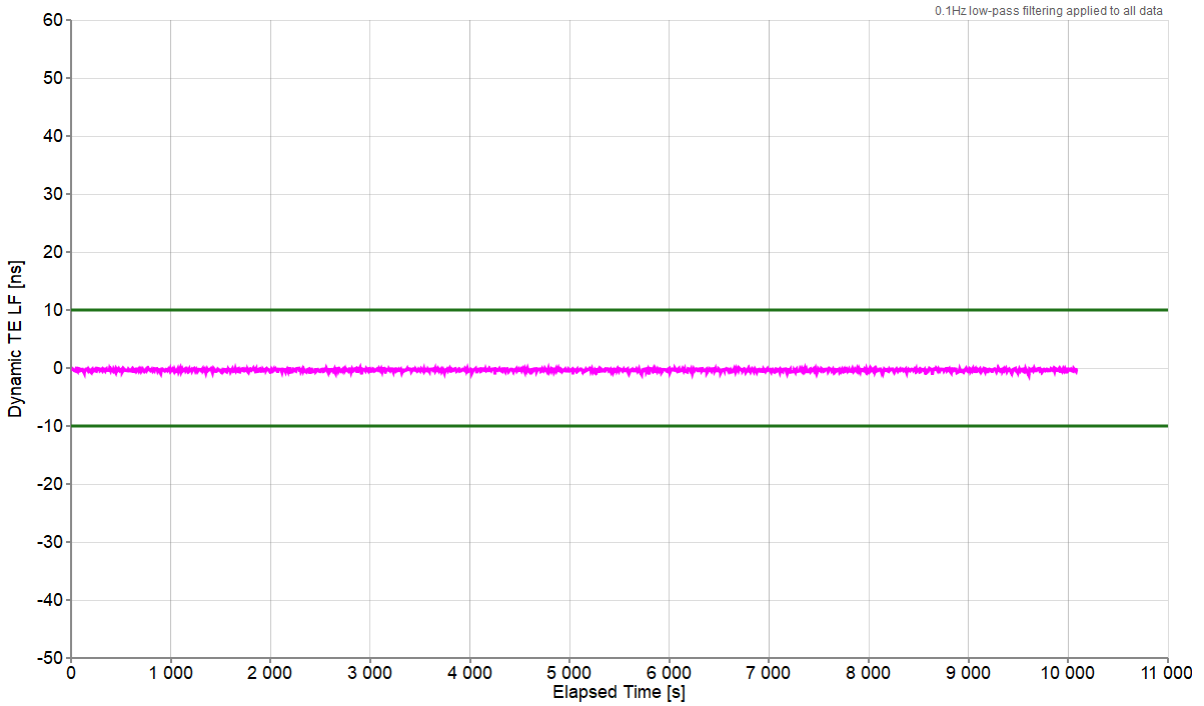

Mean [ns]	-0.355
Min [ns]	-1.318
Max [ns]	0.088
Max-Min [ns]	1.406

4.2.5 DTEHF Analysis

Date: 2024-09-11
File: OnePpsAccuracyTod100.CDF
Normalization: True

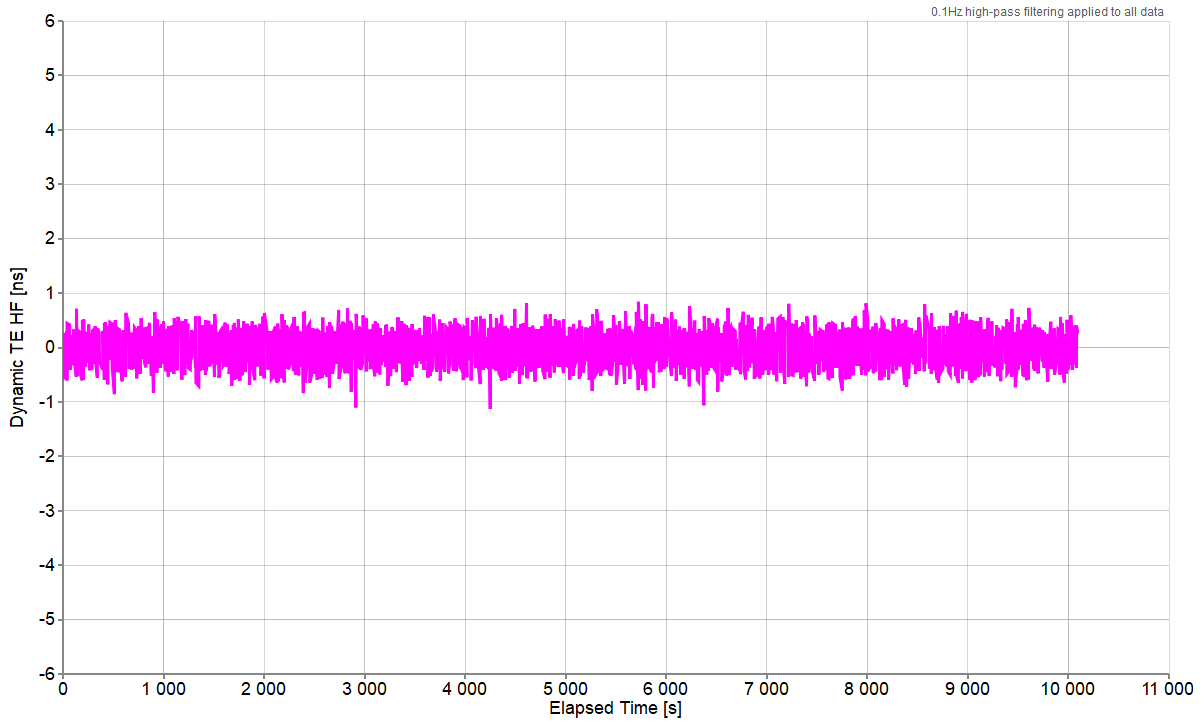

Mean [ns]	0
Min [ns]	-1.13
Max [ns]	0.84
Max-Min [ns]	1.97

4.2.6 DTEMTIE Analysis

Date: 2024-09-11
 File: OnePpsAccuracyTod100.CDF

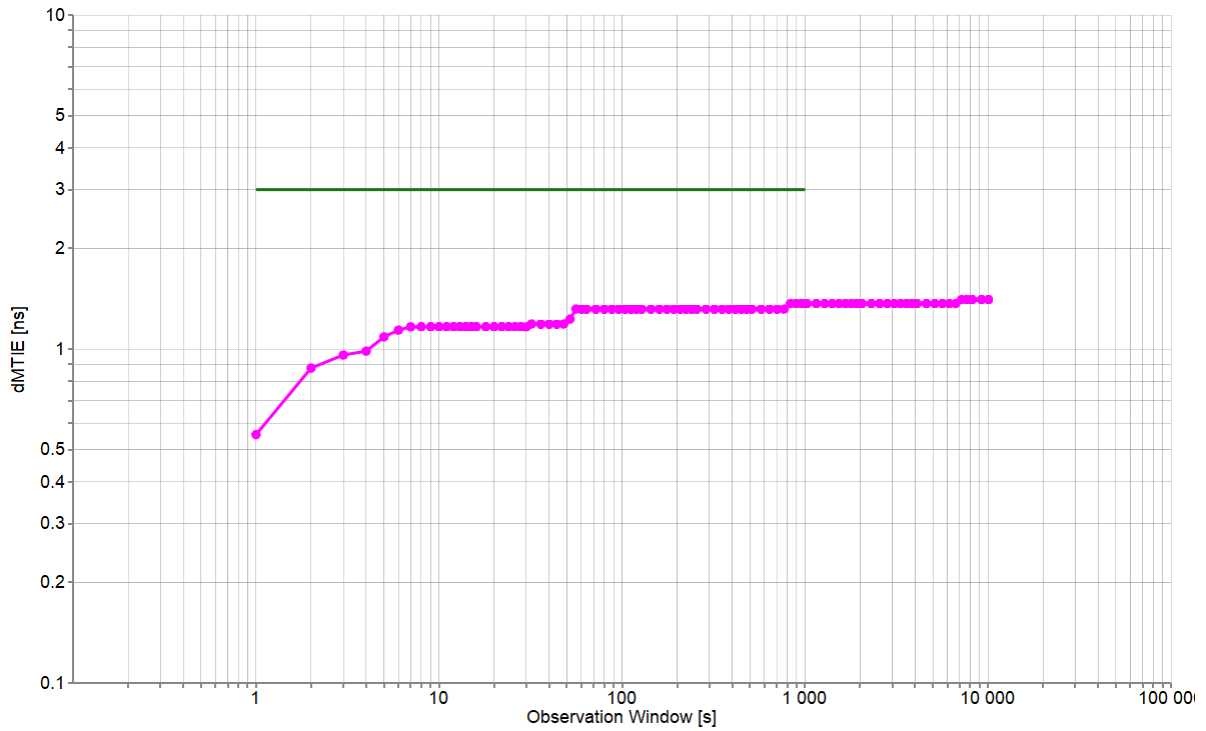

Min [ns]	0.554
Max [ns]	1.406
Max-Min [ns]	0.852

4.2.7 DTETDEV Analysis

Date: 2024-09-11
File: OnePpsAccuracyTod100.CDF

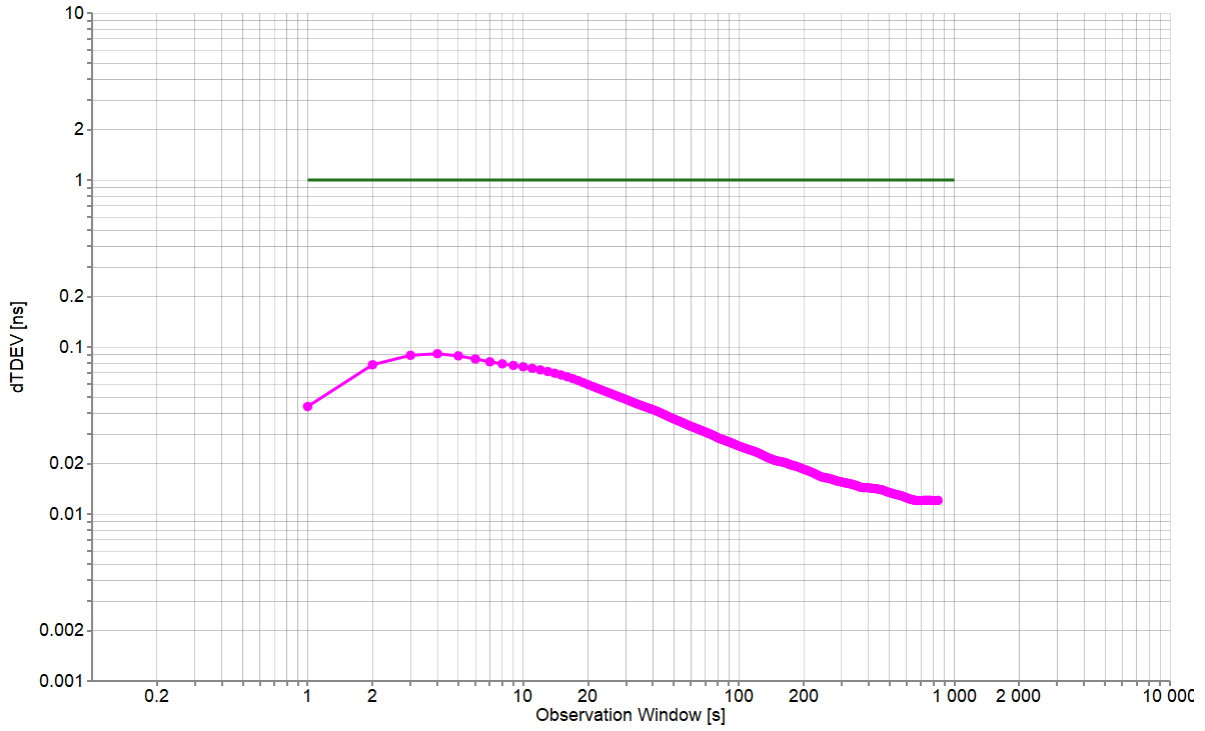

Min [ns]	0.012
Max [ns]	0.091
Max-Min [ns]	0.079

5. G.8273.2: Holdover – Standalone

Holdover performance is checked by measuring the phase/time output in the event of the loss of the PTP input to the T-BC. The holdover performance is measured on PTP and 1PPS outputs of the DUT.

In this section, the standalone configuration (ts2phc, ptp4l, synced) is tested for conformance to ITU-T G.8273.2 Section 7.4.2.2 Class B. Physical layer assistance (SyncE) is used during this test.

5.1 PTP Measurements

Test Description	Holdover
Report Date	24-09-19_08-47-41
Packet Rate (pkt/s)	16
Beginning of Test	9/13/2024 11:34:35 AM
Test Duration	01:08:38
Test Configuration	1

All Mask Results	Pass
Mask TIMEERROR	N/A
Mask TIMEERROR Result	NoMask
Mask DTE	N/A
Mask DTE Result	NoMask
Mask DTEMTIE	G.8273.2 T-BC Class B Time Holdover Const. Temp.
Mask DTEMTIE Result	Pass

5.1.1 TIMEERROR Analysis

Date: 2024-09-13
File: Ptp1588100.CDF
Include Correction Field: True
Packet Selection: False

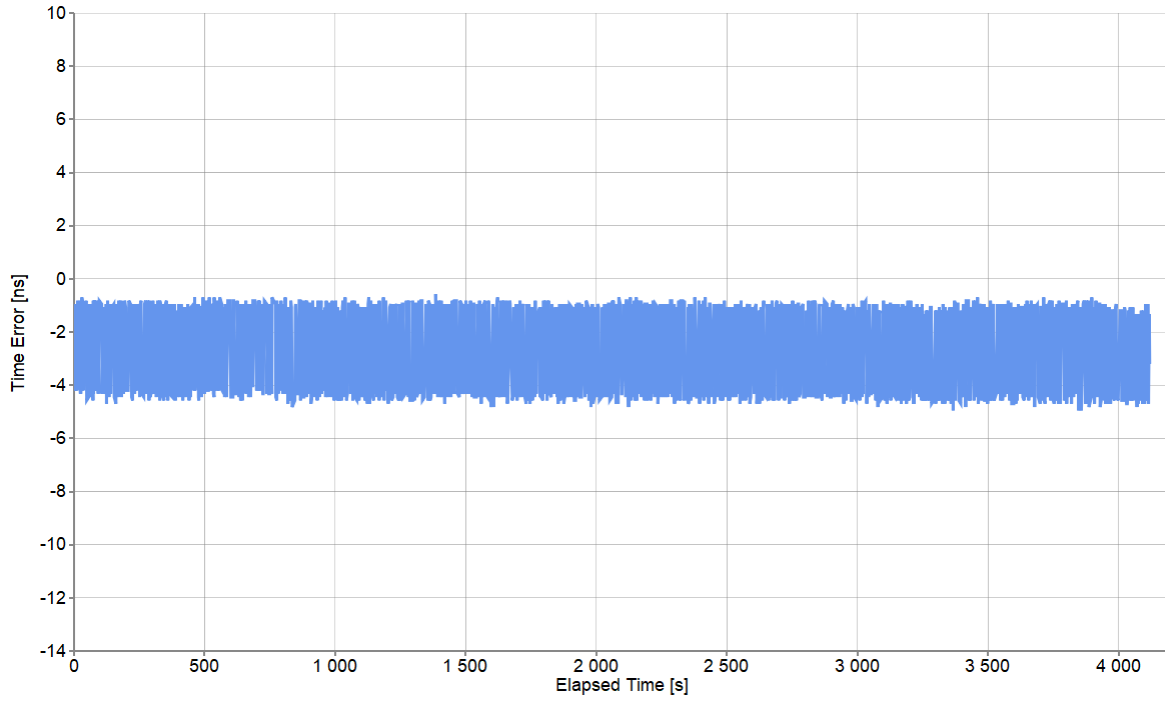

Pk-Pk [ns]	4.375
Mean [ns]	-2.725
Min [ns]	-4.948
Max [ns]	-0.573

5.1.2 DTE Analysis

Date: 2024-09-13
File: Ptp1588100.CDF
Remove Settling: True
Normalization: True

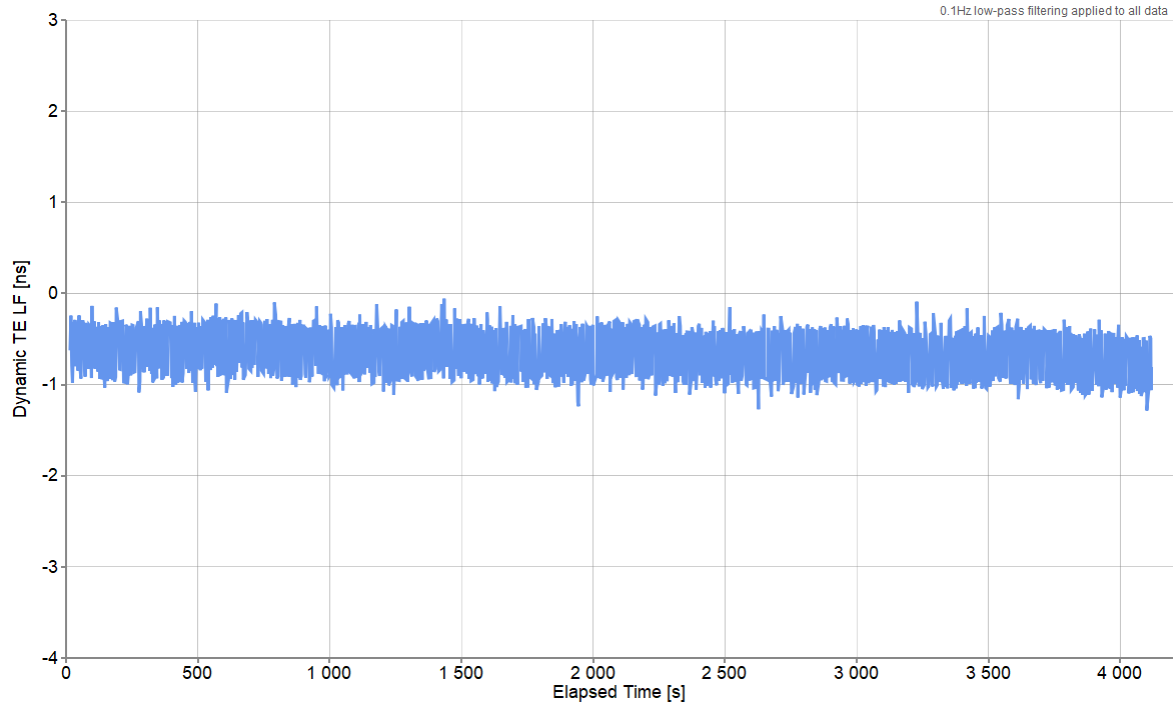

Mean [ns]	-0.652
Min [ns]	-1.284
Max [ns]	-0.057
Max-Min [ns]	1.227

5.1.3 DTEMTIE Analysis

Date: 2024-09-13
File: Ptp1588100.CDF

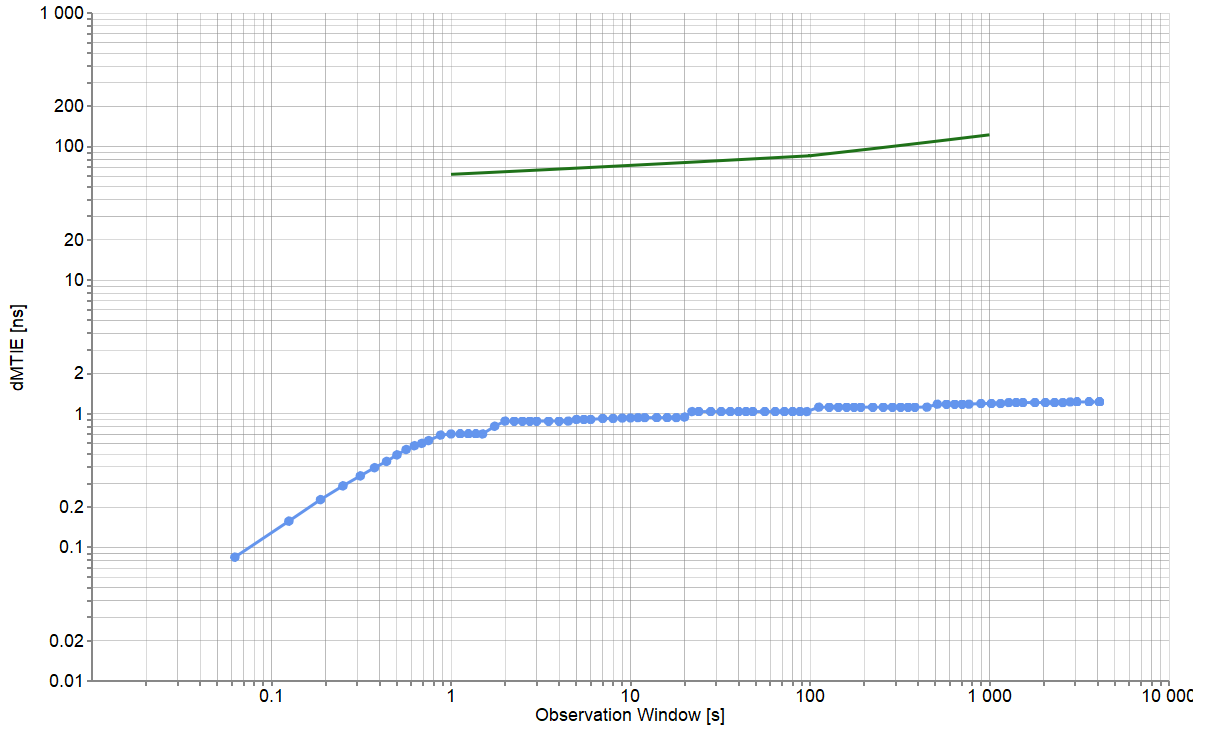

Min [ns]	0.084
Max [ns]	1.227
Max-Min [ns]	1.142

5.2 1PPS Measurements

Test Description	Holdover
Report Date	24-09-19_08-47-41
Packet Rate (pkt/s)	16
Beginning of Test	9/13/2024 11:34:35 AM
Test Duration	01:08:36
Test Configuration	1

All Mask Results	Pass
Mask ONEPPS	N/A
Mask ONEPPS Result	NoMask
Mask MTIE	G.8273.2 T-BC Class B Time Holdover Const. Temp.
Mask MTIE Result	Pass

5.2.1 ONEPPS Analysis

Date: 2024-09-13
 File: OnePpsAccuracyTod100.CDF
 Offset Removal Applied: False
 Zero Offset: -5.803ns

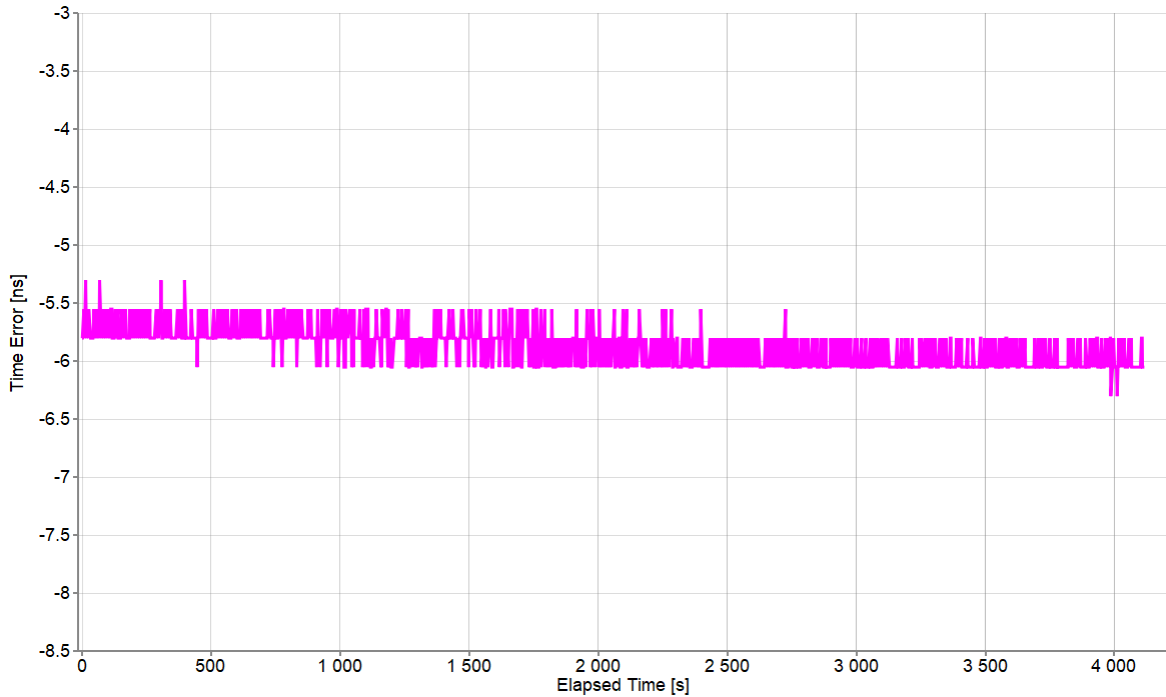

Mean [ns]	-5.904
Min [ns]	-6.303
Max [ns]	-5.303
Max-Min [ns]	1

5.2.2 MTIE Analysis

Date: 2024-09-13
 File: OnePpsAccuracyTod100.CDF

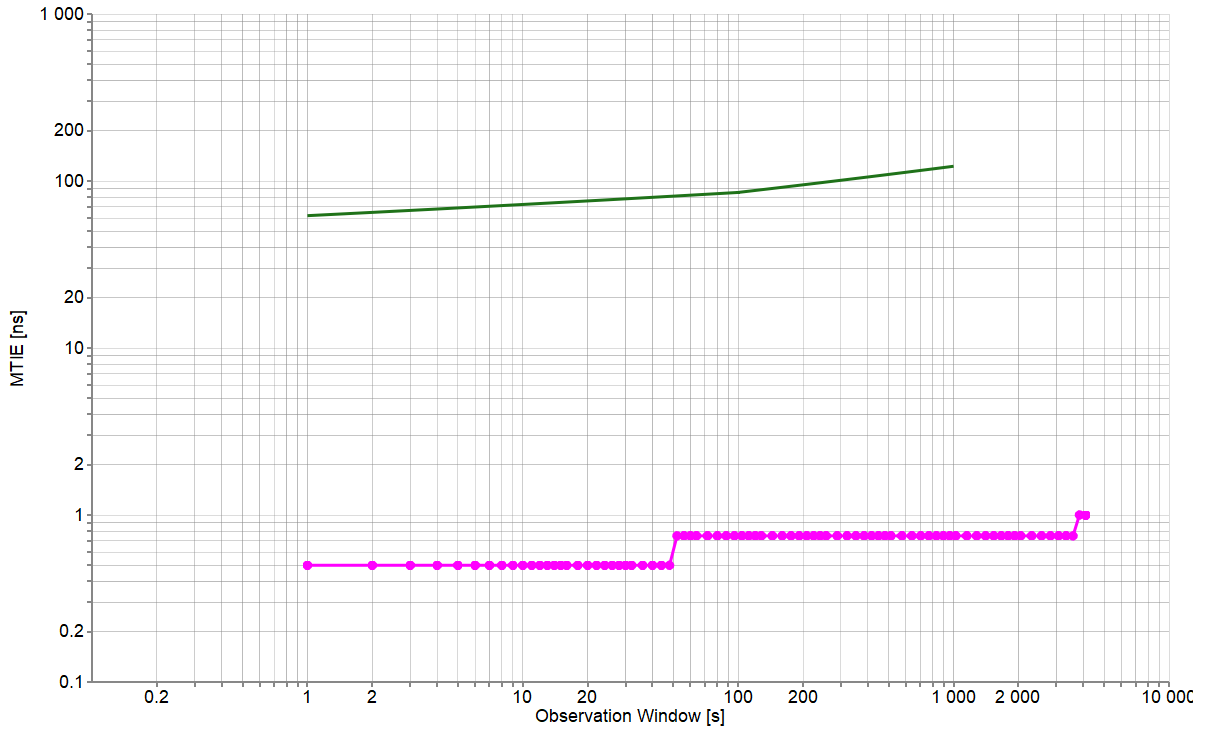

Min [ns]	0.5
Max [ns]	1
Max-Min [ns]	0.5

6. G.8273.2: Noise Generation – External Servo

The noise generation of a T-SC represents the amount of noise produced at the output of the T-SC when there is an ideal input reference packet timing signal. The noise generation is measured on both 1PPS output of the DUT.

In this section, the external servo configuration (pcm4l, ptp4l, synced) is tested for conformance to ITU-T G.8273.2 Section 7.1 Class D. Physical layer assistance (SyncE) is used during this test.

6.1 1PPS Measurements

Test Description	Noise Generation
Report Date	24-09-19_08-47-41
Packet Rate (pkt/s)	16
Beginning of Test	9/12/2024 2:13:28 PM
Test Duration	00:44:10
Test Configuration	1
Time to Phase Lock (s)	19

All Mask Results	Pass
Mask ONEPPS	0.03μs
Mask ONEPPS Result	Pass
Mask FILTEREDTIMEERROR	0.005μs
Mask FILTEREDTIMEERROR Result	Pass
Mask CTE	0.01μs
Mask CTE Result	Pass
Mask DTE	0.01μs
Mask DTE Result	Pass
Mask DTEHF	0.07μs
Mask DTEHF Result	Pass
Mask DTEMTIE	G.8273.2 T-BC Provisional Class D Dynamic TE LF Const. Temp.
Mask DTEMTIE Result	Pass
Mask DTETDEV	G.8273.2 T-BC Provisional Class D Dynamic TE LF Const. Temp.
Mask DTETDEV Result	Pass

6.1.1 ONEPPS Analysis

Offset Removal Applied	Off
Zero Offset	1.697 ns

Date: 2024-09-12
 File: Time Error_19-09-2024_08-41-44_NG.csv
 Offset Removal Applied: False
 Zero Offset: 1.697ns

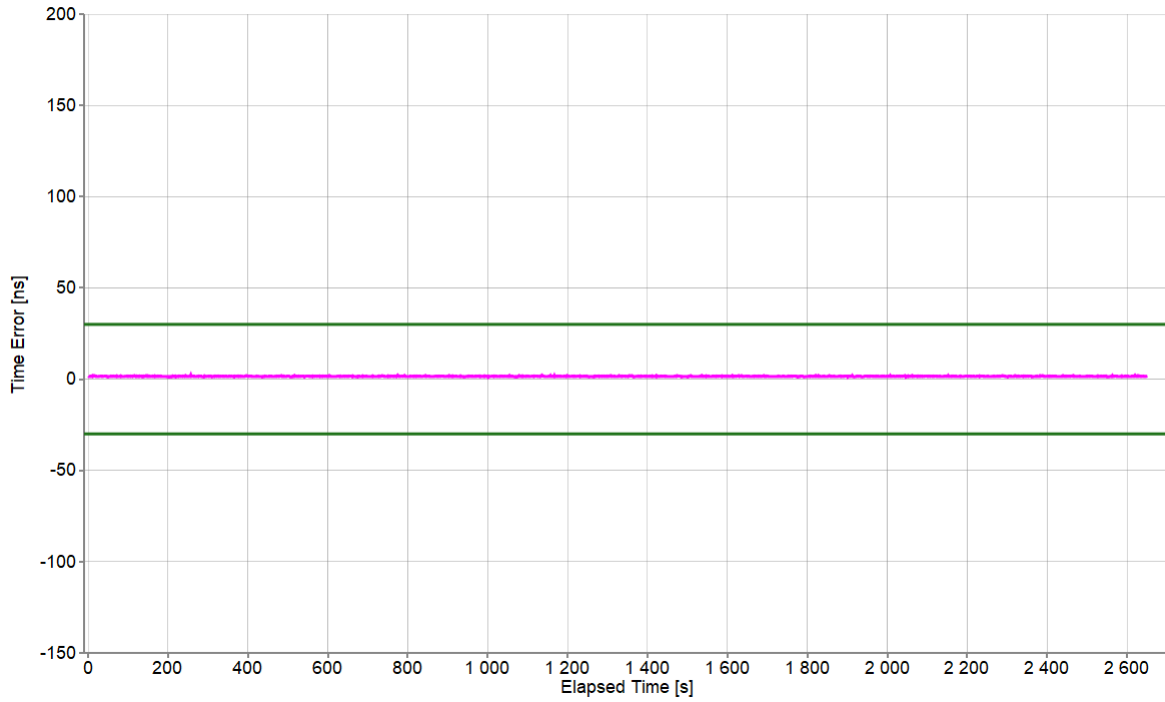

Mean [ns]	1.522
Min [ns]	1.197
Max [ns]	2.197
Max-Min [ns]	1

6.1.2 FILTEREDTIMEERROR Analysis

Date: 2024-09-12
File: Time Error_19-09-2024_08-41-44_NG.csv

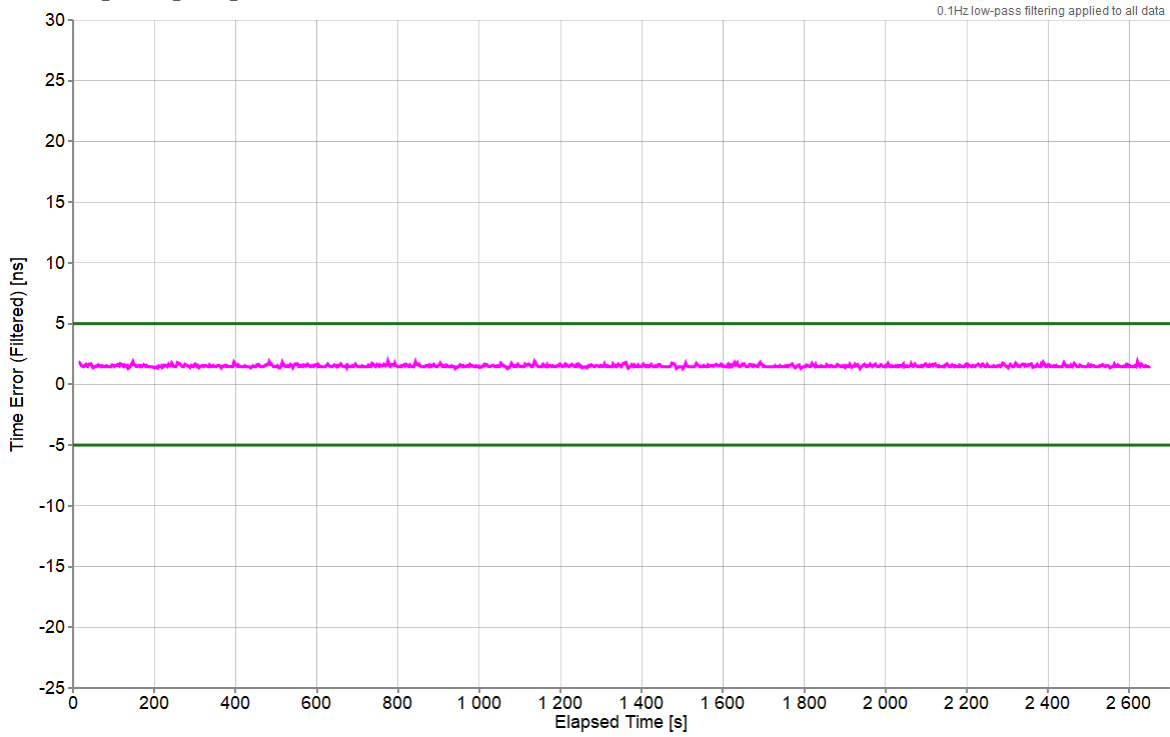

Mean [ns]	1.522
Min [ns]	1.293
Max [ns]	1.926
Max-Min [ns]	0.633

6.1.3 CTE Analysis

Date: 2024-09-12
 File: Time Error_19-09-2024_08-41-44_NG.csv
 Averaging Period: 1000s

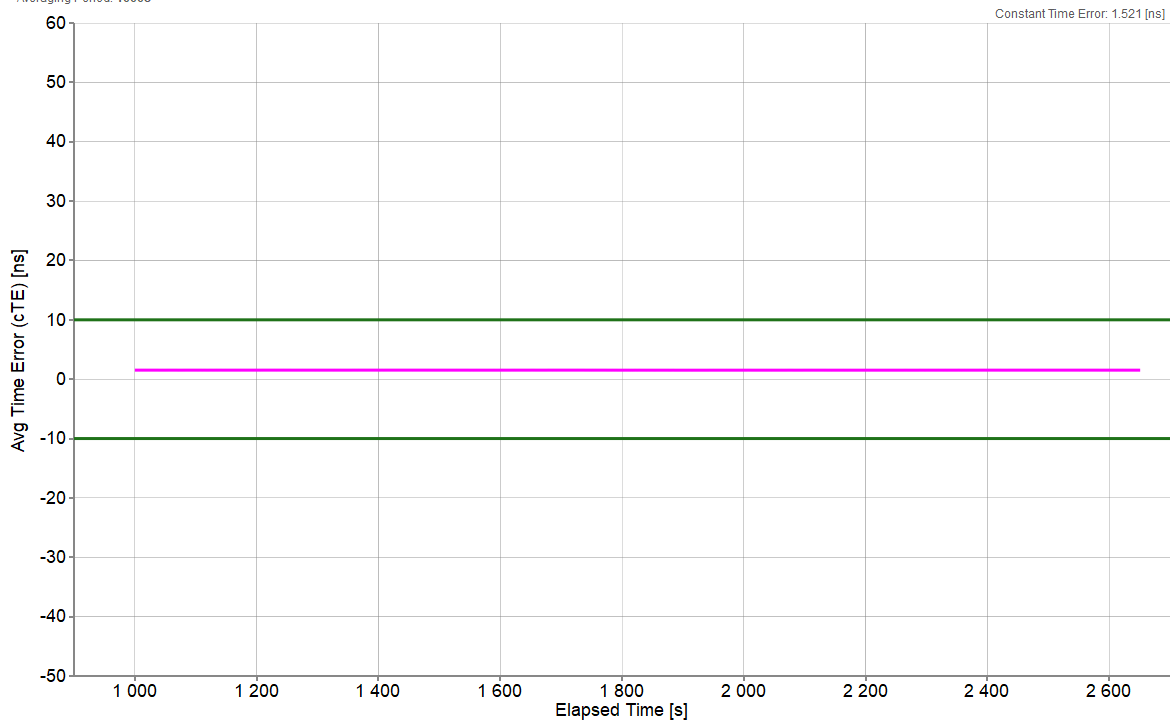

Averaging Time (s)	1000
Constant Time Error [ns]	1.521
Min [ns]	1.515
Max [ns]	1.527
Max-Min [ns]	0.012

6.1.4 DTE Analysis

Date: 2024-09-12
 File: Time Error_19-09-2024_08-41-44_NG.csv
 Remove Setting: True
 Normalization: True

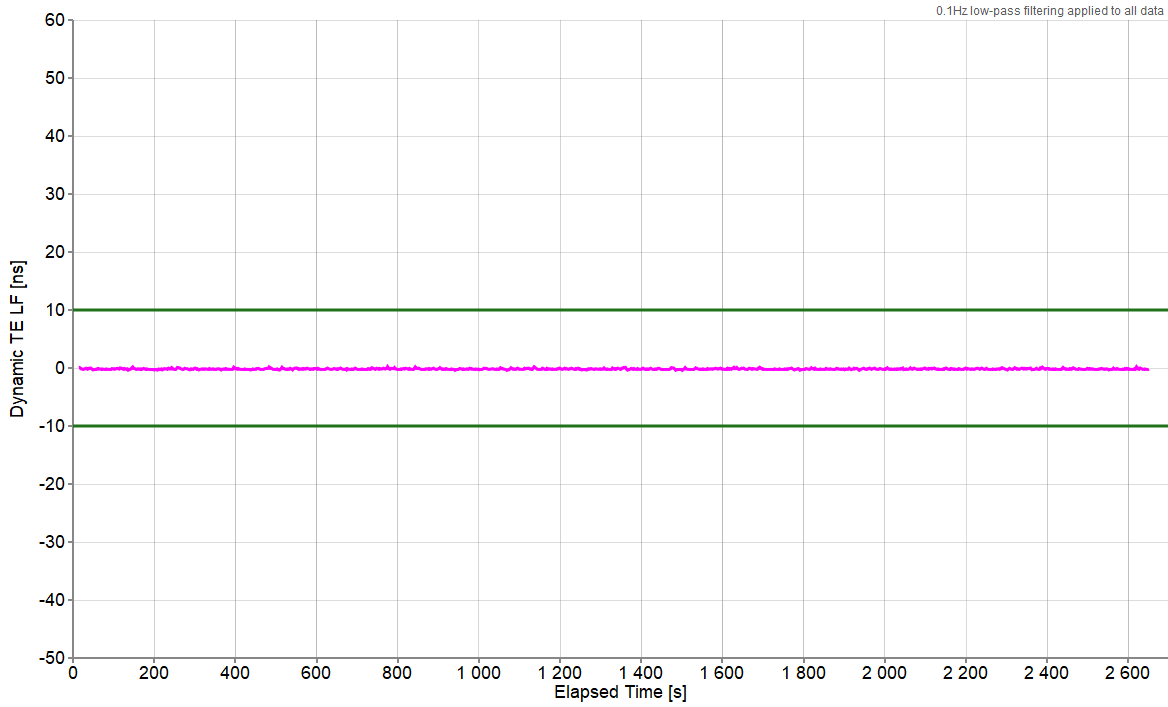

Mean [ns]	-0.175
Min [ns]	-0.404
Max [ns]	0.229
Max-Min [ns]	0.633

6.1.5 DTEHF Analysis

Date: 2024-09-12
File: Time Error_19-09-2024_08-41-44_NG.csv
Normalization: True

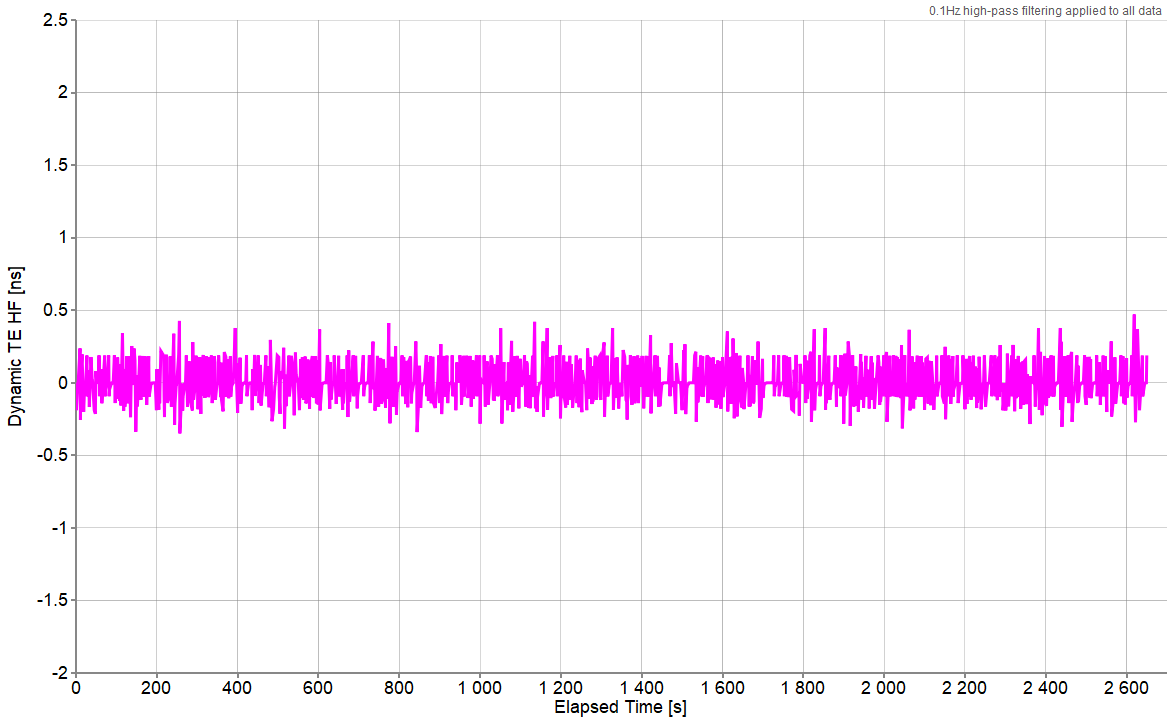

Mean [ns]	0
Min [ns]	-0.349
Max [ns]	0.47
Max-Min [ns]	0.819

6.1.6 DTEMTIE Analysis

Date: 2024-09-12
 File: Time Error_19-09-2024_08-41-44_NG.csv

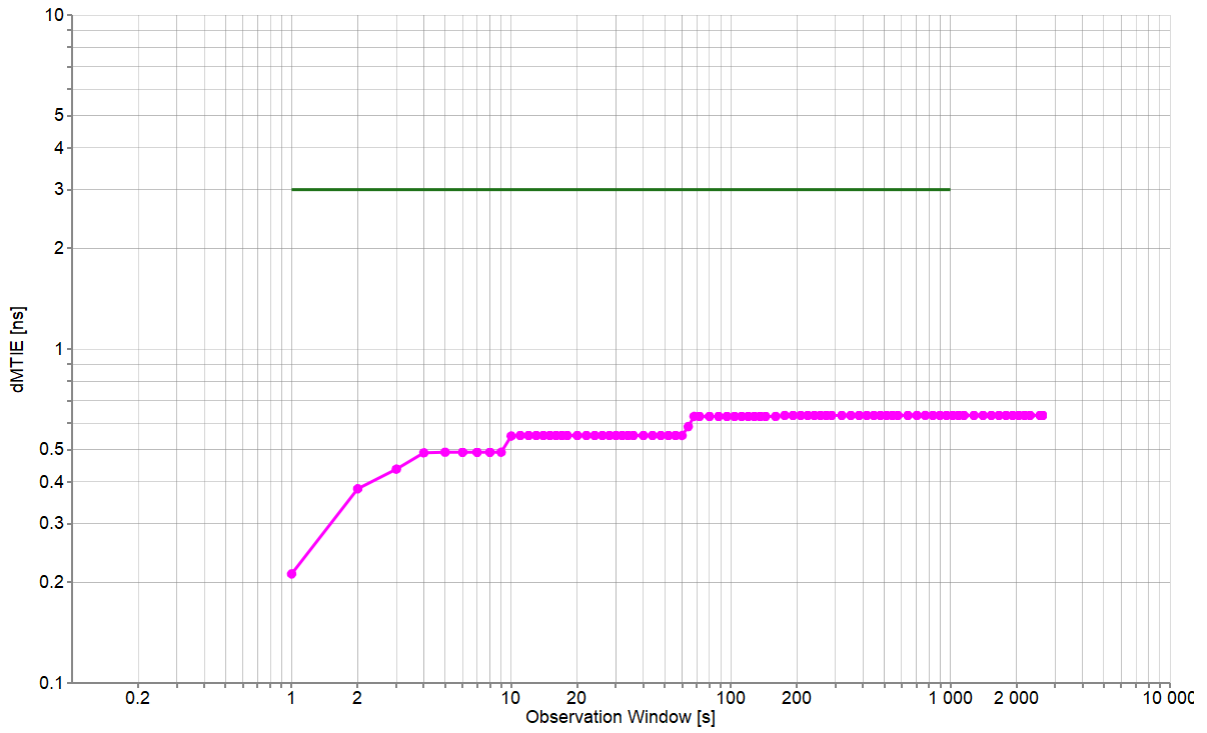

Min [ns]	0.212
Max [ns]	0.633
Max-Min [ns]	0.421

6.1.7 DTETDEV Analysis

Date: 2024-09-12
 File: Time Error_19-09-2024_08-41-44_NG.csv

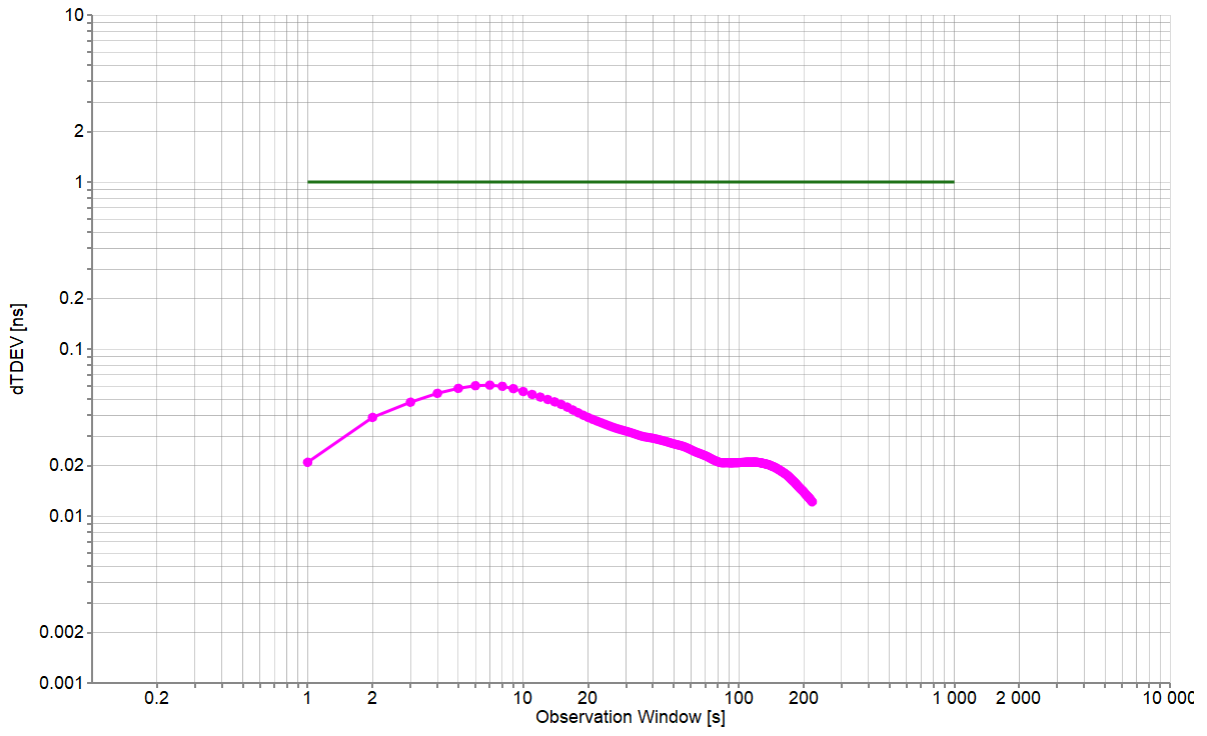

Min [ns]	0.012
Max [ns]	0.061
Max-Min [ns]	0.049

7. G.8273.2: Holdover – External Servo

Holdover performance is checked by measuring the phase/time output in the event of the loss of the PTP input to the T-SC. The holdover performance is measured on the 1PPS output of the DUT.

In this section, the external servo configuration (pcm4l, ptp4l, synced) is tested for conformance to ITU-T G.8273.2 Section 7.4.2.2 Class B. Physical layer assistance (SyncE) is used during this test.

7.1 1PPS Measurements

Test Description	Holdover
Report Date	24-09-19_08-47-41
Packet Rate (pkt/s)	16
Beginning of Test	9/12/2024 2:13:28 PM
Test Duration	05:00:00
Test Configuration	1
Time to Phase Lock (s)	19

All Mask Results	Pass
Mask ONEPPS	N/A
Mask ONEPPS Result	NoMask
Mask MTIE	G.8273.2 T-BC Class B Time Holdover Const. Temp.
Mask MTIE Result	Pass

7.1.1 ONEPPS Analysis

Offset Removal Applied	Off
Zero Offset	1.697ns

Date: 2024-09-12
 File: Time Error_19-09-2024_08-42-10_HO.csv
 Offset Removal Applied: False
 Zero Offset: 1.697ns

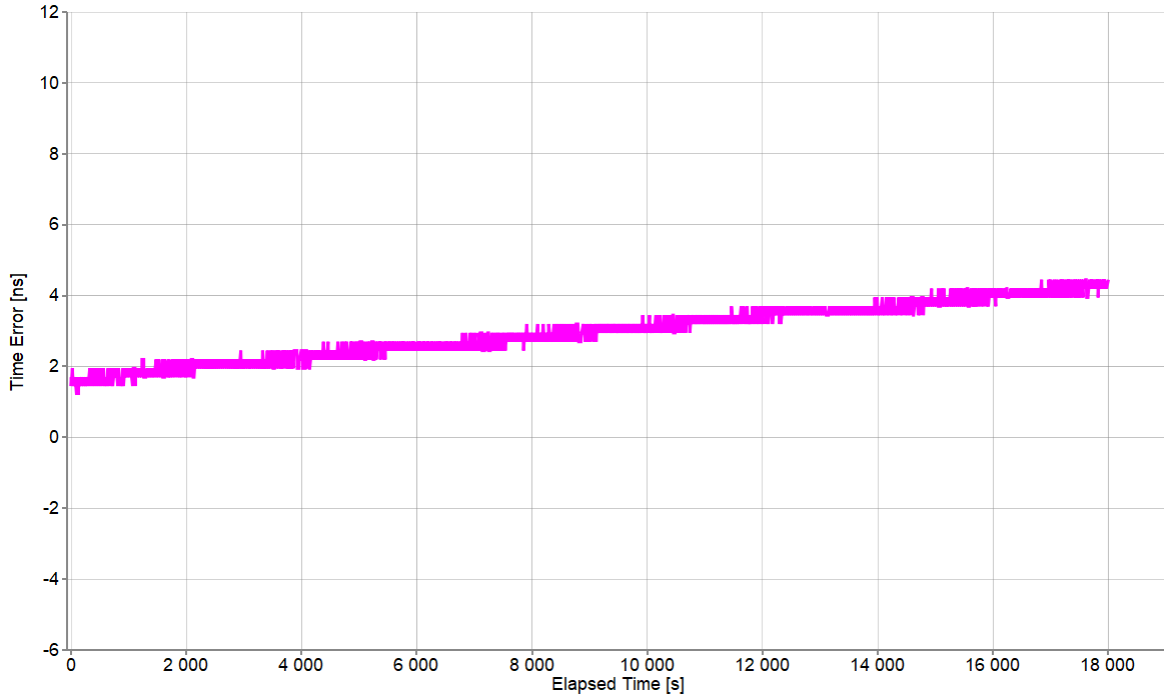

Mean [ns]	2.918
Min [ns]	1.197
Max [ns]	4.447
Max-Min [ns]	3.25

7.1.2 MTIE Analysis

Date: 2024-09-12
 File: Time Error_19-09-2024_08-42-10_HO.csv

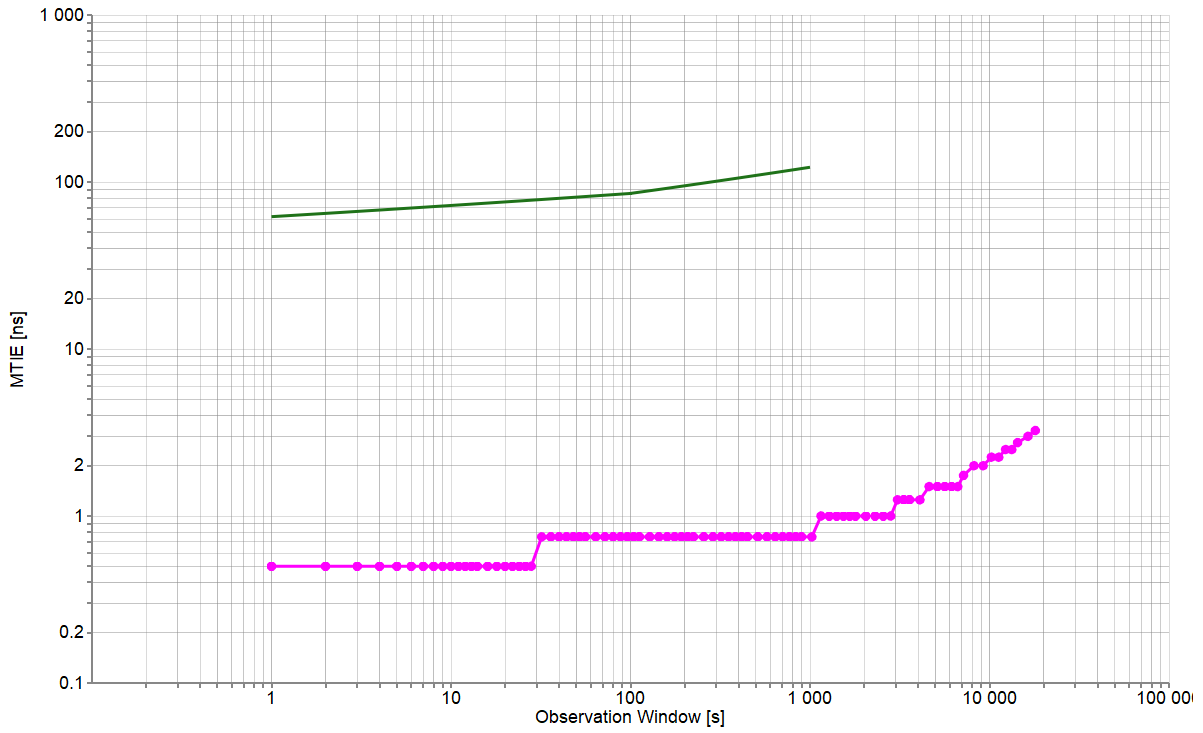

Min [ns]	0.5
Max [ns]	3.25
Max-Min [ns]	2.75

8. G.8273.4 PTS: Noise Tolerance G.8271.2 PDV Pattern

This test checks whether the equipment clock can maintain network limits at the output with maximum noise at the input. The noise tolerance of a clock indicates the minimum time error level at the input of the clock that should be accommodated while:

- not causing any alarms
- not causing the clock to switch reference
- not causing the clock to go into holdover

The level of noise that a PTS device must tolerate on its PTP input is $\max|\text{pktSelected2wayTE}|$ according to the network limit defined in ITU-T G.8271.2 clause 7.3.2.1 at the PTP input.

For this test, the G.8271.2 PDV pattern is applied to the PTP input and the output 1PPS performance is observed. Physical layer assistance (SyncE) is used during this test.

8.1 1PPS Measurements

Test Description	Noise Tolerance G.8271.2 PDV Pattern
Report Date	24-09-19_08-47-41
Packet Rate (pkt/s)	16
Beginning of Test	9/13/2024 1:23:17 PM
Test Duration	16:40:00
Test Configuration	1
Time to Phase Lock (s)	385

All Mask Results	Pass
Mask ONEPPS	1.35 μ s
Mask ONEPPS Result	Pass

8.1.1 ONEPPS Analysis

Offset Removal Applied	Off
Zero Offset	270.947 ns

Date: 2024-09-13
 File: Time Error_19-09-2024_08-44-31.csv
 Offset Removal Applied: False
 Zero Offset: 270.947ns

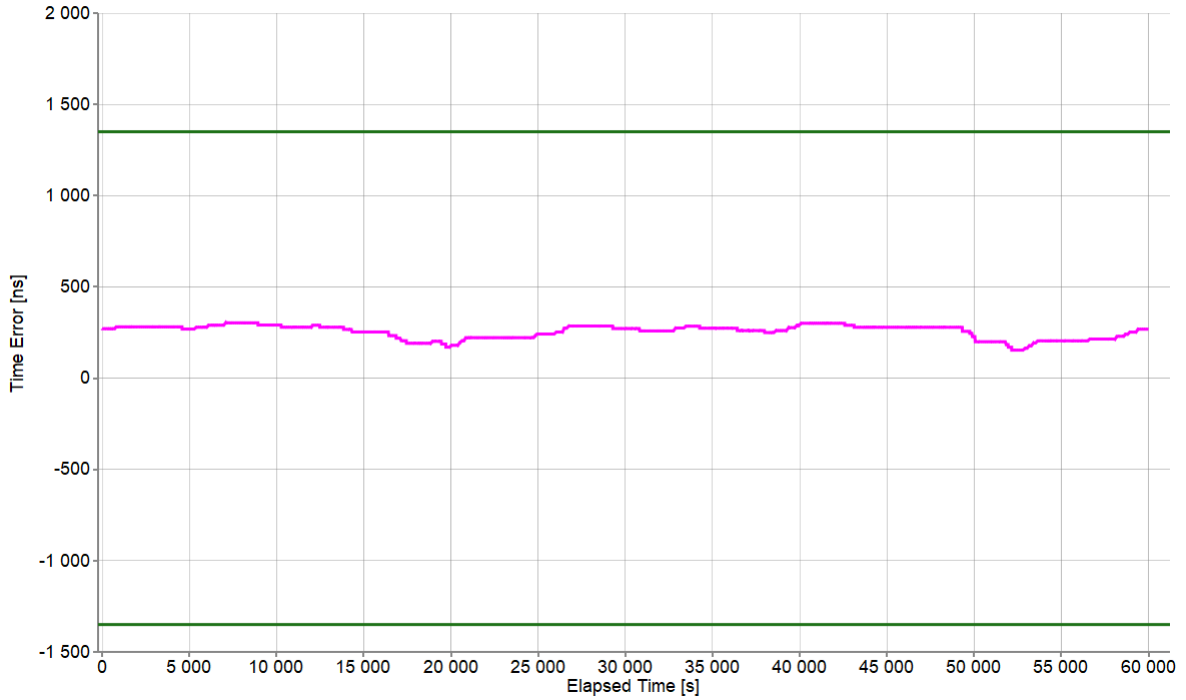

Mean [ns]	255.301
Min [ns]	153.197
Max [ns]	303.197
Max-Min [ns]	150

9. Configuration Files

9.1 TCS File

The TCS file comes loaded with the ZCU670 image: ZCU670_8A34001_10G_2025june17.tcs.

9.2 Ts2phc cfg File

```
#
# ts2phc config file to get it to behave like syncd to align
# timestamper to PHC device's 1 PPS signal.
#
# Example:
# ./ts2phc -m -q -f ts2phc.cfg
#

[global]
clock_servo          nullf
first_step_threshold 0.000000001
step_threshold       0.000000001

# timestamper, slave device
[/dev/ptp1]
ts2phc.channel       0
#ts2phc.extts_correction -12

# PHC device (ex. CM), master device
[/dev/ptp0]
ts2phc.master        1
ts2phc.channel       2
```

9.3 Standalone ptp4l cfg Files

9.3.1 Unicast BC

```
[global]
domainNumber      44

sanity_freq_limit 0

slaveOnly         0
masterOnly        0

# Announce messages
announceReceiptTimeout  2
logAnnounceInterval     1

# Sync/Delay_Req/Delay_Resp messages
# ex. 0 = 1 PPS, -3 = 8 PPS, -4 = 16 PPS
logSyncInterval         -4
logMinDelayReqInterval -4

#
# step_window is in units of sync packets
#
# 3 seconds:
# @ 16 PPS, set to 96
# @ 1 PPS, set to 6
step_window             96

clockClass              248
clockAccuracy            0xFE
timeSource               0xa0
maxStepsRemoved         255

offsetScaledLogVariance 0xffff

G.8275.defaultDS.localPriority 128
G.8275.portDS.localPriority    128

priority1                128
priority2                 255

dataset_comparison       G.8275.x
transportSpecific        0

clock_type                BC
delay_mechanism           E2E

first_step_threshold     0.000020000
step_threshold           0.000020000
tx_timestamp_timeout     1000
```

ZCU670 Unicast Boundary Clock Performance Validation Report

```
write_phase_mode      1
servo_offset_threshold 580
servo_num_offset_values 128
tsproc_mode          raw

network_transport      UDPv4

hybrid_e2e            1
inhibit_multicast_service 1
unicast_listen        1
unicast_req_duration  300

[unicast_master_table]
table_id              1
logQueryInterval     2
UDPv4                 10.64.10.1

[unicast_master_table]
table_id              2
logQueryInterval     2
UDPv4                 10.64.10.2 (Change to 10.64.10.16 for use with ADVA Master)

[eth1]
unicast_master_table  1

[eth2]
unicast_master_table  2
```

9.3.2 Unicast SC (2 Masters)

```
[global]
domainNumber      44

sanity_freq_limit 0

slaveOnly         1
masterOnly        0

# Announce messages
announceReceiptTimeout  2
logAnnounceInterval     1

# Sync/Delay_Req/Delay_Resp messages
# ex. 0 = 1 PPS, -3 = 8 PPS, -4 = 16 PPS
logSyncInterval         -4
logMinDelayReqInterval -4

#
# step_window is in units of sync packets
#
# 3 seconds:
# @ 16 PPS, set to 96
# @ 1 PPS, set to 6
step_window             96

clockClass             255
clockAccuracy          0xFE
timeSource             0xa0
maxStepsRemoved        255

offsetScaledLogVariance 0xffff

G.8275.defaultDS.localPriority 128
G.8275.portDS.localPriority    128

priority1              128
priority2              255

dataset_comparison     G.8275.x
transportSpecific      0

clock_type             OC
delay_mechanism        E2E

first_step_threshold   0.000020000
step_threshold         0.000020000
tx_timestamp_timeout   1000

write_phase_mode       1
servo_offset_threshold 580
servo_num_offset_values 128
```

```
tsproc_mode          raw

network_transport    UDPv4

hybrid_e2e           1
inhibit_multicast_service 1
unicast_listen       1
unicast_req_duration 300

[unicast_master_table]
table_id             1
logQueryInterval     2
UDPv4                10.64.10.1
UDPv4                10.64.10.2

[eth1]
unicast_master_table 1

[eth2]
unicast_master_table 1
```

9.4 External Servo ptp4l cfg Files

9.4.1 Unicast BC

```
#
# PCM4L
#
# Telecom G.8275.2 T-TSC example configuration containing attributes
# which either differ from the defaults or are relevant to the profile.
#
[global]
domainNumber        44

# Announce messages
announceReceiptTimeout 2
logAnnounceInterval  1

# Sync/Delay_Req/Delay_Resp messages
# ex. 0 = 1 PPS, -3 = 8 PPS, -4 = 16 PPS
logSyncInterval      -4
logMinDelayReqInterval -4

slaveOnly            0
masterOnly           0

clockClass           248
clockAccuracy         0xFE
timeSource            0xa0
maxStepsRemoved      255

offsetScaledLogVariance 0xffff

G.8275.defaultDS.localPriority 128
```

ZCU670 Unicast Boundary Clock Performance Validation Report

```
G.8275.portDS.localPriority      128

priority1      128
priority2      255

dataset_comparison      G.8275.x
transportSpecific      0

clock_type      BC
delay_mechanism      E2E

#
# Send timestamps to pcm41
#
free_running      1
slave_event_monitor      /var/run/pcm41
tsproc_mode      raw
tx_timestamp_timeout      5
sanity_freq_limit      0

network_transport      UDPv4

hybrid_e2e      1
inhibit_multicast_service      1
unicast_listen      1
unicast_req_duration      300

[unicast_master_table]
table_id      1
logQueryInterval      2
UDPv4      10.64.10.1

[unicast_master_table]
table_id      2
logQueryInterval      2
UDPv4      10.64.10.2

[eth1]
unicast_master_table      1

[eth2]
unicast_master_table      2
```

9.4.2 Unicast SC (2 Ports)

```
#
# PCM4L
#
# Telecom G.8275.2 T-TSC example configuration containing attributes
# which either differ from the defaults or are relevant to the profile.
#
[global]
domainNumber      44

# Announce messages
announceReceiptTimeout  2
logAnnounceInterval    1

# Sync/Delay_Req/Delay_Resp messages
# ex. 0 = 1 PPS, -3 = 8 PPS, -4 = 16 PPS
logSyncInterval        -4
logMinDelayReqInterval -4

slaveOnly      1
masterOnly     0

clockClass      255
clockAccuracy   0xFE
timeSource      0xa0
maxStepsRemoved 255

offsetScaledLogVariance 0xffff

G.8275.defaultDS.localPriority 128
G.8275.portDS.localPriority    128

priority1      128
priority2      255

dataset_comparison      G.8275.x
transportSpecific       0

clock_type      OC
delay_mechanism E2E

#
# Send timestamps to pcm4l
#
free_running      1
slave_event_monitor  /var/run/pcm4l
tsproc_mode       raw
tx_timestamp_timeout  5
sanity_freq_limit  0

network_transport      UDPv4

hybrid_e2e            1
```

```
inhibit_multicast_service      1
unicast_listen                  1
unicast_req_duration            300
```

```
[unicast_master_table]
table_id                        1
logQueryInterval                2
UDIPv4                          10.64.10.1
UDIPv4                          10.64.10.2
```

```
[eth1]
unicast_master_table           1
```

```
[eth2]
unicast_master_table           1
```

9.5 Pcm4l json File

9.5.1 Write Phase (FTS/G.8273.2)

```
{
  "versionId": "4.3",
  "testModeEnable": 0,
  "referenceTrackerType": "WritePhase",
  "remoteUdsAddress": "/var/run/ptp4l",
  "localUdsAddress": "/var/run/pcm4l",

  "stepWindowSeconds": 1,

  "phc4lConfig":
  {
    "dcoDevice": "/dev/ptp0",
    "tsDevice":
    [
      {
        "tsDeviceName": "/dev/ptp1",
        "tsDevicePinIndex": -1,
        "tsDeviceExtttsChannel": 0,
        "tsDeviceExtttsCorrectionNs": 0
      }
    ],
    "charDevice": "/dev/rsmu0",

    "phaseSnapDelaySeconds": 3,
    "tsCalibrationEnable": 0
  },

  "deviceConfig":
  {
    "oscillatorType": "Tcxo",
    "dpll1588Instance": 1,
    "tsDeviceAlignmentDisable": 0,
    "holdover":
    {
```

```

        "holdoverType": "HardwareEnhanced",
        "holdoverLossPhysicalOosEnable": 0,
        "holdoverTimeoutSeconds": 1000,
        "holdoverQualificationSeconds": 1000,
        "unqualifiedTimeoutSeconds": 10000,
        "outOfSpecUserDefinedFrequencyOffsetEnable": 0,
        "outOfSpecUserDefinedFrequencyOffsetPpb": 0
    }
},

"profileConfig":
{
    "physicalPllClockCategory": 4,
    "physicalPllClockCategoryThreshold": 1,
    "physicalPllInstance": 0,
    "physicalPllWaitToRestoreTimeoutValue": 10
},

"loggerConfig":
{
    "stdoutLog":
    {
        "enable": 1,
        "selectionMask": "0000000000111111",
        "_description_": "          | |||||__ 0: Sync error      ",
        "_description_": "          | |||||__ 1: Sync warning     ",
        "_description_": "          | ||||__ 2: Sync analysis      ",
        "_description_": "          | |||__ 3: Error                ",
        "_description_": "          | ||__ 4: Warning              ",
        "_description_": "          | |__ 5: Debug                 ",
        "_description_": "          |__ 7: Timestamp              "
    },

    "externalFdLog":
    {
        "enable": 0,
        "selectionMask": "0000000000111111",
        "_description_": "          | |||||__ 0: Sync error      ",
        "_description_": "          | |||||__ 1: Sync warning     ",
        "_description_": "          | ||||__ 2: Sync analysis      ",
        "_description_": "          | |||__ 3: Error                ",
        "_description_": "          | ||__ 4: Warning              ",
        "_description_": "          | |__ 5: Debug                 ",
        "_description_": "          |__ 7: Timestamp              "
    }
},

"instanceConfig":
[
    {
        "correctionFieldEnable": 1,
        "lostMasterTimeoutMilliseconds": 2000,
        "manageClockClassExtendedEnable": 0,
    }
]

```

```
    "numberOfTrackerInstances": 1,  
    "trackerConfig":  
    {  
      "delayAsymmetryNanoseconds": 0,  
      "phaseSnapThresholdSeconds": 0.00001,  
      "floorDelayEstimateSeconds": -1.0,  
      "__timeLockThresholdNanoseconds": "Set to 200 to meet enhanced SyncE  
limits",  
      "timeLockThresholdNanoseconds": 580,  
      "willCorrectFrequencyAtFirstSnap": 1,  
      "frequencyLockThresholdPpb": 16.0,  
      "lockFilterWindowLengthSeconds": 1.0  
    }  
  }  
]  
}
```

9.5.2 Adaptive Time (PTS/G.8273.4)

```
{  
  "versionId": "4.3",  
  "testModeEnable": 0,  
  "referenceTrackerType": "AdaptiveTime",  
  "remoteUdsAddress": "/var/run/ptp4l",  
  "localUdsAddress": "/var/run/pcm4l",  
  
  "stepWindowSeconds": 1,  
  
  "phc4lConfig":  
  {  
    "dcoDevice": "/dev/ptp0",  
    "tsDevice":  
    [  
      {  
        "tsDeviceName": "/dev/ptp1",  
        "tsDevicePinIndex": -1,  
        "tsDeviceExtttsChannel": 0,  
        "tsDeviceExtttsCorrectionNs": 0  
      }  
    ],  
    "charDevice": "/dev/rsmu0",  
  
    "phaseSnapDelaySeconds": 3,  
    "tsCalibrationEnable": 0  
  },  
  
  "deviceConfig":  
  {  
    "oscillatorType": "Tcxo",  
    "dpll1588Instance": 1,  
    "tsDeviceAlignmentDisable": 0,  
    "holdover":  
    {
```

ZCU670 Unicast Boundary Clock Performance Validation Report

```
    "holdoverType": "Software",
    "holdoverLossPhysicalOosEnable": 0,
    "holdoverTimeoutSeconds": 1000,
    "holdoverQualificationSeconds": 1000,
    "unqualifiedTimeoutSeconds": 10000,
    "outOfSpecUserDefinedFrequencyOffsetEnable": 0,
    "outOfSpecUserDefinedFrequencyOffsetPpb": 0
  }
},

"profileConfig":
{
  "__physicalPllClockCategory": "Initial value: No SyncE use 5, with SyncE use
4",
  "physicalPllClockCategory": 4,
  "physicalPllClockCategoryThreshold": 1,
  "physicalPllInstance": 0,
  "physicalPllWaitToRestoreTimeoutValue": 10
},

"loggerConfig":
{
  "stdoutLog":
  {
    "enable": 1,
    "selectionMask": "0000000000111111",
    "_description_": "      | |||||__ 0: Sync error      ",
    "_description_": "      | |||||__ 1: Sync warning     ",
    "_description_": "      | ||||__ 2: Sync analysis    ",
    "_description_": "      | |||__ 3: Error              ",
    "_description_": "      | ||__ 4: Warning             ",
    "_description_": "      | |__ 5: Debug                ",
    "_description_": "      |__ 7: Timestamp              "
  },

  "externalFdLog":
  {
    "enable": 0,
    "selectionMask": "0000000000111111",
    "_description_": "      | |||||__ 0: Sync error      ",
    "_description_": "      | |||||__ 1: Sync warning     ",
    "_description_": "      | ||||__ 2: Sync analysis    ",
    "_description_": "      | |||__ 3: Error              ",
    "_description_": "      | ||__ 4: Warning             ",
    "_description_": "      | |__ 5: Debug                ",
    "_description_": "      |__ 7: Timestamp              "
  }
},

"instanceConfig":
[
  {
    "instanceEnable": 1,
```

```
"correctionFieldEnable": 1,
"lostMasterTimeoutMilliseconds": 2000,
"manageClockClassEnable": 1,
"manageClockClassExtendedEnable": 0,
"ptpDomainNumber": -1,
"numberOfTrackerInstances": 1,

"trackerConfig":
{
  "delayAsymmetryNanoseconds": 0,
  "floorDelayEstimateSeconds": -1.0,
  "willCorrectFrequencyAtFirstSnap": 0,
  "minExpProportionForMinTracking": 0.12,

  "stationarityBounds":
  {
    "measureLower": 0.4,
    "measureUpper": 2.5
  },

  "maxNumberOfPhaseSnap": 1,
  "doubleDcoThresholdNanoseconds": 600,
  "phaseSnapThresholdSeconds": 0.00001,
  "rerouteFloorDelayThresholdSeconds": 0.000002,
  "rerouteAbnormalTodChangePpb": 20,
  "highPrecisionFrequencyCorrectionTimeMinutes": 6,

  "pdvThreshold":
  {
    "downlink": -20,
    "uplink": -20
  },

  "pdvThresholdExceededHysteresis":
  {
    "downlink": 1,
    "uplink": 1
  },

  "snapTransitionTimestamps": 4,

  "dcoLoopFilter":
  {
    "minResponseTimeSeconds": 100,
    "maxFfoCorrection": 5,
    "integralBranchGain": 0.2,
    "bandwidthScalar": 0.5
  },

  "desiredPrecisionSeconds": 0.0000001,
  "frequencyLockThresholdPpb": 15.0,
  "timeLockThresholdNanoseconds": 2450,
  "ffoSlopeLimitPpbPerSecond": -1
```

```
    }  
  }  
]  
}
```

9.6 Synced cfg File

```
#  
# Global parameters  
#  
[global]  
net_opt 1  
no_ql_en 0  
synce_forced_ql_en 1  
lo_ql SEC  
lo_pri 255  
max_msg_lvl 6  
stdout_en 1  
syslog_en 0  
# Device configuration file path (applicable for generic device)  
device_cfg_file ""  
device_name /dev/rsmu0  
synce_dp11_idx 0  
holdover_ql SEC  
holdover_tmr 10  
hoff_tmr 300  
wtr_tmr 10  
advanced_holdover_en 0  
pcm41_if_en 1  
pcm41_if_ip_addr 127.0.0.1  
pcm41_if_port_num 2400  
mng_if_en 1  
mng_if_ip_addr 127.0.0.2  
mng_if_port_num 2401  
  
#  
# Sync-E clock port  
#  
[eth1]  
clk_idx 1  
pri 1  
tx_en 1  
rx_en 1  
tx_bundle_num -1  
init_ql SEC  
  
[eth2]  
#clk_idx 1  
pri 2  
tx_en 1  
rx_en 1  
tx_bundle_num -1  
init_ql SEC
```

10. Revision History

Revision	Date	Description
1.01	Sep 16, 2025	Updated Configuration Files section to reflect new recommended values for ZCU670.
1.00	Dec 10, 2024	Initial release.

IMPORTANT NOTICE AND DISCLAIMER

RENESAS ELECTRONICS CORPORATION AND ITS SUBSIDIARIES (“RENESAS”) PROVIDES TECHNICAL SPECIFICATIONS AND RELIABILITY DATA (INCLUDING DATASHEETS), DESIGN RESOURCES (INCLUDING REFERENCE DESIGNS), APPLICATION OR OTHER DESIGN ADVICE, WEB TOOLS, SAFETY INFORMATION, AND OTHER RESOURCES “AS IS” AND WITH ALL FAULTS, AND DISCLAIMS ALL WARRANTIES, EXPRESS OR IMPLIED, INCLUDING, WITHOUT LIMITATION, ANY IMPLIED WARRANTIES OF MERCHANTABILITY, FITNESS FOR A PARTICULAR PURPOSE, OR NON-INFRINGEMENT OF THIRD-PARTY INTELLECTUAL PROPERTY RIGHTS.

These resources are intended for developers who are designing with Renesas products. You are solely responsible for (1) selecting the appropriate products for your application, (2) designing, validating, and testing your application, and (3) ensuring your application meets applicable standards, and any other safety, security, or other requirements. These resources are subject to change without notice. Renesas grants you permission to use these resources only to develop an application that uses Renesas products. Other reproduction or use of these resources is strictly prohibited. No license is granted to any other Renesas intellectual property or to any third-party intellectual property. Renesas disclaims responsibility for, and you will fully indemnify Renesas and its representatives against, any claims, damages, costs, losses, or liabilities arising from your use of these resources. Renesas' products are provided only subject to Renesas' Terms and Conditions of Sale or other applicable terms agreed to in writing. No use of any Renesas resources expands or otherwise alters any applicable warranties or warranty disclaimers for these products.

(Disclaimer Rev.1.01)

Corporate Headquarters

TOYOSU FORESIA, 3-2-24 Toyosu,
Koto-ku, Tokyo 135-0061, Japan
www.renesas.com

Trademarks

Renesas and the Renesas logo are trademarks of Renesas Electronics Corporation. All trademarks and registered trademarks are the property of their respective owners.

Contact Information

For further information on a product, technology, the most up-to-date version of a document, or your nearest sales office, please visit www.renesas.com/contact-us/.