

Technical Data of Ceramic Resonator

MURATA Part No.: CSTCE8M00G55A-R0

Applied to R5F21348EJFP;CM11=0

Murata's recommendation 推奨回路定数

IC name	IC名	R5F21348EJFP;CM11=0
Parts Number	品番	CSTCE8M00G55A-R0
C ₁ , C ₂ [pF]	負荷容量	33 pF
R _f [ohm]	帰還抵抗	No mount
R _d [ohm]	制限抵抗	Short
Supply Voltage Range[V]	電源電圧範囲	2.7 to 5.5 V
Temp. Range [deg.C]	温度範囲	-40 to +125deg.C

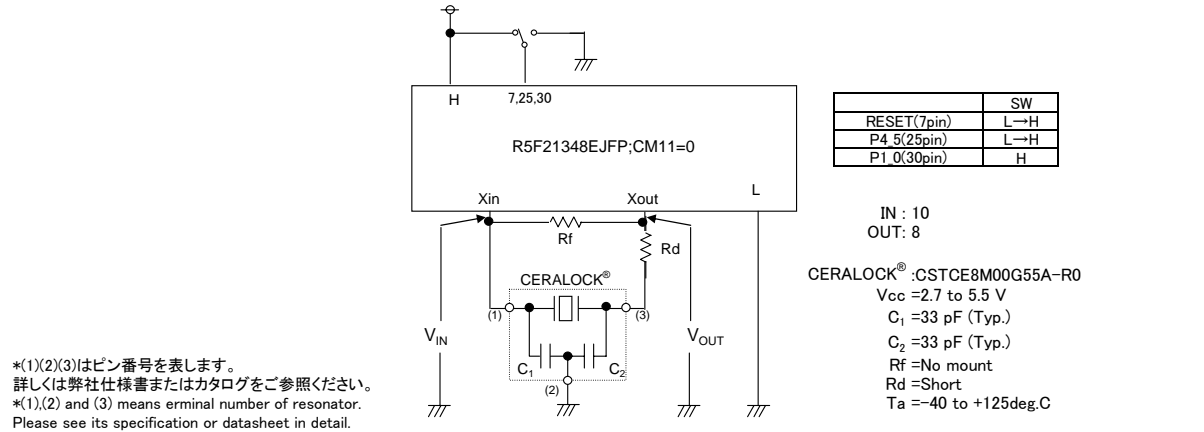
Characteristics of Oscillation Circuit 発振回路特性

Characteristics 特性	Value 測定値	Criterion 基準	Notes 備考
Oscillating Voltage 発振電圧 (V _{cc} =5V, 25deg.C) (V _{cc} =1.6V)	Typical sample 標準品	VIH 1.7 [V]	≤ 1.9V Input high voltage 発振入力電圧High側レベル
		VIL -0.2 [V]	≥ -0.3V Input low voltage 発振入力電圧Low側レベル
		VOH 1.6 [V]	Output high voltage 発振出力電圧High側レベル
		VOL -0.1 [V]	Output low voltage 発振出力電圧Low側レベル
	R1 limit sample R1規格限界品(*1)	V _I p-p 1.6 [V]	≥ 0.4 x V _{cc} (≥ 0.64V) Swing level at input side 発振入力振幅 (VIH - VIL)
	V _O p-p 1.7 [V]	Swing level at output side 発振出力振幅 (VOH - VOL)	
Starting Voltage 発振開始電圧 (-40 to +125deg.C)	Typical sample 標準品	1.6 [V]	≤ 2.7V Lowest supply voltage for oscillation start
	R1 limit sample R1規格限界品(*1)	1.6 [V]	発振回路が動作を始める最低電源電圧
Oscillation Start up Time 発振立ち上がり時間(*2) (Typical sample at V _{cc} =5V,25deg.C)	0.03 [ms]		Time to reach 90% of the oscillation level under steady state 定常状態の発振振幅の90%に達するまでの時間
Frequency Correlation 発振周波数相関(*3) (Typical sample at V _{cc} =5V,25deg.C)	Less than 0.1 [%]		Oscillating frequency correlation against our standard IC 当社標準回路に対する発振周波数ずれ量

*1 R1: Resonant impedance. "R1 limit sample" means R1 resistance of applied sample is equal as its R1 spec.

R1は発振子の共振抵抗を意味します。R1規格限界品とは、適用する発振子の共振抵抗値が、その規格値まで低下した状態のサンプルとなります。

*2 The measurement results is affected by the rise-up characteristics of supplied voltage on your PCB. Please refer to appendix 1.
測定結果は実装基板の電源立ち上がり特性の影響を受けます。添付資料1をご参照下さい。

*3 Frequency correlation means the oscillating frequency difference between your PCB and Murata frequency sorting circuit with standard IC.

Please refer to appendix 2.

貴社基板と当社標準回路では、同一発振子を使用した場合でも発振周波数の差が生じます。これを発振周波数相関と呼びます。添付資料2をご参照下さい。

< Characteristics to Check 判定項目 >

Characteristics 特性	Requirements 条件	Criterion 基準
1. Oscillating Waveform 発振波形	* As close as possible to a sine wave 正弦波に近いこと * No distortion around V _{th} level of IC ICのスレッショレベル付近で歪みなきこと	No distortion from 0.3xV _{dd} to 0.7xV _{dd}
2. Oscillating Voltage 発振電圧	* Oscillating Voltage is not too large 発振振幅が大き過ぎないこと * Oscillating Voltage is enough with limit sample R1規格限界品での発振振幅が十分であること	- Supply voltage 電源電圧 > 3.3V -0.7V ≤ V _{IL} , V _{IH} ≤ V _{dd} +0.7V, V _I p-p ≥ 0.4xV _{dd} - Supply voltage 電源電圧 ≤ 3.3V -0.3V ≤ V _{IL} , V _{IH} ≤ V _{dd} +0.3V, V _I p-p ≥ 0.4 x V _{dd}
3. Starting Voltage 発振開始電圧	* Meet customer requirements 電源電圧範囲の要求値を満たすこと	Maximum Starting Voltage +0.1 ≤ Minimum Voltage Range (your request)
4. Rise Time and Transient Waveform 発振立ち上がり波形	* No irregular oscillation waveform overlapping 異常発振無きこと	

Test Data

Oscillation waveform data on recommendable circuit condition

MODEL: CSTCE8M00G55A-R0 with R5F21348EJFP;CM11=0

Typical sample

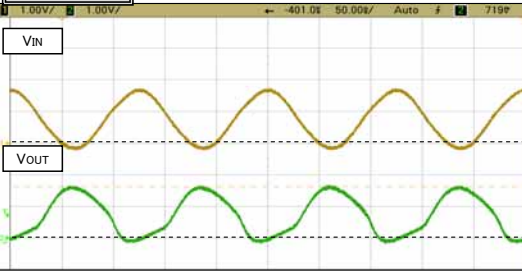

V _{IH}	V _{IL}	V _{Ip-p}	V _{OH}	V _{OL}	V _{Op-p}
1.7	-0.2	1.8	1.6	-0.1	1.8

[V]

Limit sample (R1= 40[ohm max])

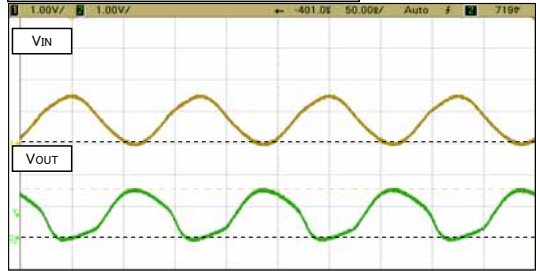

V _{IH}	V _{IL}	V _{Ip-p}	V _{OH}	V _{OL}	V _{Op-p}
1.5	-0.1	1.6	1.6	-0.1	1.7

[V]

Typical sample at V_{cc}=5V,25deg.C Vertical: 1V/div., Horizontal: 50ns/div.
Broken line: GND

Oscillation start up waveform on recommendable circuit condition

MODEL: CSTCE8M00G55A-R0 with R5F21348EJFP;CM11=0

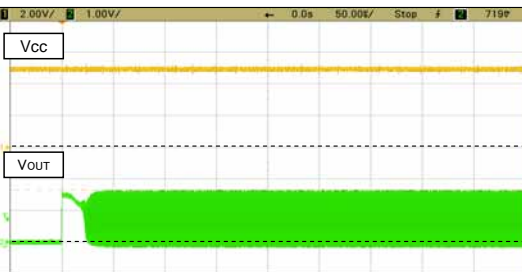

Typical sample at V_{cc}=5V,25deg.C
[V_{cc}] Vertical: 2V/div., Horizontal: 50μs/div.
[V_{out}] Vertical: 2V/div., Horizontal: 50μs/div.
Broken line: GND

Test Data

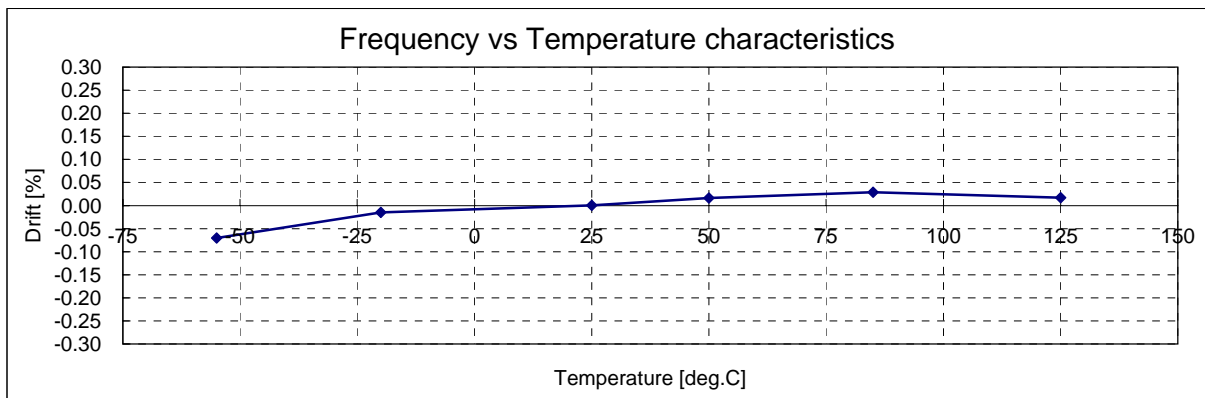

Typical sample at Vcc=5V

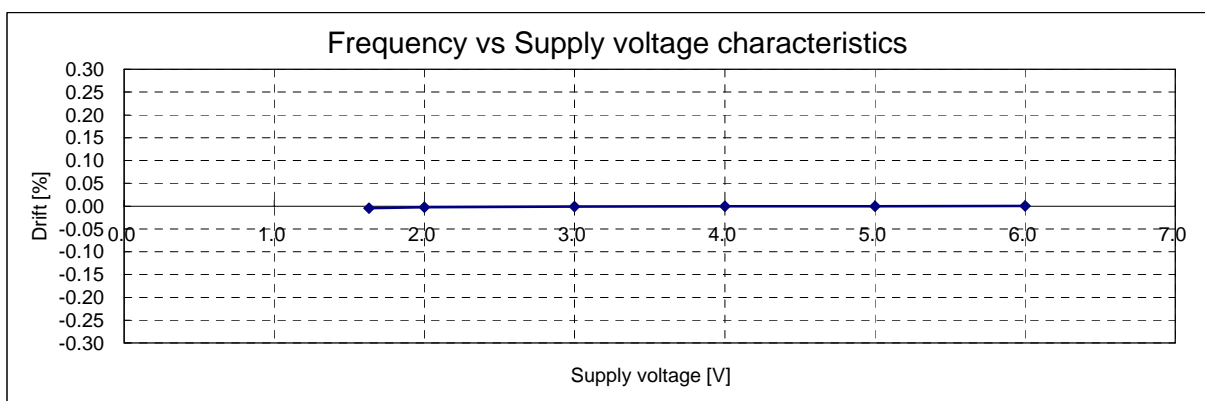

Typical sample at 25deg.C

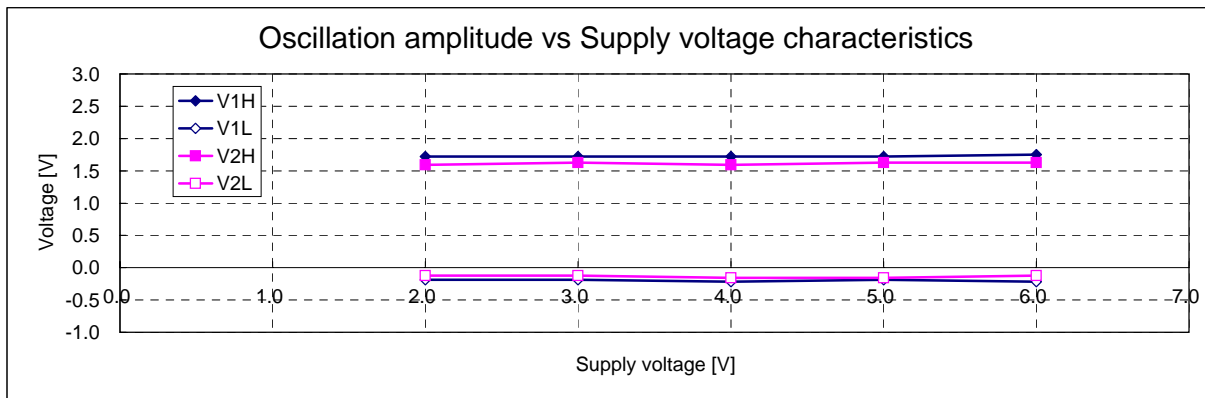

Typical sample at 25deg.C

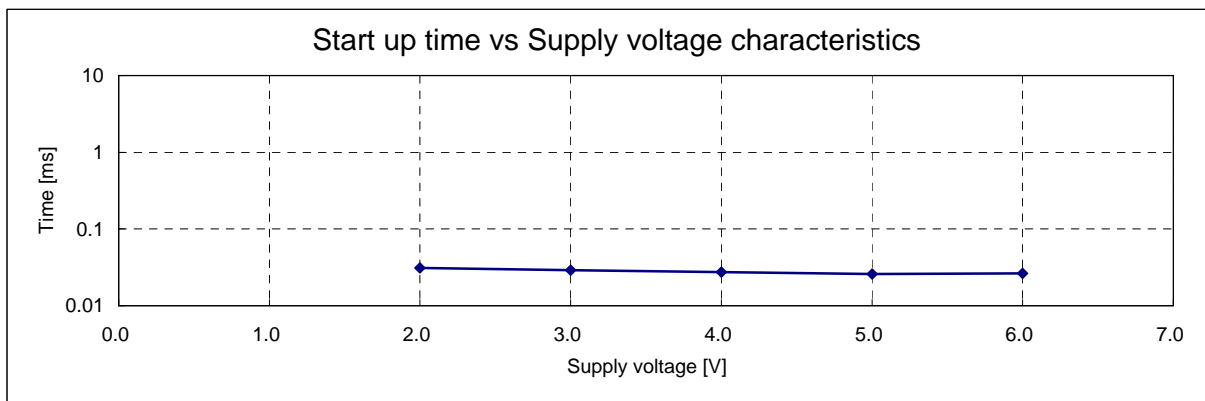

Typical sample at 25deg.C

Appendix 1 : Rise Time 発振立ち上がり時間

“Rise time” is defined as the time to reach 90% of the oscillation level under steady state conditions as shown below figure.

発振立ち上がり時間は、電源電圧(Vdd, Vsetなど)が印加された瞬間から、発振振幅が定常状態振幅の90%に達するまでの時間として定義されます。

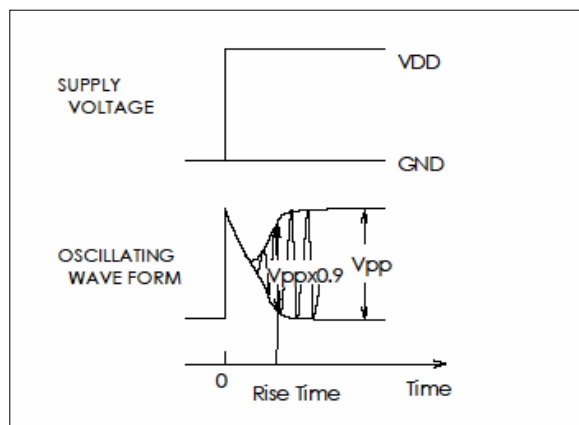

In the case that rising time of supplied voltage (Vdd or Vset) is slower than that of resonator, resonator's rise time depends on that of power supply.

In the case that reset function is applied to the circuit, resonator's rise time also depends on that of this function.

In these cases, it is unable to measure the correct rise time of resonator itself.

搭載されているバイパスコンデンサによりVdd(Vset)の立ち上がり時間が発振子の立ち上がり時間と比較して遅い場合、発振子の立ち上がり時間はVdd(Vset)の立ち上がり時間に依存して遅くなります。

また、Vdd(Vset)が印加されてから発振回路に電圧が印加されるまでにリセット時間などが設定されている場合、やはり発振立ち上がり時間は遅くなります。

このような場合、発振子本来の立ち上がり時間を測定することはできませんので、予めご了承下さい。

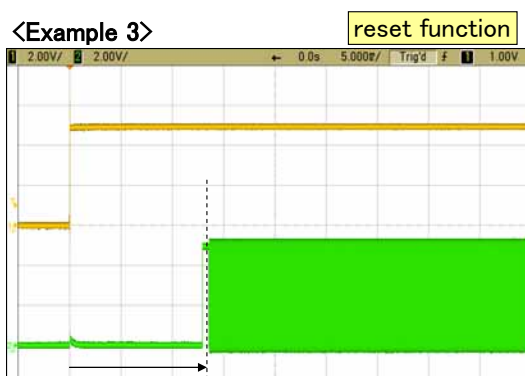
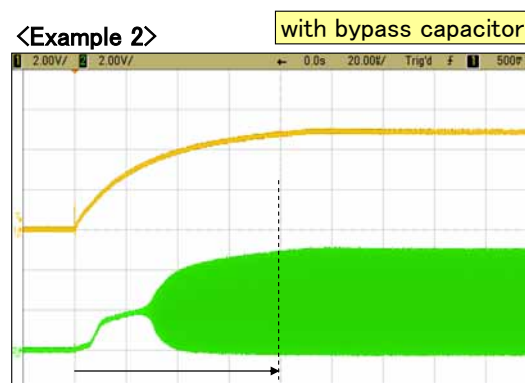
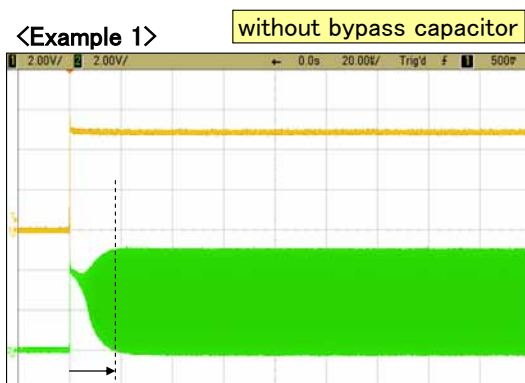

Appendix 2 : Frequency correlation 発振周波数相関

Oscillating frequency differs on your PCB and on Murata frequency sorting circuit because IC and PCB are different. We call this difference as "Frequency correlation".

We usually report "Frequency correlation" value in our IC evaluation report. If you require tighter frequency tolerance than the standard spec. of our resonator, we would like to offer a customized part number with frequency adjusted on your PCB.

In this case, please let us measure the "Frequency correlation" on your final PCB.

ある1つの発振子を使用したとしても、ICや基板の違いにより、実際にお使いになられる基板と当社標準回路との間には、発振周波数の差が存在します。当社ではこれを"発振周波数相関"と呼びます。

通常、"発振周波数相関"値はICマッチングレポートにて報告しております。当社発振子の標準的な規格に対してより発振周波数精度を必要とされる場合には、貴社基板に対して発振周波数を合わせこんだカスタム品を提案させて頂きたいと存じます。

この場合、"発振周波数相関"を確認する為に設計の完了した基板をご準備頂くようお願いさせていただくことがありますので、予めご了承下さい。

Please see below figure for your reference about oscillation frequency and frequency correlation.

発振周波数と周波数相関に関して、以下の図をご参照下さい。

<Actual oscillation frequency 実際の発振周波数>

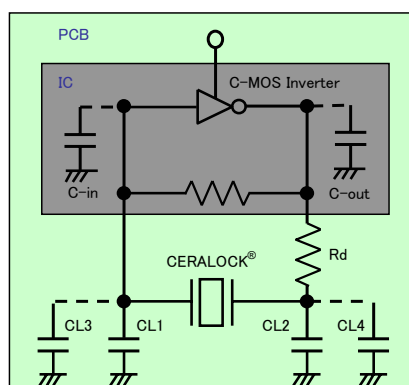

Equation of Oscillation Frequency 発振周波数の近似式

$$F_{osc} = Fr \sqrt{1 + \frac{C_1}{C_0 + C_L}}$$

F_{osc} : Oscillation Frequency 発振周波数

Fr : Resonant Frequency of Ceramic Resonator 発振子の共振周波数

C_1 : Equivalent Series Capacitance 等価直列容量

C_0 : Equivalent Parallel Capacitance 等価並列容量

$$C_L = \frac{(C_{L1} + C_{L3} + C_{in}) \cdot (C_{L2} + C_{L4} + C_{out})}{(C_{L1} + C_{L3} + C_{in}) + (C_{L2} + C_{L4} + C_{out})}$$

$CL3, CL4$: Stray Capacitance of PCB 実装基板の寄生容量

C_{in}, C_{out} : Input/Output Capacitance of IC ICの入出力容量

Used IC and PCB have effect on the actual oscillation frequency.
ご使用のICや基板は実際の発振周波数に影響を与えます。

<Frequency correlation 発振周波数相関>

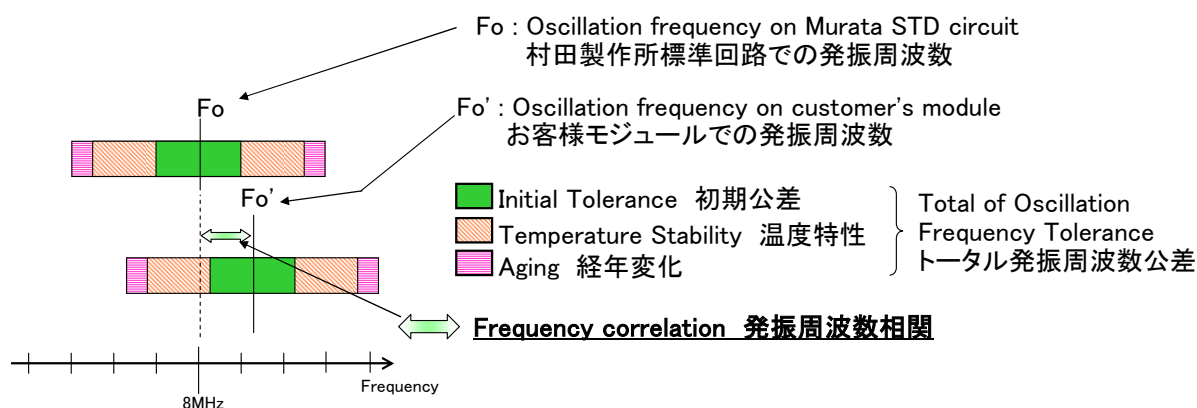

To meet required oscillation frequency tolerance, we would like to offer customized part number with frequency adjusted on your final PCB.

標準的な発振周波数公差よりもより狭い公差をご希望の場合には、ご使用になられる実装基板にて発振周波数を調整したカスタム品をご提案させていただいております。

■ Test Data

Comparison Table

IC No.	V1H [V]	V1L [V]	V1p-p [V]	V2H [V]	V2L [V]	V2p-p [V]	Fosc [kHz]	T-rise [ms]	Vstart [V]
ES1	1.72	-0.19	1.91	1.63	-0.16	1.78	8008.481	0.026	1.63
HH	1.72	-0.19	1.91	1.59	-0.13	1.72	8009.107	0.039	1.59
HL	1.69	-0.22	1.91	1.59	-0.16	1.75	8008.031	0.032	1.59
LH	1.72	-0.19	1.91	1.66	-0.16	1.81	8009.355	0.029	1.59
LL	1.69	-0.19	1.88	1.63	-0.16	1.78	8008.289	0.026	1.58
LT	1.72	-0.19	1.91	1.63	-0.13	1.75	8008.863	0.028	1.57
ST	1.69	-0.19	1.88	1.63	-0.13	1.75	8009.164	0.034	1.60

Performance described in this document were measured with IC No. ES1

Frequency Correlation Data

Sample No.	R5F21348EJFP;CM11=0 Fosc [kHz]	TC74HCU04 x2 Fosc [kHz]	Shift [%]
1	8011.36	8009.40	0.02
2	8009.87	8008.70	0.01
3	8009.62	8008.40	0.02
4	8009.32	8008.90	0.01
5	7994.31	7992.60	0.02
Ave.	8006.90	8005.60	0.02

muRata Standard Circuit

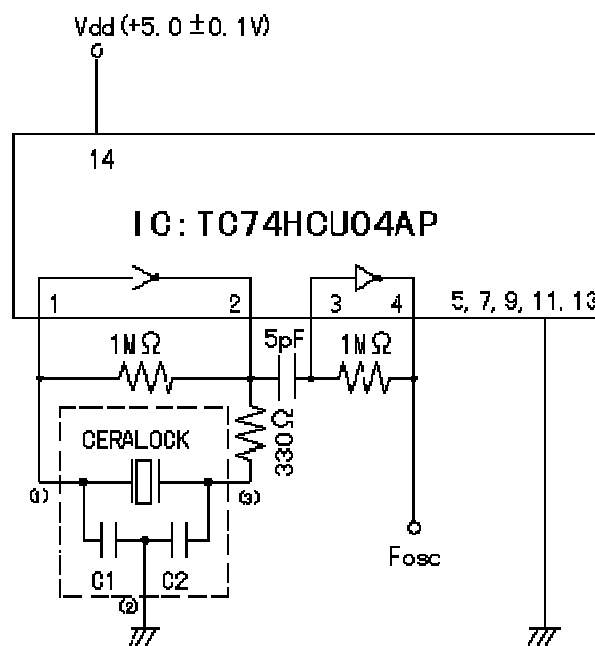

*(1)(2)(3)はピン番号を表します。
詳しくは弊社仕様書またはカタログをご参照ください。
*(1),(2) and (3) means terminal number of resonator.
Please see its specification or datasheet in detail.

CERALOCK[®]: CSTCE8M00G55A-R0

Vdd = +5V
C1 = 33pF
C2 = 33pF
Rf = 1M [ohm]
Rd = 330 [ohm]