

Technical Data of Ceramic Resonator

MURATA Part No.: CSTCC2M00G56-R0

Applied to R5F21256SNFP(High)



***TOYAMA MURATA MANUFACTURING CO., LTD.***

Product Engineering Service Section VI

Piezoelectric Components Department I

Piezoelectric Components Division

Device Business Unit

Approved by	Checked by	Issued by	Issued Date	Data No.
 K.Maruno	 R.Miyamae	 T.Morita	Jul 6, 2006	TCD-06-1382

## Contents

1.	Test Circuit	1
2.	Temperature Characteristics of Oscillating Frequency, Oscillating Voltage	2
3.	Rise Time, Oscillating Frequency, Oscillating Voltage vs Vcc Characteristics	3
4.	Oscillating Frequency, Oscillating Voltage, Rise Time, Starting Voltage vs Rd Characteristics	4

### Note : Rise Time

"Rise time" is defined as the time when oscillation voltage reaches 90% of full voltage swing after Vdd(Vset) is supplied.

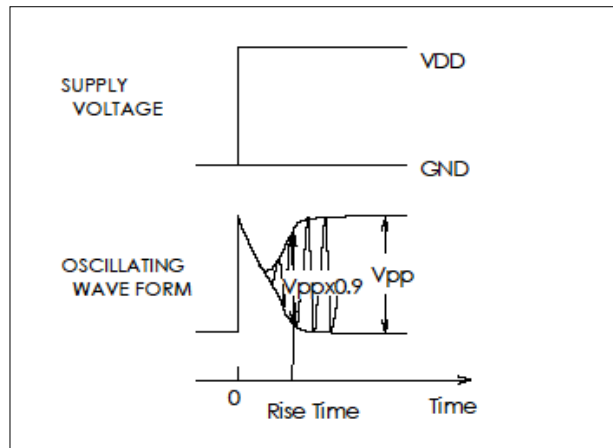

In the case that rising time of Vdd(Vset) is slow comparing to resonator's rise time due to the bypass capacitor, resonator's rise time is also slow because it depends on rising time of Vdd(Vset).

Also, in the case that the time supplying voltage to the oscillator circuit takes a certain time by reset time etc after Vdd(Vset) is applied, resonator's rise time is also slow.

In these case, we will describe "Unable to measure" in rise time data, because we can not measure resonator's rise time correctly.

Test Circuit

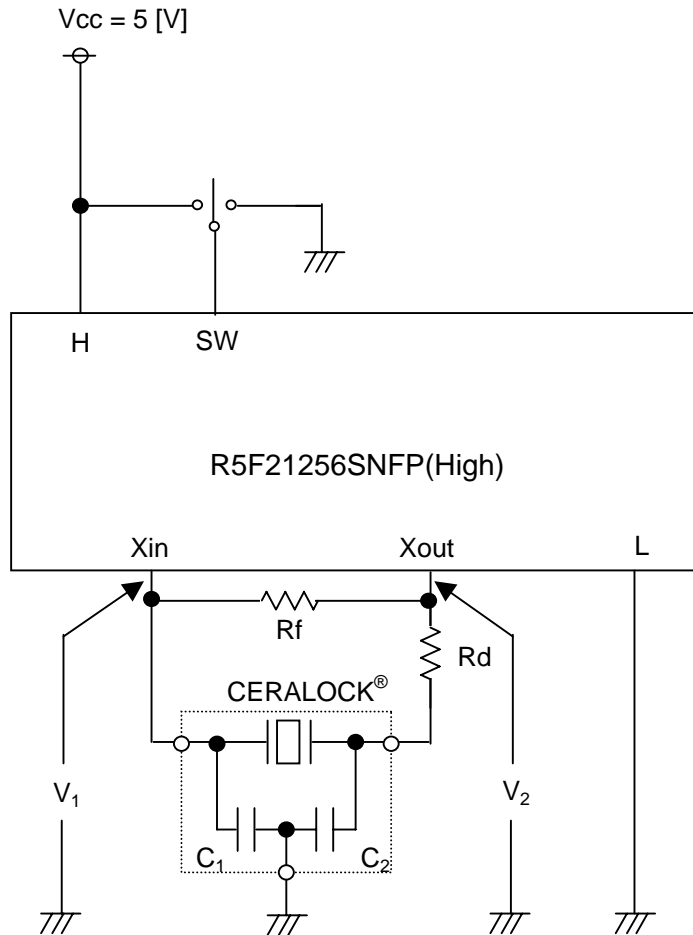

SEL	RESET 8pin	P1_7/TRAI0/INT1 21pin	P4_5/INTO 27pin
SW	L→H	H	H→L

Xin : 11  
 Xout: 9  
 H : 5, 12  
 L : 10

Recommended Value

CERALOCK<sup>®</sup> : CSTCC2M00G56-R0

Vcc = 2.2 to 5.5 [V]

C1 = 47 [pF] (Typ.)

C2 = 47 [pF] (Typ.)

Rf = 1 [Mohm]

Rd = 1 [kohm]

Ta = -40 to 85 [°C]

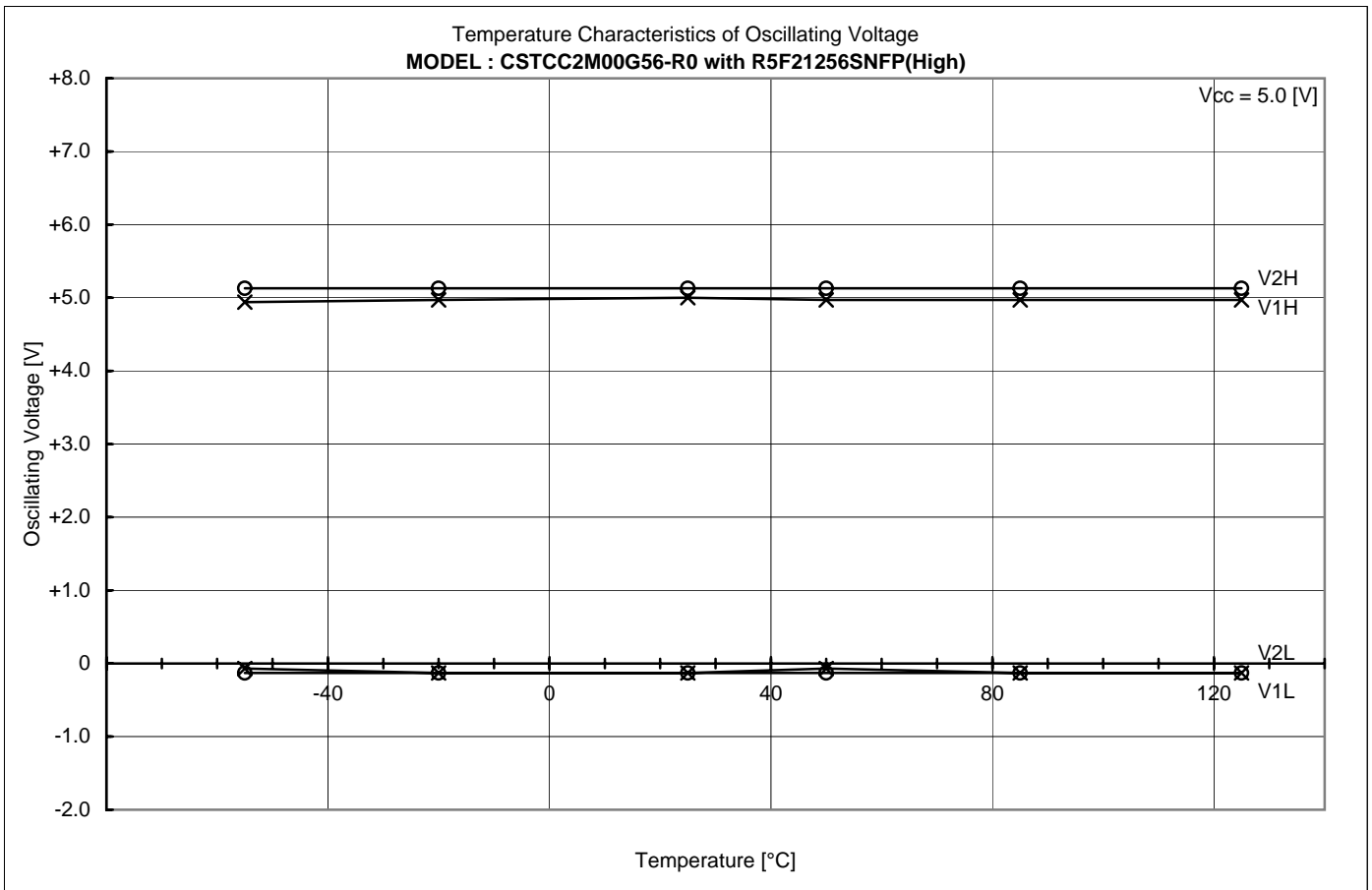
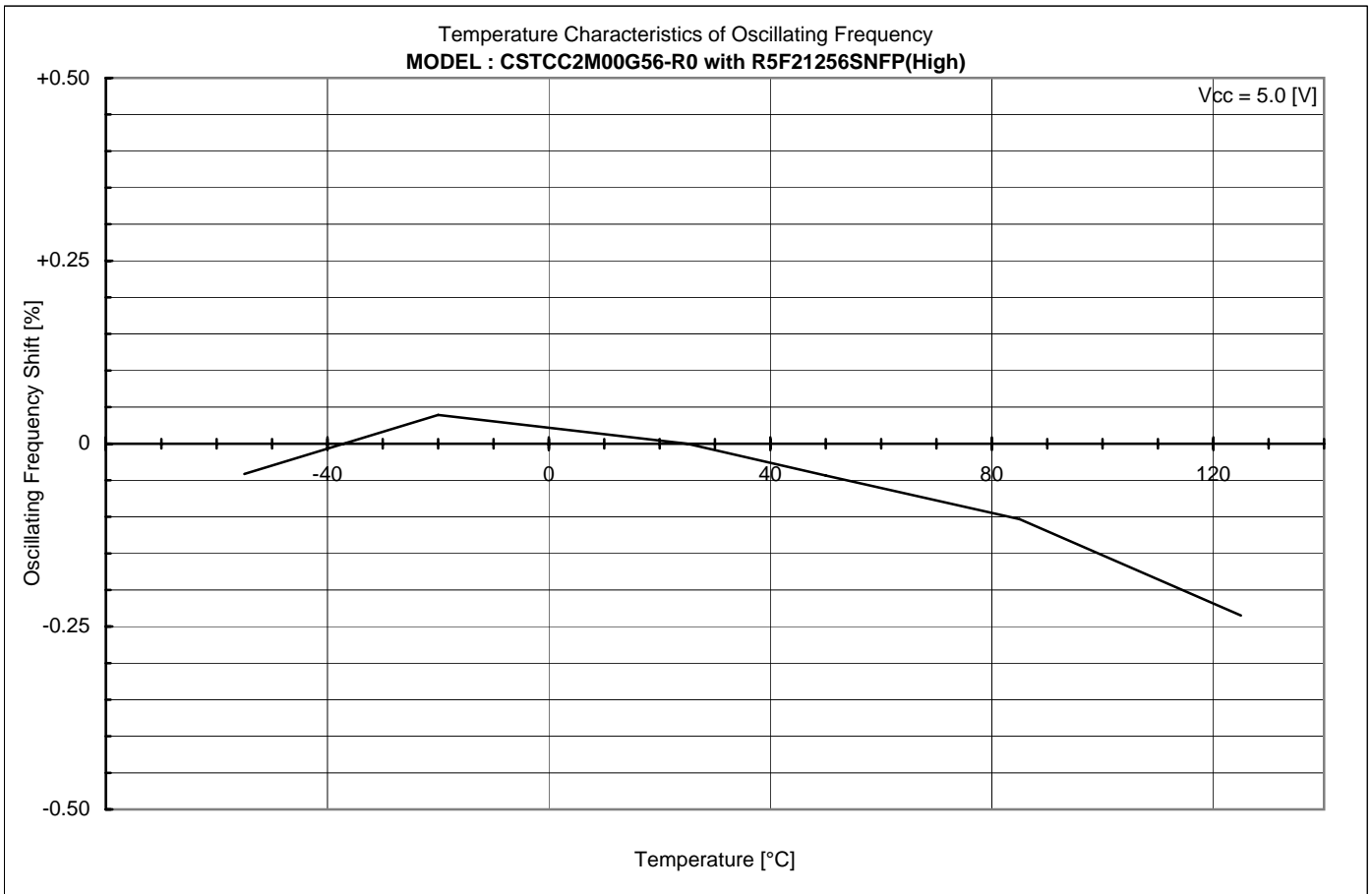

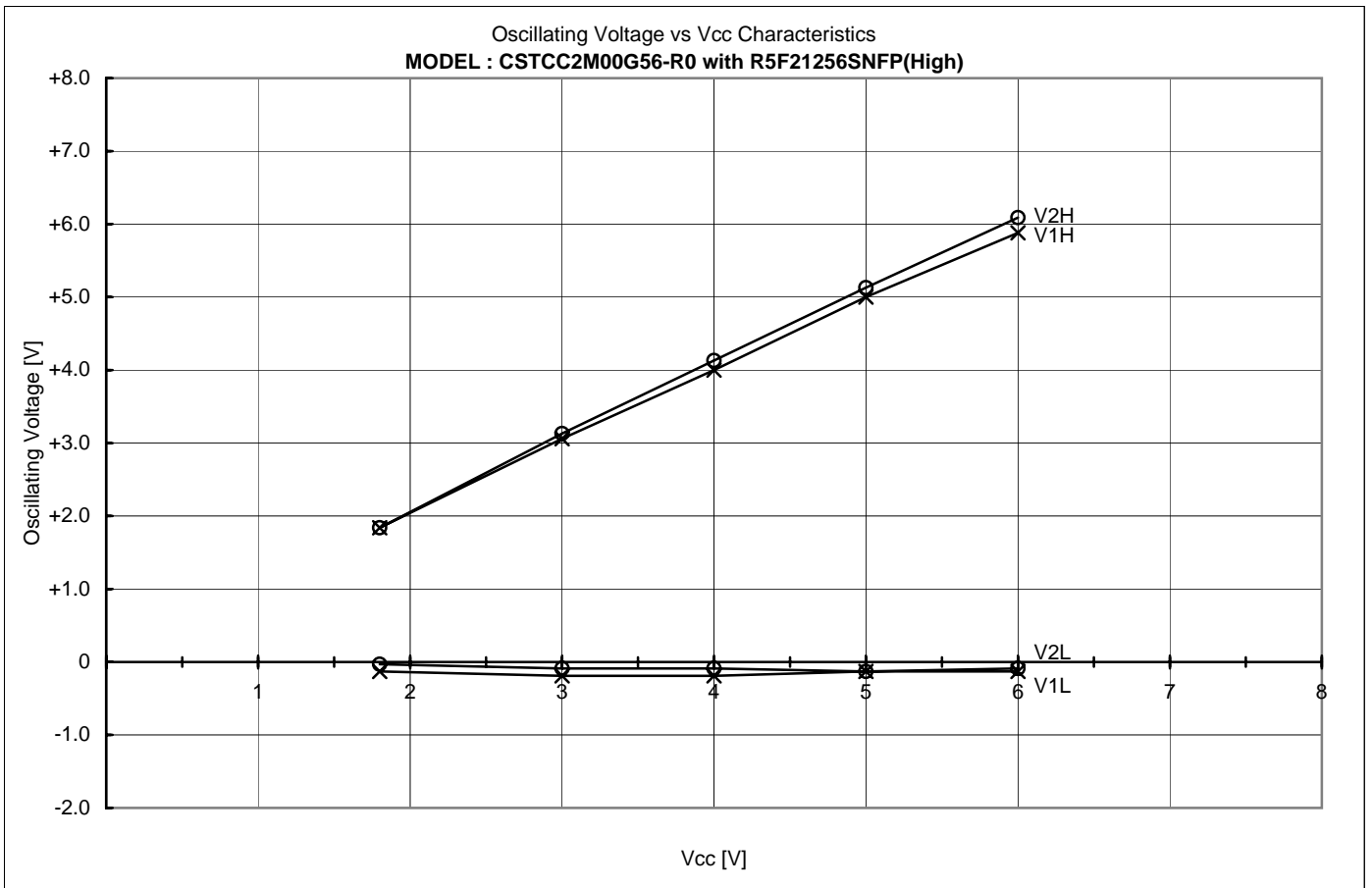
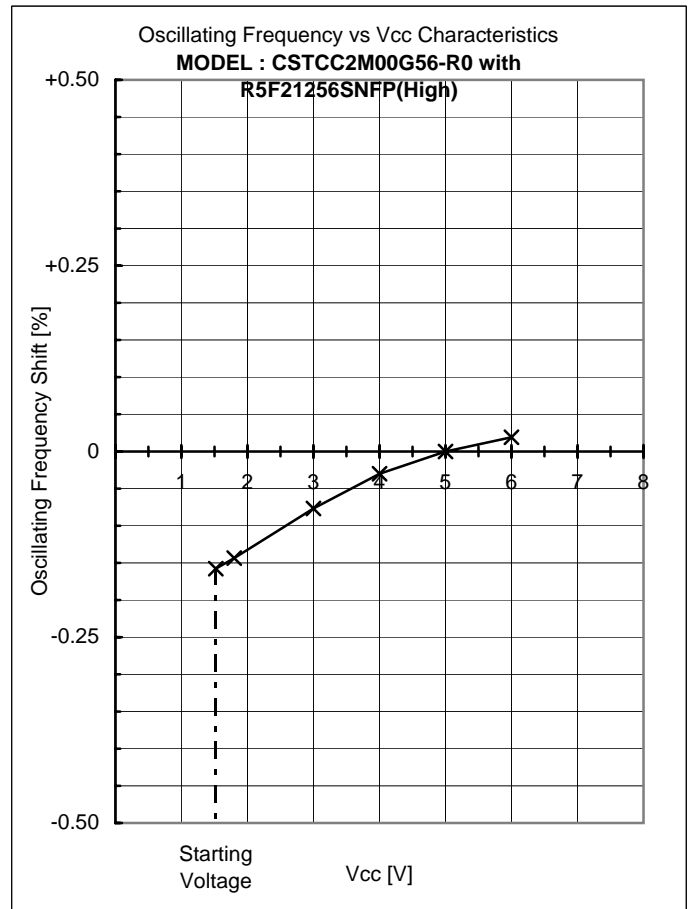
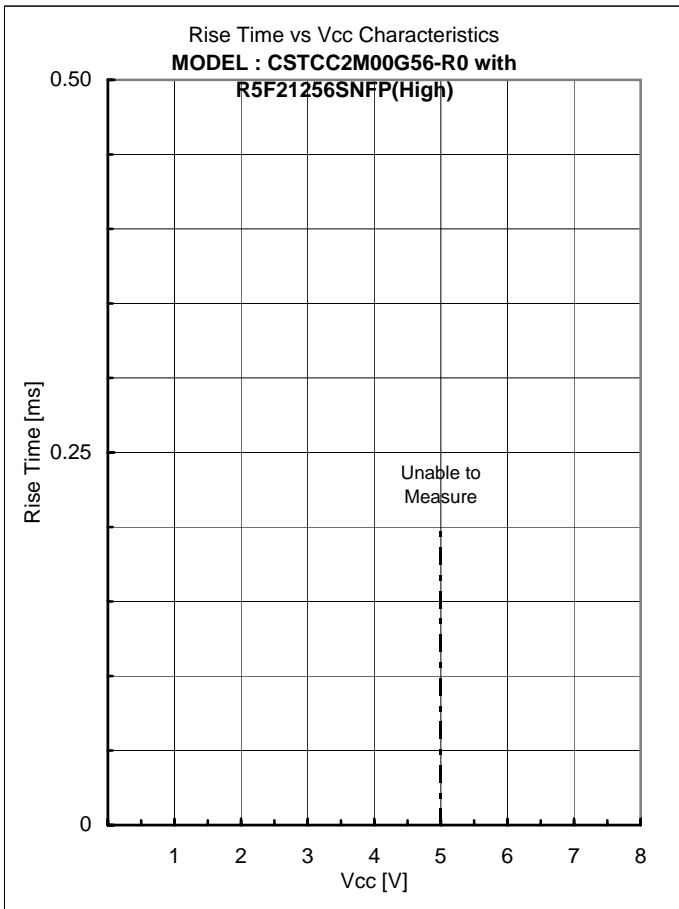

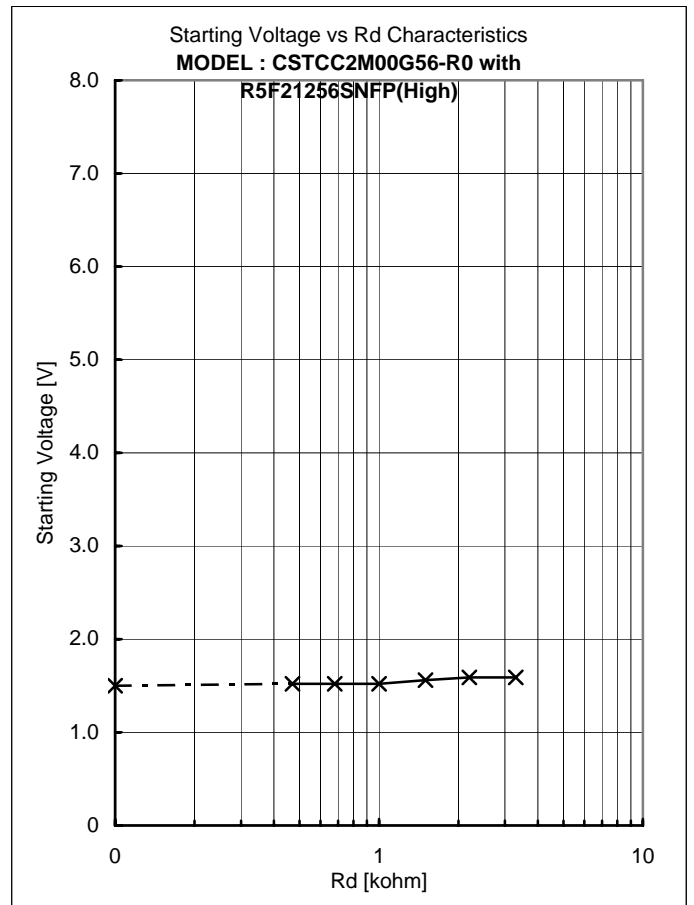
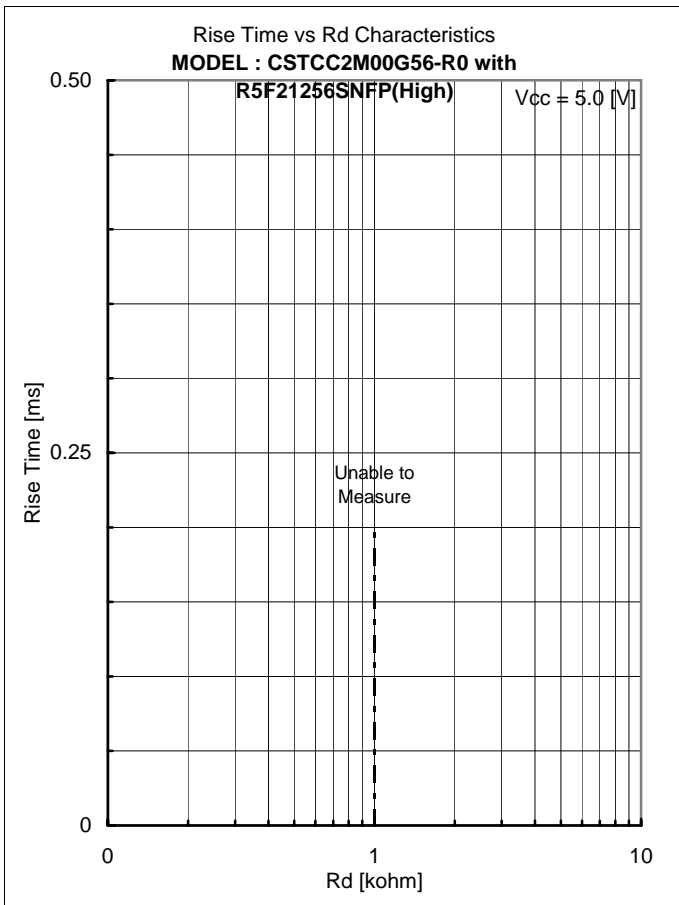
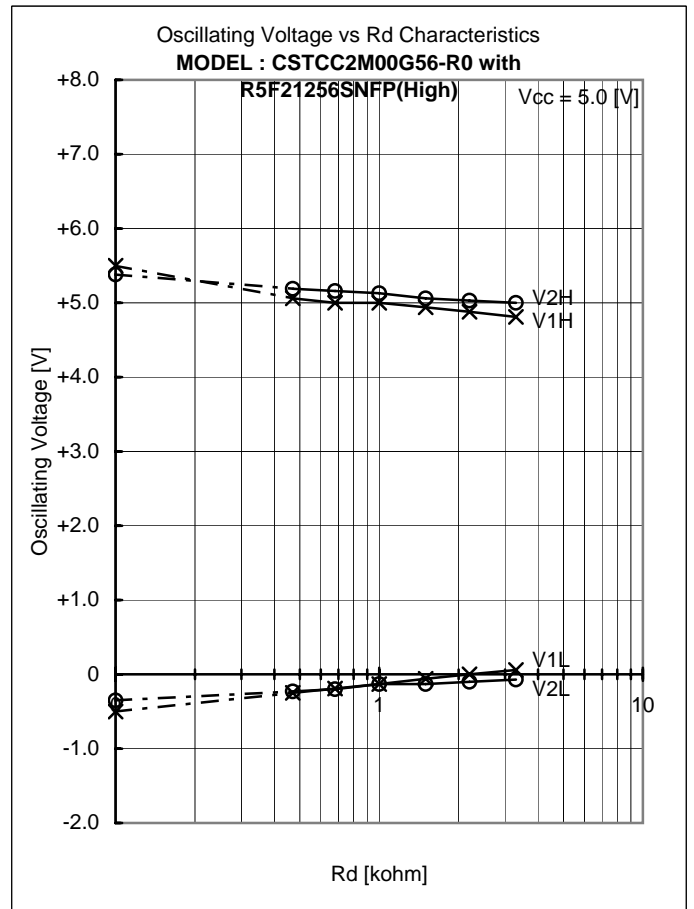
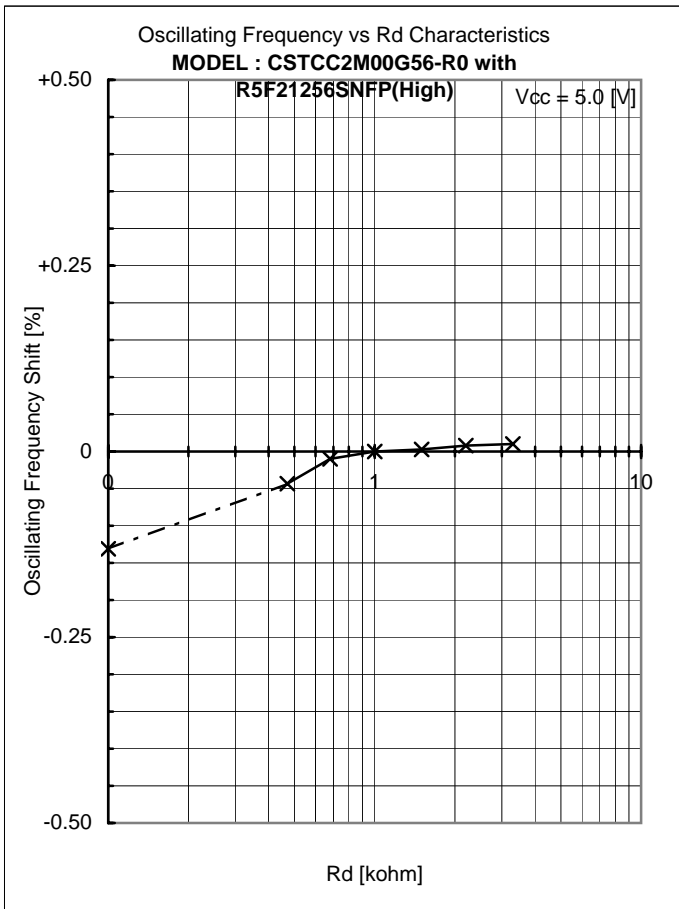



## Appendixes

### 5. Comparison Table

5



**Comparison Table**

IC : No	V1H [V]	V1L [V]	V1p-p [V]	V2H [V]	V2L [V]	V2p-p [V]	Fosc [kHz]	Trise [ms]	Vstart [V]
WS	5.00	-0.13	5.13	5.13	-0.13	5.26	2010.196	Unable to	1.52
LL	4.88	-0.11	4.99	5.13	-0.13	5.26	2010.423	Measure	1.40
LH	5.09	-0.13	5.22	5.13	-0.13	5.26	2008.524		1.53
HH	5.00	-0.13	5.13	5.10	-0.13	5.23	2010.291		1.54
HL	4.94	-0.13	5.07	5.10	-0.17	5.27	2010.365		1.53

Ref.

Performance described page 2 to 4 were measured with IC No. WS

### Frequency Correlation Data

Sample No.	R5F21256SNFP(High) Fosc [kHz]	TC74HCU04 Fosc [kHz]	Shift [%]
1	2010.858	2000.848	0.5003
2	2009.826	2000.114	0.4856
3	2000.554	1990.401	0.5101
4	2003.093	1992.759	0.5186
5	2006.400	1996.628	0.4894
$\bar{X}$	2006.146	1996.150	0.5008

#### muRata Standard Circuit

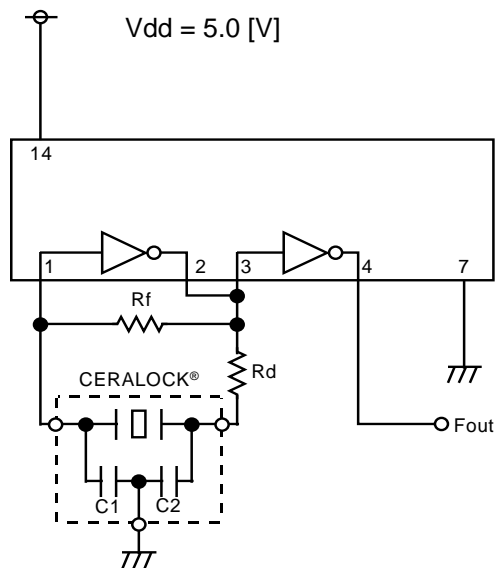

CERALOCK® : CSTCC2M00G56-R0

C1 = 47 [pF]

C2 = 47 [pF]

Rf = 1 [Mohm]

Rd = 1 [kohm]