



Technical Data of Ceramic Resonator

MURATA Part No.: CSTLS8M00G56-B0

Applied to R5F21194SP(High)

TOYAMA MURATA MANUFACTURING CO., LTD.

Product Engineering Service Section VI
Piezoelectric Components Department I
Piezoelectric Components Division
Device Business Unit

Approved by	Checked by	Issued by	Issued Date	Data No.
 K.Maruno	 R.Miyamae	 T.Morita	Feb 13, 2006	TCD-06-0165

Contents

1.	Test Circuit	1
2.	Temperature Characteristics of Oscillating Frequency, Oscillating Voltage	2
3.	Rise Time, Oscillating Frequency, Oscillating Voltage vs Vcc Characteristics	3

Note : Rise Time

"Rise time" is defined as the time when oscillation voltage reaches 90% of full voltage swing after Vdd(Vset) is supplied.

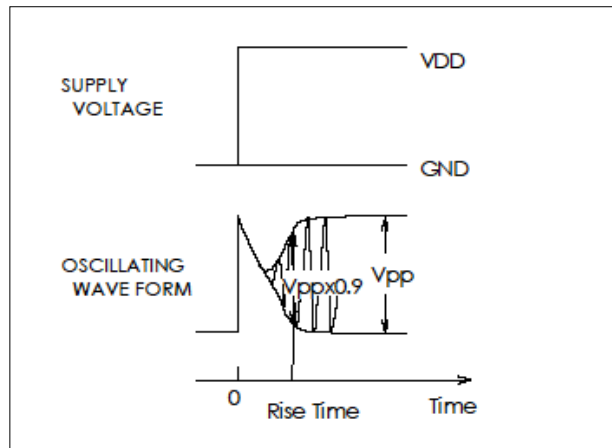

In the case that rising time of Vdd(Vset) is slow comparing to resonator's rise time due to the bypass capacitor, resonator's rise time is also slow because it depends on rising time of Vdd(Vset).

Also, in the case that the time supplying voltage to the oscillator circuit takes a certain time by reset time etc after Vdd(Vset) is applied, resonator's rise time is also slow.

In these case, we will describe "Unable to measure" in rise time data, because we can not measure resonator's rise time correctly.

Test Circuit

Vcc = 5.0 [V]

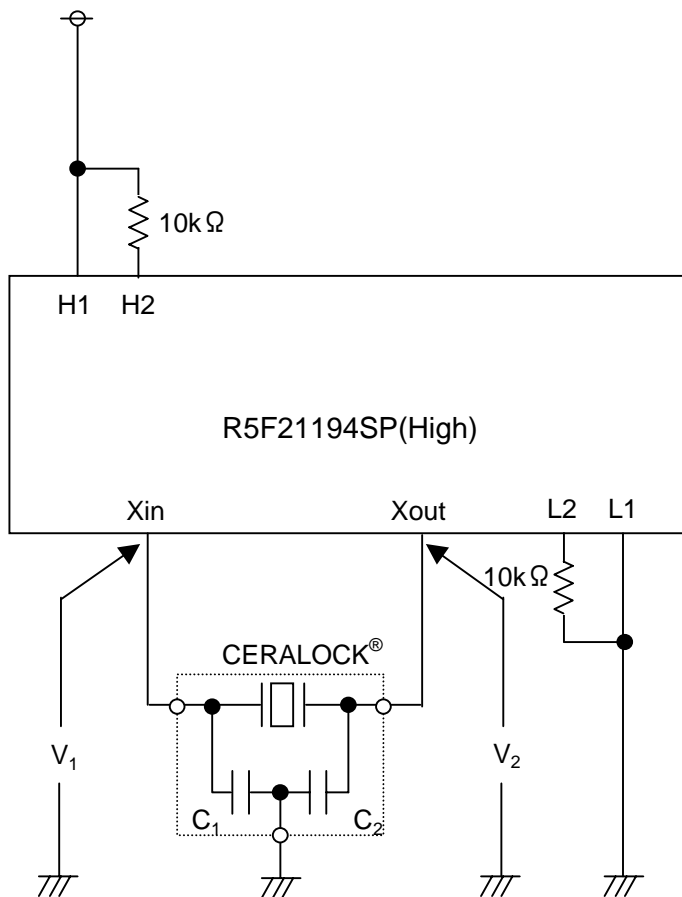

Xin : 6

Xout: 4

H1 : 3,7

L1 : 5

H2 : 8,10

L2 : 2

Recommended Value

CERALOCK® : CSTLS8M00G56-B0

Vcc = 2.7 to 5.5 [V]

C1 = 47 [pF] (Typ.)

C2 = 47 [pF] (Typ.)

Ta = -40 to 85 [°C]

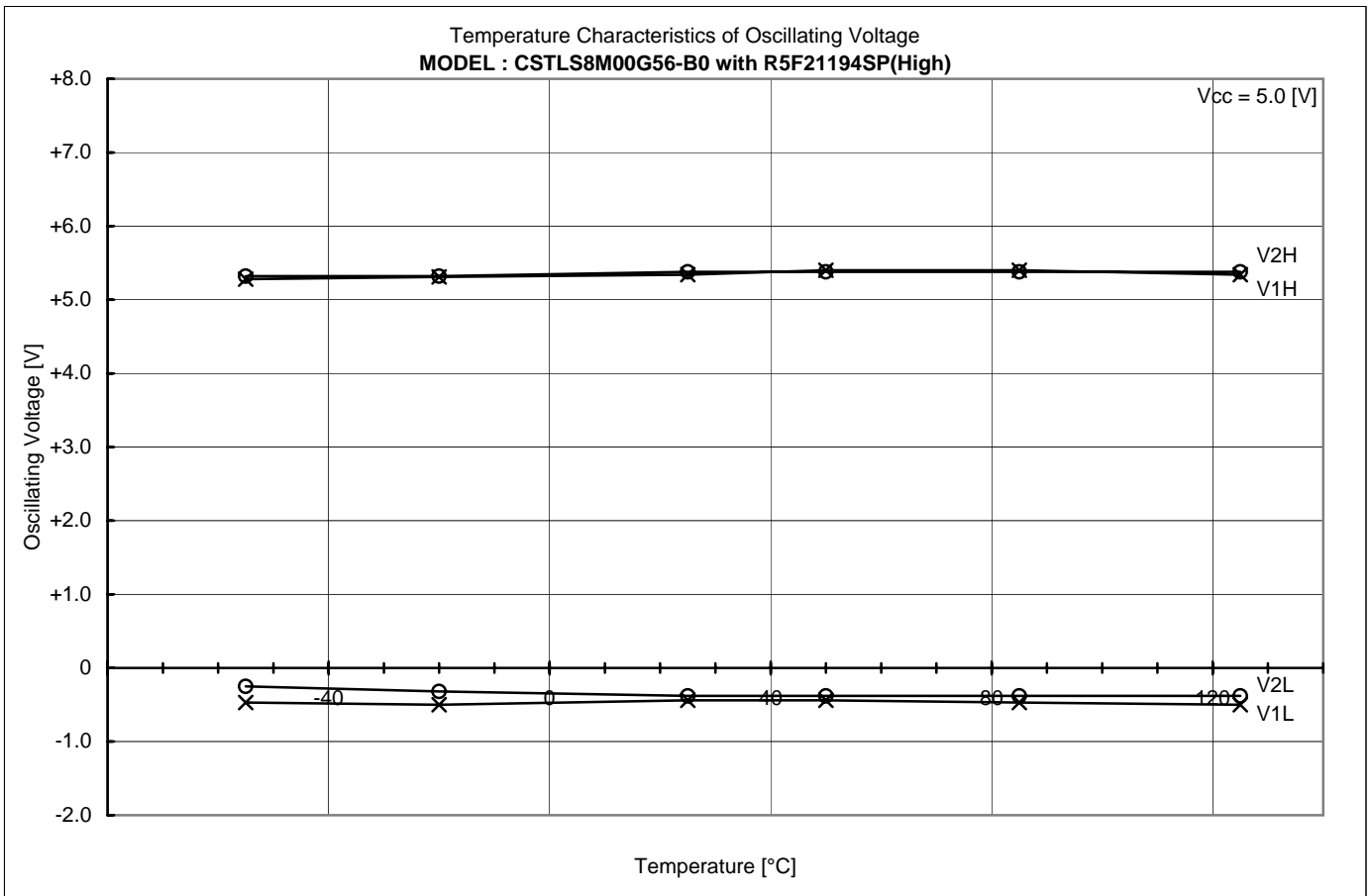
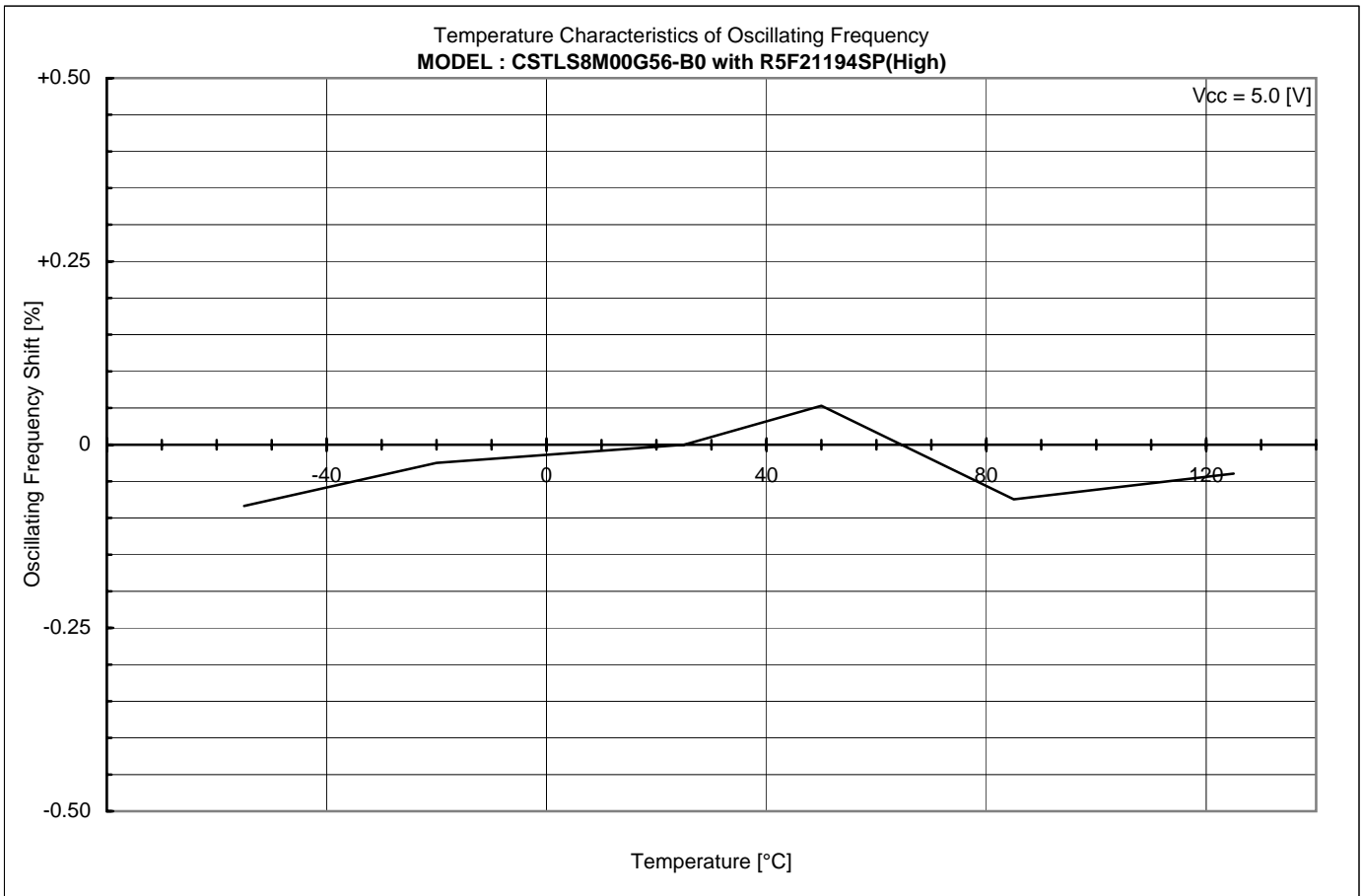

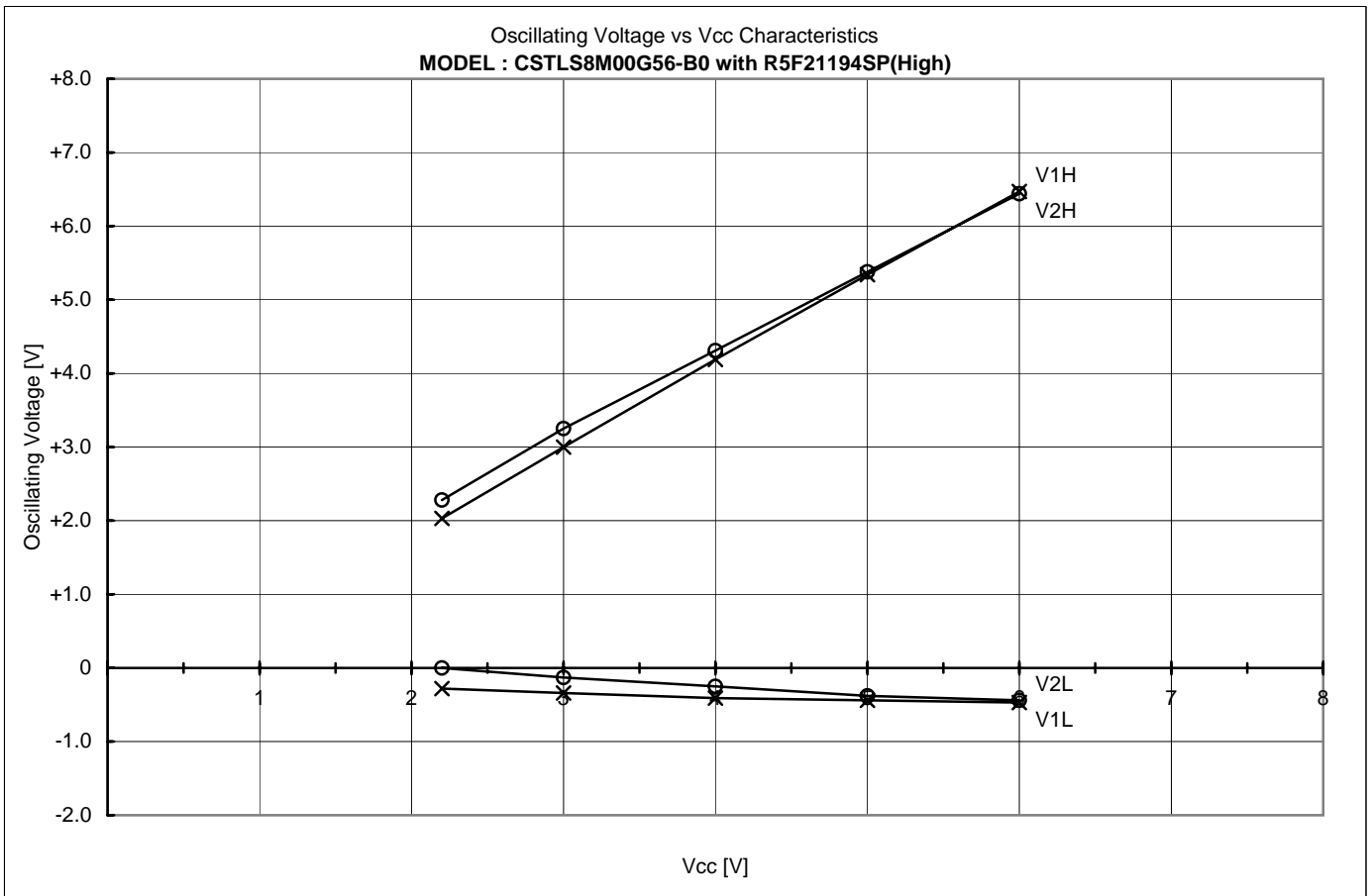
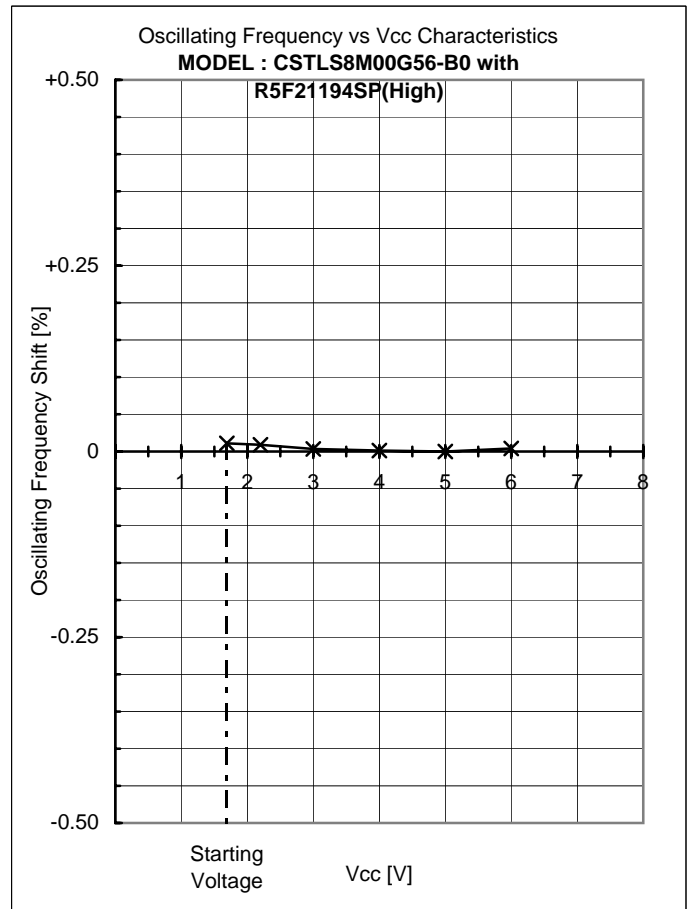
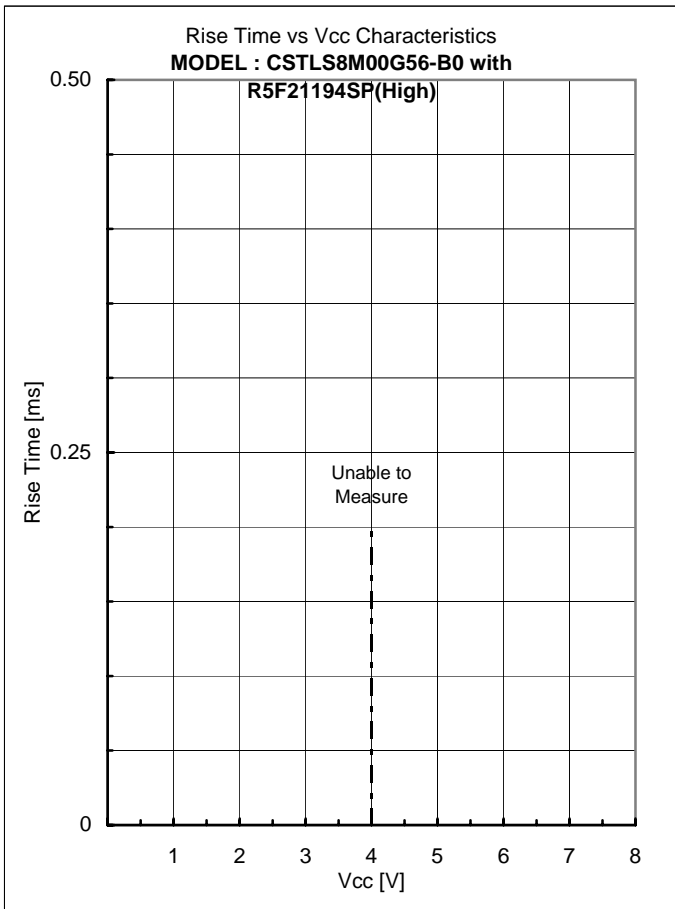

Appendixes

4. Comparison Table

4

Comparison Table

IC : No	V1H [V]	V1L [V]	V1p-p [V]	V2H [V]	V2L [V]	V2p-p [V]	Fosc [kHz]	Trise [ms]	Vstart [V]
TYP	5.34	-0.44	5.78	5.38	-0.38	5.76	7997.070	Unable to	1.69
LL	5.41	-0.38	5.79	5.38	-0.38	5.76	7996.908	Measure	1.49
LH	5.34	-0.41	5.75	5.38	-0.31	5.69	7996.249		1.65
HL	5.34	-0.38	5.72	5.31	-0.38	5.69	7996.463		1.65
HH	5.34	-0.41	5.75	5.38	-0.38	5.76	7996.333		1.74

Ref.

Performance described page 2 to 3 were measured with IC No. TYP

Frequency Correlation Data

Sample No.	R5F21194SP(High) Fosc [kHz]	TC74HCU04 Fosc [kHz]	Shift [%]
1	8000.307	7991.673	0.1080
2	7993.830	7985.745	0.1012
3	7993.581	7984.435	0.1145
4	7999.955	7991.077	0.1111
5	7995.064	7986.703	0.1047
\bar{X}	7996.547	7987.926	0.1079

muRata Standard Circuit

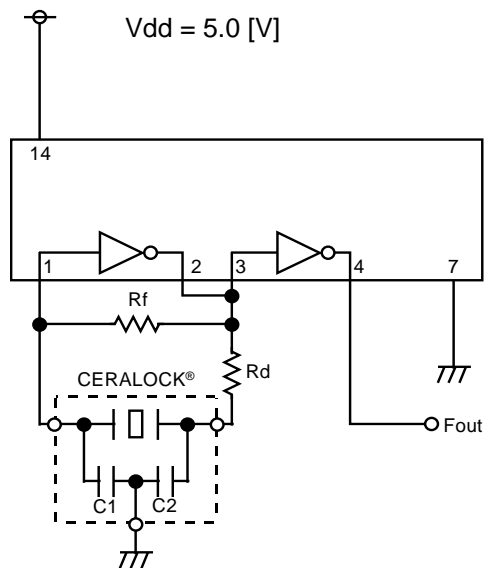

CERALOCK® : CSTLS8M00G56-B0

C1 = 47 [pF]

C2 = 47 [pF]

Rf = 1 [Mohm]

Rd = 680 [ohm]