



Technical Data of Ceramic Resonator

MURATA Part No.: CSTCC2M00G56-R0

Applied to R5F21194SP(High)

TOYAMA MURATA MANUFACTURING CO., LTD.

Product Engineering Service Section VI
Piezoelectric Components Department I
Piezoelectric Components Division
Device Business Unit

Approved by	Checked by	Issued by	Issued Date	Data No.
 K.Maruno	 R.Miyamae	 T.Morita	Feb 13, 2006	TCD-06-0159

Contents

1.	Test Circuit	1
2.	Temperature Characteristics of Oscillating Frequency, Oscillating Voltage	2
3.	Rise Time, Oscillating Frequency, Oscillating Voltage vs Vcc Characteristics	3

Note : Rise Time

"Rise time" is defined as the time when oscillation voltage reaches 90% of full voltage swing after Vdd(Vset) is supplied.

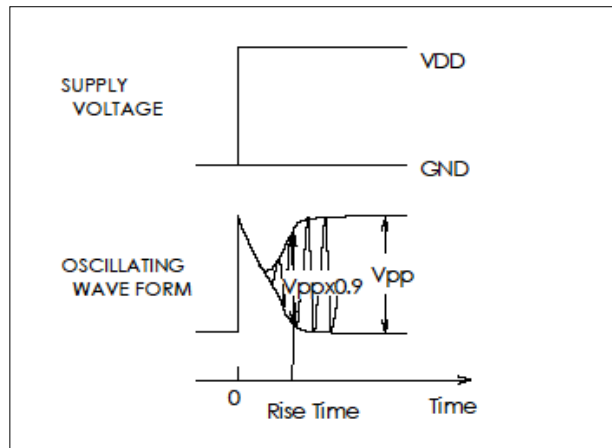

In the case that rising time of Vdd(Vset) is slow comparing to resonator's rise time due to the bypass capacitor, resonator's rise time is also slow because it depends on rising time of Vdd(Vset).

Also, in the case that the time supplying voltage to the oscillator circuit takes a certain time by reset time etc after Vdd(Vset) is applied, resonator's rise time is also slow.

In these case, we will describe "Unable to measure" in rise time data, because we can not measure resonator's rise time correctly.

Test Circuit

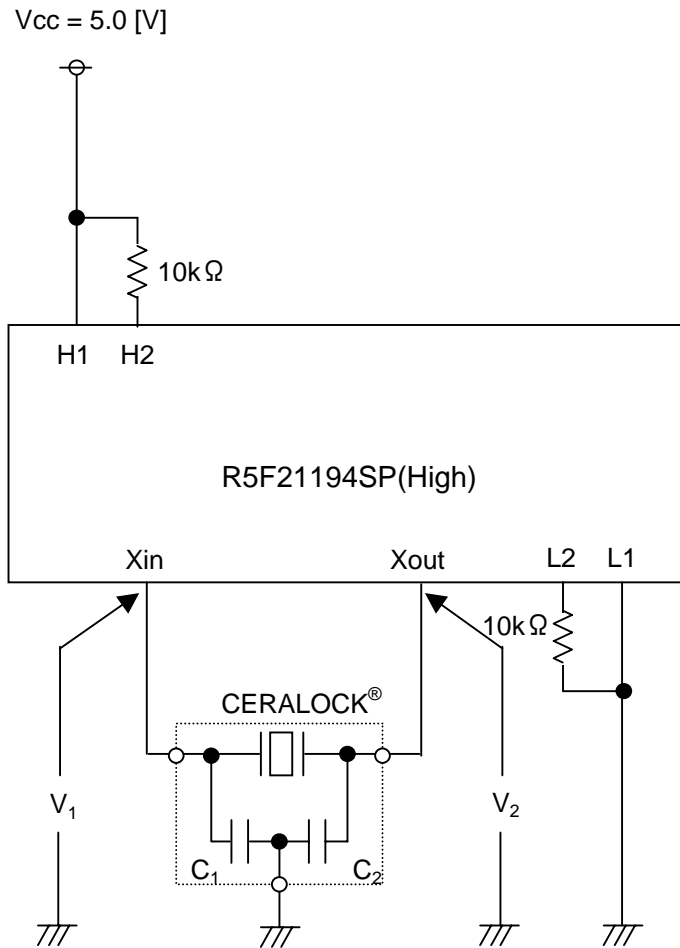

Xin : 6

Xout: 4

H1 : 3,7

L1 : 5

H2 : 8,10

L2 : 2

Recommended Value

CERALOCK® : CSTCC2M00G56-R0

Vcc = 2.7 to 5.5 [V]

C1 = 47 [pF] (Typ.)

C2 = 47 [pF] (Typ.)

Ta = -40 to 85 [°C]

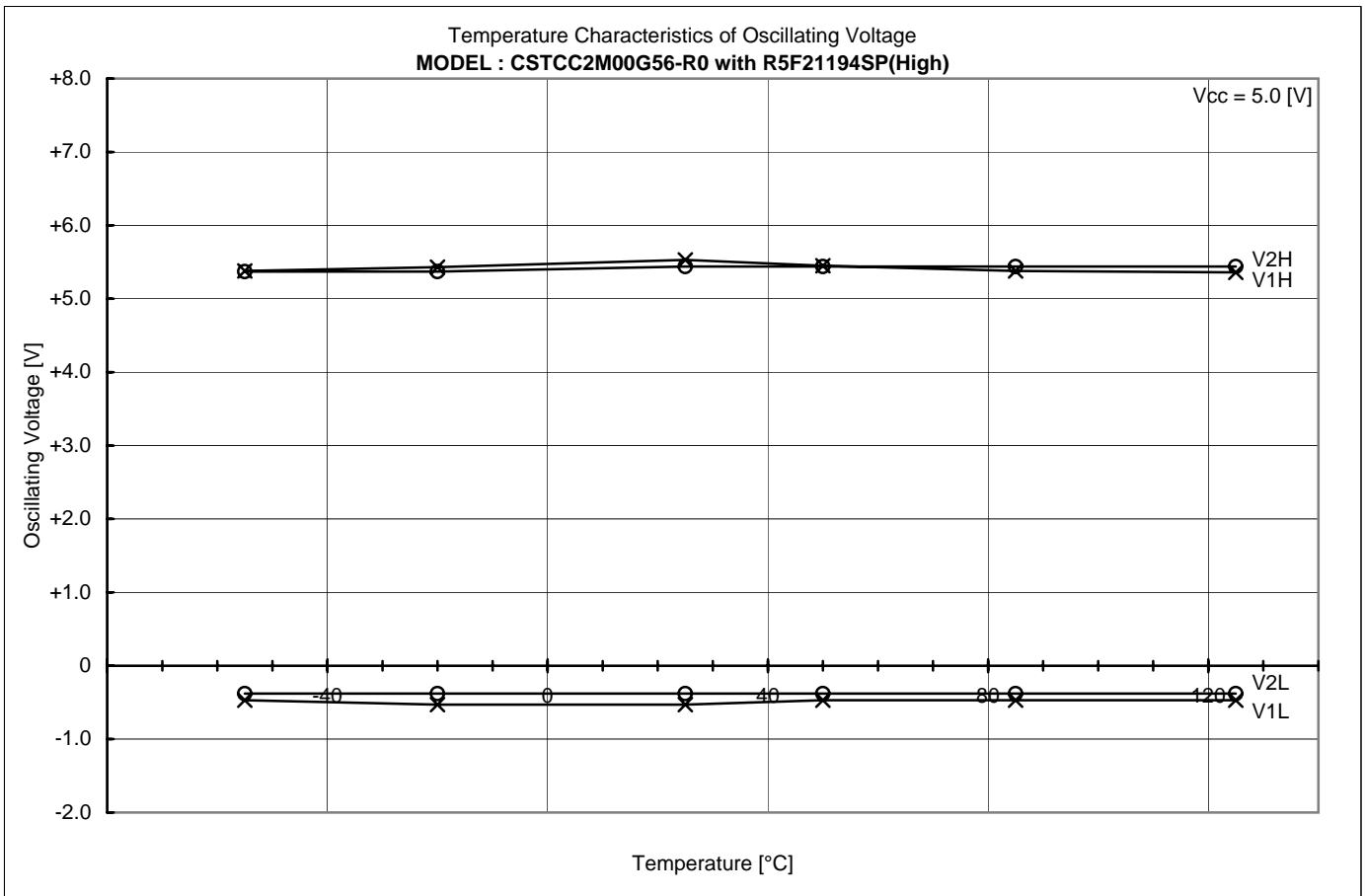
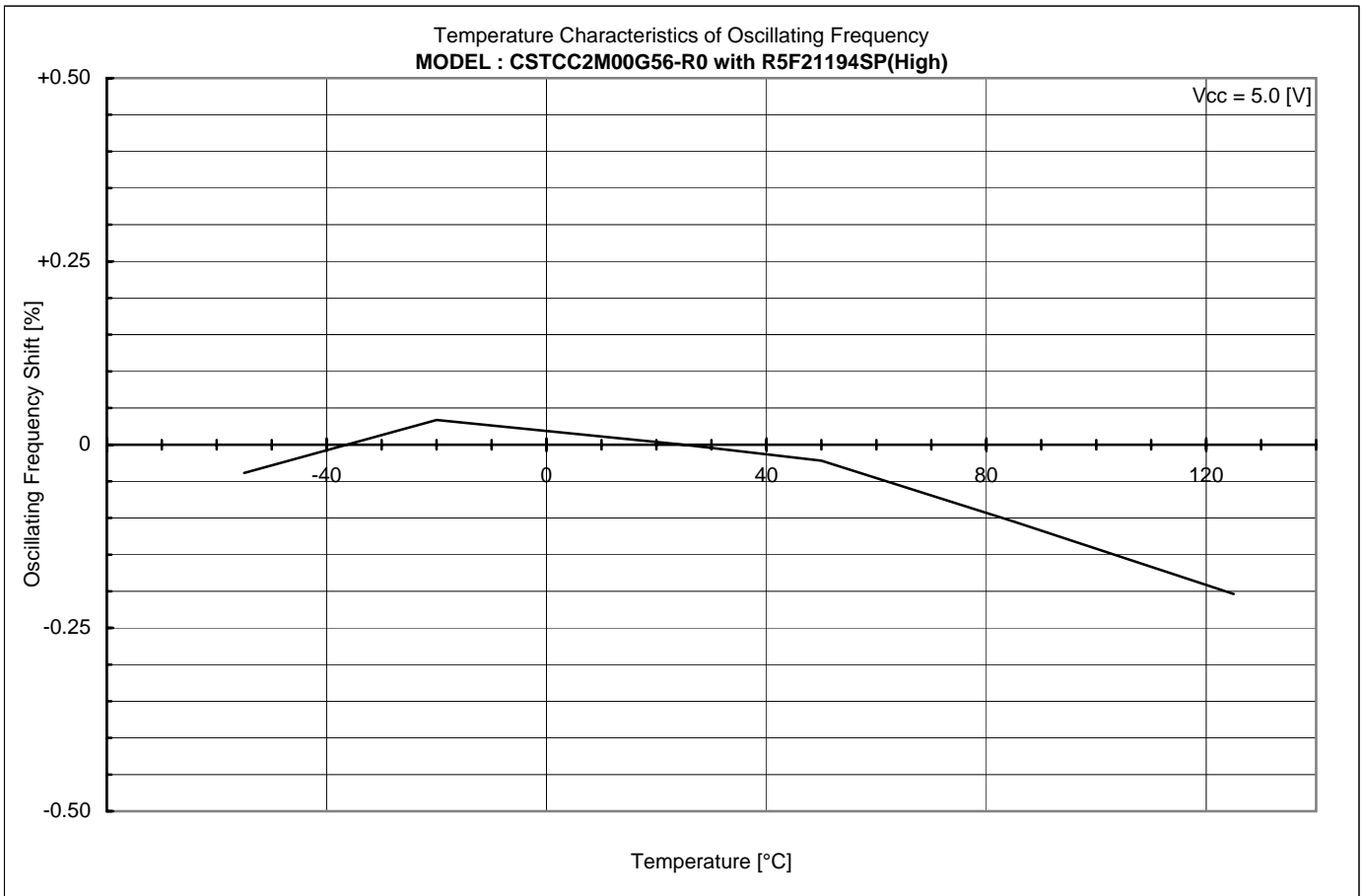

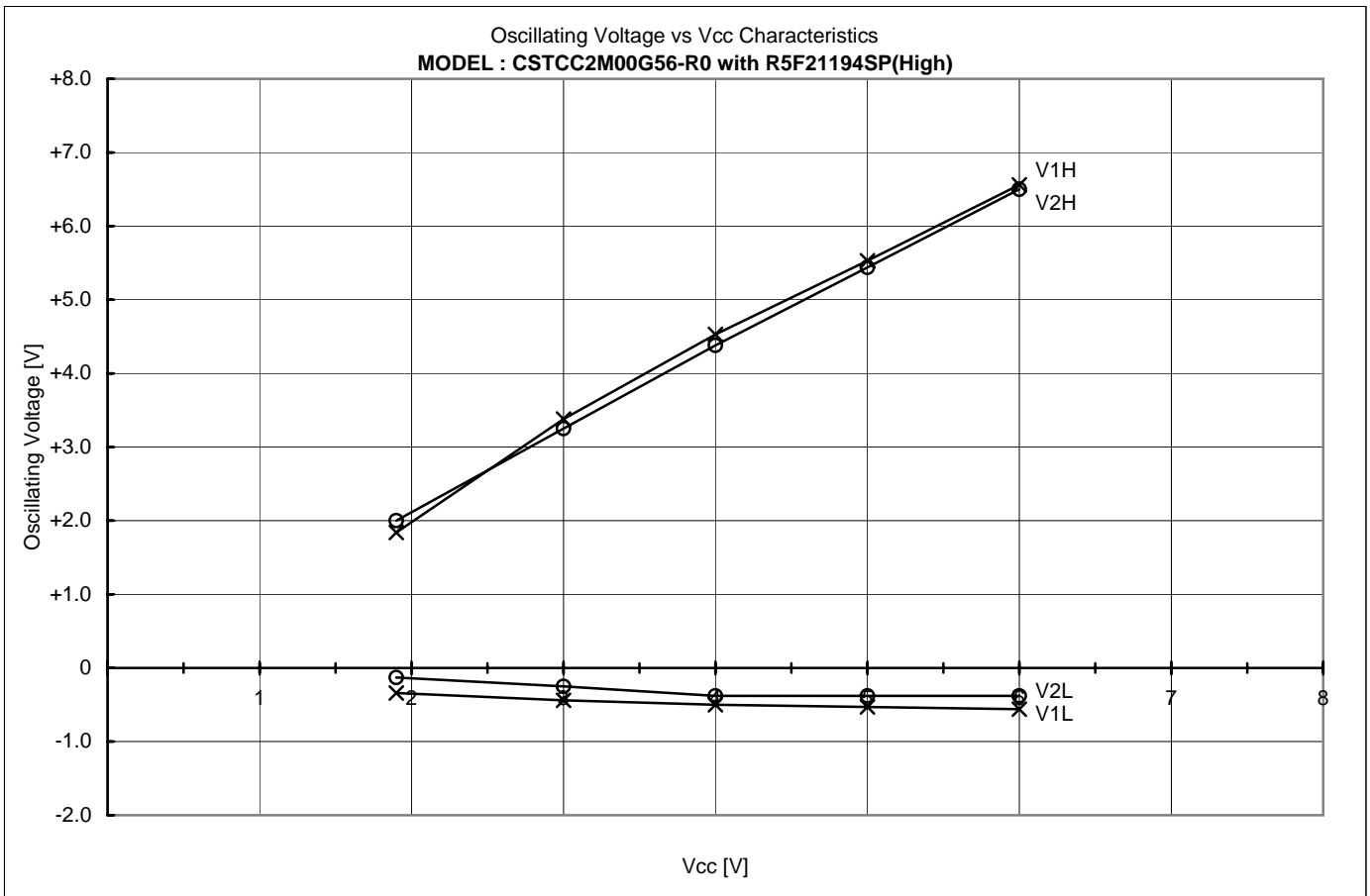
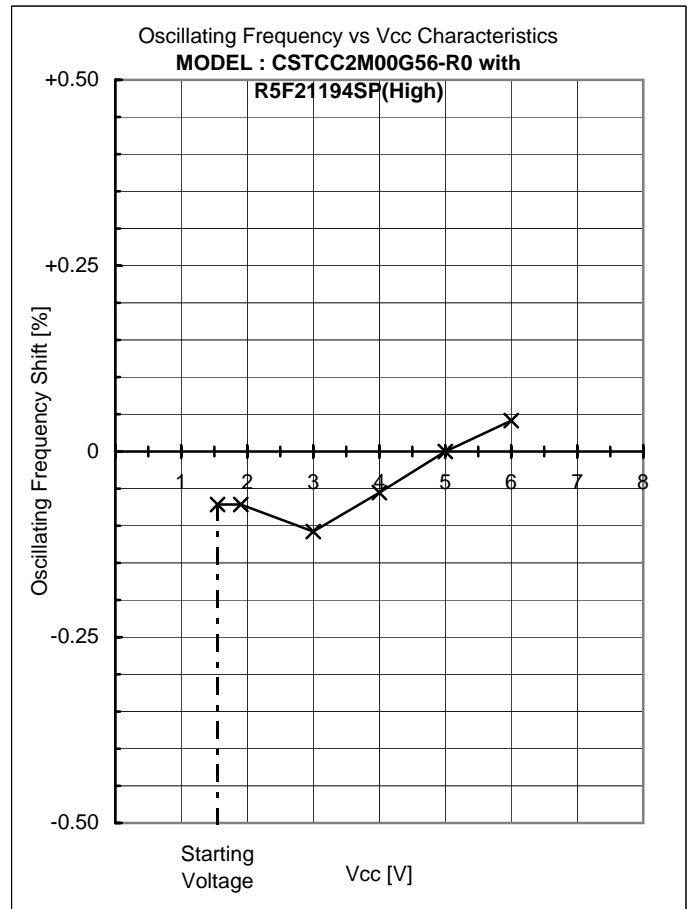
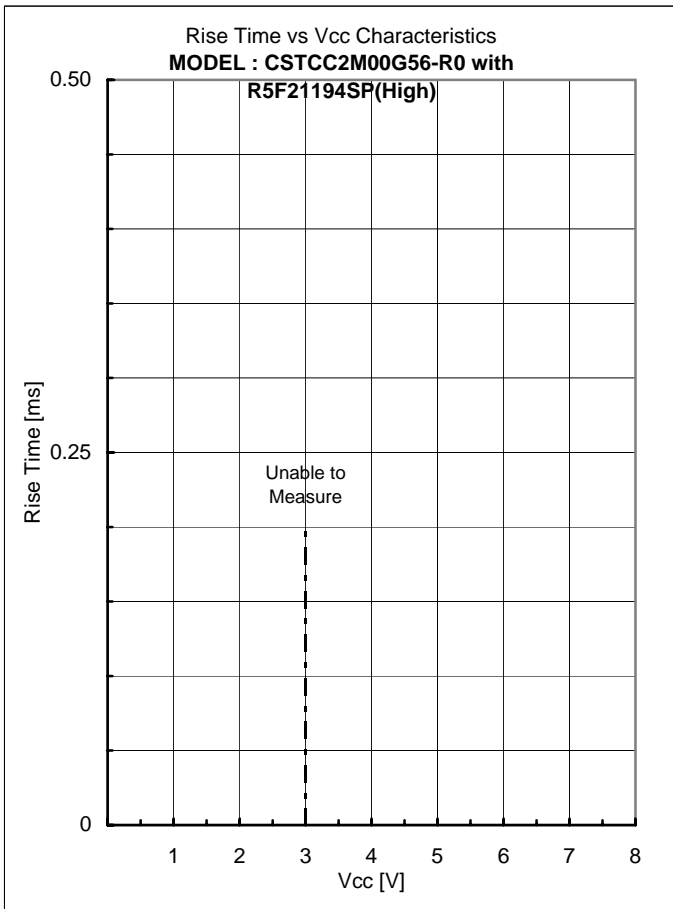

Appendixes

4. Comparison Table

4

Comparison Table

IC : No	V1H [V]	V1L [V]	V1p-p [V]	V2H [V]	V2L [V]	V2p-p [V]	Fosc [kHz]	Trise [ms]	Vstart [V]
TYP	5.53	-0.53	6.06	5.44	-0.38	5.82	2007.993	Unable to	1.55
LL	5.53	-0.47	6.00	5.38	-0.38	5.76	2008.333	Measure	1.36
LH	5.53	-0.56	6.09	5.44	-0.38	5.82	2007.959		1.52
HL	5.56	-0.50	6.06	5.38	-0.38	5.76	2007.936		1.51
HH	5.59	-0.53	6.12	5.44	-0.38	5.82	2007.856		1.60

Ref.

Performance described page 2 to 3 were measured with IC No. TYP

Frequency Correlation Data

Sample No.	R5F21194SP(High) Fosc [kHz]	TC74HCU04 Fosc [kHz]	Shift [%]
1	2008.359	2007.735	0.0310
2	2007.344	2006.748	0.0297
3	1997.763	1997.729	0.0017
4	1999.939	1999.827	0.0056
5	2003.703	2003.300	0.0201
- X	2003.422	2003.068	0.0177

muRata Standard Circuit

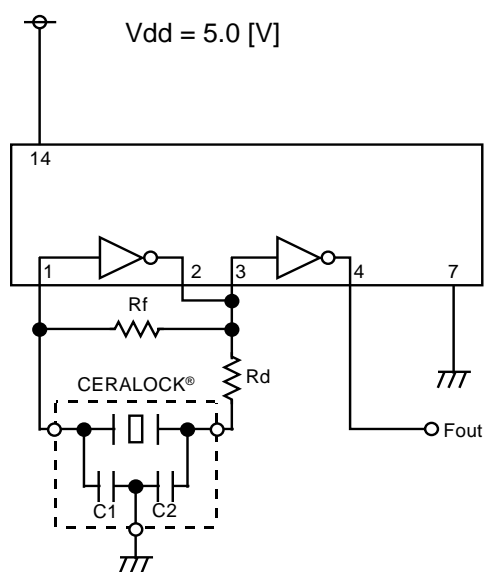

CERALOCK® : CSTCC2M00G56-R0

C1 = 47 [pF]

C2 = 47 [pF]

Rf = 1 [Mohm]

Rd = 1 [kohm]