

ISL70003SEH

Neutron Test Report

TR026

Rev 0.00

March 8, 2016

Introduction

This report summarizes results of 1MeV equivalent neutron testing of the [ISL70003SEH](#) integrated FET point-of-load regulator. The test was conducted in order to determine the sensitivity of the part to Displacement Damage (DD) caused by neutron or proton environments. Neutron fluences ranged from 2×10^{12} n/cm² to 1×10^{14} n/cm². This project was carried out in collaboration with VPT, Inc. (Blacksburg, VA) and their support is gratefully acknowledged.

Reference Documents

For more information about the ISL70003SEH, refer to the following documentation.

- [ISL70003SEH](#) datasheet
- Standard Microcircuit Drawing (SMD): [5962-14203](#)
- MIL-STD-883 test method 1017
- [AN1913](#) “Single Event Effects Testing of the ISL70003SEH, a 3V to 13.2V, 6A Synchronous Buck Regulator”

Part Description

The ISL70003SEH is a radiation hardened synchronous buck regulator capable of operating over an input voltage range of 3.0V to 13.2V. With integrated MOSFETs, the part provides an efficient single chip power solution that is externally adjustable from 0.6V to ~90% of the input voltage. Continuous output load current capability is 6A for $T_J \leq +125^\circ\text{C}$ and 3A for $T_J \leq +150^\circ\text{C}$. The ISL70003SEH uses voltage mode control architecture with feed-forward and switches at pin-selected fixed frequencies of 500kHz or 300kHz. Loop compensation is externally adjustable to allow for an optimum balance between stability and output dynamic performance. The on-chip synchronous power MOSFET switches are optimized for efficiency and thermal performance. The chip features two logic-level disable inputs that can be used to inhibit pulses on the phase (LXx) pins in order to maximize efficiency as a function of load current.

The ISL70003SEH supports DDR applications and contains a buffer amplifier for generating the V_{REF} voltage required by that protocol. Typical ISL70003SEH applications include FPGA, CPLD and DSP power management, CPU core and I/O supply and DDR memory power management in high-density distributed power systems for space applications.

The ISL70003SEH is hardened to achieve a Total Dose (TID) rating of 100krad(Si) at both high (50-300rad(Si)/s) and low (≤ 0.01 rad(Si)/s) dose rates as specified in MIL-STD-883 test method 1019. The part is acceptance tested on a wafer-by-wafer basis at low dose rate to 50krad(Si) and at high dose rate to 100krad(Si), as indicated by the '-EH' suffix in the part number.

The ISL70003SEH is also SEE rated to a Linear Energy Transfer (LET) value of 86.4 MeV.cm²/mg. Single-Event Transients (SET) are well known to be a major issue in power management parts driving voltage-sensitive loads, and the part provides superior performance in this environment; refer to Intersil application note [AN1913](#) for further details. Additional SET hardening is achieved by specifying or restricting the values of certain external components.

The ISL70003SEH is implemented in a submicron junction-isolated BiCMOS process optimized for power management applications, with 0.6 μm minimum ground rules and three layers of interconnect. The process is in volume production under MIL-PRF-38535 certification and is used for a wide range of commercial power management devices.

Specifications for radiation hardened QML devices are controlled by the Defense Logistics Agency (DLA) in Columbus, OH. The SMD is the controlling document and must be cited when ordering.

Block Diagram

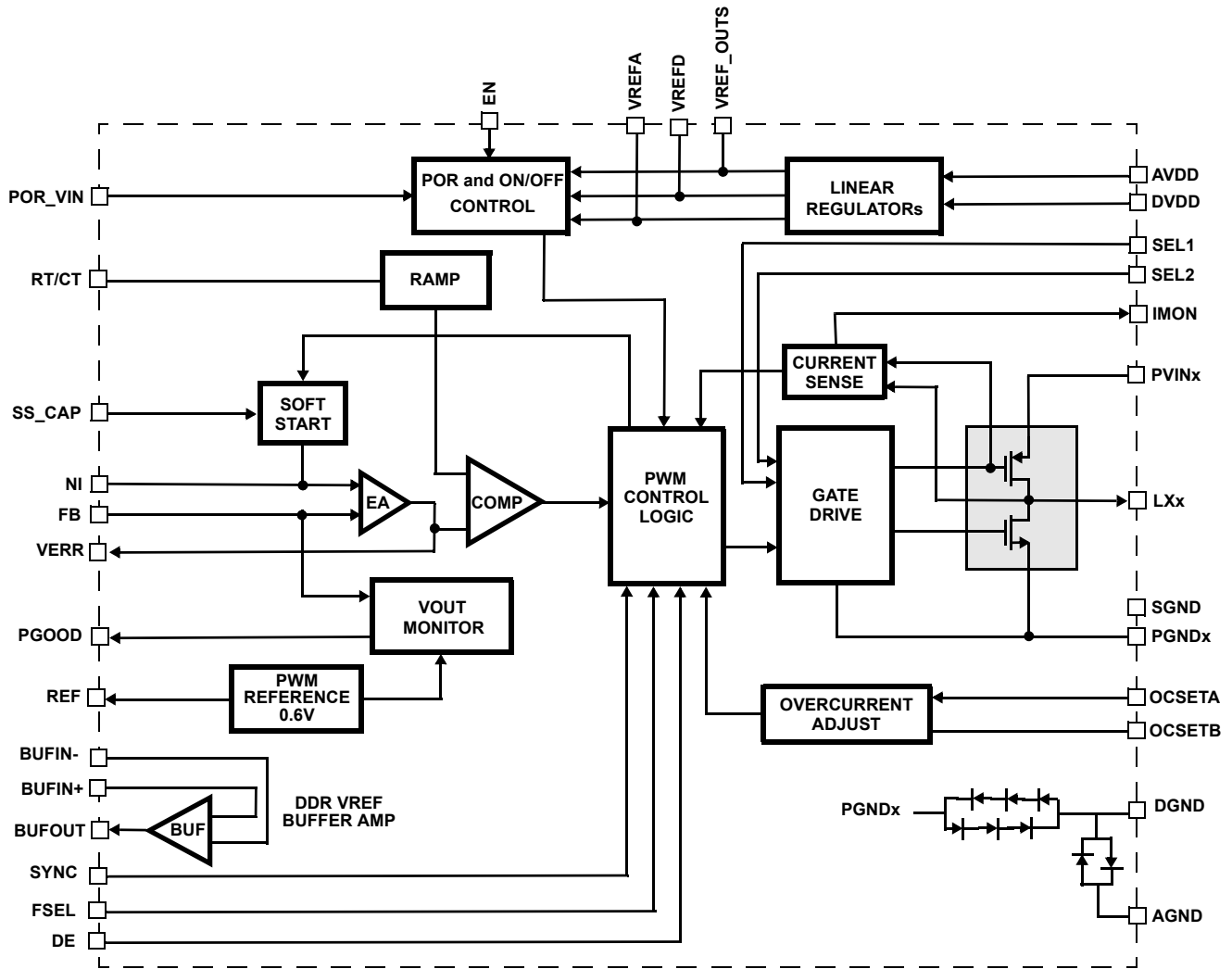

FIGURE 1. BLOCK DIAGRAM

Test Description

Irradiation Facility

Neutron irradiation was performed by the VPT team at the University of Massachusetts Lowell Fast Neutron Irradiation (FNI) facility, which provides a controlled 1MeV equivalent neutron flux. Parts were tested in an unbiased configuration with all leads shorted together in accordance with TM 1017 of MIL-STD-883. As neutron irradiation activates many of the heavier elements found in a packaged integrated circuit, the parts exposed at the higher neutron levels required (as expected) some 'cooldown' time before being shipped back to Intersil (Palm Bay, FL) for electrical testing.

Test Fixturing

No formal irradiation test fixturing is involved, as these DD tests are 'bag tests' in the sense that the parts are irradiated with all leads shorted together.

Characterization Equipment

Electrical testing was performed before and after irradiation using the Intersil production Automated Test Equipment (ATE). All electrical testing was performed at room temperature.

Experimental Matrix

Testing proceeded in general accordance with the guidelines of MIL-STD-883 TM 1017. The experimental matrix consisted of 5 samples irradiated at 2×10^{12} n/cm², 5 irradiated at 1×10^{13} n/cm², 5 irradiated at 3×10^{13} n/cm² and 5 irradiated at 1×10^{14} n/cm². Two control units were used.

The ISL70003SEH samples were drawn from Lot 3XKFBC. Samples were packaged in the standard hermetic 64 Ld Ceramic Quad Flatpack (CQFP) production package, code RKV. Samples were processed through burnin before irradiation and were screened to the SMD limits at room, low and high temperatures before the start of neutron testing.

Results

Test Results

Neutron testing of the ISL70003SEH is complete and the results are reported in the balance of this report. It should be carefully realized when interpreting the data that each neutron irradiation was performed on a different five-unit sample; this is not total dose testing, where the damage is cumulative.

Attributes Data

TABLE 1. ATTRIBUTES DATA

PART	FLUENCE, n/cm ²	SAMPLE SIZE	PASS (Note 1)	FAIL
ISL70003SEH	2×10^{12}	5	5	0
ISL70003SEH	1×10^{13}	5	5	0
ISL70003SEH	3×10^{13}	5	0	5
ISL70003SEH	1×10^{14}	5	0	5

NOTE:

- 'Pass' indicates a sample that passes all SMD limits.

Variables Data

The plots in [Figures 2](#) through [29](#) show data plots for key parameters before and after irradiation to each level. The plots show the median of each parameter as a function of neutron irradiation. We chose to plot the median because of the small sample sizes (five per cell) involved. We also show the applicable electrical limits taken from the SMD; it should be carefully noted that these limits are provided for guidance only as the ISL70003SEH is not specified for the neutron environment.

All samples passed the post-irradiation SMD limits after 2×10^{12} and 1×10^{13} n/cm² but failed the SMD post-irradiation limits after 3×10^{13} and 1×10^{14} n/cm².

Variables Data Plots

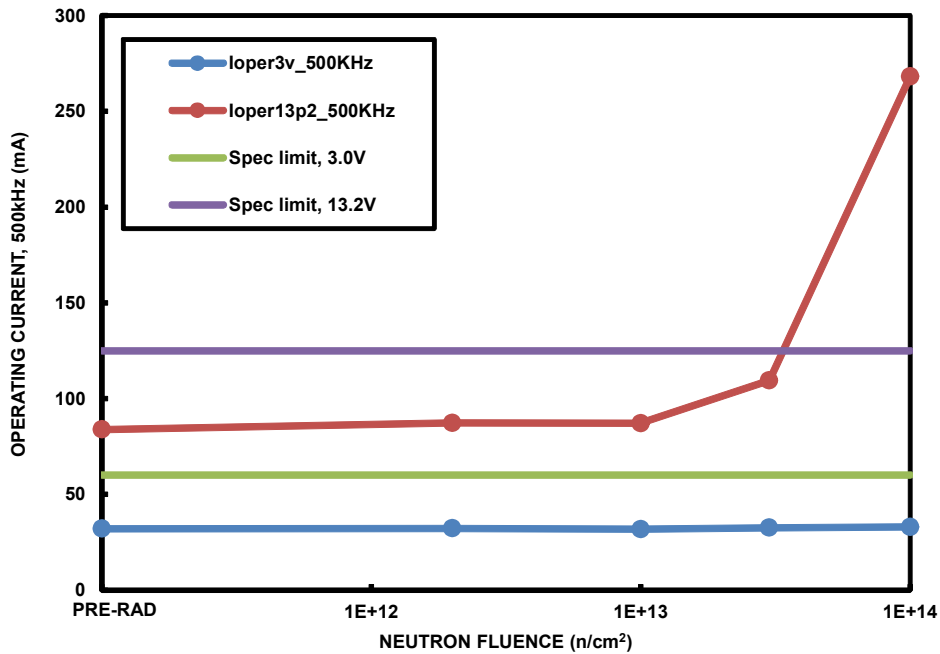

FIGURE 2. ISL70003SEH operating current at 500kHz, 3V (blue) and 13.2V (red) input voltage cases, as a function of neutron irradiation, showing the median of the populations following irradiation to each level. Neutron fluences and sample sizes (in parentheses) were 2×10^{12} n/cm² (5 samples), 1×10^{13} n/cm² (5 samples), 3×10^{13} n/cm² (5 samples) and 1×10^{14} n/cm² (5 samples). The SMD limits are 60.0mA maximum (3V case) and 125.0mA maximum (13.2V case).

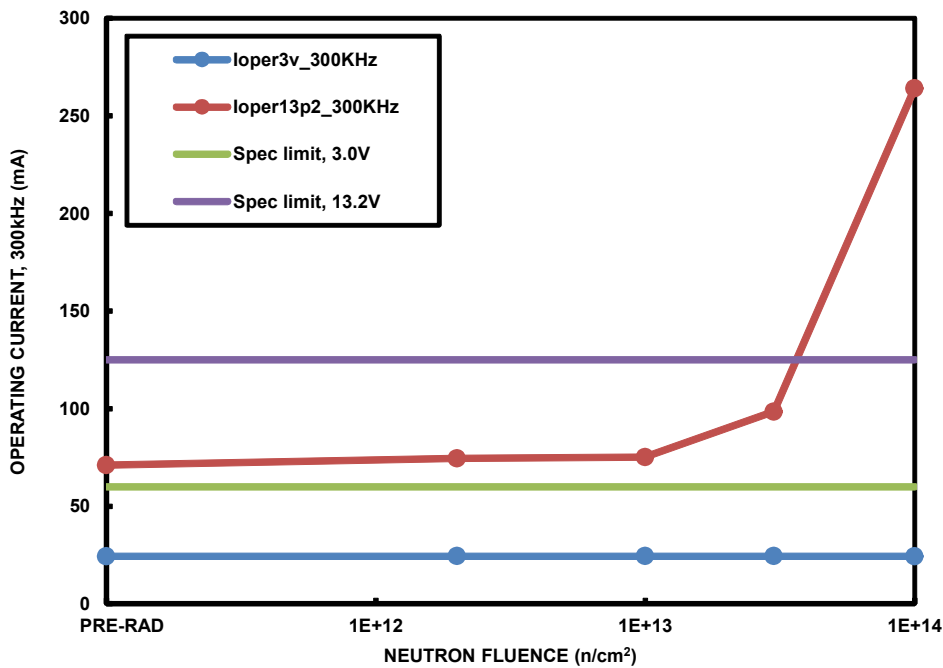

FIGURE 3. ISL70003SEH operating current at 300kHz, 3V (blue) and 13.2V (red) input voltage cases, as a function of neutron irradiation, showing the median of the populations following irradiation to each level. Neutron fluences and sample sizes (in parentheses) were 2×10^{12} n/cm² (5 samples), 1×10^{13} n/cm² (5 samples), 3×10^{13} n/cm² (5 samples) and 1×10^{14} n/cm² (5 samples). The SMD limits are 60.0mA maximum (3V case) and 125.0mA maximum (13.2V case).

Variables Data Plots (Continued)

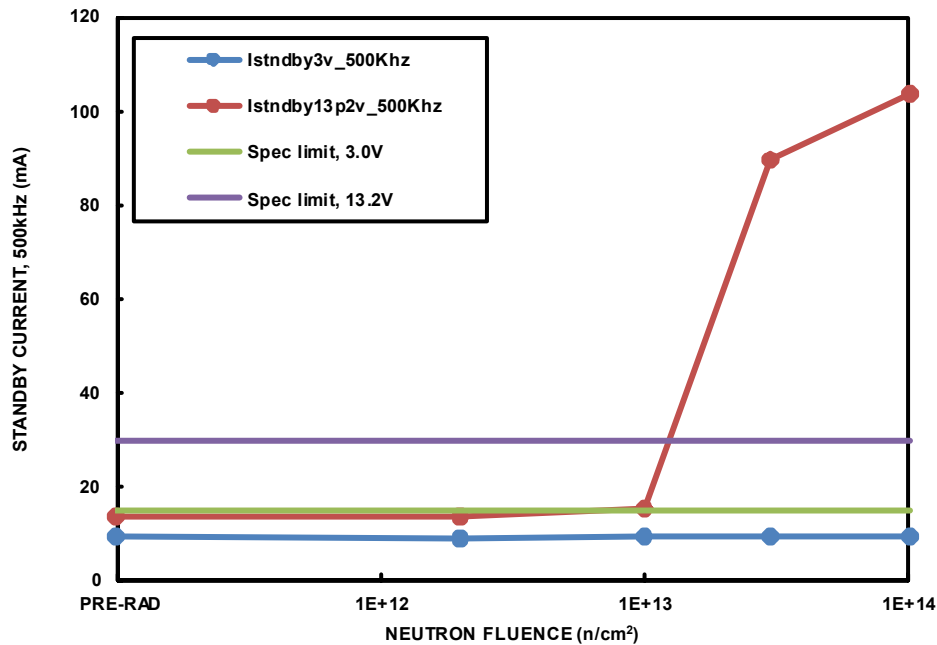

FIGURE 4. ISL70003SEH standby current at 500kHz, 3V (blue) and 13.2V (red) cases, as a function of neutron irradiation, showing the median of the populations following irradiation to each level. Neutron fluences and sample sizes (in parentheses) were 2×10^{12} n/cm² (5 samples), 1×10^{13} n/cm² (5 samples), 3×10^{13} n/cm² (5 samples) and 1×10^{14} n/cm² (5 samples). The SMD limits are 15.0mA maximum (3V case) and 30.0mA maximum (13.2V case).

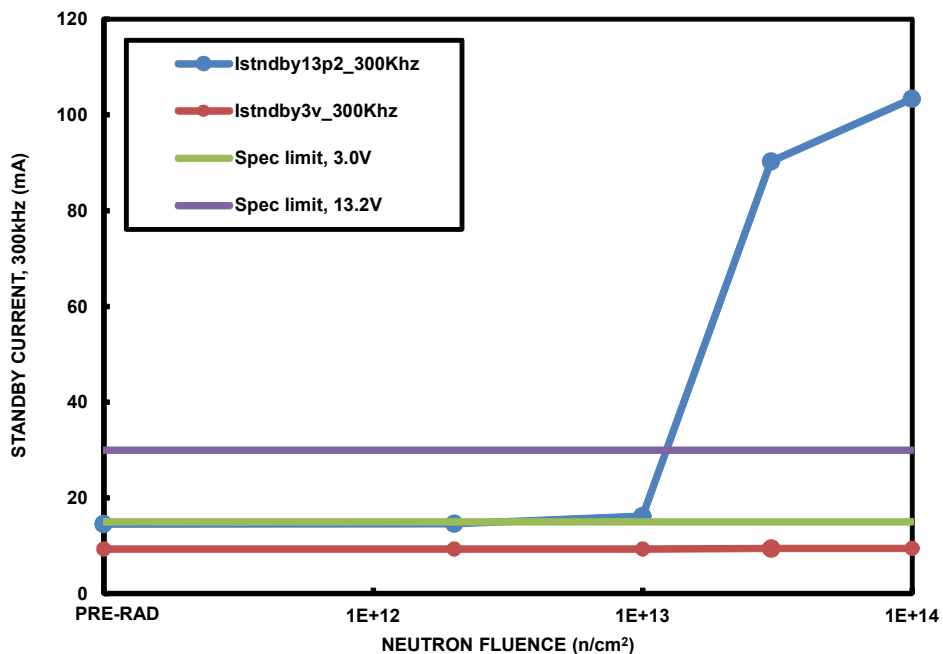

FIGURE 5. ISL70003SEH standby current at 300kHz, 3V (red) and 13.2V (blue) cases, as a function of neutron irradiation, showing the median of the populations following irradiation to each level. Neutron fluences and sample sizes (in parentheses) were 2×10^{12} n/cm² (5 samples), 1×10^{13} n/cm² (5 samples), 3×10^{13} n/cm² (5 samples) and 1×10^{14} n/cm² (5 samples). The SMD limits are 15.0mA maximum (3V case) and 30.0mA maximum (13.2V case).

Variables Data Plots (Continued)

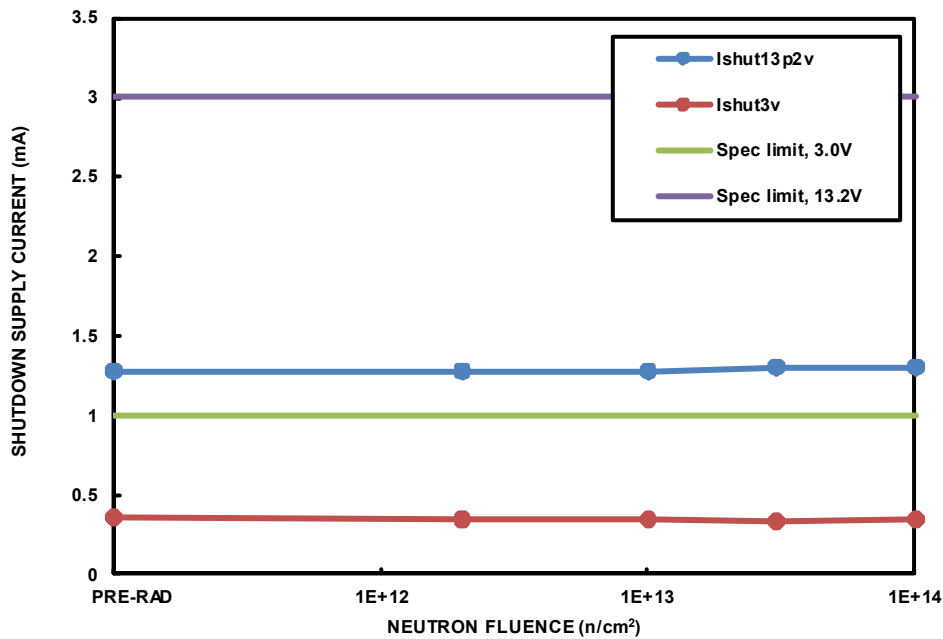

FIGURE 6. ISL70003SEH shutdown ('quiescent') supply current, 3V (red) and 13.2V (blue) cases, as a function of neutron irradiation, showing the median of the populations following irradiation to each level. Neutron fluences and sample sizes (in parentheses) were 1×10^{12} n/cm² (5 samples), 1×10^{13} n/cm² (5 samples), 3×10^{13} n/cm² (5 samples) and 2×10^{14} n/cm² (5 samples). The SMD limits are 1.0mA maximum (3V case) and 3.0mA maximum (13.2V case).

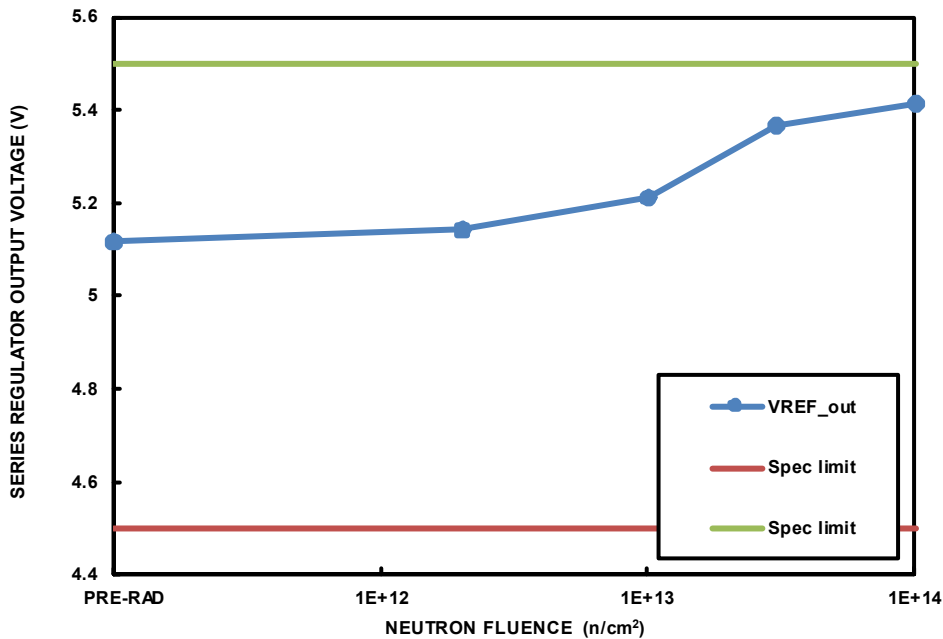

FIGURE 7. ISL70003SEH series regulator output voltage, 13.2V input (blue), as a function of neutron irradiation, showing the median of the populations following irradiation to each level. Neutron fluences and sample sizes (in parentheses) were 2×10^{12} n/cm² (5 samples), 1×10^{13} n/cm² (5 samples), 3×10^{13} n/cm² (5 samples) and 1×10^{14} n/cm² (5 samples). The SMD limits are 4.5V to 5.5V.

Variables Data Plots (Continued)

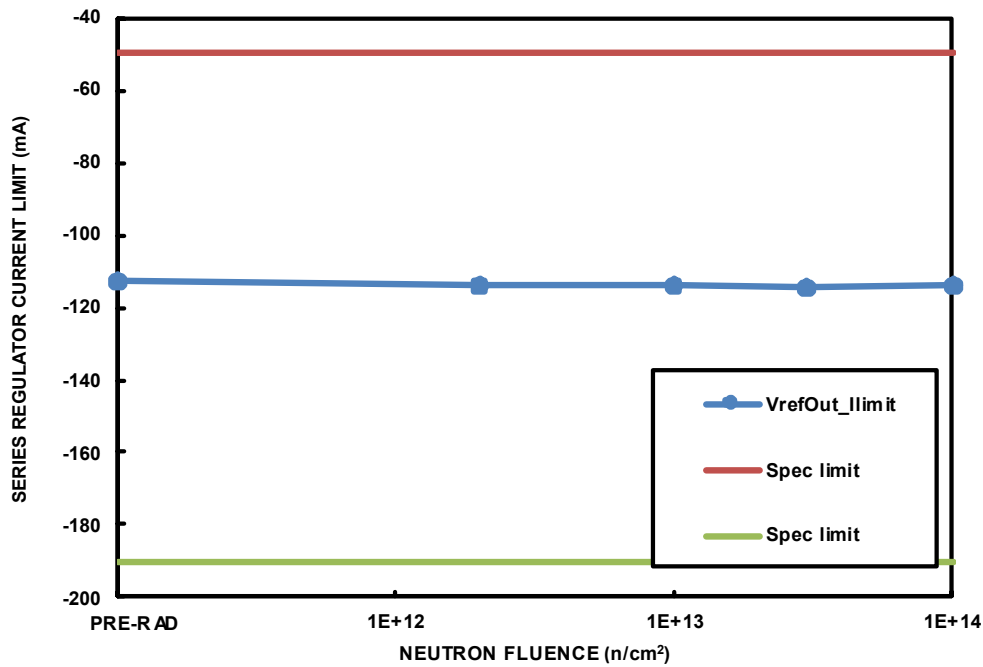

FIGURE 8. ISL70003SEH on-chip series regulator current limit (blue) as a function of neutron irradiation, showing the median of the populations following irradiation to each level. Neutron fluences and sample sizes (in parentheses) were 2×10^{12} n/cm² (5 samples), 1×10^{13} n/cm² (5 samples), 3×10^{13} n/cm² (5 samples) and 1×10^{14} n/cm² (5 samples). The SMD limits are -50.0mA to -190.0mA.

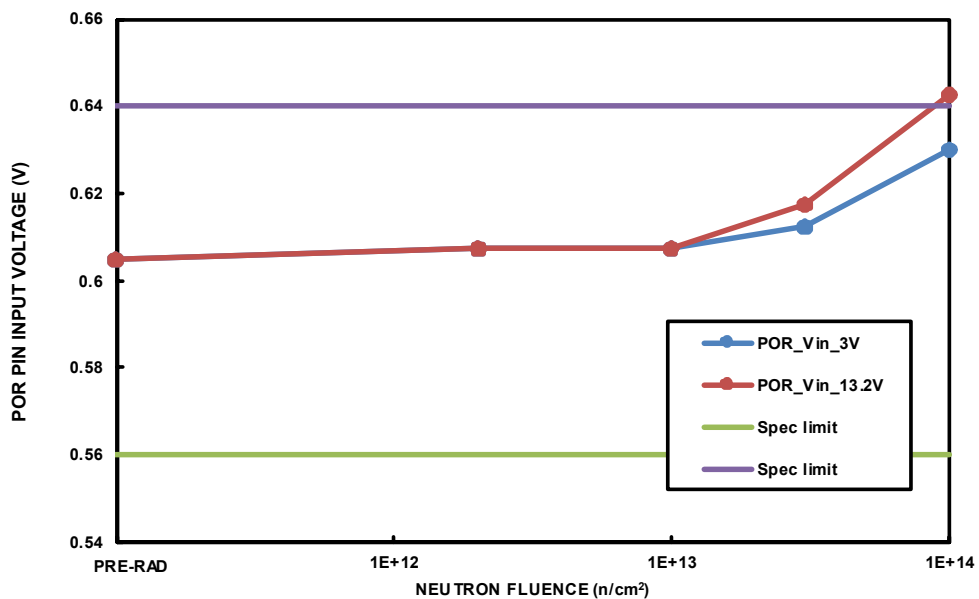

FIGURE 9. ISL70003SEH POR input pin voltage, 3V (blue) and 13.3V (red) cases, as a function of neutron irradiation, showing the median of the populations following irradiation to each level. Neutron fluences and sample sizes (in parentheses) were 2×10^{12} n/cm² (5 samples), 1×10^{13} n/cm² (5 samples), 3×10^{13} n/cm² (5 samples) and 1×10^{14} n/cm² (5 samples). The SMD limits are 0.56V to 0.64V.

Variables Data Plots (Continued)

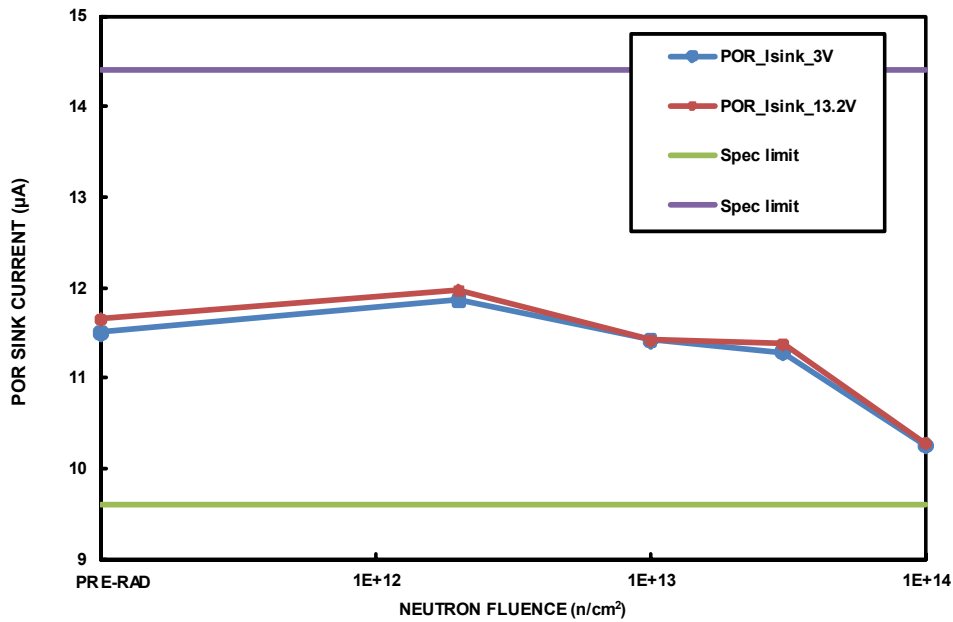

FIGURE 10. ISL70003SEH power on reset (POR) sink current, 3V (blue) and 13.3V (red) cases, as a function of neutron irradiation, showing the median of the populations following irradiation to each level. Neutron fluences and sample sizes (in parentheses) were 2×10^{12} n/cm² (5 samples), 1×10^{13} n/cm² (5 samples), 3×10^{13} n/cm² (5 samples) and 1×10^{14} n/cm² (5 samples). The SMD limits are 9.6mA to 14.4mA.

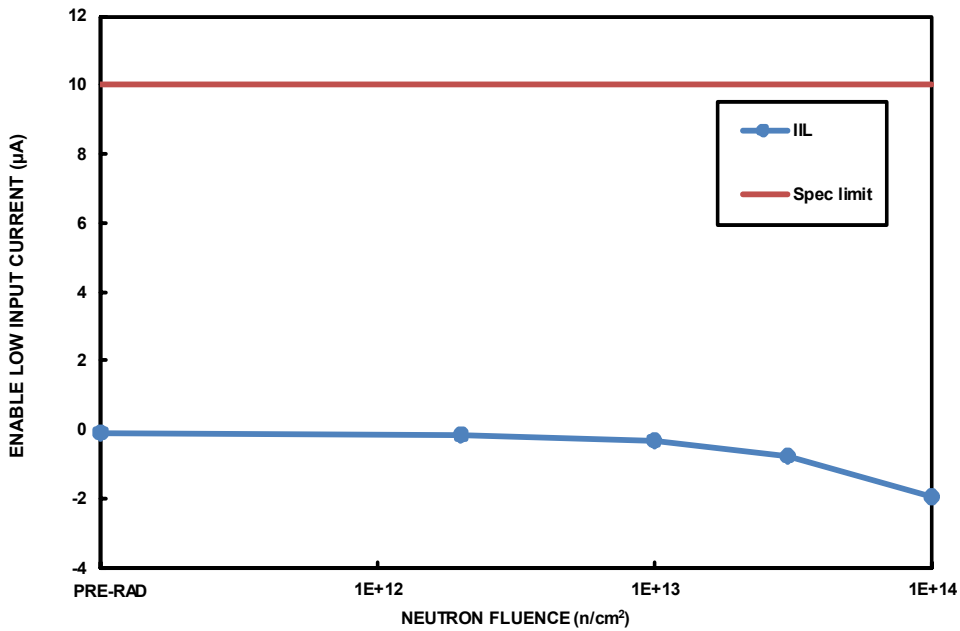

FIGURE 11. ISL70003SEH enable low input current (blue) as a function of neutron irradiation, showing the median of the populations following irradiation to each level. Neutron fluences and sample sizes (in parentheses) were 2×10^{12} n/cm² (5 samples), 1×10^{13} n/cm² (5 samples), 3×10^{13} n/cm² (5 samples) and 1×10^{14} n/cm² (5 samples). The SMD limit is +10.0µA maximum.

Variables Data Plots (Continued)

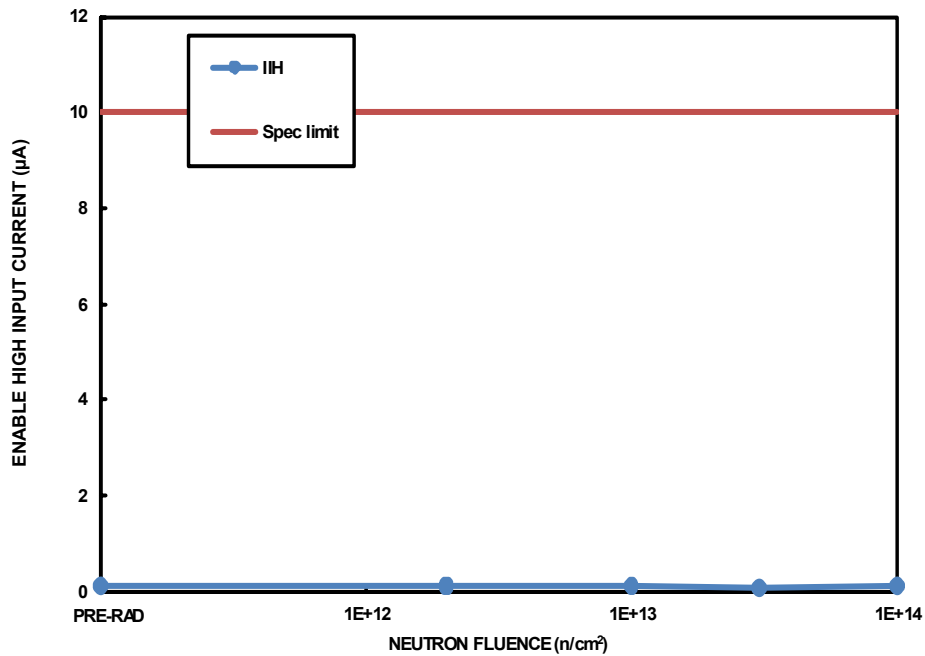

FIGURE 12. ISL70003SEH enable high input current (blue) as a function of neutron irradiation, showing the median of the populations following irradiation to each level. Neutron fluences and sample sizes (in parentheses) were 2×10^{12} n/cm² (5 samples), 1×10^{13} n/cm² (5 samples), 3×10^{13} n/cm² (5 samples) and 1×10^{14} n/cm² (5 samples). The SMD limit is +10.0µA maximum.

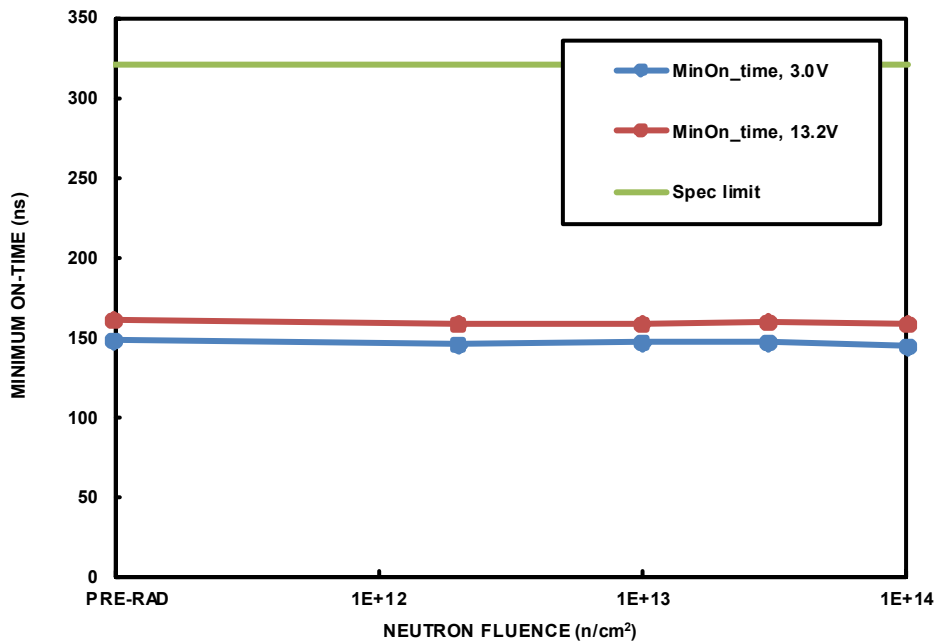

FIGURE 13. ISL70003SEH minimum on-time, 3V (blue) and 13.2V (red) cases, as a function of neutron irradiation, showing the median of the populations following irradiation to each level. Neutron fluences and sample sizes (in parentheses) were 2×10^{12} n/cm² (5 samples), 1×10^{13} n/cm² (5 samples), 3×10^{13} n/cm² (5 samples) and 1×10^{14} n/cm² (5 samples). The SMD limit is 320.0ns maximum.

Variables Data Plots (Continued)

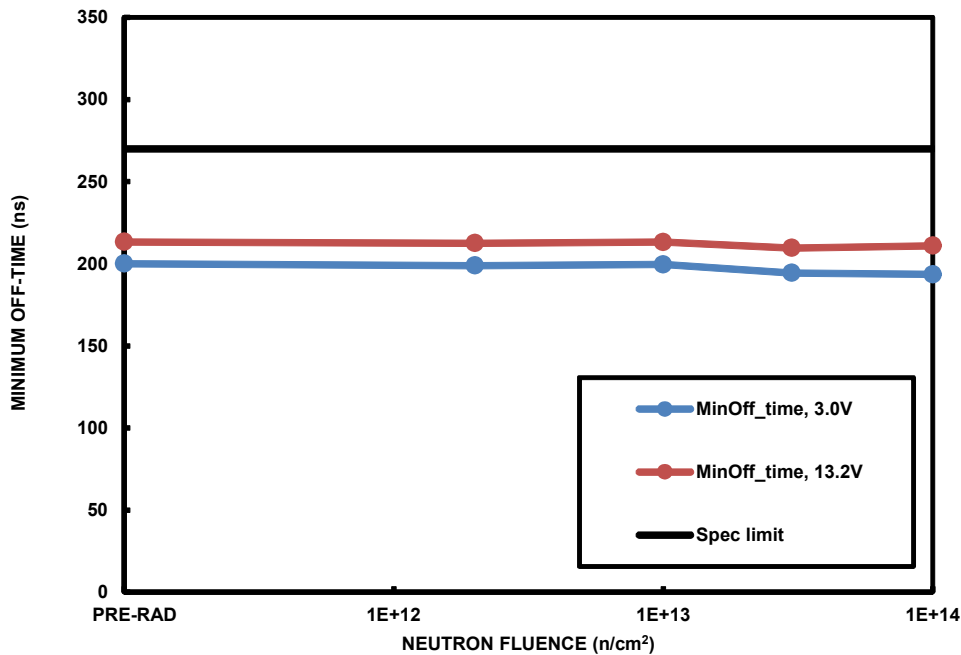

FIGURE 14. ISL70003SEH minimum off-time, 3V (blue) and 13.2V (red) cases, as a function of neutron irradiation, showing the median of the populations following irradiation to each level. Neutron fluences and sample sizes (in parentheses) were 2×10^{12} n/cm² (5 samples), 1×10^{13} n/cm² (5 samples), 3×10^{13} n/cm² (5 samples) and 1×10^{14} n/cm² (5 samples). The SMD limit is 270.0ns maximum.

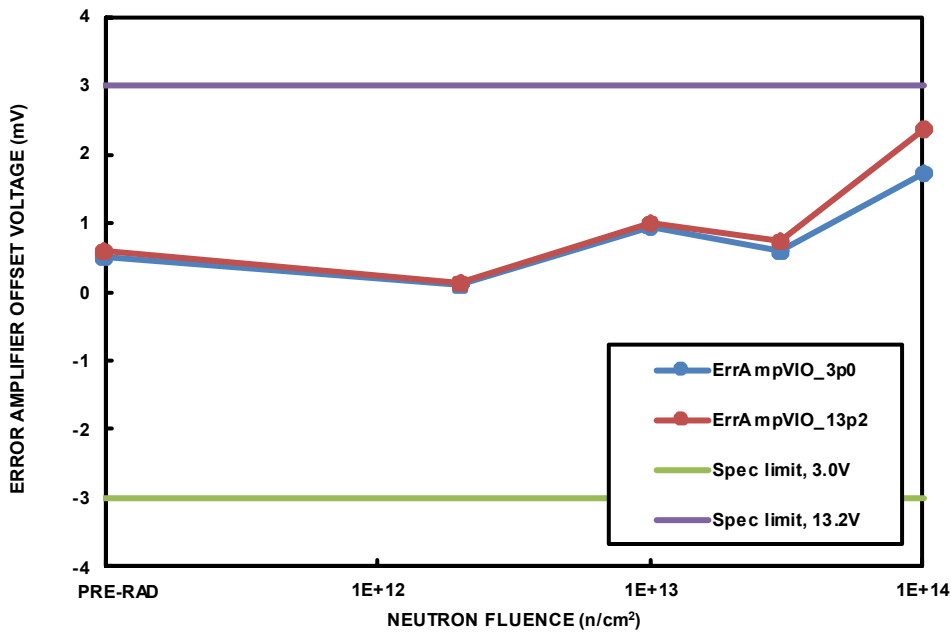

FIGURE 15. ISL70003SEH error amplifier input offset voltage, 3V (blue) and 13.2V (red) cases as a function of neutron irradiation, showing the median of the populations following irradiation to each level. Neutron fluences and sample sizes (in parentheses) were 2×10^{12} n/cm² (5 samples), 1×10^{13} n/cm² (5 samples), 3×10^{13} n/cm² (5 samples) and 1×10^{14} n/cm² (5 samples). The SMD limits are -3.0mV to 3.0mV.

Variables Data Plots (Continued)

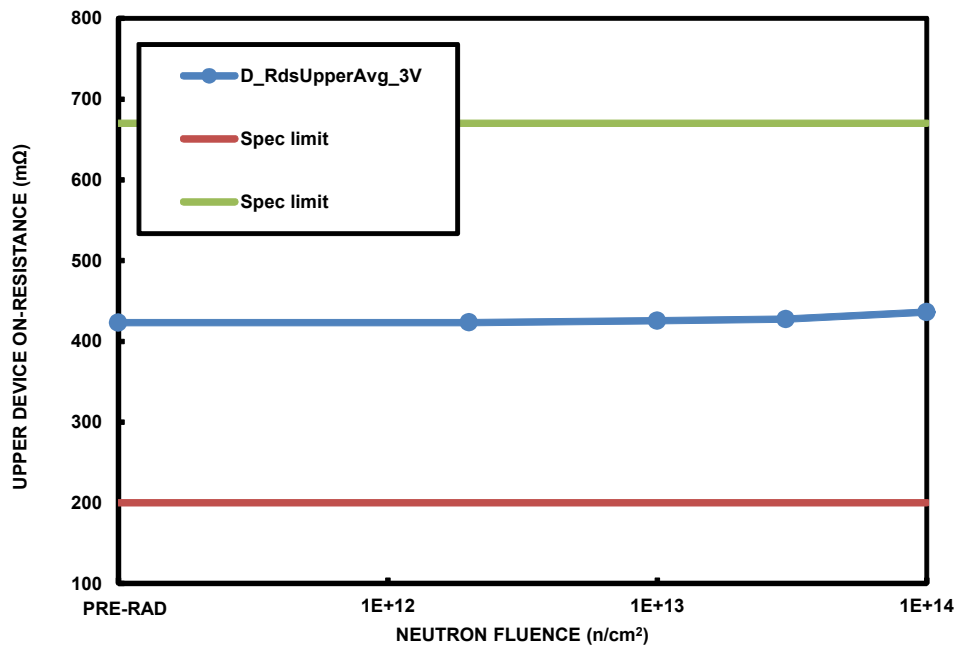

FIGURE 16. ISL70003SEH average upper device ON-resistance at 3V in (blue), ten power blocks, as a function of neutron irradiation, showing the median of the populations following irradiation to each level. Neutron fluences and sample sizes (in parentheses) were 2×10^{12} n/cm² (5 samples), 1×10^{13} n/cm² (5 samples), 3×10^{13} n/cm² (5 samples) and 1×10^{14} n/cm² (5 samples). The SMD limits are 170.0mΩ to 700.0mΩ.

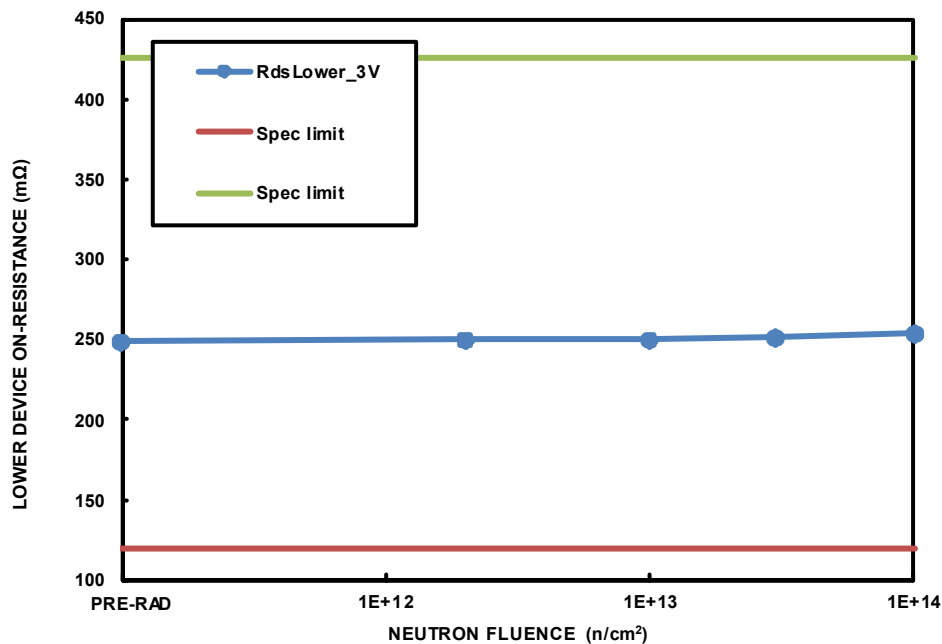

FIGURE 17. ISL70003SEH average lower device ON-resistance at 3V in (blue), ten power blocks, as a function of neutron irradiation, showing the median of the populations following irradiation to each level. Neutron fluences and sample sizes (in parentheses) were 2×10^{12} n/cm² (5 samples), 1×10^{13} n/cm² (5 samples), 3×10^{13} n/cm² (5 samples) and 1×10^{14} n/cm² (5 samples). The SMD limits are 90.0mΩ to 455.0mΩ.

Variables Data Plots (Continued)

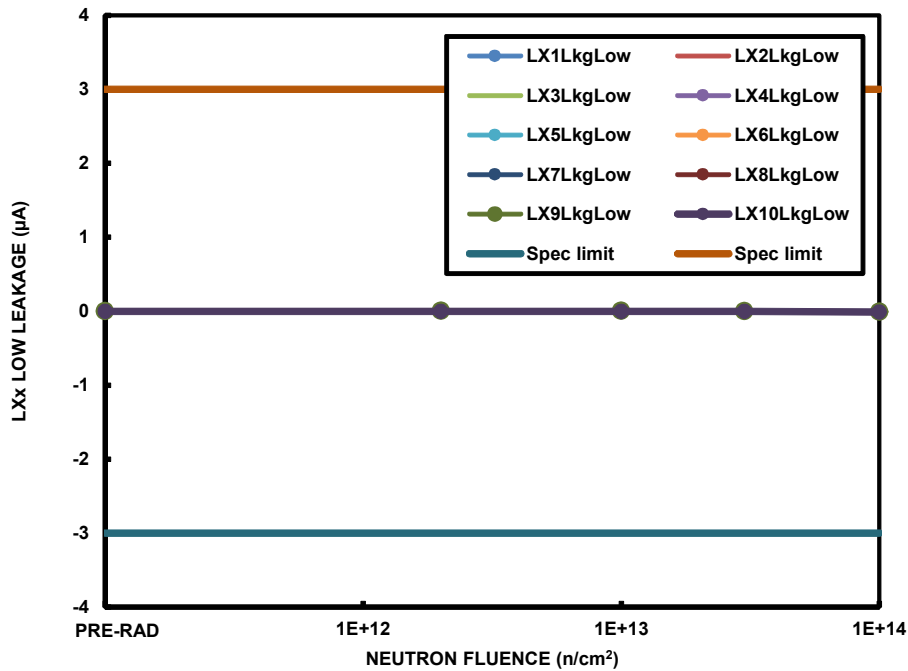

FIGURE 18. ISL70003SEH LXx low leakage current, each of ten power blocks, as a function of neutron irradiation, showing the median of the populations following irradiation to each level. Neutron fluences and sample sizes (in parentheses) were 2×10^{12} n/cm² (5 samples), 1×10^{13} n/cm² (5 samples), 3×10^{13} n/cm² (5 samples) and 1×10^{14} n/cm² (5 samples). The SMD limits are -3.0µA to +3.0µA.

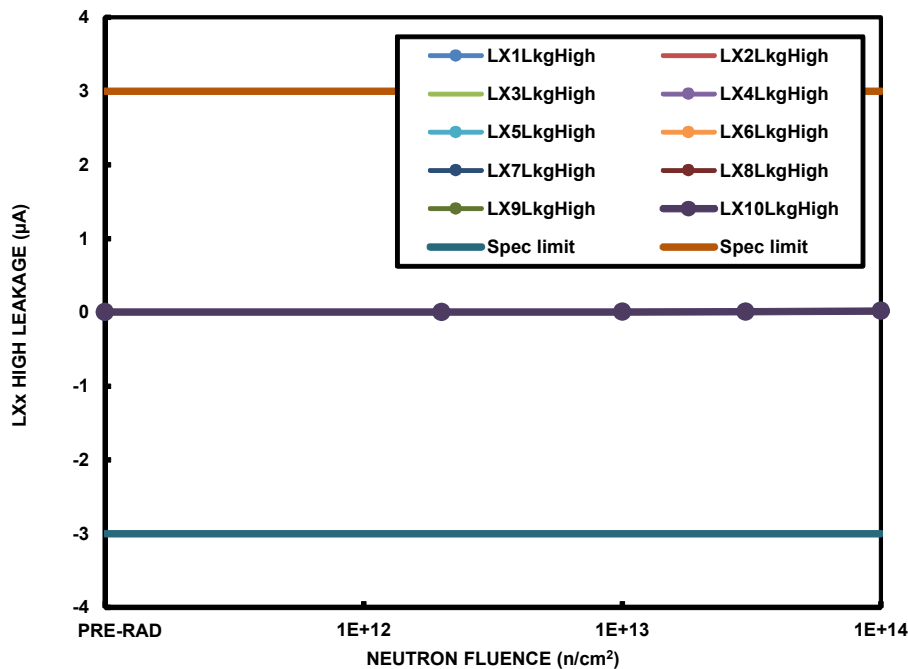

FIGURE 19. ISL70003SEH LXx high leakage current, each of ten power blocks, as a function of neutron irradiation, showing the median of the populations following irradiation to each level. Neutron fluences and sample sizes (in parentheses) were 2×10^{12} n/cm² (5 samples), 1×10^{13} n/cm² (5 samples), 3×10^{13} n/cm² (5 samples) and 1×10^{14} n/cm² (5 samples). The SMD limits are -3.0µA to +3.0µA.

Variables Data Plots (Continued)

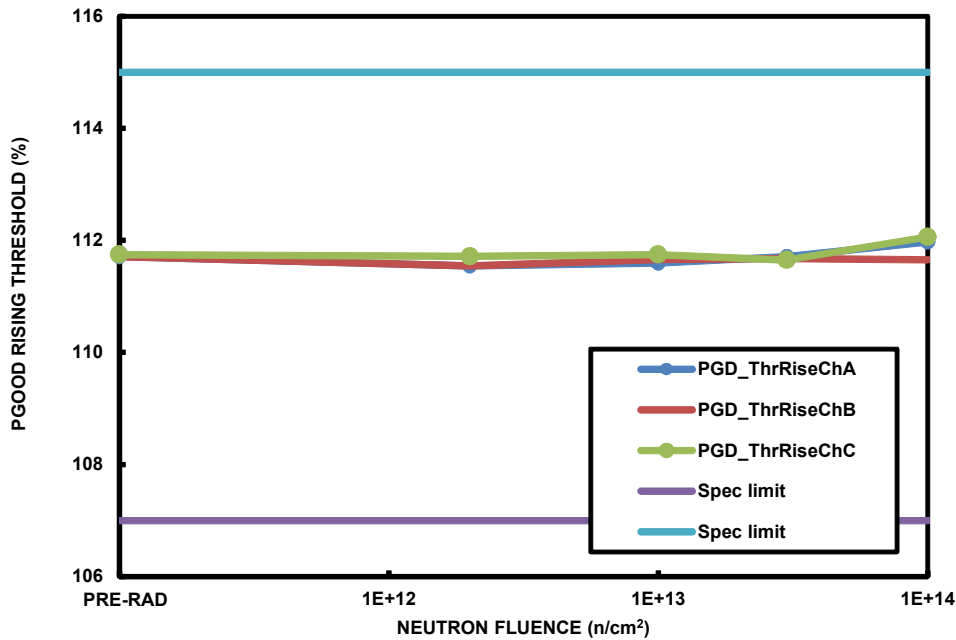

FIGURE 20. ISL70003SEH PG00D rising threshold, channels A (blue), B (red) and C (green), as a function of neutron irradiation, showing the median of the populations following irradiation to each level. Neutron fluences and sample sizes (in parentheses) were 2×10^{12} n/cm² (5 samples), 1×10^{13} n/cm² (5 samples), 3×10^{13} n/cm² (5 samples) and 1×10^{14} n/cm² (5 samples). The SMD limits are 107% to 118%.

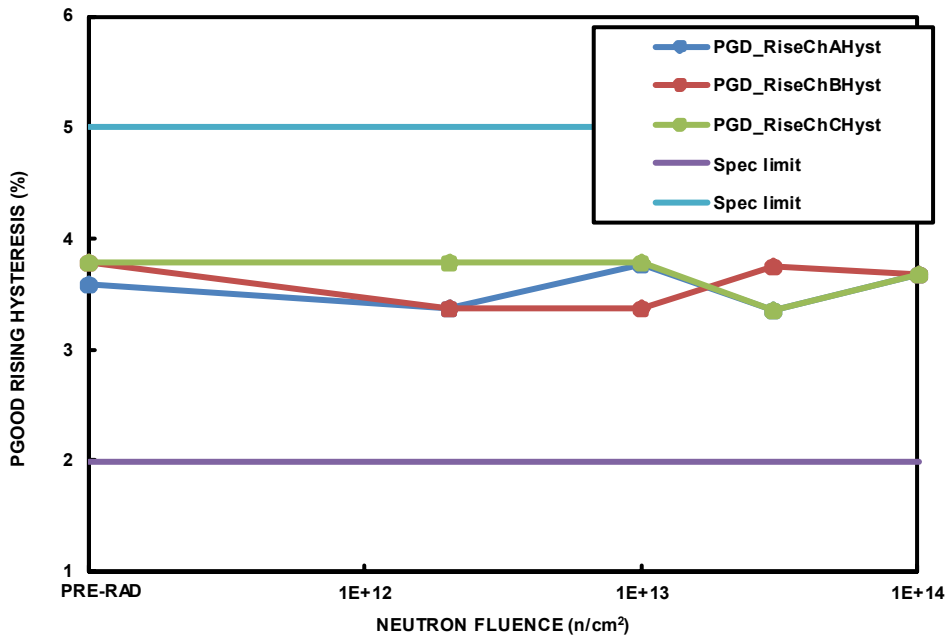

FIGURE 21. ISL70003SEH PG00D rising hysteresis, channels A (blue), B (red) and C (green), as a function of neutron irradiation, showing the median of the populations following irradiation to each level. Neutron fluences and sample sizes (in parentheses) were 2×10^{12} n/cm² (5 samples), 1×10^{13} n/cm² (5 samples), 3×10^{13} n/cm² (5 samples) and 1×10^{14} n/cm² (5 samples). The SMD limits are 2% to 5%.

Variables Data Plots (Continued)

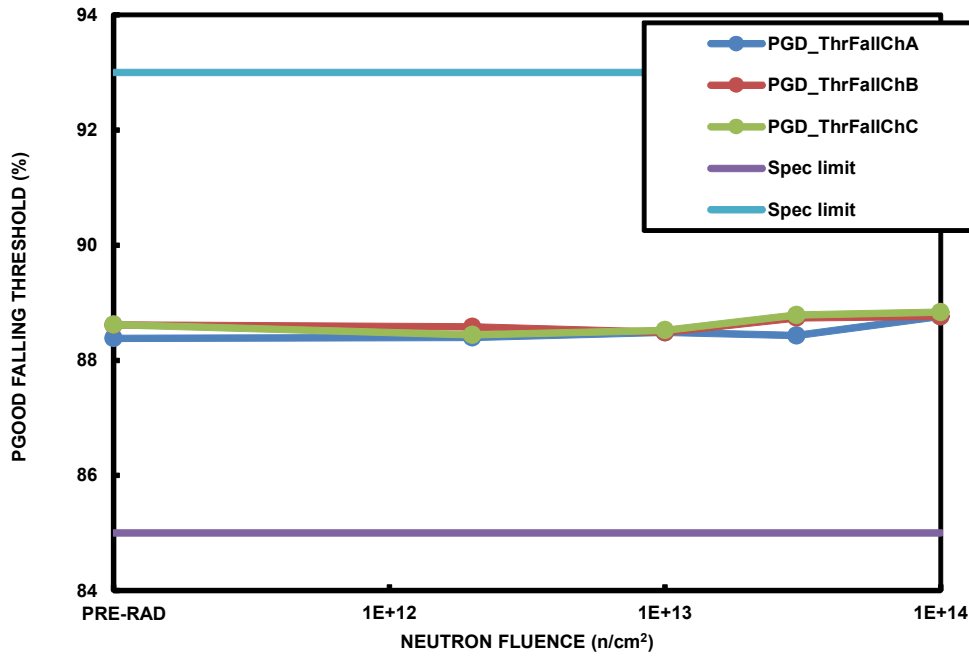

FIGURE 22. ISL70003SEH PGOOD falling threshold, channels A (blue), B (red) and C (green), as a function of neutron irradiation, showing the median of the populations following irradiation to each level. Neutron fluences and sample sizes (in parentheses) were 2×10^{12} n/cm² (5 samples), 1×10^{13} n/cm² (5 samples), 3×10^{13} n/cm² (5 samples) and 1×10^{14} n/cm² (5 samples). The SMD limits are 85% to 93%.

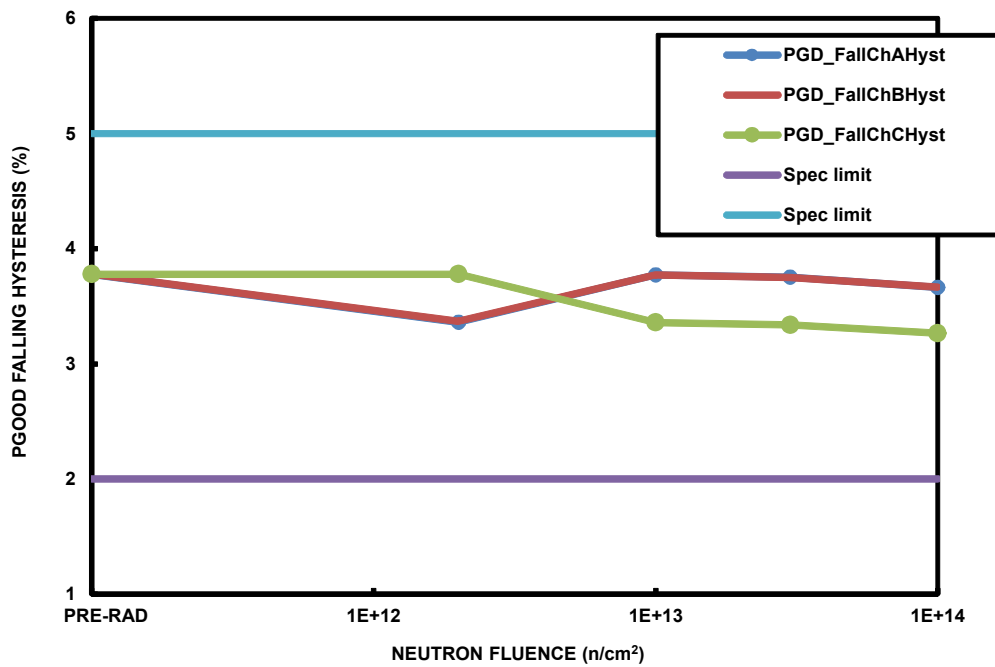

FIGURE 23. ISL70003SEH PGOOD falling hysteresis, channels A (blue), B (red) and C (green), as a function of neutron irradiation, showing the median of the populations following irradiation to each level. Neutron fluences and sample sizes (in parentheses) were 2×10^{12} n/cm² (5 samples), 1×10^{13} n/cm² (5 samples), 3×10^{13} n/cm² (5 samples) and 1×10^{14} n/cm² (5 samples). The SMD limits are 2% to 5%.

Variables Data Plots (Continued)

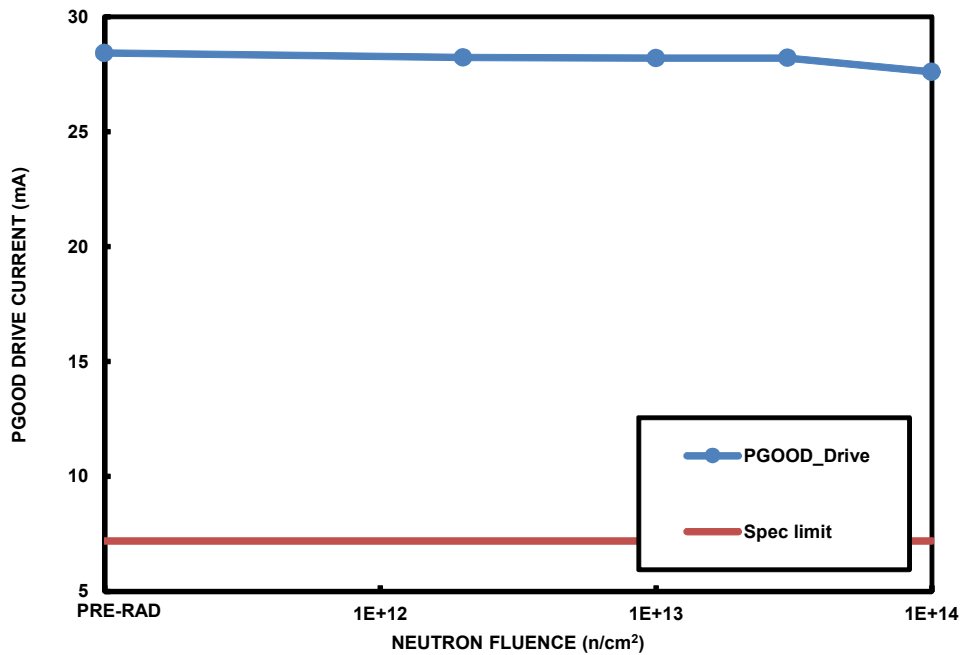

FIGURE 24. ISL70003SEH Power-Good (PGOOD) output drive current, 3V in (blue), as a function of neutron irradiation, showing the median of the populations following irradiation to each level. Neutron fluences and sample sizes (in parentheses) were 2×10^{12} n/cm² (5 samples), 1×10^{13} n/cm² (5 samples), 3×10^{13} n/cm² (5 samples) and 1×10^{14} n/cm² (5 samples). The SMD limit is 7.2mA minimum.

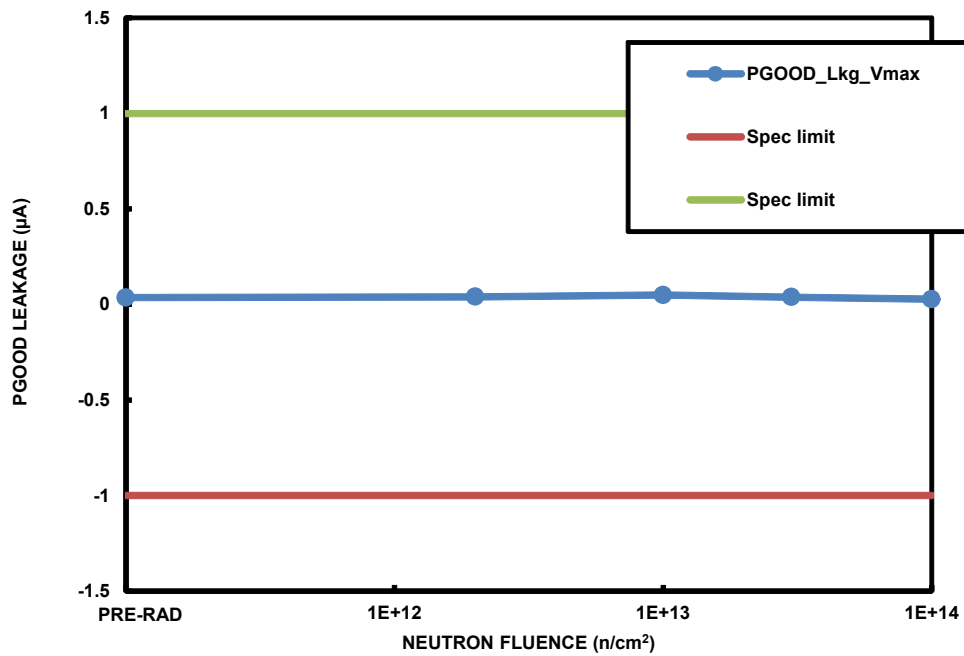

FIGURE 25. ISL70003SEH PGGOOD output leakage, 3V in (blue), as a function of neutron irradiation, showing the median of the populations following irradiation to each level. Neutron fluences and sample sizes (in parentheses) were 2×10^{12} n/cm² (5 samples), 1×10^{13} n/cm² (5 samples), 3×10^{13} n/cm² (5 samples) and 1×10^{14} n/cm² (5 samples). The SMD limits are -1.0µA to +1.0µA.

Variables Data Plots (Continued)

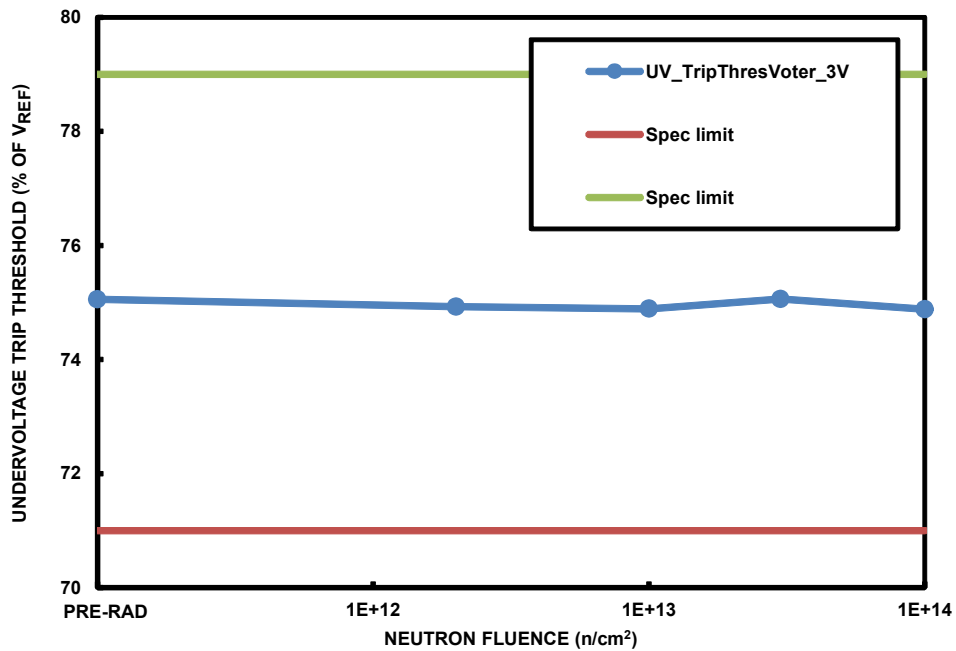

FIGURE 26. ISL70003SEH undervoltage trip threshold (blue) as a function of neutron irradiation, showing the median of the populations following irradiation to each level. Neutron fluences and sample sizes (in parentheses) were 2 x 10¹² n/cm² (5 samples), 1 x 10¹³ n/cm² (5 samples), 3 x 10¹³ n/cm² (5 samples) and 1 x 10¹⁴ n/cm² (5 samples). The SMD limits are 71% to 79%.

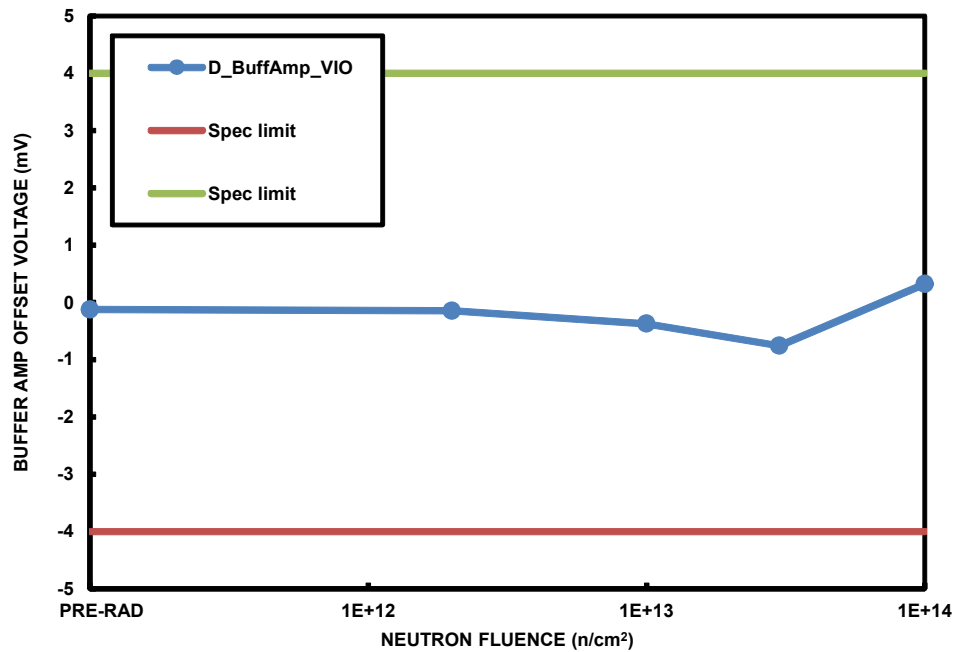

FIGURE 27. ISL70003SEH buffer amplifier input offset voltage (blue) as a function of neutron irradiation, showing the median of the populations following irradiation to each level. Neutron fluences and sample sizes (in parentheses) were 2 x 10¹² n/cm² (5 samples), 1 x 10¹³ n/cm² (5 samples), 3 x 10¹³ n/cm² (5 samples) and 1 x 10¹⁴ n/cm² (5 samples). The data sheet limits are -4mV to 4mV.

Variables Data Plots (Continued)

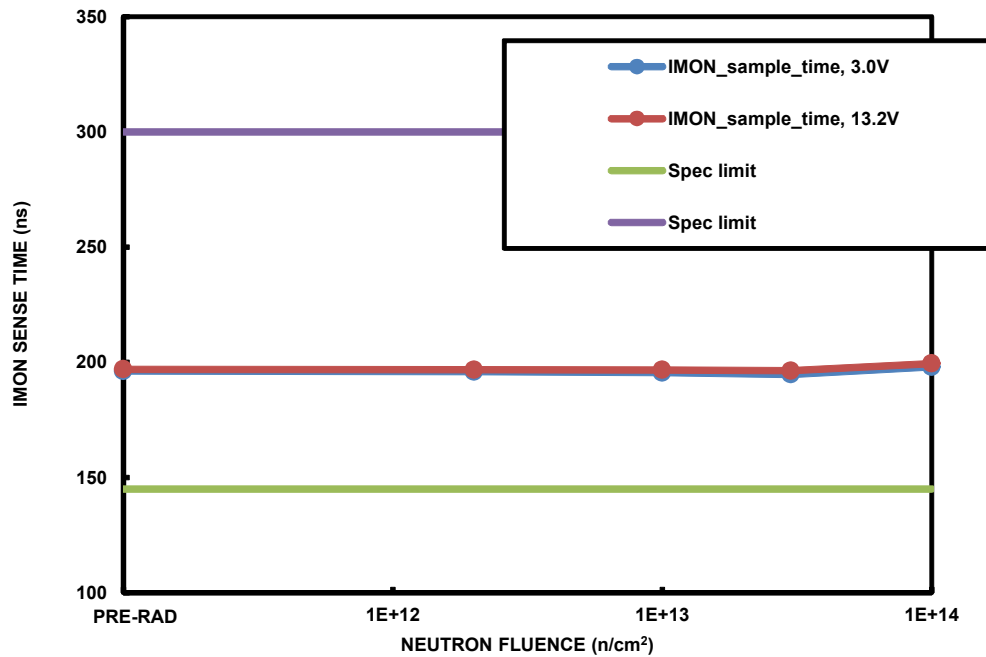

FIGURE 28. ISL70003SEH current monitor (IMON) sense time for the 3V (blue) and 13.2V (red) cases, as a function of neutron irradiation, showing the median of the populations following irradiation to each level. Neutron fluences and sample sizes (in parentheses) were 2×10^{12} n/cm² (5 samples), 1×10^{13} n/cm² (5 samples), 3×10^{13} n/cm² (5 samples) and 1×10^{14} n/cm² (5 samples). The SMD limits are 145ns to 300ns.

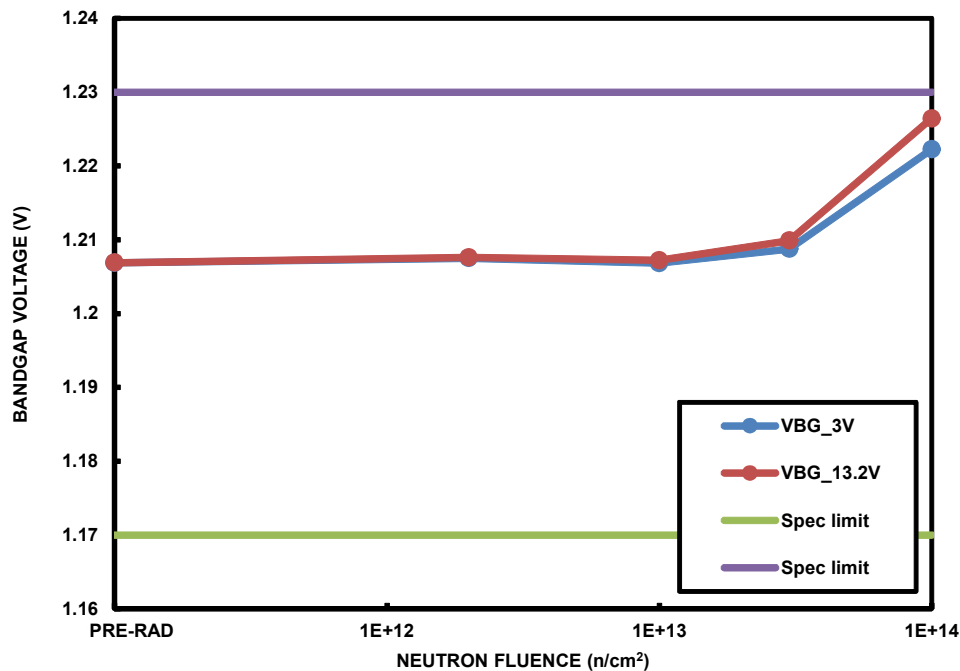

FIGURE 29. ISL70003SEH bandgap voltage for the 3V (blue) and 13.2V (red) cases, as a function of neutron irradiation, showing the median of the populations following irradiation to each level. Neutron fluences and sample sizes (in parentheses) were 2×10^{12} n/cm² (5 samples), 1×10^{13} n/cm² (5 samples), 3×10^{13} n/cm² (5 samples) and 1×10^{14} n/cm² (5 samples). The SMD limits are 1.17V to 1.23V.

Discussion and Conclusion

This document reports the results of 1MeV equivalent neutron testing of the ISL70003SEH hardened Point-of-Load (POL) regulator. Parts were tested at 2×10^{12} n/cm², 1×10^{13} n/cm², 3×10^{13} n/cm² and 1×10^{14} n/cm². The data is reported in [Figures 2](#) through [29](#), show plots of key parameters before and after irradiation to each level. The plots show the median of each parameter as a function of neutron irradiation. The figures also show the applicable electrical limits taken from the SMD; it should be carefully noted that these limits are provided for

guidance only as the ISL70003SEH is not specified for the neutron environment. All samples passed the SMD limits after 2×10^{12} and 1×10^{13} n/cm² but failed after 3×10^{13} and 1×10^{14} n/cm².

TABLE 2. REPORTED PARAMETERS

FIGURE	PARAMETER	LIMIT, LOW	LIMIT, HIGH	UNITS	NOTES
2	Operating Current, 500kHz	-	60/25	mA	3V and 13.2V _{IN}
3	Operating Current, 300kHz	-	60/25	mA	3V and 13.2V _{IN}
4	Standby Current, 500kHz	-	15/30	mA	3V and 13.2V _{IN}
5	Standby Current, 300kHz	-	15/30	mA	3V and 13.2V _{IN}
6	Shutdown Current, 500kHz	-	1/3	mA	3V and 13.2V _{IN}
7	Series Regulator Output Voltage	4.5	5.5	V	13.2V _{IN}
8	Series Regulator Current Limit	-50	-190	mA	13.2V _{IN}
9	POR Input Pin Voltage	0.56	0.64	V	3V and 13.2V _{IN}
10	POR Sink Current	9.6	14.4	mA	3V and 13.2V _{IN}
11	Enable low Input Current	-	10.0	μA	13.2V _{IN}
12	Enable high Input Current	-	10.0	μA	13.2V _{IN}
13	Minimum On-Time	-	320	ns	3V and 13.2V _{IN}
14	Minimum Off-Time	-	270	ns	3V and 13.2V _{IN}
15	Error Amplifier Offset Voltage	-3	3	mV	3V and 13.2V _{IN}
16	Upper Device ON-Resistance	170	700	mΩ	3V and 13.2V _{IN}
17	Lower Device ON-Resistance	90	455	mΩ	3V and 13.2V _{IN}
18	LXx low Leakage Current	-3	3	μA	3V _{IN}
19	LXx high Leakage Current	-3	3	μA	3V _{IN}
20	PGOOD Rising Threshold	107	118	%	3V _{IN}
21	PGOOD Rising Hysteresis	2	5	%	3V _{IN}
22	PGOOD Falling Threshold	85	93	%	3V _{IN}
23	PGOOD Falling Hysteresis	2	5	%	3V _{IN}
24	PGOOD Output Drive Current	7.2	-	mA	3V _{IN}
25	PGOOD Output Leakage	-1	1	μA	3V _{IN}
26	Undervoltage Trip Threshold	71	79	%	3V _{IN}
27	Buffer Amplifier Offset Voltage	-4	4	mV	3V _{IN}
28	Current Monitor Sense Time	145	300	ns	3V and 13.2V _{IN}
29	Bandgap Output Voltage	1.17	1.23	V	3V and 13.2V _{IN}

Notice

1. Descriptions of circuits, software and other related information in this document are provided only to illustrate the operation of semiconductor products and application examples. You are fully responsible for the incorporation or any other use of the circuits, software, and information in the design of your product or system. Renesas Electronics disclaims any and all liability for any losses and damages incurred by you or third parties arising from the use of these circuits, software, or information.
2. Renesas Electronics hereby expressly disclaims any warranties against and liability for infringement or any other claims involving patents, copyrights, or other intellectual property rights of third parties, by or arising from the use of Renesas Electronics products or technical information described in this document, including but not limited to, the product data, drawings, charts, programs, algorithms, and application examples.
3. No license, express, implied or otherwise, is granted hereby under any patents, copyrights or other intellectual property rights of Renesas Electronics or others.
4. You shall not alter, modify, copy, or reverse engineer any Renesas Electronics product, whether in whole or in part. Renesas Electronics disclaims any and all liability for any losses or damages incurred by you or third parties arising from such alteration, modification, copying or reverse engineering.
5. Renesas Electronics products are classified according to the following two quality grades: "Standard" and "High Quality". The intended applications for each Renesas Electronics product depends on the product's quality grade, as indicated below.
"Standard": Computers; office equipment; communications equipment; test and measurement equipment; audio and visual equipment; home electronic appliances; machine tools; personal electronic equipment; industrial robots; etc.
"High Quality": Transportation equipment (automobiles, trains, ships, etc.); traffic control (traffic lights); large-scale communication equipment; key financial terminal systems; safety control equipment; etc.
Unless expressly designated as a high reliability product or a product for harsh environments in a Renesas Electronics data sheet or other Renesas Electronics document, Renesas Electronics products are not intended or authorized for use in products or systems that may pose a direct threat to human life or bodily injury (artificial life support devices or systems; surgical implantations; etc.), or may cause serious property damage (space system; undersea repeaters; nuclear power control systems; aircraft control systems; key plant systems; military equipment; etc.). Renesas Electronics disclaims any and all liability for any damages or losses incurred by you or any third parties arising from the use of any Renesas Electronics product that is inconsistent with any Renesas Electronics data sheet, user's manual or other Renesas Electronics document.
6. When using Renesas Electronics products, refer to the latest product information (data sheets, user's manuals, application notes, "General Notes for Handling and Using Semiconductor Devices" in the reliability handbook, etc.), and ensure that usage conditions are within the ranges specified by Renesas Electronics with respect to maximum ratings, operating power supply voltage range, heat dissipation characteristics, installation, etc. Renesas Electronics disclaims any and all liability for any malfunctions, failure or accident arising out of the use of Renesas Electronics products outside of such specified ranges.
7. Although Renesas Electronics endeavors to improve the quality and reliability of Renesas Electronics products, semiconductor products have specific characteristics, such as the occurrence of failure at a certain rate and malfunctions under certain use conditions. Unless designated as a high reliability product or a product for harsh environments in a Renesas Electronics data sheet or other Renesas Electronics document, Renesas Electronics products are not subject to radiation resistance design. You are responsible for implementing safety measures to guard against the possibility of bodily injury, injury or damage caused by fire, and/or danger to the public in the event of a failure or malfunction of Renesas Electronics products, such as safety design for hardware and software, including but not limited to redundancy, fire control and malfunction prevention, appropriate treatment for aging degradation or any other appropriate measures. Because the evaluation of microcomputer software alone is very difficult and impractical, you are responsible for evaluating the safety of the final products or systems manufactured by you.
8. Please contact a Renesas Electronics sales office for details as to environmental matters such as the environmental compatibility of each Renesas Electronics product. You are responsible for carefully and sufficiently investigating applicable laws and regulations that regulate the inclusion or use of controlled substances, including without limitation, the EU RoHS Directive, and using Renesas Electronics products in compliance with all these applicable laws and regulations. Renesas Electronics disclaims any and all liability for damages or losses occurring as a result of your noncompliance with applicable laws and regulations.
9. Renesas Electronics products and technologies shall not be used for or incorporated into any products or systems whose manufacture, use, or sale is prohibited under any applicable domestic or foreign laws or regulations. You shall comply with any applicable export control laws and regulations promulgated and administered by the governments of any countries asserting jurisdiction over the parties or transactions.
10. It is the responsibility of the buyer or distributor of Renesas Electronics products, or any other party who distributes, disposes of, or otherwise sells or transfers the product to a third party, to notify such third party in advance of the contents and conditions set forth in this document.
11. This document shall not be reprinted, reproduced or duplicated in any form, in whole or in part, without prior written consent of Renesas Electronics.
12. Please contact a Renesas Electronics sales office if you have any questions regarding the information contained in this document or Renesas Electronics products.
(Note 1) "Renesas Electronics" as used in this document means Renesas Electronics Corporation and also includes its directly or indirectly controlled subsidiaries.
(Note 2) "Renesas Electronics product(s)" means any product developed or manufactured by or for Renesas Electronics.

(Rev.4.0-1 November 2017)



SALES OFFICES

Renesas Electronics Corporation

<http://www.renesas.com>

Refer to "<http://www.renesas.com/>" for the latest and detailed information.

Renesas Electronics America Inc.
1001 Murphy Ranch Road, Milpitas, CA 95035, U.S.A.
Tel: +1-408-432-8888, Fax: +1-408-434-5351

Renesas Electronics Canada Limited
9251 Yonge Street, Suite 8309 Richmond Hill, Ontario Canada L4C 9T3
Tel: +1-905-237-2004

Renesas Electronics Europe Limited
Dukes Meadow, Millboard Road, Bourne End, Buckinghamshire, SL8 5FH, U.K
Tel: +44-1628-651-700, Fax: +44-1628-651-804

Renesas Electronics Europe GmbH
Arcadiastrasse 10, 40472 Düsseldorf, Germany
Tel: +49-211-6503-0, Fax: +49-211-6503-1327

Renesas Electronics (China) Co., Ltd.
Room 1709 Quantum Plaza, No.27 ZhichunLu, Haidian District, Beijing, 100191 P. R. China
Tel: +86-10-8235-1155, Fax: +86-10-8235-7679

Renesas Electronics (Shanghai) Co., Ltd.
Unit 301, Tower A, Central Towers, 555 Langao Road, Putuo District, Shanghai, 200333 P. R. China
Tel: +86-21-2226-0888, Fax: +86-21-2226-0999

Renesas Electronics Hong Kong Limited
Unit 1601-1611, 16/F., Tower 2, Grand Century Place, 193 Prince Edward Road West, Mongkok, Kowloon, Hong Kong
Tel: +852-2265-6688, Fax: +852-2886-9022

Renesas Electronics Taiwan Co., Ltd.
13F, No. 363, Fu Shing North Road, Taipei 10543, Taiwan
Tel: +886-2-8175-9600, Fax: +886-2-8175-9670

Renesas Electronics Singapore Pte. Ltd.
80 Bendemeer Road, Unit #06-02 Hyflux Innovation Centre, Singapore 339949
Tel: +65-6213-0200, Fax: +65-6213-0300

Renesas Electronics Malaysia Sdn.Bhd.
Unit 1207, Block B, Menara Amcorp, Amcorp Trade Centre, No. 18, Jln Persiaran Barat, 46050 Petaling Jaya, Selangor Darul Ehsan, Malaysia
Tel: +60-3-7955-9390, Fax: +60-3-7955-9510

Renesas Electronics India Pvt. Ltd.
No.777C, 100 Feet Road, HAL 2nd Stage, Indiranagar, Bangalore 560 038, India
Tel: +91-80-67208700, Fax: +91-80-67208777

Renesas Electronics Korea Co., Ltd.
17F, KAMCO Yangjae Tower, 262, Gangnam-daero, Gangnam-gu, Seoul, 06265 Korea
Tel: +82-2-558-3737, Fax: +82-2-558-5338