



Quick Start Guide: YROTATE-IT-RX66T

Document Contents

1.0	Introduction	1
2.0	Board Layout	2
3.0	Initial Board Configuration	3
4.0	PC Graphical User Interface (GUI) Software Installation	4
5.0	Installing USB Drivers	5
6.0	Using the Graphical User Interface (GUI)	6
7.0	Additional material	8
8.0	Support	9

1.0 Introduction

Welcome to the Renesas Motor Control RX66T reference kit!

This quick start guide assists the user to connect and use the YROTATE-IT-RX66T motor control kit for the first time. The RX66T microcontroller flash memory is pre-programmed with a motor control project. Please check the contents of the kit using the supplied package contents list and notify your supplier if any are missing.

Please be informed that the most updated documents related to the kit must be downloaded on the following website after a quick registration:

<https://www.renesas.com/eu/en/solutions/key-technology/motor-control.html>

No CD-ROM nor DVD-ROM are provided in the kit.

Note: PLEASE DO NOT CONNECT THE BOARD TO THE HOST PC BEFORE INSTRUCTED

Quick Start Guide: YROTATE-IT-RX66T

2.0 Board Layout

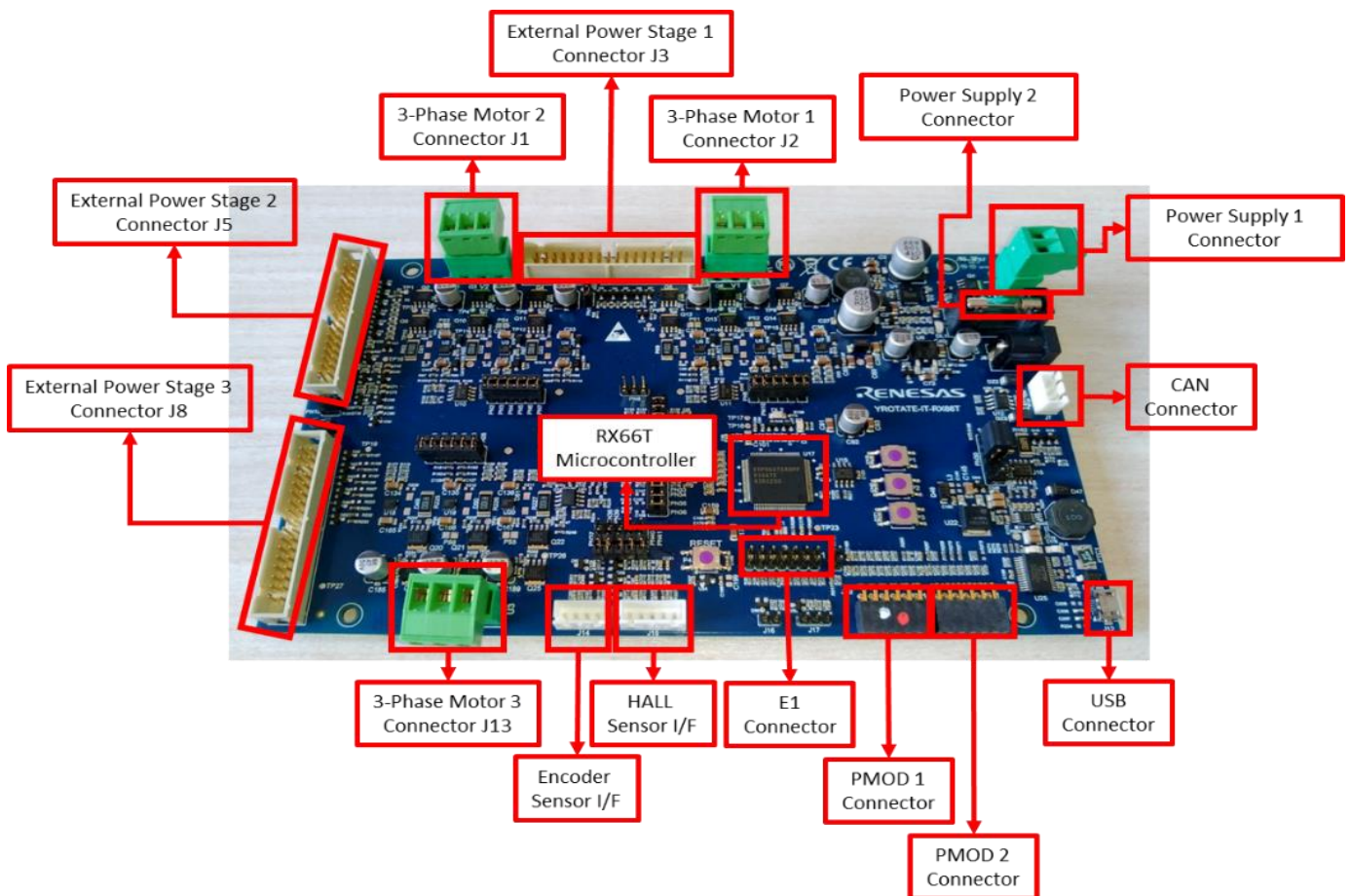

For further board details please refer to the YROTATE-IT-RX66T User Manual.

Quick Start Guide: YROTATE-IT-RX66T

3.0 Initial Board Configuration

Before connecting the micro-USB cable to the host PC and to the YROTATE-IT-RX66T board, please follow the setup procedure as described below.

1. The demonstration 3-phase Permanent Magnet Motor (e.g. PMSM) comes pre-wired with its connector as shown below. The box contains a 3-phase Brushless Motor DB42S03 from Nanotec.

Please refer to the Nanotec website for more details: <http://en.nanotec.com>

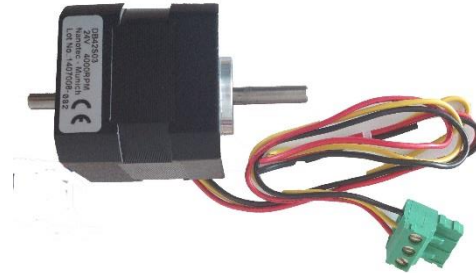

2. Place the PMSM motor connector into the assigned motor connector socket **J1** on the YROTATE-IT-RX66T board.

The motor wires are connected as follows

- a. Red Motor wire to "U" connection
- b. Yellow motor wire to the "V" connection
- c. Black motor wire to the "W" connection

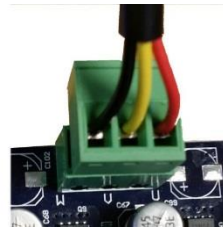

3. There are two ways to supply power to the YROTATE-IT-RX66T board.
 - a. The first is to plug in the USB cable from the PC to supply power directly to the board. In this case the current delivered to the motor is limited by the USB capabilities.
 - b. The second method is to power the board using an external voltage DC source.

For full details of power supply options please refer to Chapter 3 of the YROTATE-IT-RX66T User Manual.

4. For initial setup of the YROTATE-IT-RX66T kit, the first method must be used (USB powered). Ensure that Jumpers **PN30** and **PN31** are correctly configured as described below.

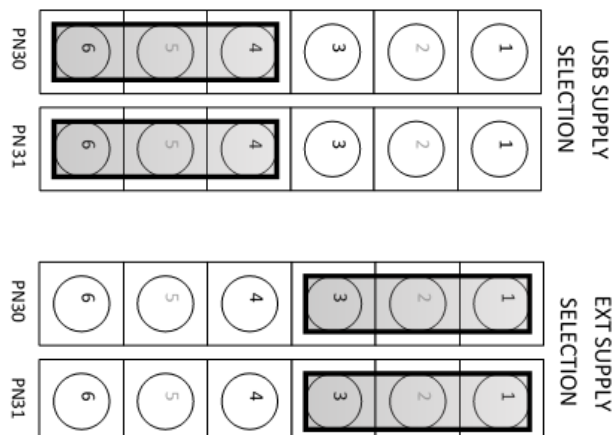

Quick Start Guide: YROTATE-IT-RX66T

4.0 PC Graphical User Interface (GUI) Software Installation

The PC GUI supports the 32-bit and 64-bit operating systems:

- Window 10
- Windows 8.1
- Windows 8

Please download the latest PC GUI software on the website:

<https://www.renesas.com/eu/en/solutions/key-technology/motor-control.html>

where after registration, the package to download is the zip filename: "YROTATE-IT-RX66T_PC_GUI_XXXXXX.zip"

Windows™ Vista and 7, 8 users must install the software with administration rights. User may see "User Account Control" dialog box. If applicable, enter the administrator password and click <OK>. Else, Right Click on the "MCDemoSetupx.x.exe" and select "Run as administrator".

Click on <Install Motor Control Demo> on the installer opening screen and then follow the instructions until reaching the final installer screen and then click <Finish>. At this stage **do not** click on <Start Demo>.

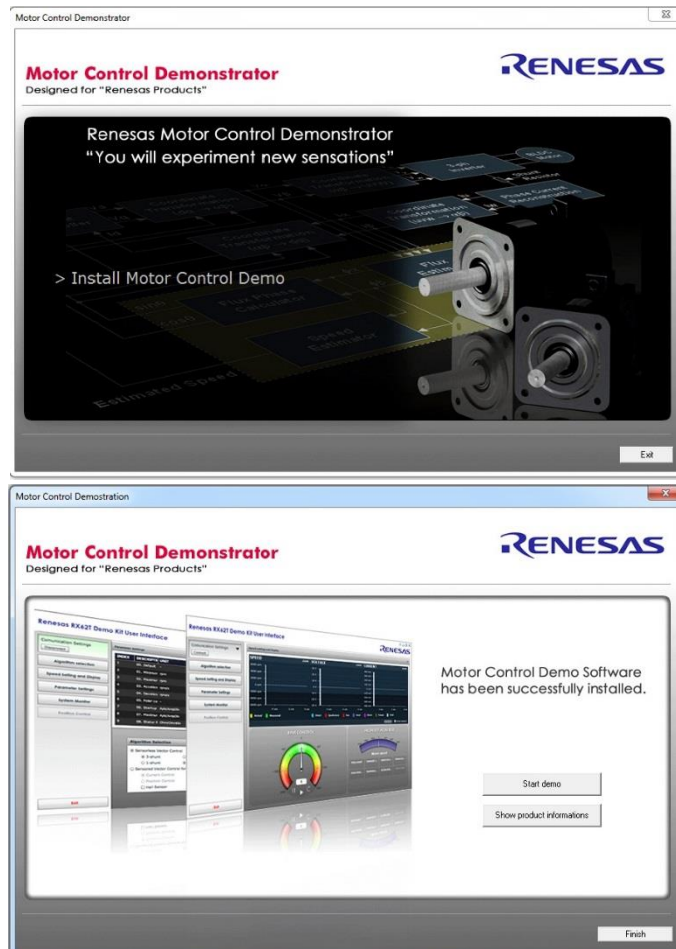

Quick Start Guide: YROTATE-IT-RX66T

5.0 Installing USB Drivers

The virtual UART drivers are included separately in the zip file “YROTATE-IT-RX66T_PC_GUI_XXXXXX.zip”, located in the folder: ./Drivers/

The RX66T inverter kit is using the FT232R IC from FDTI to convert serial communication to USB. Please refer to the FDTI website to get more information about the device used.

To install the virtual UART drivers of the YROTATE-IT-RX66T, please follow the steps:

1. First, connect the USB cable to the host PC and then connect to the YROTATE-IT-RX66T board.

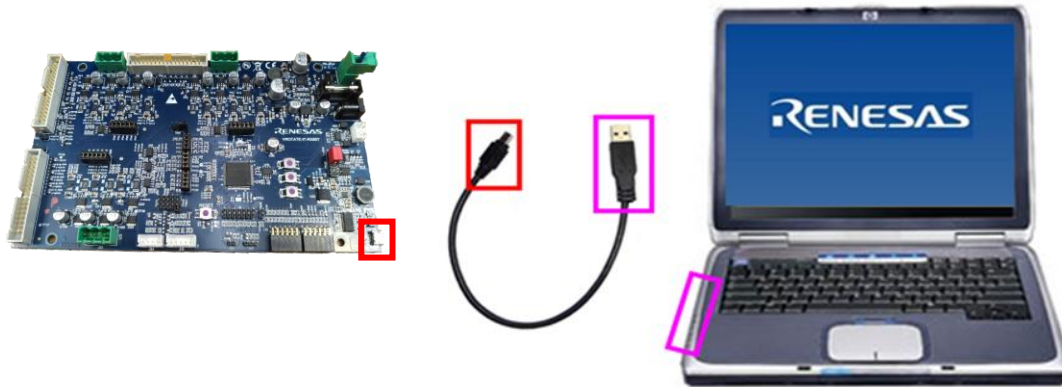

2. The host PC will detect the new hardware and start the driver installation. You may have to follow the Windows instructions, selecting **<NOT THIS TIME>** to the request for an automatic driver search by Windows. Then click on **<SELECT A PATH>** to select the appropriate YROTATE-IT-RX66T drivers in the folder ./Drivers/
3. If the automatic installation fails, the drivers can be manually installed. In the folder ./Drivers/, double click on the file “**CDM v2.12.06 WHQL Certified.exe**” and then follow the installer instructions.
4. When the board is powered up, please check that the LED **DL2** is blinking, indicating that the Microcontroller RX66T is working properly.

Quick Start Guide: YROTATE-IT-RX66T

6.0 Using the Graphical User Interface (GUI)

The GUI is installed during the installation process and must be run with administration rights. To start the GUI Right-click on the Motor Control Demo Icon in the start menu or on the desktop and **“Run as administrator”**



Please note, that for Windows Vista and Windows 7, 8 users, the GUI must be run with administration rights. To automatically set the admin privilege, press the right mouse button over the icon of the GUI, Select **“Properties”**, press the Left mouse button on the **“Compatibility”** tab and Select the Checkbox **“Run this program as an administrator”** under the Privilege Level, and click **<OK>**.

It is recommended that the USB cable should be connected to the PC and the board before opening the GUI as this makes the connection process easier. The GUI can be opened without the board being connected.

Once the GUI is open use the following procedure to connect the GUI to the YROTATE-IT-RX66T board.

- Select the **“Select board setup”** drop down menu bar in the **“Communication Settings”** box in the top left hand corner of the GUI panel.
- Select the **<RX66T>** option.
- Select the **“Serial port”** drop down box.
- Select the communications port connected to the YROTATE-IT-RX66T board (in this example COM1)
- Click on the **<Connect>** button.

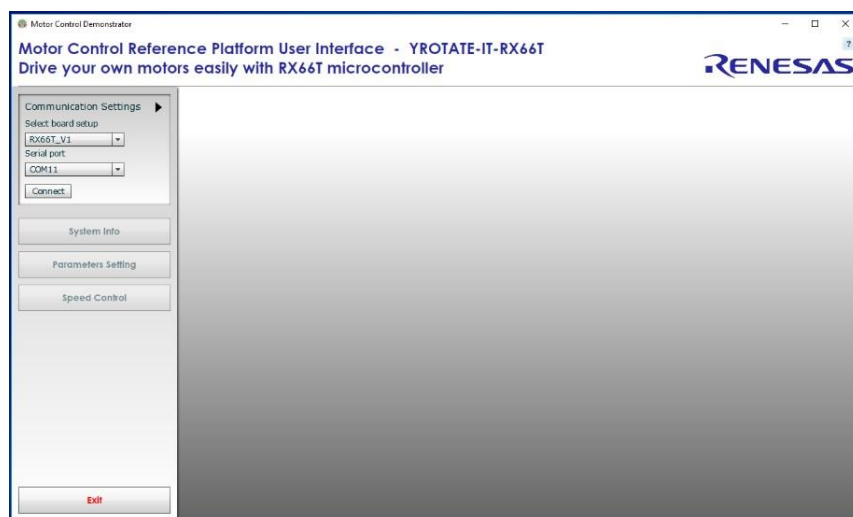

Once connected the GUI can be used to control the motor manually using the **“RPM Control”** facility. Here the user can start, stop and set direction and speed of the motor, whilst observing its performance parameters within the system display windows of the GUI.

Quick Start Guide: YROTATE-IT-RX66T

The GUI can be closed by either clicking on the <Exit> button in the bottom left hand corner or the usual windows close button.

All the facilities of the GUI, including the unique Auto-calibration feature are described in the YROTATE-IT-RX66T User Manual, which can be downloaded on the website:

<https://www.renesas.com/eu/en/solutions/key-technology/motor-control.html>

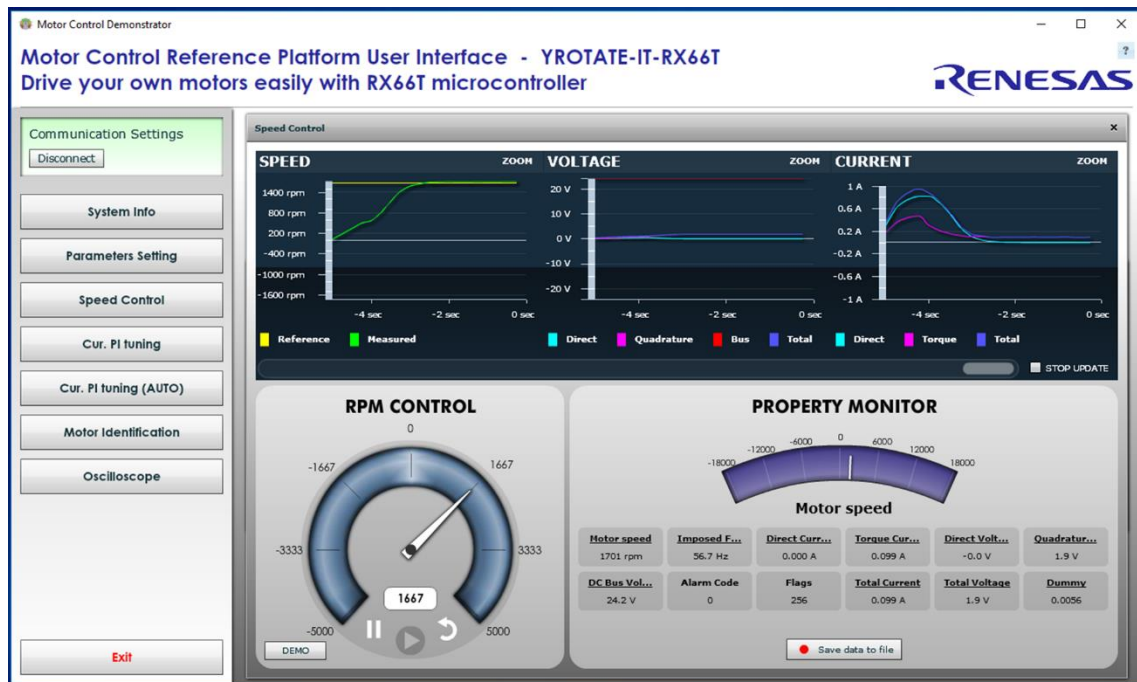

Speed range limitations

The YROTATE-IT-RX66T kit is able to drive diverse 3-phase Permanent Magnet Motors by using the sensor-less vector control algorithm within the given electrical specification of the system.

A **minimum** speed exists which is mandatory to reach in order to run the motor properly using the three shunts current measurement methods.

When the power is powered by the USB supplied by a laptop, the maximum current delivered to the board is **500mA** with a total phase current limited to **300mA** at 12VDC Voltage.

That's why, when **NO** external power supply is connected the minimum of the delivered Nanotec Motor DB42S03 is **300 RPM**, and the maximum speed is **2500RPM**.

The current throughout the three shunts at slower rotational speed than 300 RPM is too low by using the USB power supply configuration and cannot be used for the rotor estimation within the control algorithm.

Higher Voltage up to 24VDC and current up to 1A can be supplied to the Board externally by changing the settings of the Jumper **PN30** and **PN31**, like described in the "Chapter 3.0 Initial Board Configuration".

The maximum load free rotational speed of the Nanotec motor is up to **6000RPM**.

The motor can reach higher speed up to **8000RPM**, using the implemented flux weakening technic within the control algorithm and higher current.

Quick Start Guide: YROTATE-IT-RX66T

7.0 Additional material

After you have completed this quick start procedure, please review documentation that is available on the webpage <https://www.renesas.com/eu/en/solutions/key-technology/motor-control.html>

The Website contents is the following:

Items	Description of Resources
Auto-tuning Video-Tutorial	Short video explaining how to easily tune any Brushless AC motor in 45 seconds using just the intuitive PC Graphical User Interface
YROTATE-IT-RX66T_PC_GUI_XXXXXX.exe	PC GUI installer package including the drivers and readme file
Embedded Software e ² Studio Source Code	Source files for code flashed by default into the Renesas RX66T microcontroller available under e2studio. The software source code delivered is Royalty-Free.
Manuals Kit Motor Specifications Renesas Parts Datasheets Tuned Motors Specifications	Relevant documentation for the kit, the 3-phase motor, the RX66T microcontroller, the Renesas Analog Parts and the motors tuned.
Schematics-Gerber-BoM External Power Stages Main low voltage inverter Board	Schematics, Gerber files (Design files, CAD), Bill of Materials for both the main kit and the external power stages (not included as part of the kit)



Quick Start Guide: YROTATE-IT-RX66T

8.0 Support

Online technical support and further information is available at the following locations

Motor Control Websites www.renesas.com/motorcontrol

Europe:

America:

Japan:

General Web Resources

RenesasRulz Forum

www.renesasrulz.com

Renesas Interactive Training

www.renesasinteractive.com

Renesas YouTube Channel

www.youtube.com/user/RenesasPresents

Renesas Europe on Facebook

www.facebook.com/RenesasEurope

Renesas Europe on Twitter

www.twitter.com/Renesas_Europe

©2020 Renesas Electronics Europe GmbH. All rights reserved
©2020 Renesas Electronics Corporation. All rights reserved
©2020 Renesas Electronics Solution Corp Ltd. All rights reserved